

K'NEX

Imagine • Build • Play™

20 MODEL BUILDING SET WHEEL RACERS™

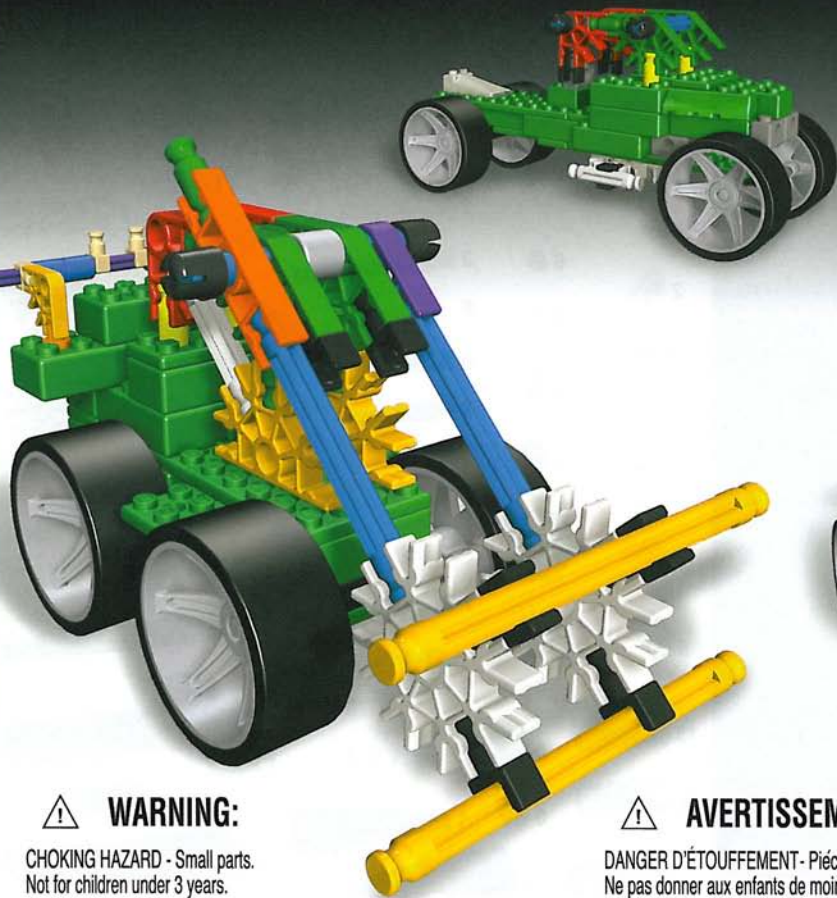

WARNING:

CHOKING HAZARD - Small parts.
Not for children under 3 years.



AVERTISSEMENT:

DANGER D'ÉTOUFFEMENT - Pièces de petite taille.
Ne pas donner aux enfants de moins de 3 ans.



BUILDING INSTRUCTIONS :

★	QUICK CAR	3
★	SPEEDSTER	4
★★	FLATBED TRUCK	6
★★	DRAGSTER	10
★★	TOW TRUCK	14
★★★	PLOW	18

15 BUILDING IDEAS 22 - 25

TRANSLATIONS :

Français
Español
Deutsch
Italiano
Português
Nederlands
Svenska
Dansk
Norsk
Suomi

26 - 27

Parts Count :

Before you start building, be sure to compare the parts in your set with the list here. If anything is missing, call or write to us using the contact information on the back cover of this book. We're happy to help you!



Start Building:

Follow the steps in order. Each part has its own color and shape. Look at the picture, find the parts in your set that match and put them together. Try to hold your model in the same direction as the picture so you'll attach your piece to the right place.

Next Step:

The faded colors are the sections you have already built. You'll want to connect the next parts to the place where the arrows are pointing. There isn't an arrow for every connection spot.

Spacers:

Some models use different colored spacers. Be sure that you use correct color, size and number of spacers.



1

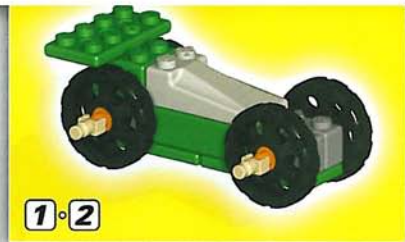
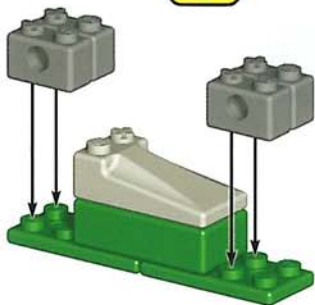

QUICK CAR

2

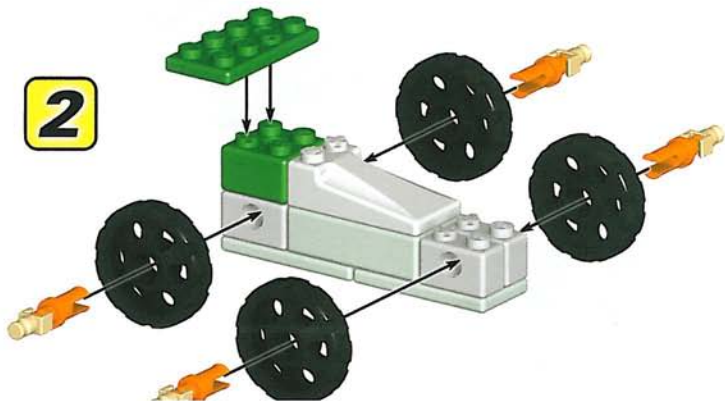



1

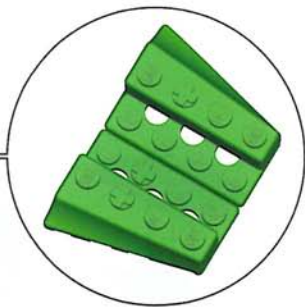
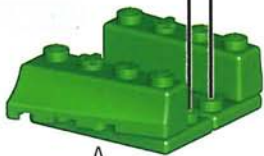
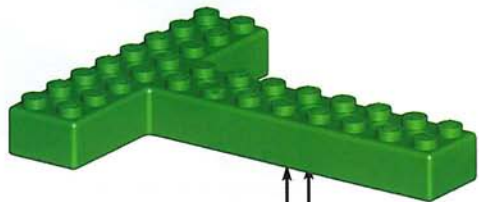

2

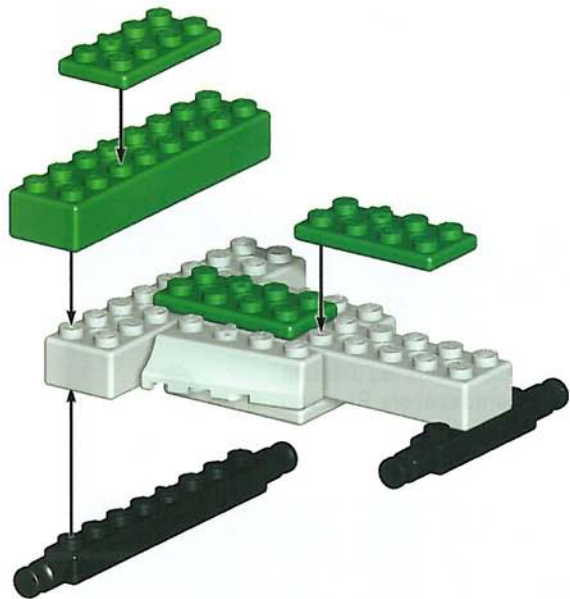

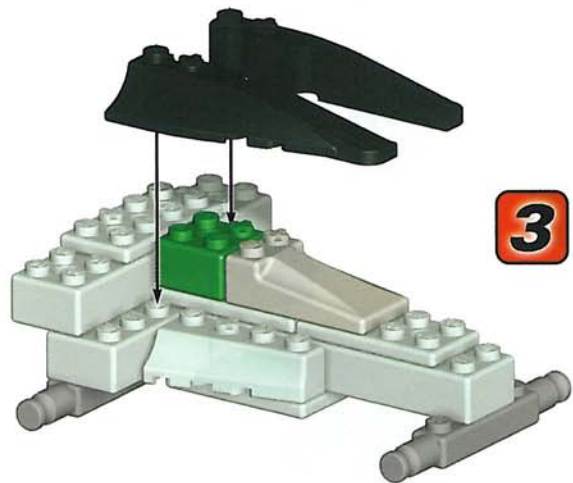

SPEEDSTER

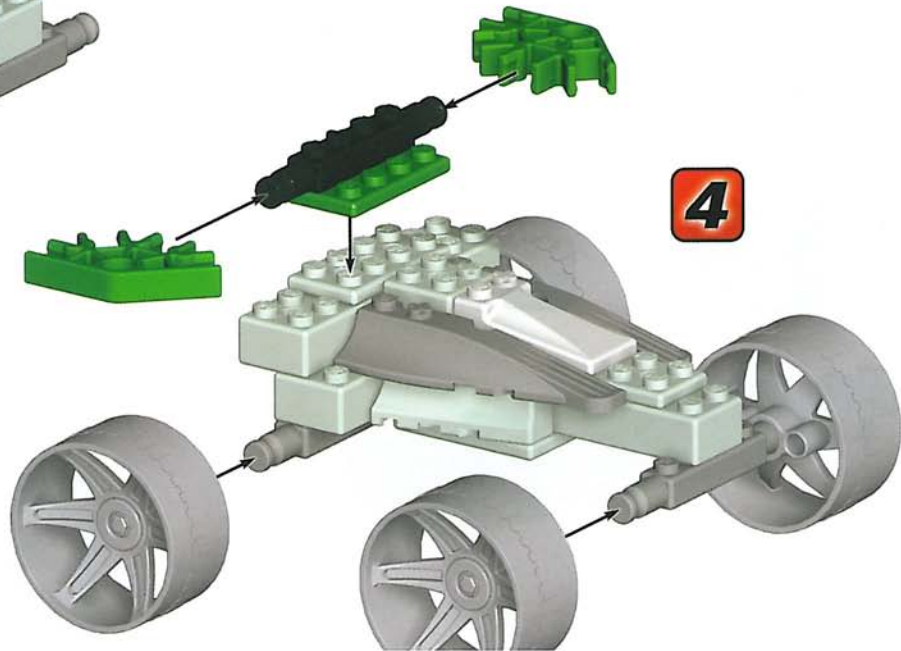

FLATBED TRUCK

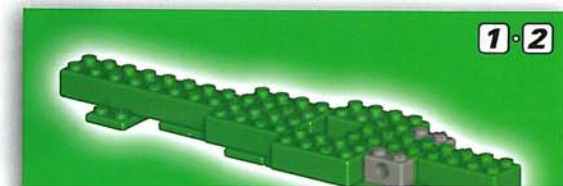
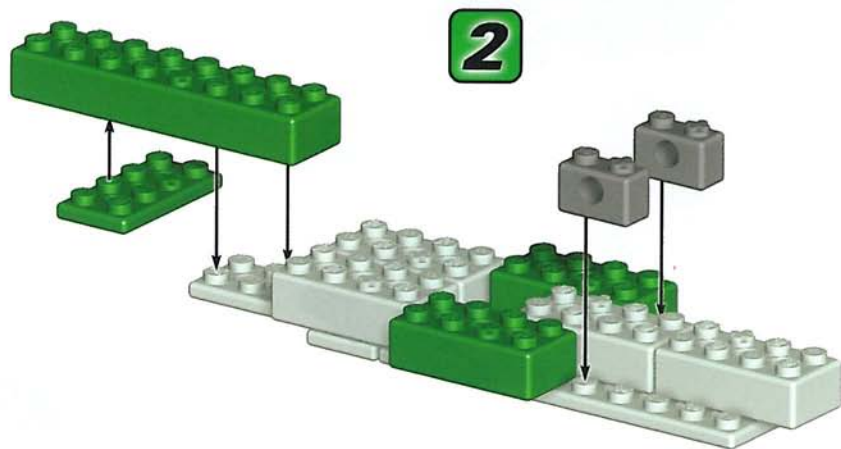
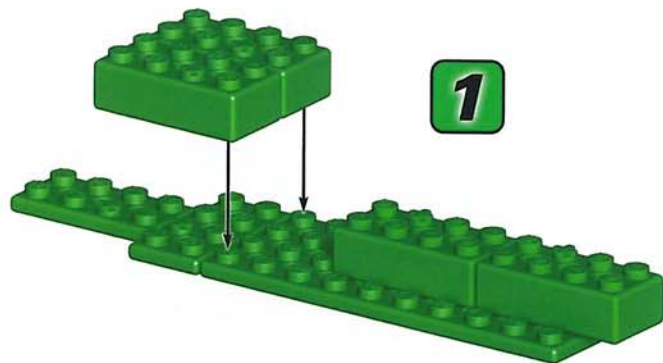
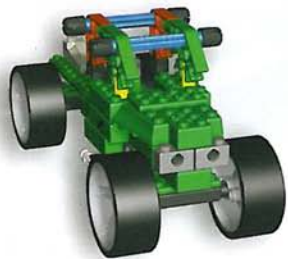

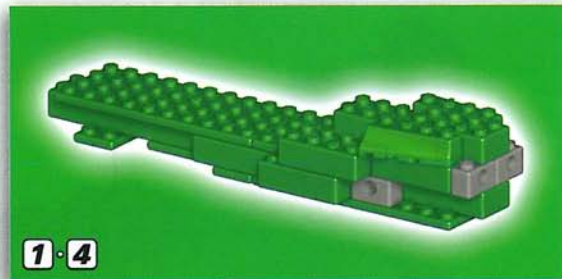
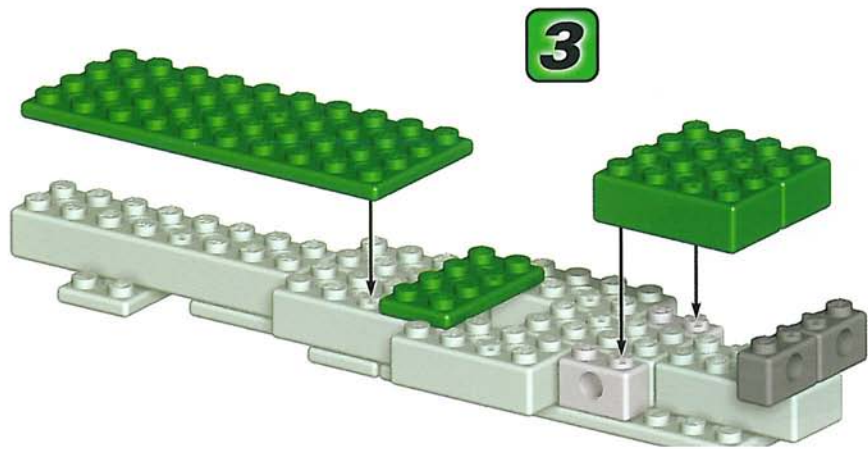
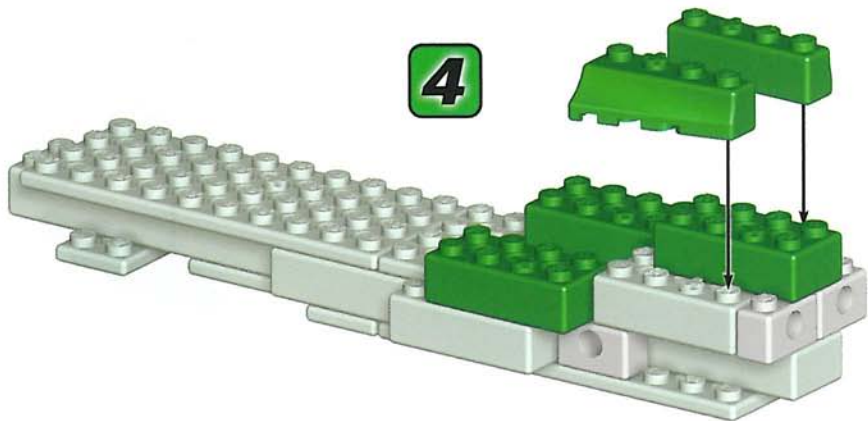

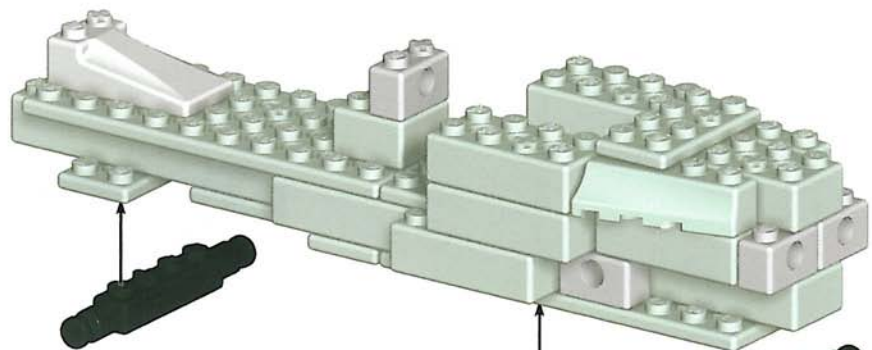

6

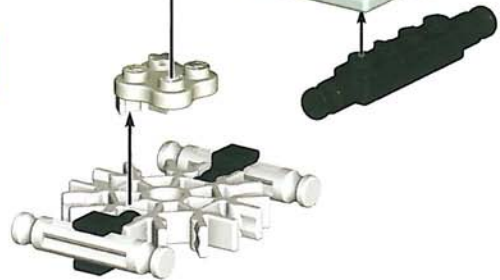

5

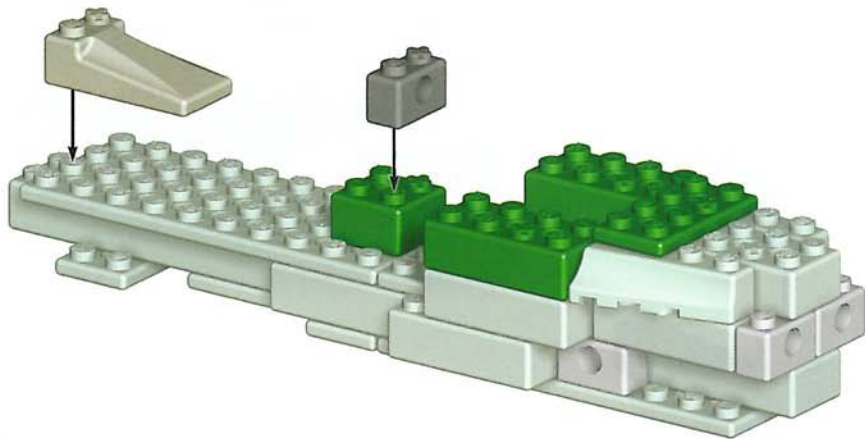

8

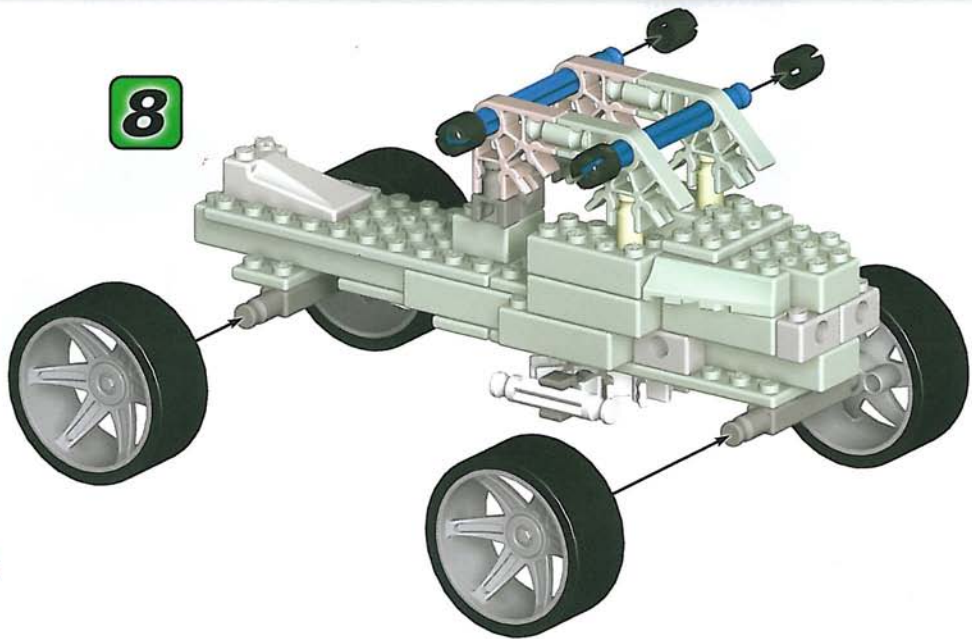

7

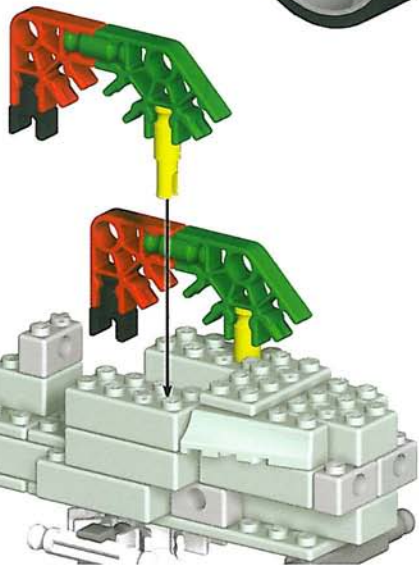

FLATBED TRUCK

1-8



DRAGSTER

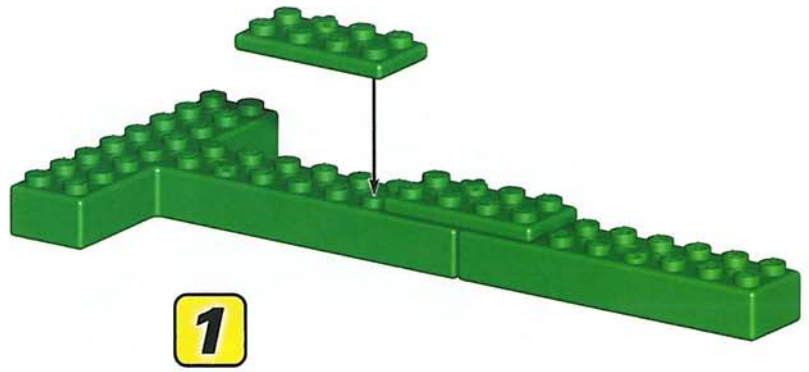
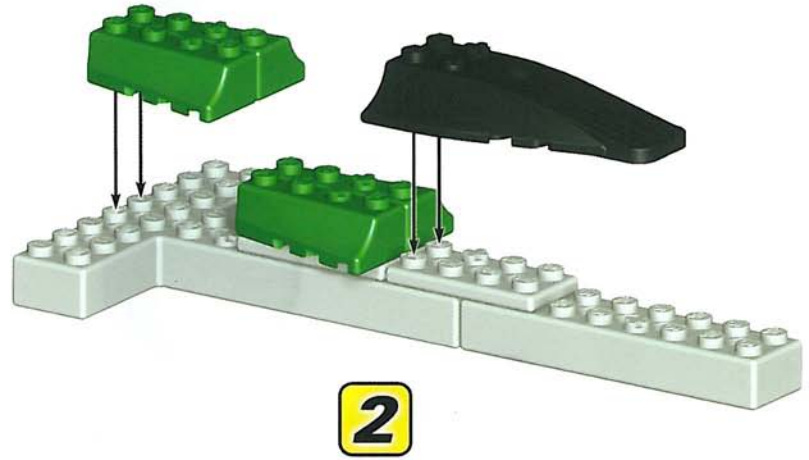
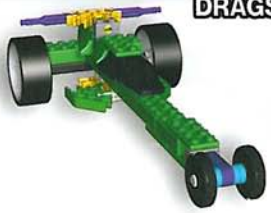

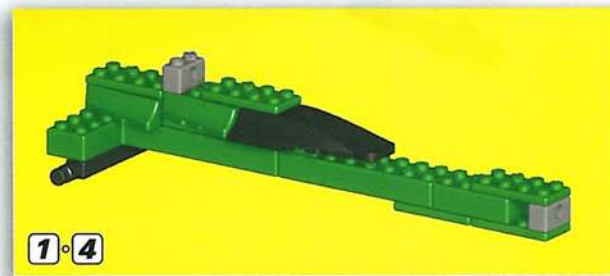
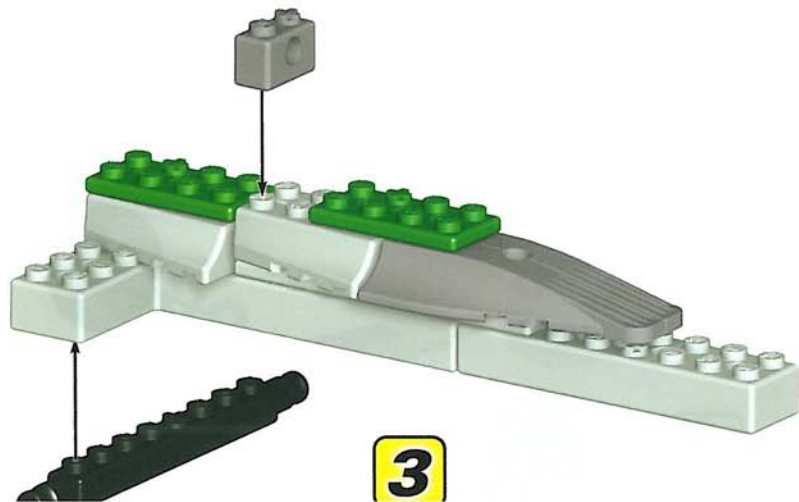
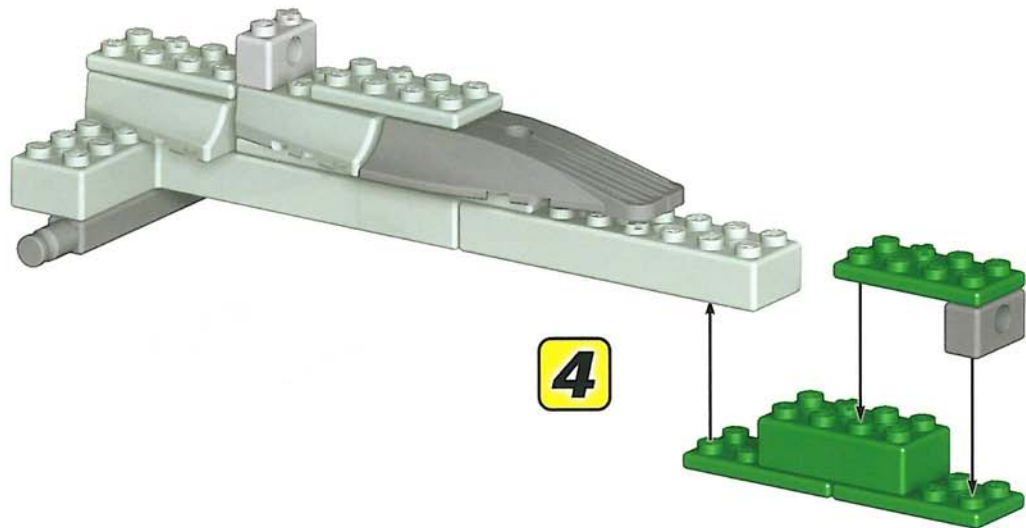

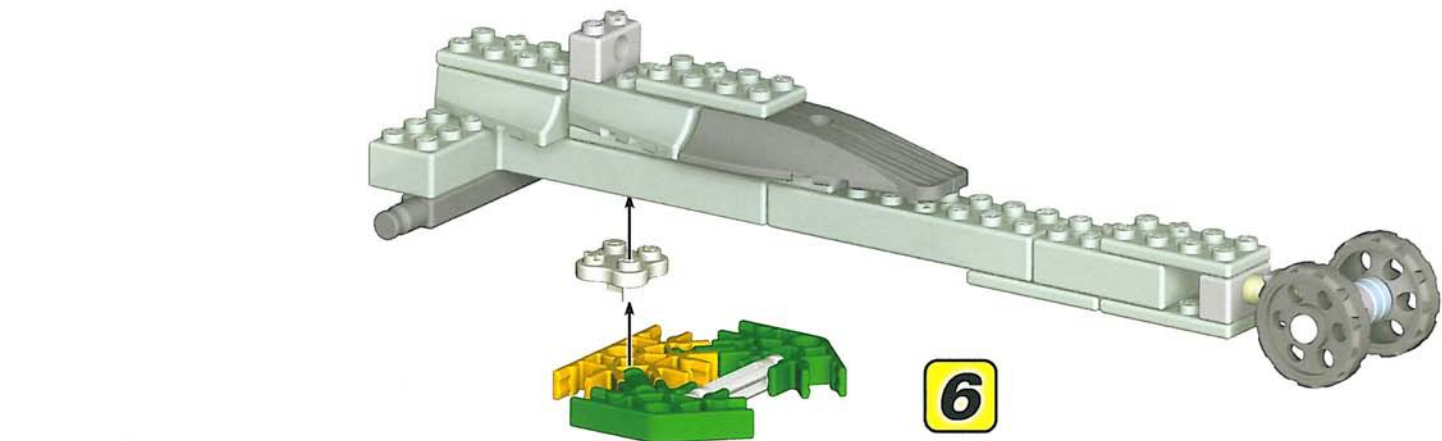



DRAGSTER

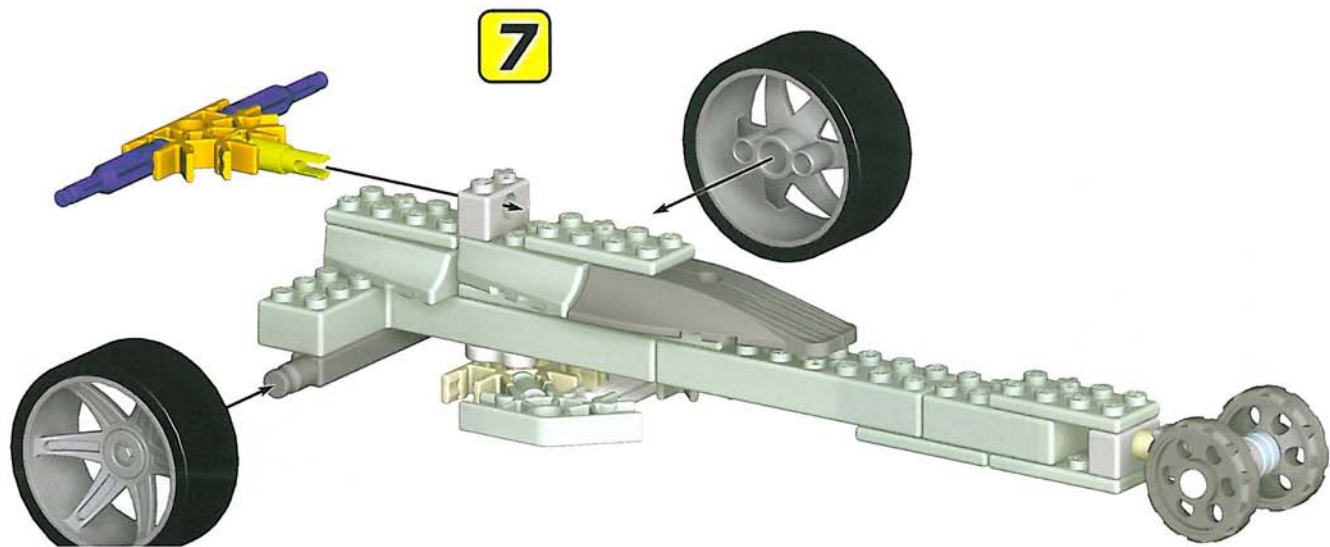

TOW TRUCK

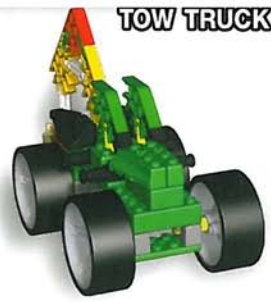

1

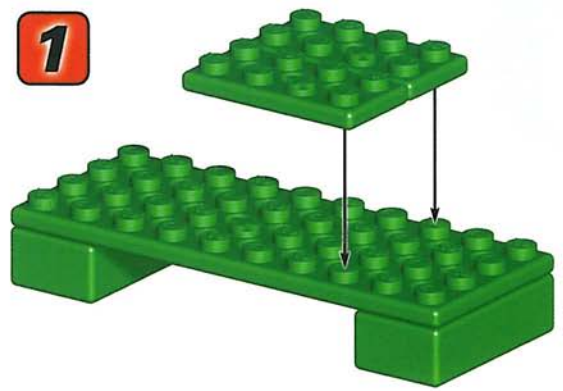

2

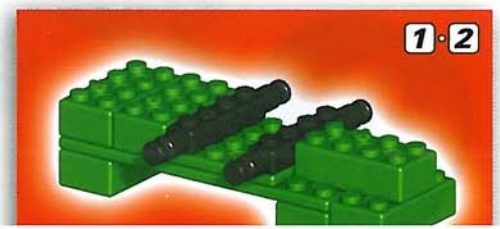
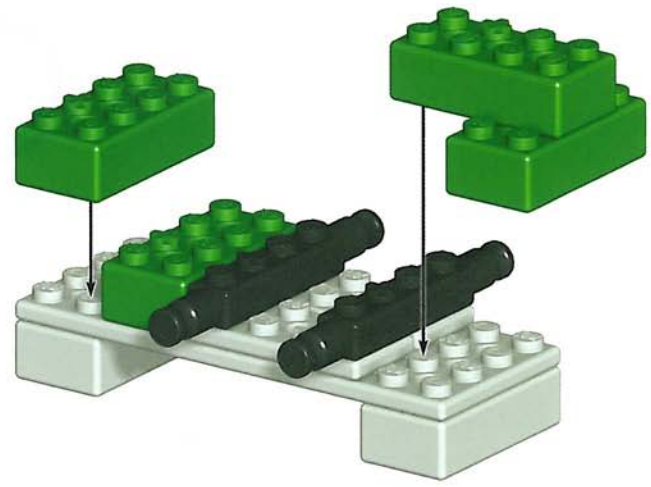

1-2

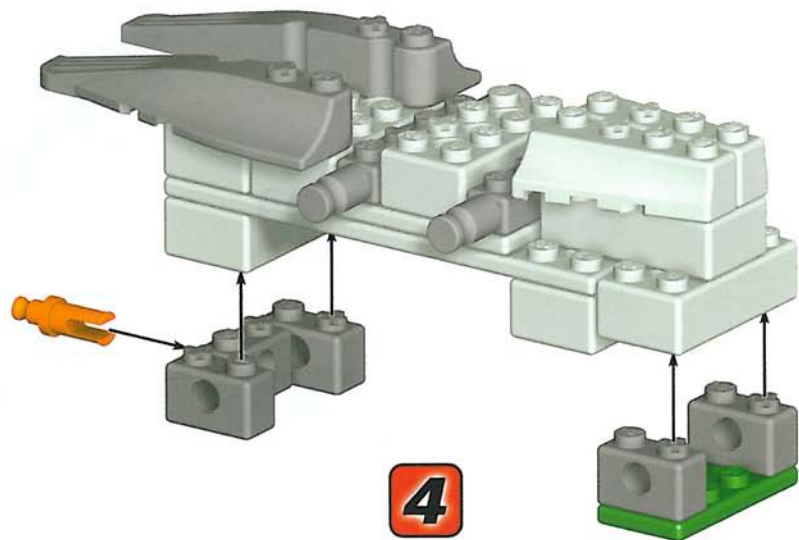

4

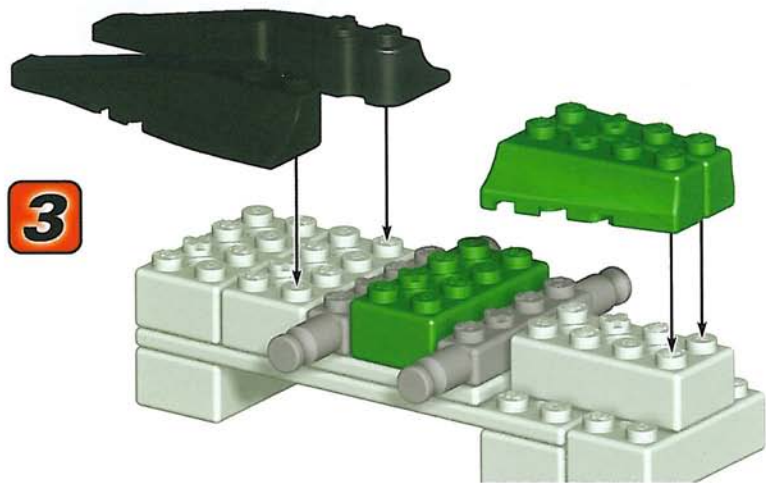

3



1-4

5

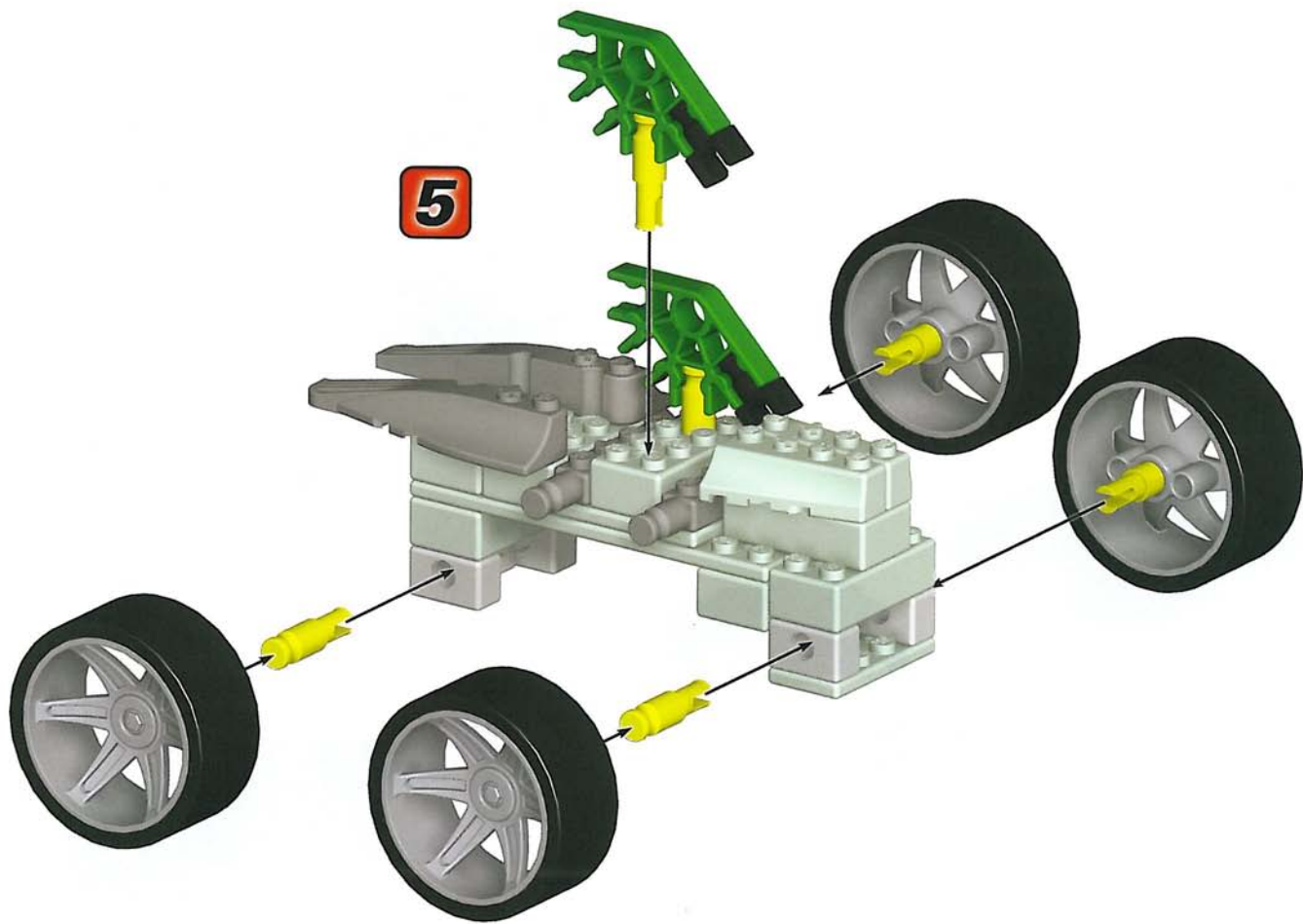



TOW TRUCK

PLow

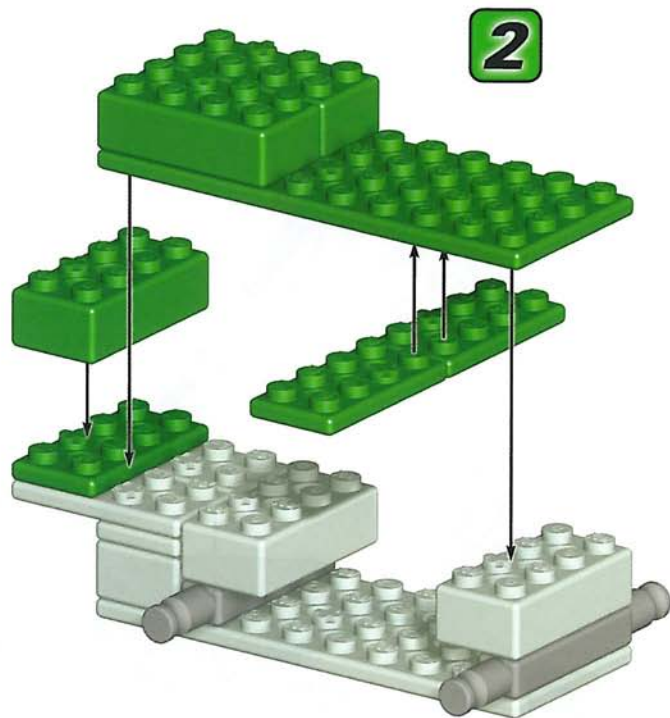
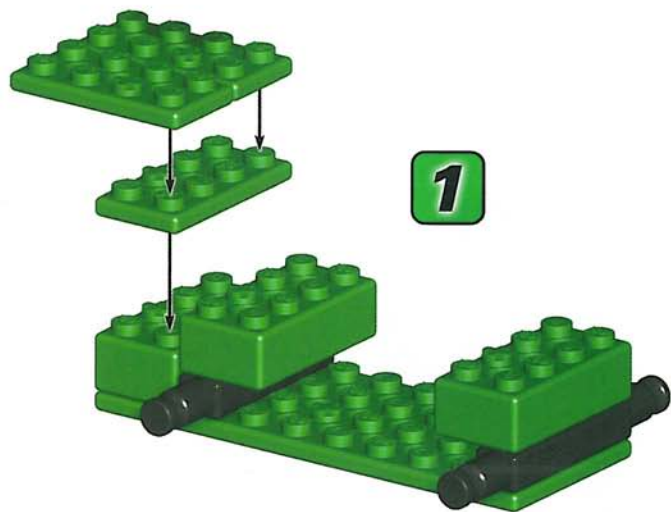
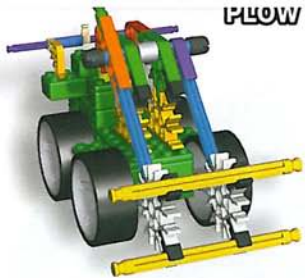

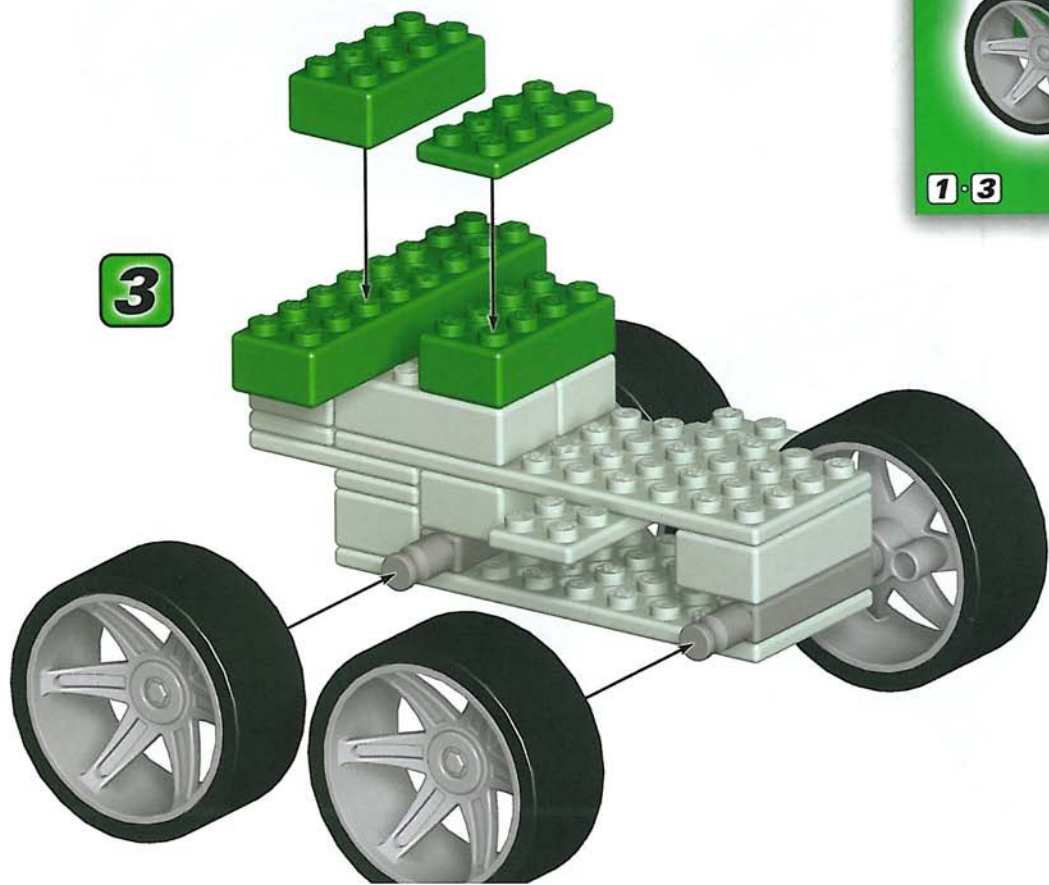

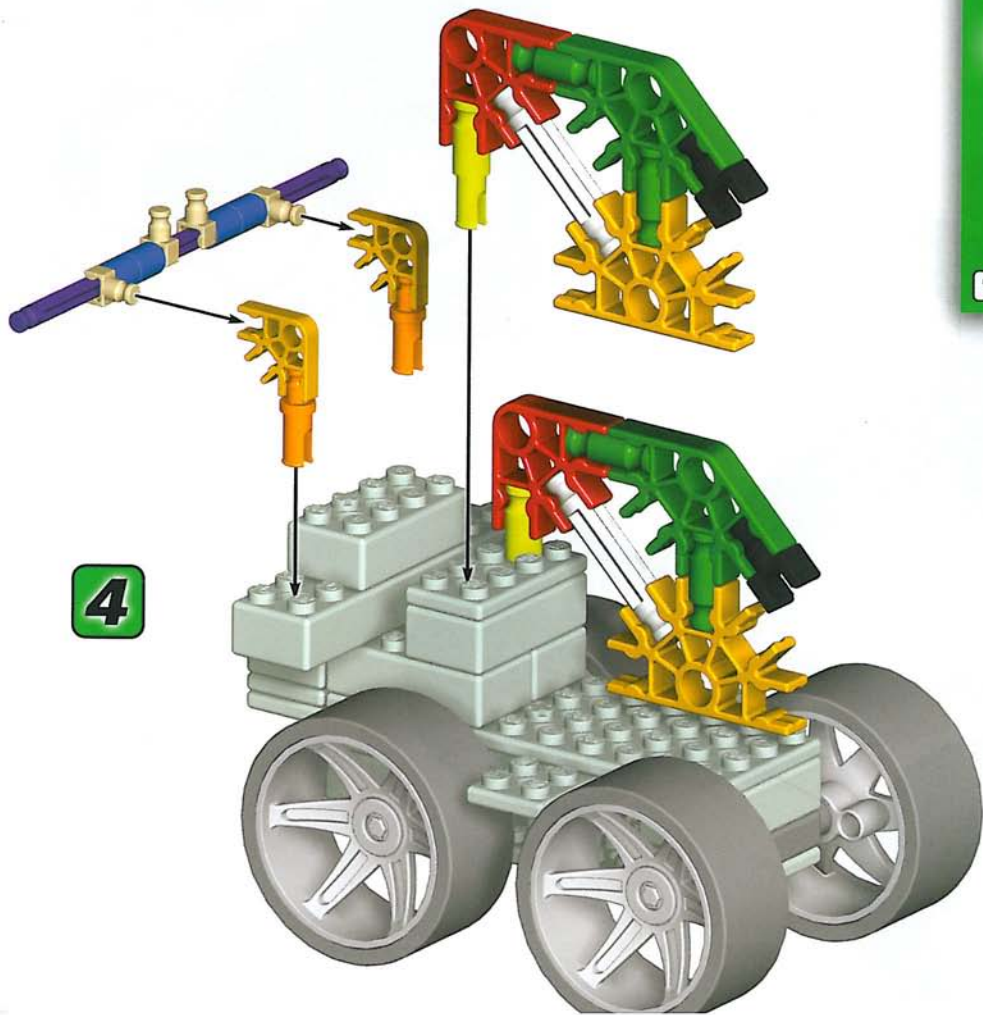

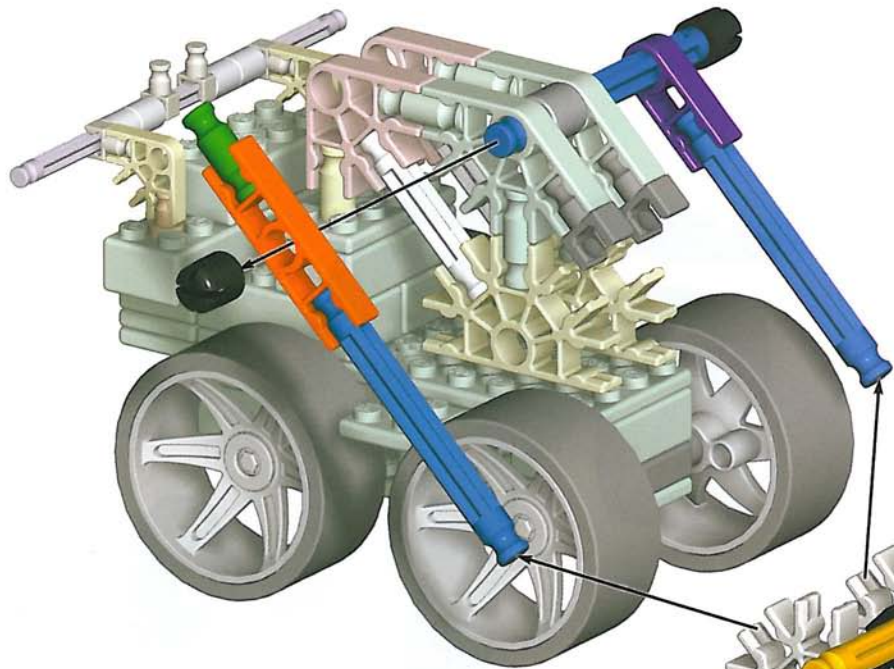

5



PLOW

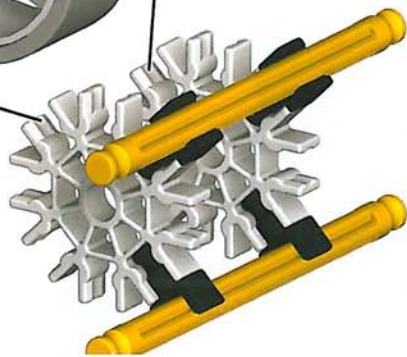

*Want full instructions for these models?
No problem! Go to www.knex.com/casesets
and enter code number 12310*

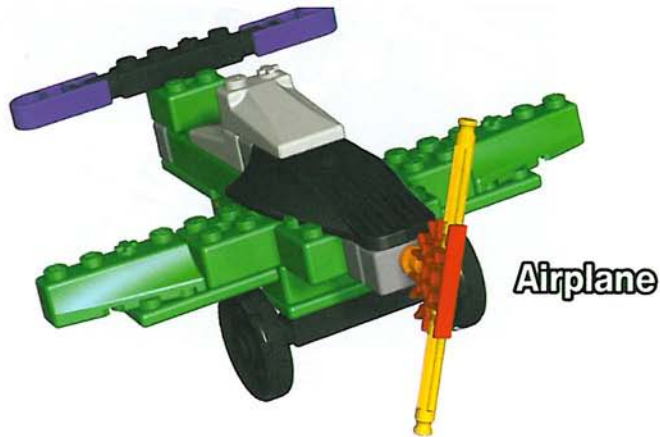

Airplane



Funny Car 2

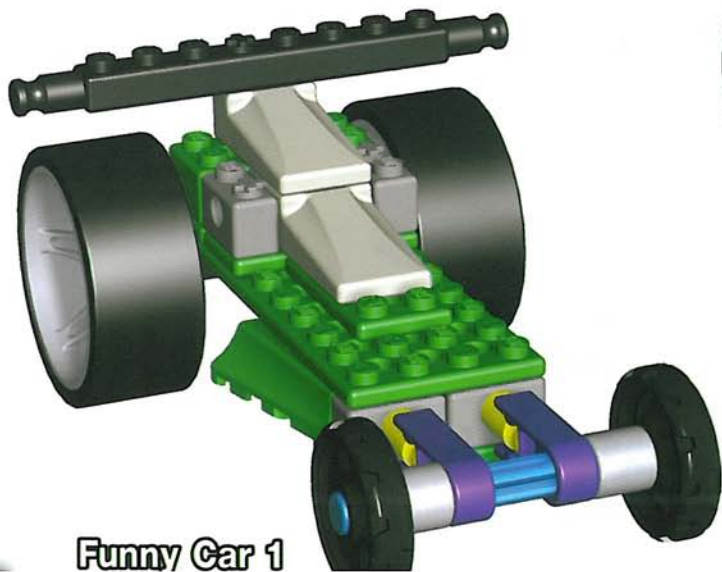

Funny Car 1

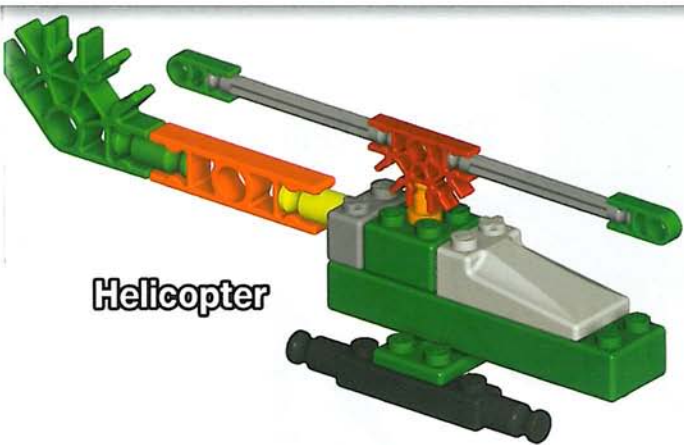

Helicopter

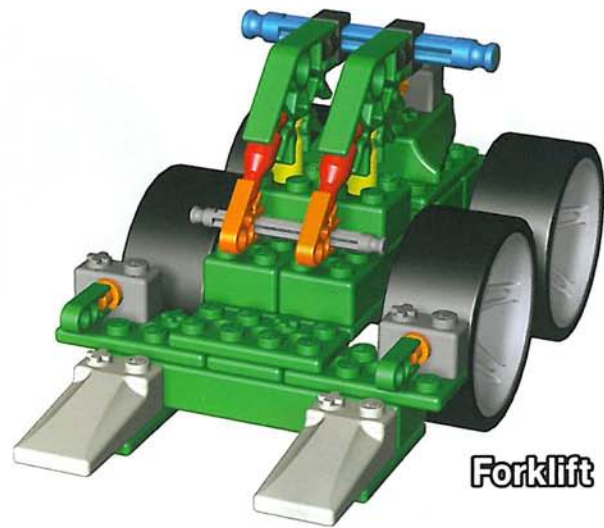

Forklift



Stadium Truck

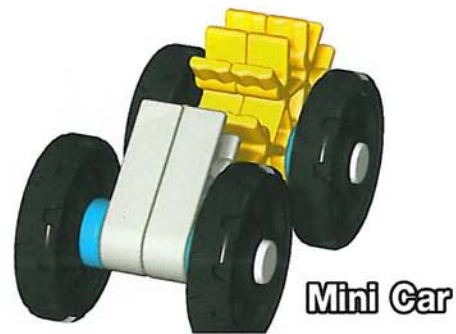

Mini Car



Moped

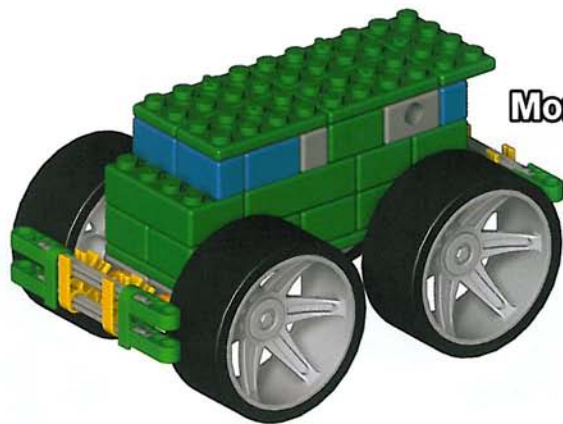

Monster Van



Sailboat



Catamaran

Want full instructions for these models?
No problem! Go to www.knex.com/casesets
and enter code number 12310



Jet Plane



Glider Plane

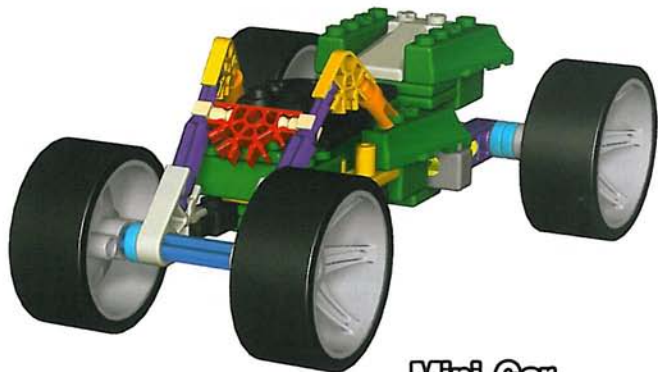
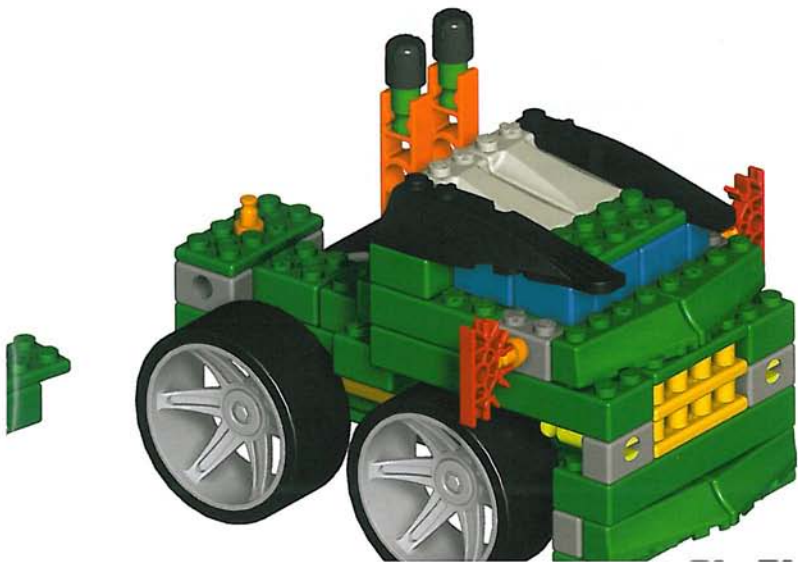

Mini Car

F 1. Commence la construction :

Chaque élément a ses propres couleur et forme. Regarde l'illustration, trouve les éléments qui vont ensemble et assemble-les. Essaie de tenir ton modèle dans le même sens que sur l'illustration de façon à fixer la pièce à l'endroit qu'il faut.

2. Étape suivante :

Les couleurs délavées représentent les sections que tu as déjà assemblées. Tu devras connecter les éléments suivants à l'endroit où pointent les flèches. Il n'y a pas de flèche pour chaque point de connection.

3. Espaceurs :

Il y a des espaceurs de différentes couleurs. Veille à utiliser la couleur, la dimension et le nombre d'espaceurs qu'il faut.

E 1. Empieza a construir:

Cada pieza tiene su propio color y forma. Observa el dibujo, encuentra las piezas que combinan y ponlas juntas. Trata de mantener tu modelo en la misma dirección en que se muestra en el dibujo. Así podrás conectar la pieza en el correcto lugar.

2. Paso siguiente:

Las partes descoloridas son las secciones que ya has construido. Querrás conectar las piezas que siguen en el lugar hacia el cual las flechas están apuntando. No hay una flecha para cada punto de conexión.

3. Espaciadores:

Encontrarás espaciadores de diferentes colores. Asegúrate de que usas la correcta cantidad de espaciadores, y que el color y la medida de los espaciadores también sean correctos.

D 1. Los geht's mit dem Bauen:

Jedes Teil hat eine bestimmte Farbe und Form. Schau dir das Bild an und suche nach Teilen, die zueinander passen. Füge diese Teile dann zusammen. Versuche, dein Modell in der gleichen Richtung zu halten, wie in dem Bild, damit du die Teile an der richtigen Stelle zusammenfügst.

2. Nächster Schritt:

Die Abschnitte mit blassen Farben hast du schon fertig gebaut. Die nächsten Teile gehören dort hin, wo die Pfeile hinzeigen. Für manche Befestigungspunkte gibt es keinen separaten Pfeil.

3. Abstandsstücke:

Abstandsstücke haben unterschiedliche Farben. Achte darauf, die richtige Farbe, Größe und Anzahl von Abstandsstücken zu verwenden.

I 1. Comincia a costruire:

Ogni parte ha il suo colore e la sua forma. Guarda la figura, trova le parti che corrispondono e mettile insieme. Cerca di tenere il tuo modello nella stessa direzione della figura così attaccherai il pezzo al posto giusto.

2. Il prossimo passo:

I colori sbiaditi sono le sezioni che hai già costruito. Quello che vorrai fare è connettere le prossime parti nel posto verso il quale sono rivolte le frecce. Non c'è una freccia per ogni punto di connessione.

3. Distanziatori:

Ci sono distanziatori di colore diverso. Assicurati di star usando il colore, la misura e il numero di distanziatori giusti.

P 1. Inicia a construção:

Cada peça tem a sua própria cor e configuração. Observa a ilustração, procura as peças que correspondem e coloca-as todas juntas. Tenta manter o teu modelo na mesma direcção mostrada na ilustração para encaixares a peça no local correcto.

2. Passo seguinte:

As cores desbotadas pertencem às secções que já construístes. Necessitarás de unir as peças seguintes no local apontado pelas setas. Não existe uma seta para cada ponto de conexão.

3. Espaçadores:

Existem espaçadores de cores diferentes. Certifica-te de que usas a cor, tamanho e número de espaçadores exactos.

NL 1. Begin te bouwen:

Elk onderdeel heeft zijn eigen kleur en vorm. Kijk naar de afbeelding, vind de overeenstemmende onderdelen en voeg ze aan mekaar. Tracht het model in dezelfde richting te houden als de afbeelding; zo zul je het stuk op de correcte plaats vastmaken.

2. Volgende stap:

De vage kleuren zijn delen die reeds werden opgebouwd. De volgende onderdelen zullen moeten gekoppeld worden op de plaats aangeduid door de pijlen. Er is geen pijl voor elk koppelingspunt.

3. Spatiestukken:

Er zijn verschillende gekleurde spatiestukken. Verzeker je ervan om de juiste kleur, grootte en aantal spatiestukken te gebruiken.

SV 1. Börja bygga:

Varje del har sin egen färg och form. Titta på bilden, hitta delarna som passar och sätt ihop dem. Försök att hålla din modell i samma riktning som på bilden så att du fäster delen på rätt ställe.

2. Nästa steg:

De bleka färgerna anger sektioner som du redan byggt. Du ska koppla nästa delar till ställena som anges med pilarna. Det finns inte pilar för varje kopplingspunkt.

3. Mellanbalkar:

Det finns mellanbalkar av olika färger. Använd alltid rätt färg, storlek och antal mellanbalkar.

DA 1. Begynd at bygge:

Hver del har sin egen farve og form. Se på billedet, find de dele, der matcher, og sæt dem sammen. Prøv at holde din model i samme retning som billedet, så du kommer til at sætte delen fast på den rette plads.

2. Næste trin:

De faldede farver er de afsnit, du allerede har bygget. Du skal samle de næste dele på det sted, som pilene peger på. Der findes ikke nogen pil for hvert eneste samlingssted.

3. Afstandsstykker:

Der er afstandsstykker i forskellige farver. Sørg for at bruge korrekt farve, størrelse og antal afstandsstykker.

NO 1. Sett i gang byggingen:

Hver del har sin egen farge og fasong. Se på bildet, finn de delene som tilsvarer hverandre og sett de sammen. Försök å holde modellene din i samme retning som bildet slik at stykket festes til det rette stedet

2. Neste skritt:

Det bleke fargene er de seksjonene som du allerede har bygget. Du skal feste de neste delene der hvor pilene peker. Det finnes ikke en pil for hvert skjøtepunktsted.

3. Avstandstykker:

Det finnes forskjellige fargede avstandstykker. Pass på å bruke riktig farge, størrelse og antall avstandstykker.

FI 1. Aloita rakentaminen:

Jokaisella osalla on oma värinsä ja muotonsa. Katso kuvaa, etsi käsiisi toisiinsa sopivat palat ja pane ne yhteen. Yritä pitää mallisi samassa suunnassa kuin kuvassa jotta varmasti kiinnität osan oikeaan kohtaan.

2. Seuraava askel:

Haaleat värit osoittavat rakenteita, jotka olet jo tehnyt. Liitä seuraavat osat nuolien osoittamiin kohtiin. Nuolia ei ole jokaisessa liitäntäkohdassa.

3. Välitangot:

Sarjassa on erivärisiä välitankoja. Käytä aina oikeanvärisiä ja -kokoisia välitankoja sekä oikeaa lukumäärää.

K'NEX.COM

WORKS WITH ALL LEADING BUILDING BRICKS™



+



=



Sold separately.
Vendus séparément.
Se venden por separado.
Separat erhältlich.
Venduti separatamente.
Vendidos separadamente.
Afzonderlijk verkocht.
Säljes separat.
Selges separat.
Myydään erikseen.

Visit www.knex.com/casets
and click on **combo builds** for instructions.



+



=

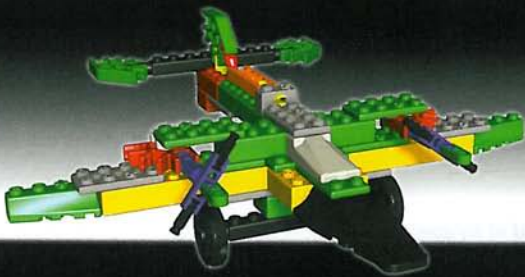

Questions? Call 1-800-KID-KNEX (U.S.A./Canada only)
or 00800-22427276 (UK/Ireland only)

Write to email@knex.com or visit www.knex.com
For Customer Service outside the USA, CAN, GBR please
contact local distributor. Distributor information can be
found at: <http://www.knex.com/contact/international.php>
Le Service clients hors d'USA et CAN, s'il vous plaît contacter
le distributeur local. L'information de distributeur peut être
trouvée à <http://www.knex.com/contact/international.php>

Standard K'NEX parts made in the U.S.A.

Special components made in China.

Product & colors may vary.

K'NEX is a registered trademark of K'NEX Industries, Inc.

Pièce K'NEX courantes fabriqués aux États-Unis.
Éléments spéciaux fabriqués en Chine. Fabriqués aux
États-Unis. K'NEX hechas en EE.UU. Produits et couleurs
peuvent varier. K'NEX est une marque déposée de
K'NEX Industries, Inc. Componentes especiales hechas
en China. Hecho en los EE.UU. El producto y los colores
pueden variar. K'NEX es una marca registrada de
K'NEX Industries, Inc.

Manufactured under U.S. Patents/Fabriqués sous
brevets américains/Fabricado bajo patentes de EE.UU.
5,061,219; 5,137,486; 5,199,919; 5,350,331. Other U.S.
and foreign patents pending. Autres brevets américains et
étrangers en instance. Otras patentes de EE.UU. y países
extranjeros pendientes. Conforms to ASTM F963-03

- Identifies Genuine K'NEX Bricks.
- Identifie que ce sont d'authentiques briques K'NEX.
- Identifica los ladrillos genuinos de K'NEX.
- Identifiziert echte K'NEX-Bausteine.
- Edentifica i veri blocchi K'NEX.
- Identifica que são cubos genuíno da K'NEX.
- Identificeert K'NEX bakstenen voor.
- Anger äkta K'NEX klossar.
- Identifierer ægte K'NEX brikker.
- Identifierer ekte K'NEX-murstein.
- Osoittaa aitoja K'NEX paloja.



www.knex.com ©2007 K'NEX Industries, Inc.