

16457

K'NEX

**ULTIMATE
100 MODEL
BUILDING SET**

**AIR
MODELS**

Flying Machine
page 1



Hang Glider
page 15

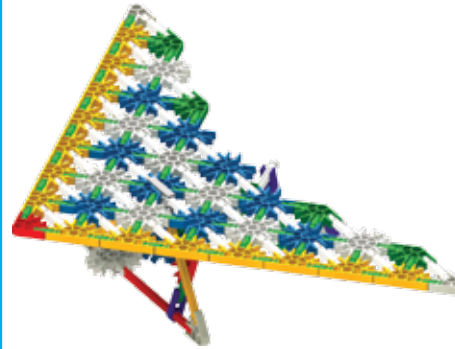

Helicopter
page 17

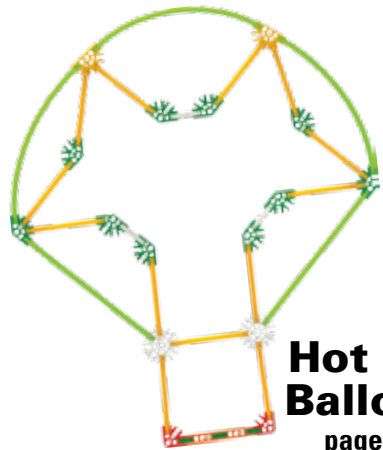

**Hot Air
Balloon**
page 21

Plane
page 22

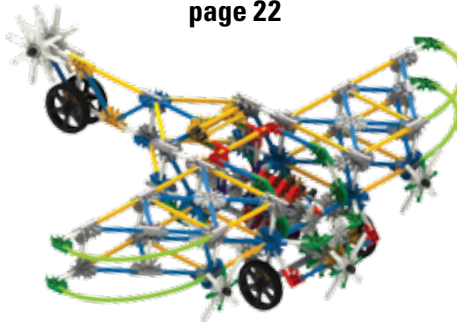

Space Jet
page 41

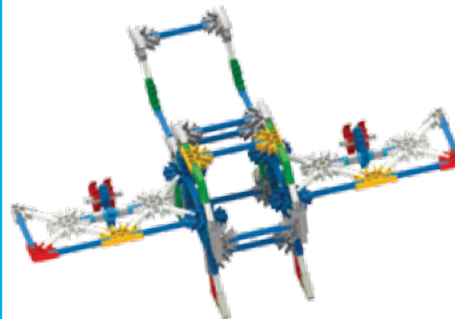

UFO
page 46

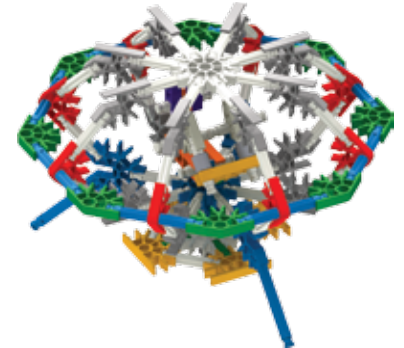

Flying Machine

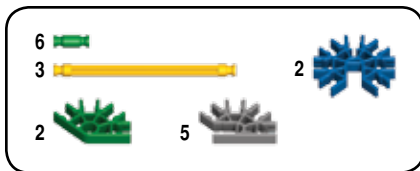
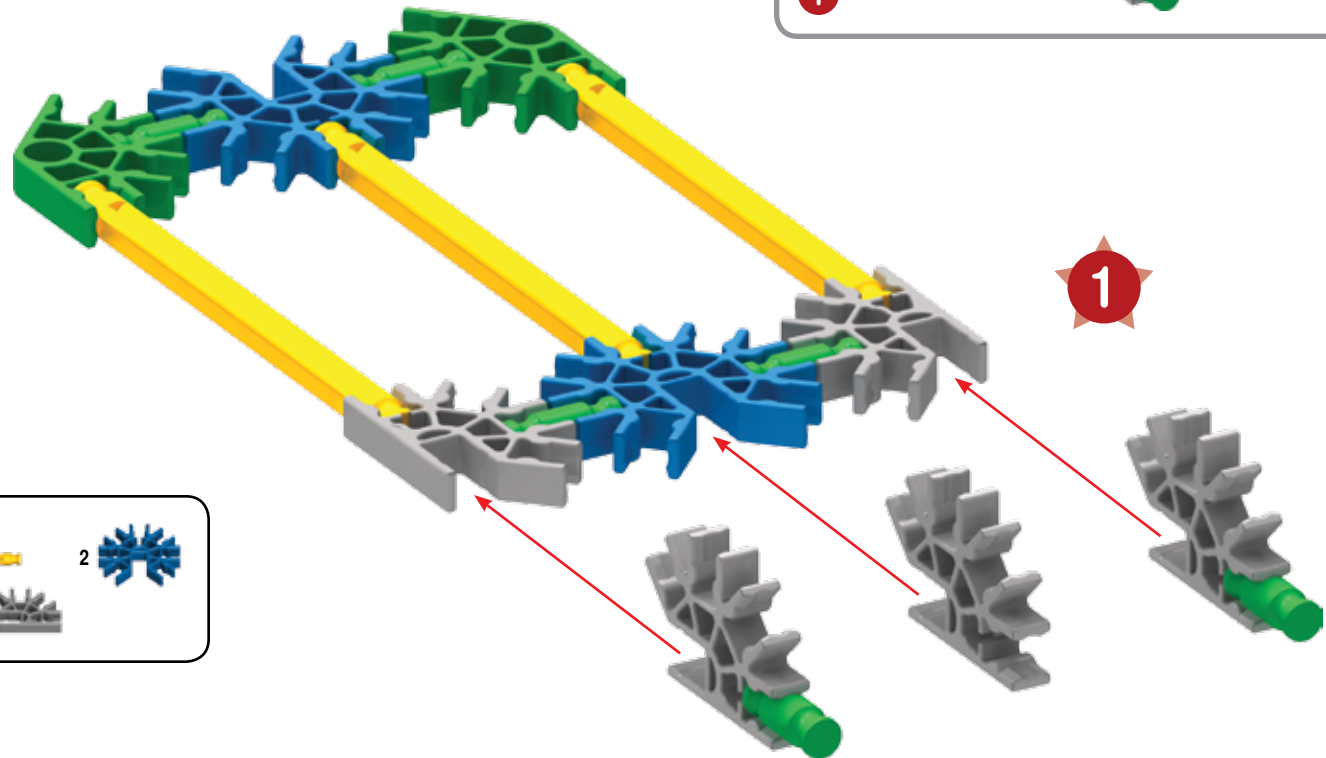
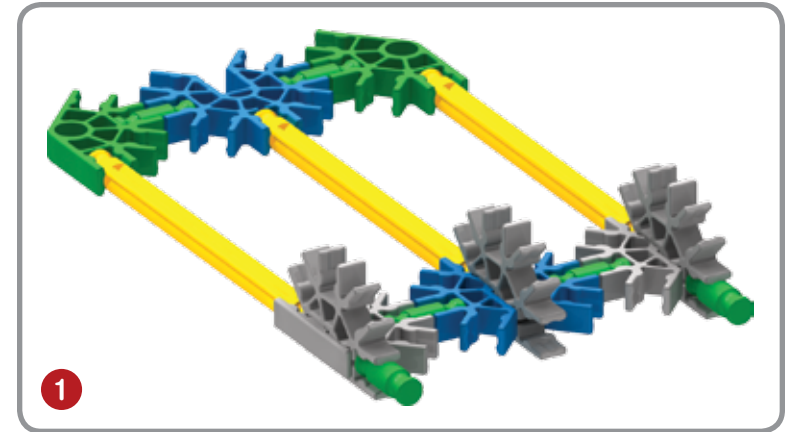

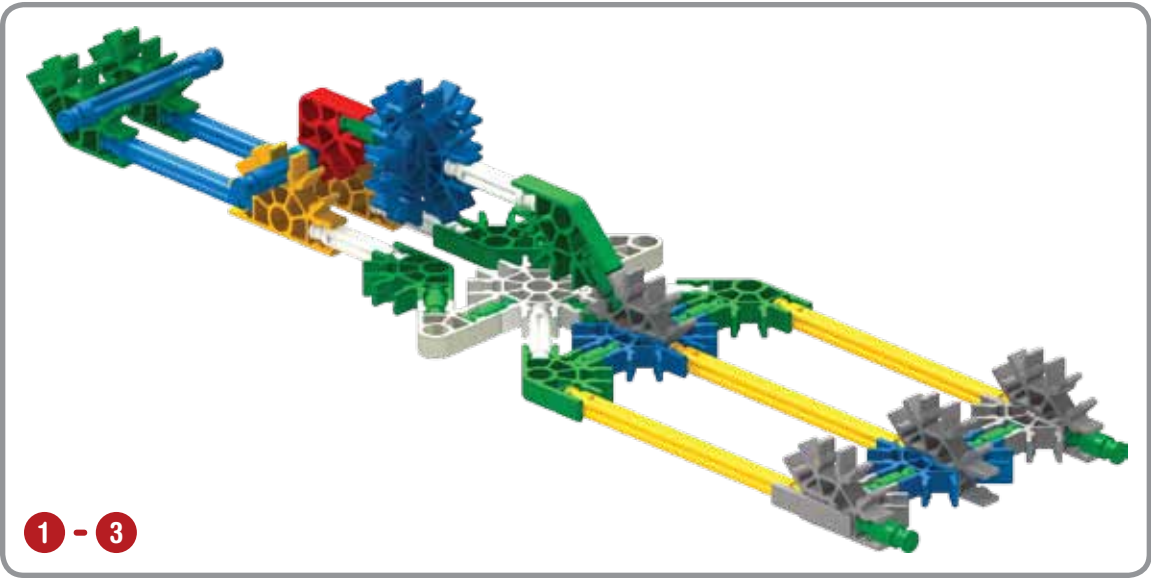
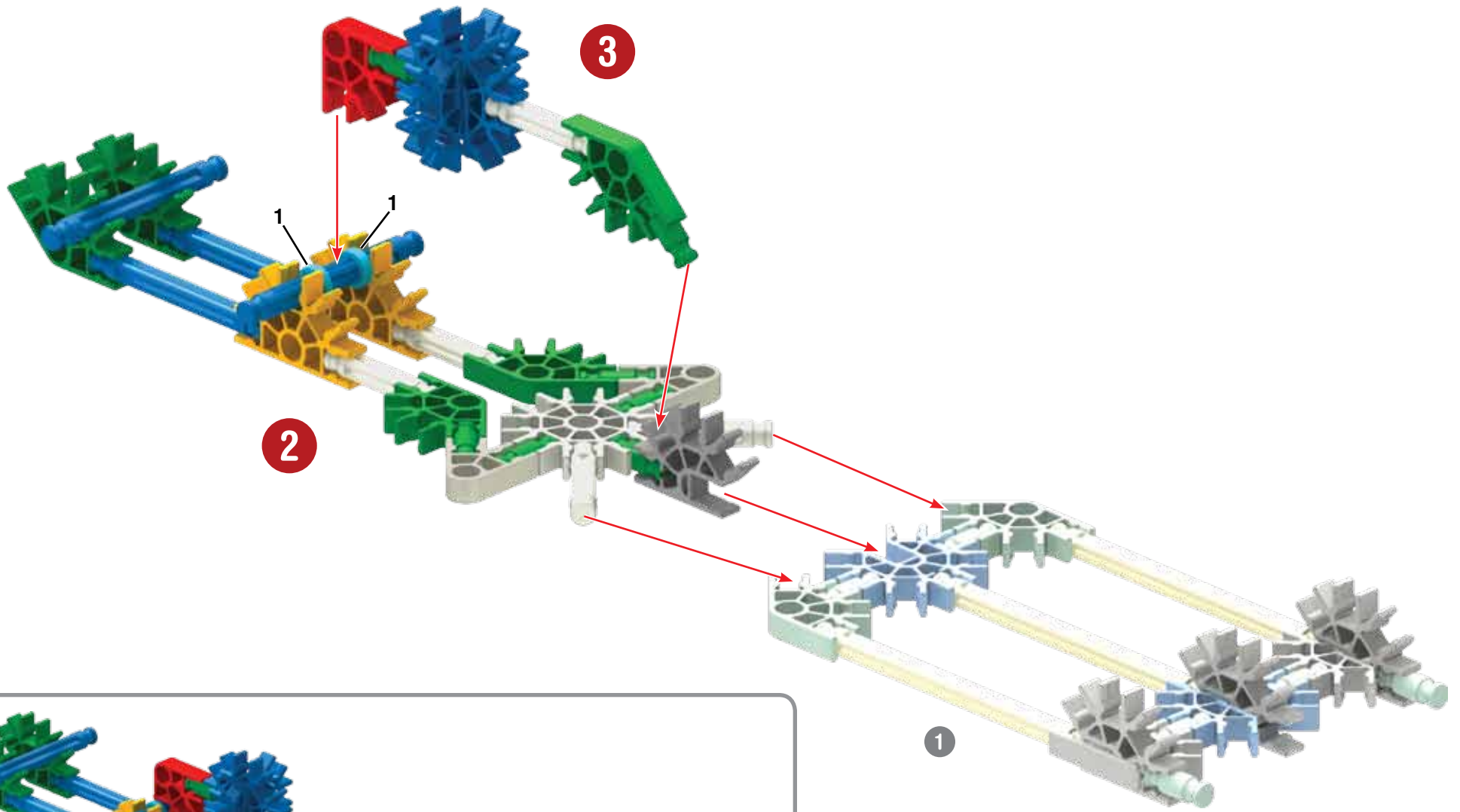

- | | | | | |
|---|---|---|---|---|
| 7 | 2 | 2 | 1 | 5 |
| 5 | 1 | 1 | 2 | 5 |
| 4 | | | | |
| 2 | 1 | 2 | 1 | |

1 - 3

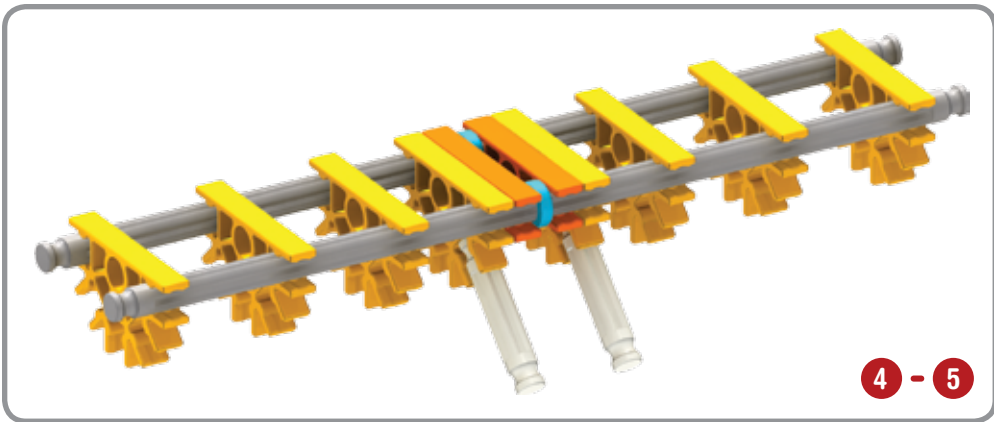
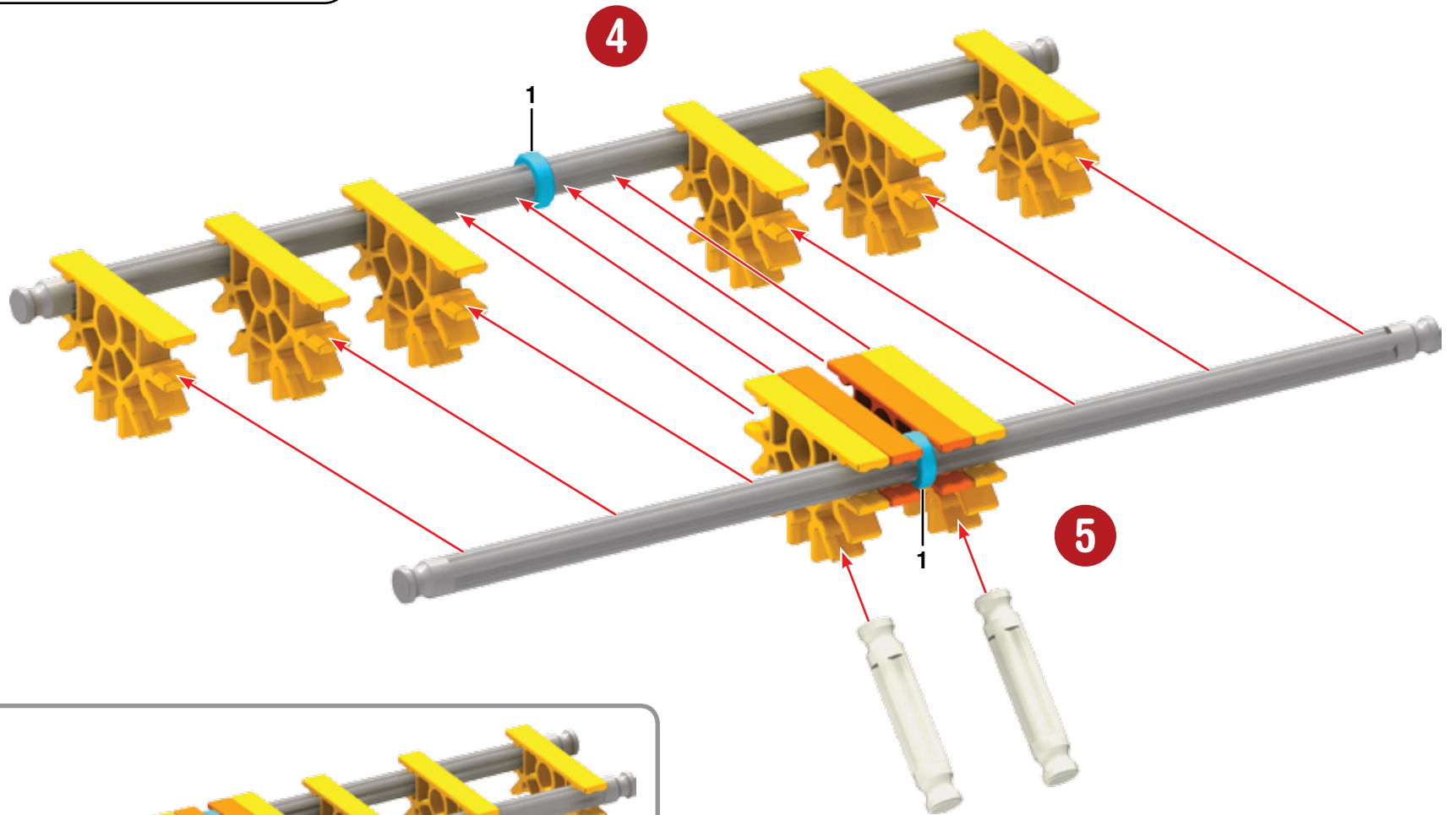
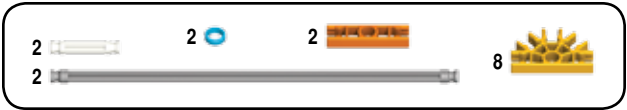

3 AIR MODELS

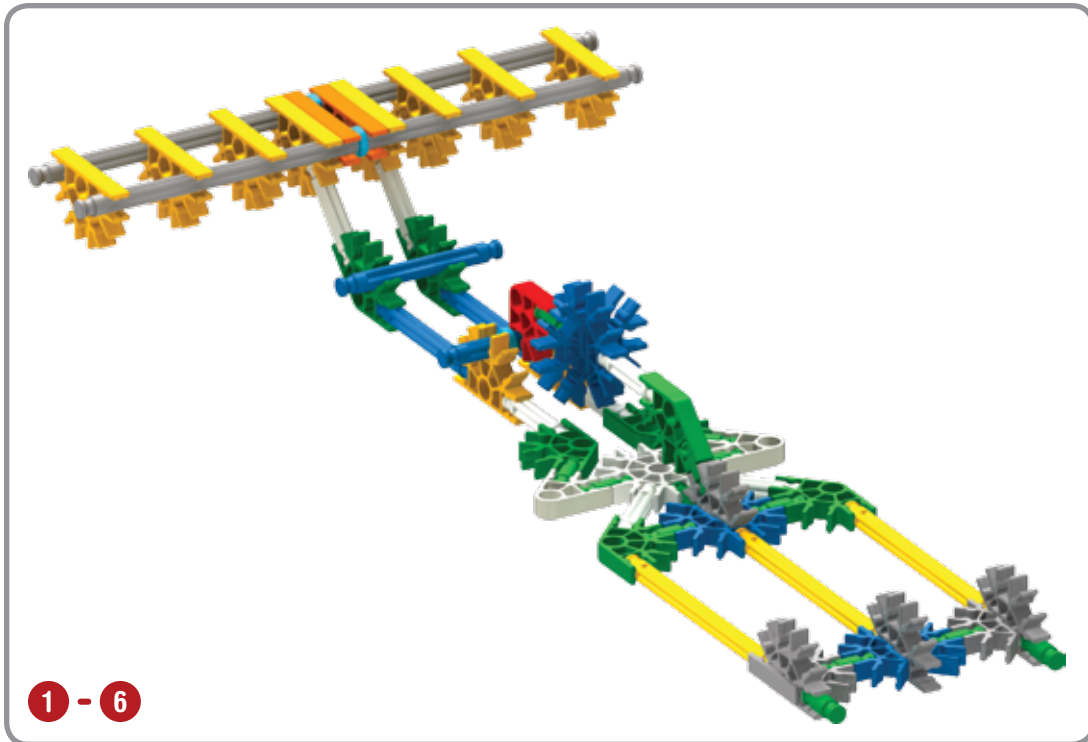
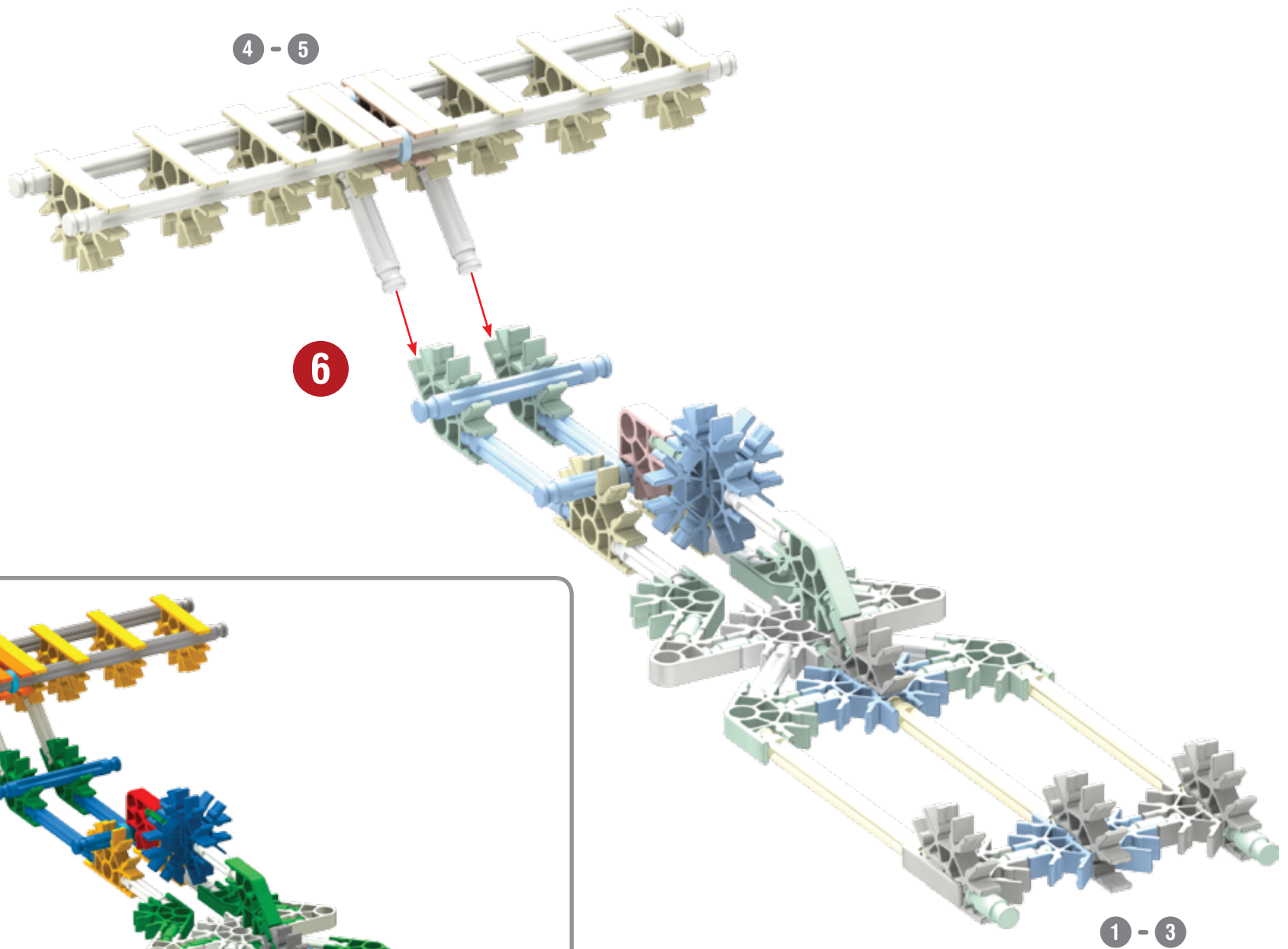

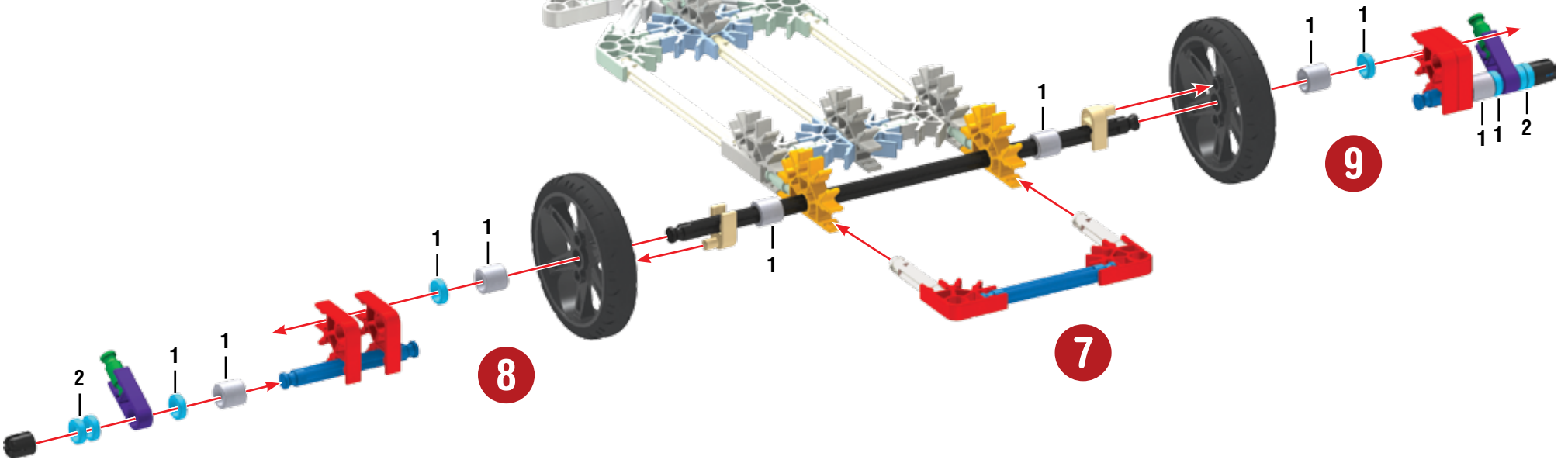
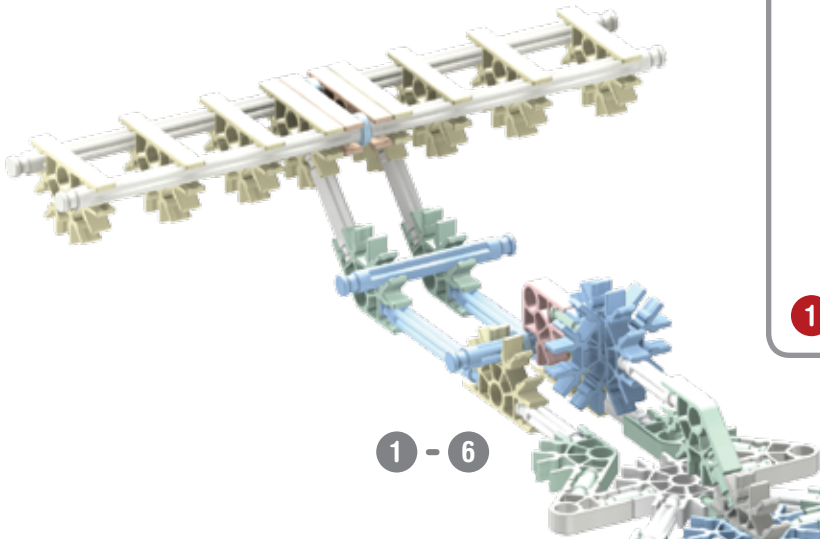
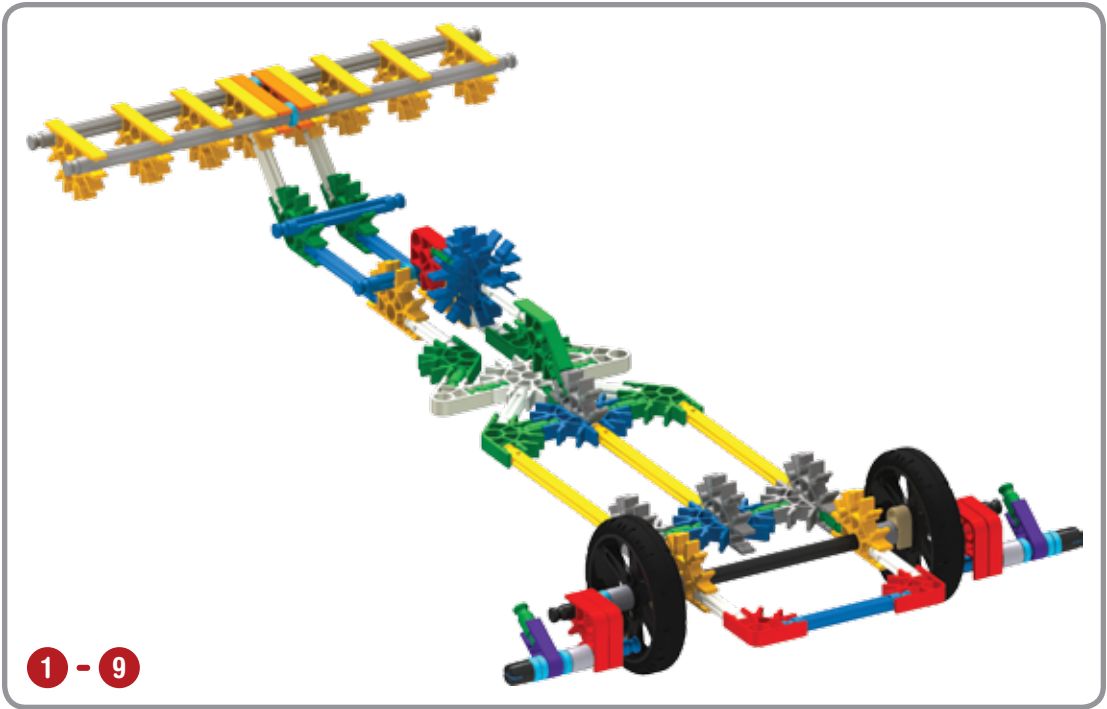
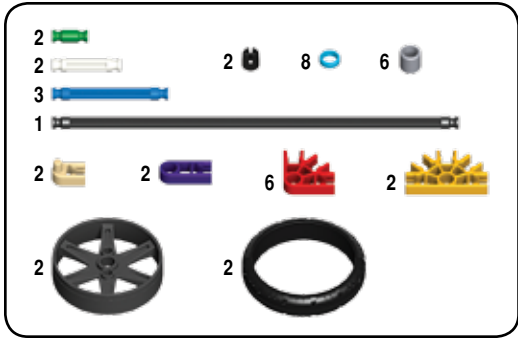

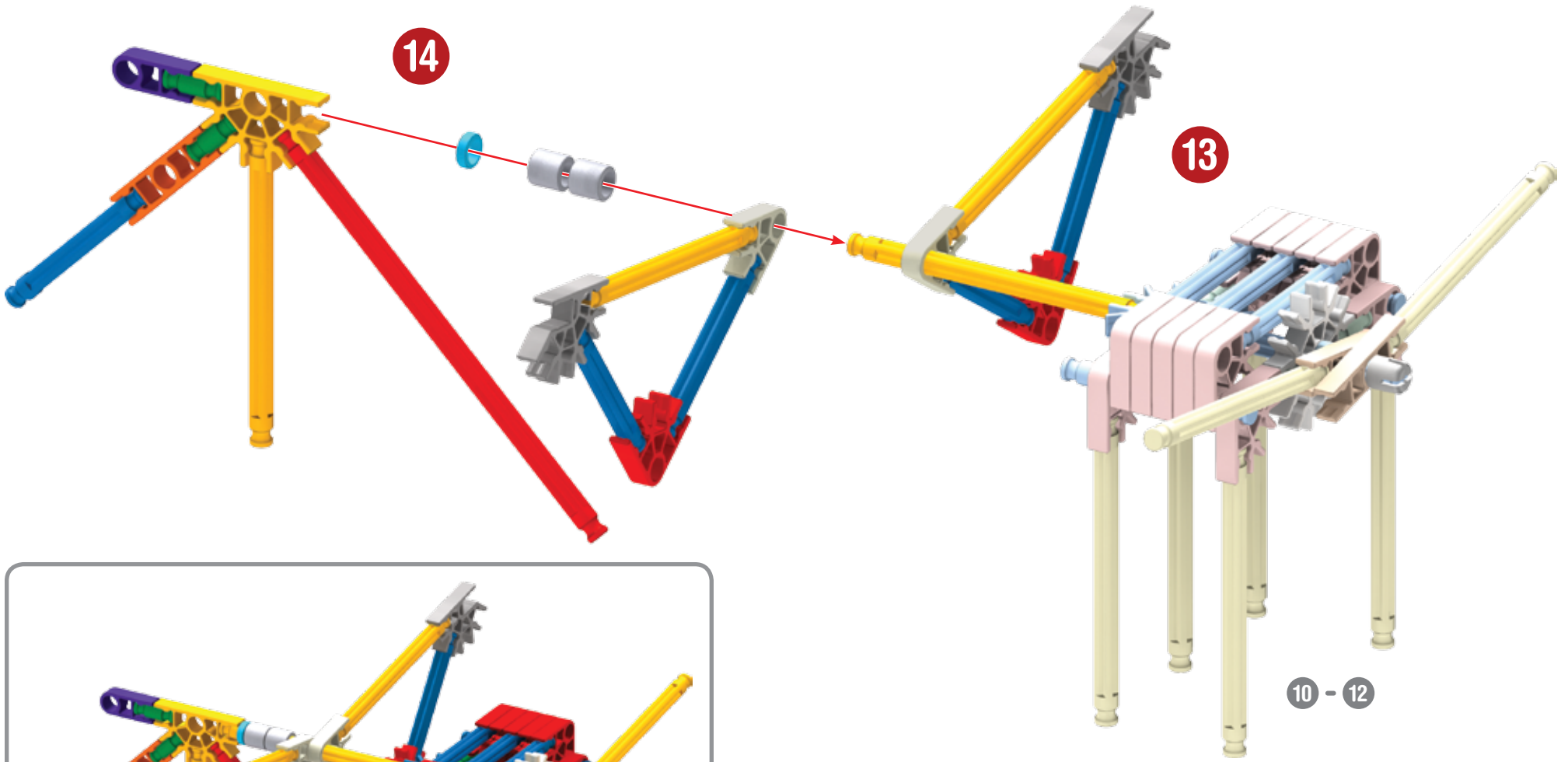

10 - 12

10 - 14

2		1		2		1	
5							
4						1	
1							
2		2		1		2	

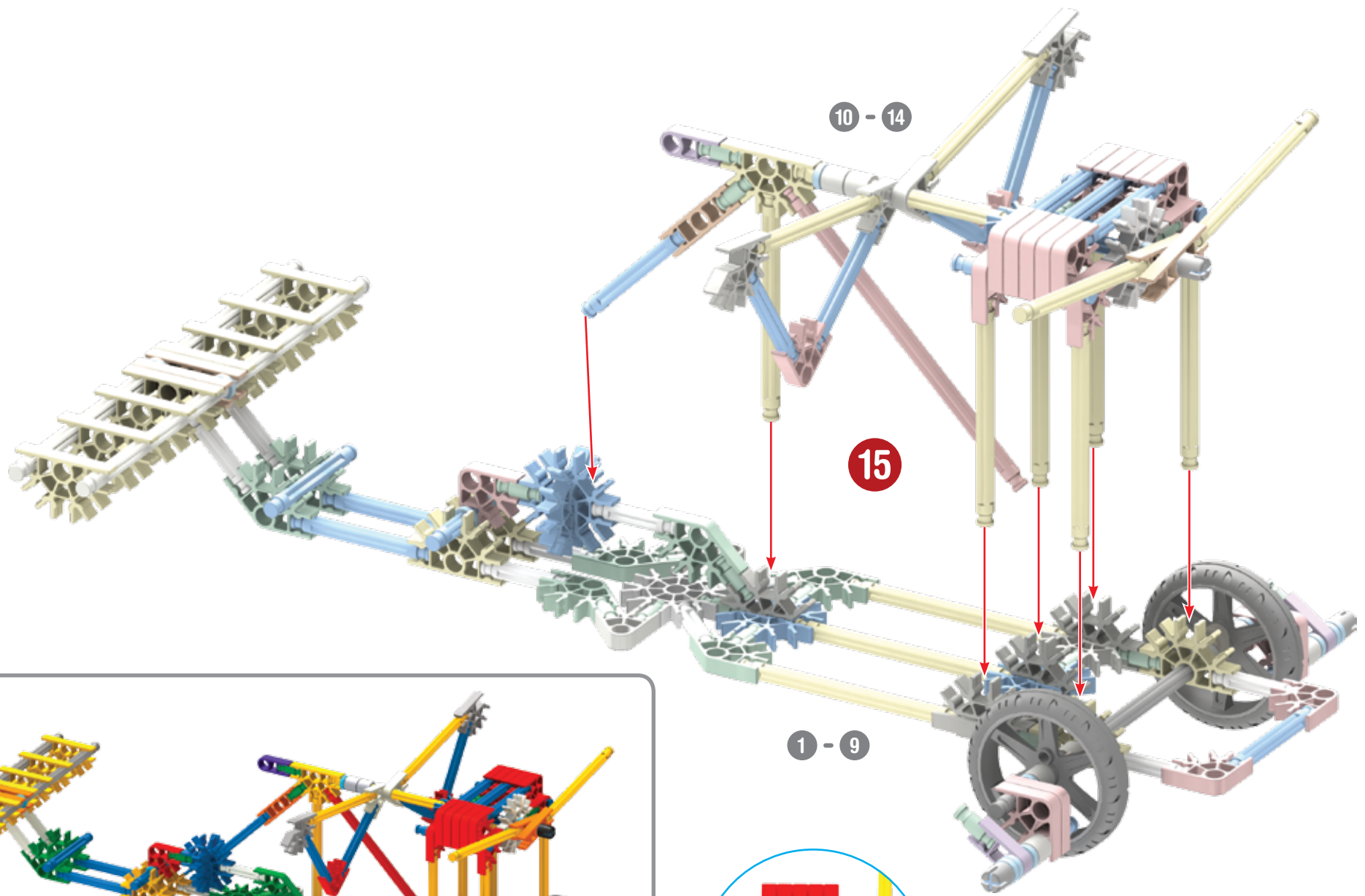

10 - 14

15

1 - 9



1 - 15

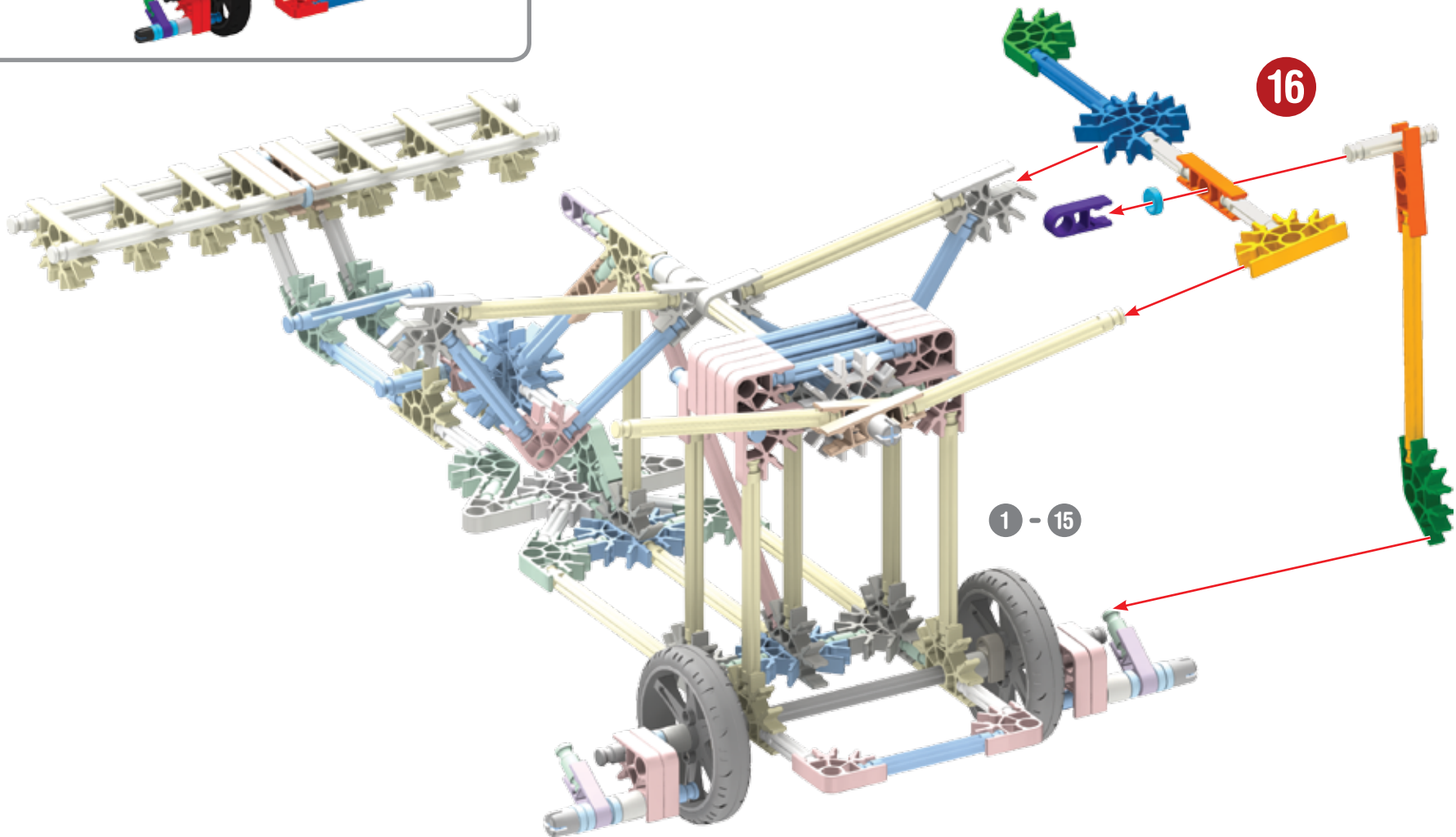
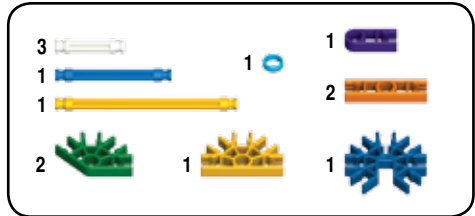

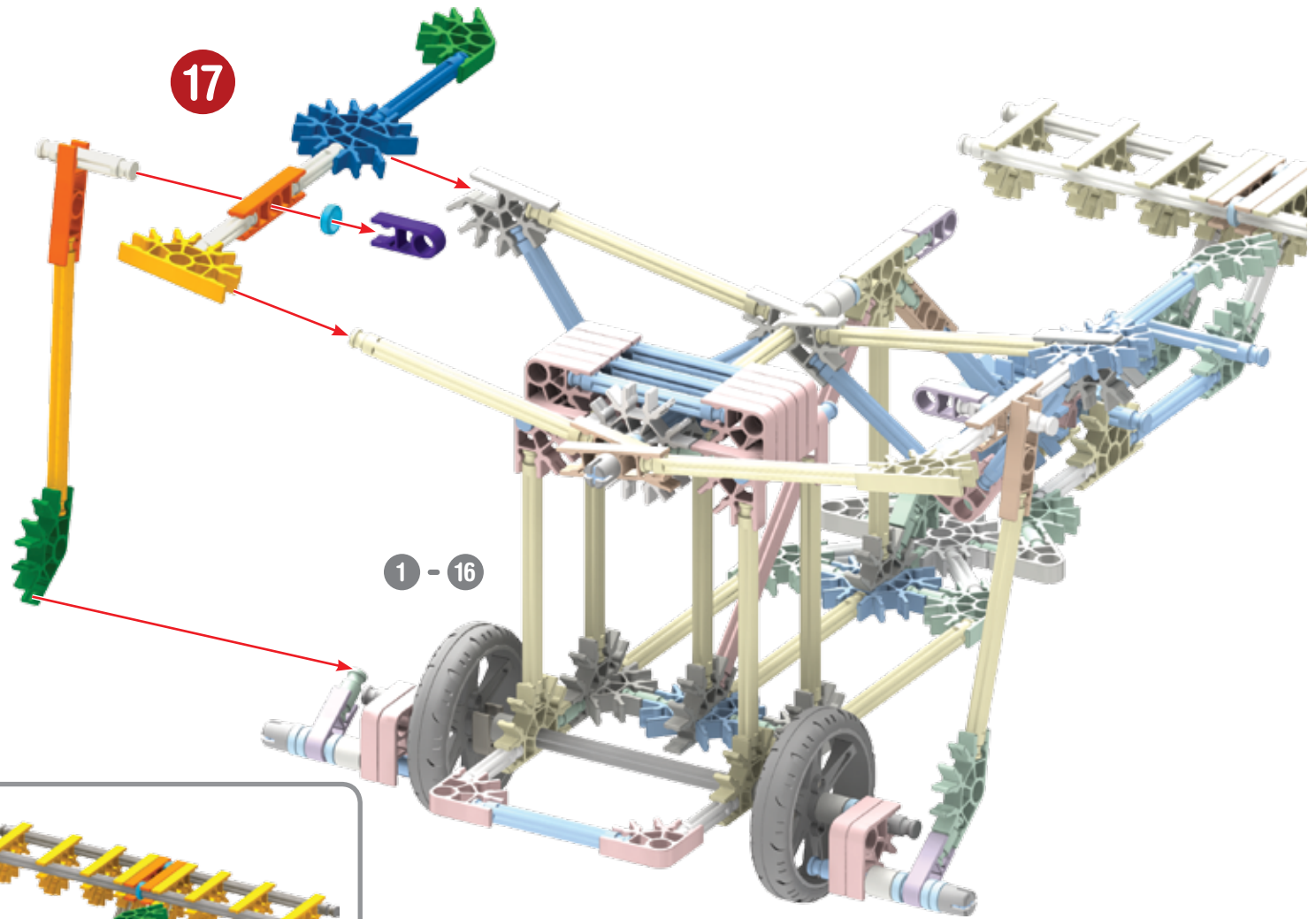

- | | | | | | |
|---|--|---|--|---|--|
| 3 | | 1 | | 1 | |
| 1 | | | | 2 | |
| 1 | | | | | |
| 2 | | 1 | | 1 | |

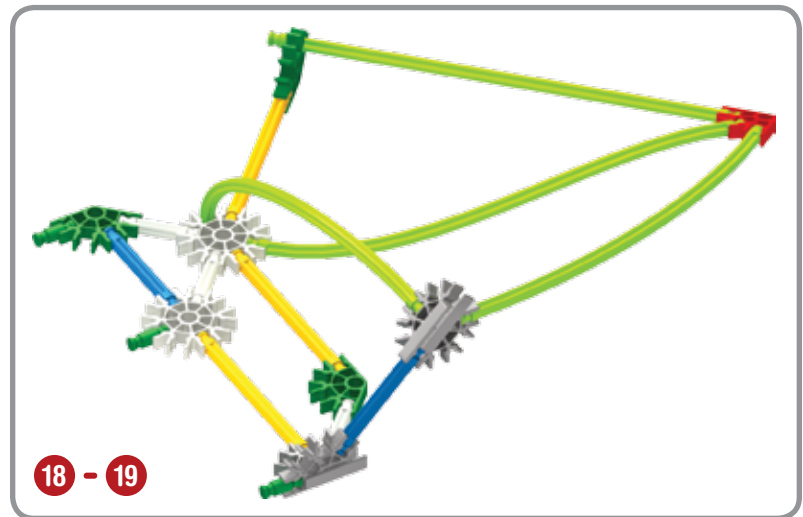
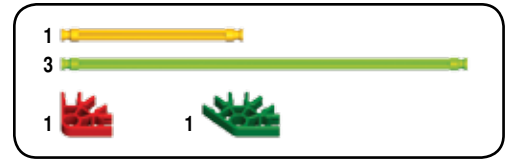
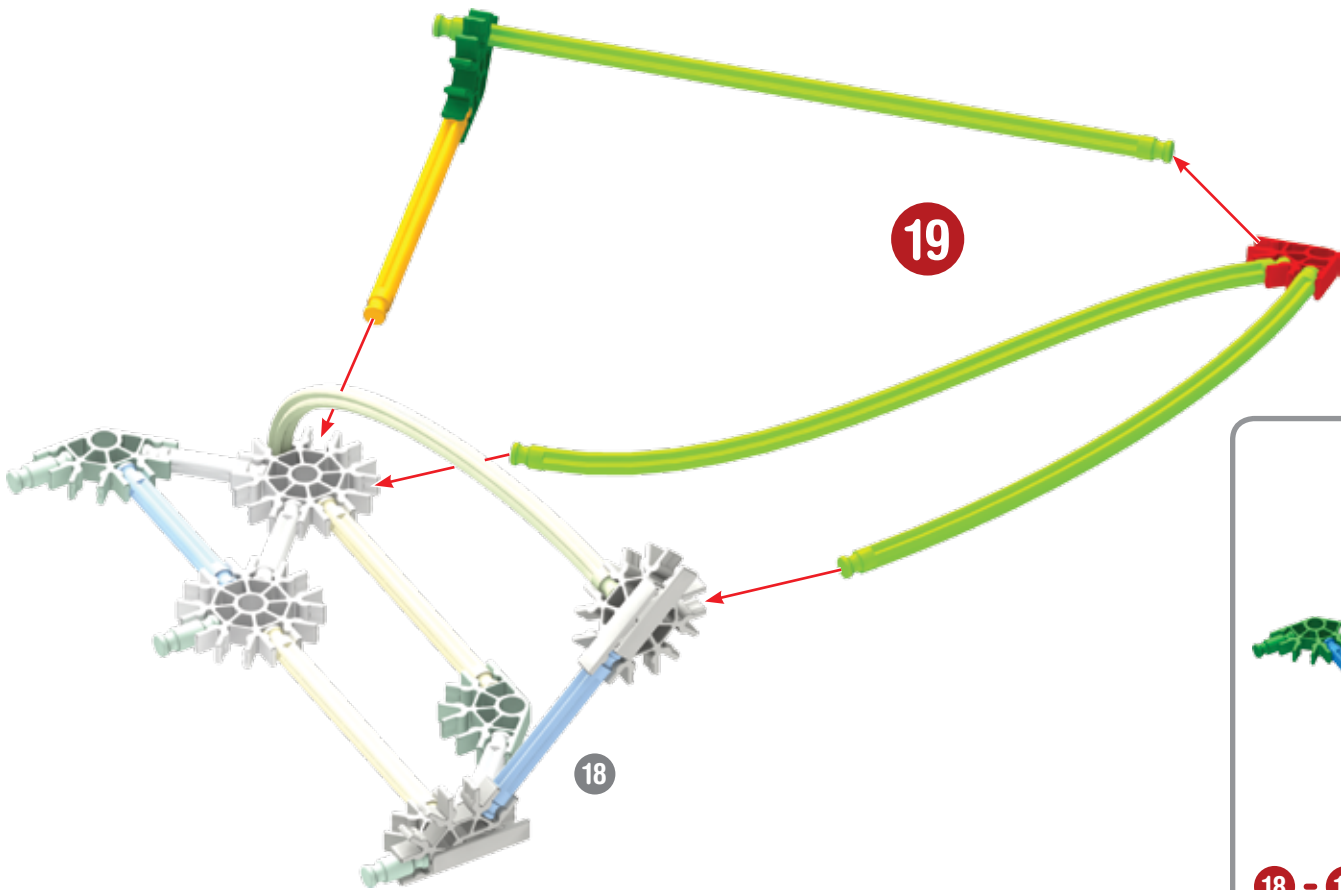
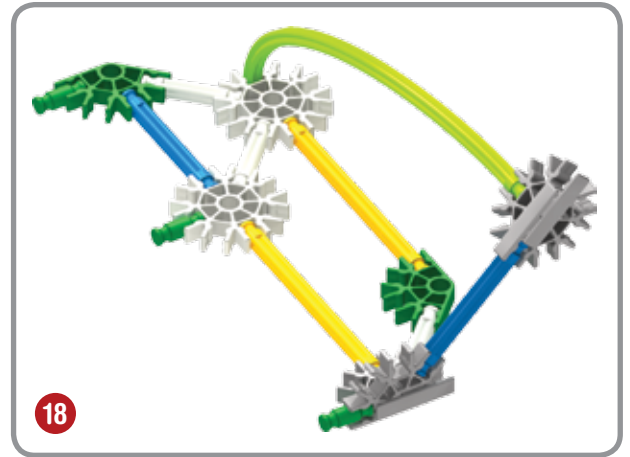
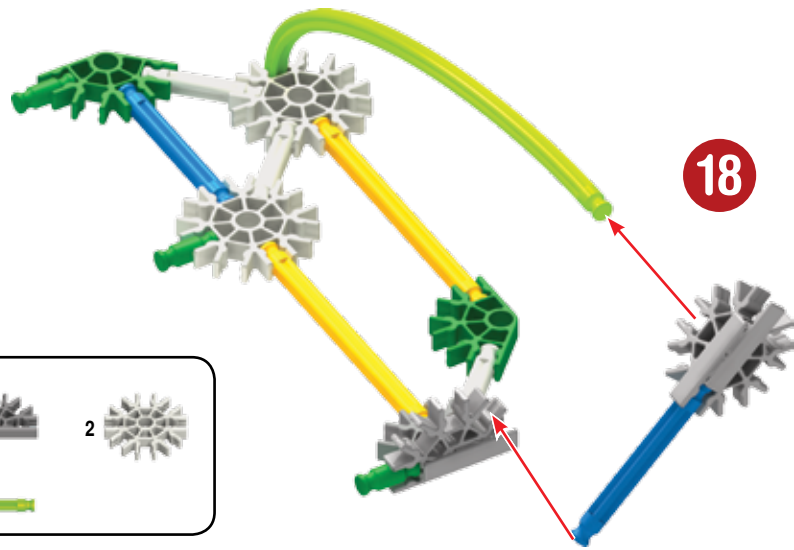
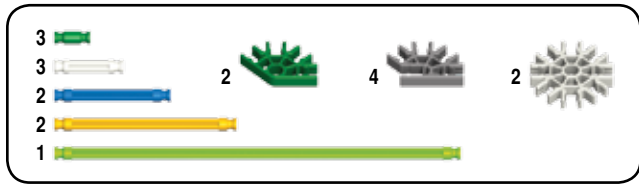

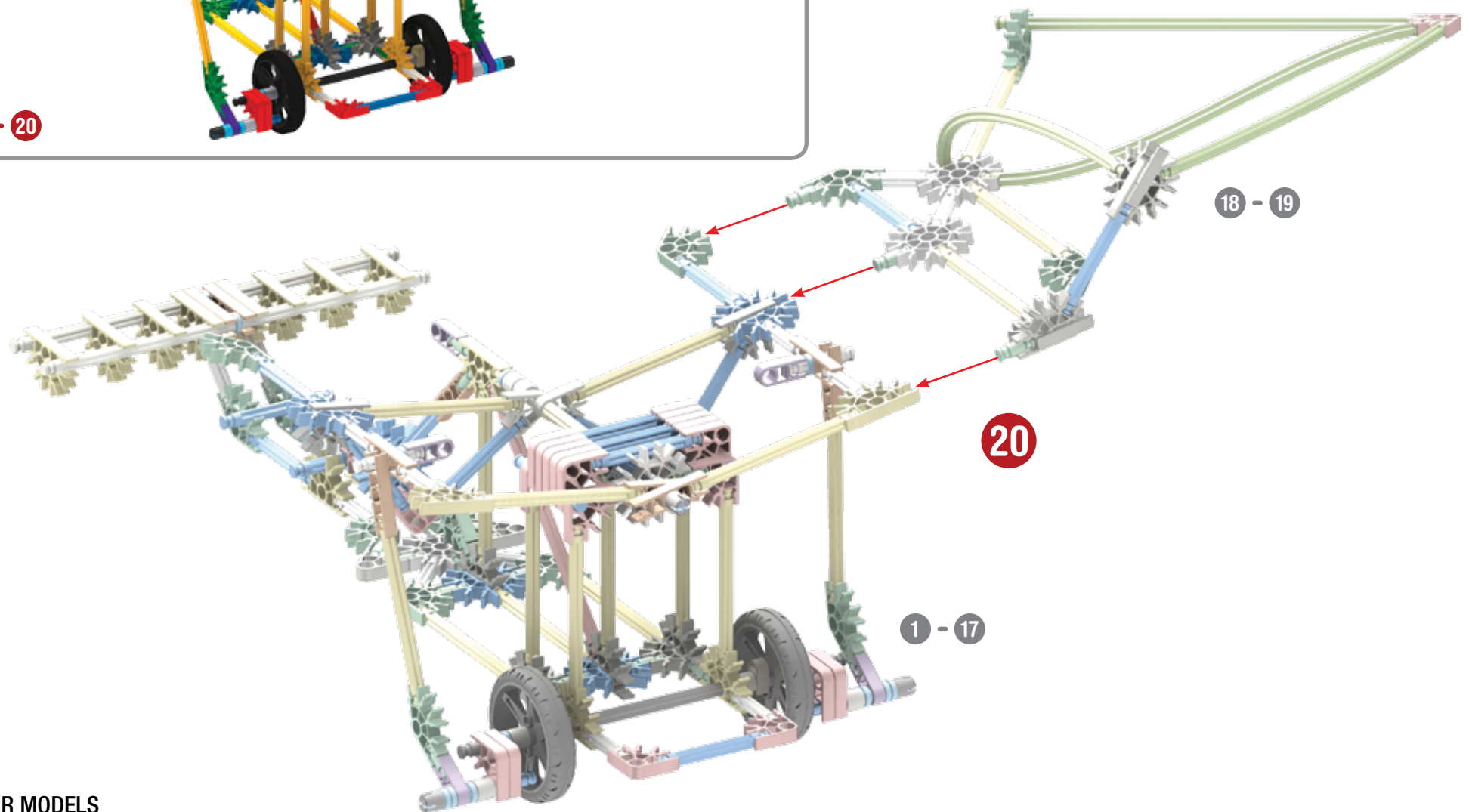

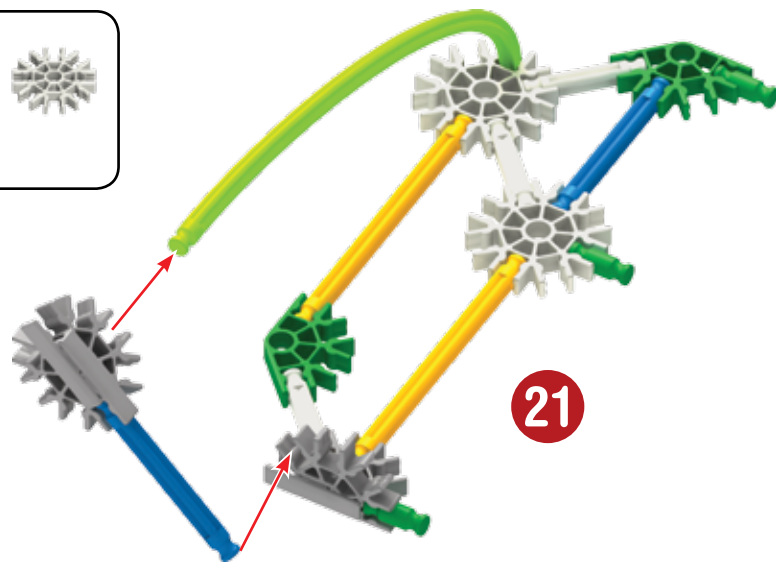
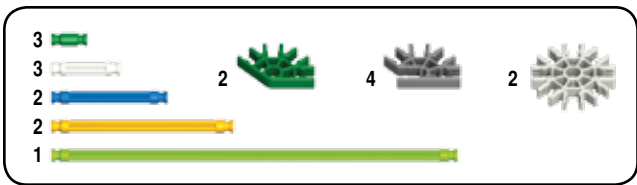

21

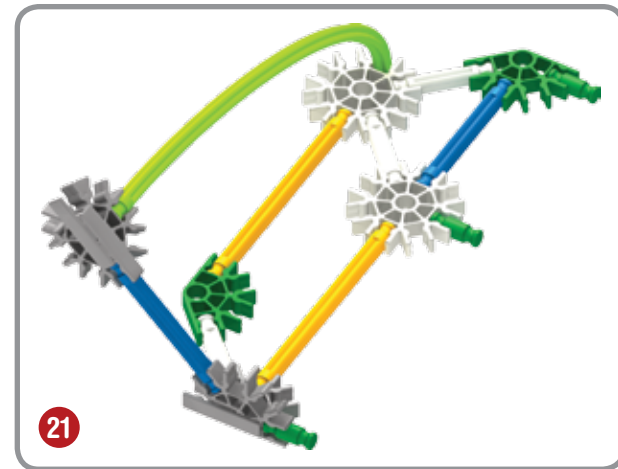

21

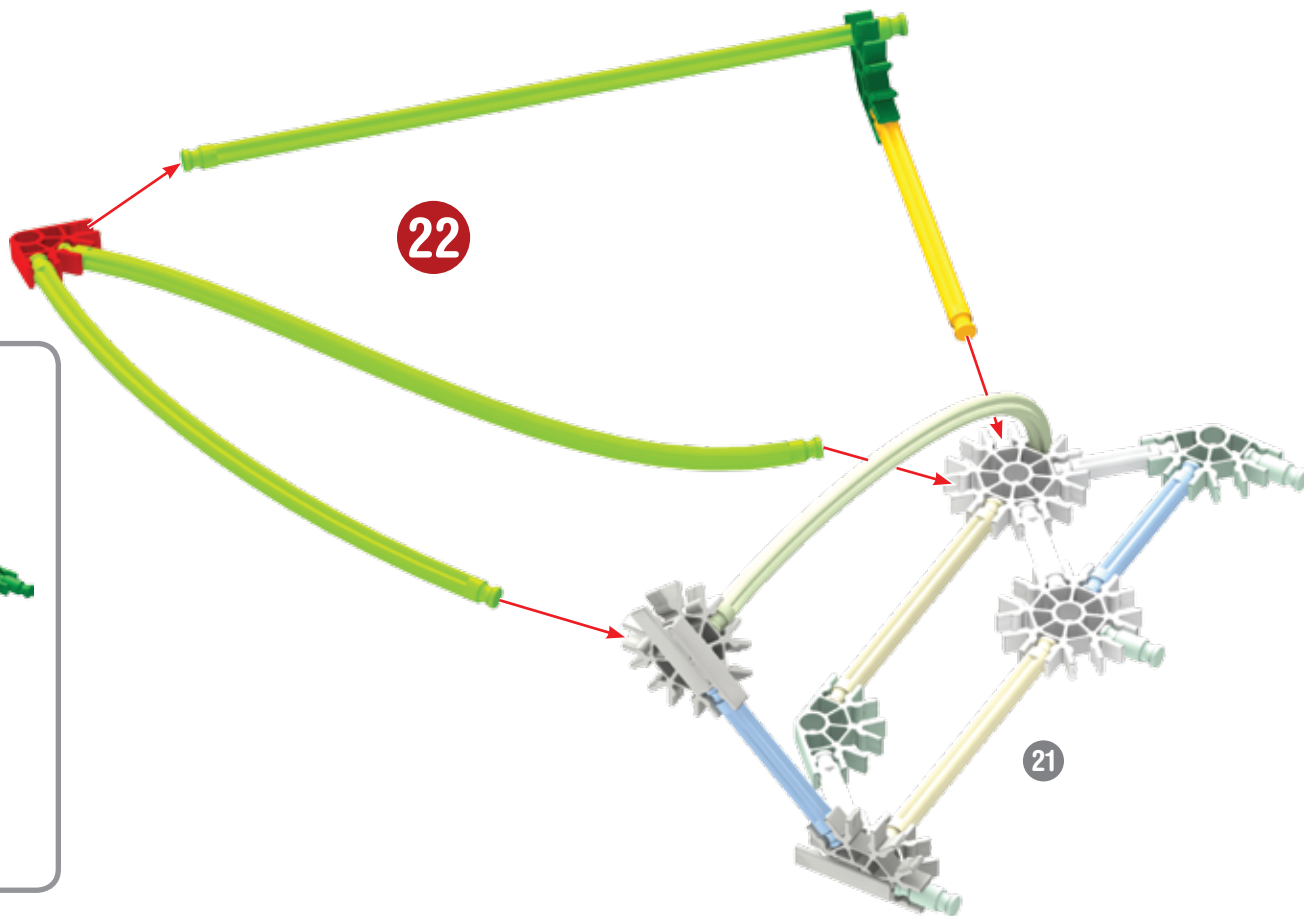
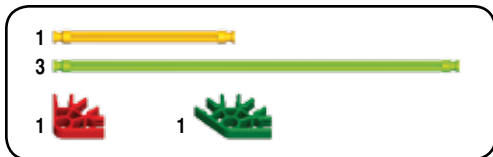

22

21

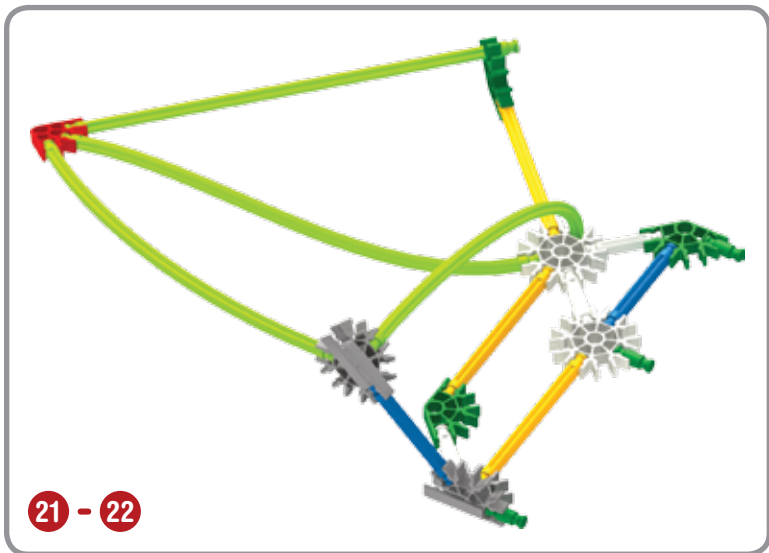

21 - 22

Flying Machine

1 - 23

21 - 22

23

1 - 20

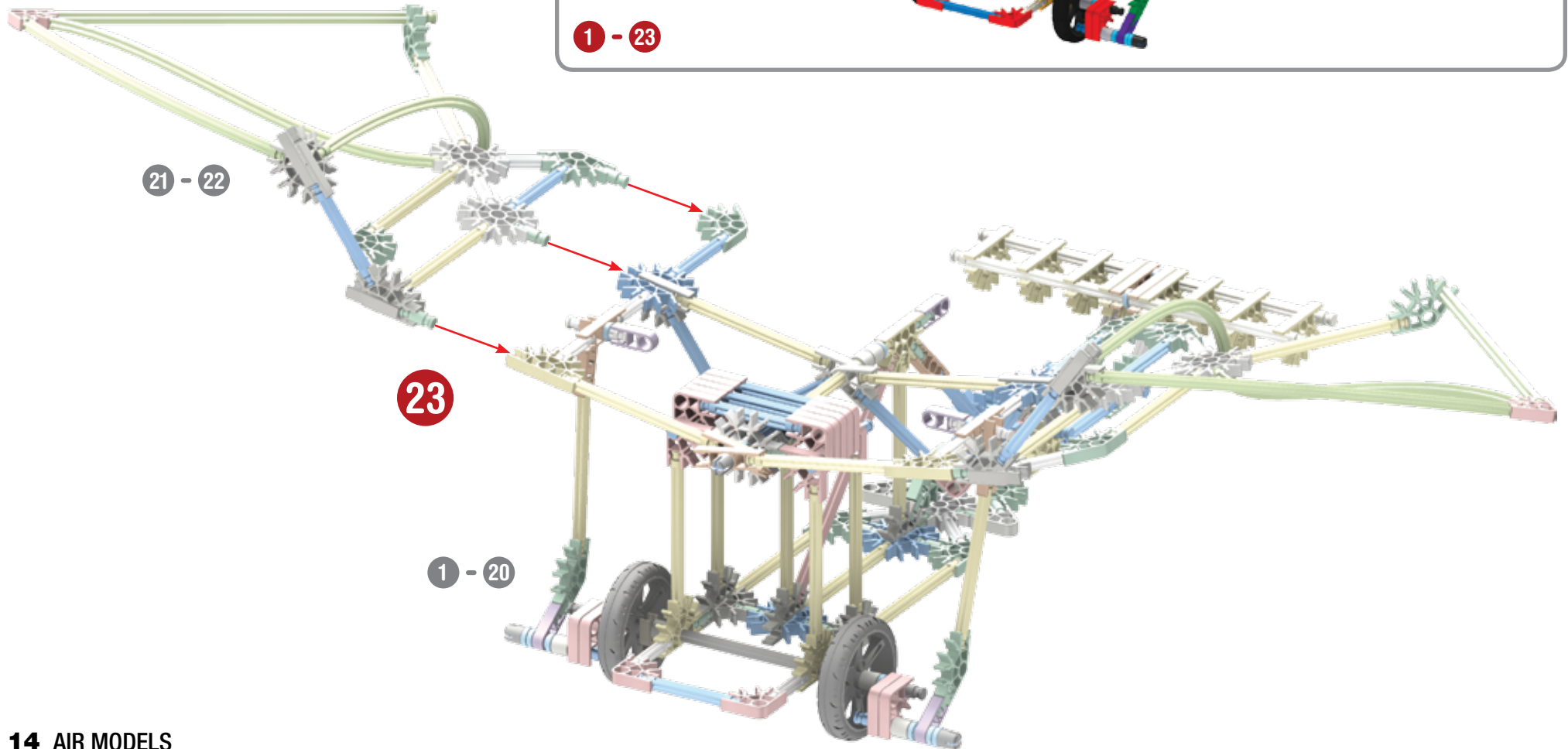

Hang Glider

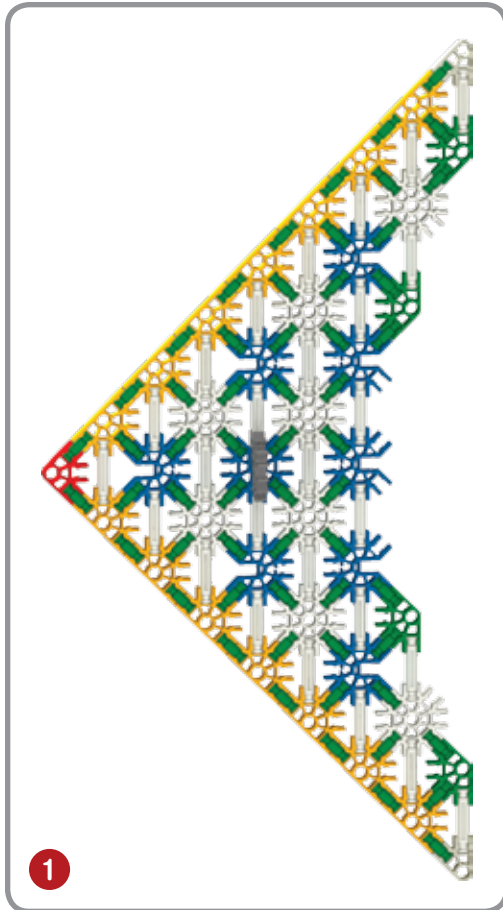
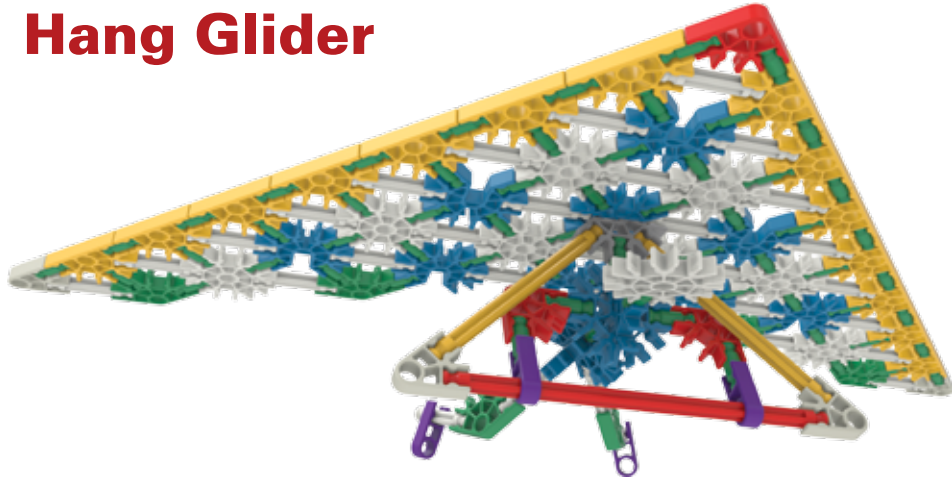

1

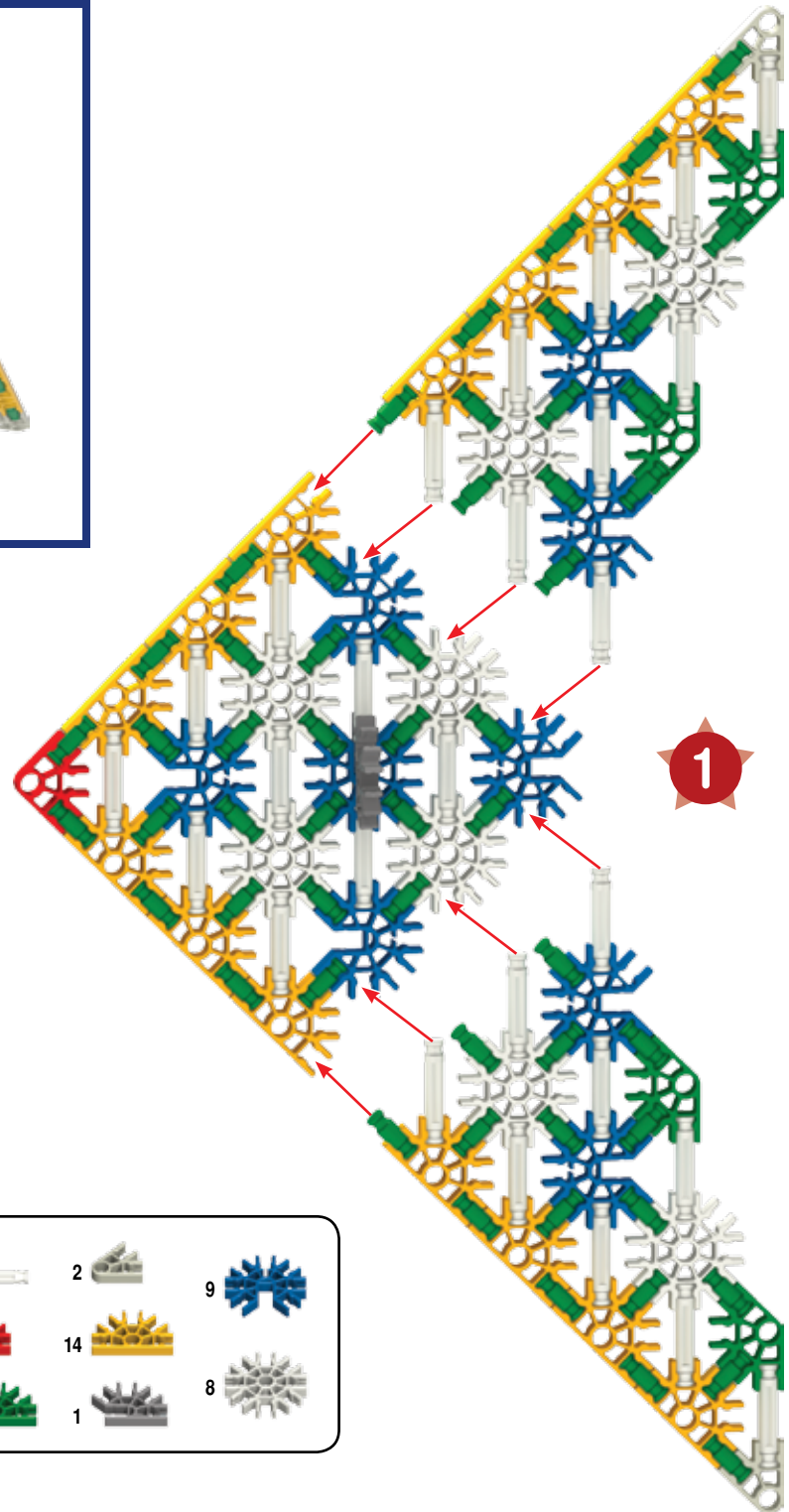

58		2		9	
27		14		8	
1		1			
4					

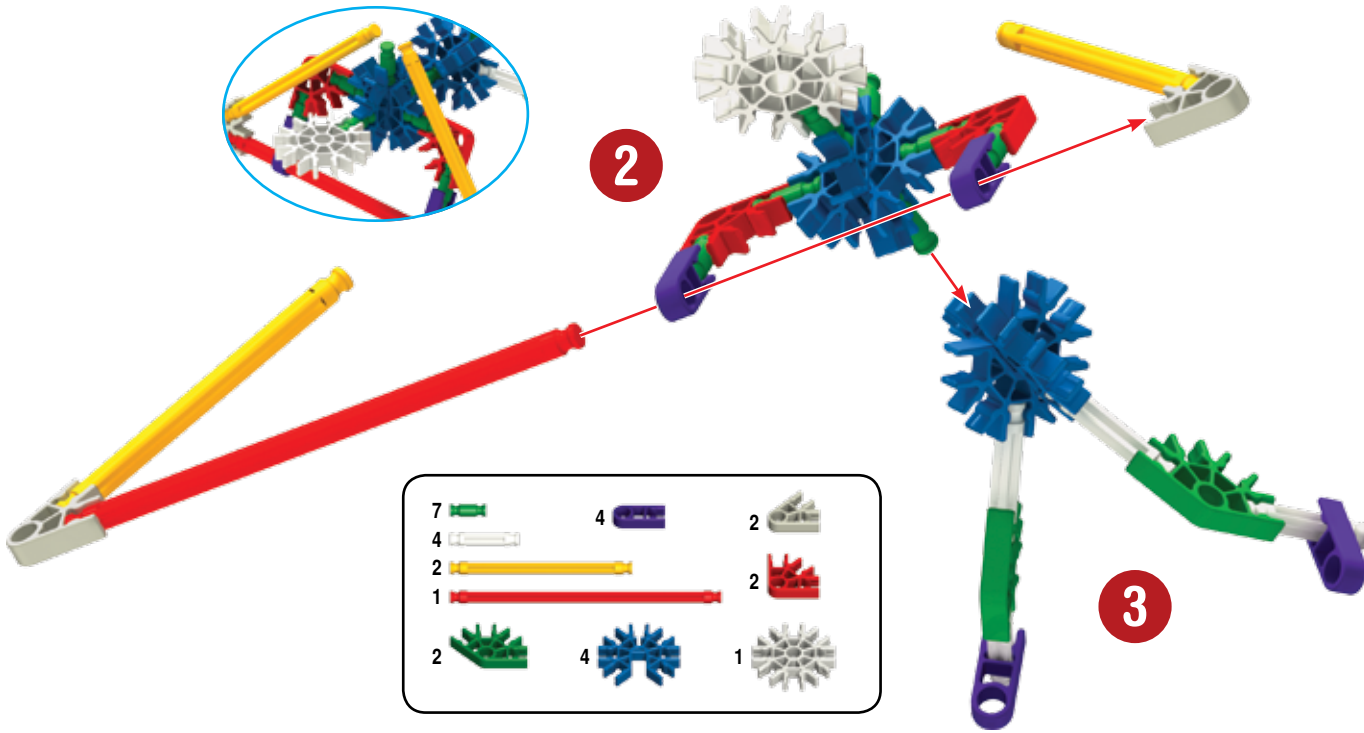

7	4	2
4	2	2
2	1	2
1	2	1
2	4	1

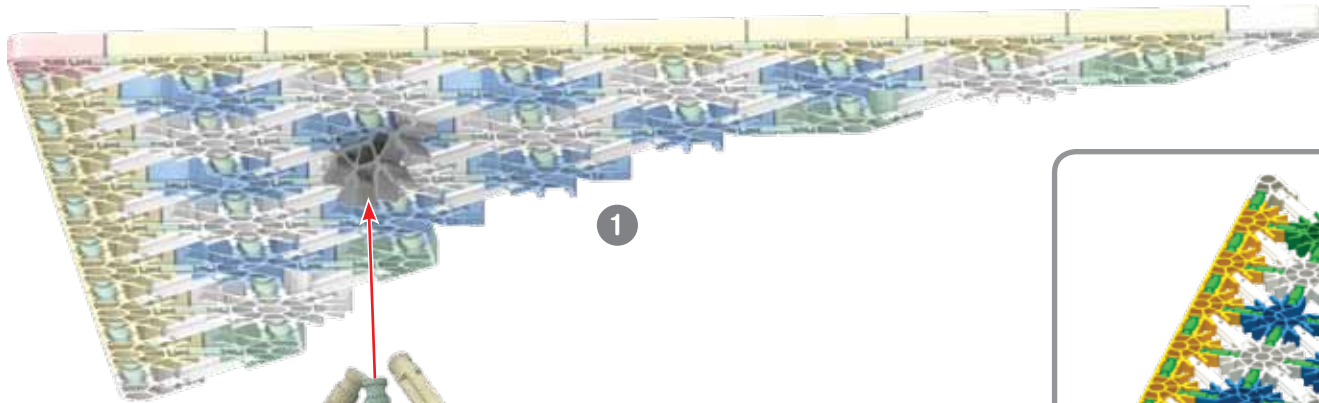
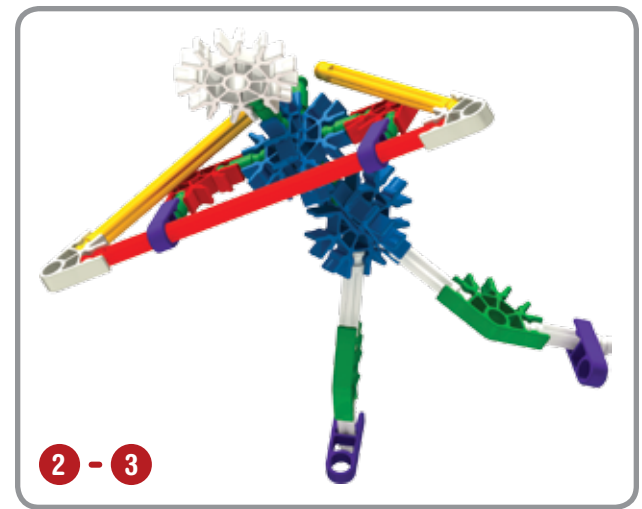

4

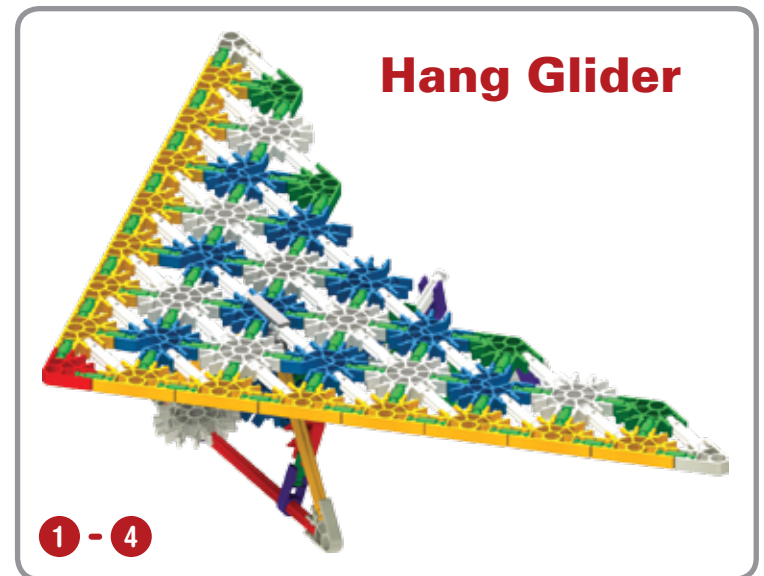

Helicopter



- | | | | | | |
|---|--|---|--|---|--|
| 9 | | 2 | | 5 | |
| 7 | | | | | |
| 3 | | | | | |
| 1 | | 1 | | | |
| 4 | | 8 | | | |

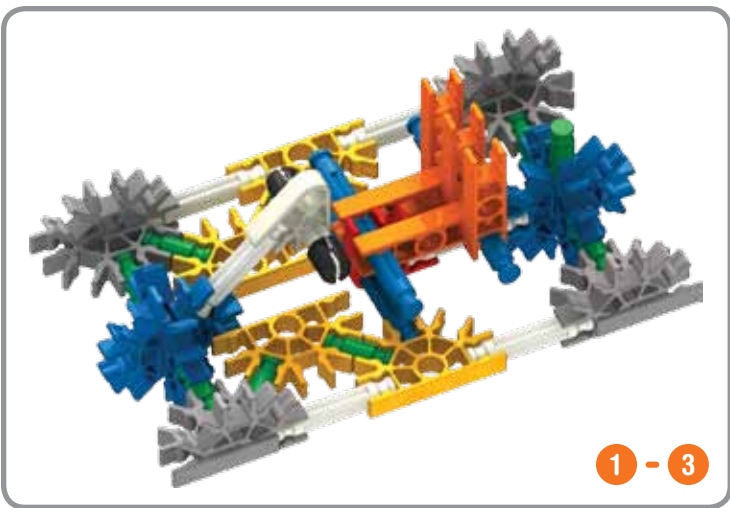
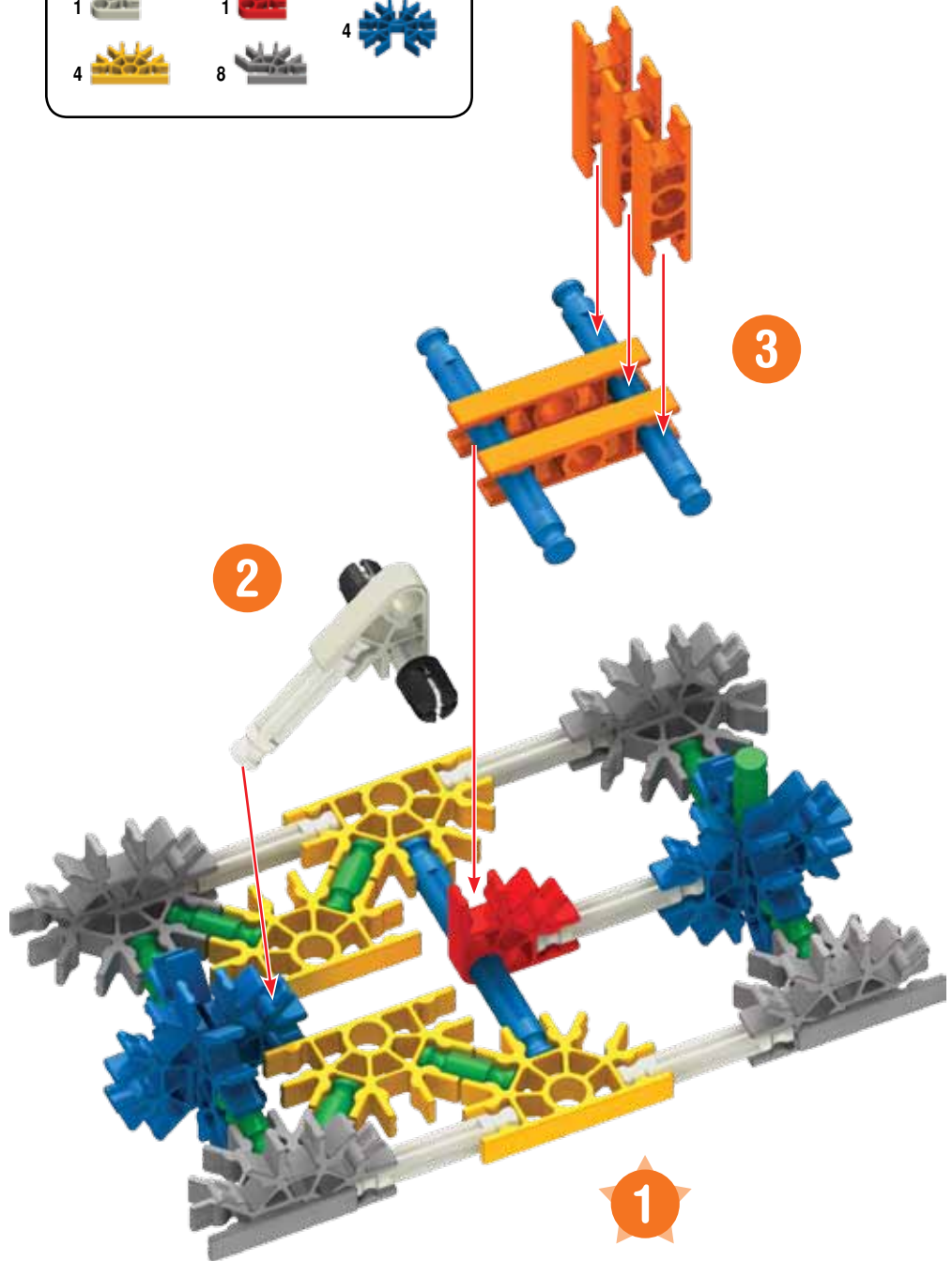

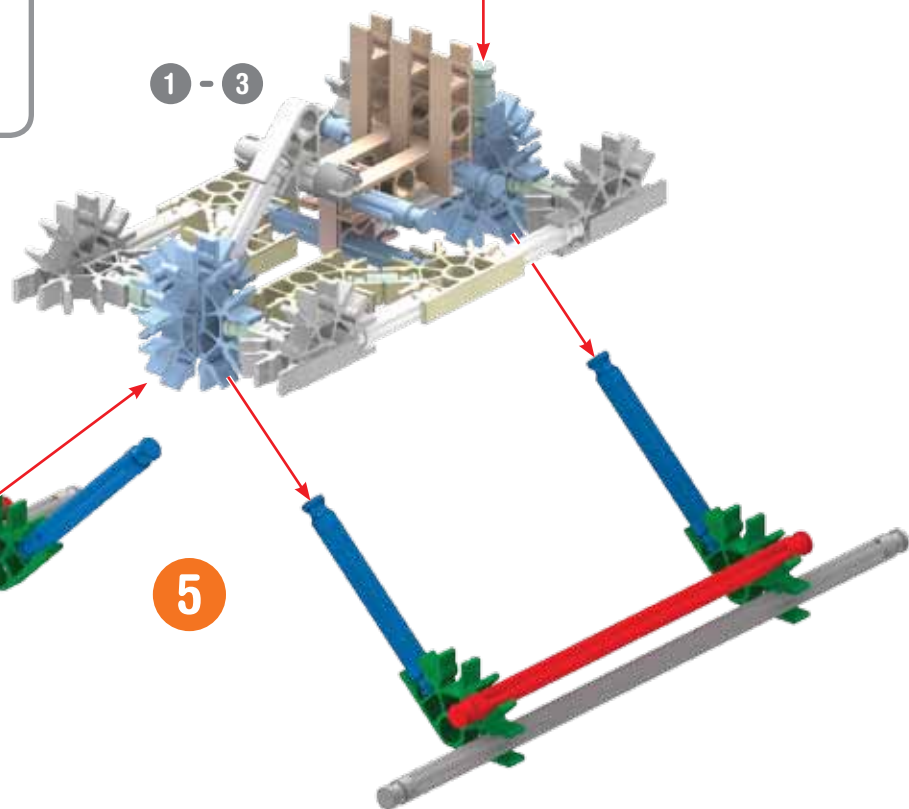
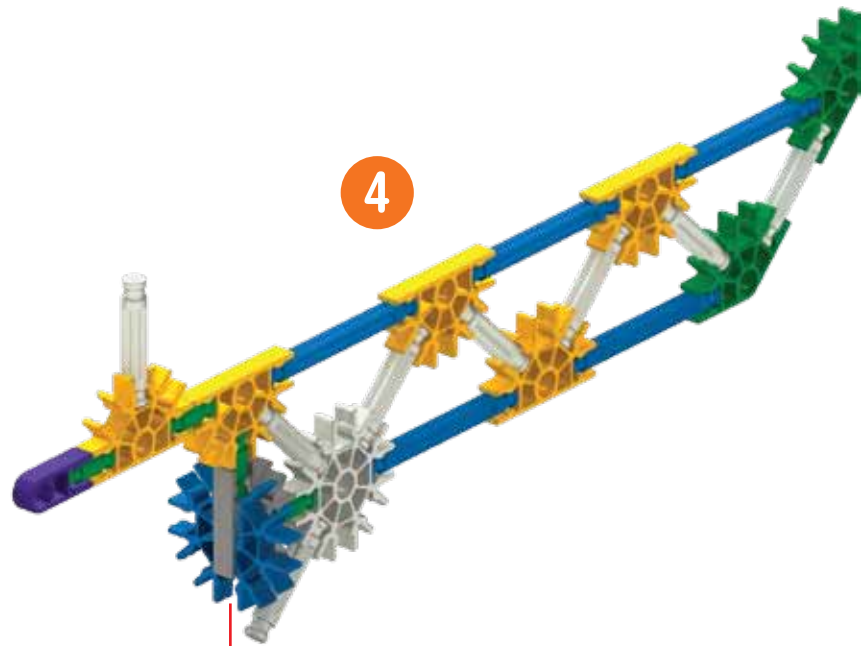
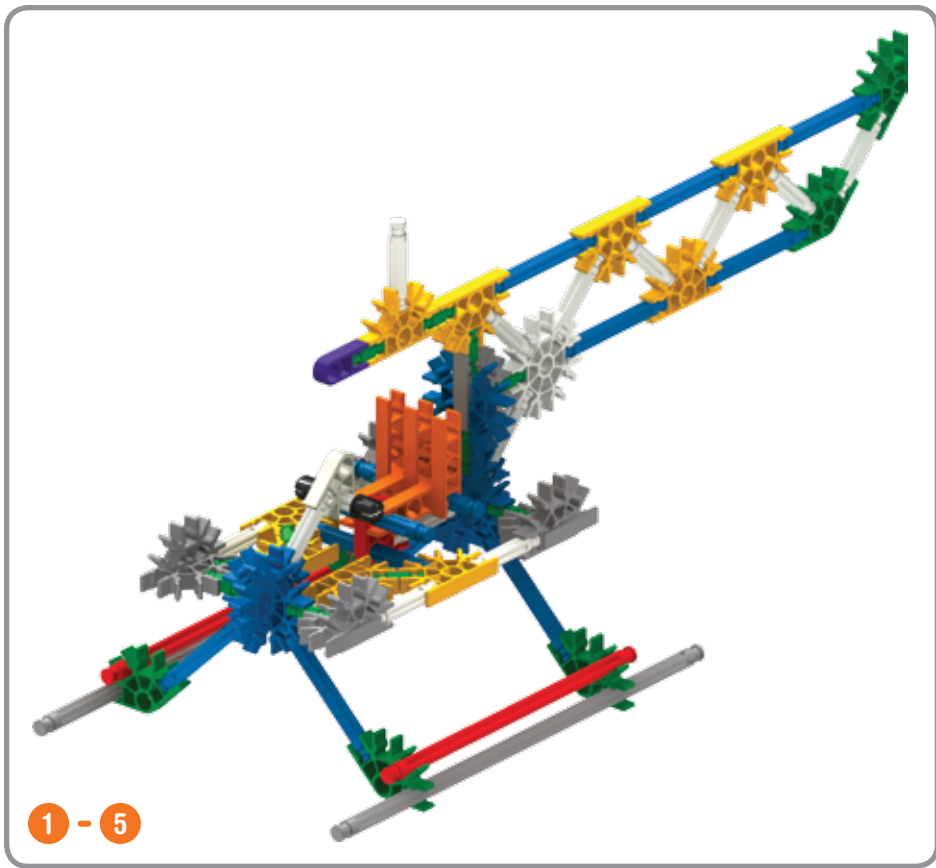

- | | | | | | |
|---|--|---|--|---|--|
| 4 | | 5 | | 1 | |
| 8 | | | | 6 | |
| 9 | | | | | |
| 2 | | | | | |
| 2 | | | | | |
| 1 | | 1 | | 1 | |

- 6
- 6
- 4
- 2
- 4
- 2
- 2
- 4
- 2
- 2

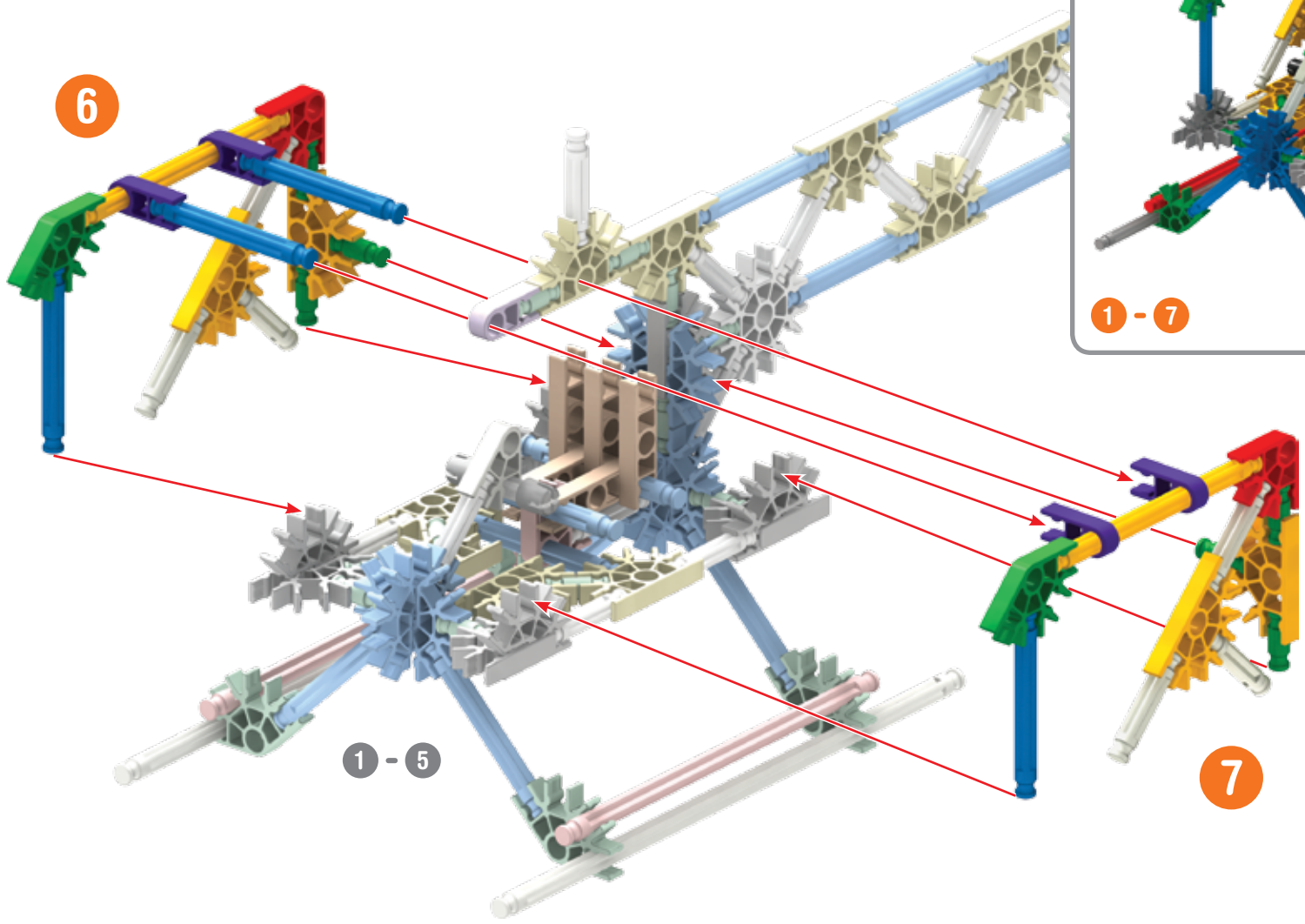

- | | | | | | | | |
|----|--|---|--|---|--|---|--|
| 8 | | 1 | | 1 | | 2 | |
| 12 | | 2 | | 1 | | 2 | |
| 2 | | 4 | | 1 | | 2 | |
| 4 | | 2 | | 2 | | 4 | |
| 1 | | 2 | | 3 | | 4 | |
| 2 | | 4 | | 4 | | | |

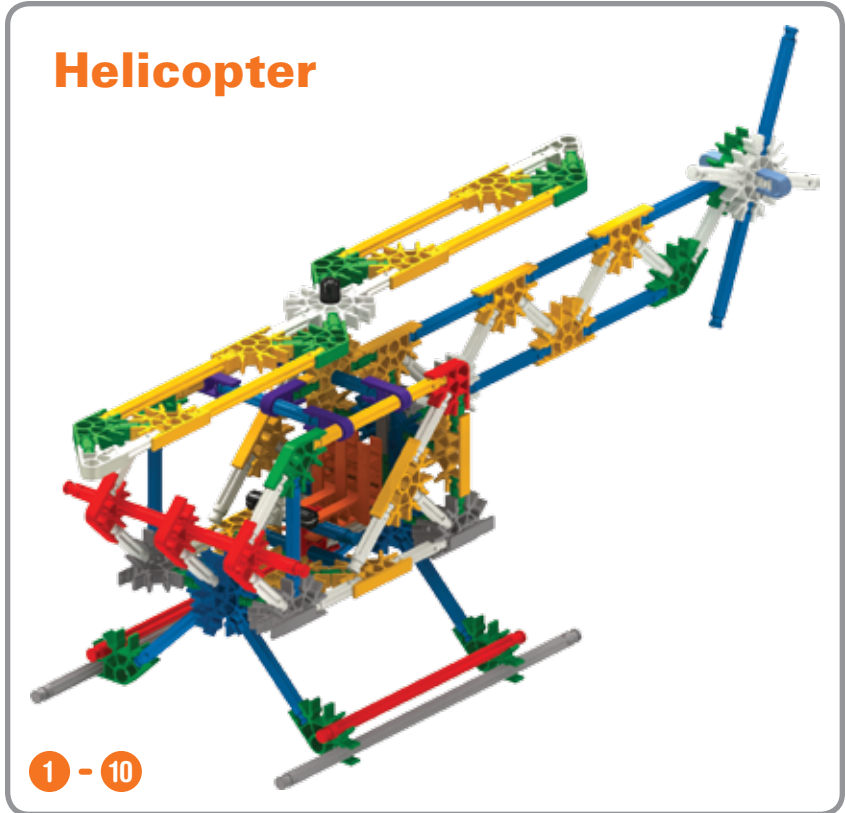
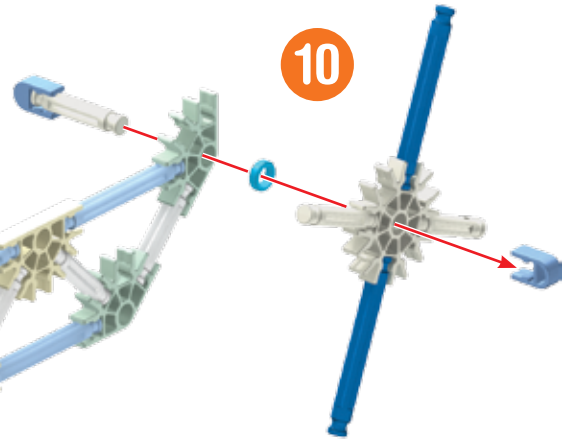
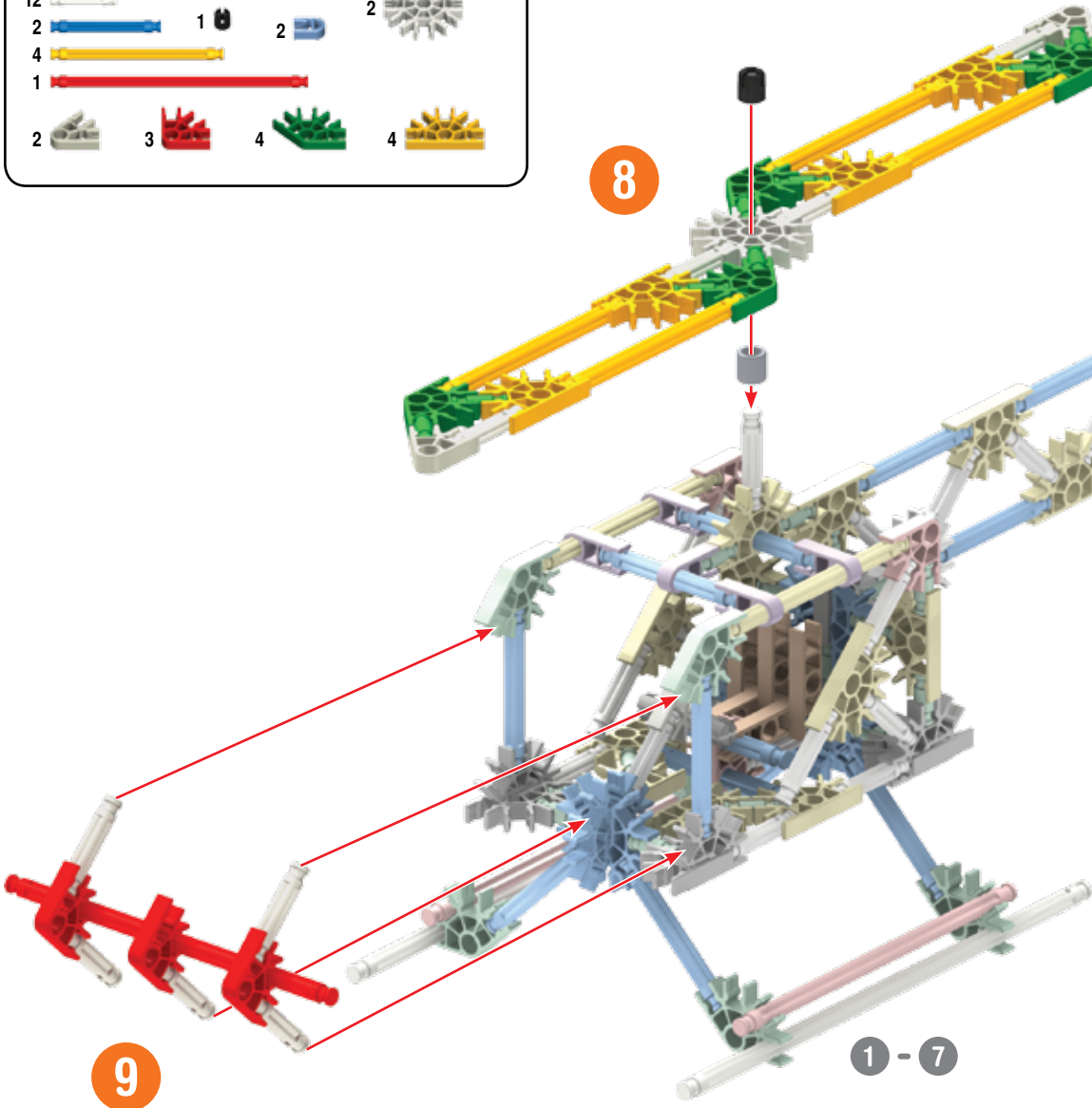

Helicopter

Hot Air Balloon

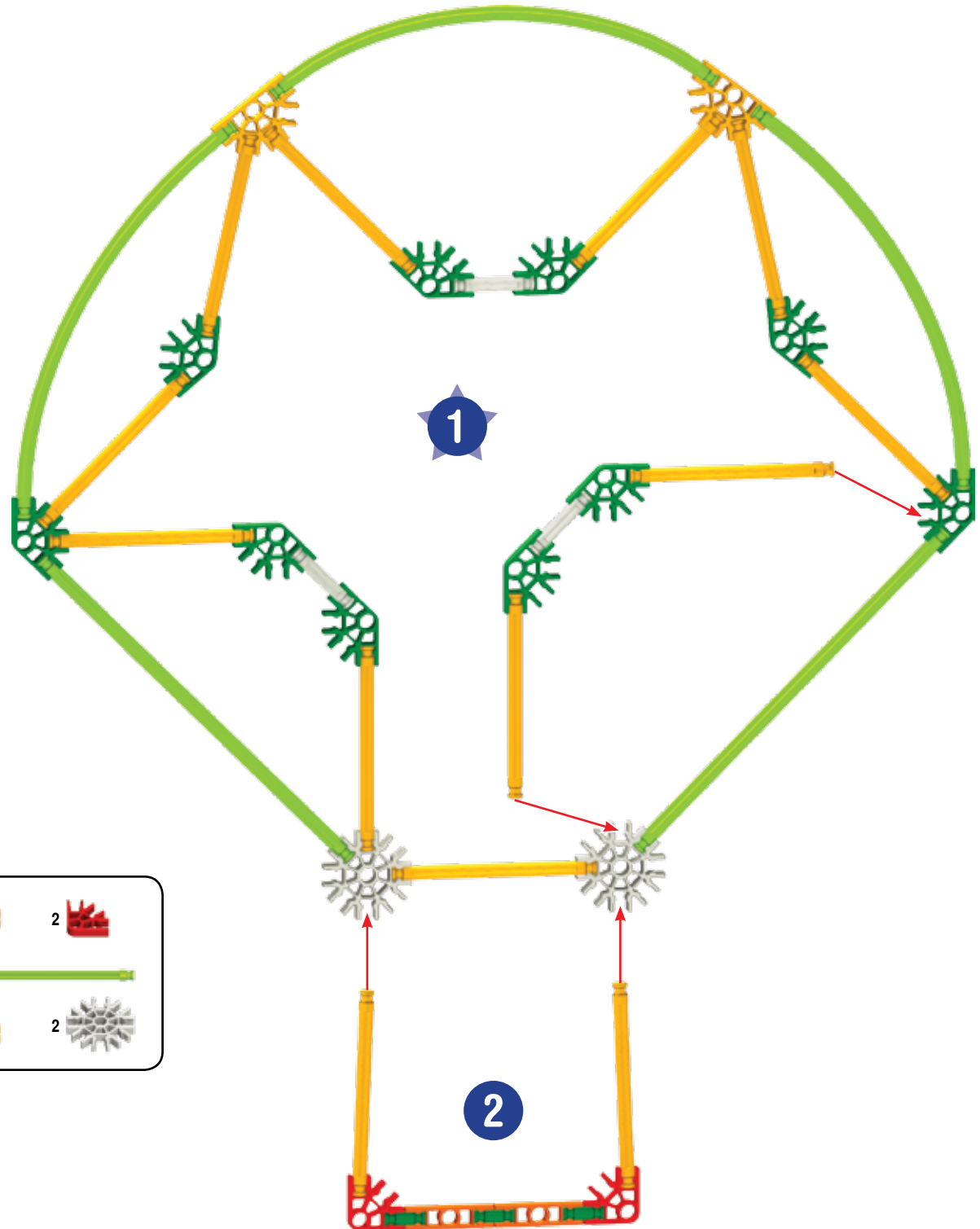
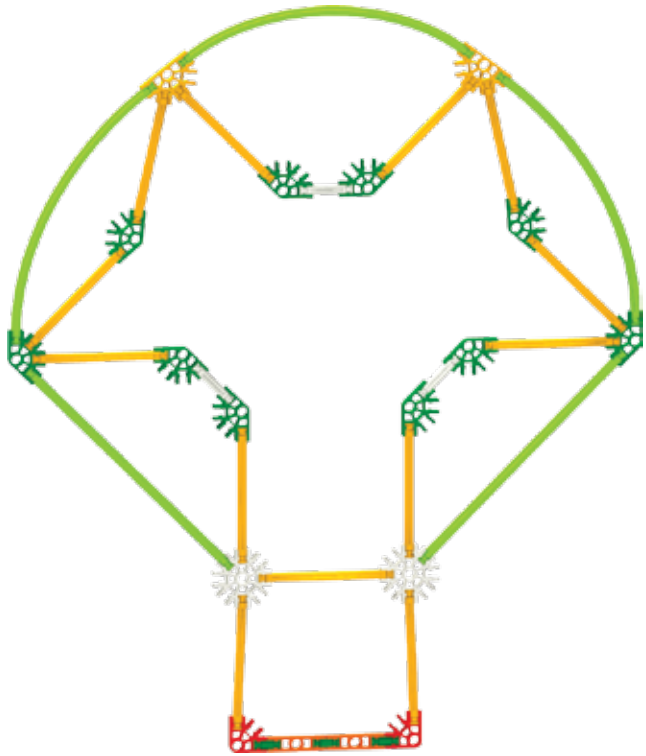

3		2		2	
3					
13					
5					
10		2		2	

Plane

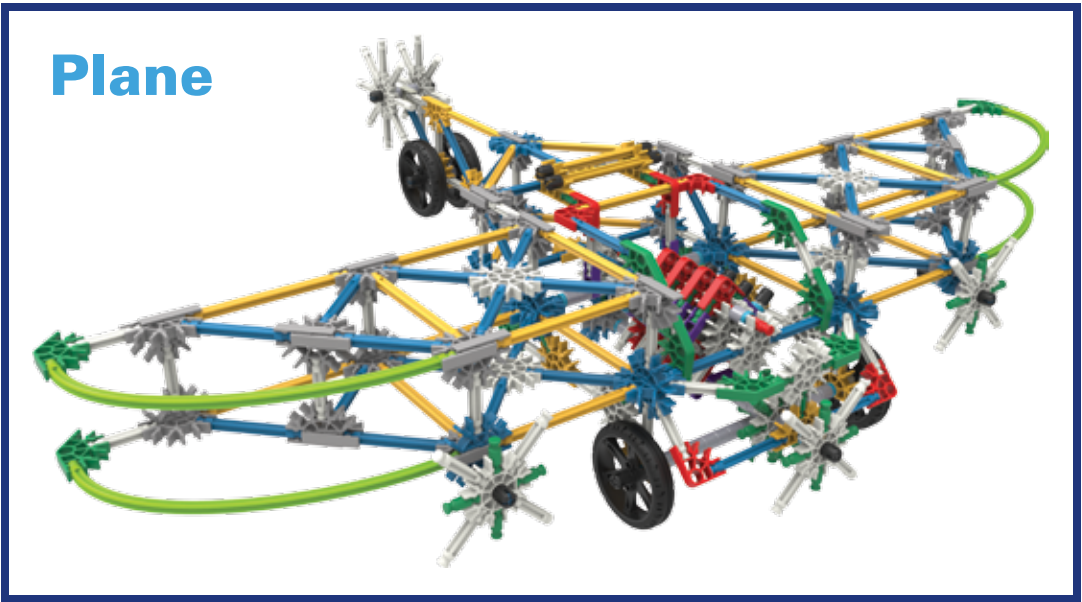

1

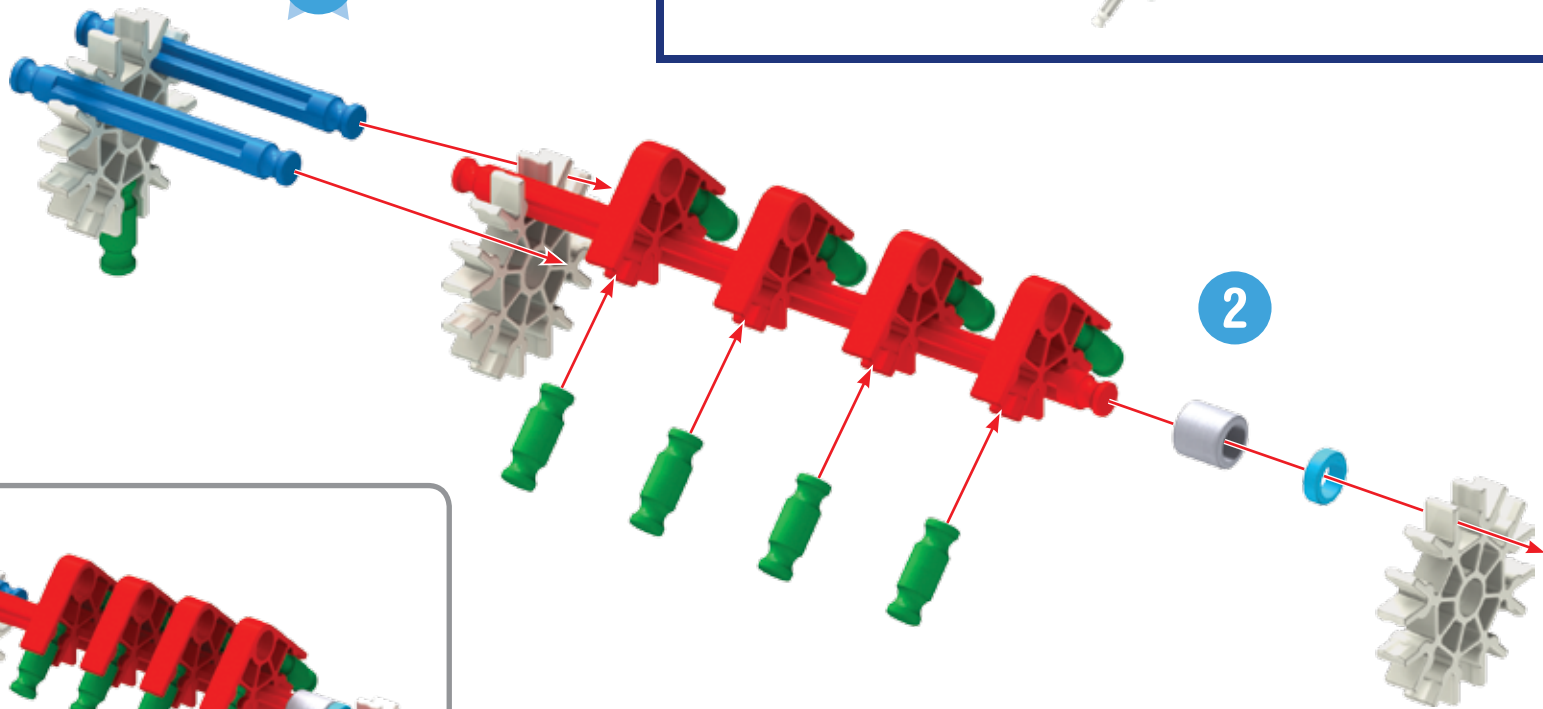

2

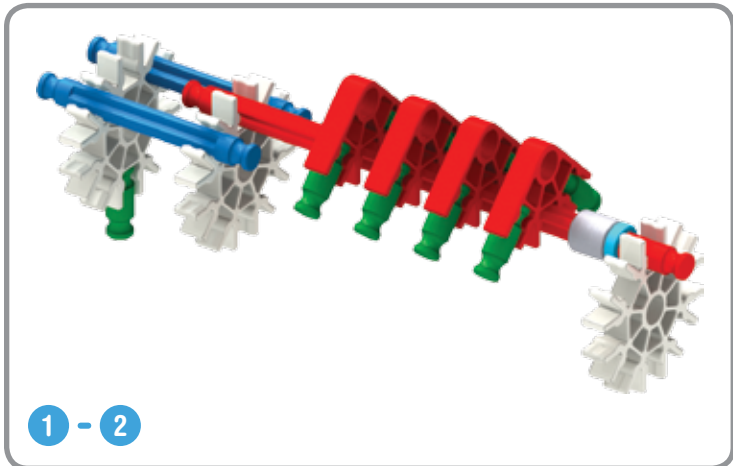

1	1	4	3
9			
2			
1			

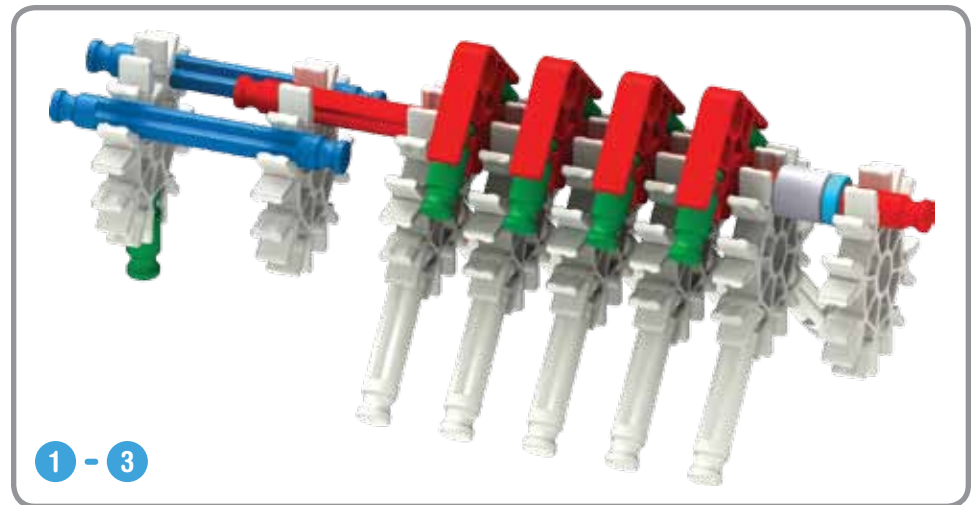
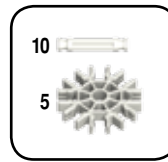
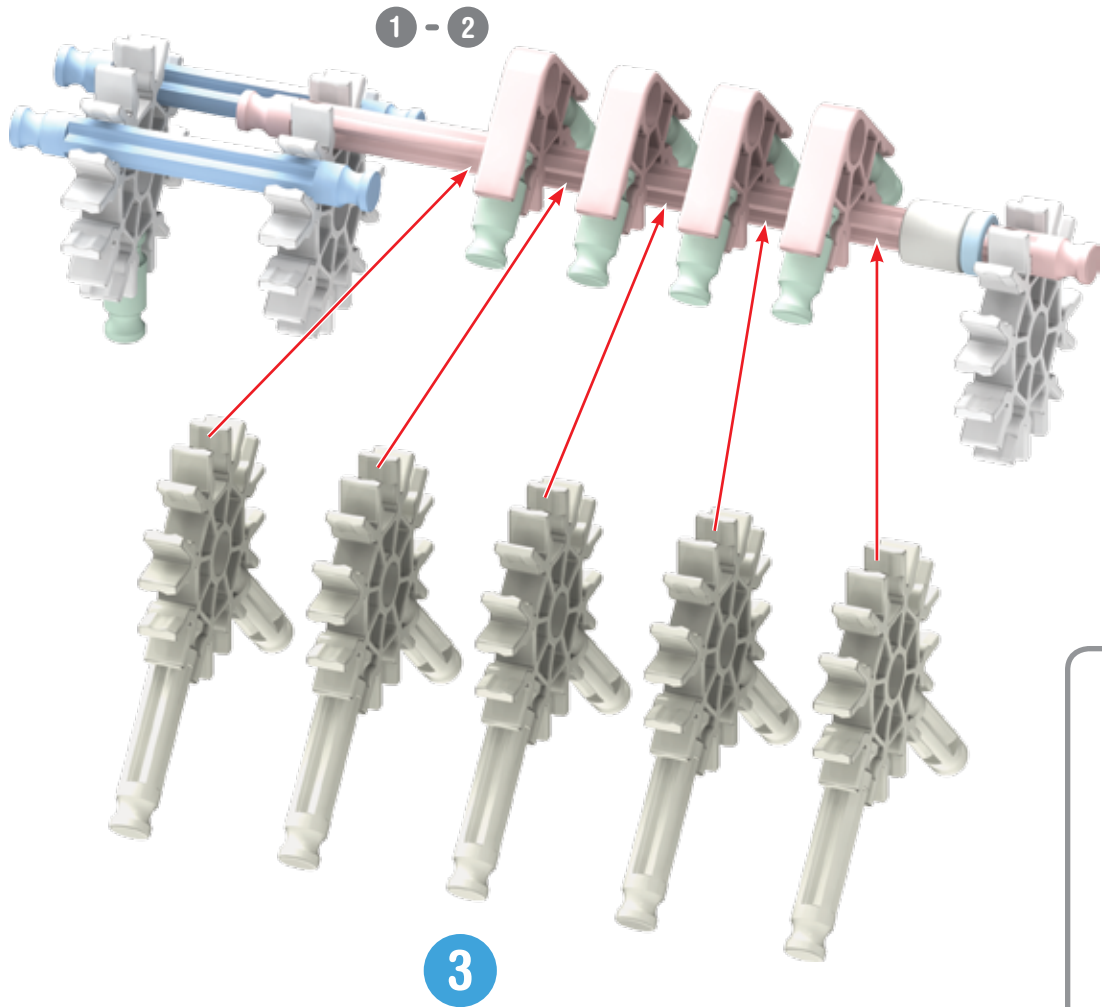

x8

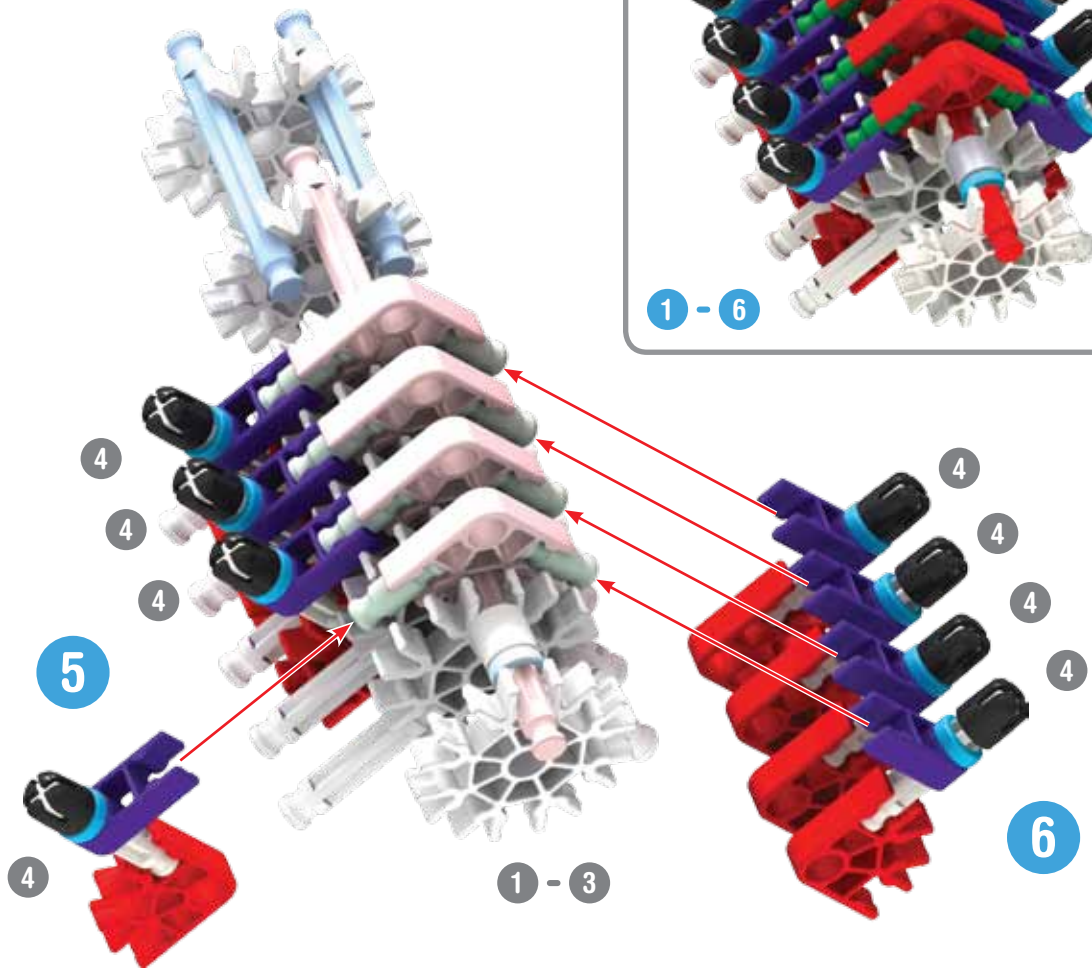
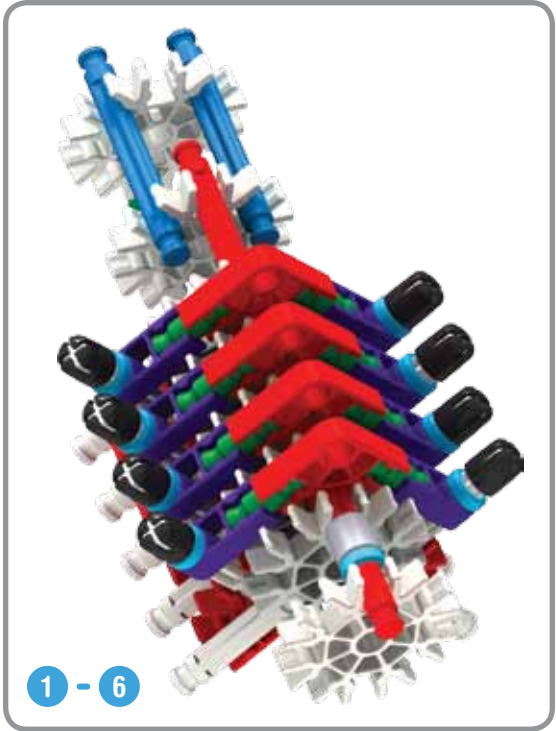
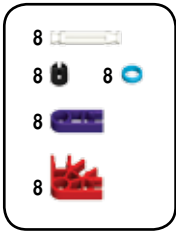
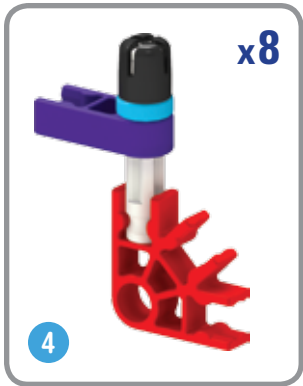
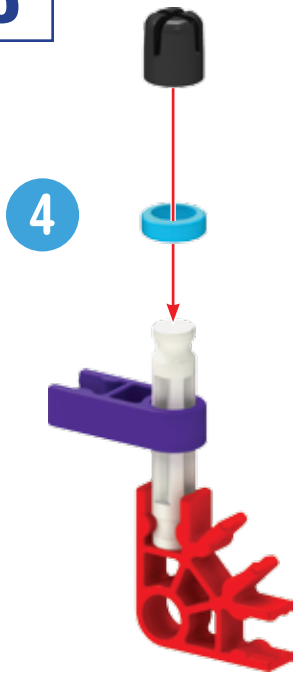

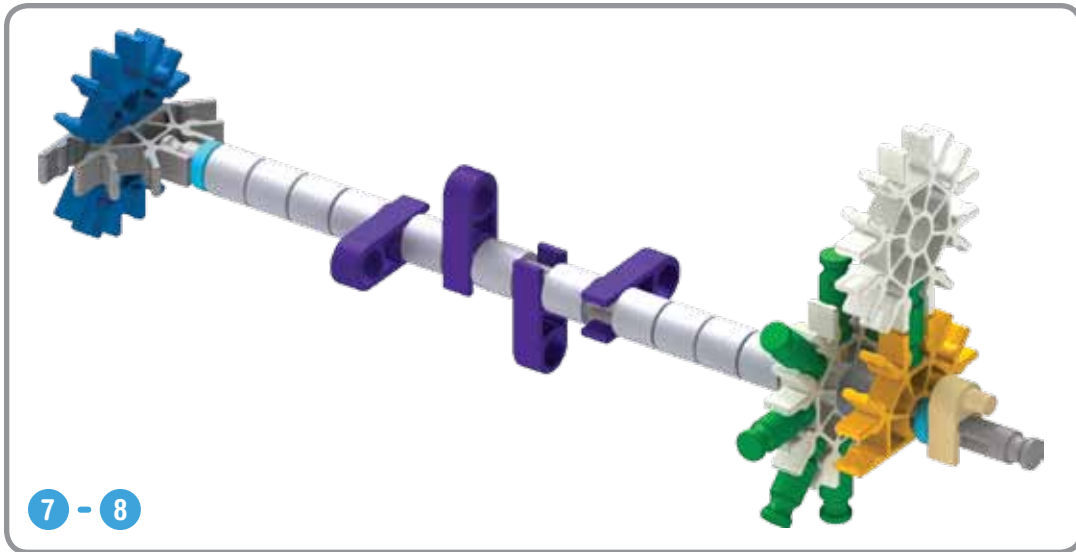
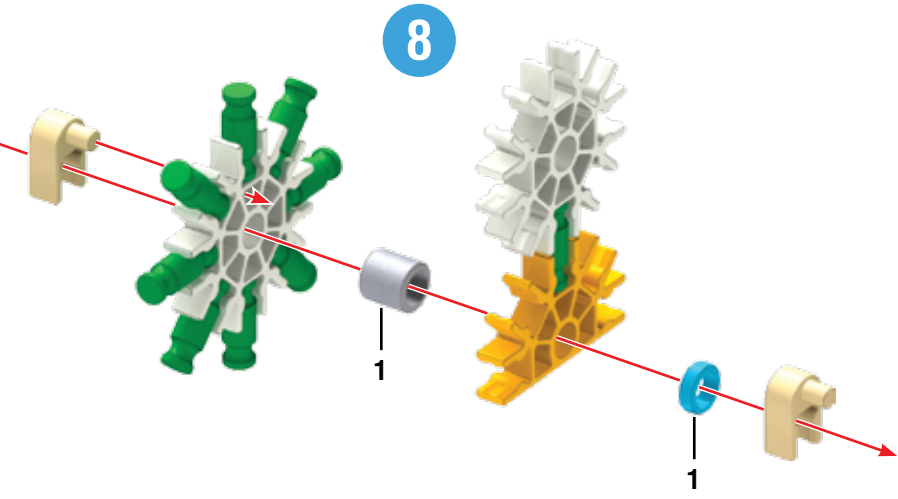
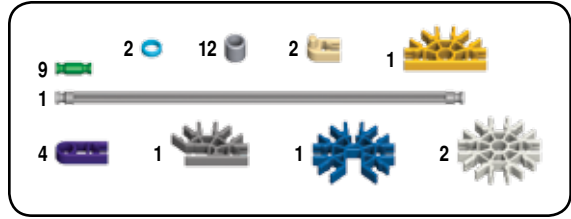
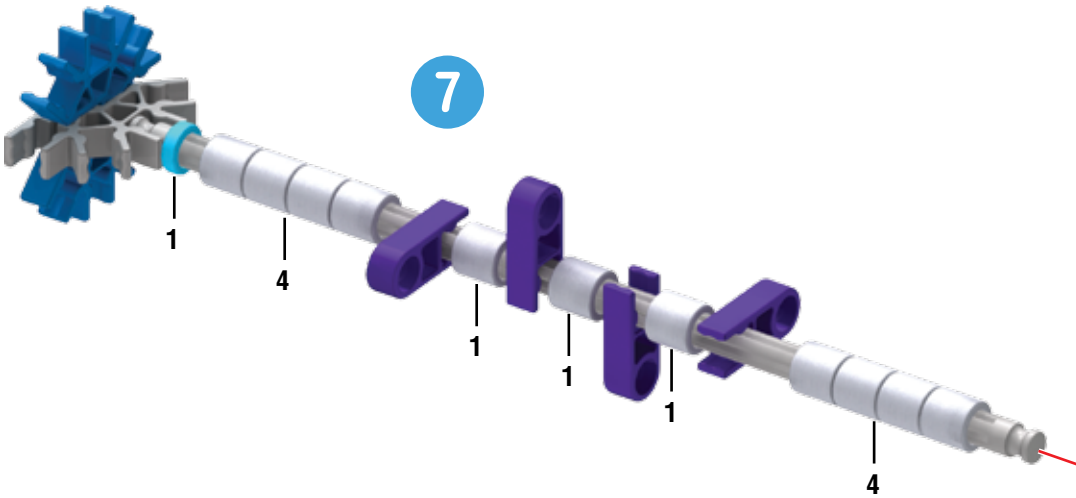

7 - 8

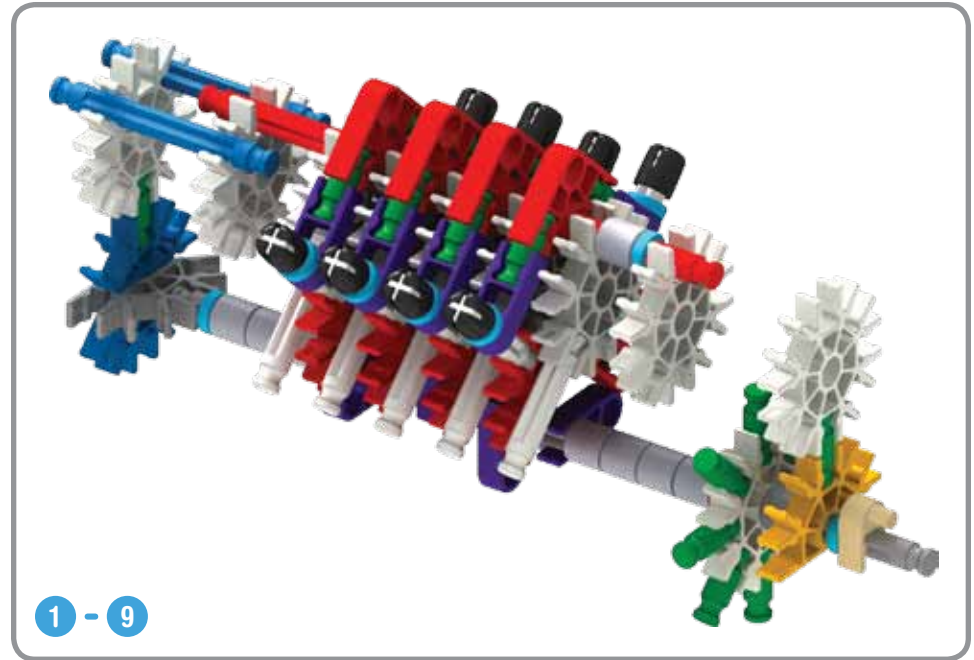
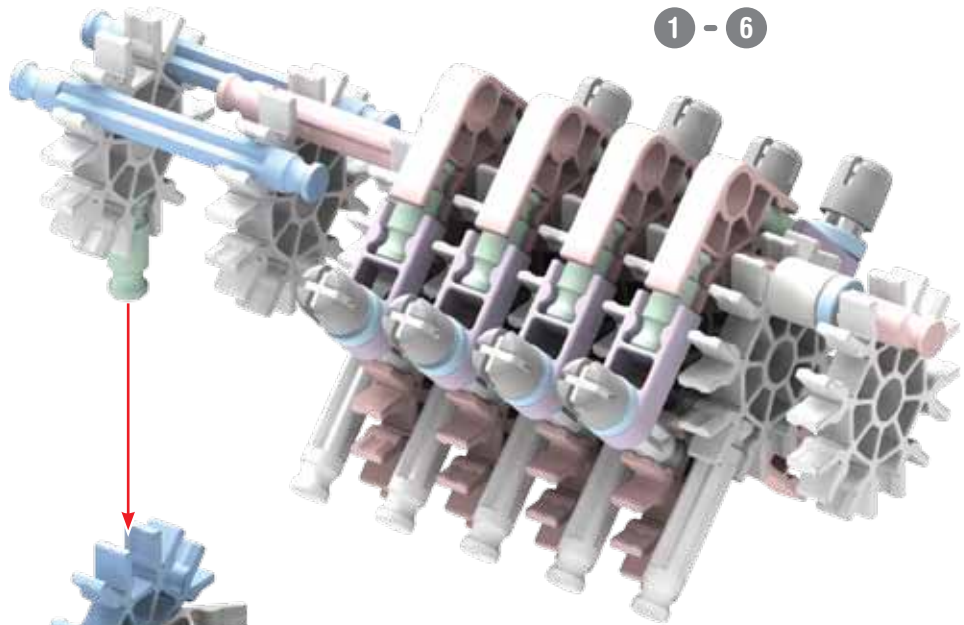

9

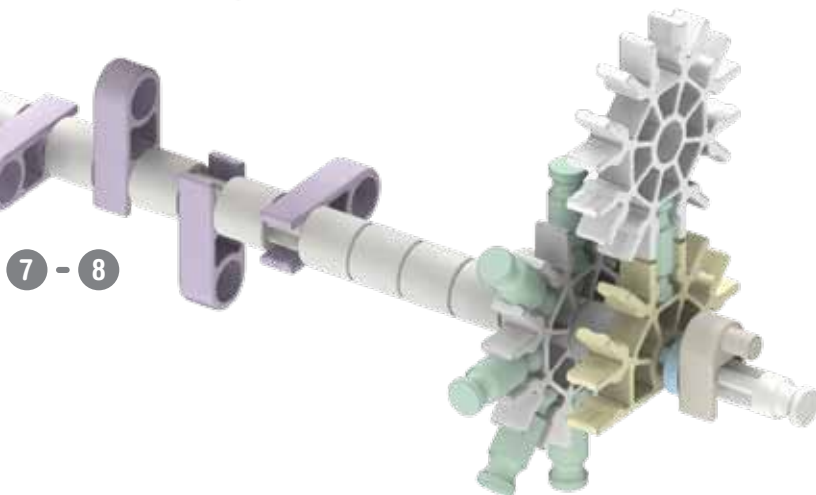

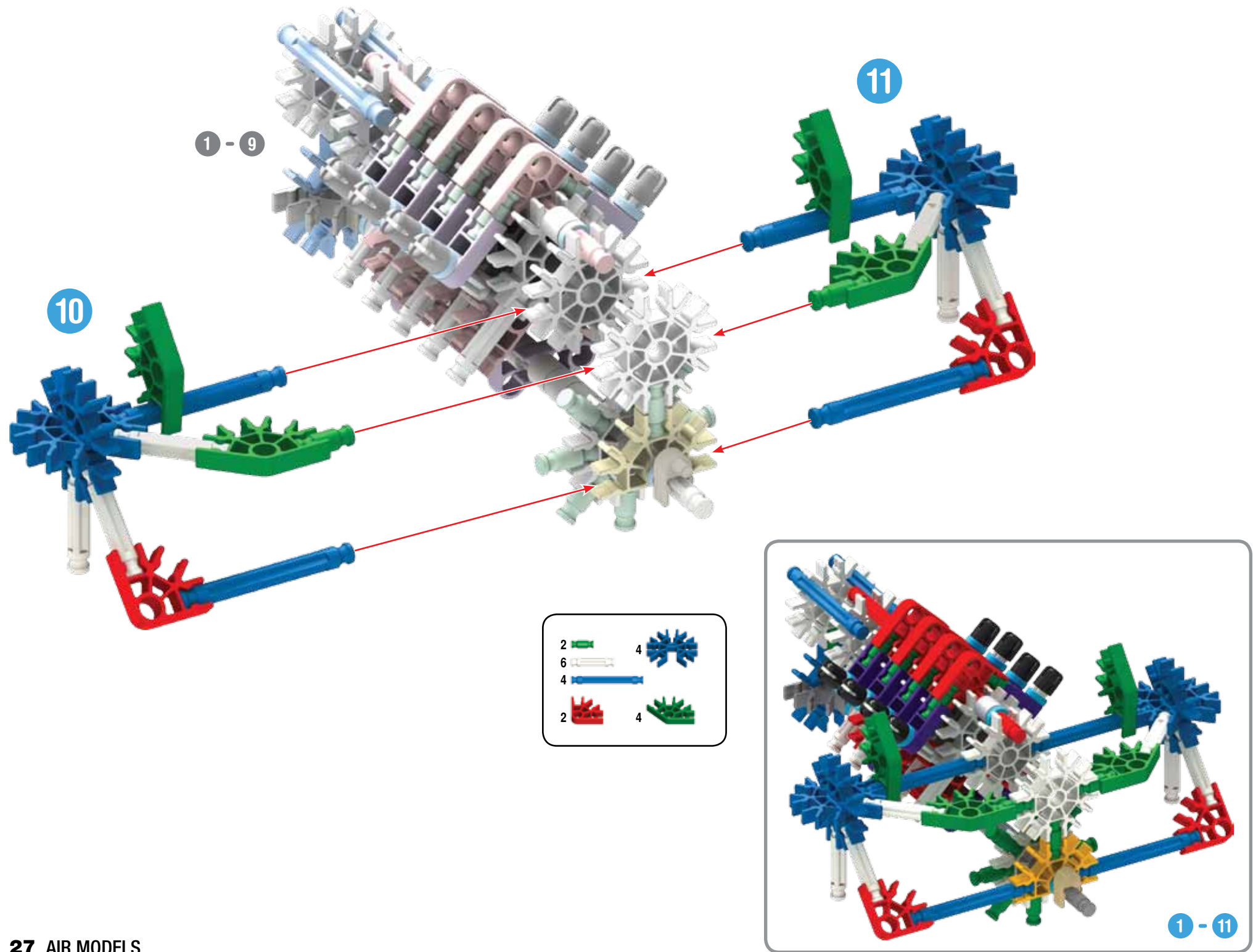

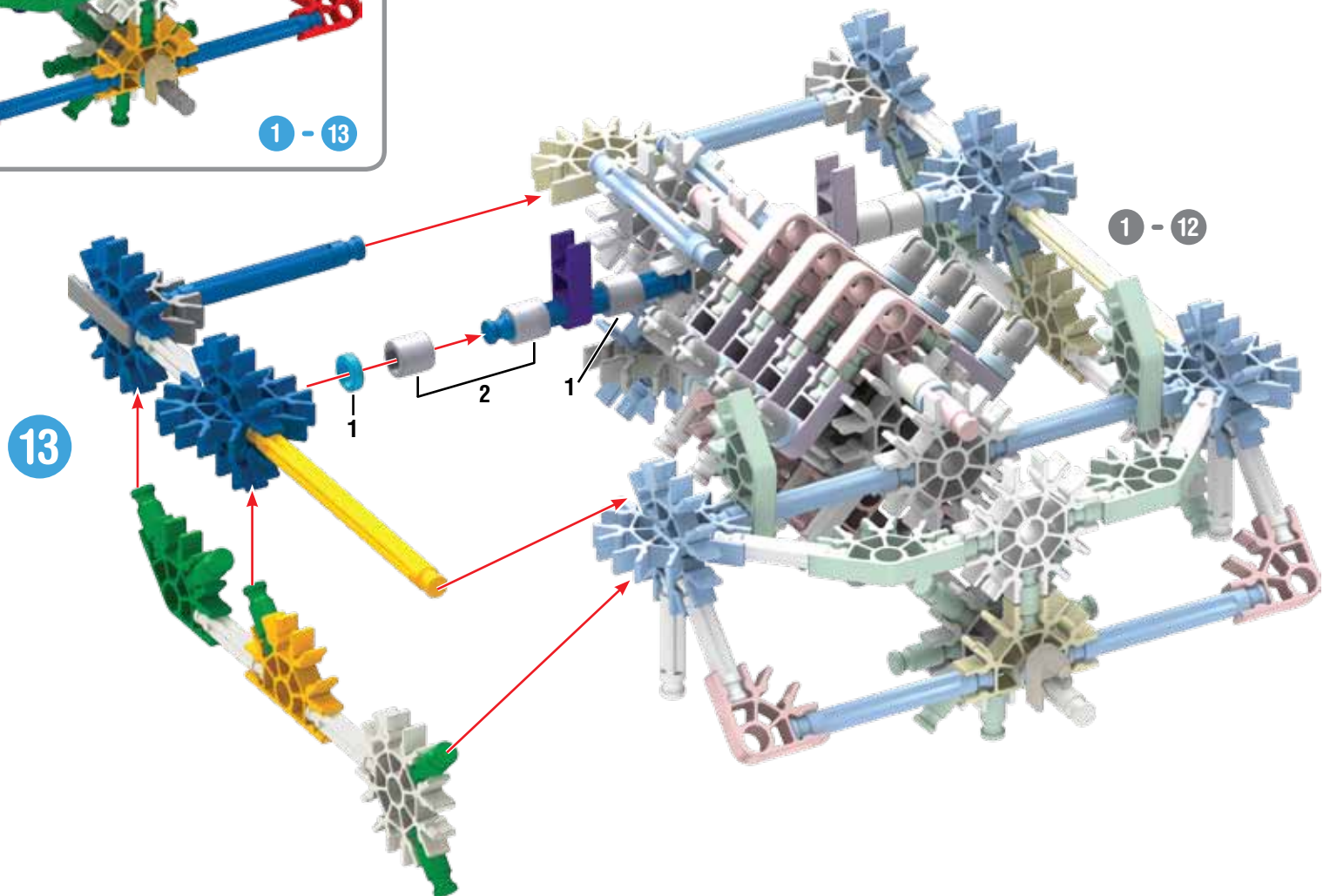
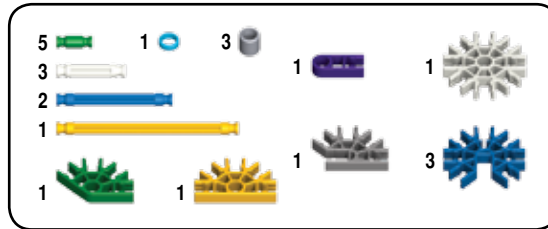
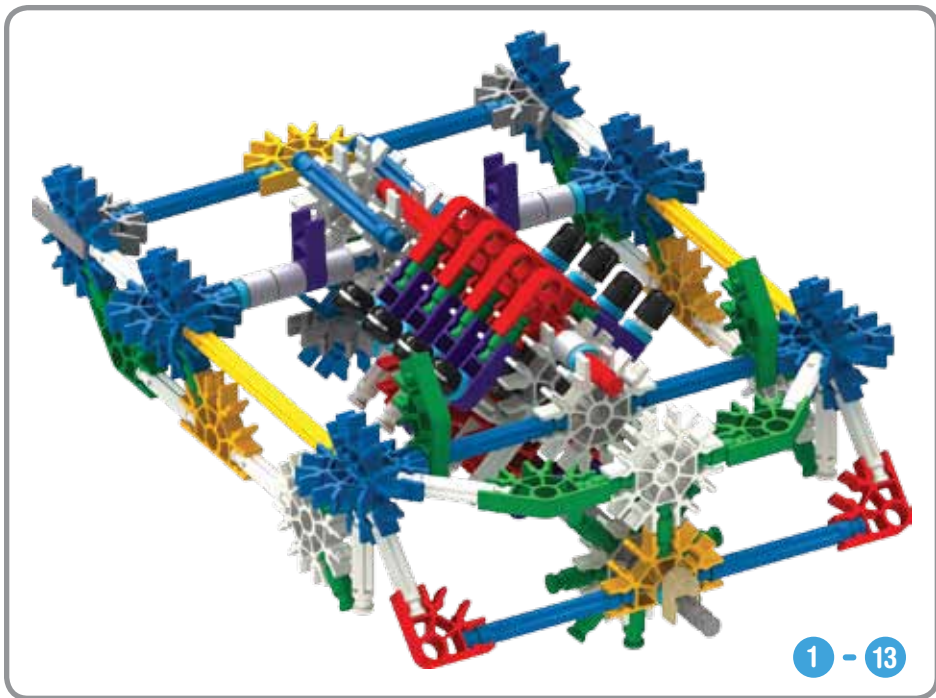

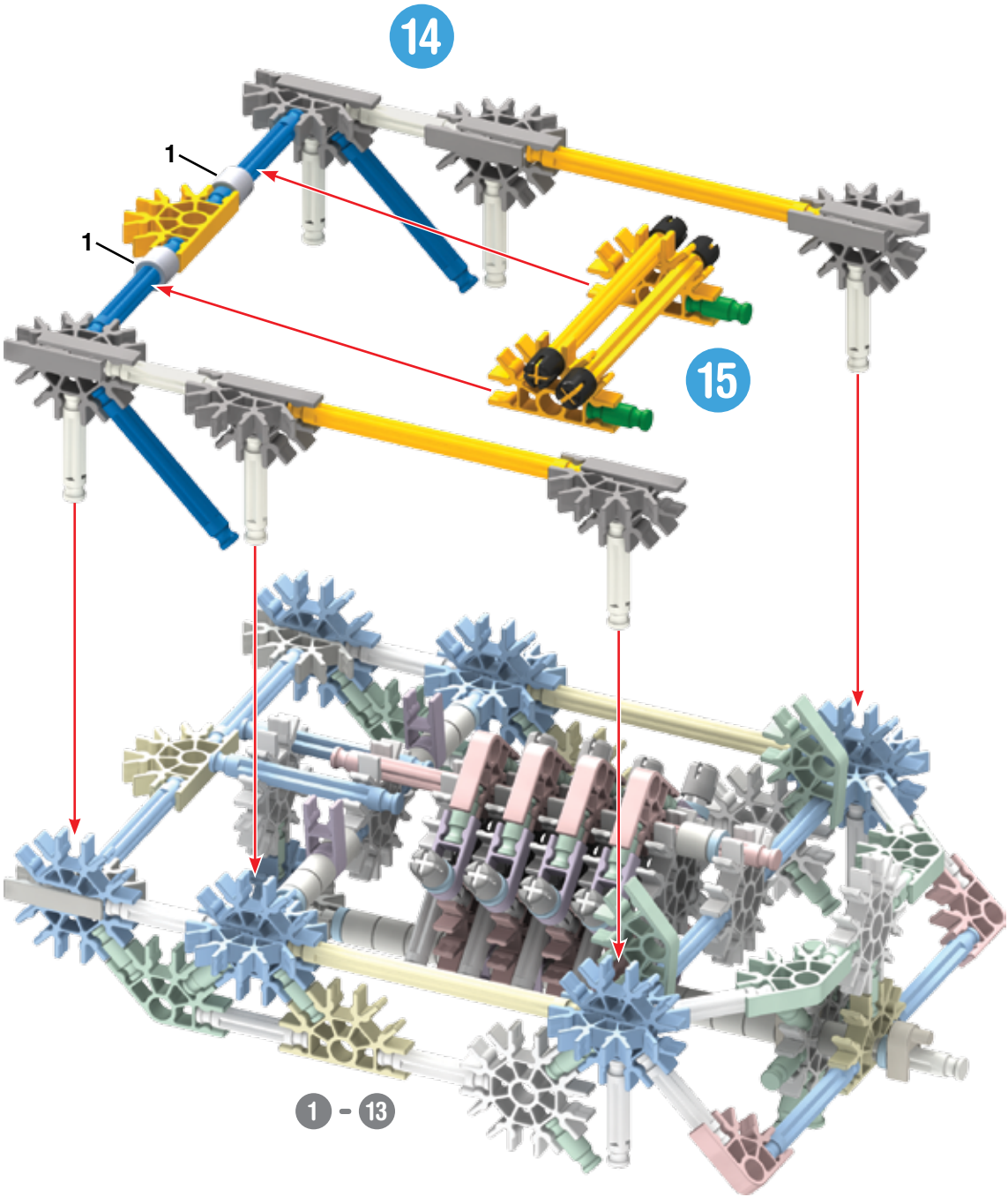

2		4		3	
6		2			
4				12	
4					

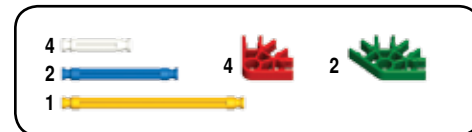
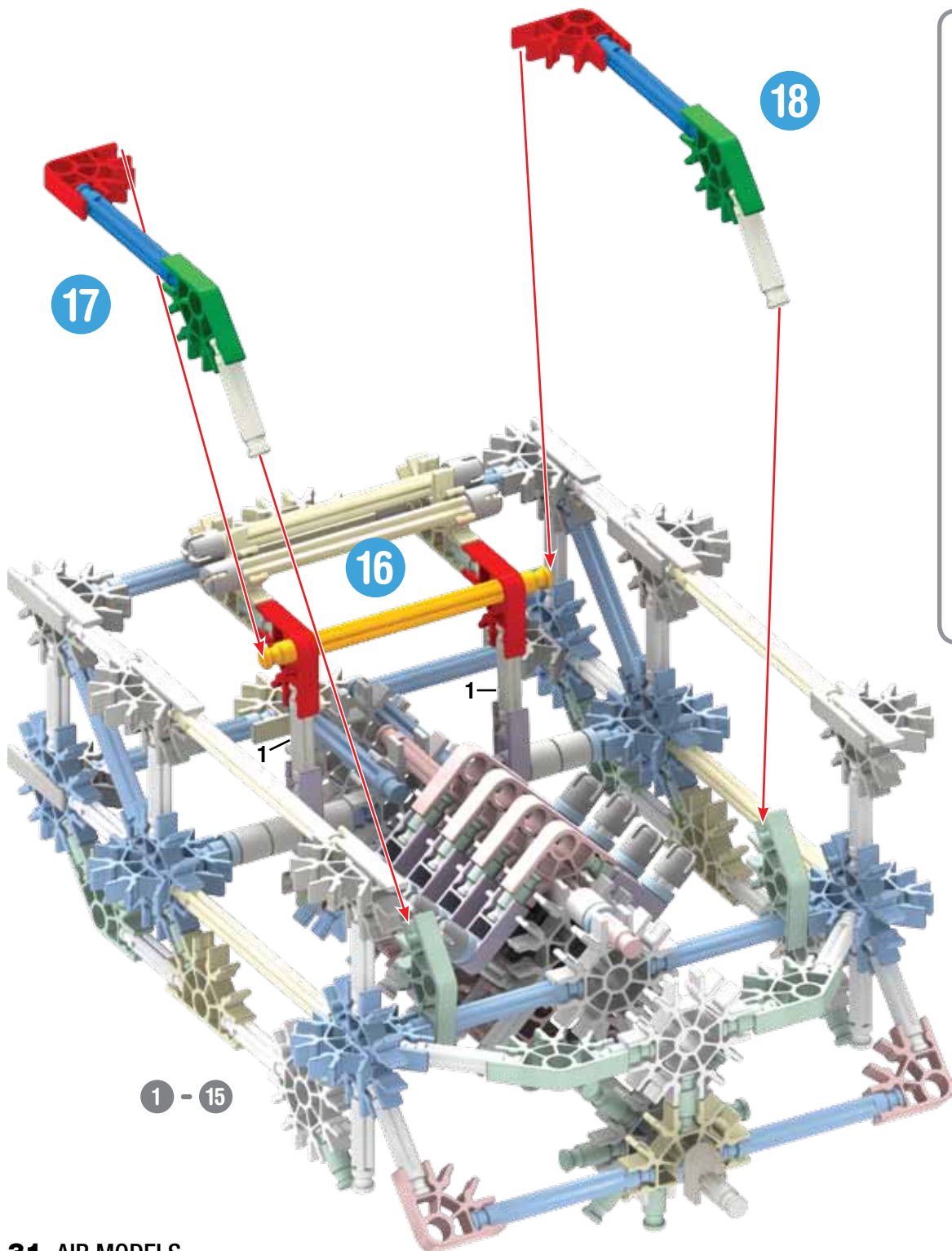

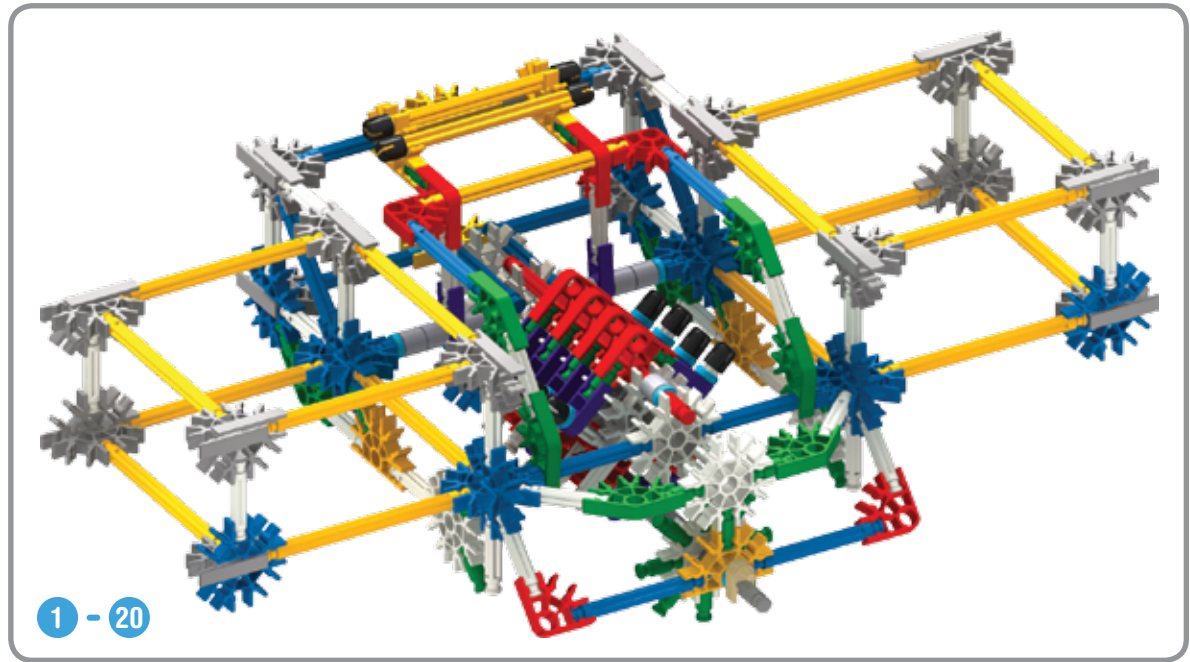
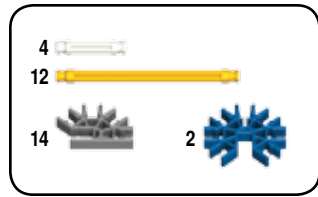
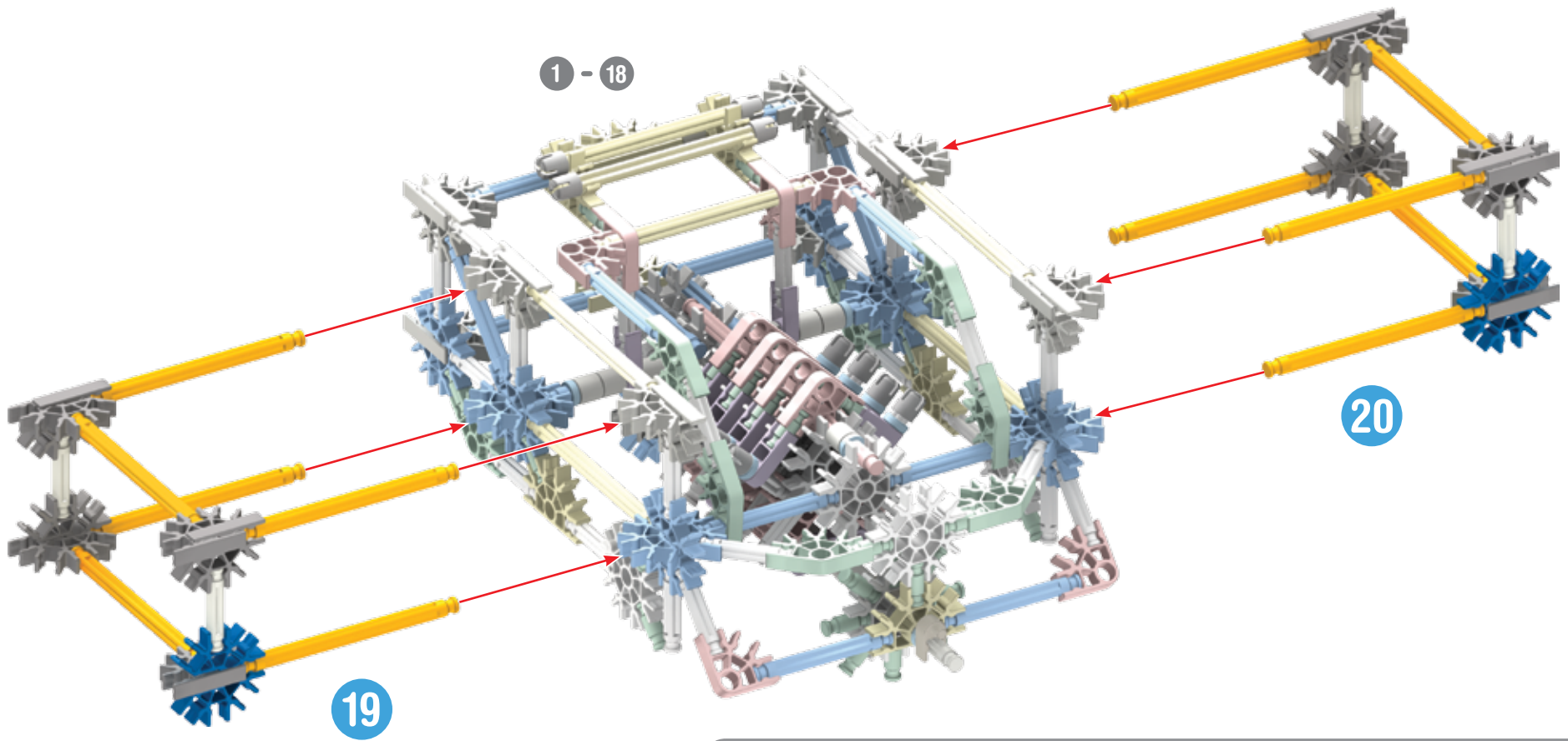

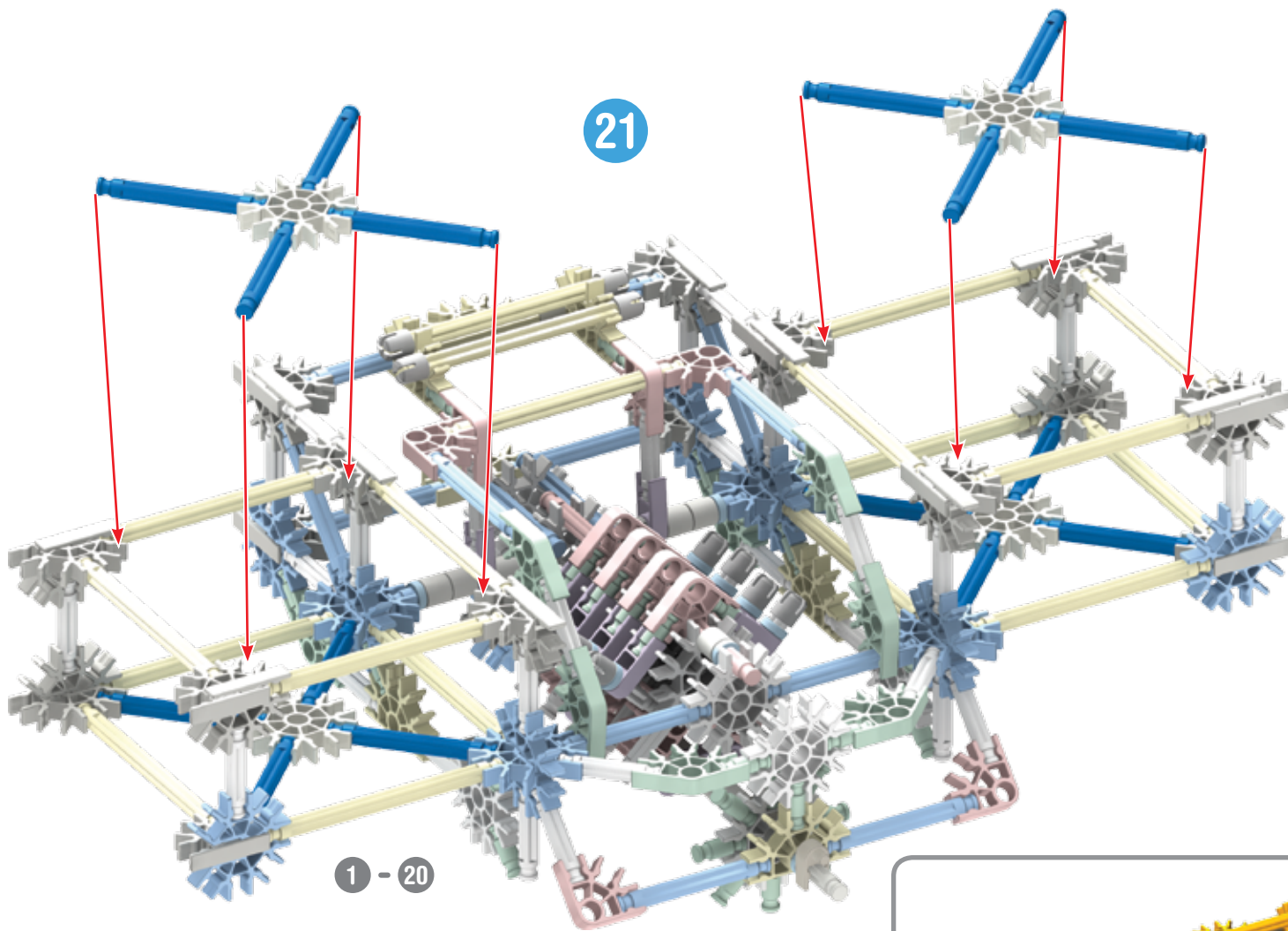

1 - 20

16	
4	

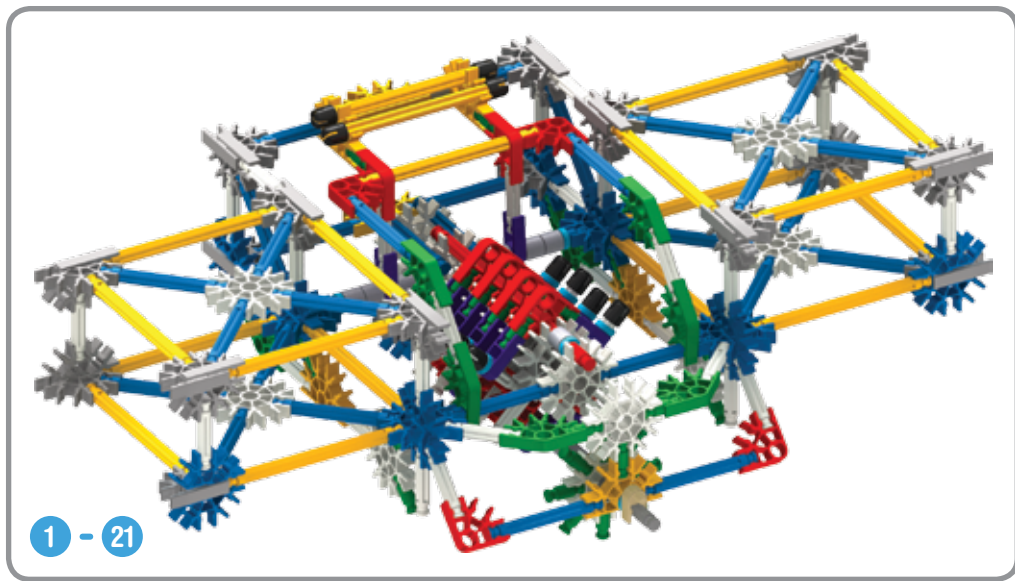

1 - 21

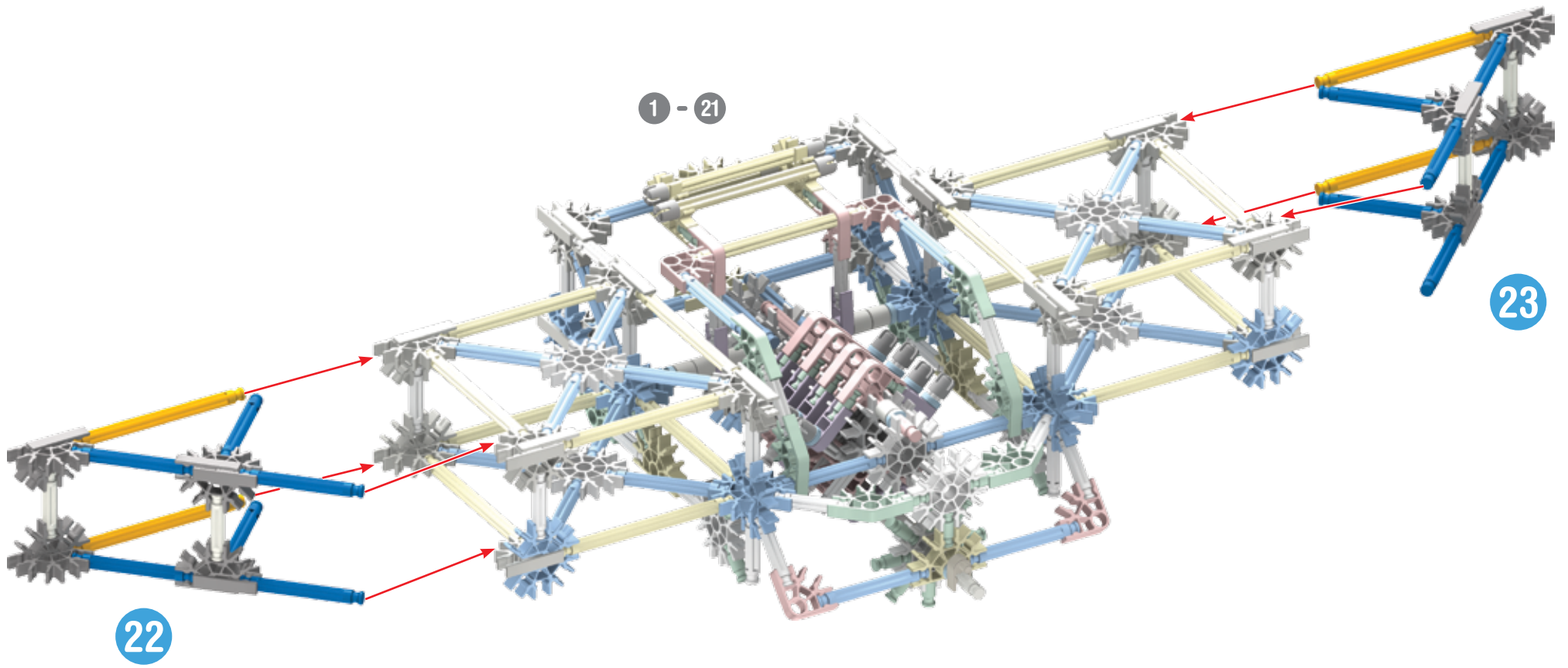

23

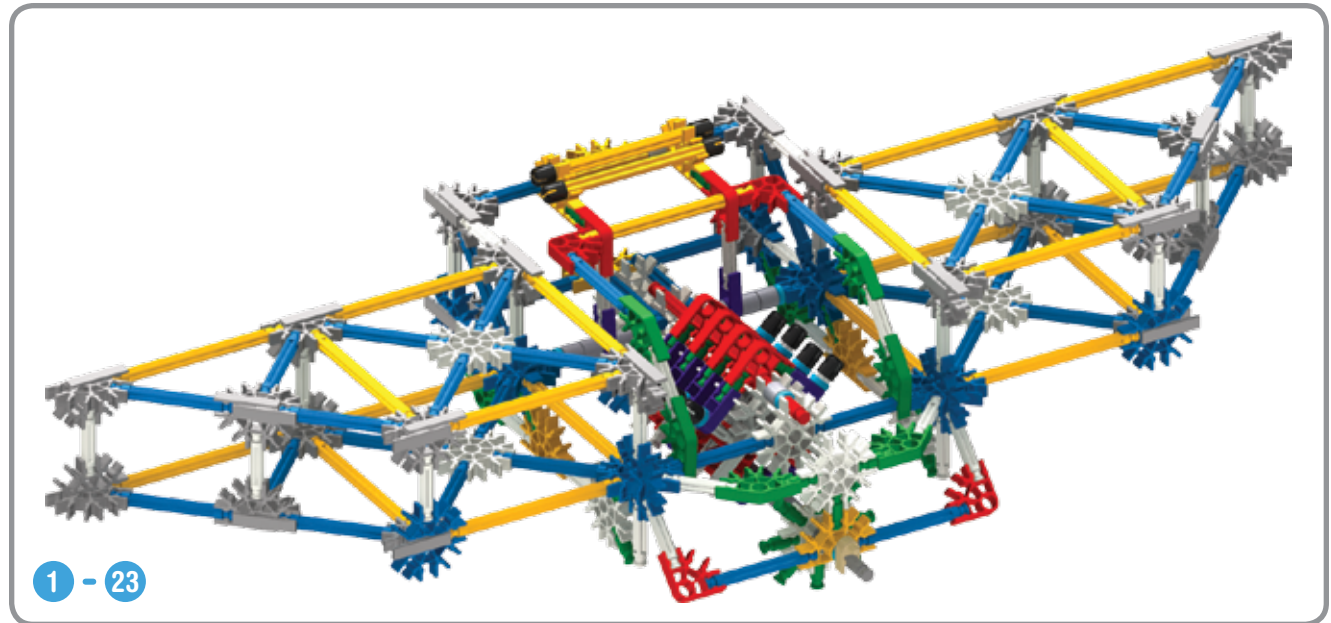
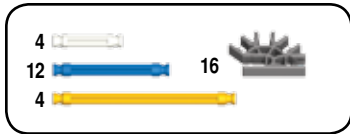

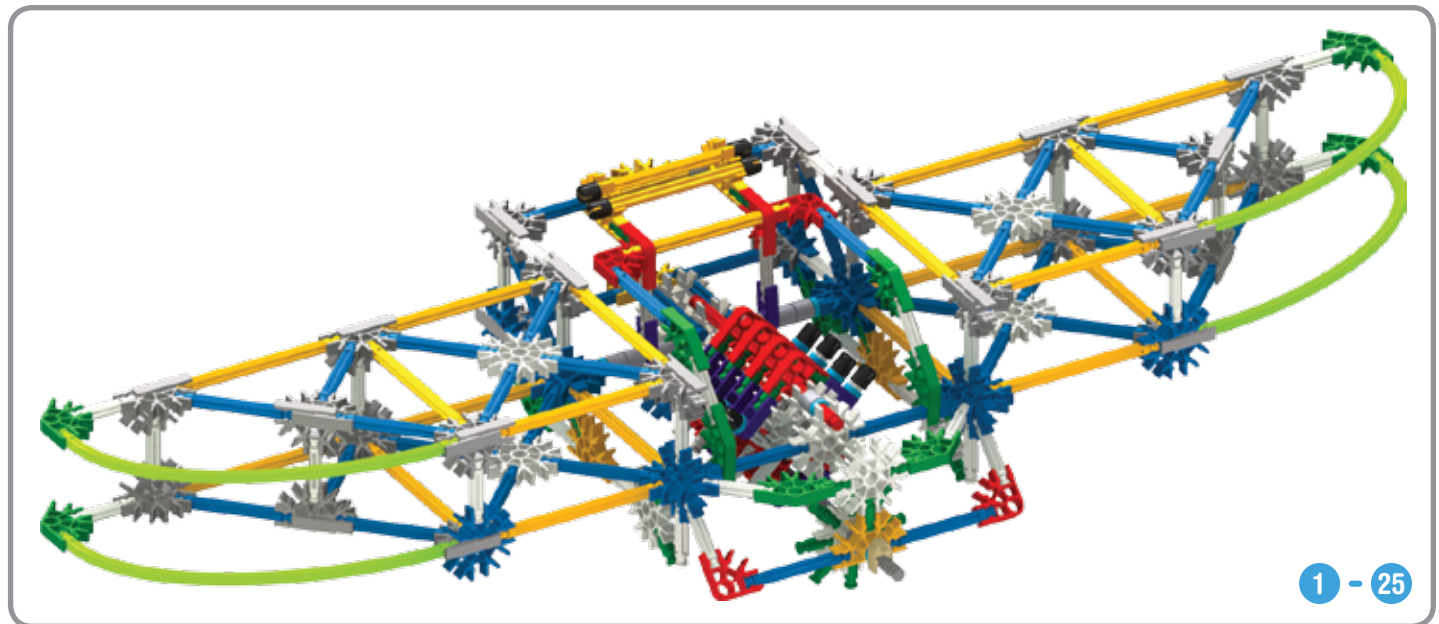
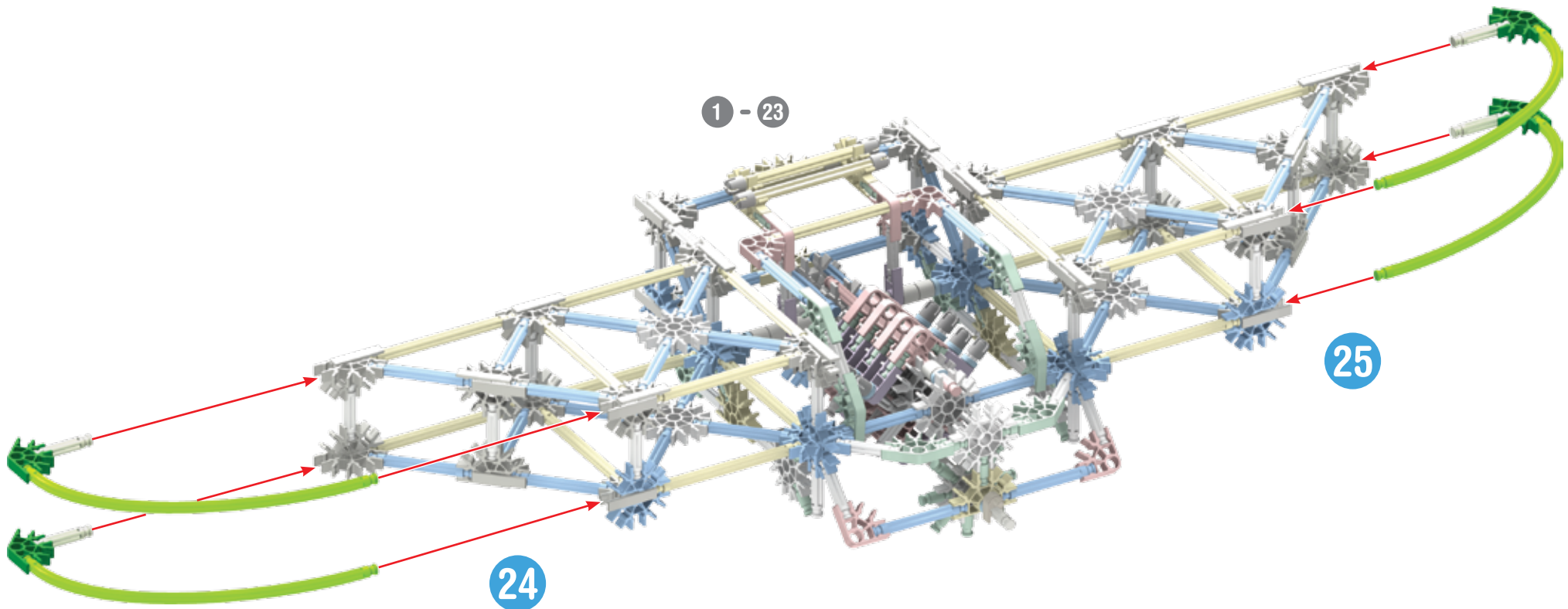

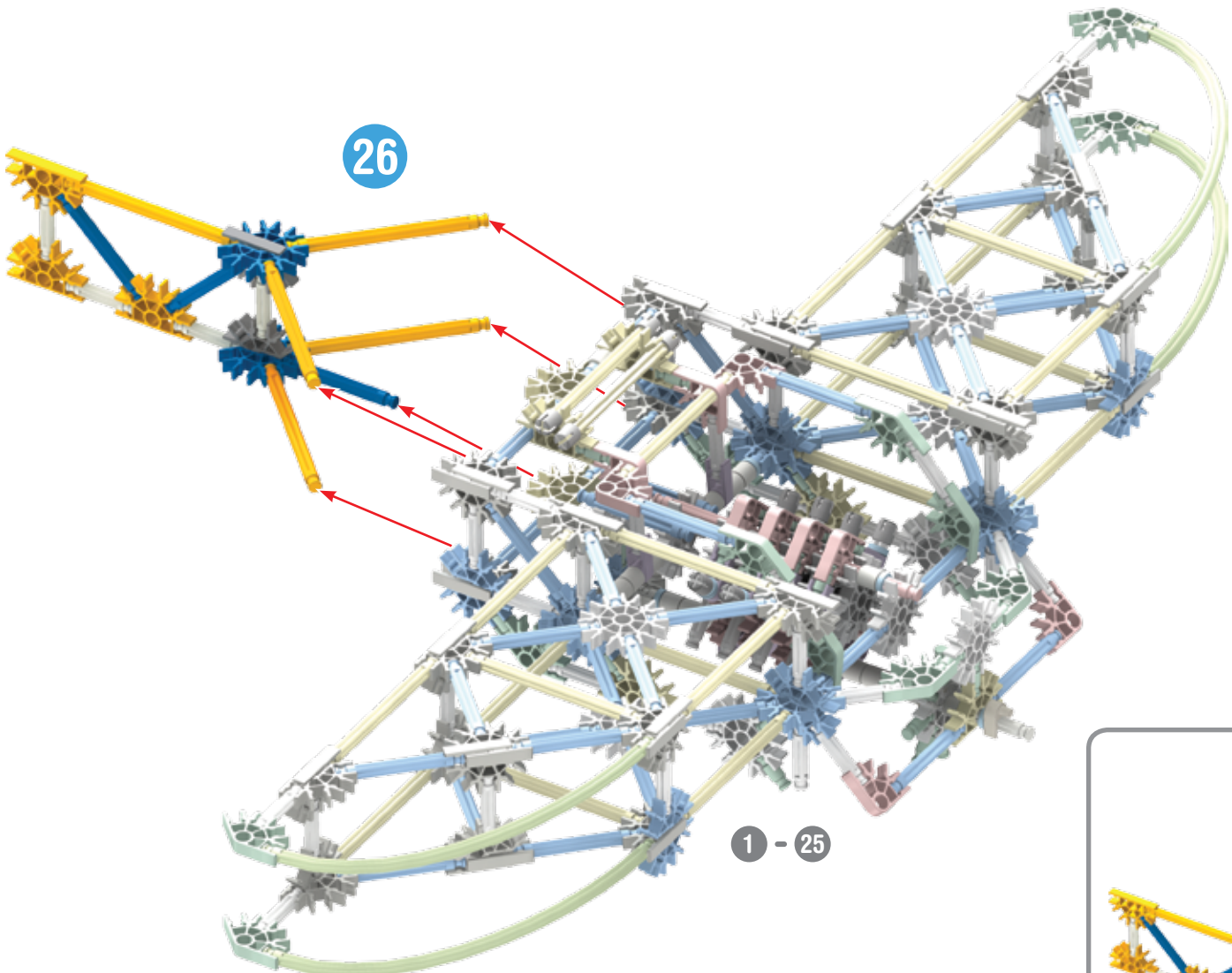

26

1 - 25

4		3	
3			
5			
2		2	

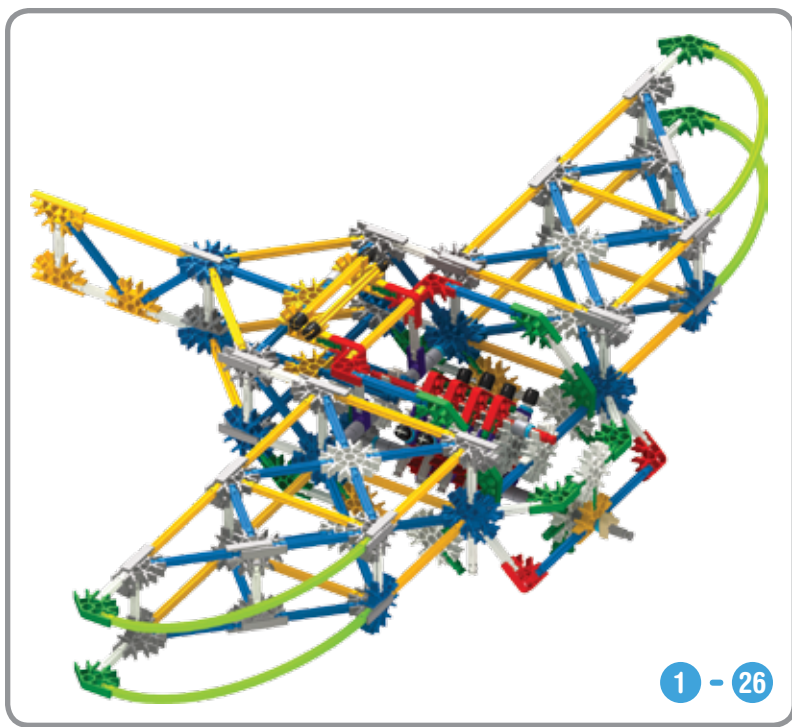

1 - 26

2		2	
17		1	
2		2	

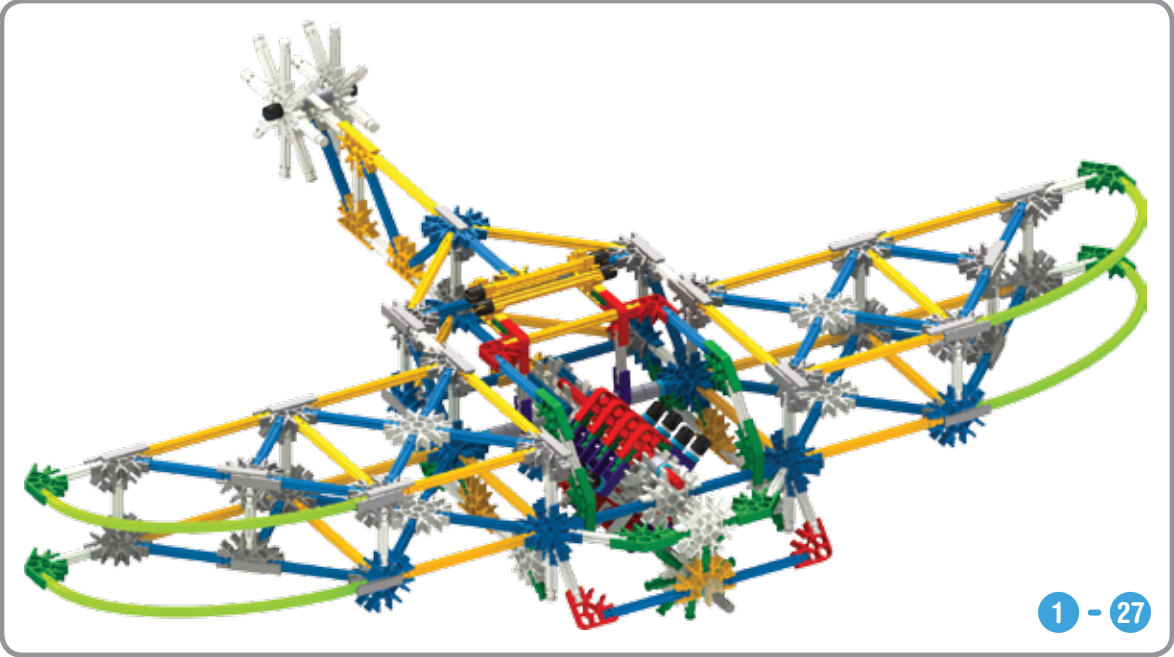

27

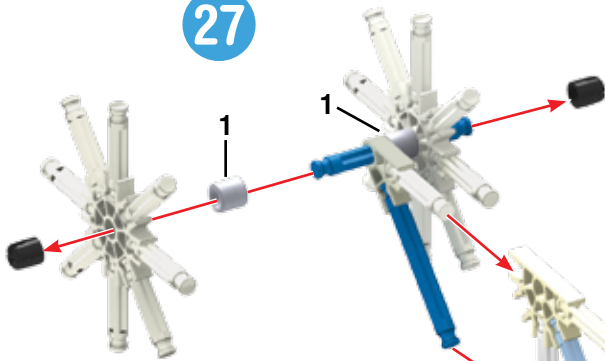

1 - 26

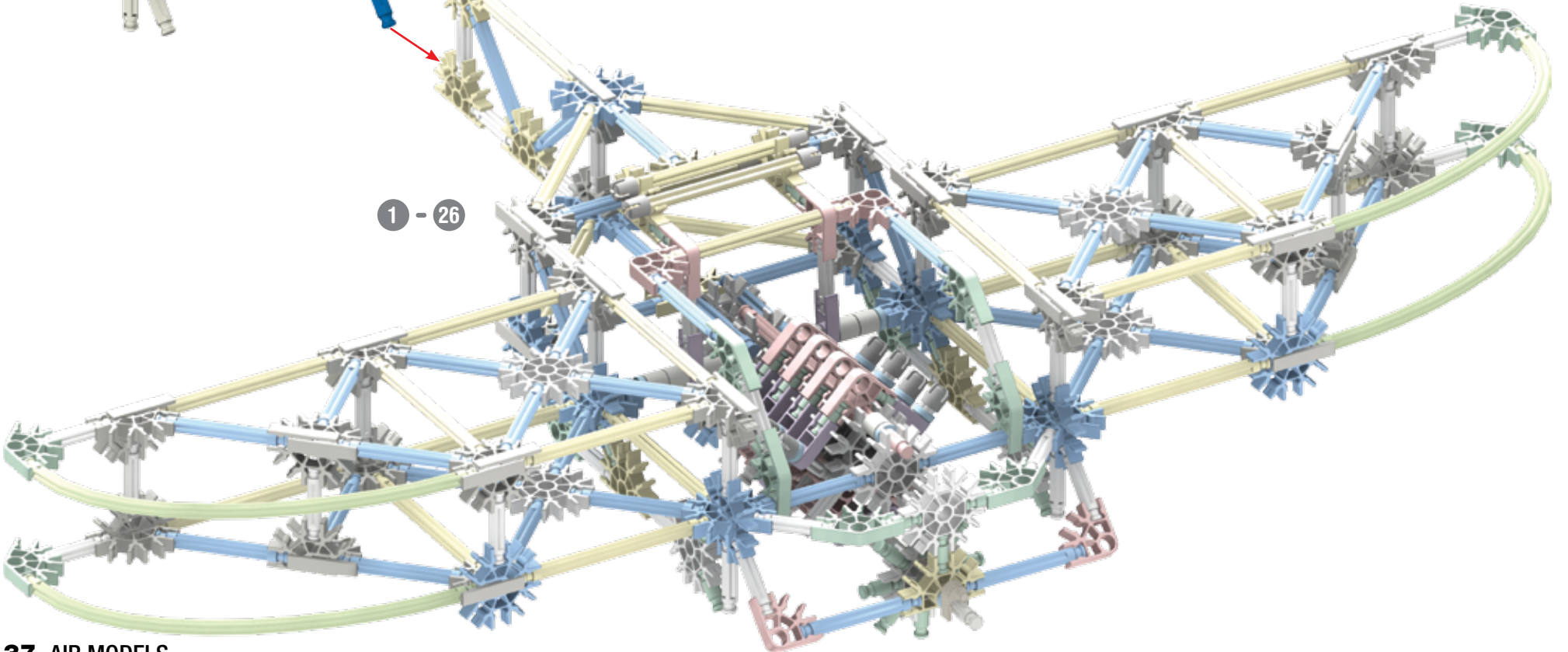

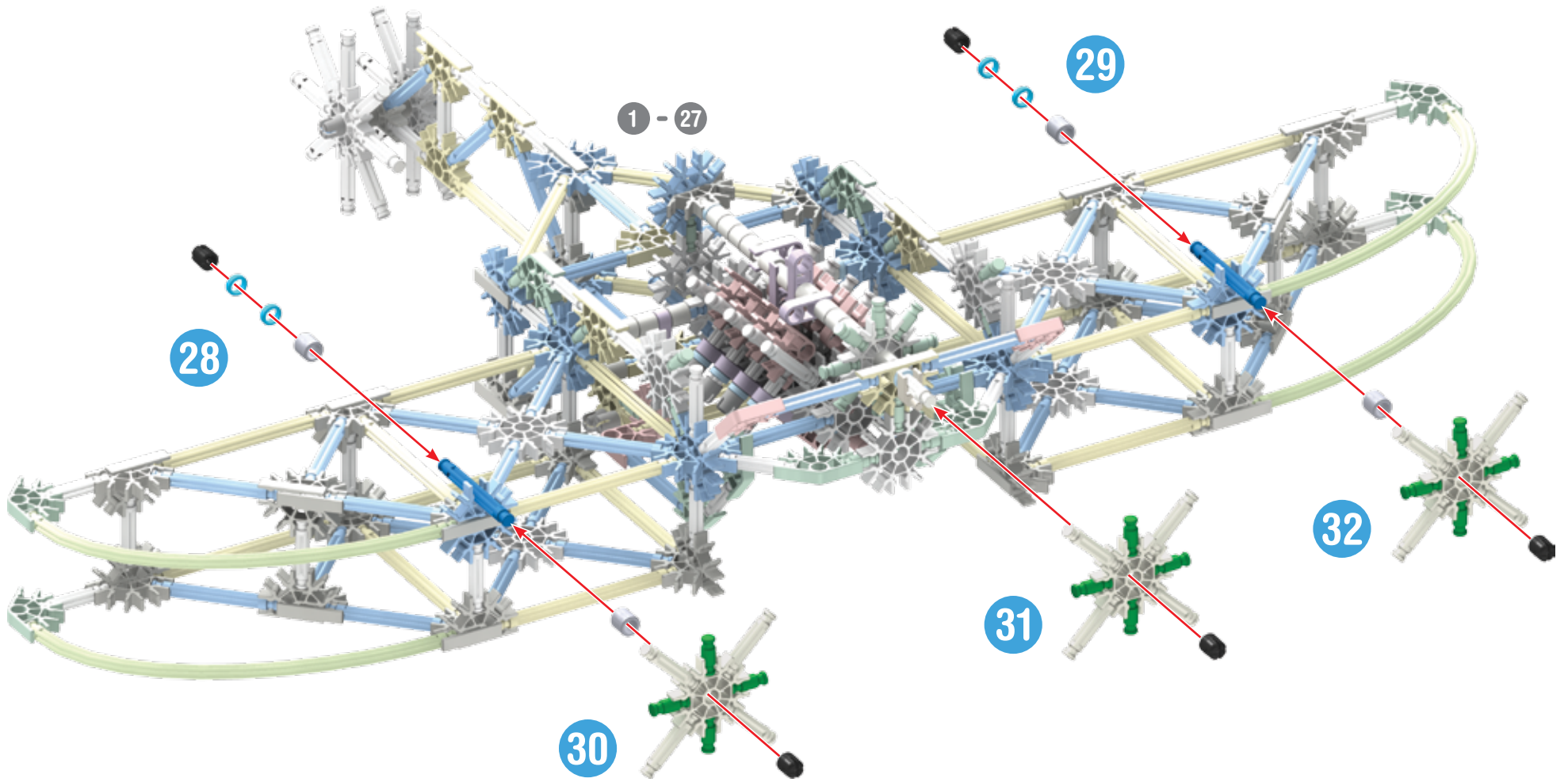

- | | | | |
|----|--|---|--|
| 12 | | 3 | |
| 12 | | | |
| 2 | | | |
| 5 | | 4 | |
| | | 4 | |

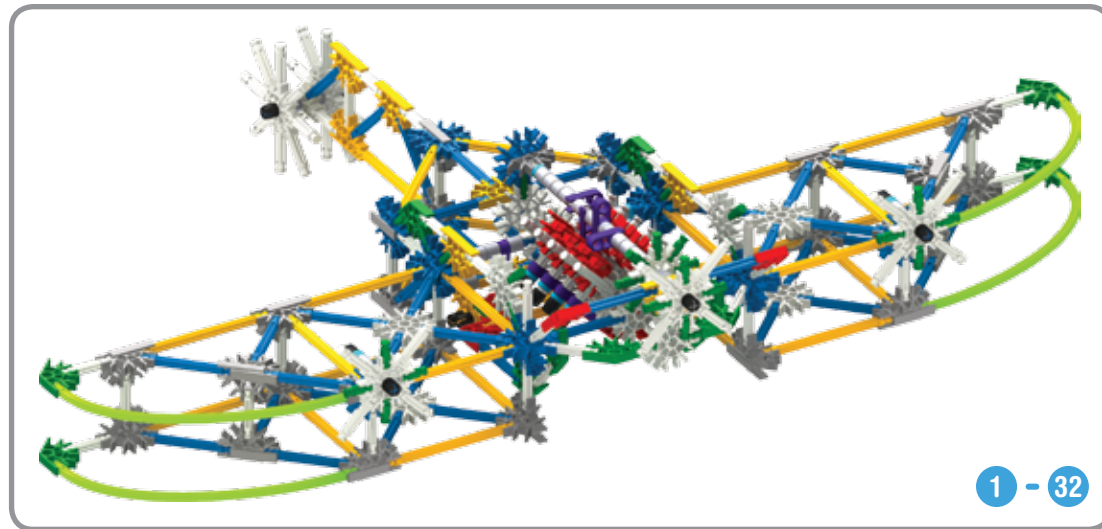

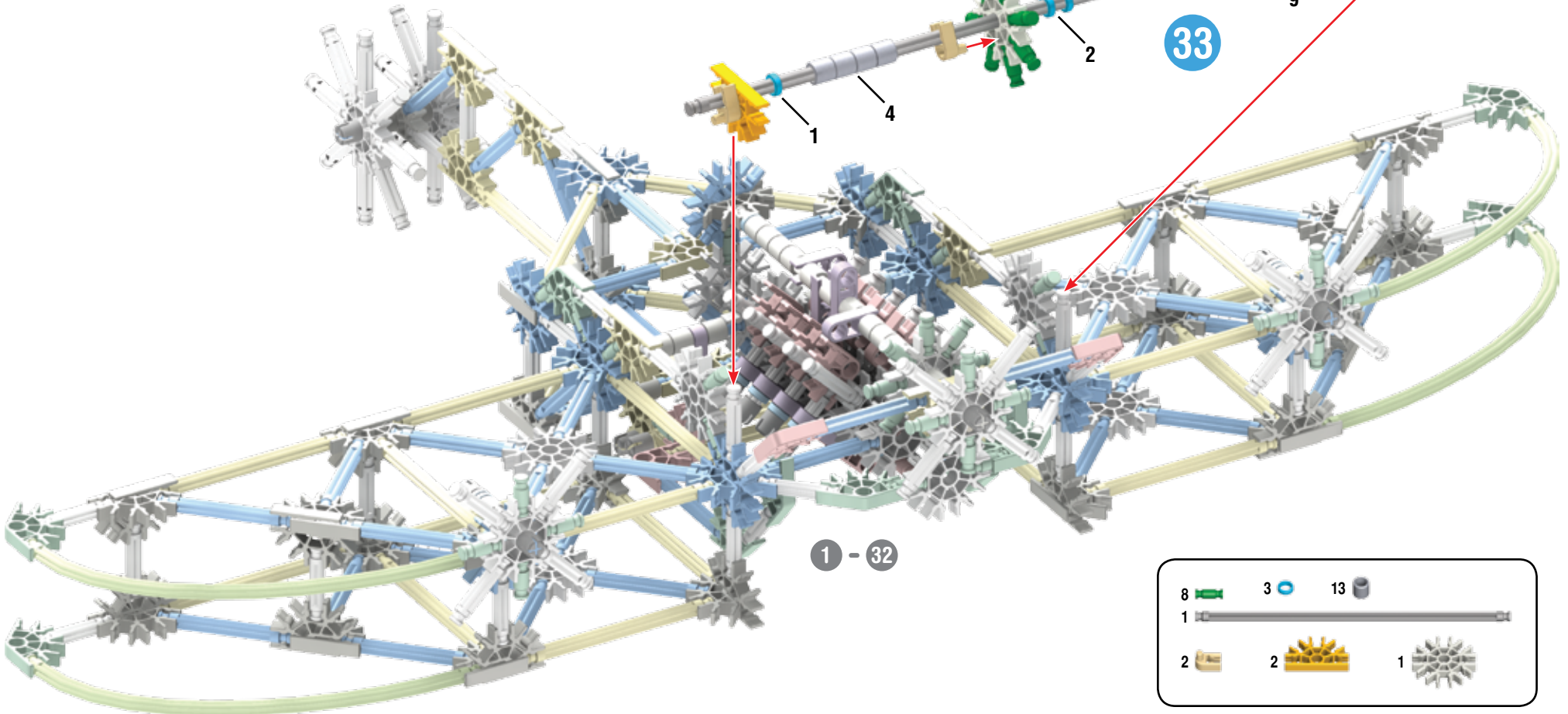
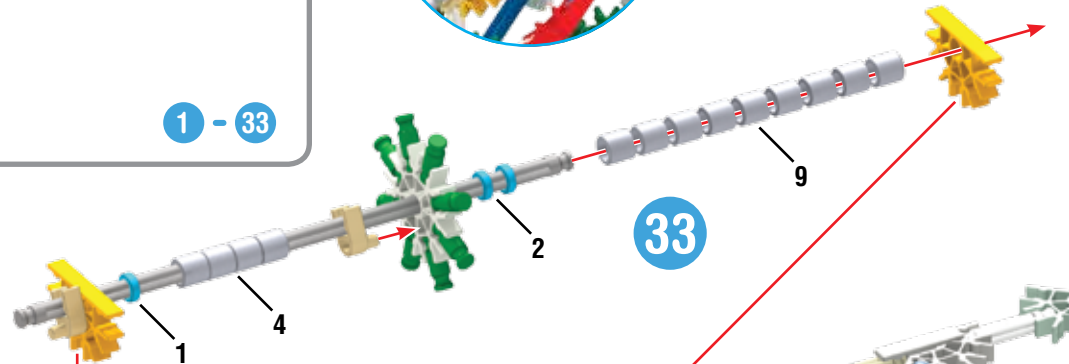
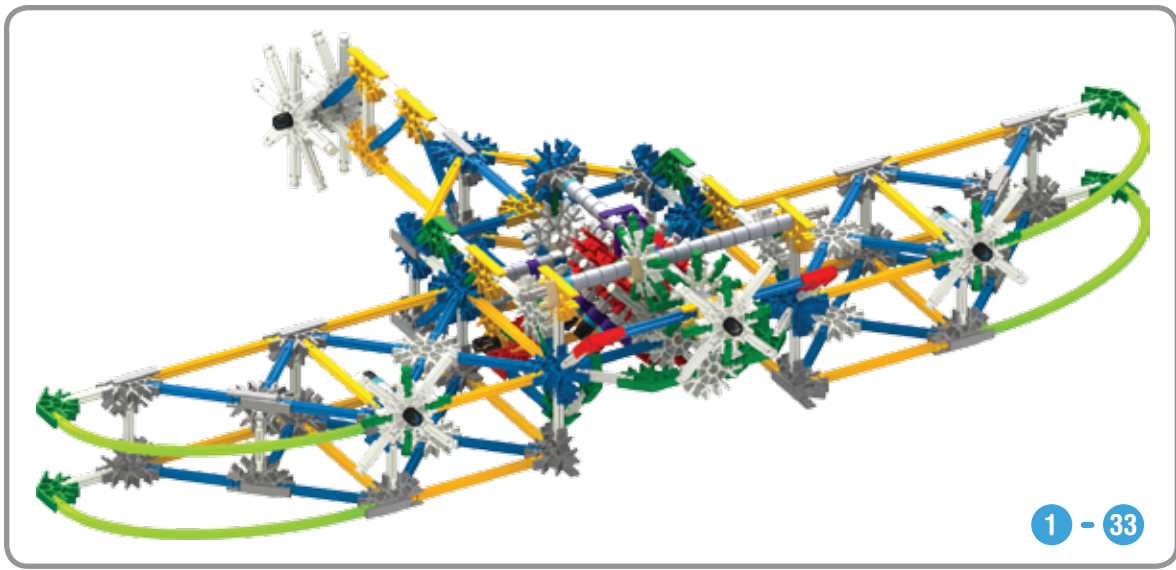

8		3		13	
1					
2		2		1	

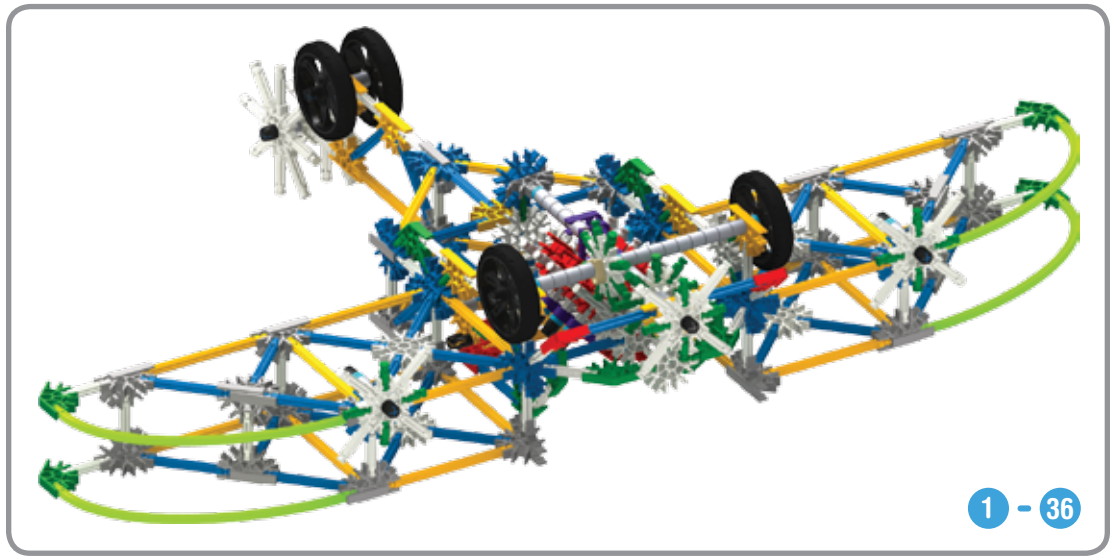
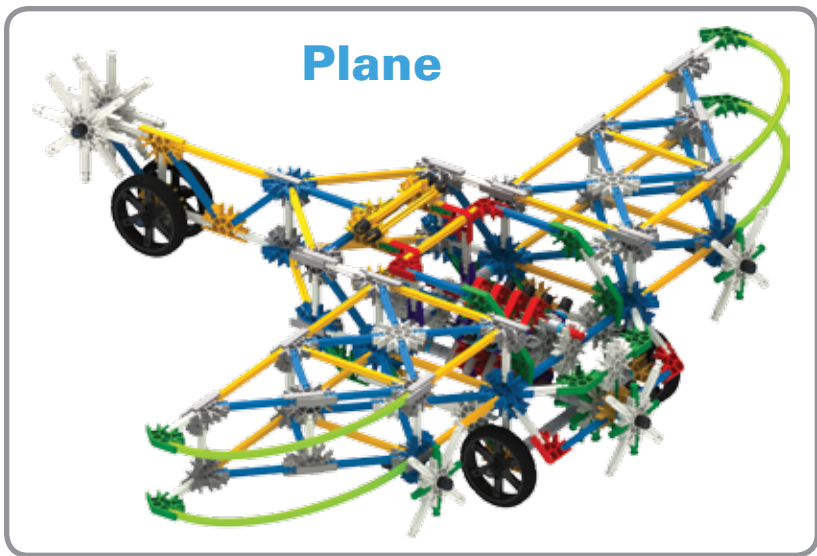
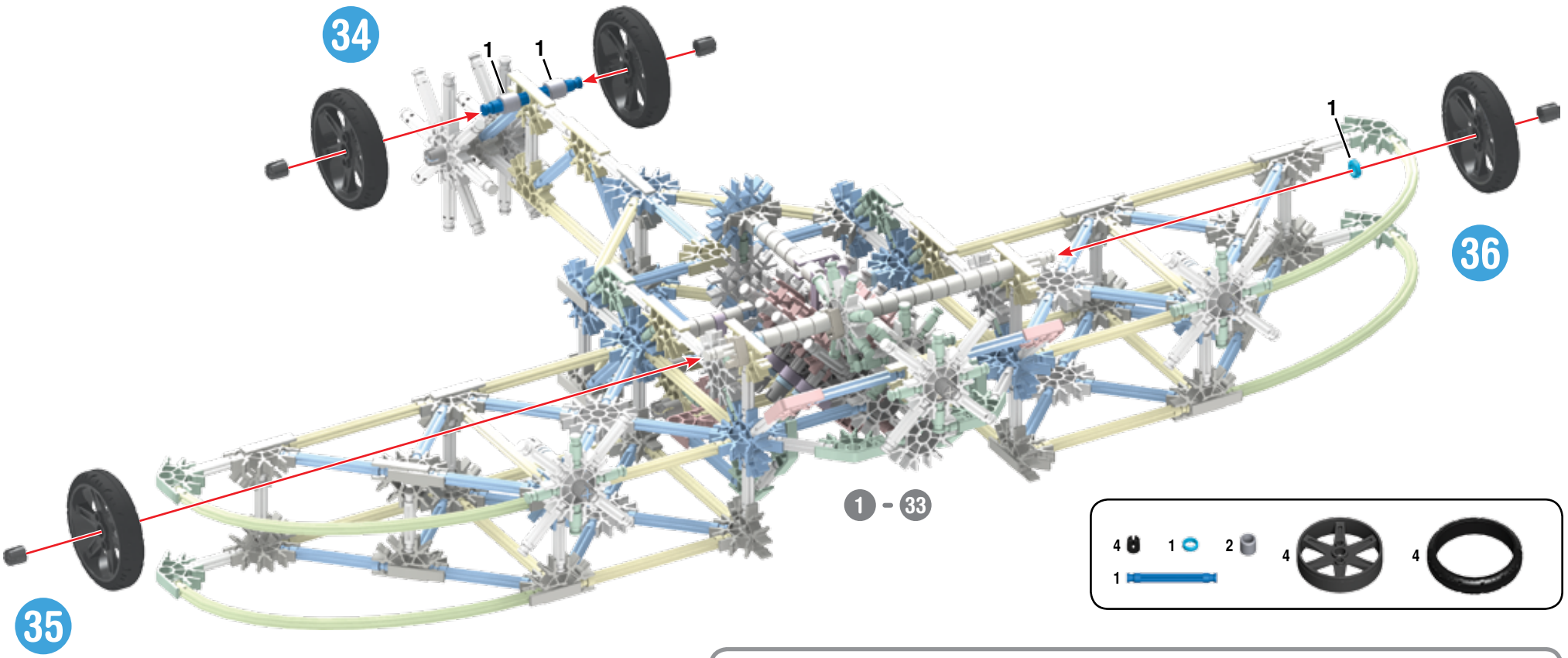

Space Jet

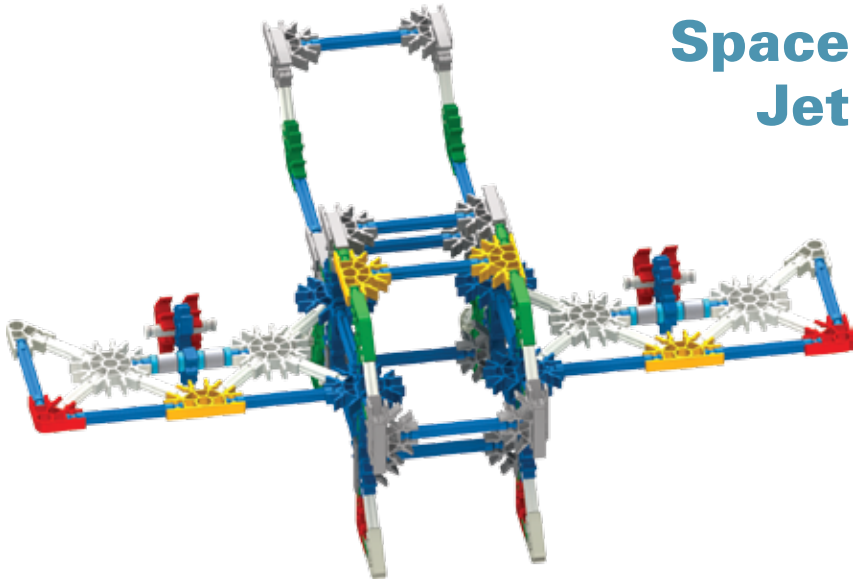

10		4	
6		4	
4		4	
2		4	
4		4	

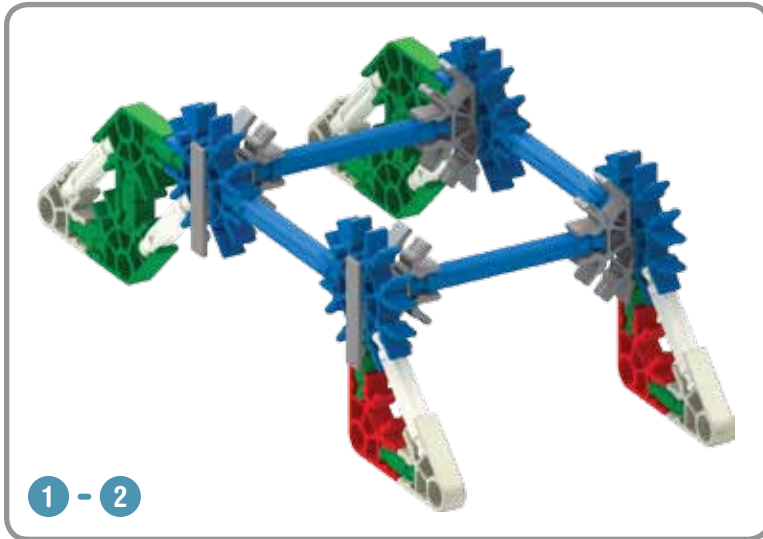
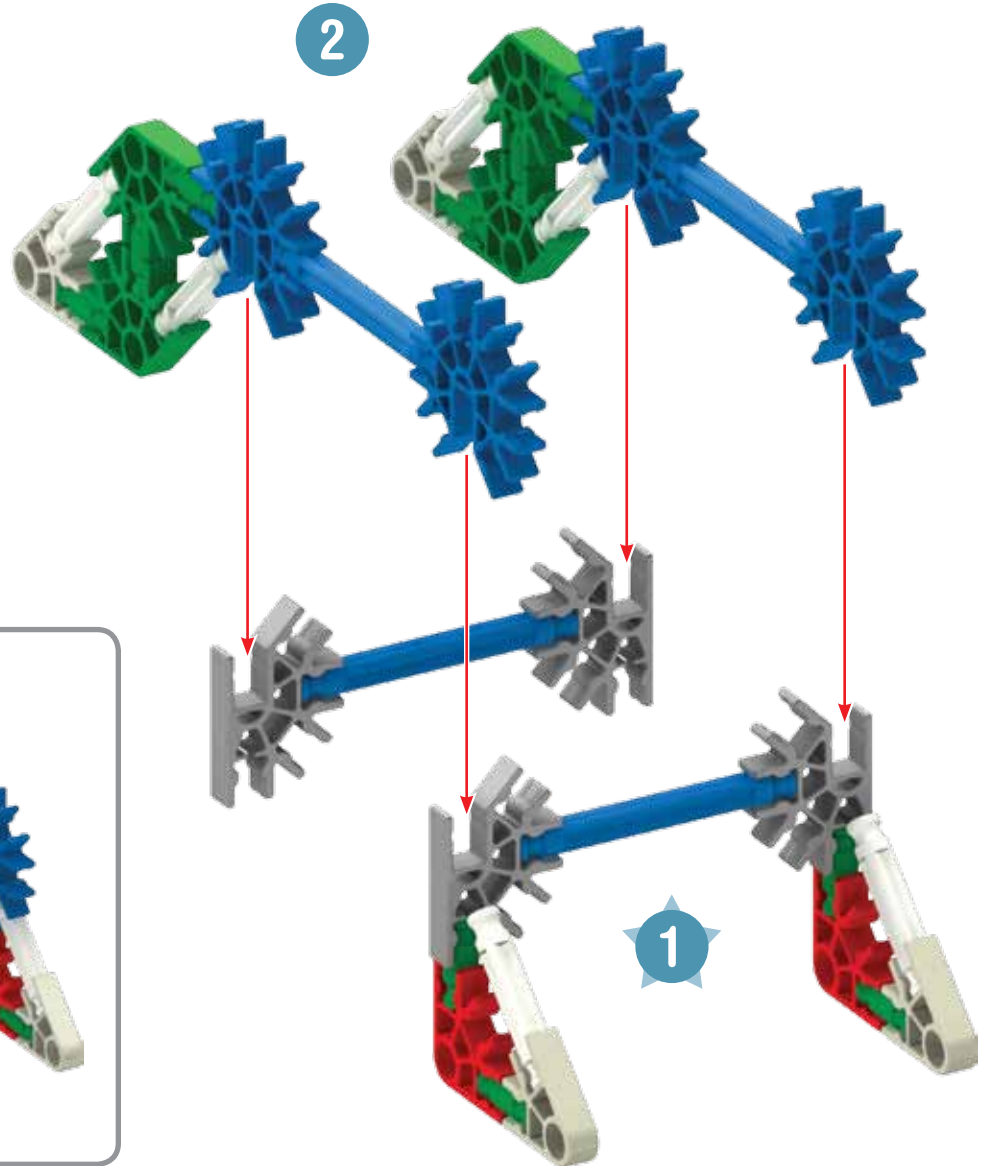

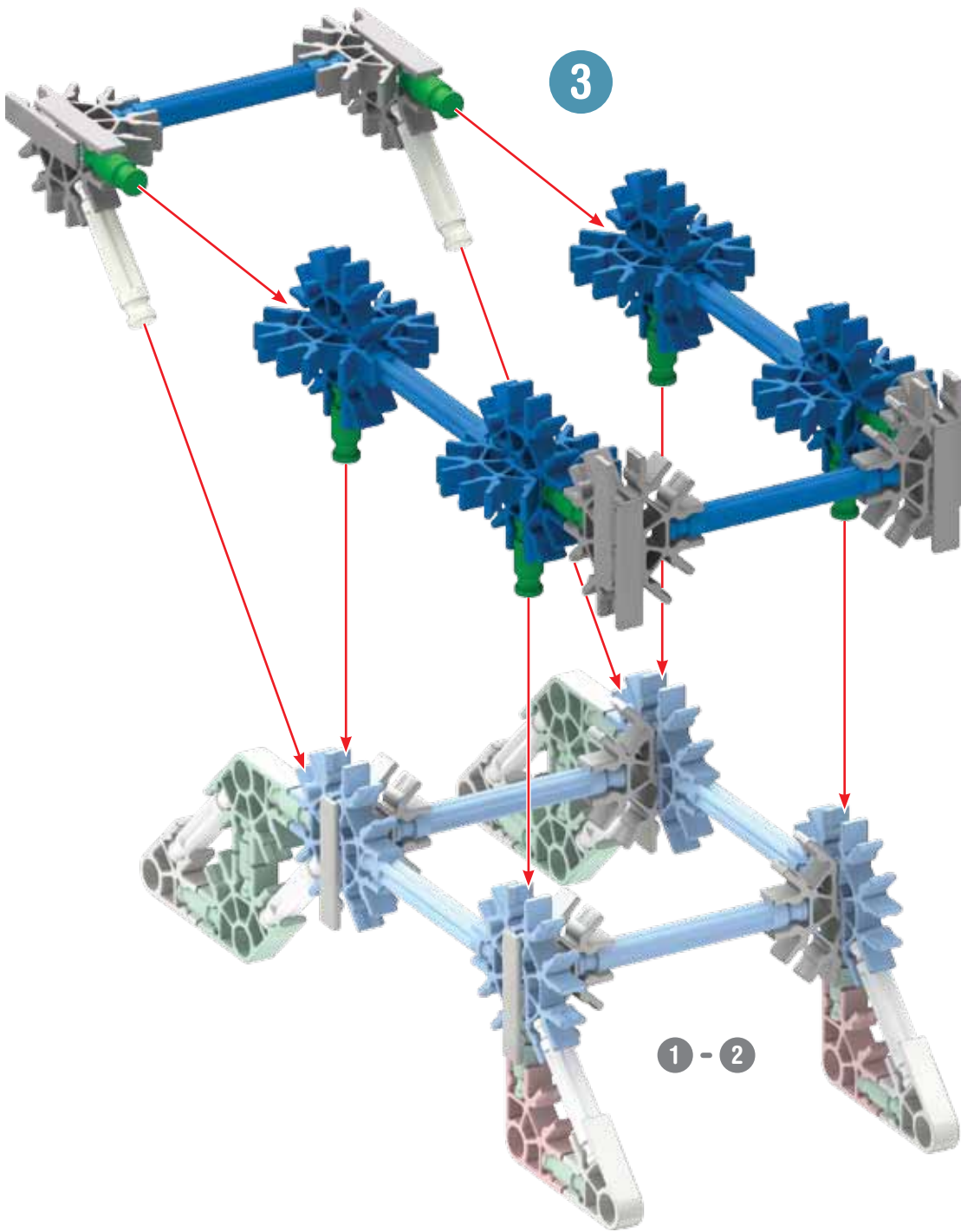

- | | | | | | |
|---|--|---|--|---|--|
| 8 | | 8 | | 8 | |
| 2 | | | | | |
| 4 | | | | | |

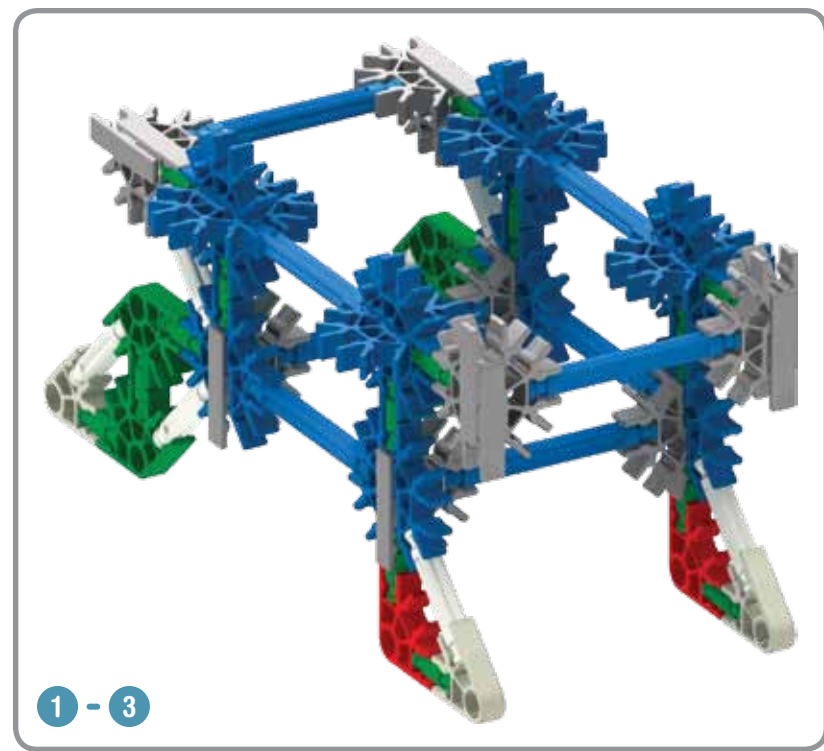

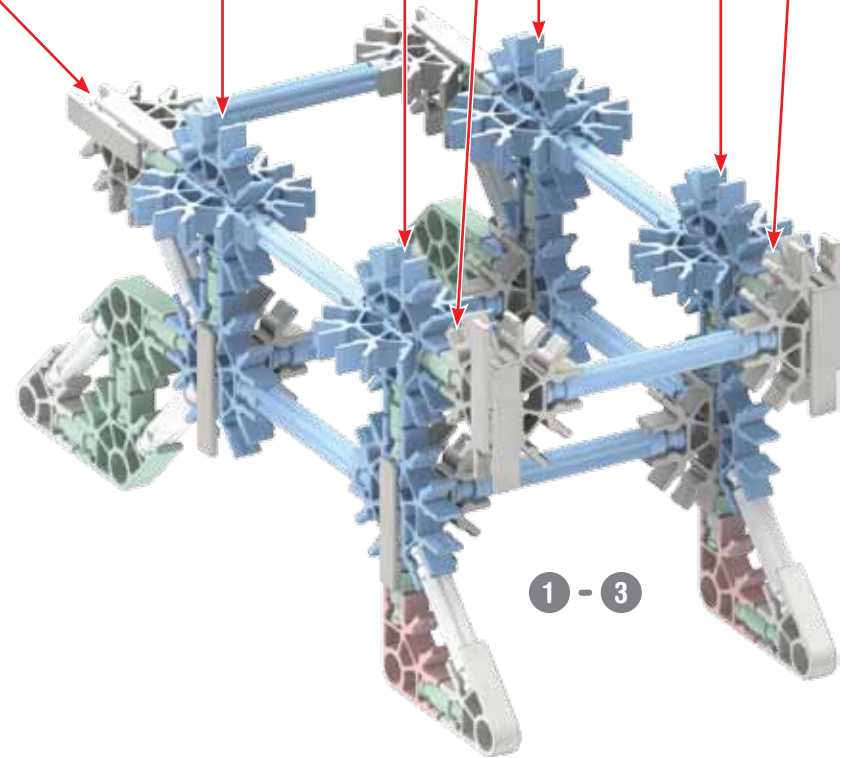
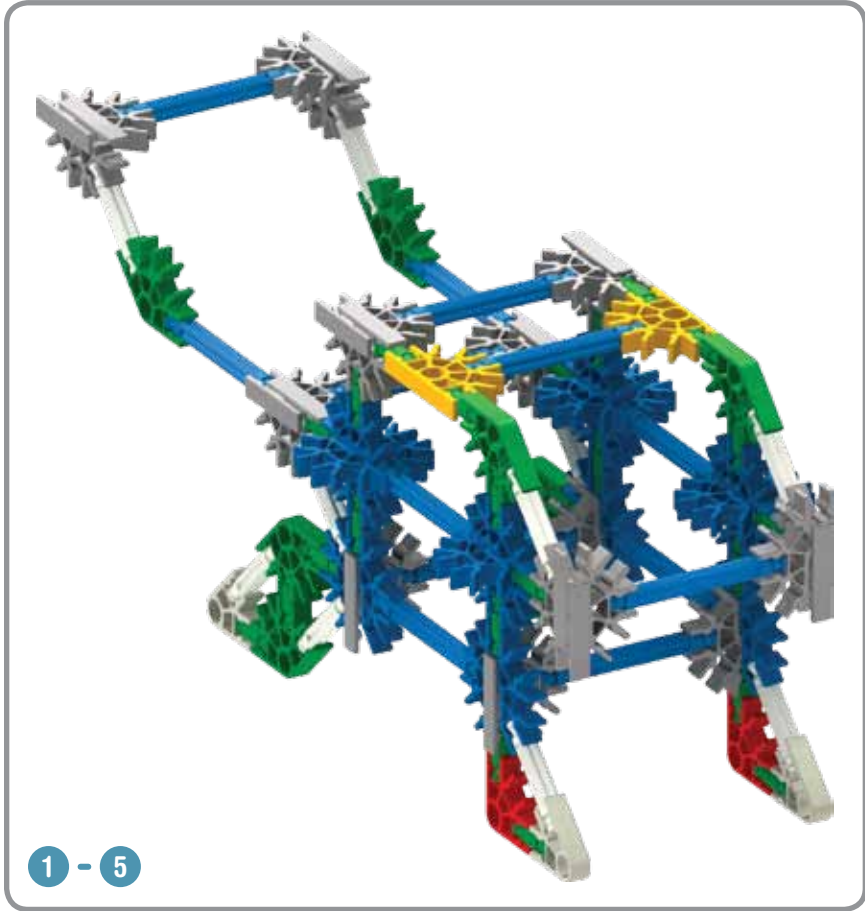
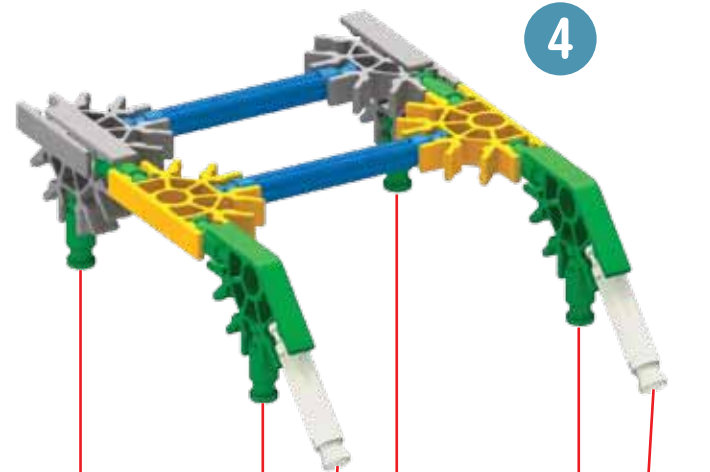
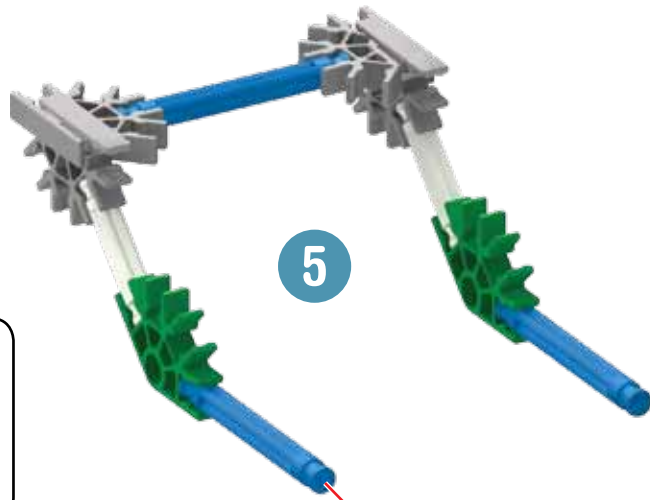
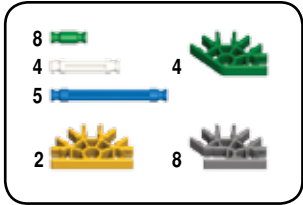

x2

6

7

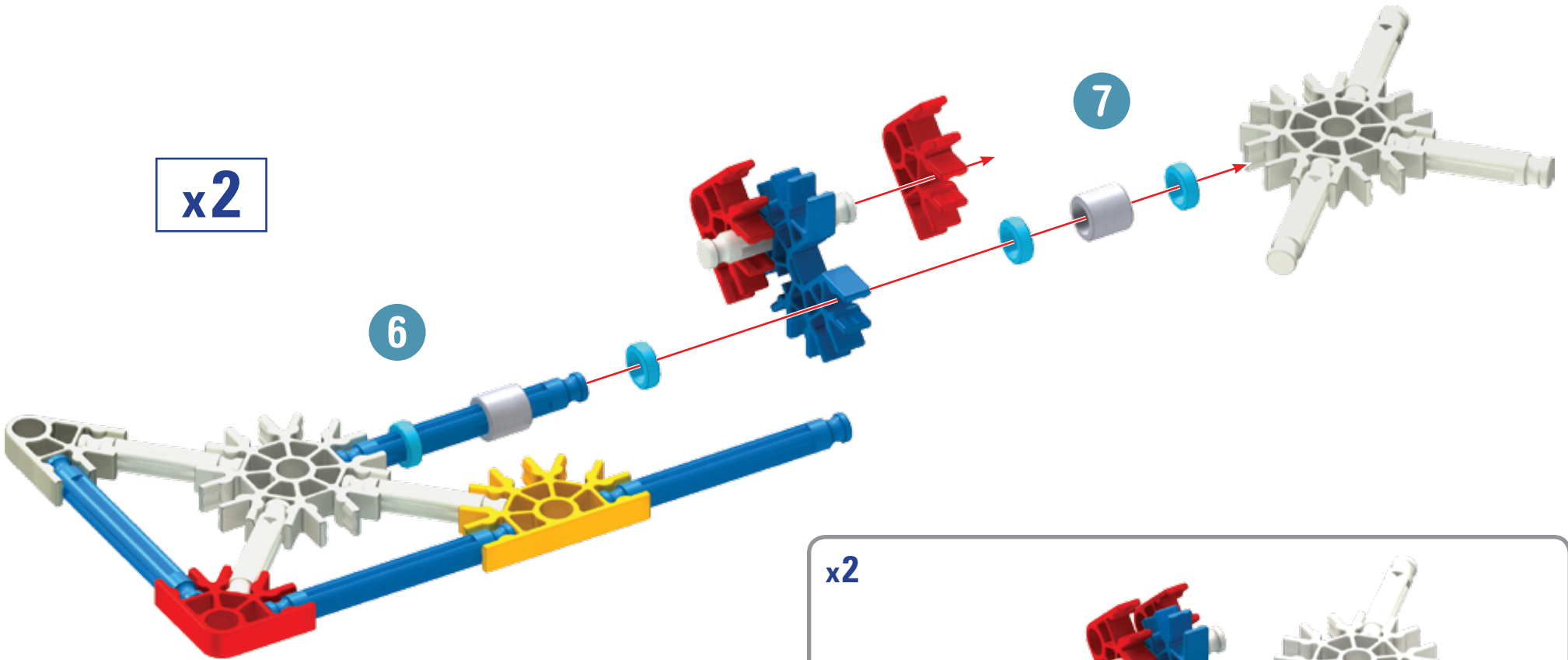

- | | | | | |
|----|---|---|---|---|
| 8 | 4 | 2 | 2 | |
| 14 | | | | |
| 8 | | 6 | 2 | 4 |

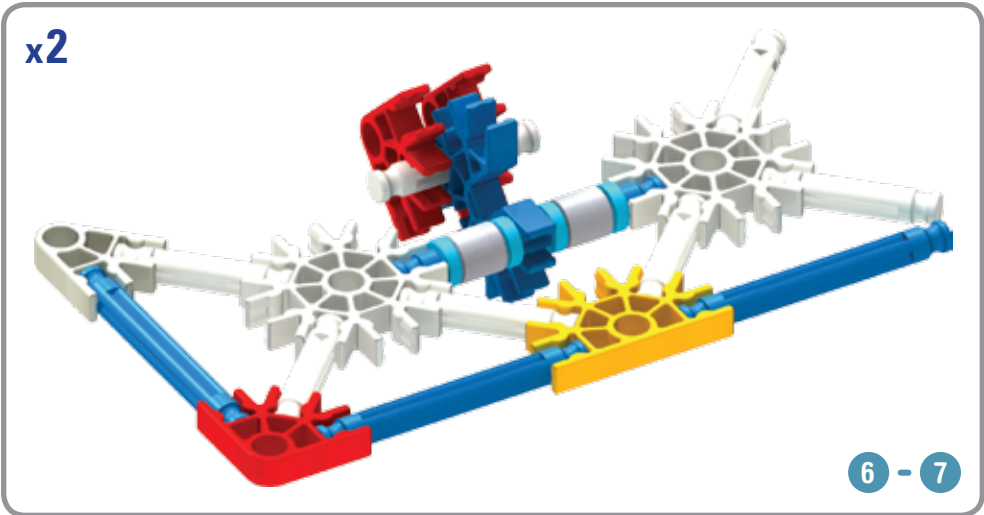

Space Jet

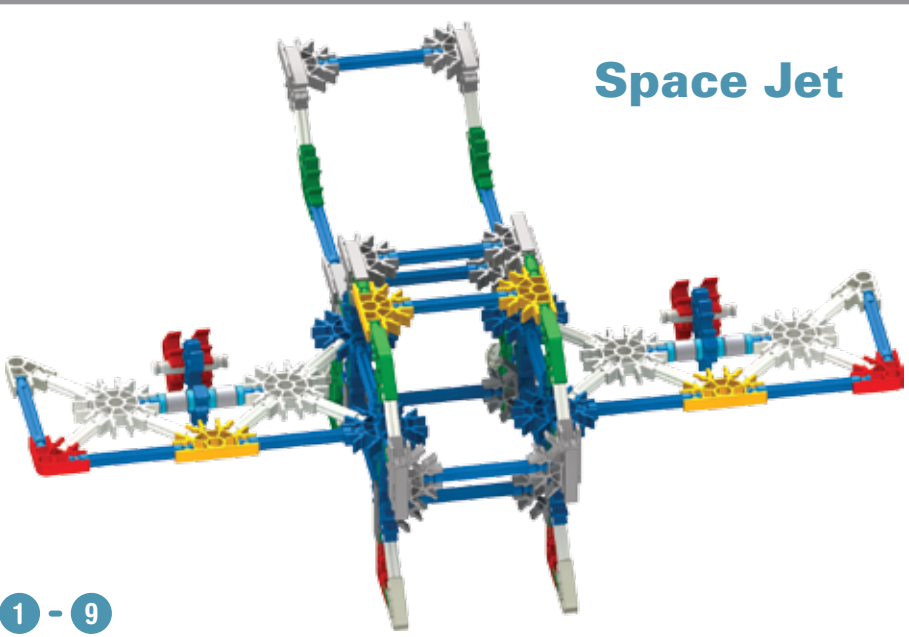

1 - 9

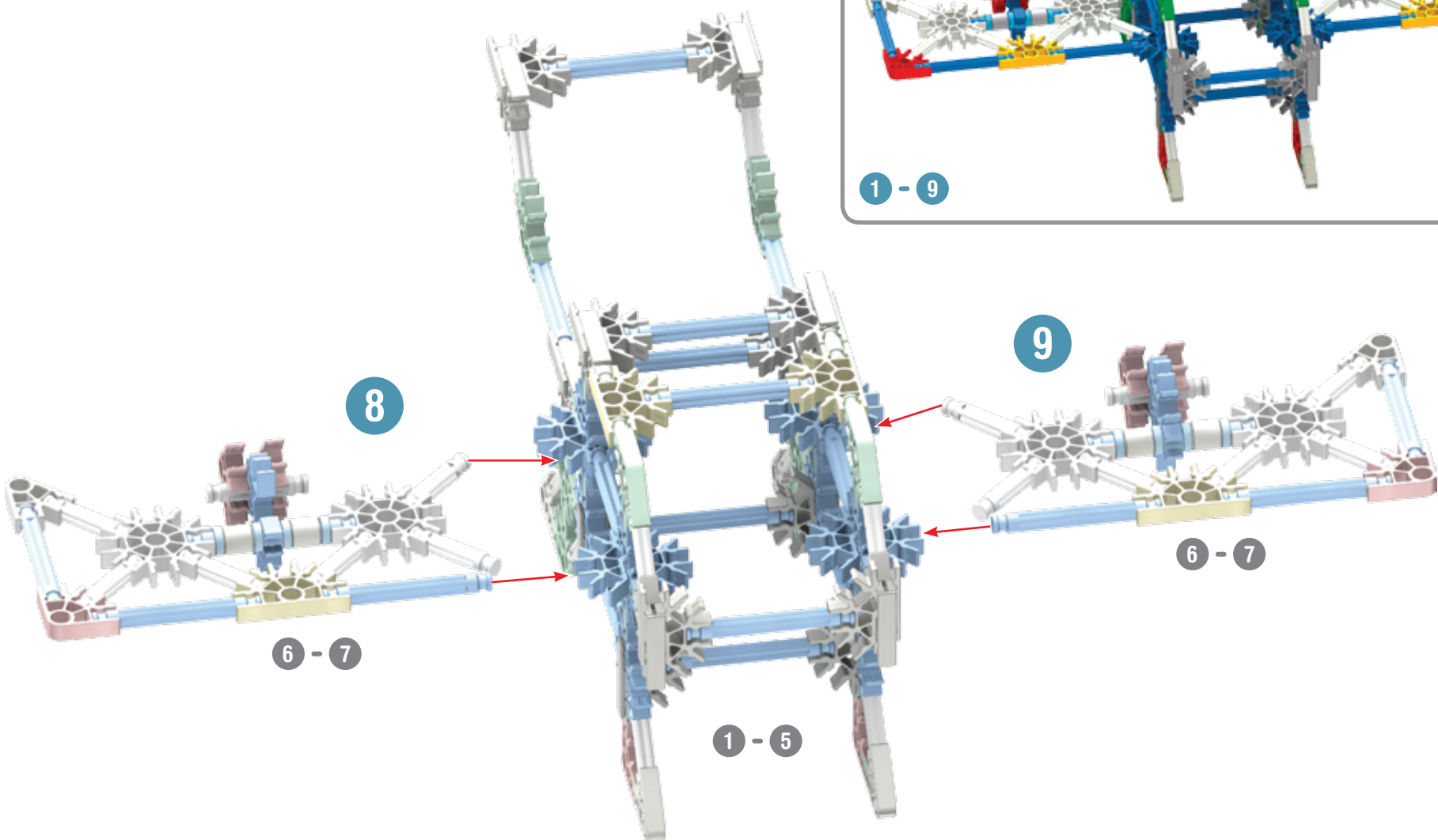

8

6 - 7



1 - 5

9

6 - 7

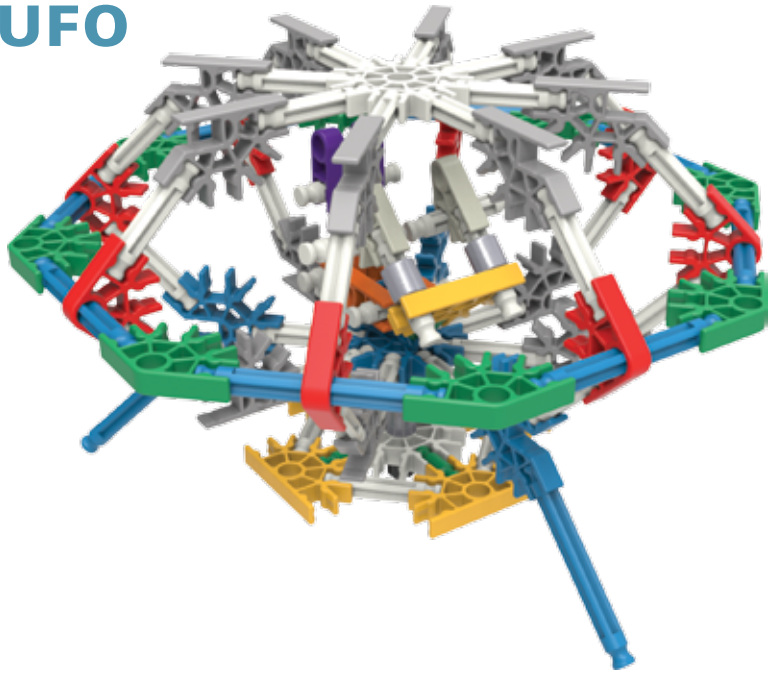
UFO



- 8 
- 3 
- 5 

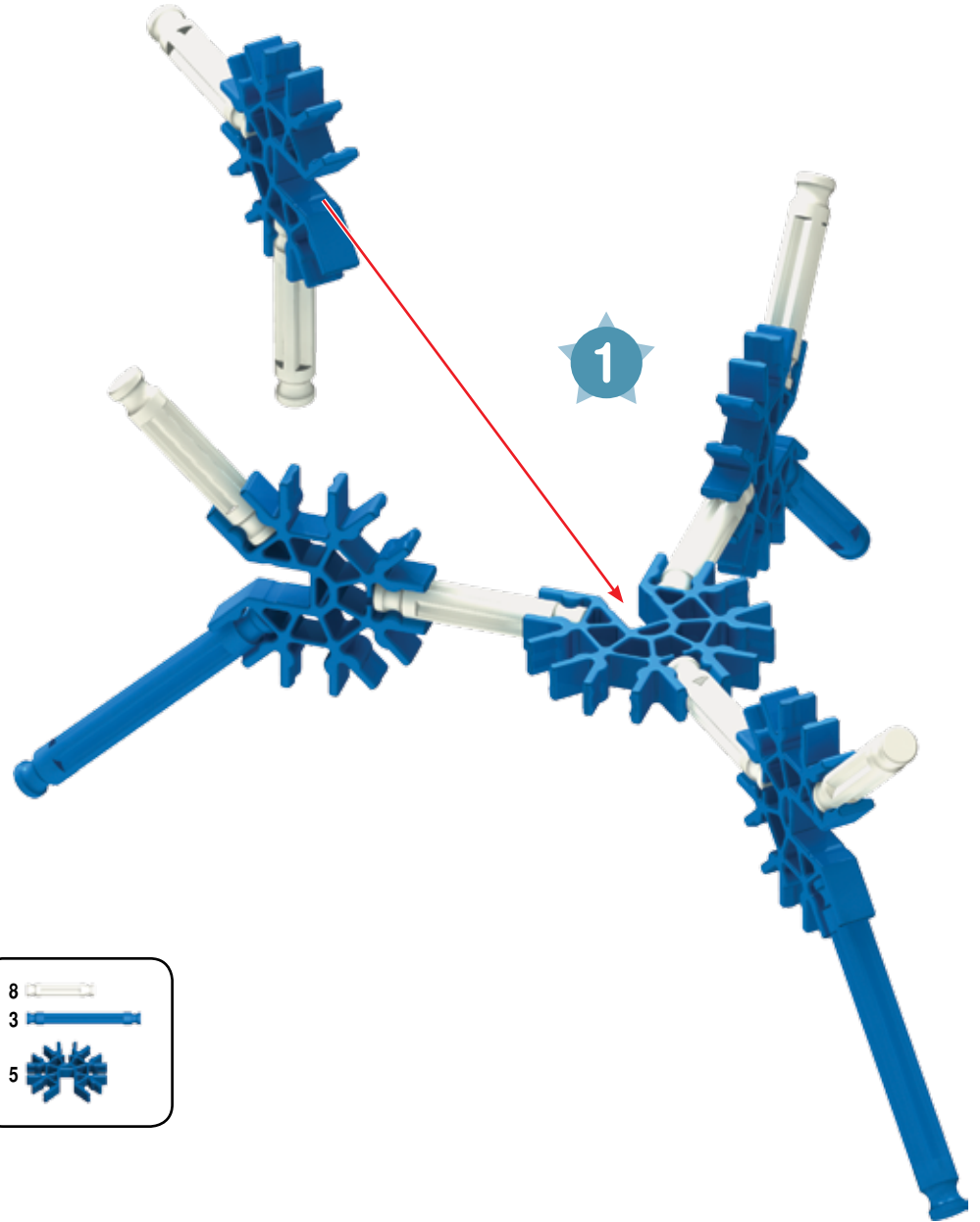

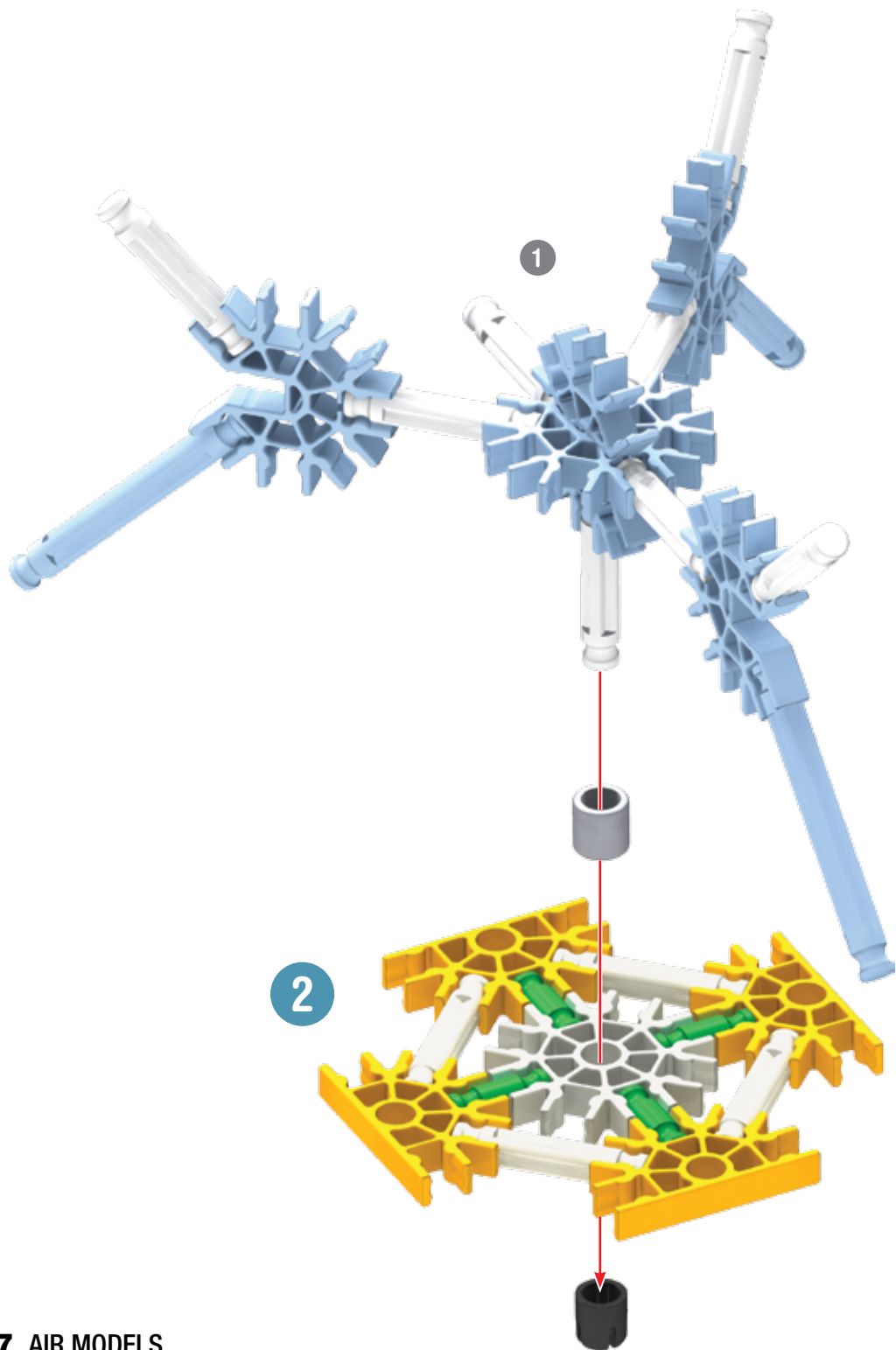

- | | | | | | | | | | |
|---|--|---|--|---|--|---|--|---|--|
| 4 | | 1 | | 1 | | 4 | | 1 | |
| 4 | | | | | | | | | |



1 - 2

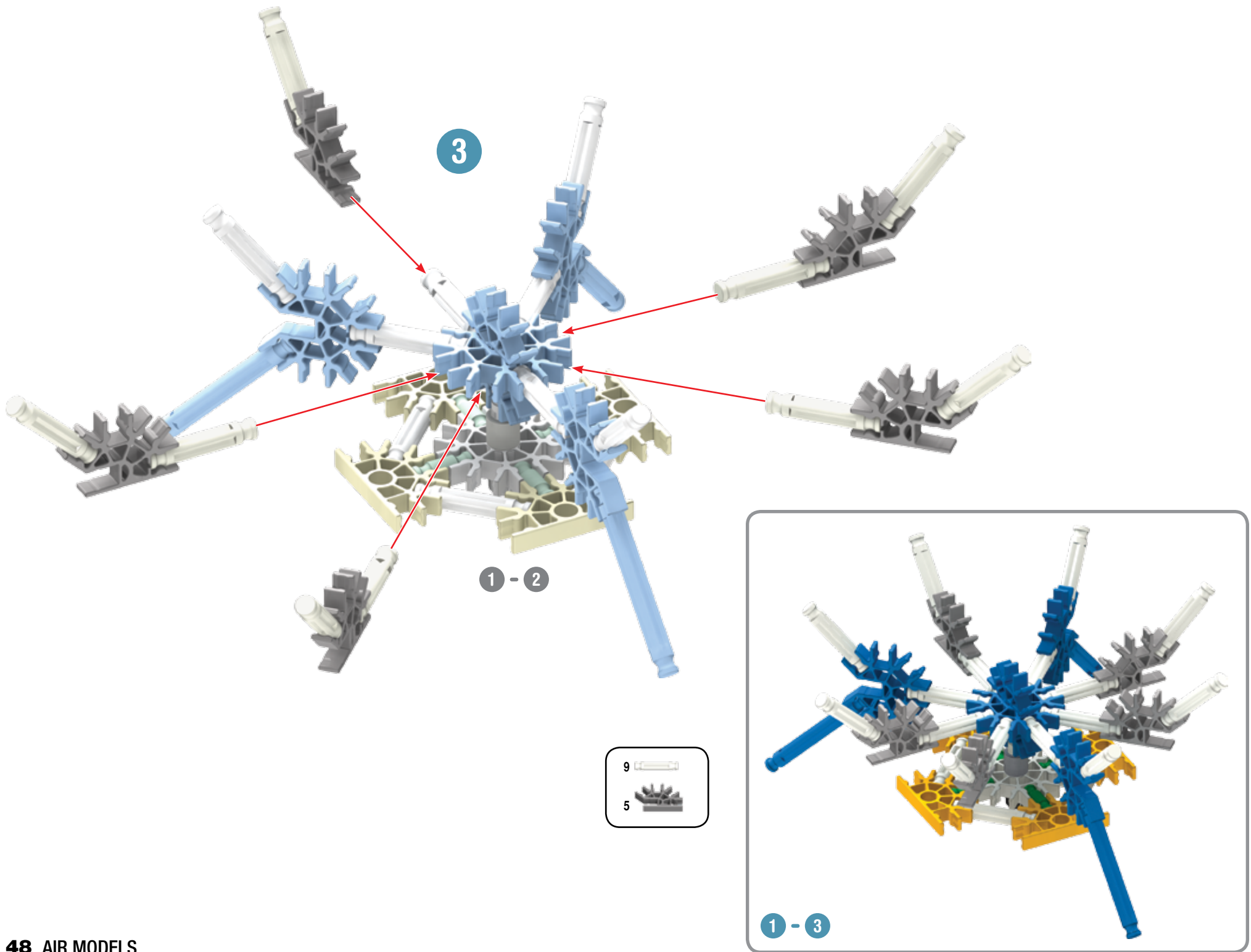

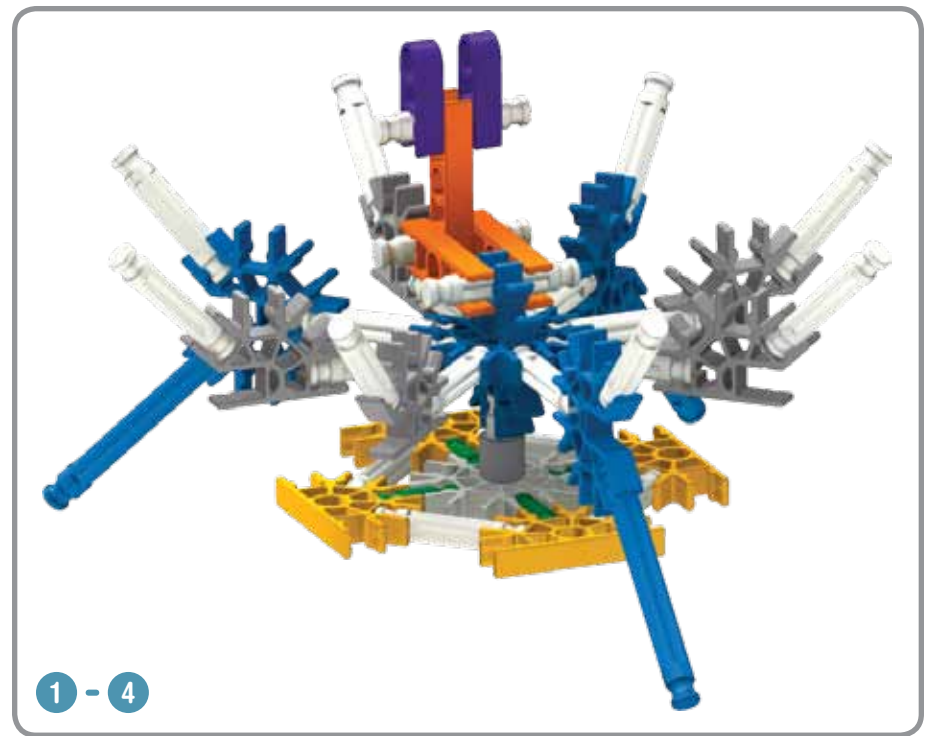
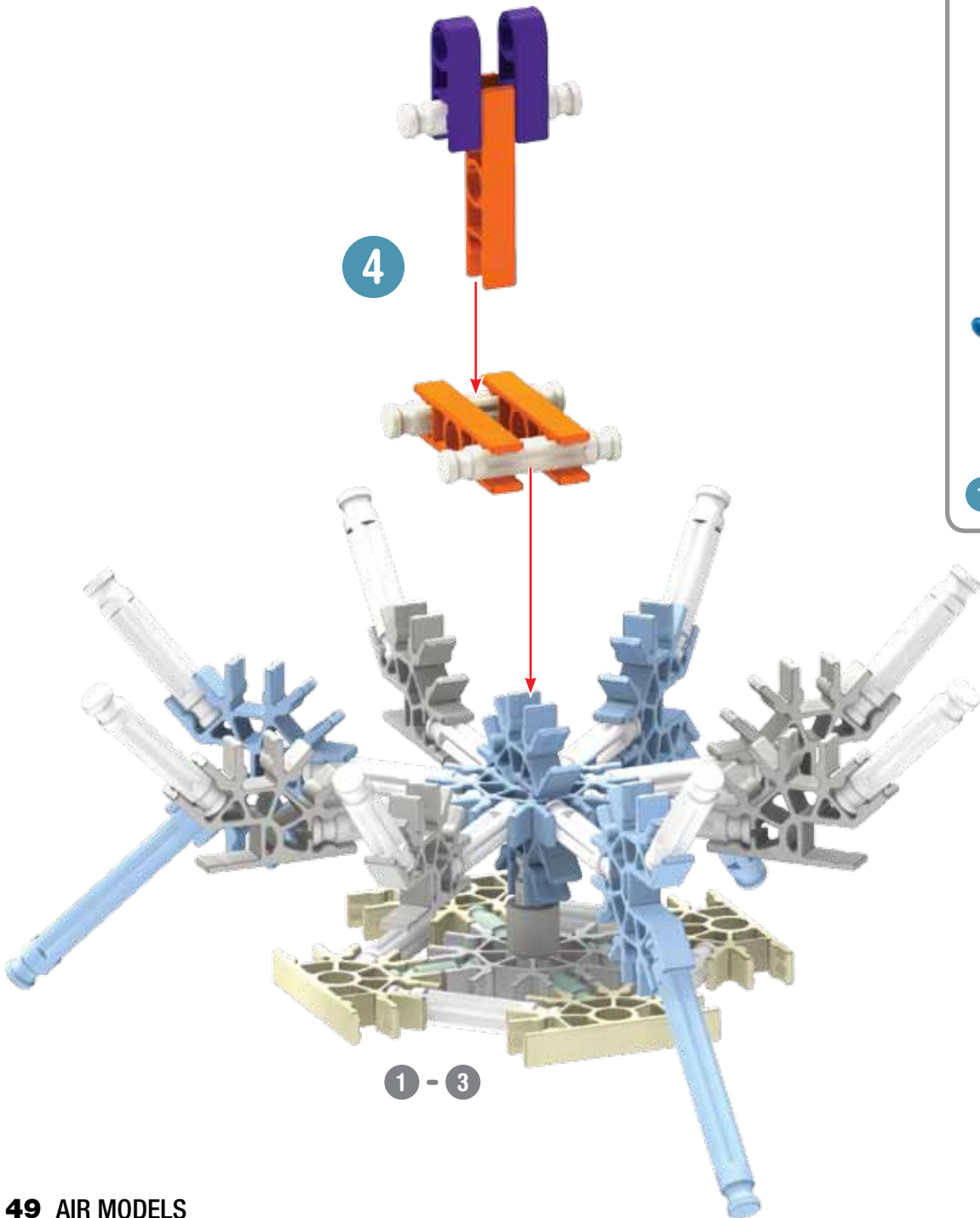

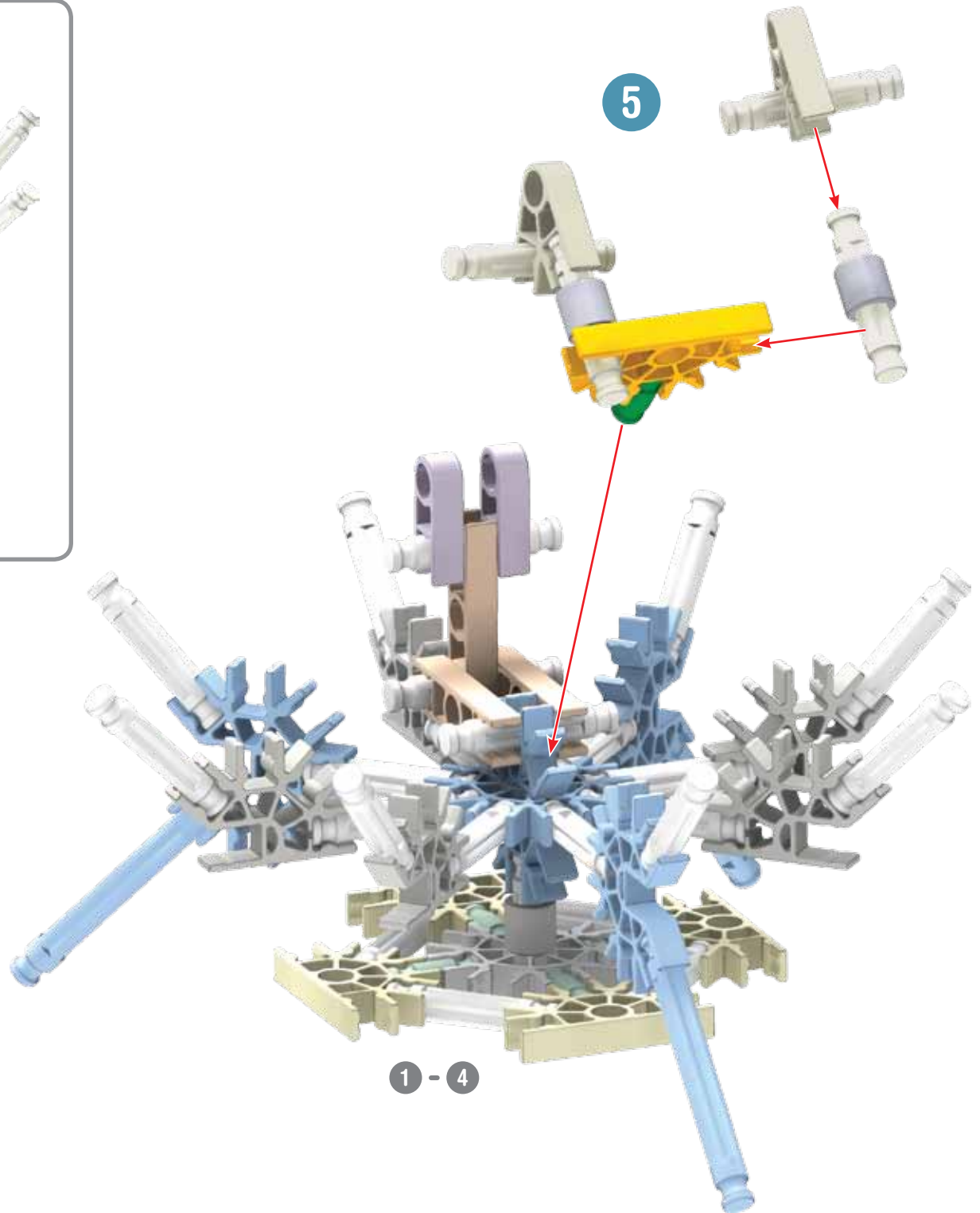

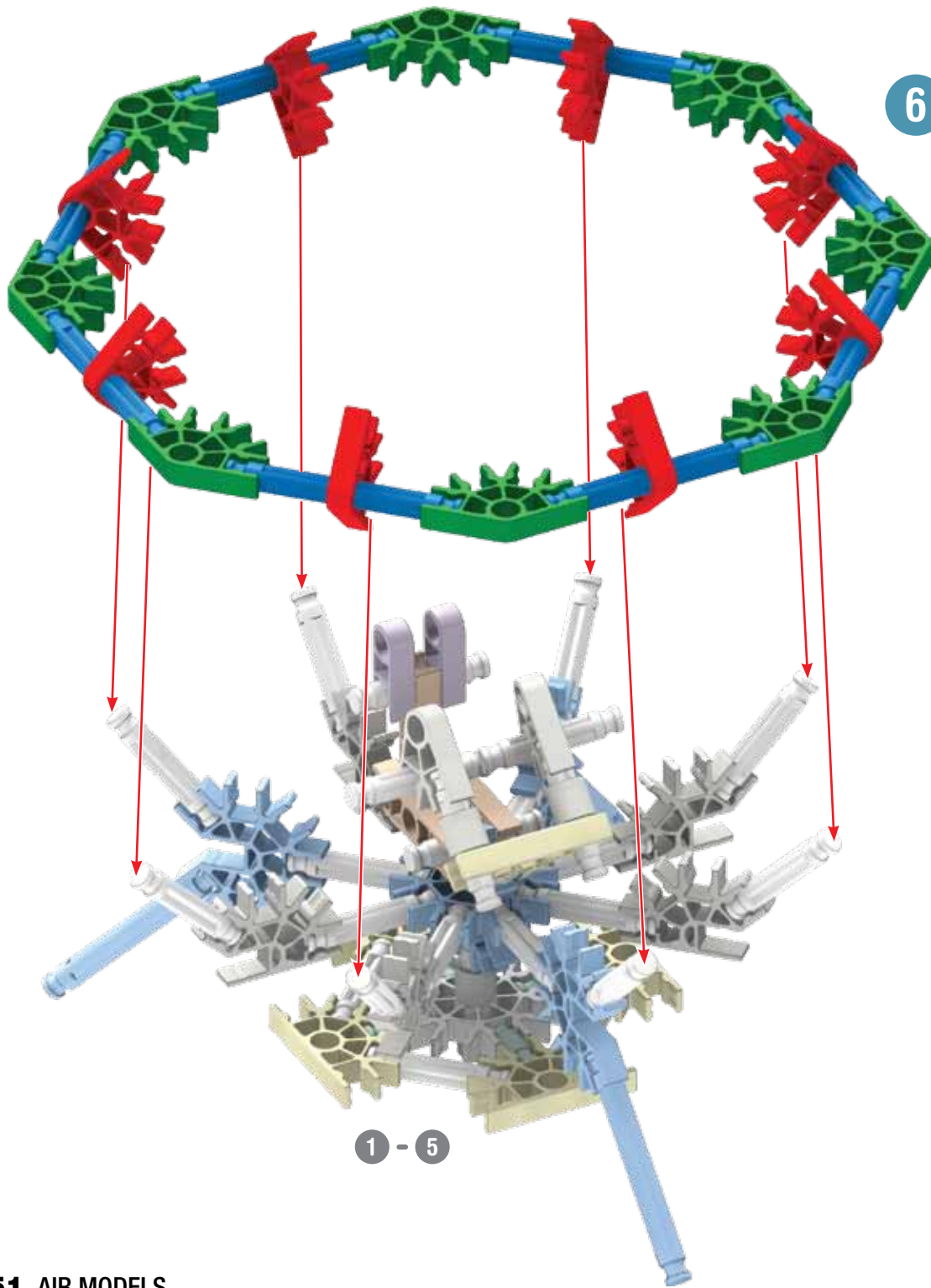

6

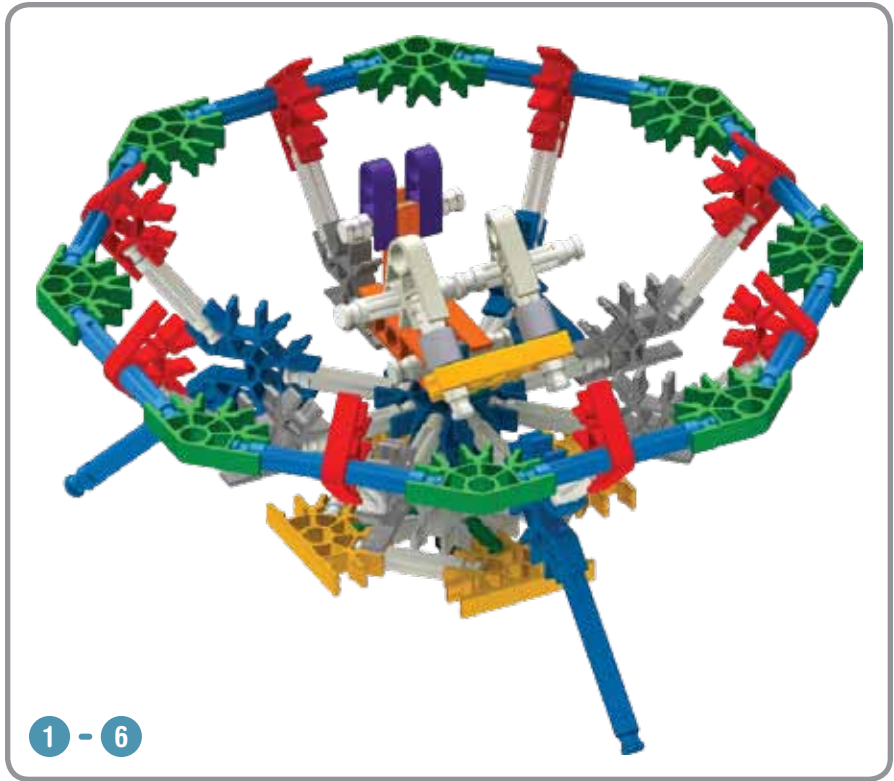
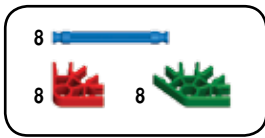

7

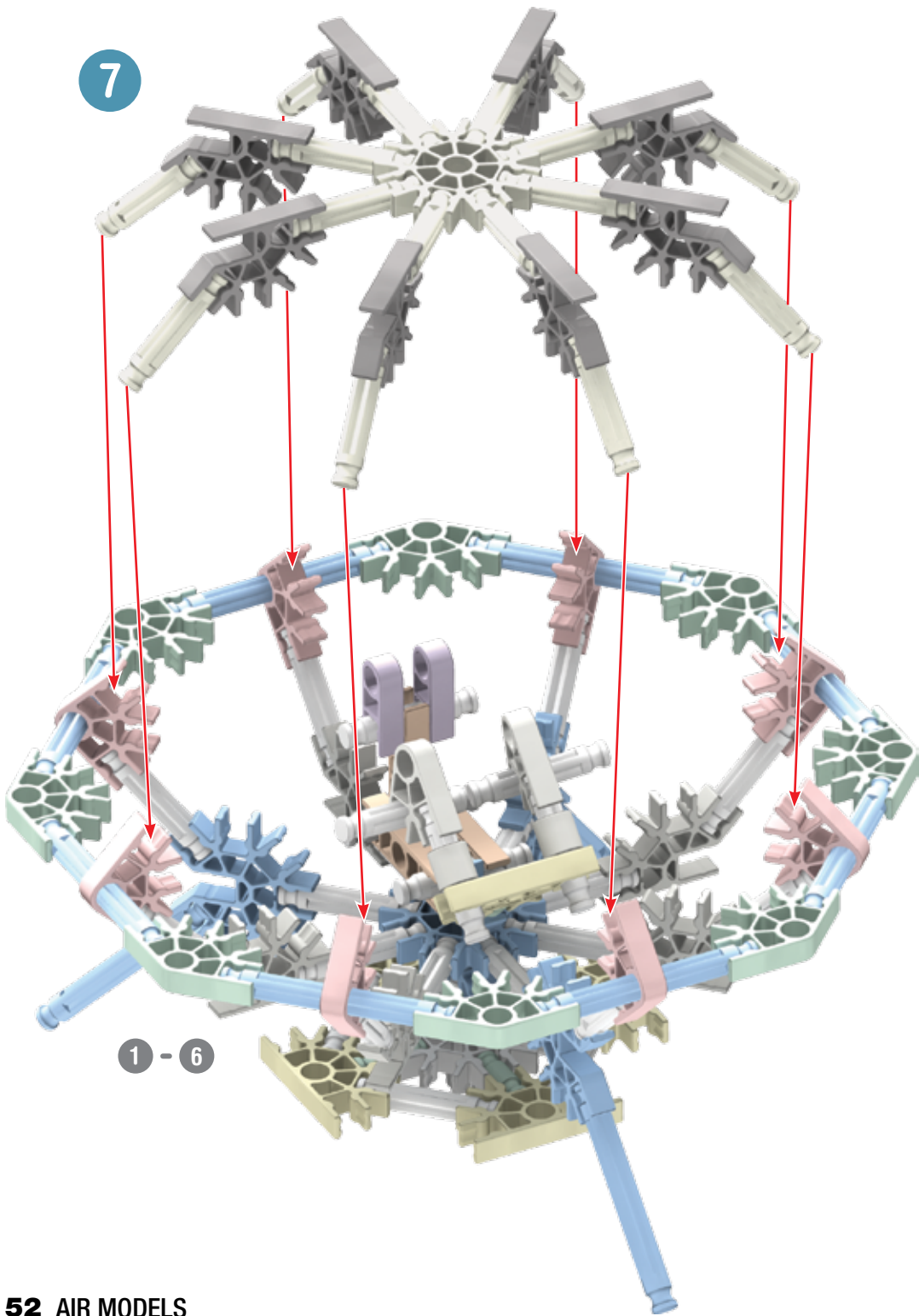

- 16
- 8
- 1

UFO

