

16457

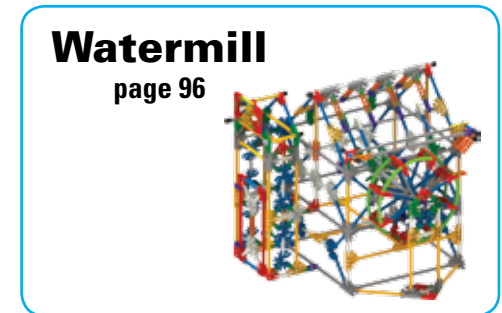

**ULTIMATE 100 MODEL
BUILDING SET**

STRUCTURES

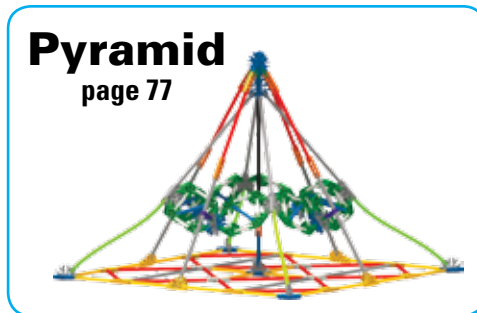
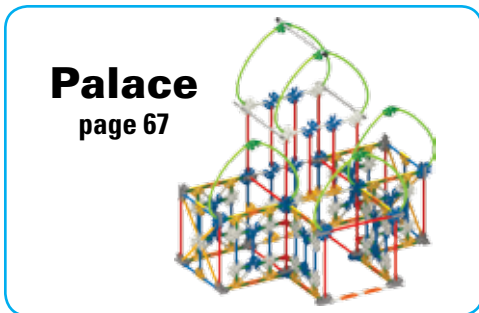
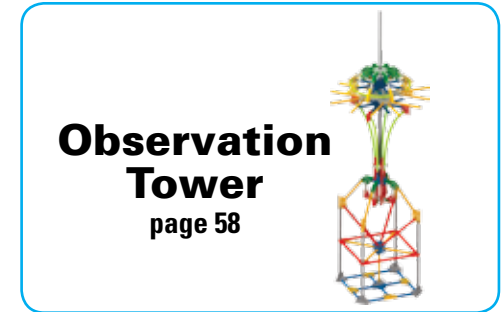
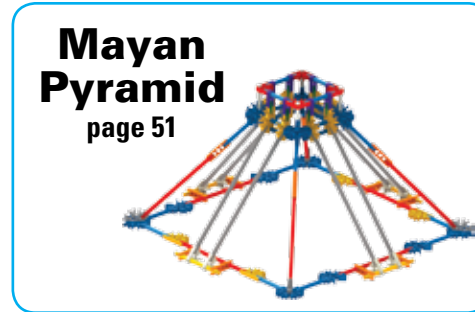
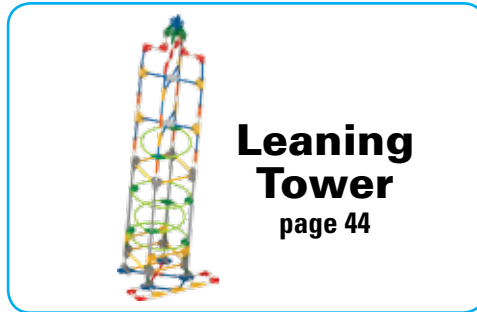
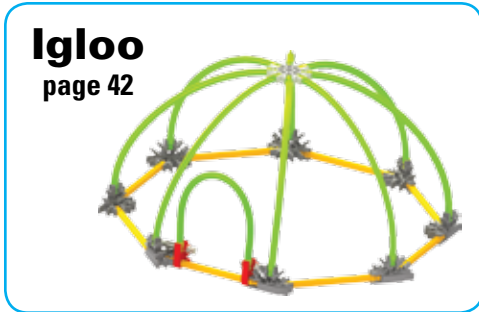
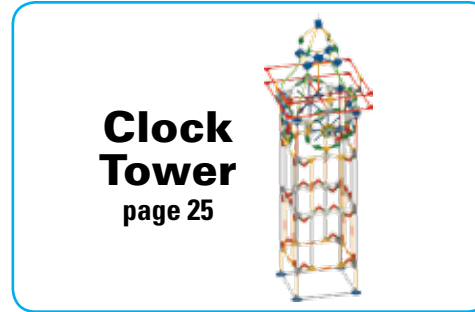
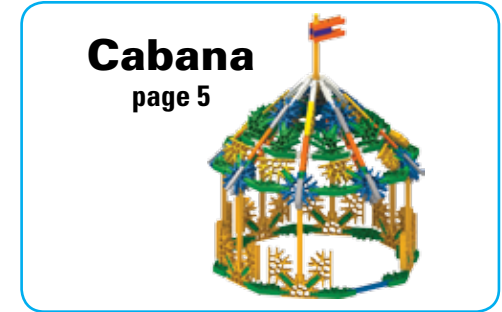

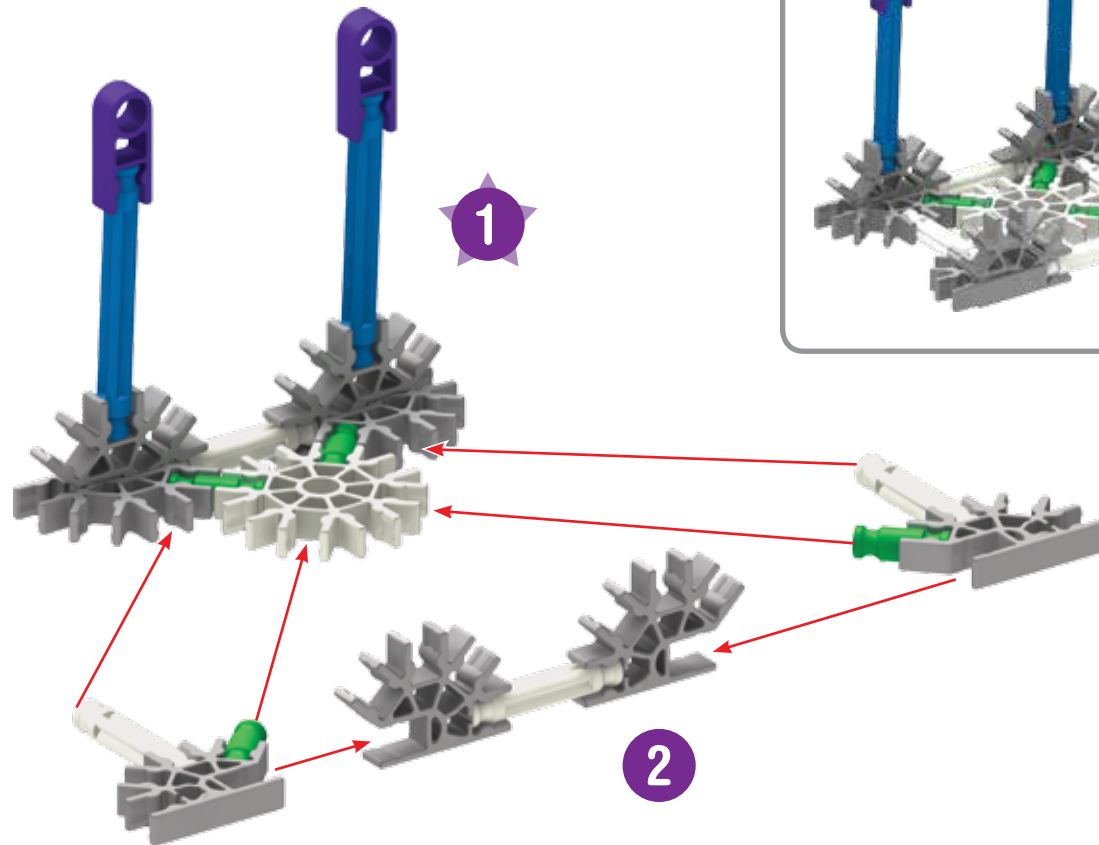
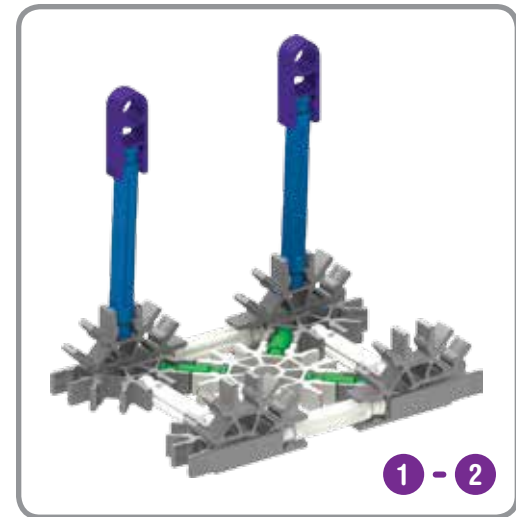
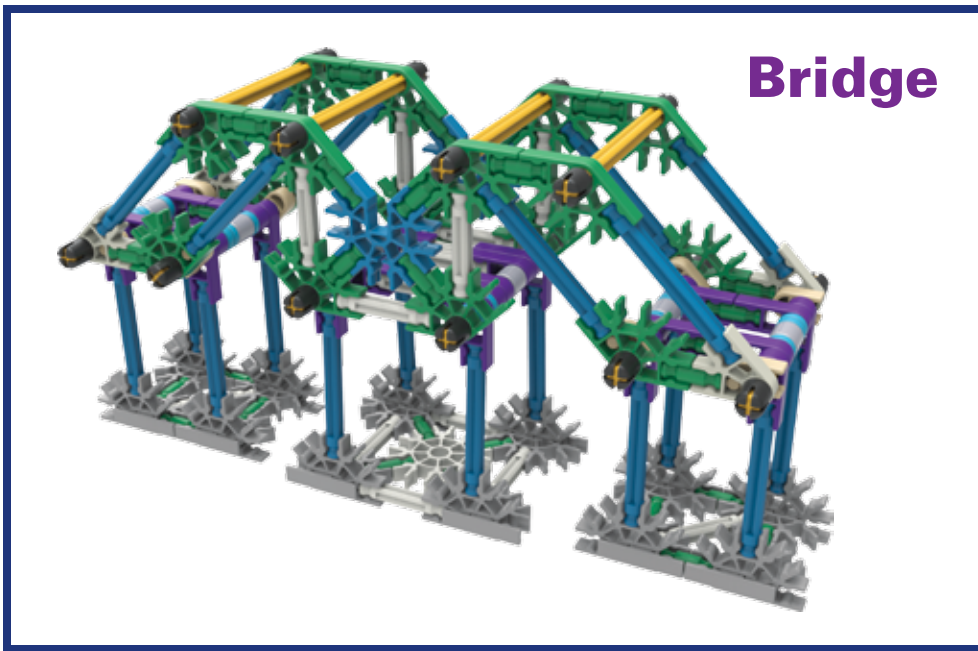

- 4
- 4
- 2
- 2
- 8
- 1

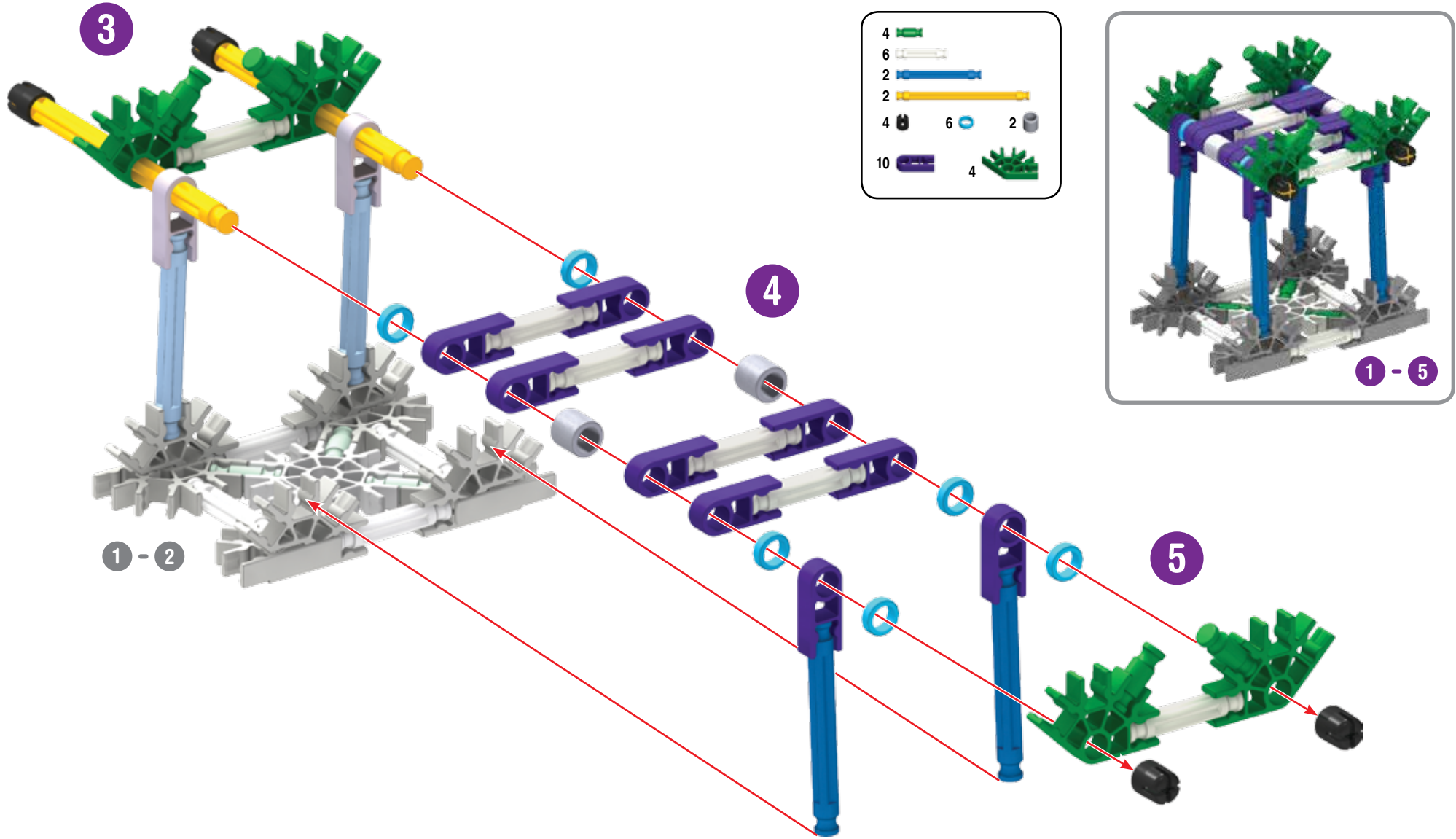

- | | | | |
|---|--|----|--|
| 8 | | 4 | |
| 2 | | | |
| 4 | | 16 | |

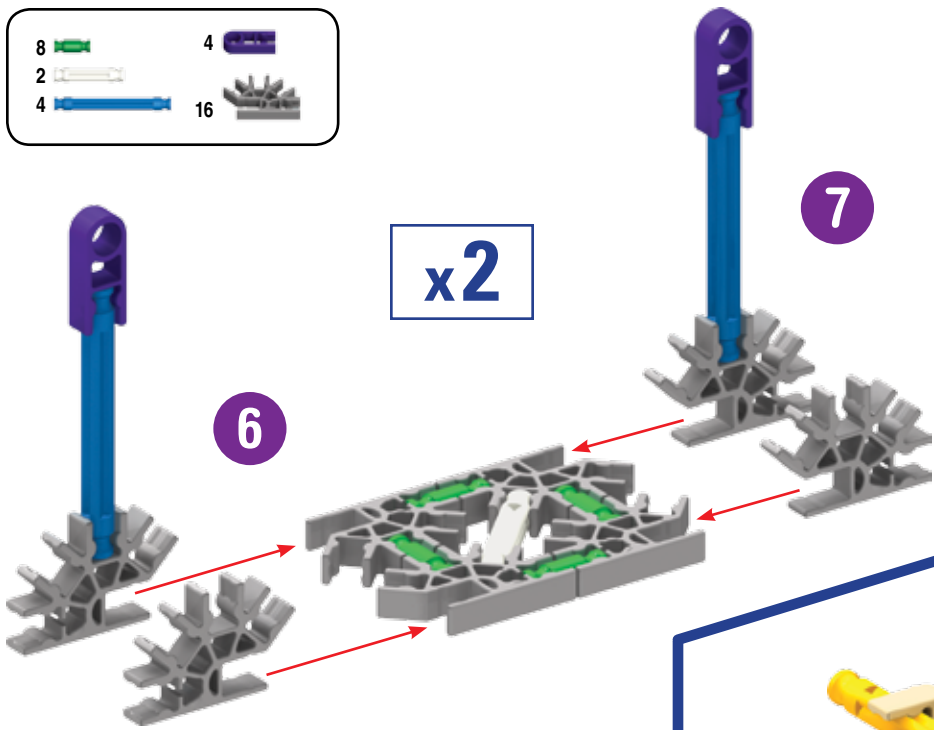

- | | | | | | |
|---|--|----|--|---|--|
| 4 | | 12 | | 4 | |
| 4 | | | | | |
| 8 | | 12 | | | |

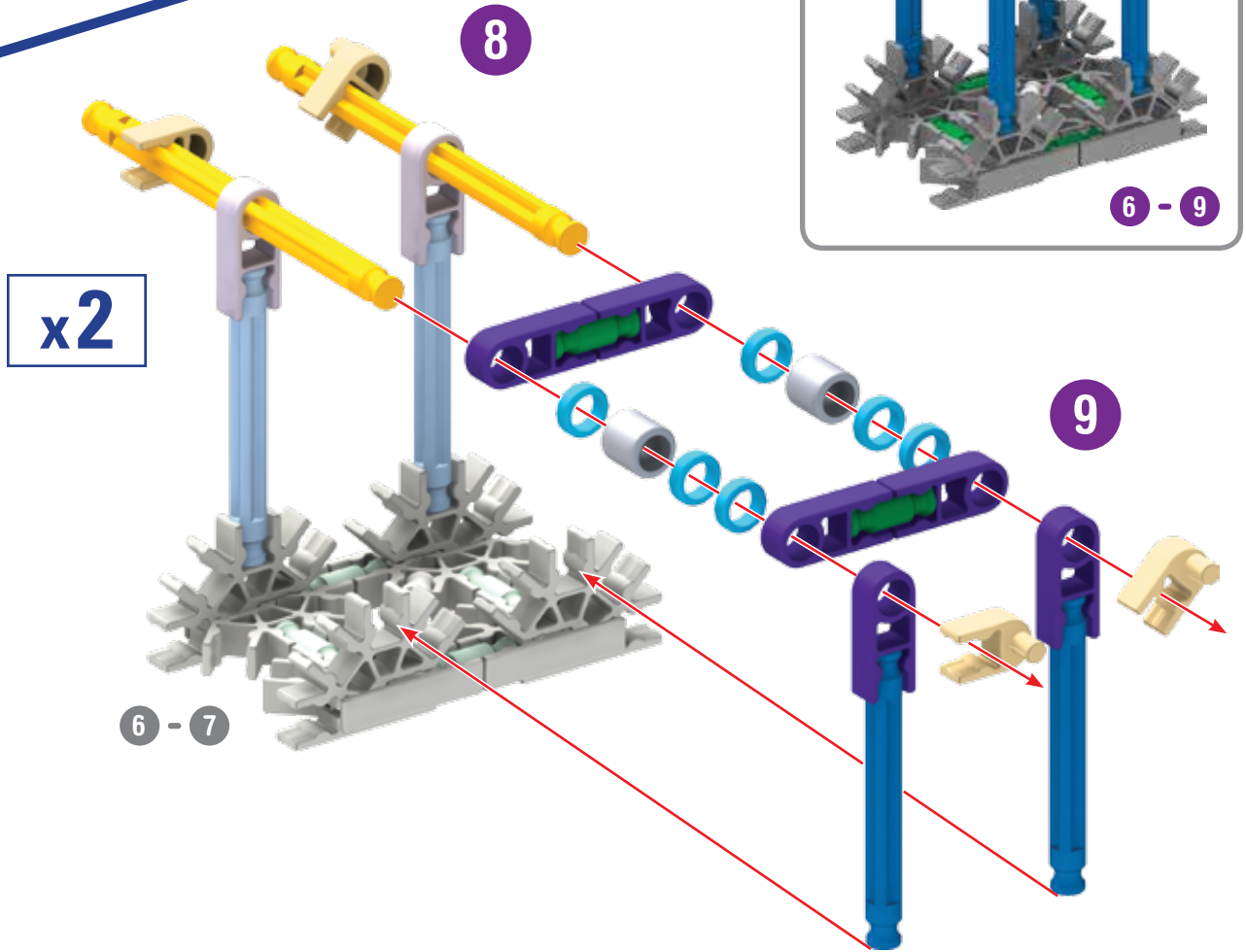
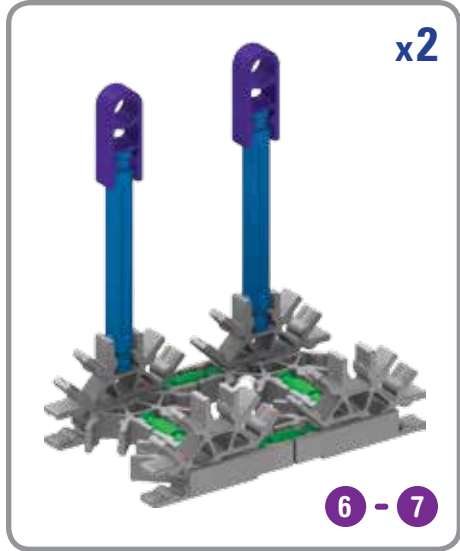

- 12
- 4
- 8
- 4
- 12
- 2

x2

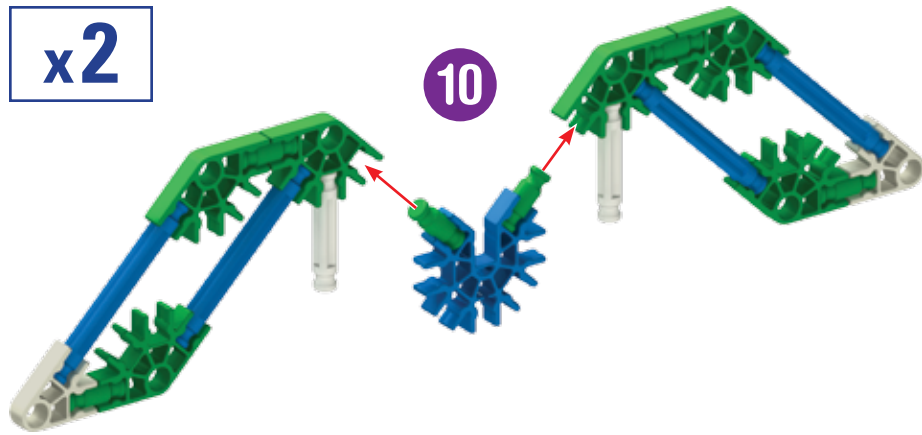

10



x2

10

Bridge

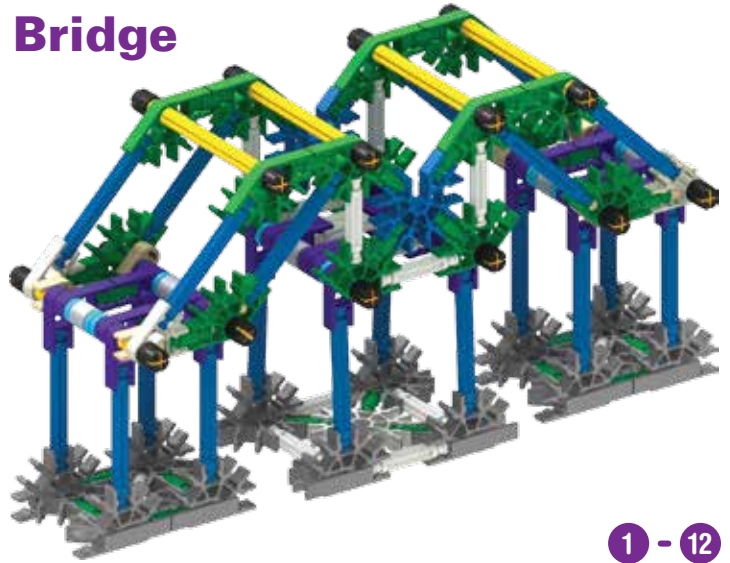

1 - 12

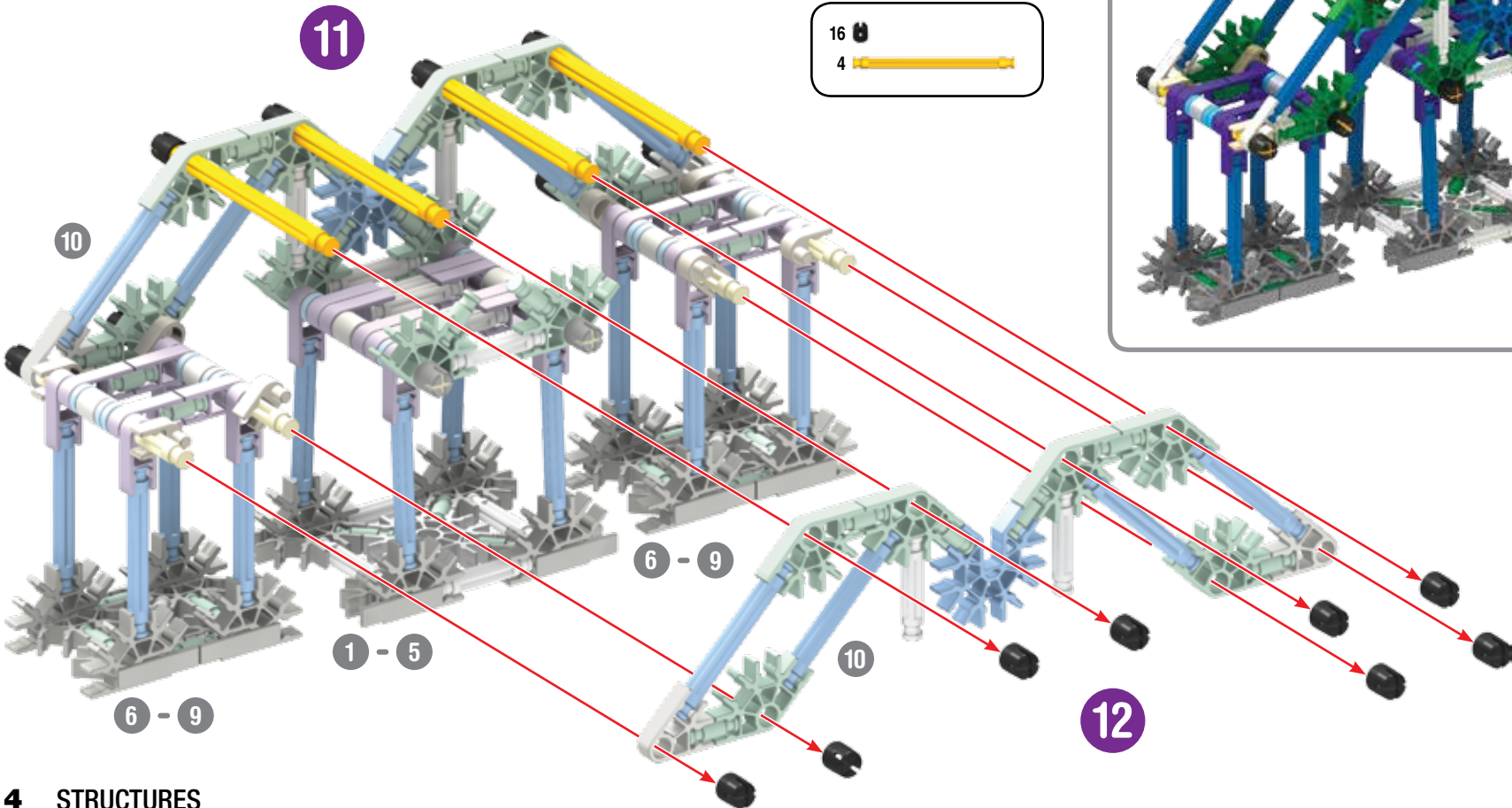

11

- 16
- 4

10

6 - 9

1 - 5

10

12

6 - 9

Cabana



x7

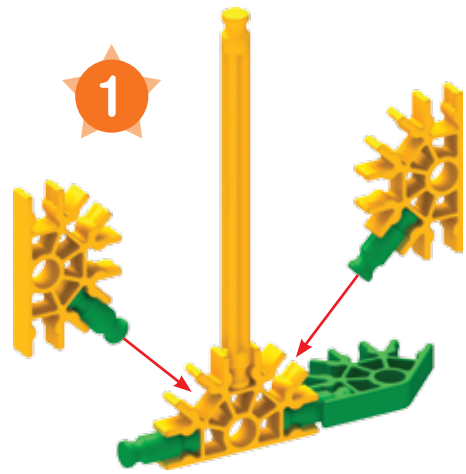

- 28
- 7
- 7
- 21

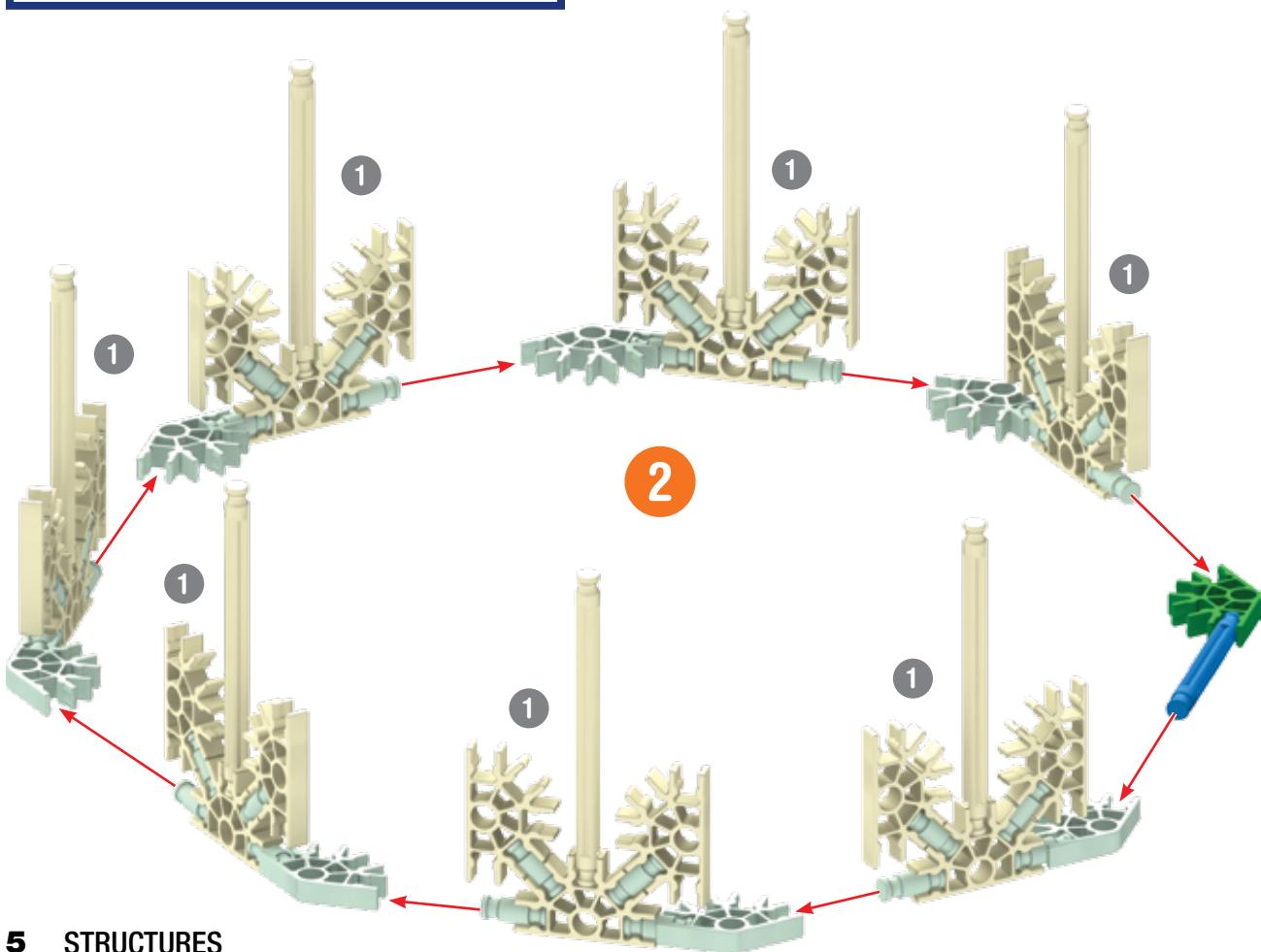
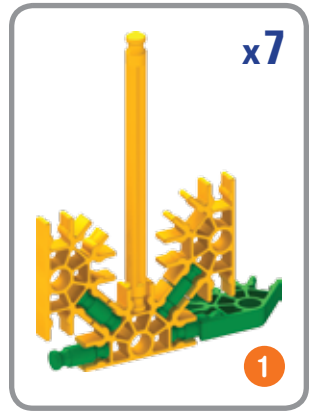

- 1
- 1

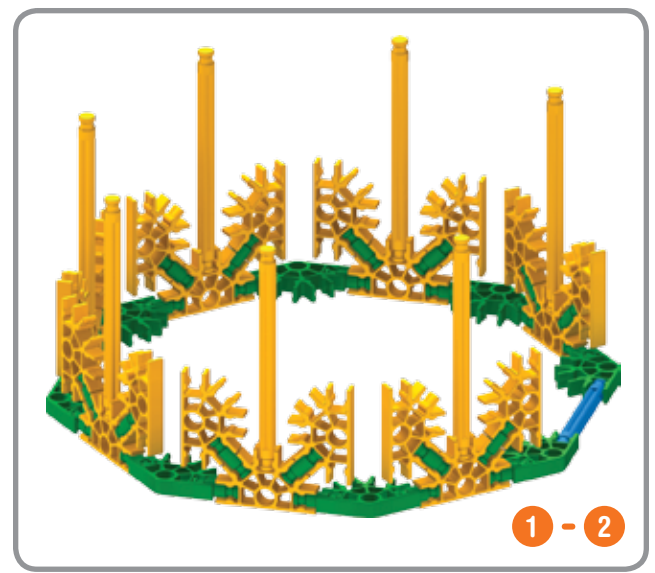

x8

40		8	
8		8	
8		16	
8		8	

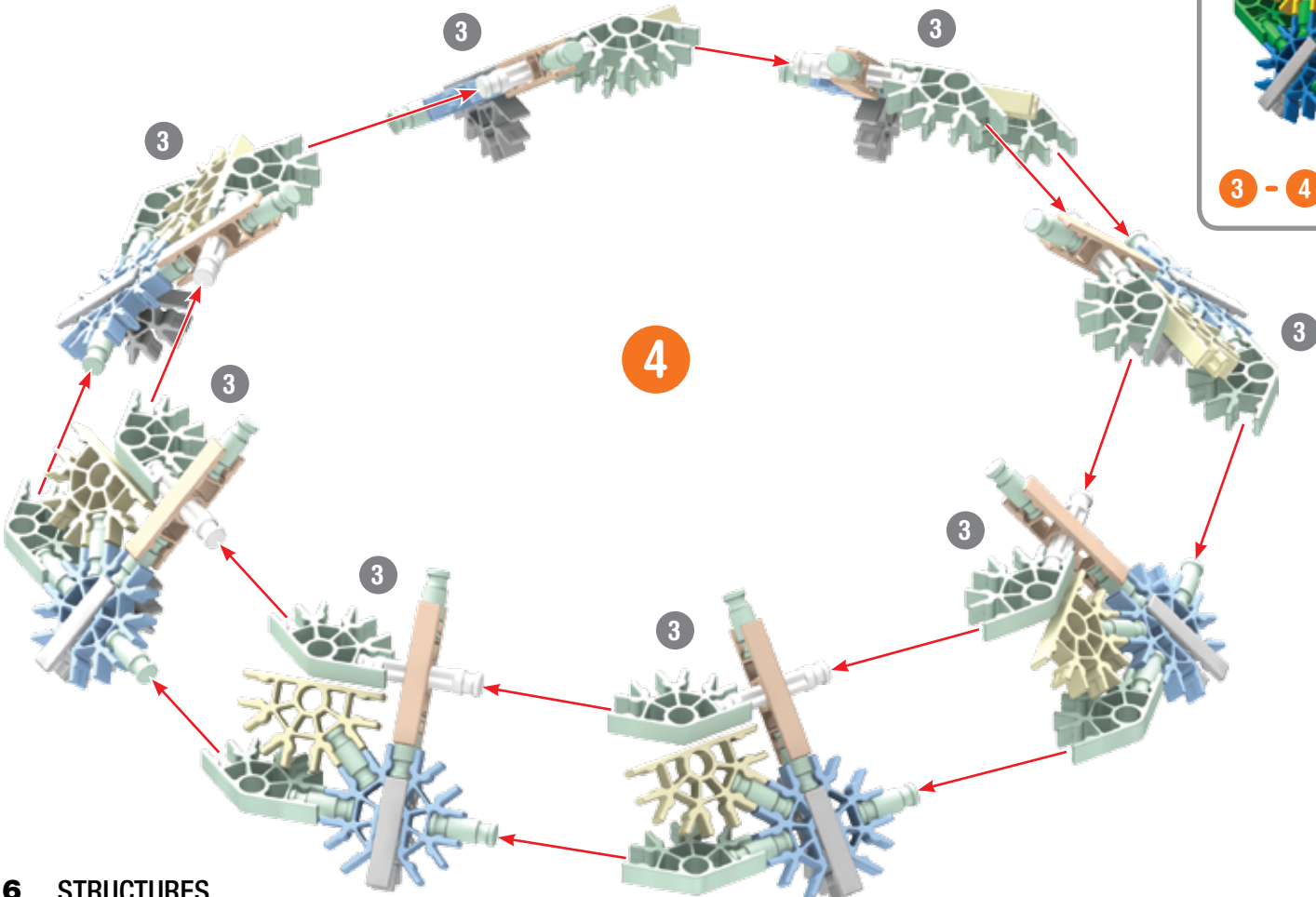
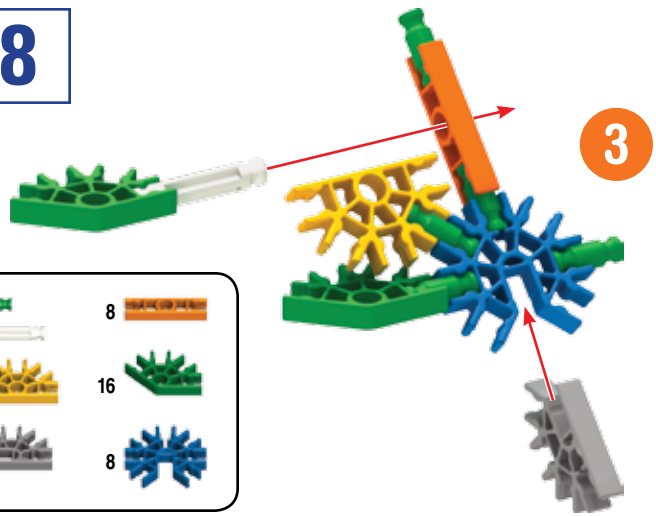

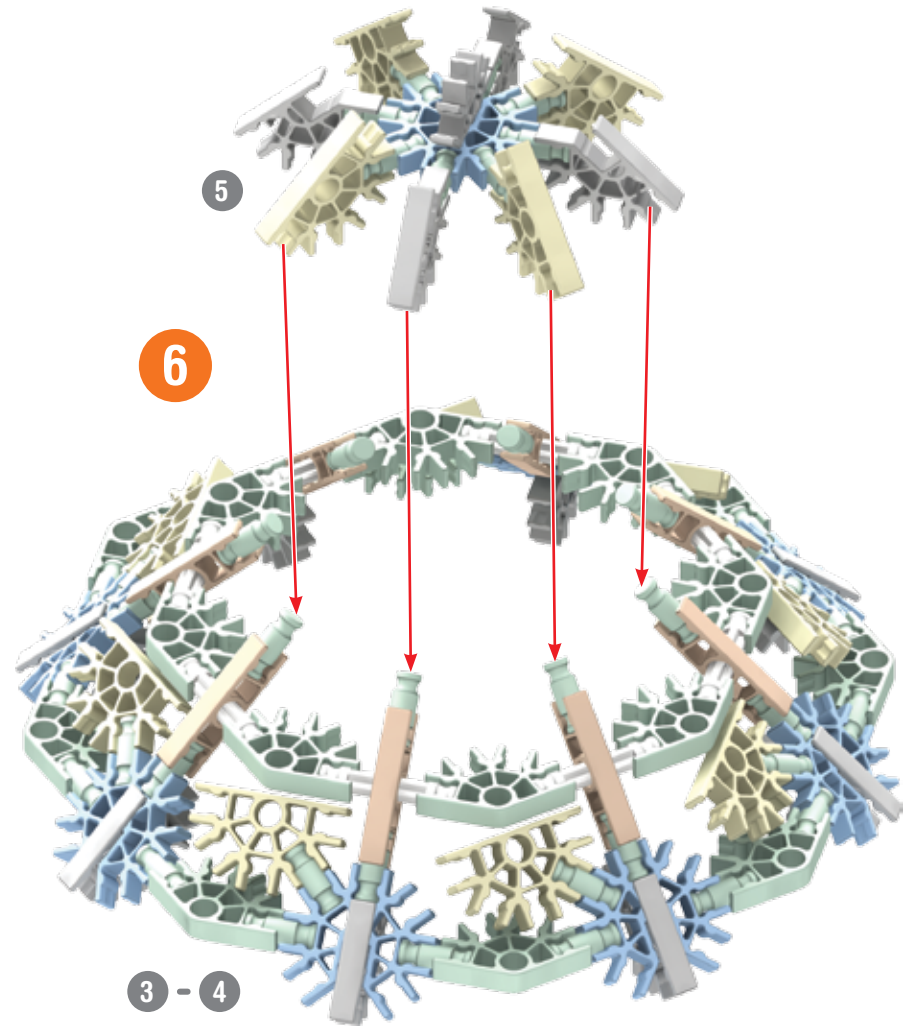
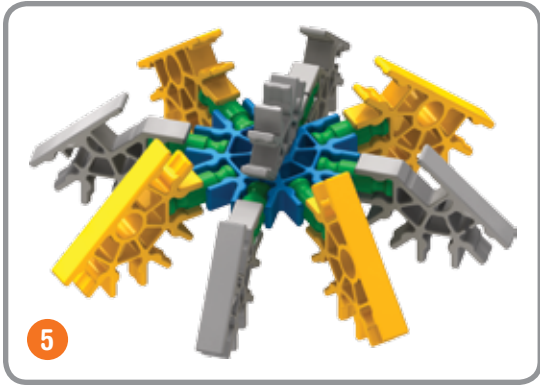
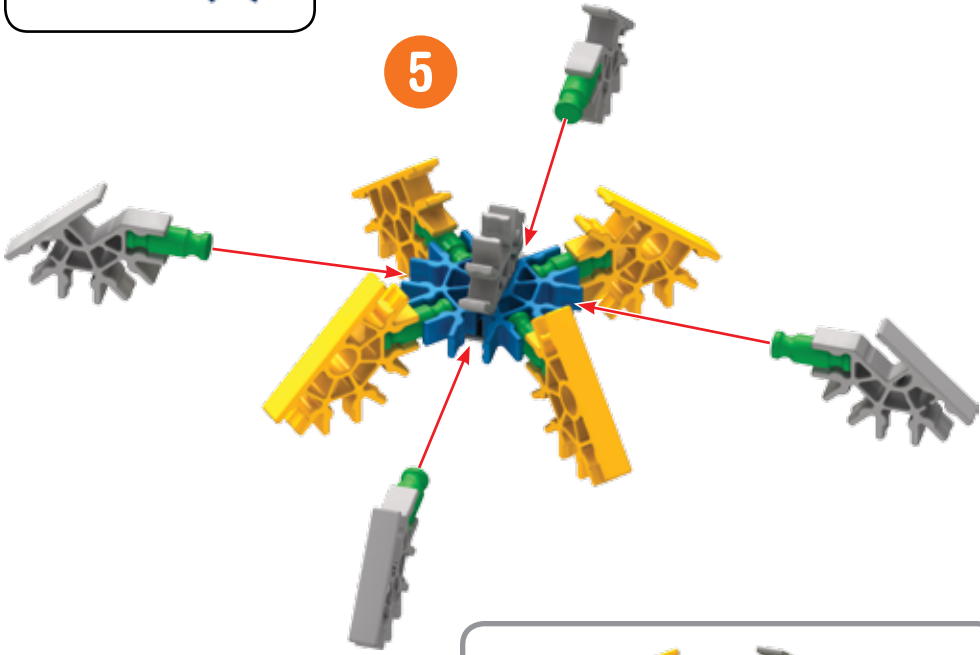
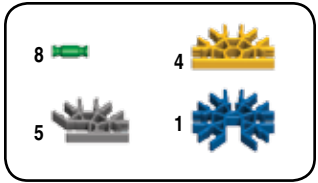

3 - 4

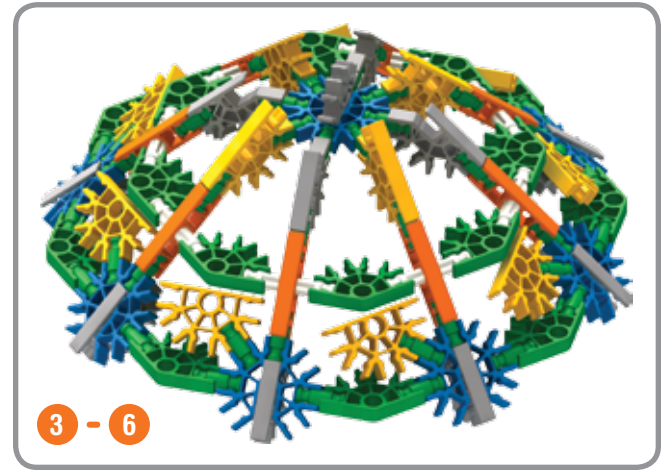

3 - 6

x4

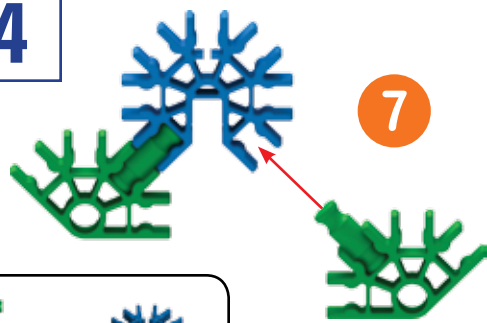

7

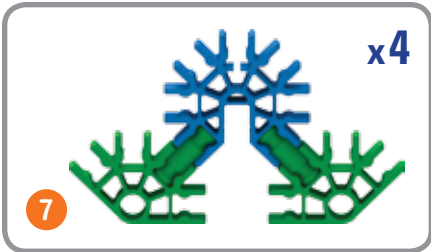

x4

7

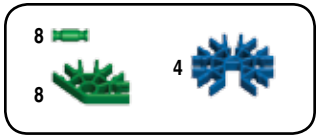

8

8

4

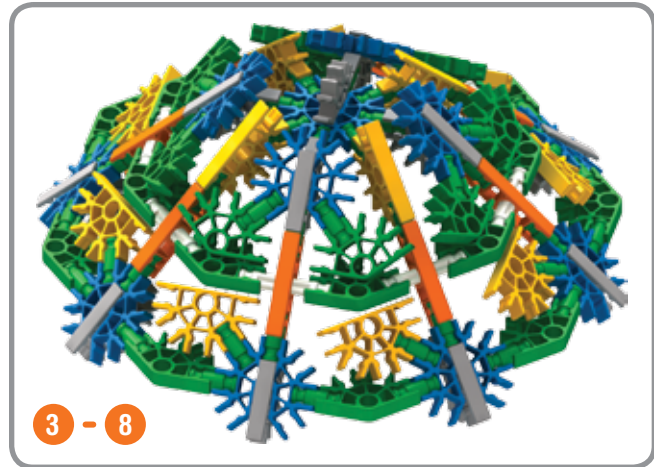

3 - 8

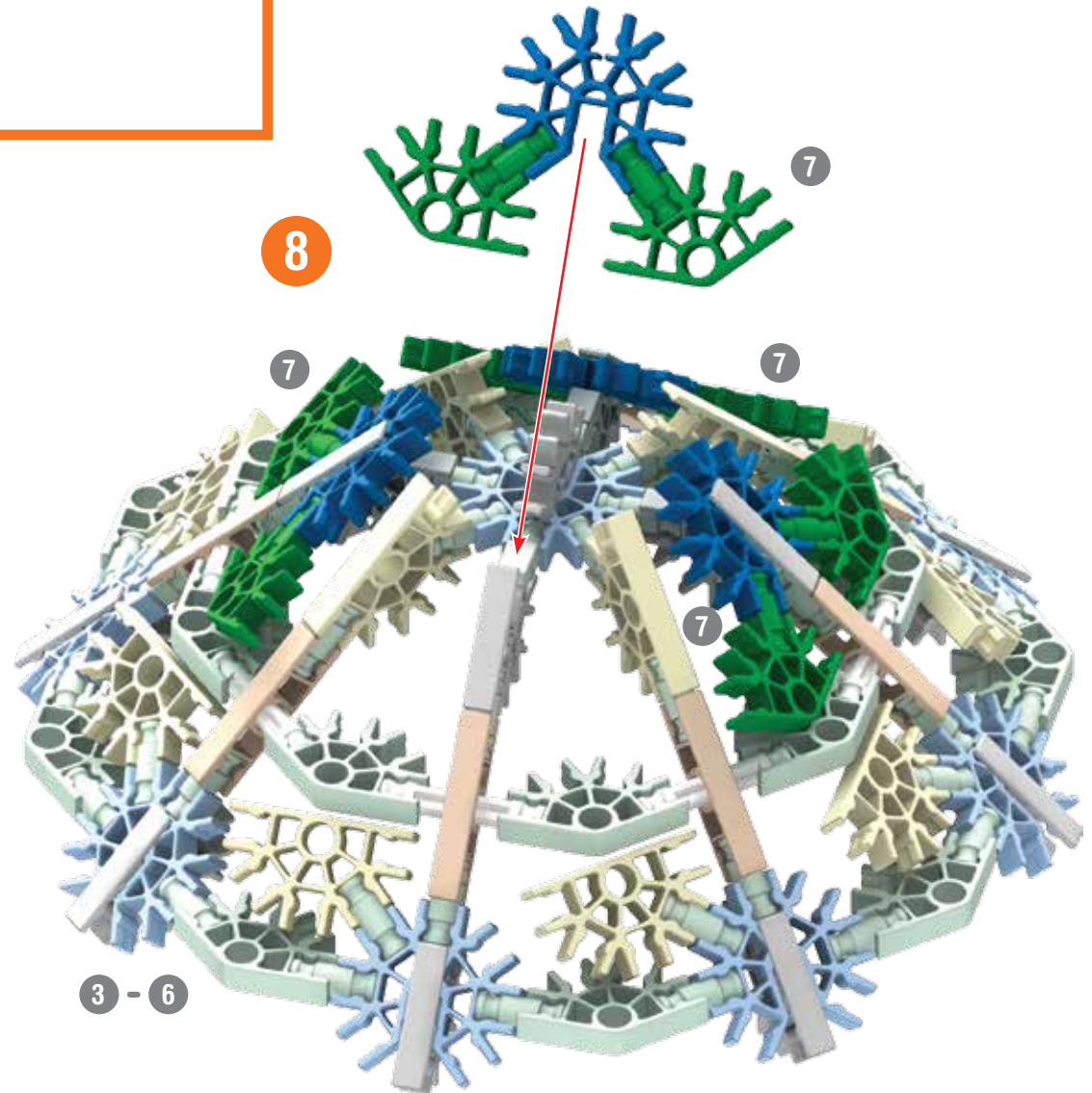

8





7

7

7

7

3 - 6

- 8 
- 1 
- 1  2 

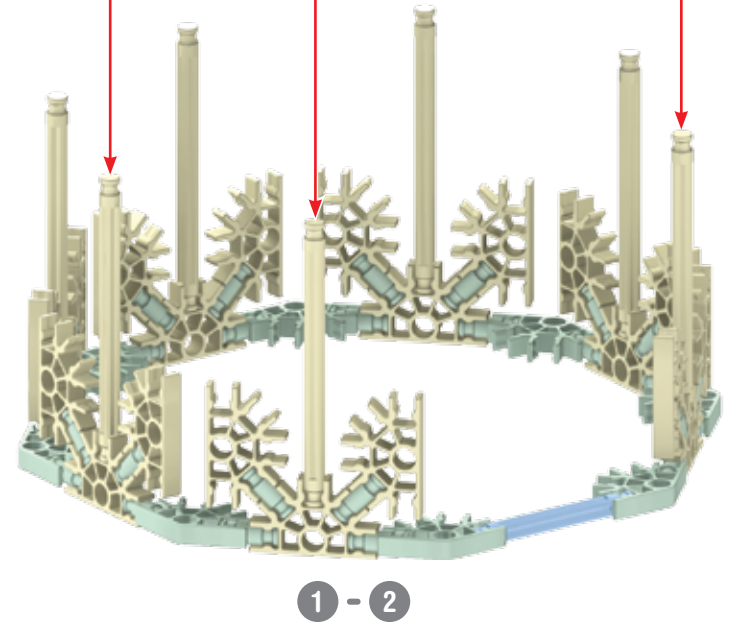
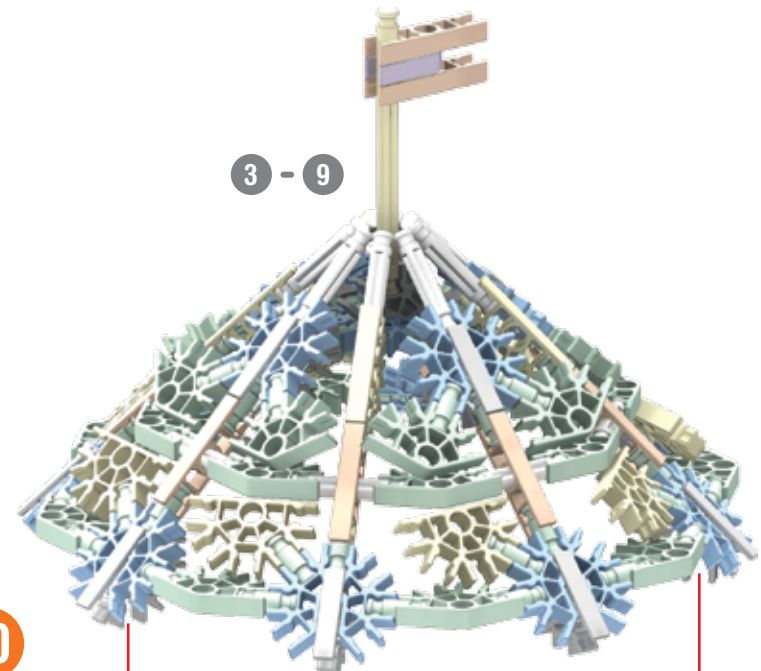
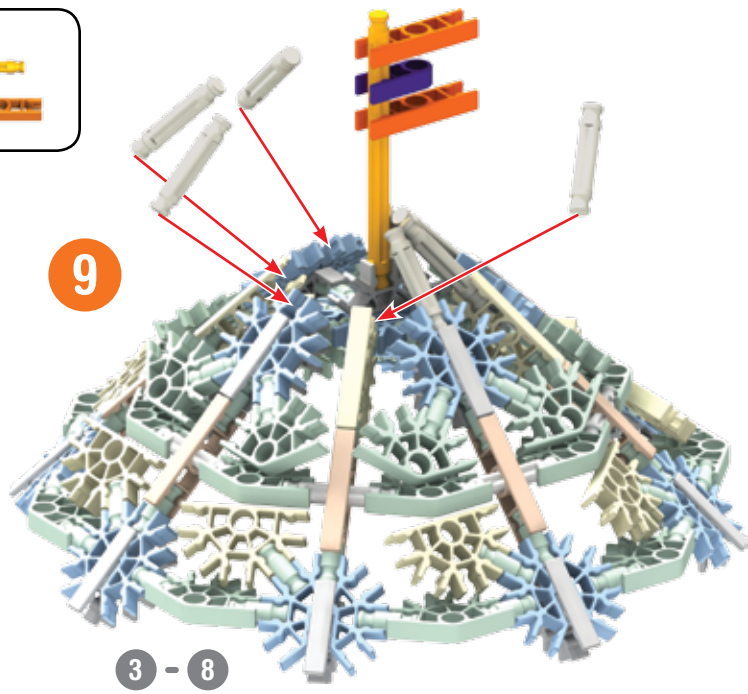

Car Wash

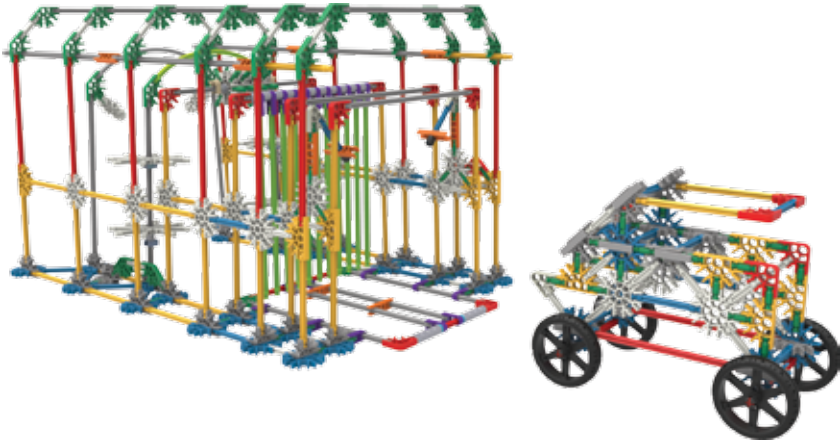

12		2		2		12	
6							
4							
2							
4							
2		8		10		2	
						12	

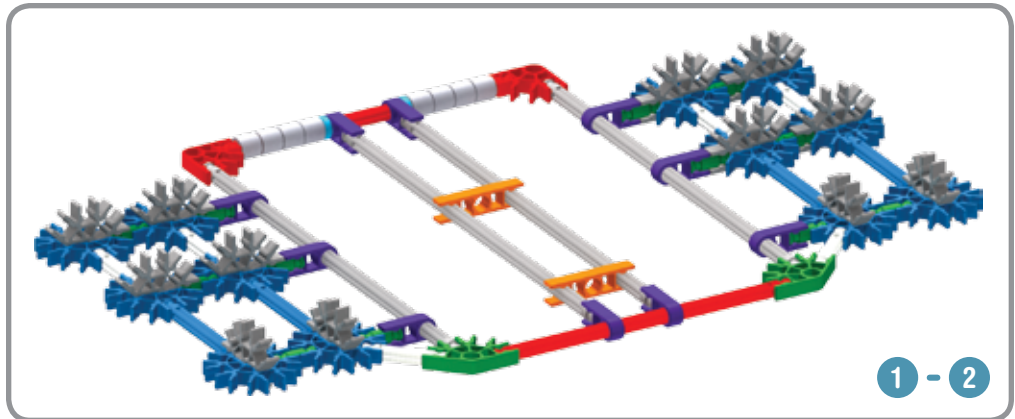
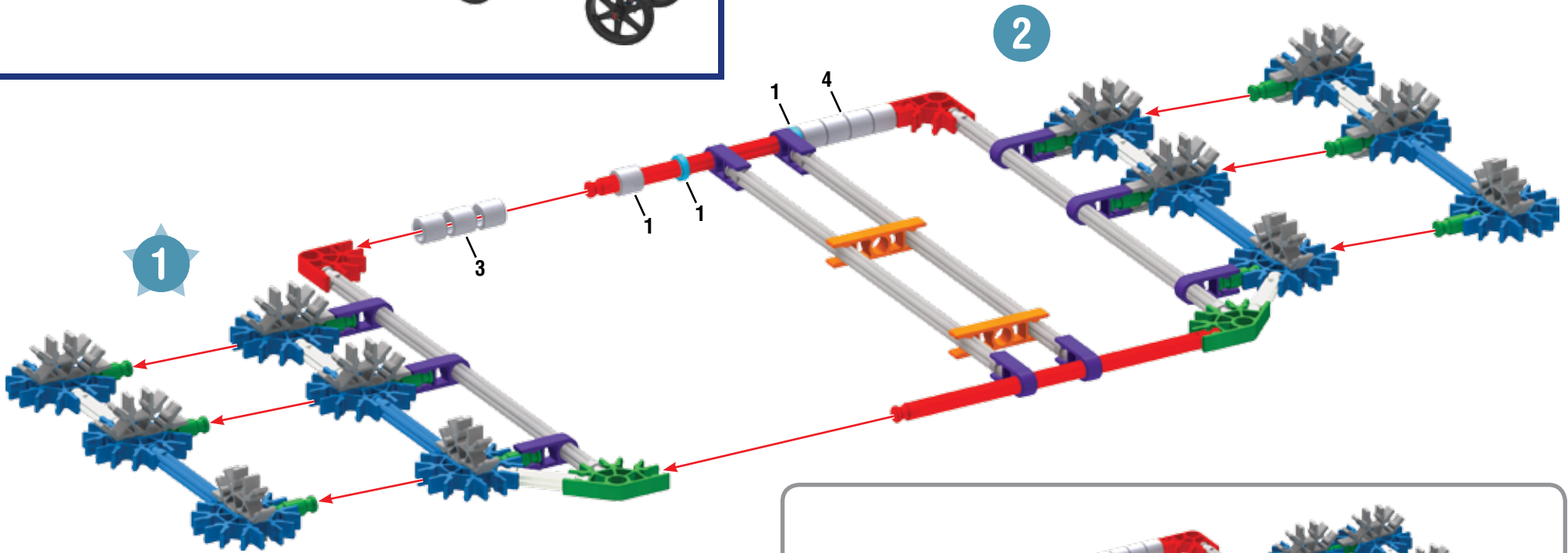

1 - 2

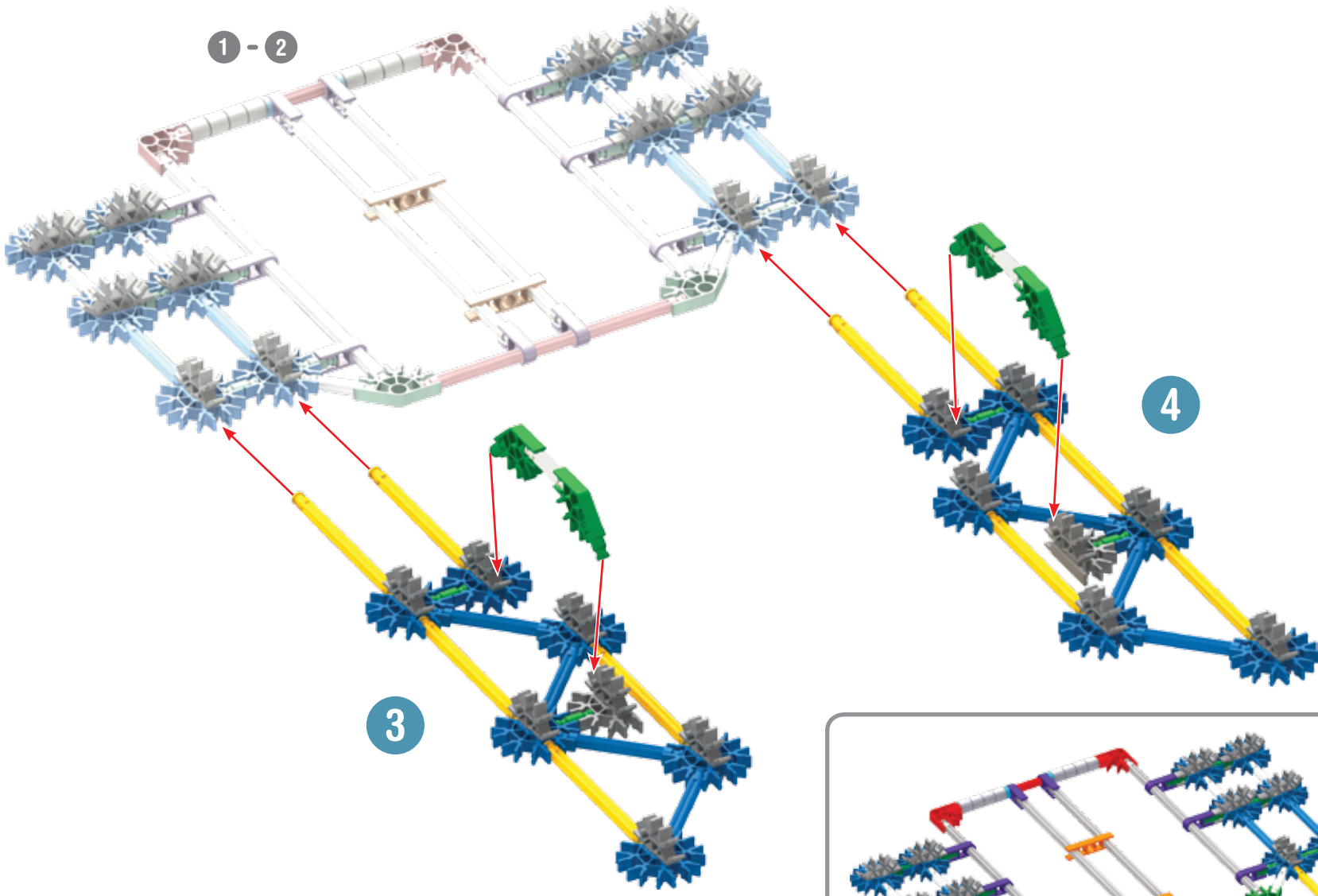

3

4

8		12		4	
2					
8				16	
10					

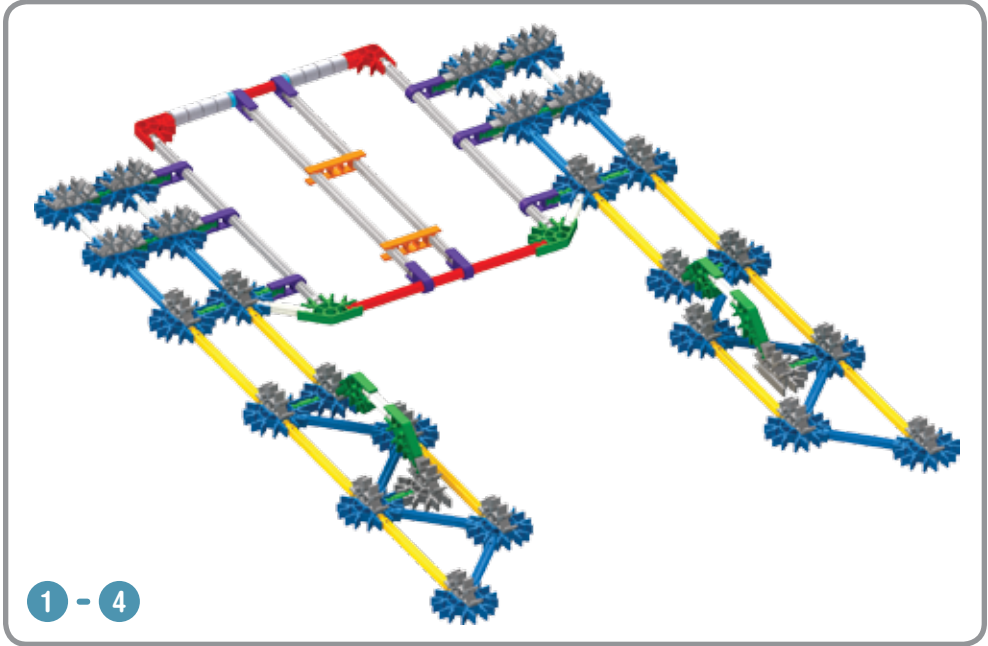

1 - 4

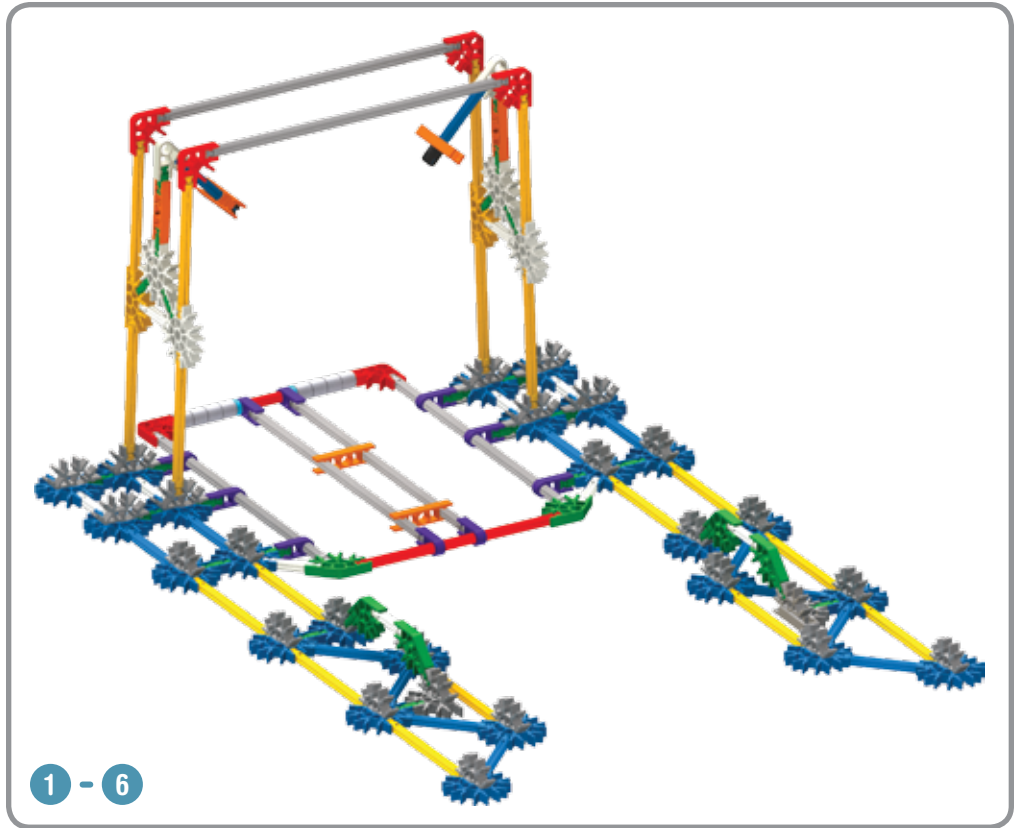
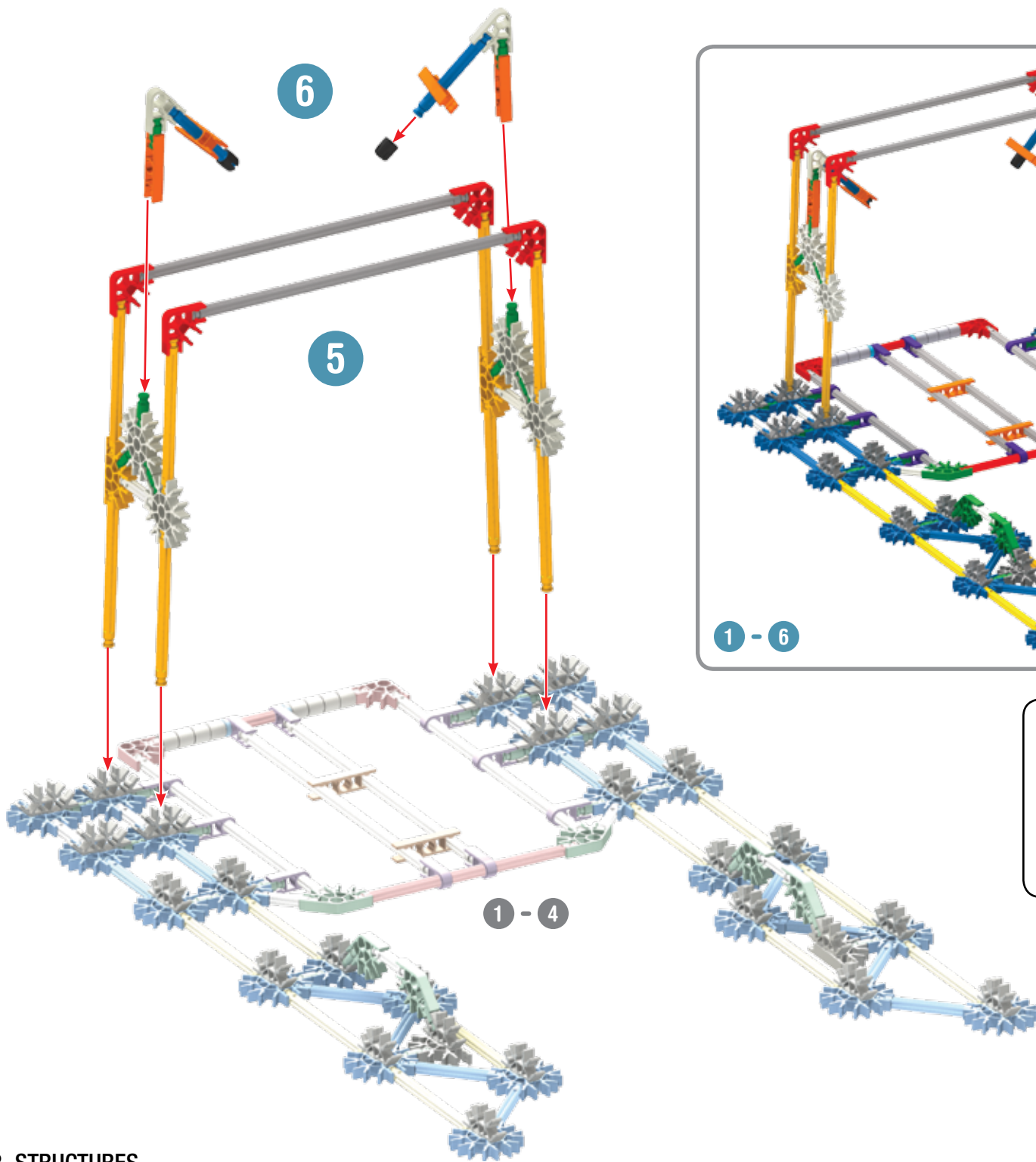

- | | | |
|---|---|---|
| 8 | 2 | 4 |
| 2 | 2 | |
| 2 | | 2 |
| 8 | | |
| 2 | | |
| 4 | 2 | 4 |

8

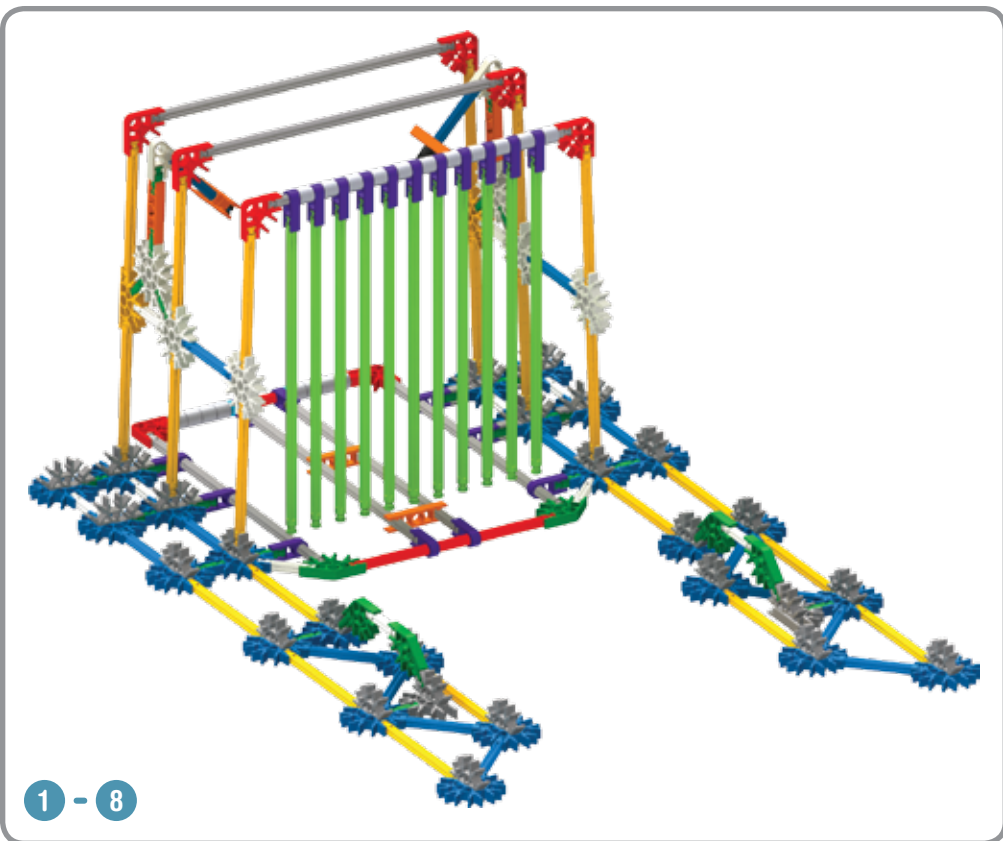
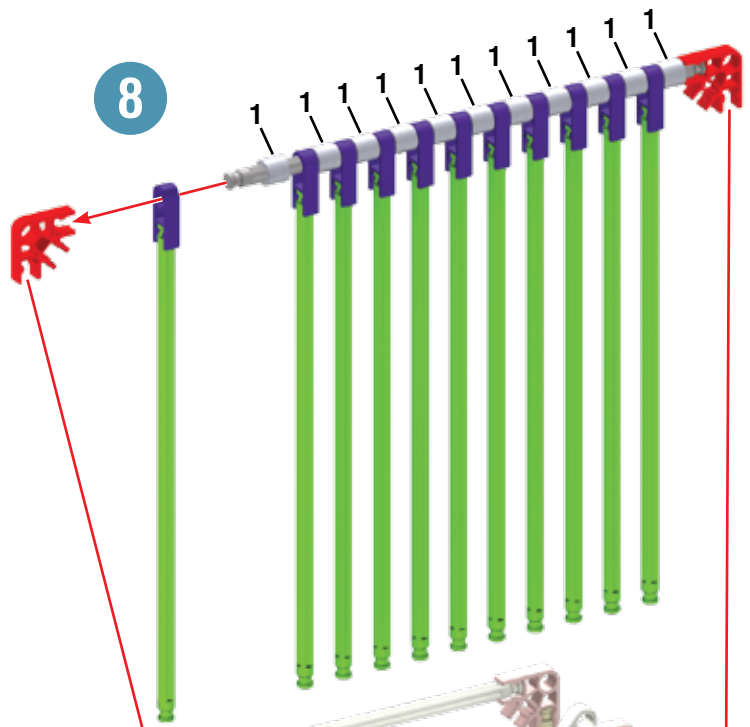

1 - 8

7

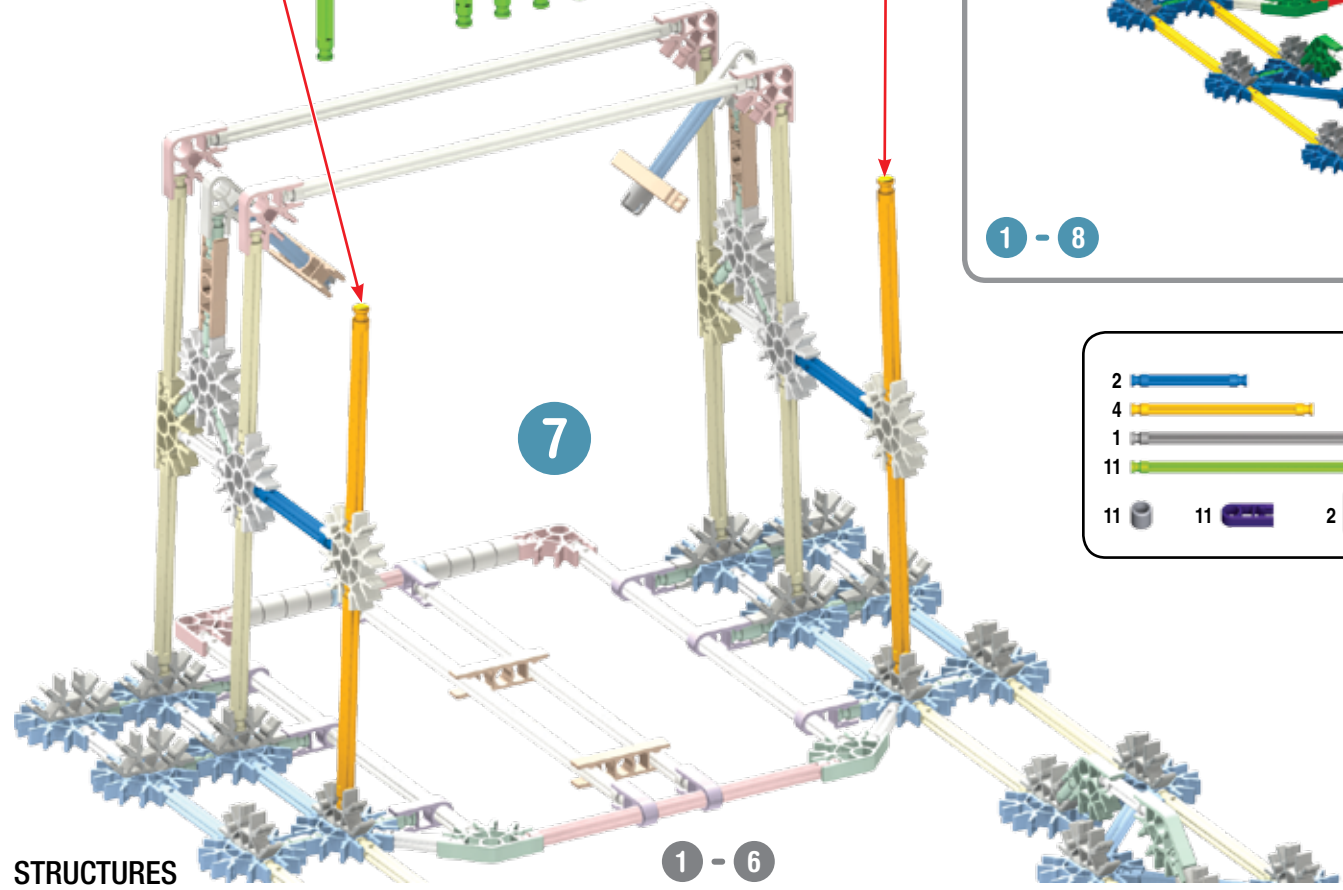

1 - 6

- | | | | |
|----|--|----|--|
| 2 | | 2 | |
| 4 | | | |
| 1 | | | |
| 11 | | | |
| 11 | | 11 | |
| | | 2 | |

10

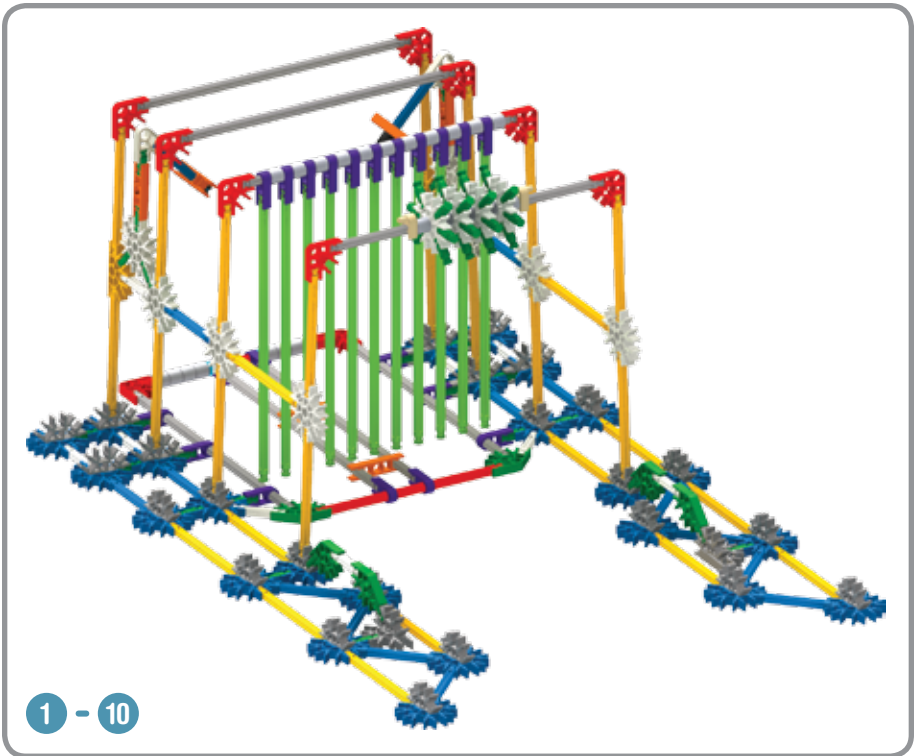
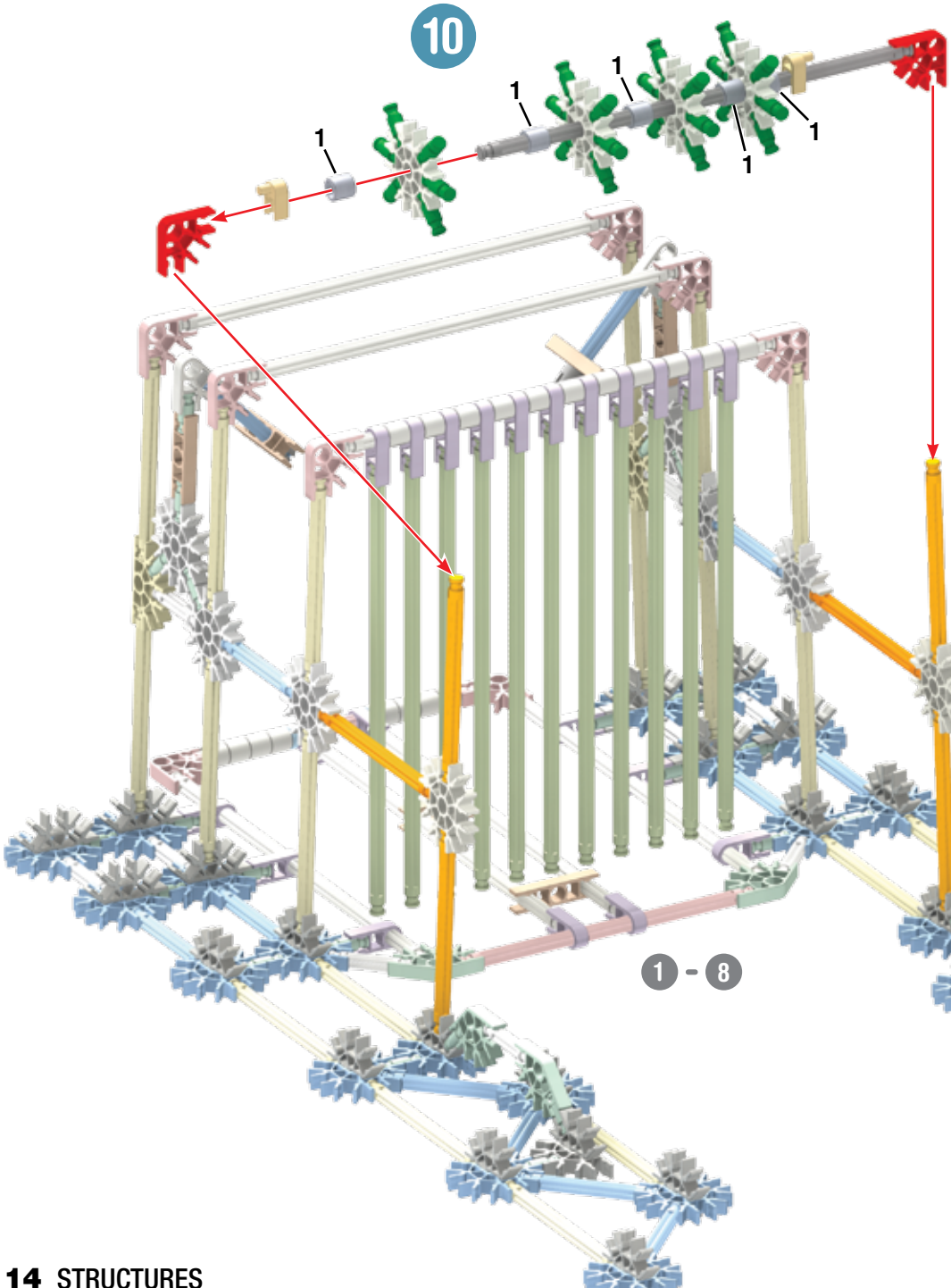







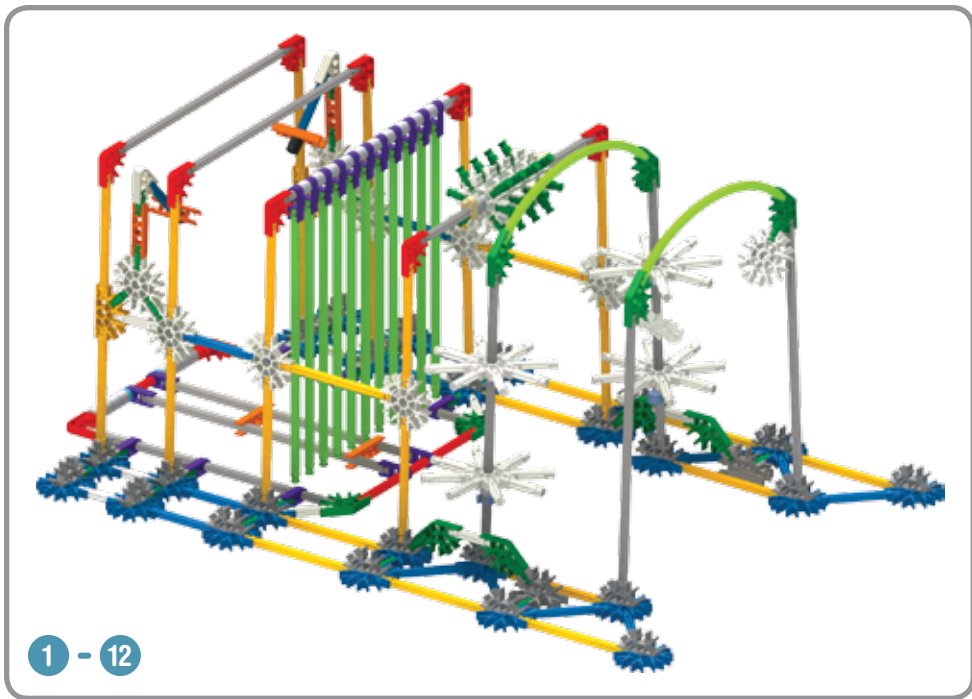

1 - 10

9

- 24
- 6
- 1
- 5
- 2
- 2
- 6

1 - 8



- 2 
- 32 
- 4 
- 2 
- 2 
- 4 
- 4 
- 6 

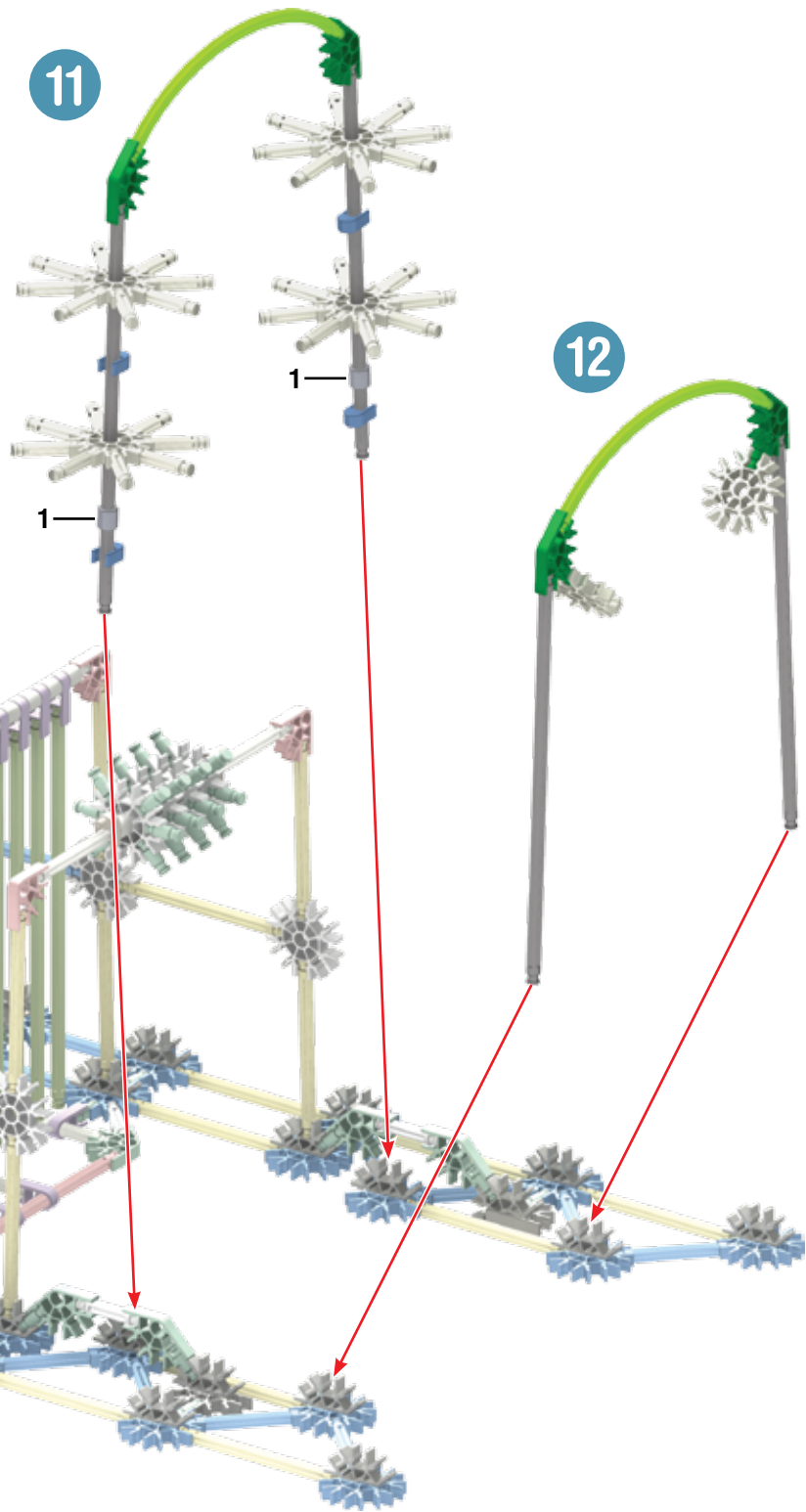

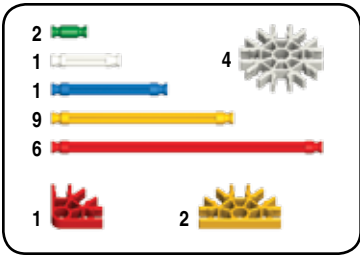

13

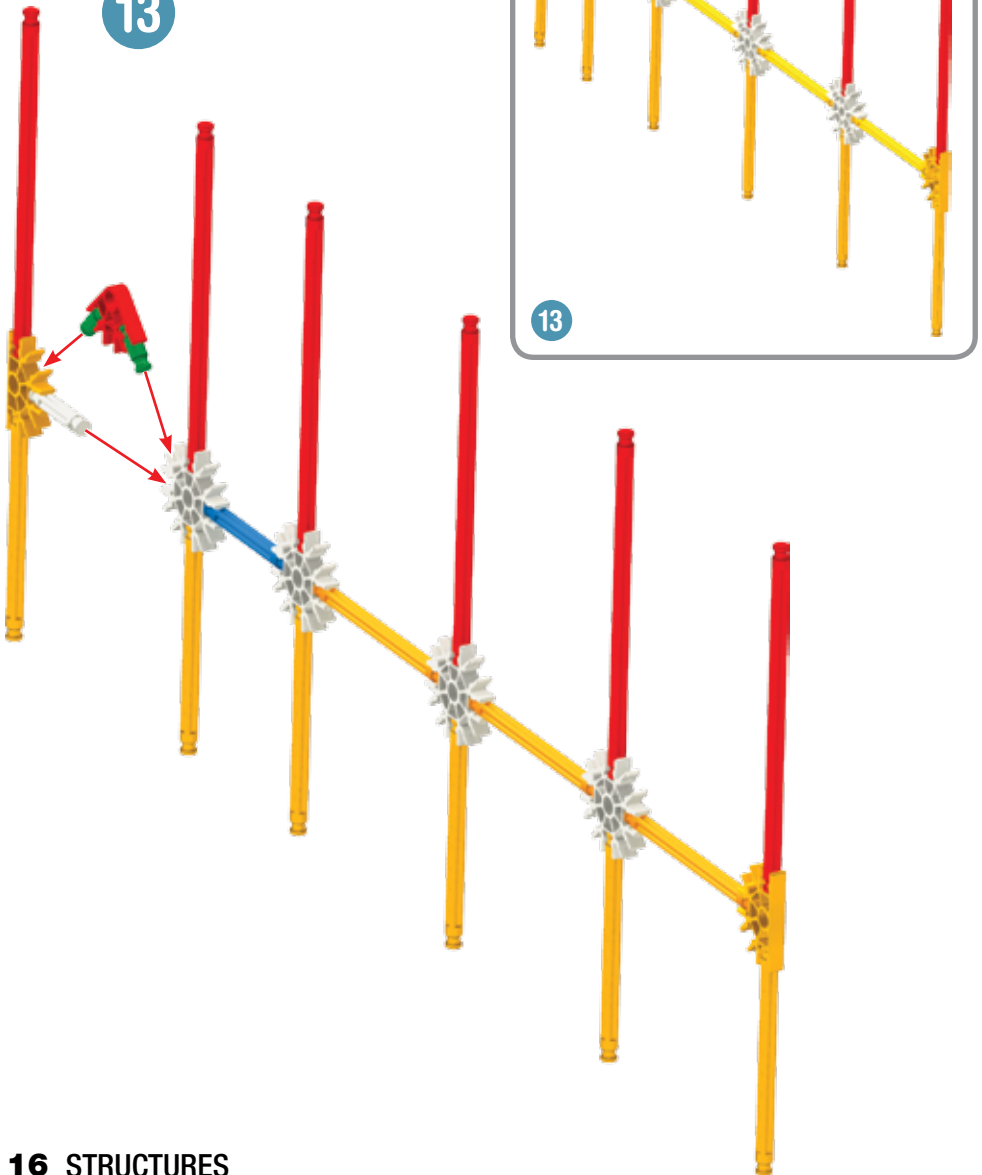

13

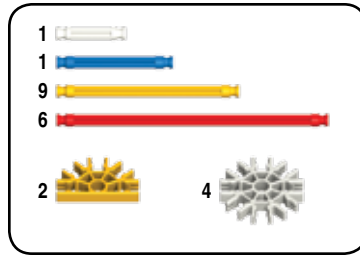

14

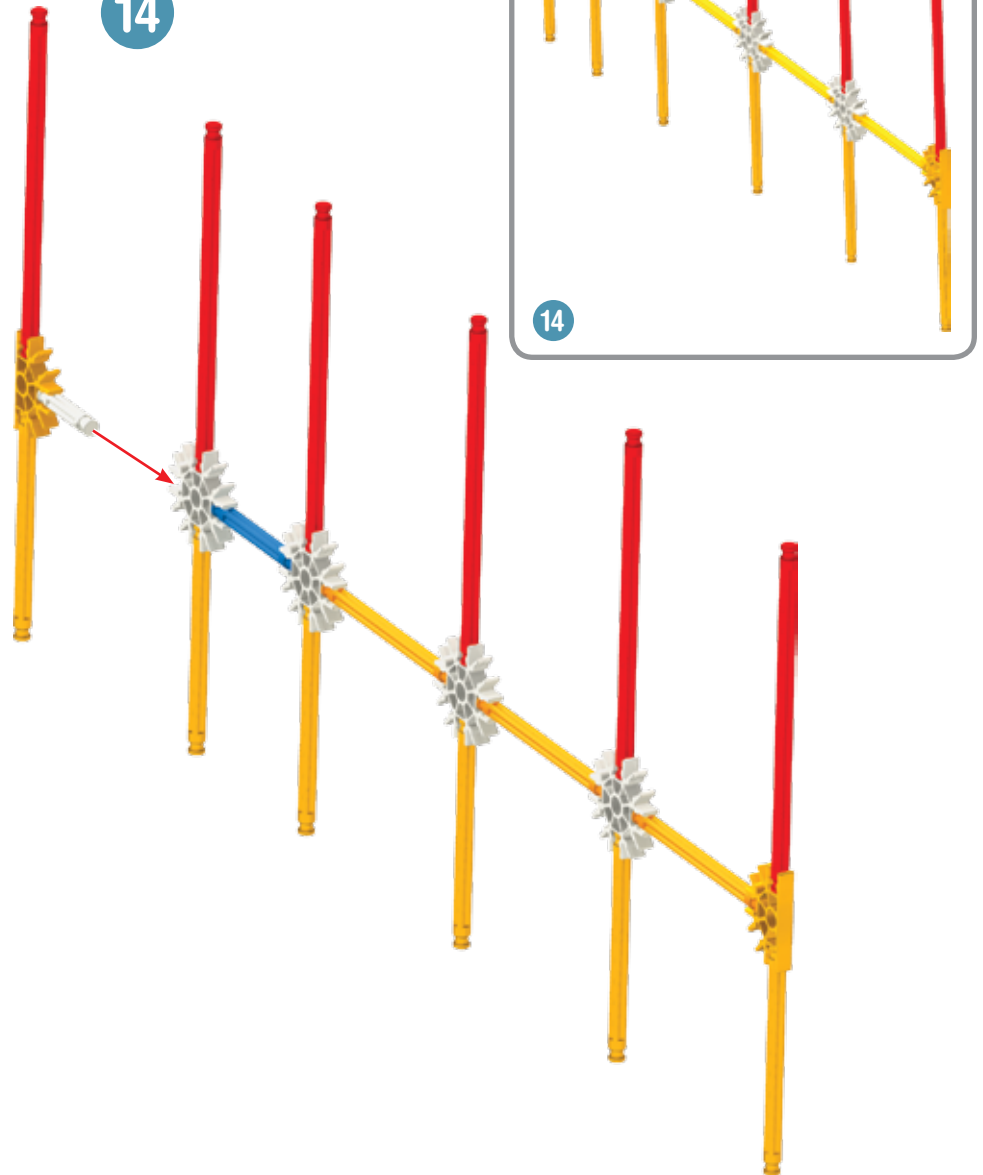

14

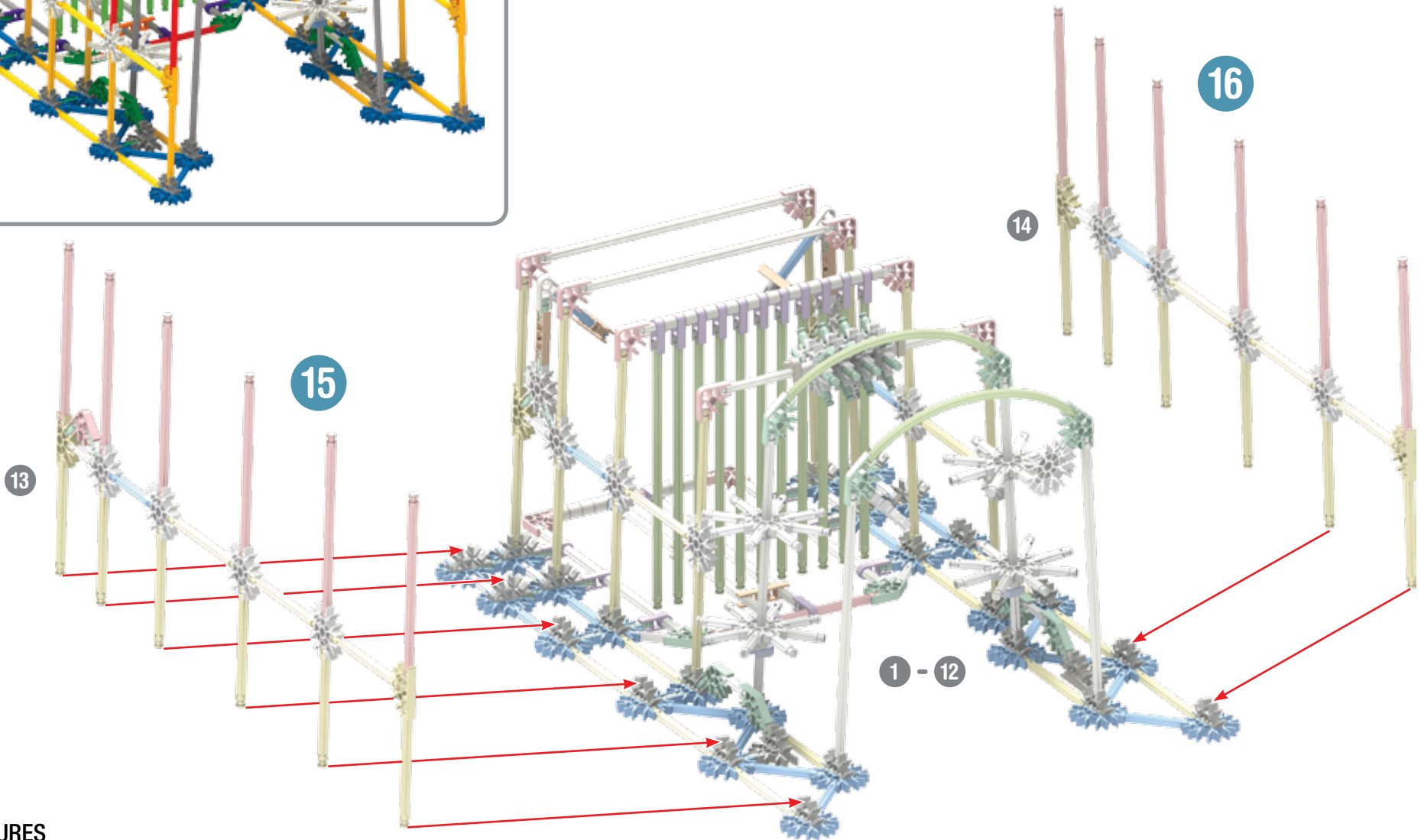
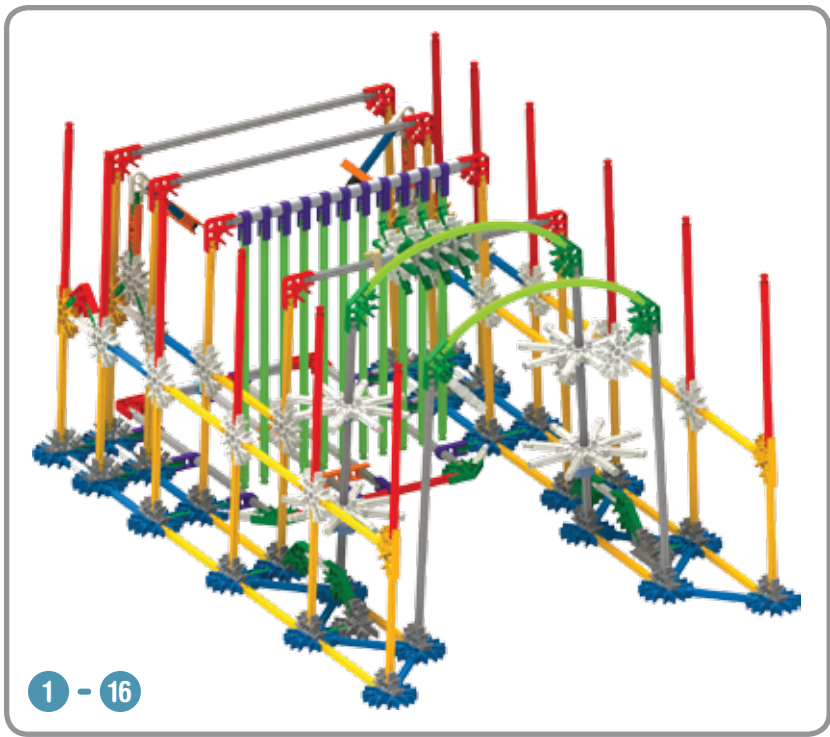

x6



x6

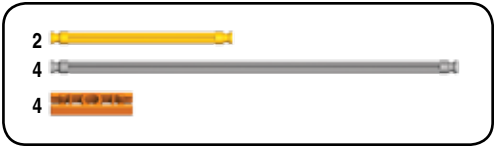
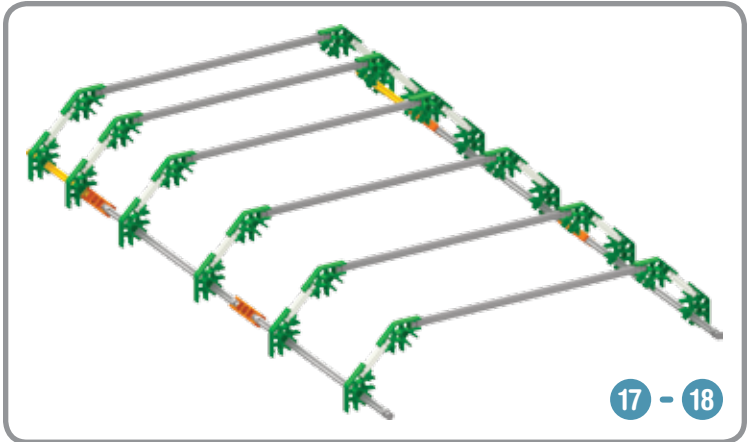
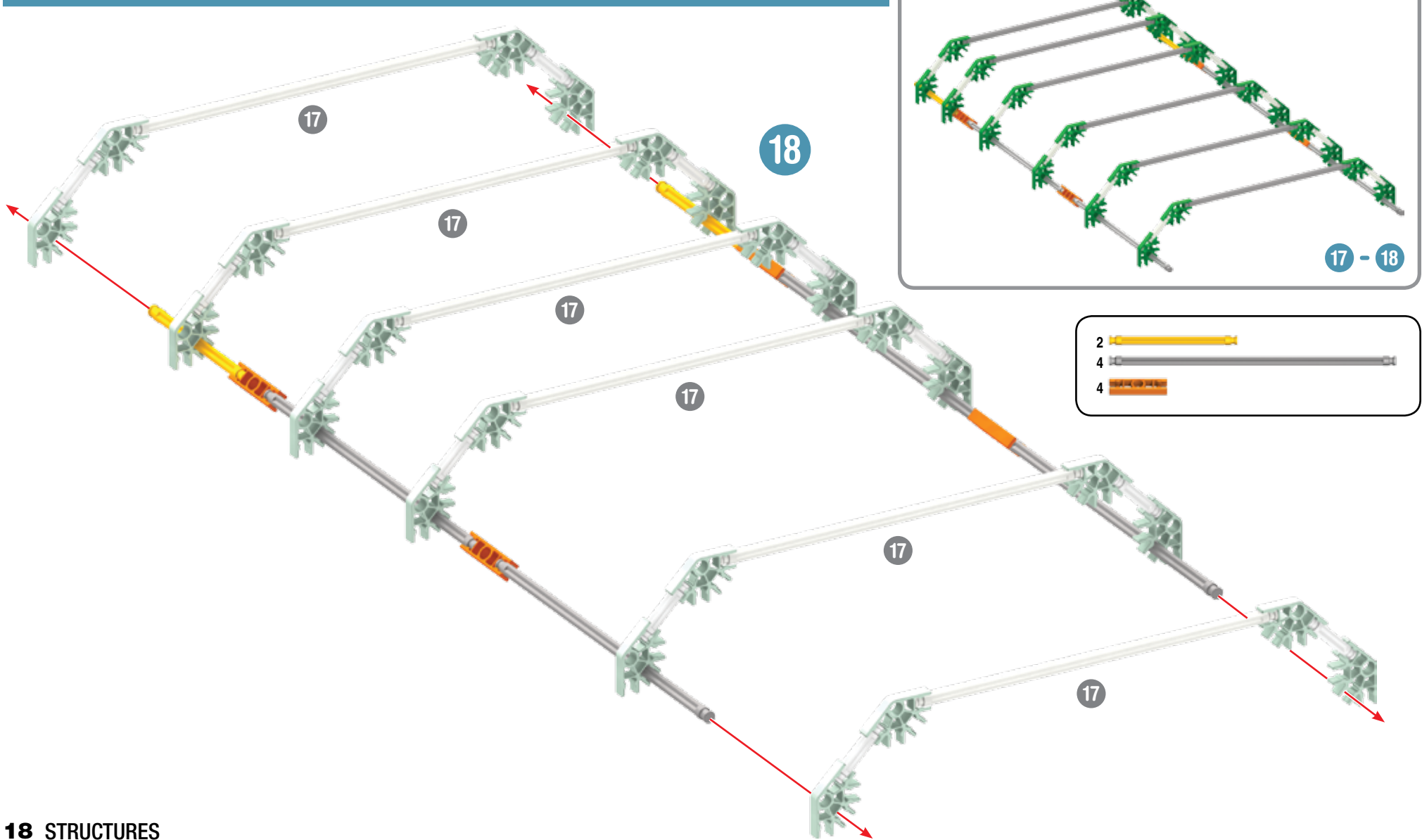
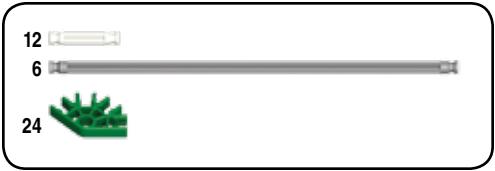

17 - 18

19

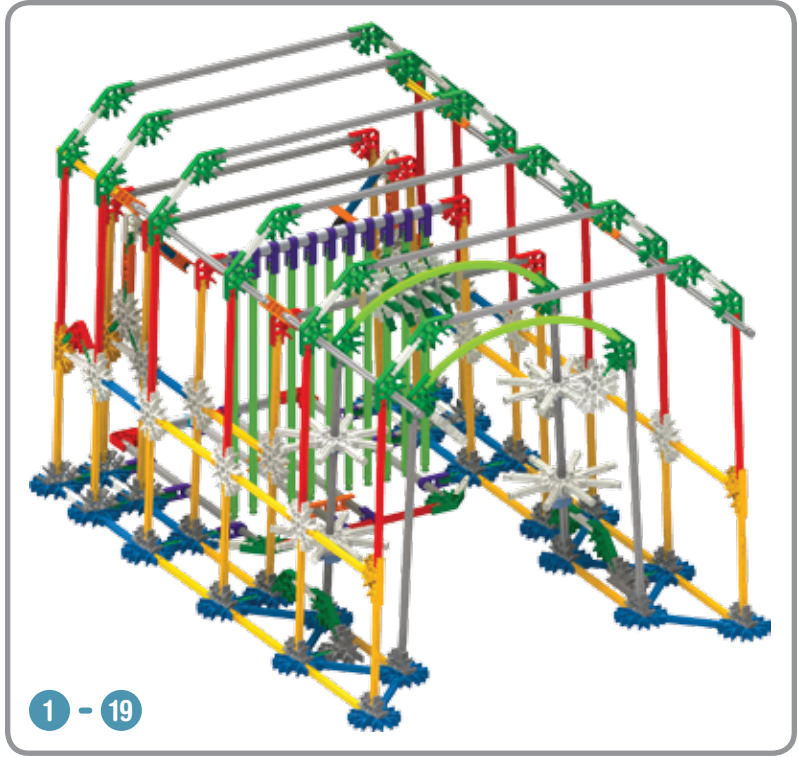
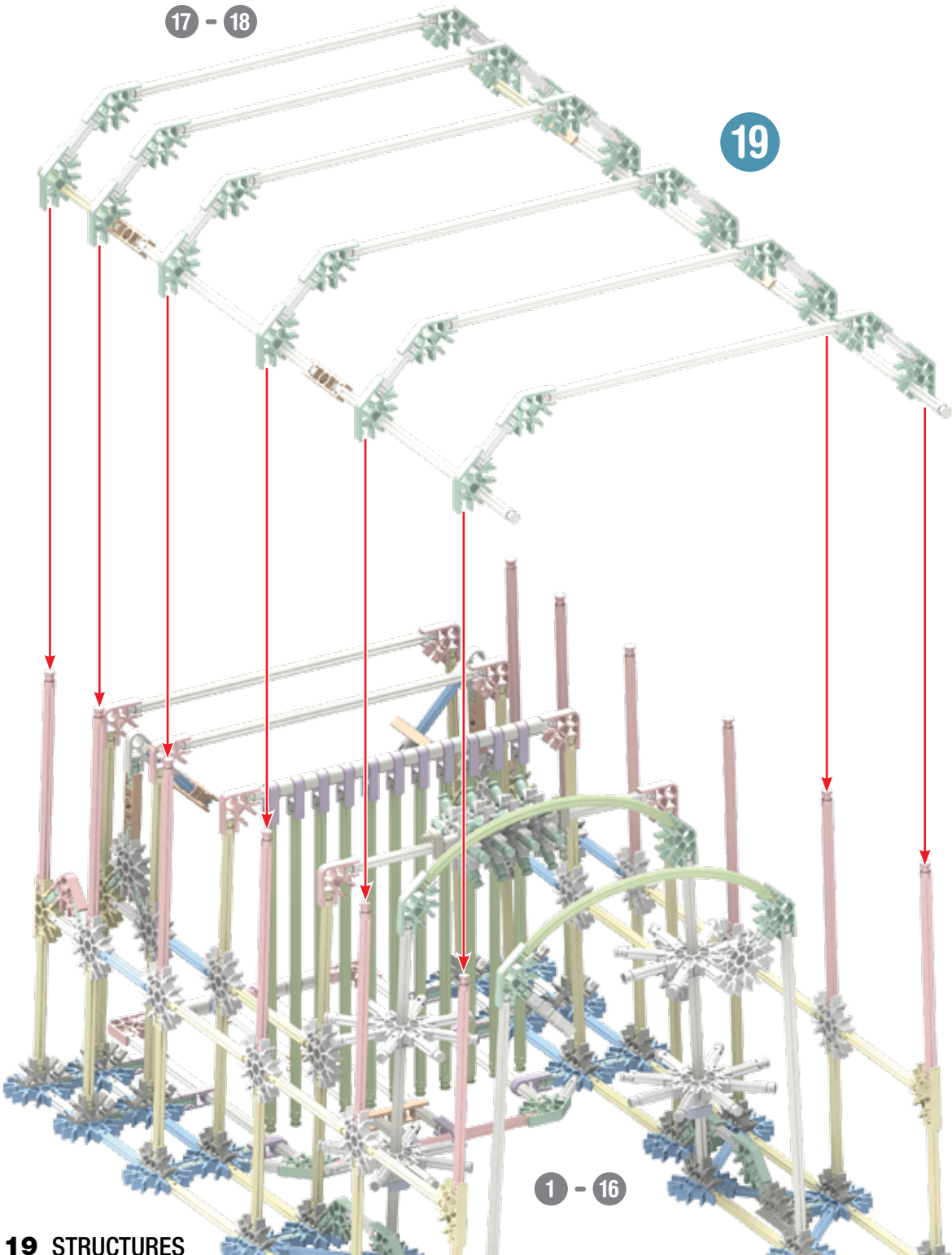

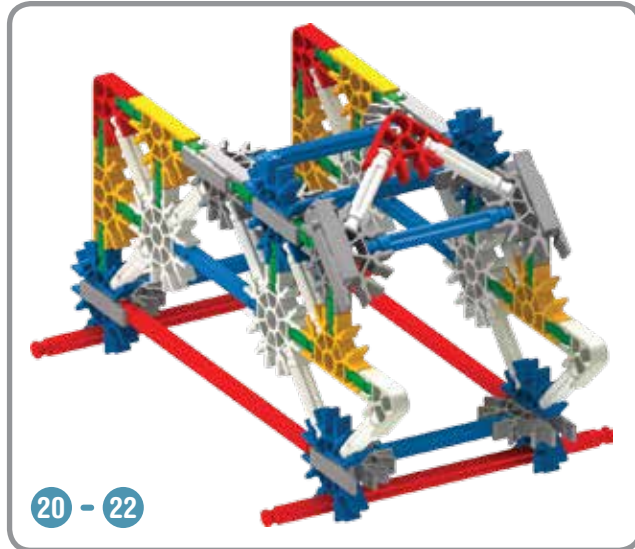
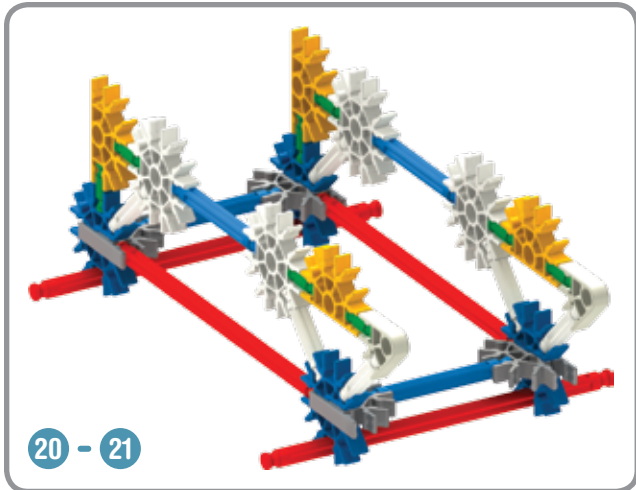
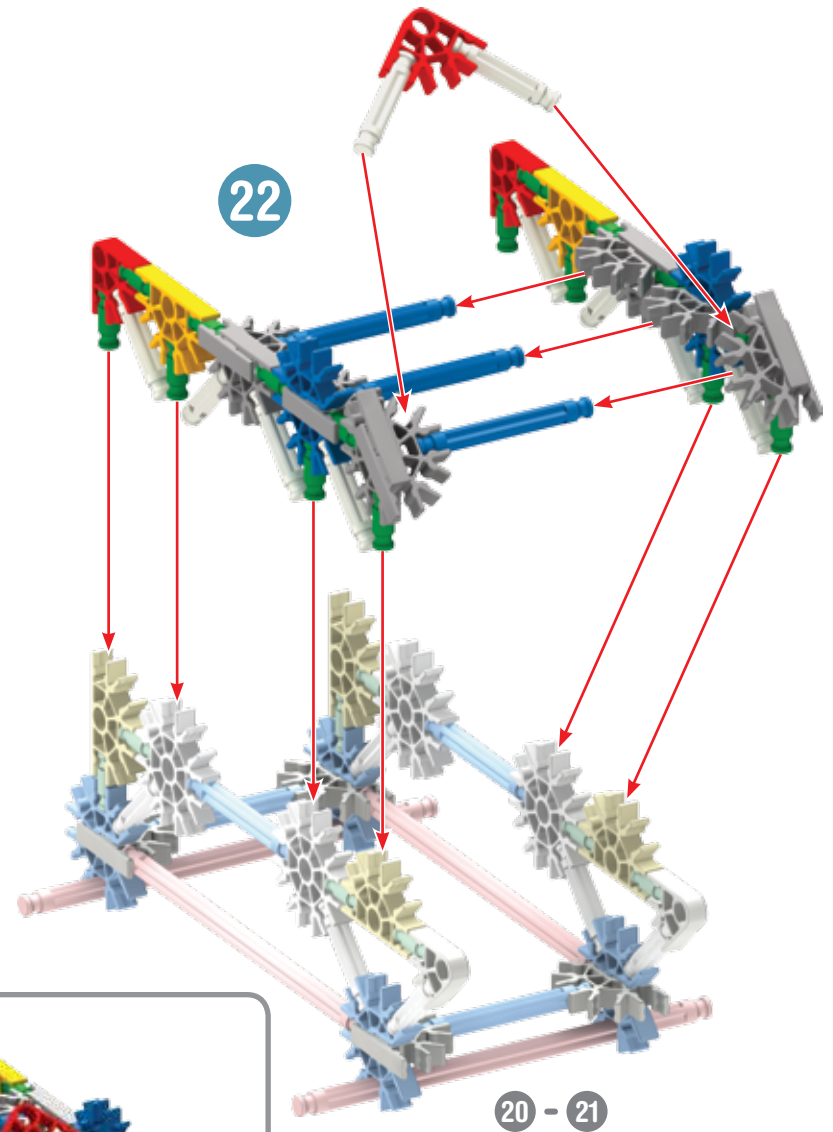
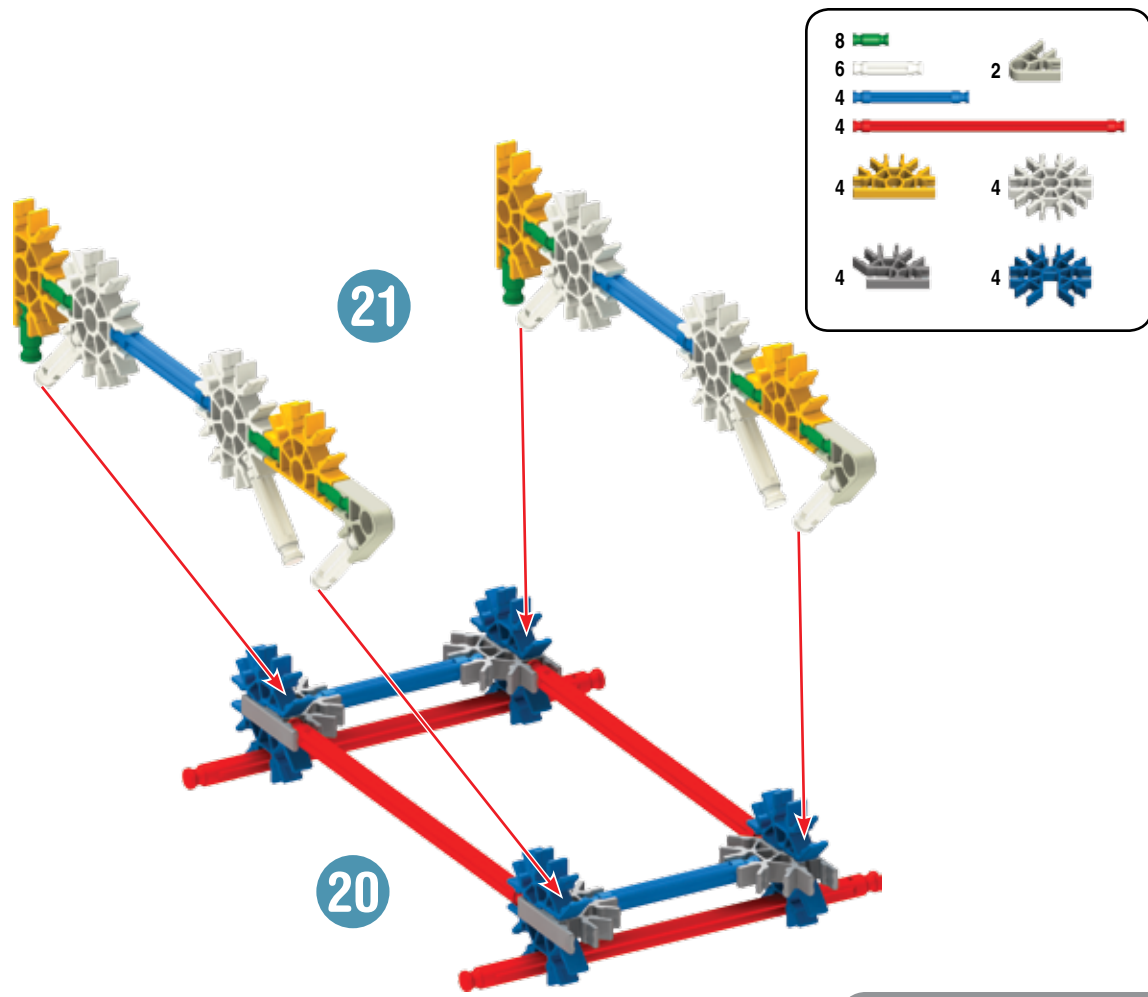

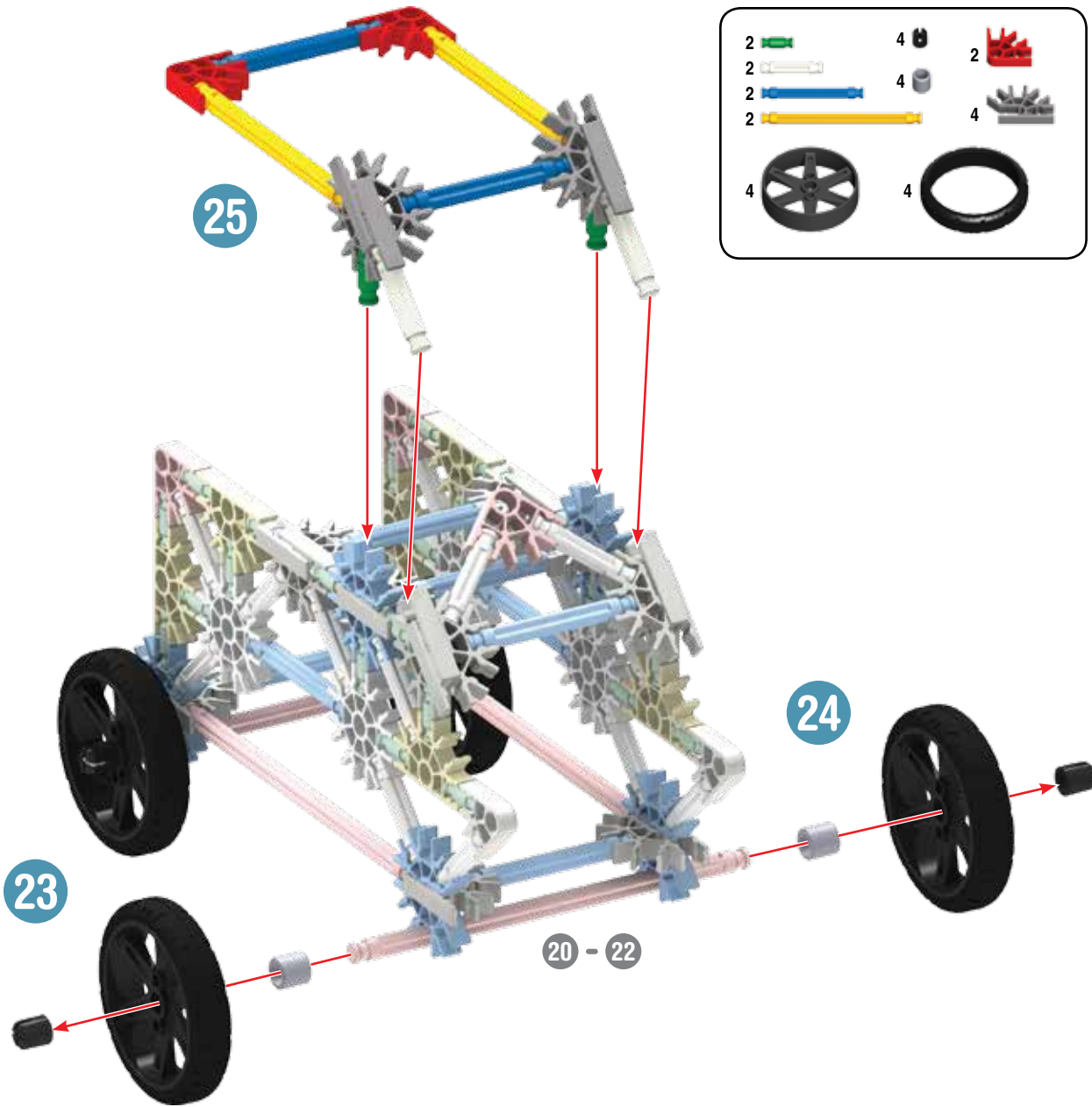

- | | | | | | |
|---|--|---|--|---|--|
| 2 | | 4 | | 2 | |
| 2 | | 4 | | 4 | |
| 2 | | 4 | | 4 | |
| 2 | | 4 | | | |

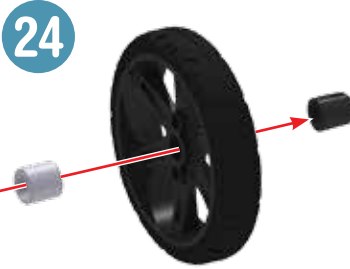
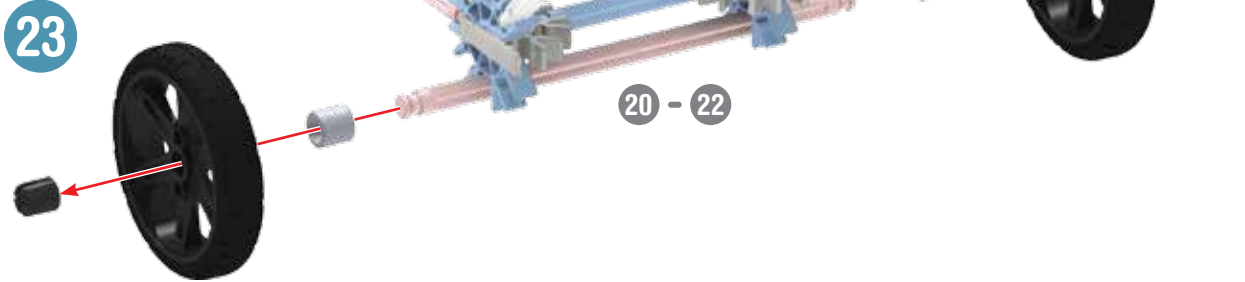

Castle

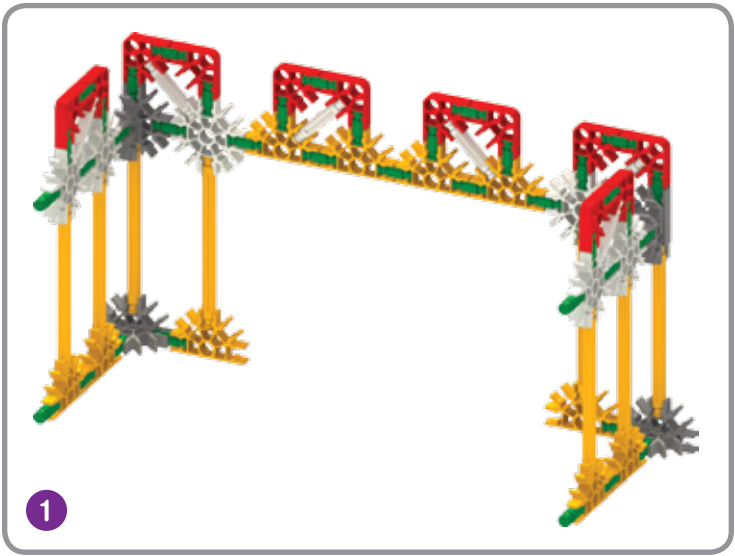
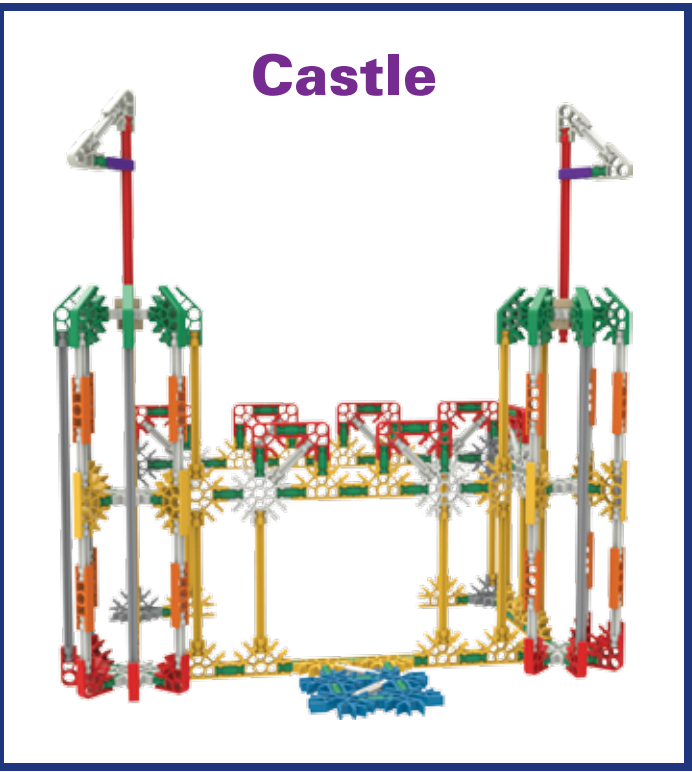

- | | | | | |
|----|--|----|--|--|
| 39 | | 12 | | |
| 6 | | | | |
| 8 | | 6 | | |
| 10 | | 8 | | |

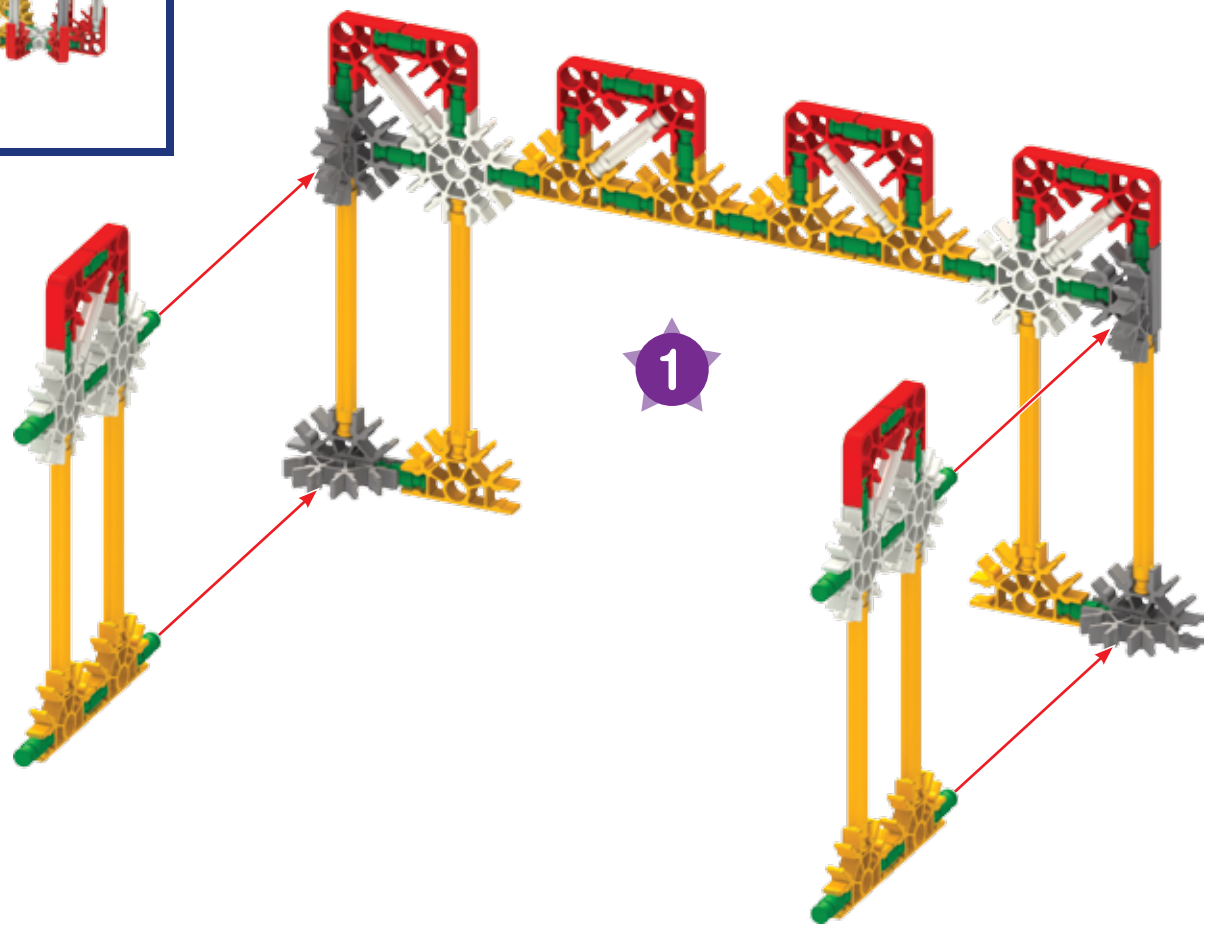

x2

- 20
- 24
- 8
- 4
- 12
- 10
- 14
- 4

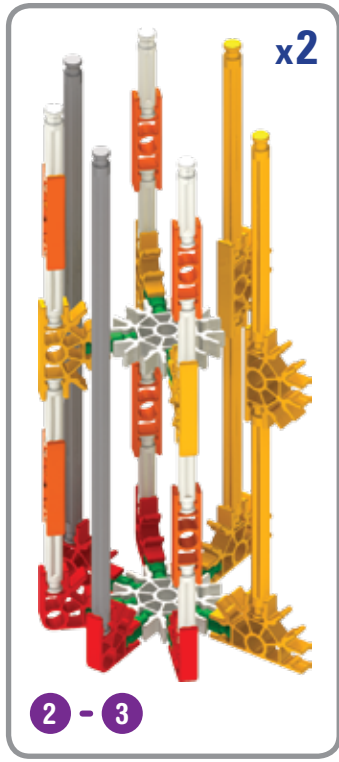
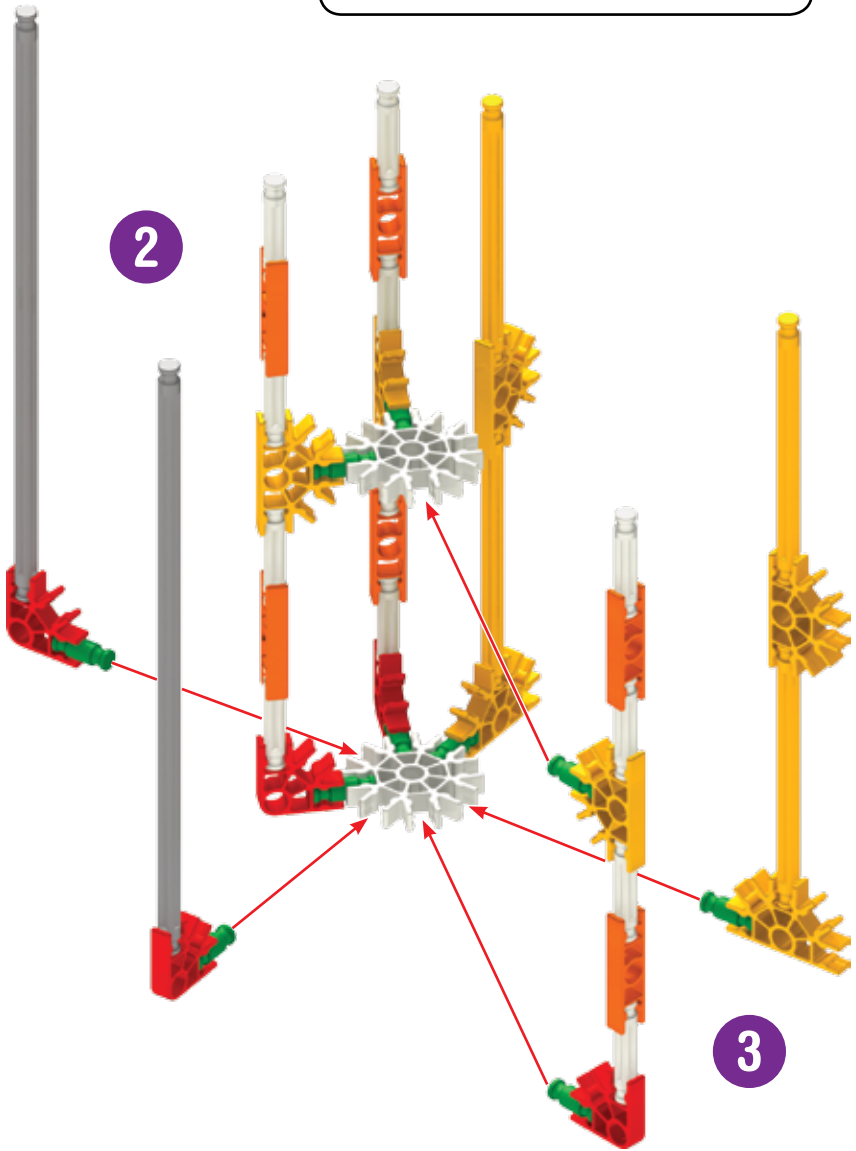

x2

4

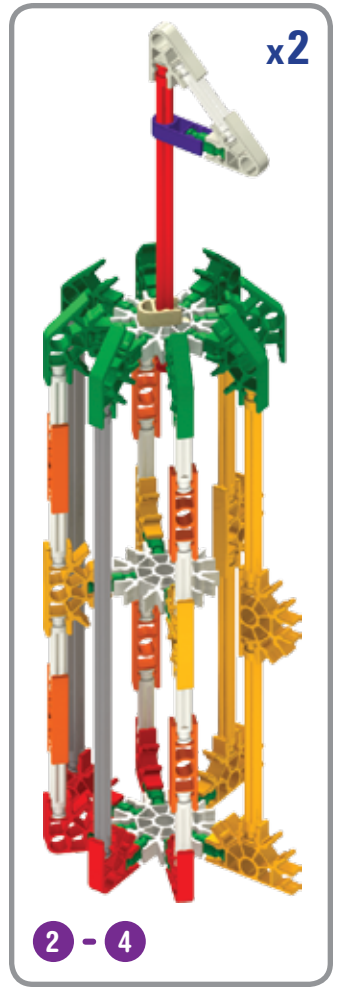
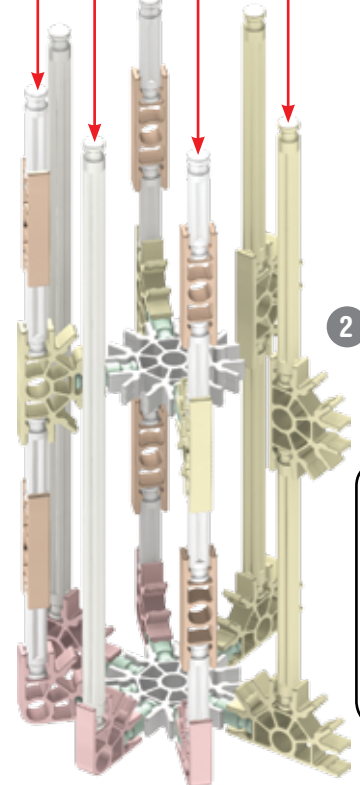

- 18
- 2
- 2
- 16
- 4
- 4
- 4
- 2
- 2

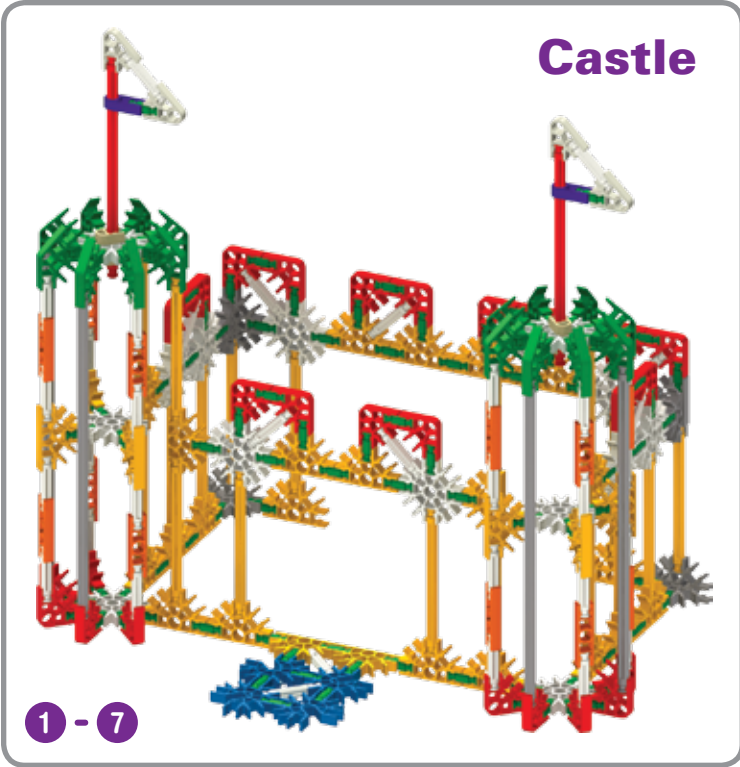
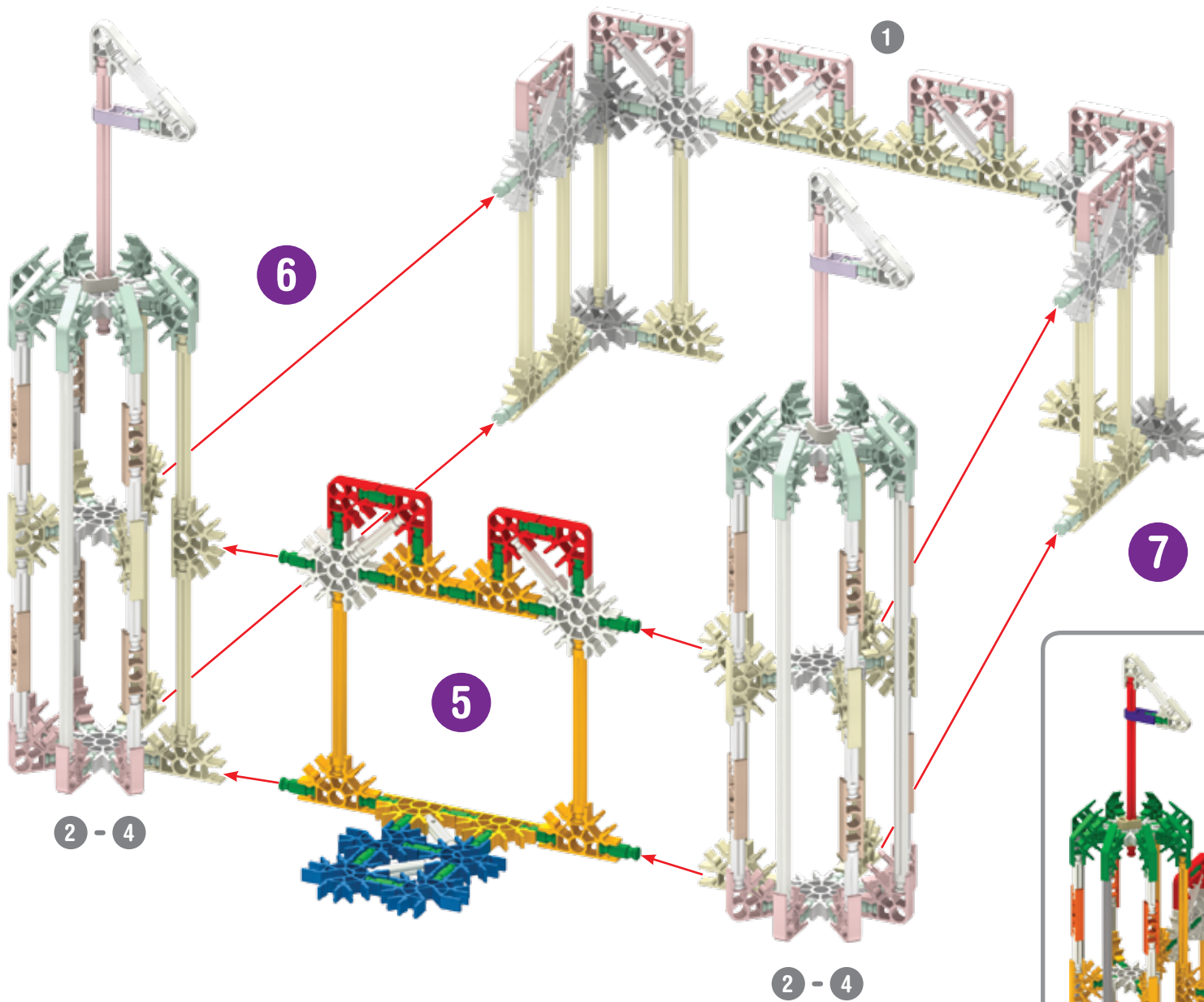

- | | | | | |
|----|--|---|--|--|
| 22 | | 4 | | |
| 4 | | | | |
| 2 | | | | |
| 6 | | 4 | | |

Clock Tower



16		8		8	
16					
4					
4					
4		12		4	

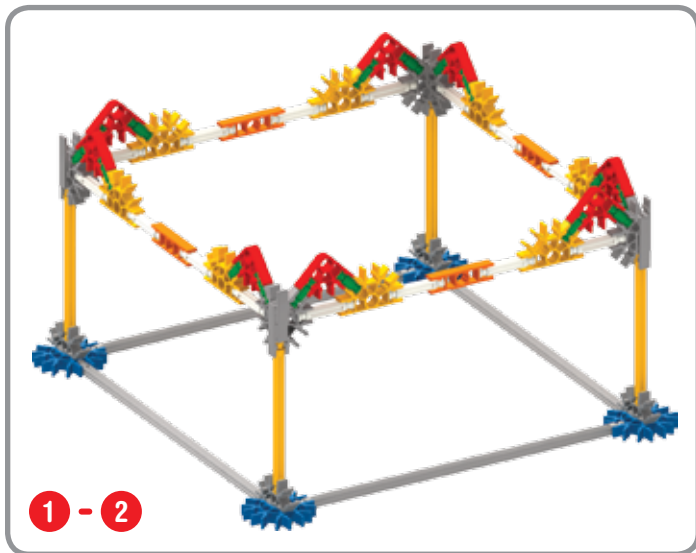
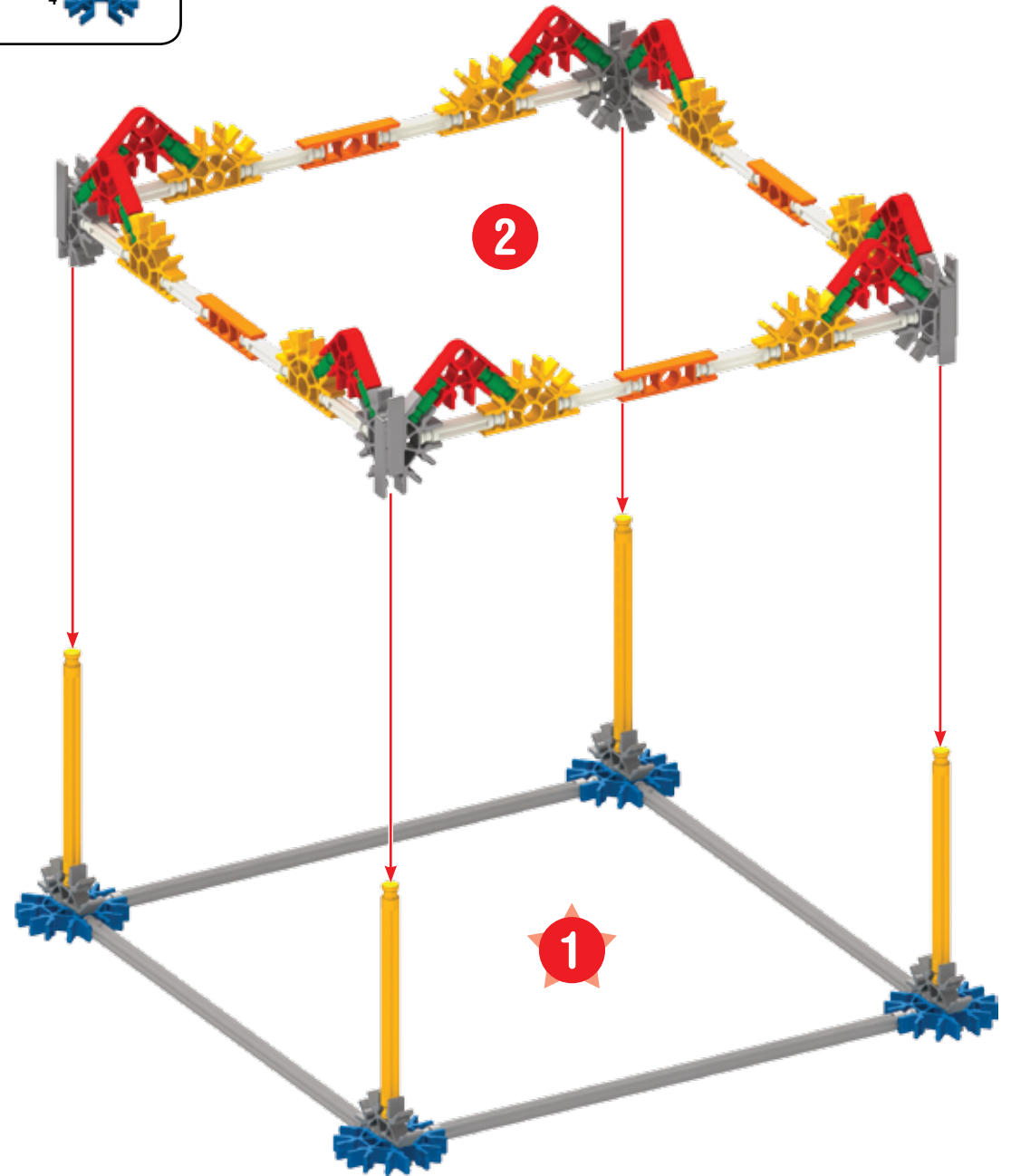

1 - 2

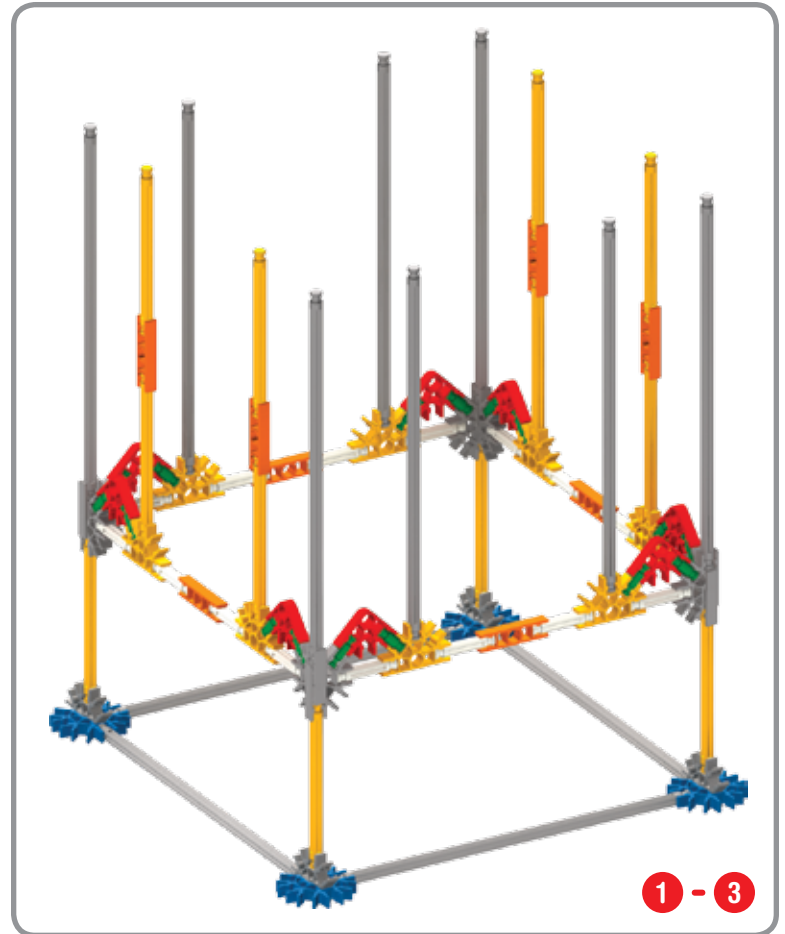
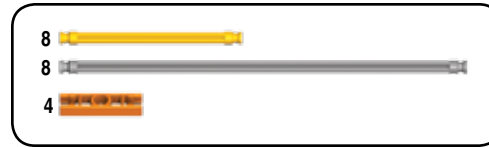
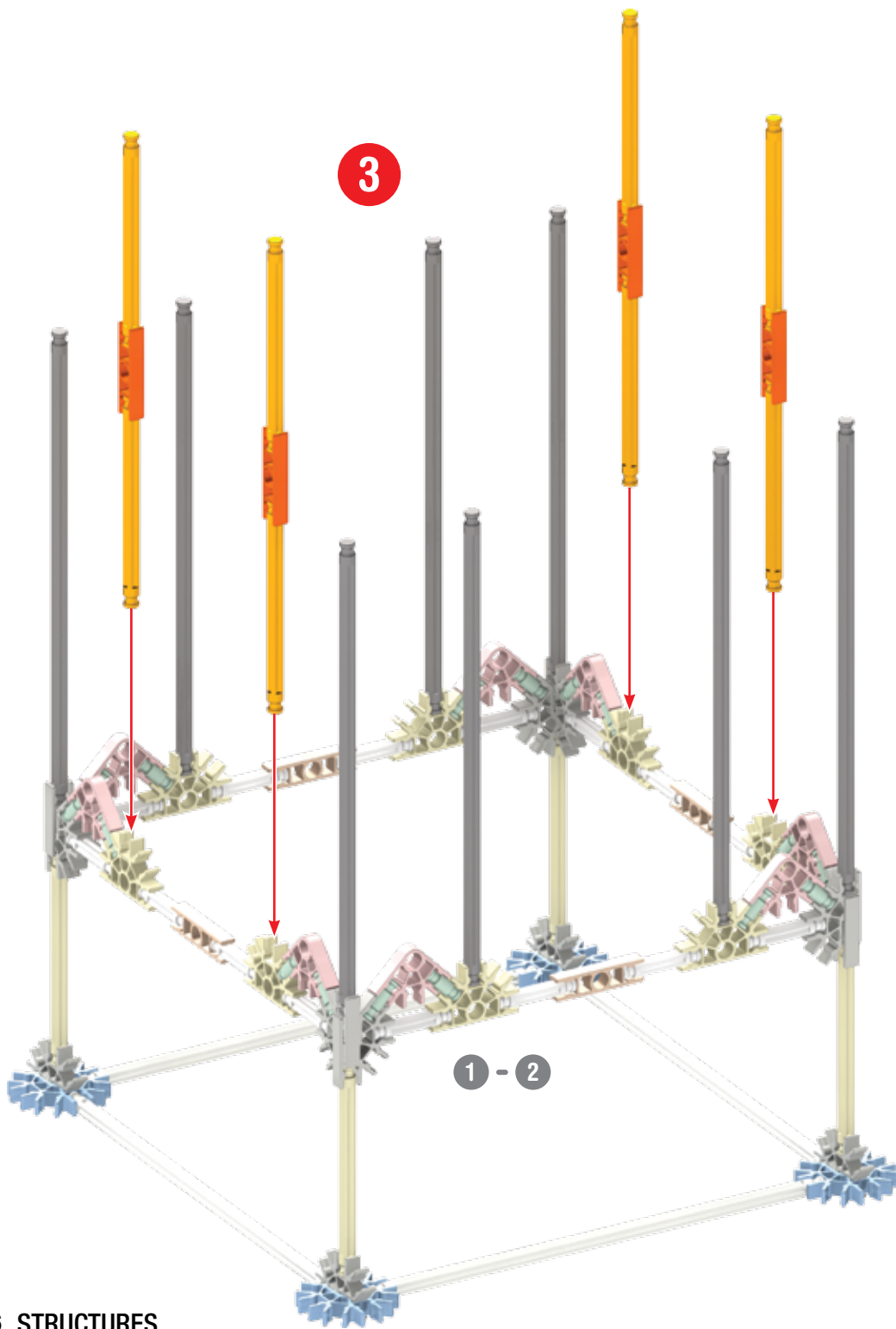

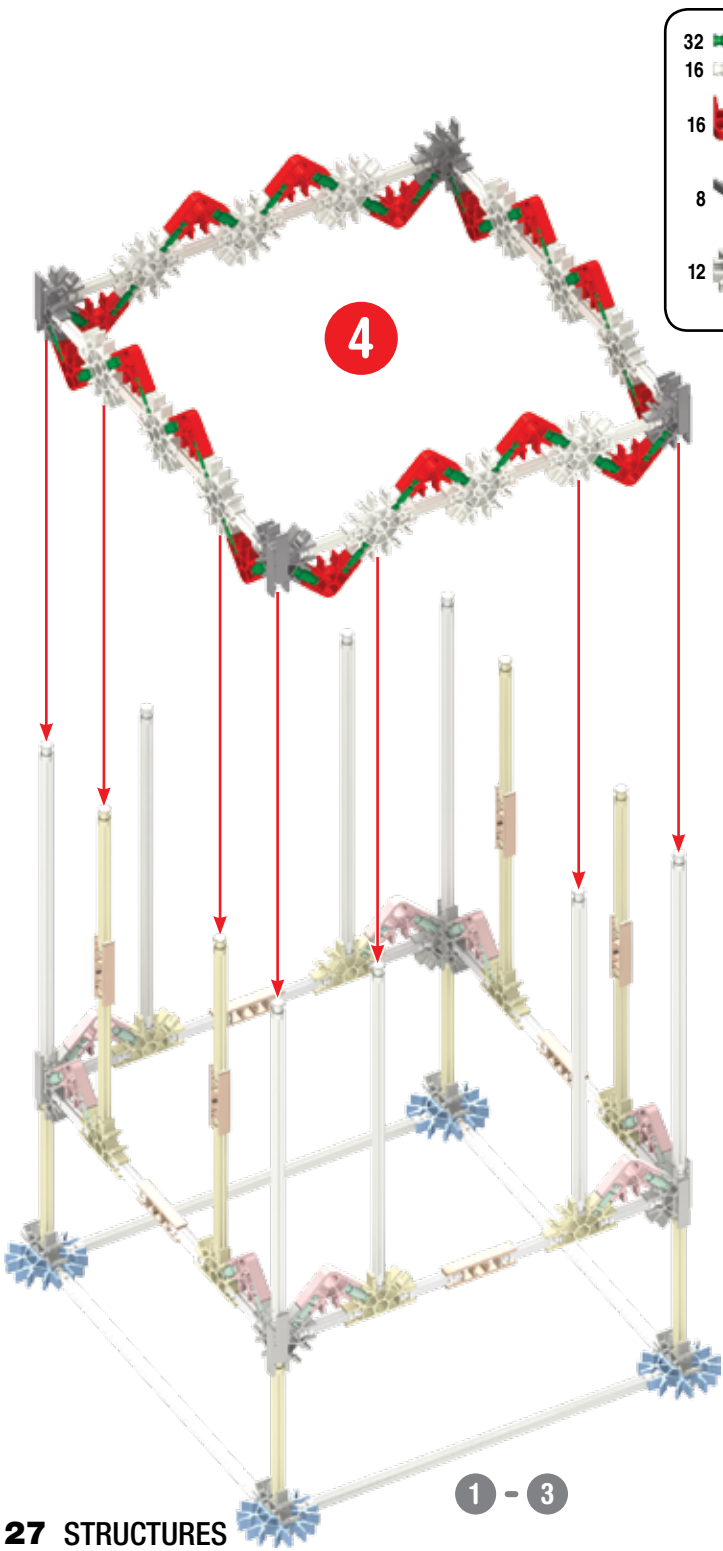

- 32
- 16
- 16
- 8
- 12

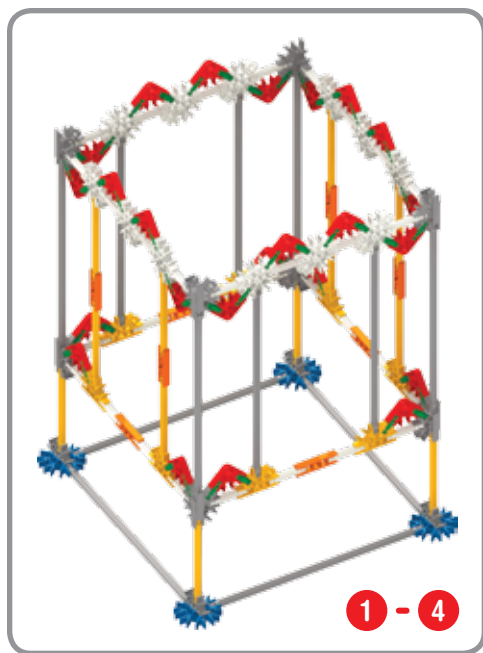
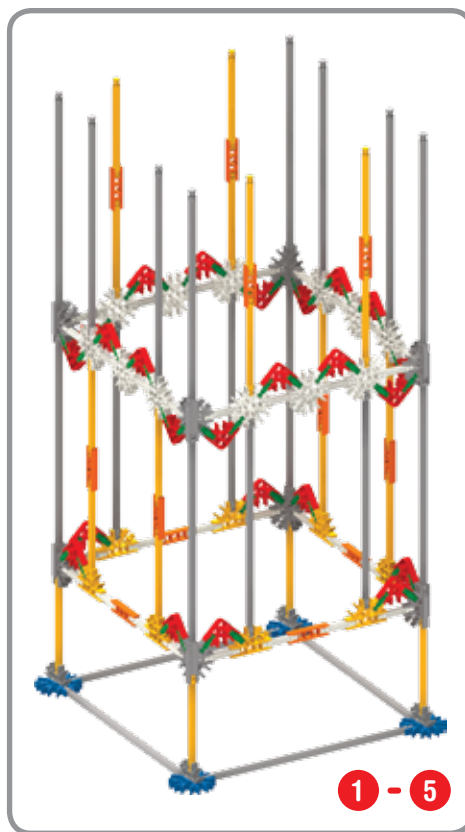

- 8
- 8
- 4

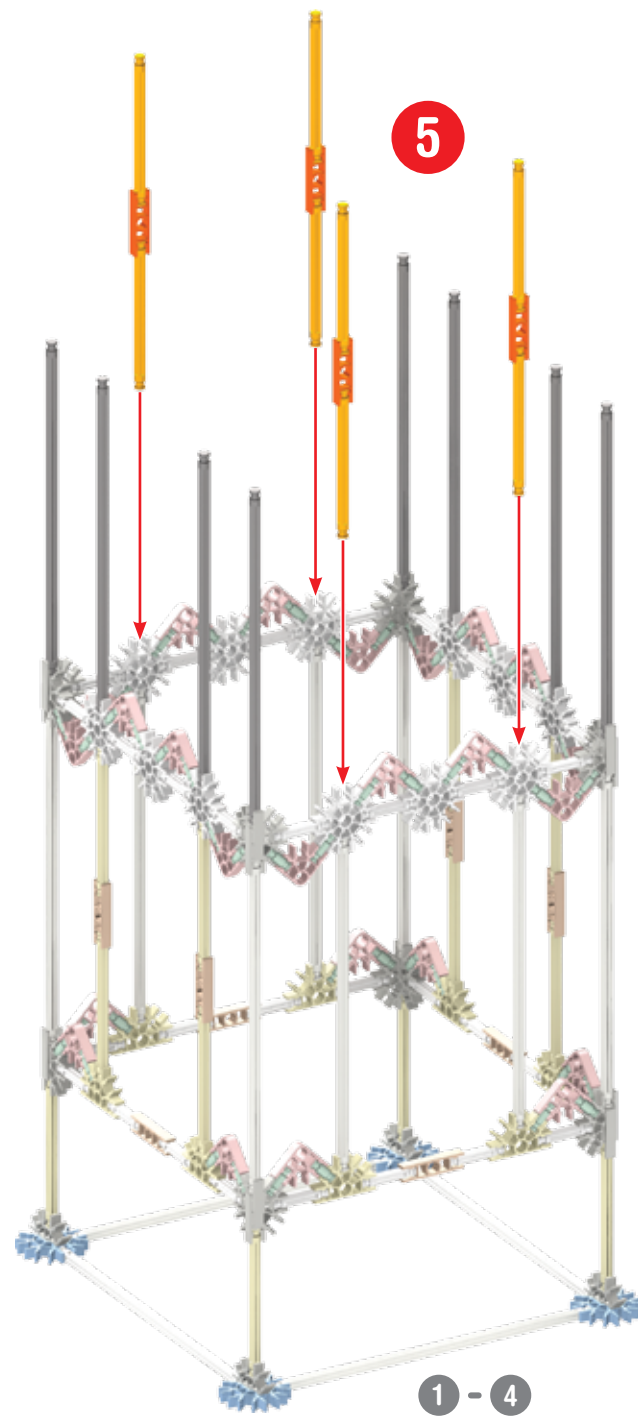

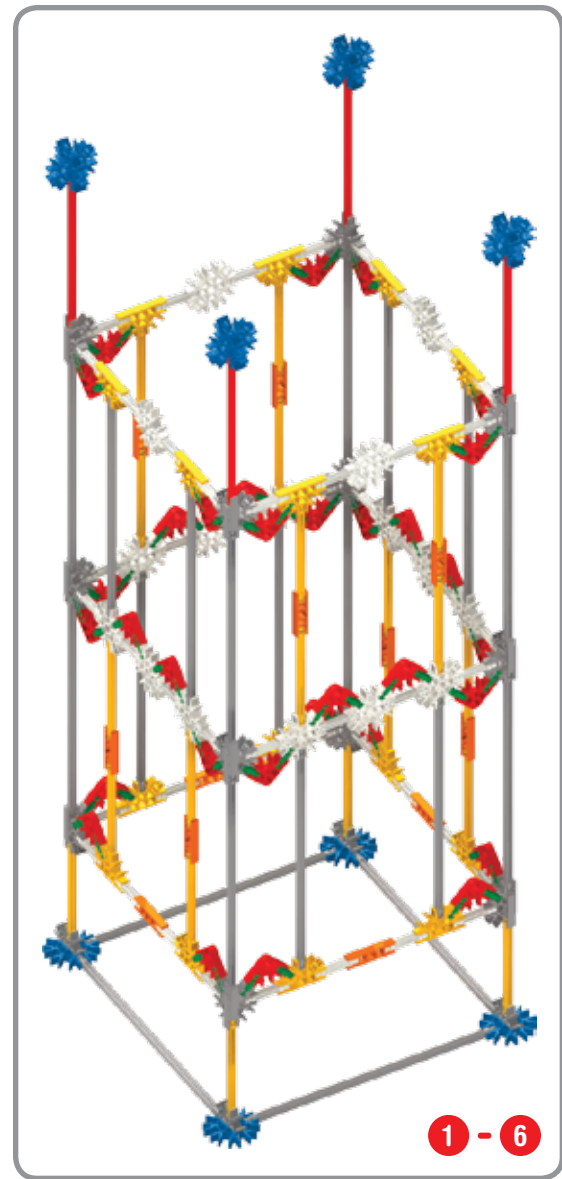
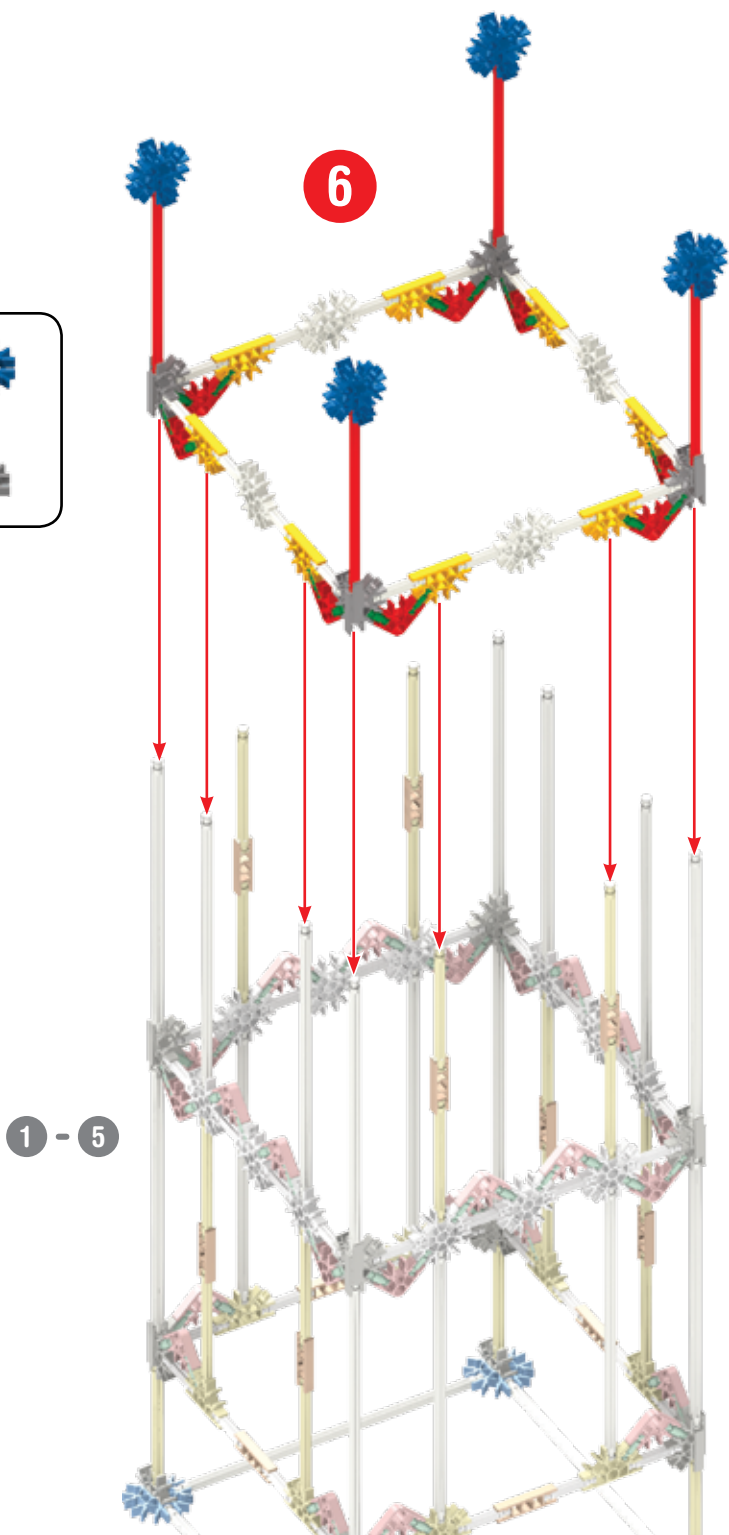
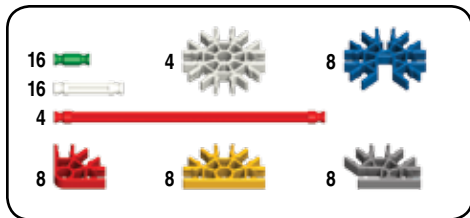

x3

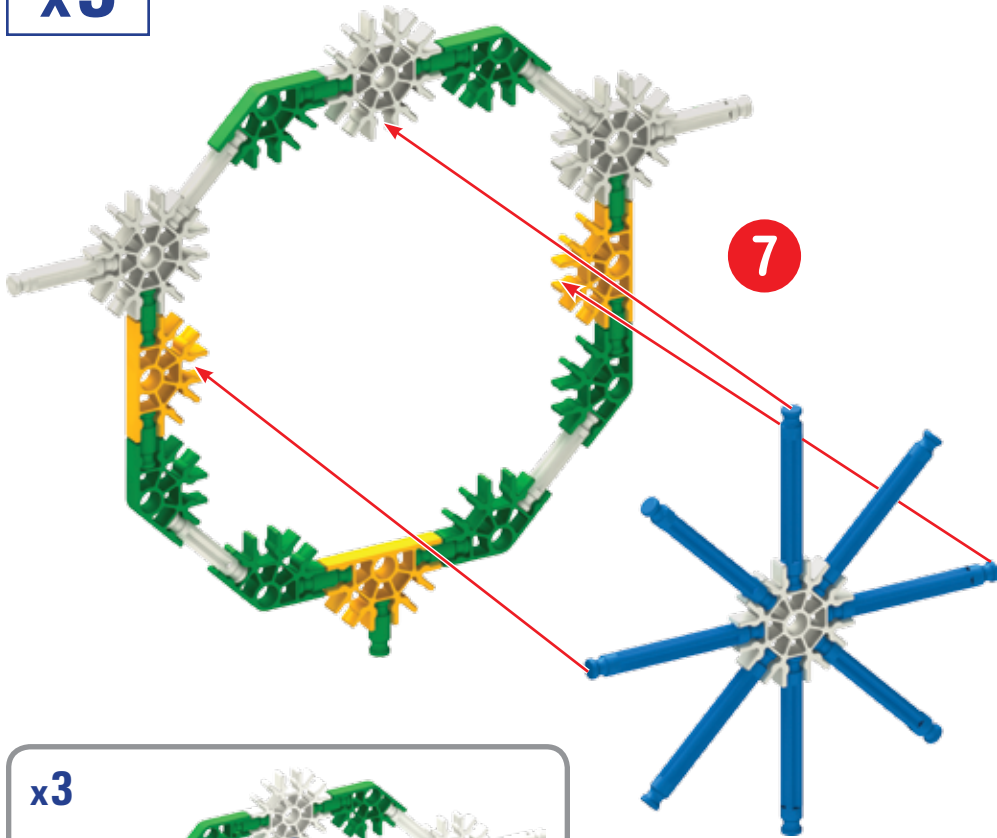

27		12	
18			
24			
18		9	

6		3	
6			
3			
3		6	



x3

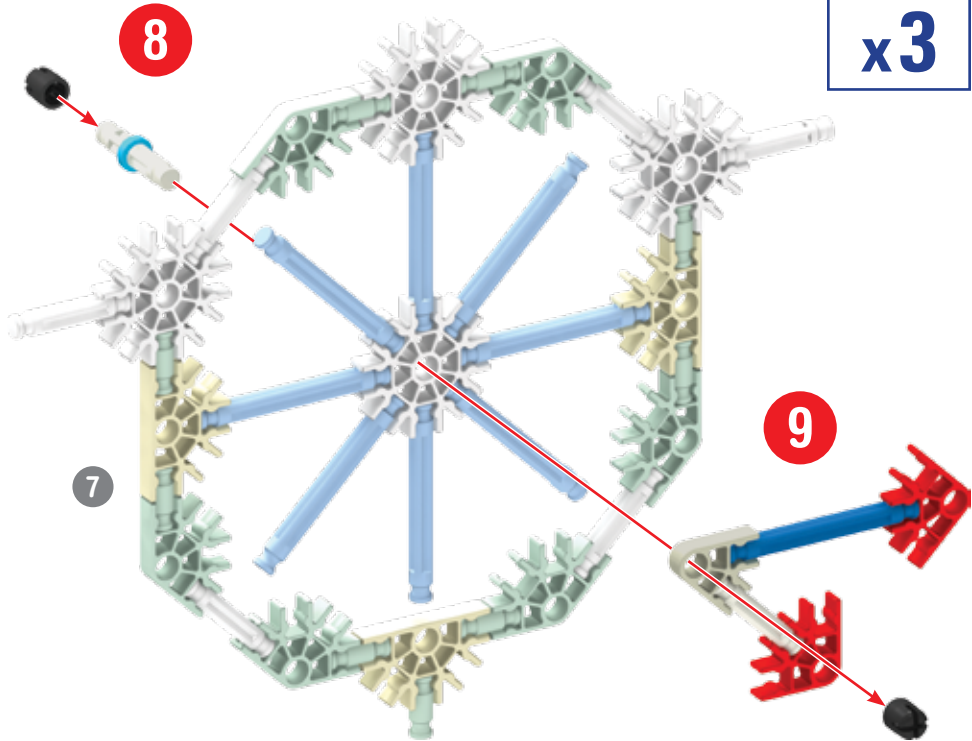

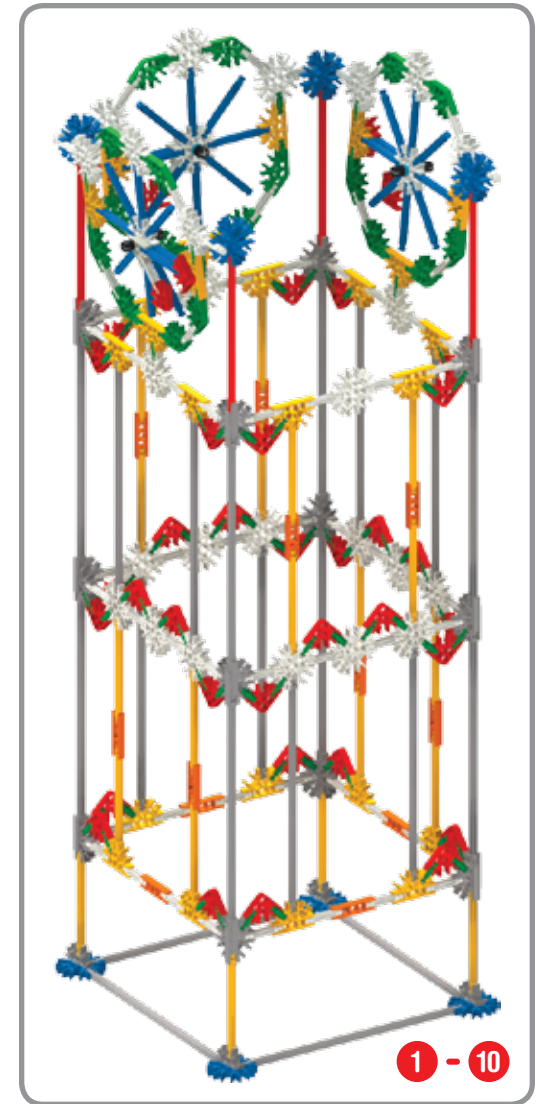
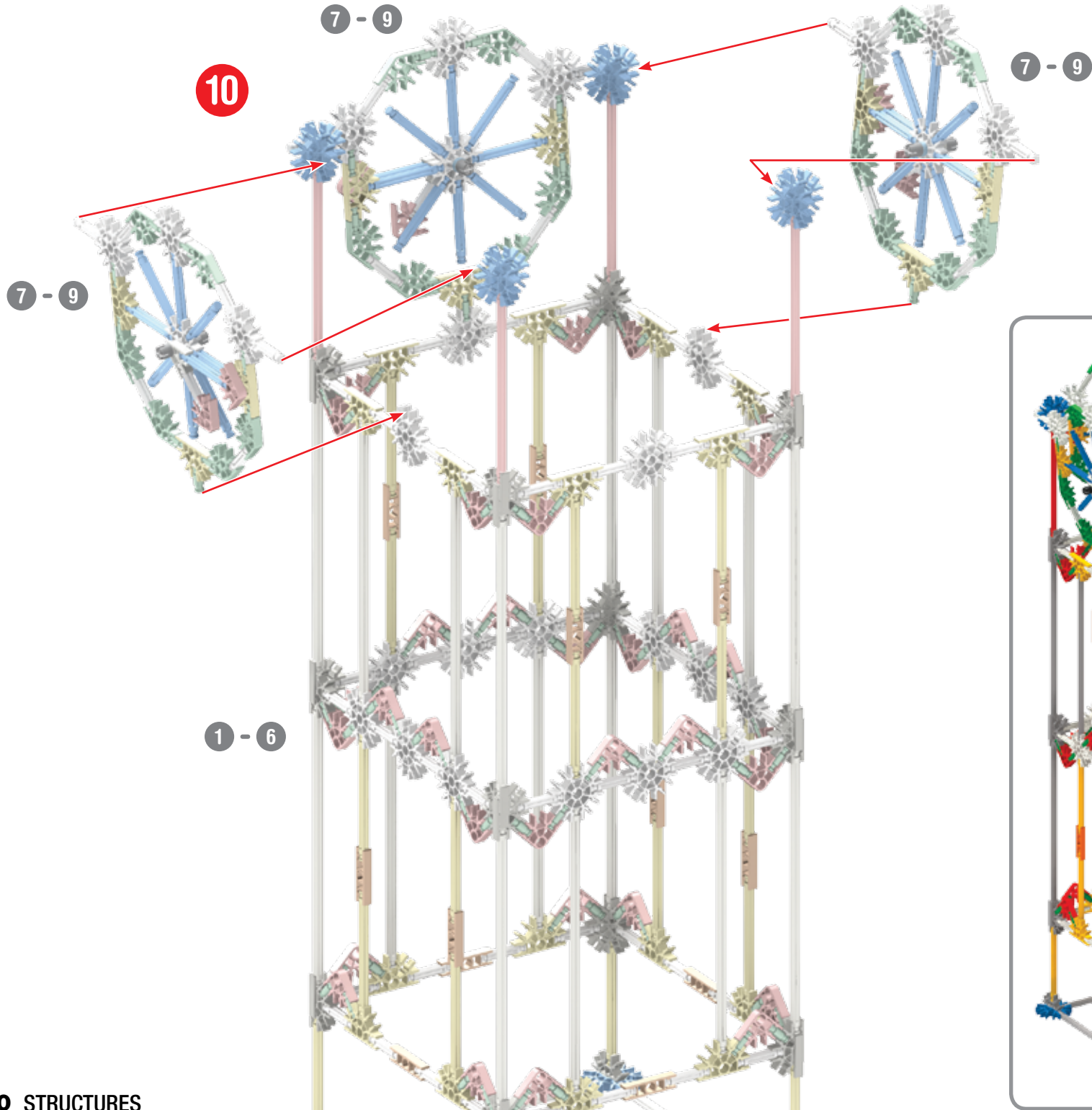

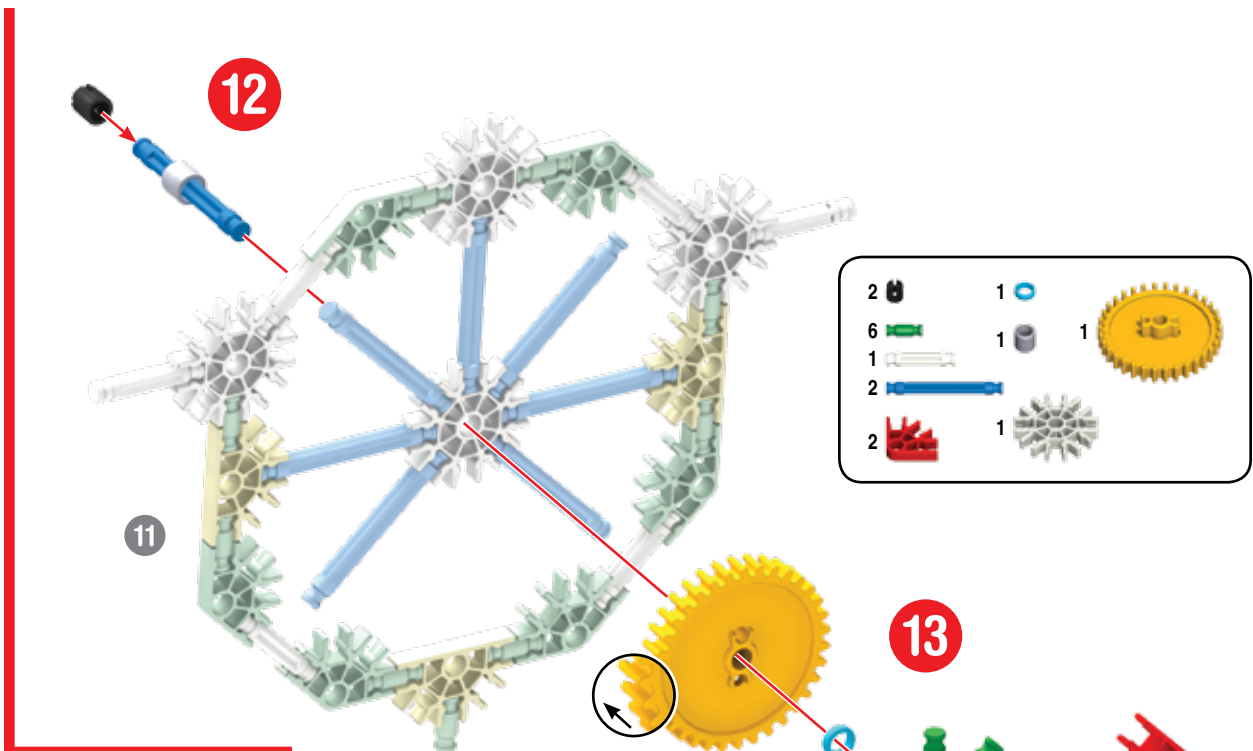
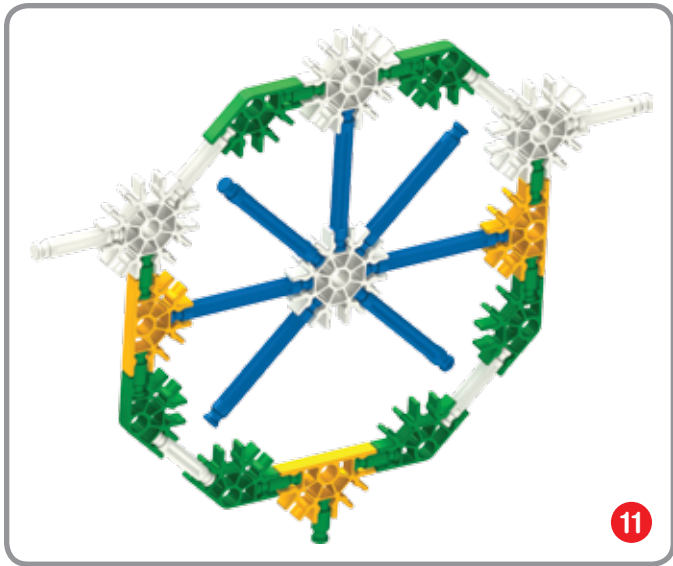

2	Black axle pin	1	Blue Technic axle	1	Yellow gear
6	Green Technic axle	1	Grey Technic axle	1	Grey gear
1	White Technic connector				
2	Blue Technic axle				
2	Red Technic connector				

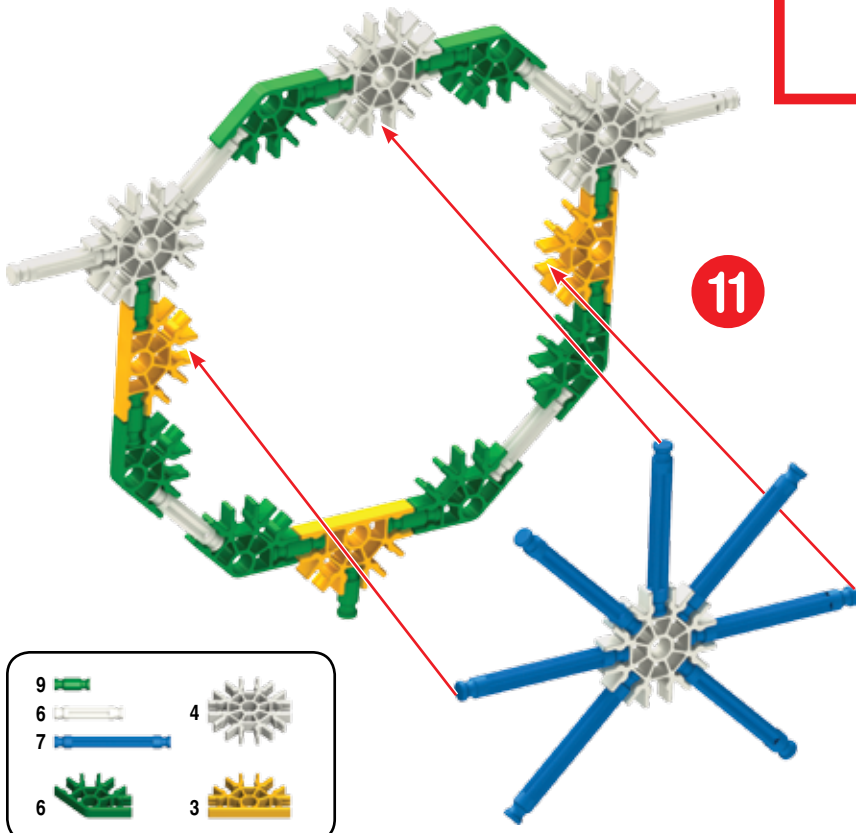

9	Green Technic axle	4	Grey Technic connector
6	White Technic connector		
7	Blue Technic axle		
6	Green Technic axle	3	Yellow gear

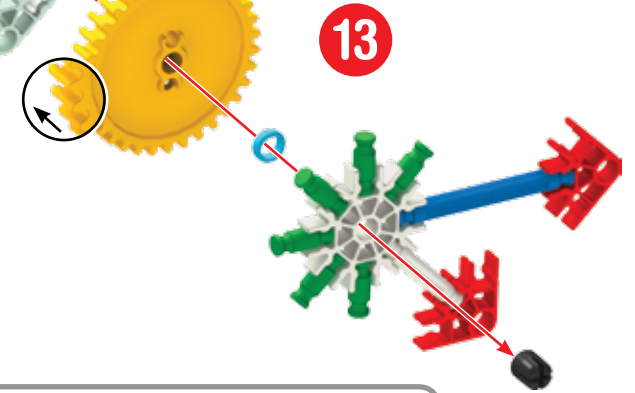

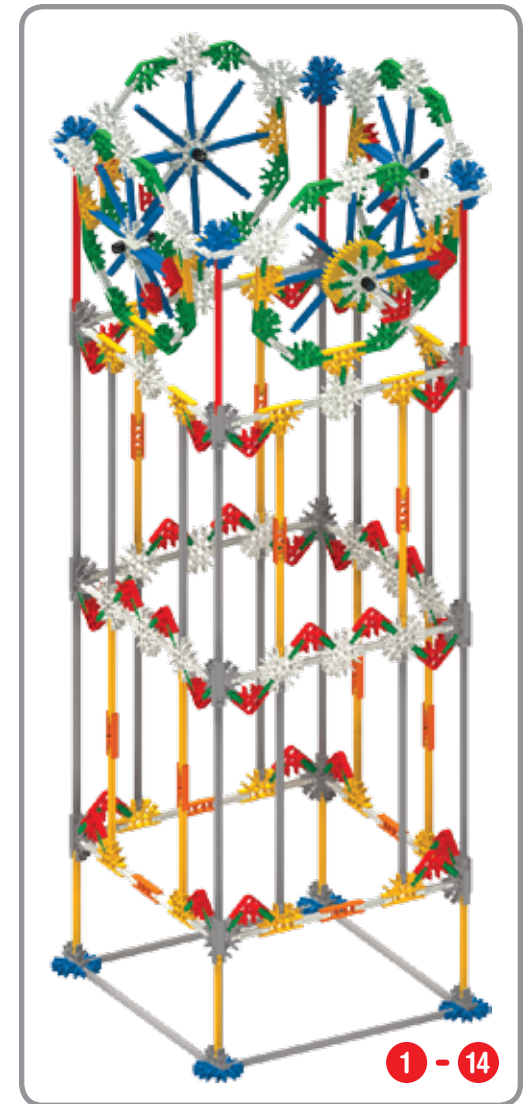
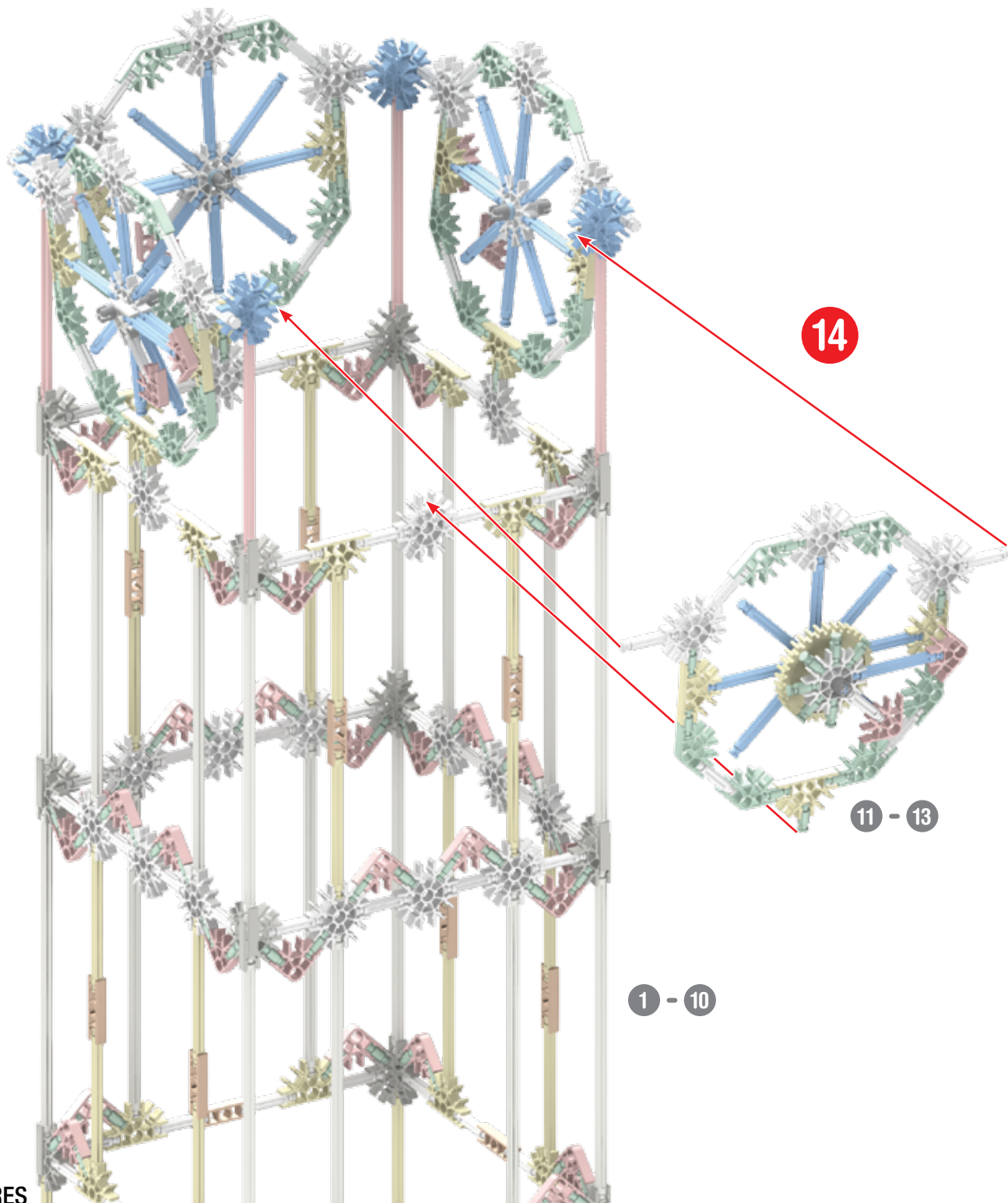

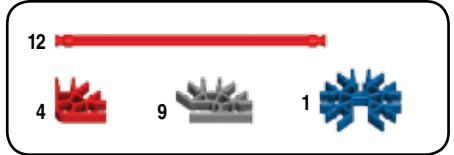
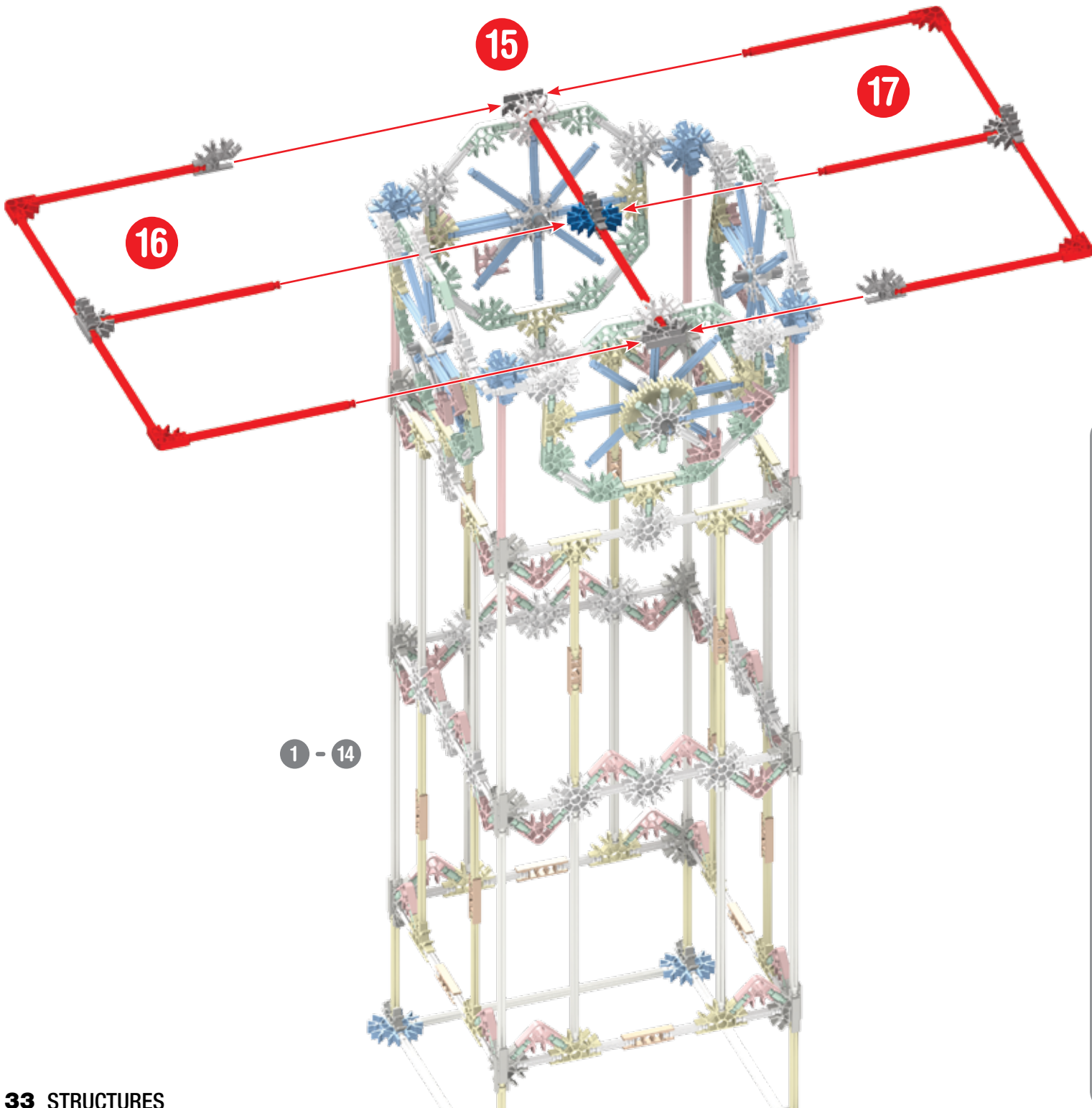

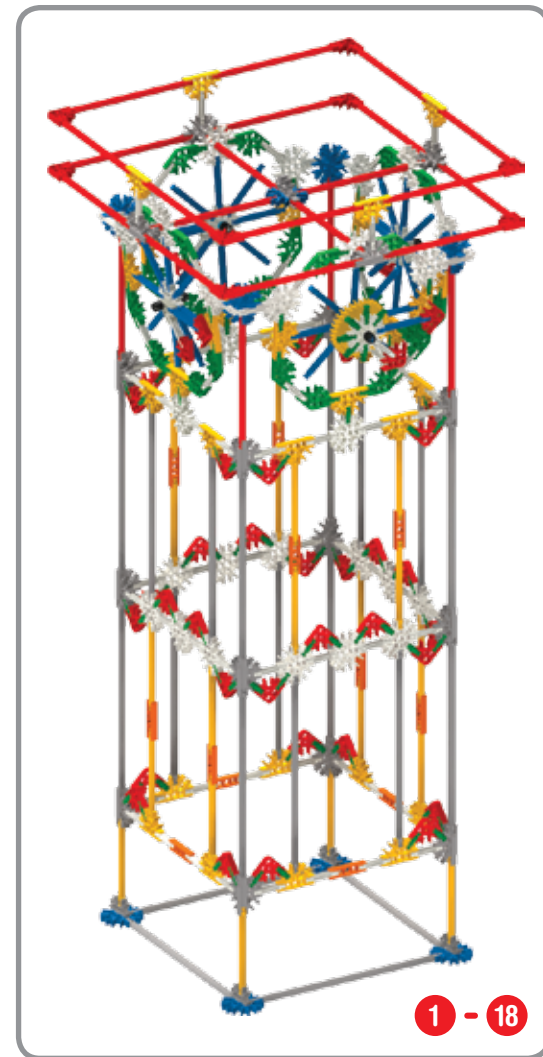
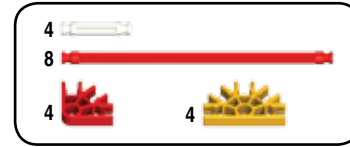
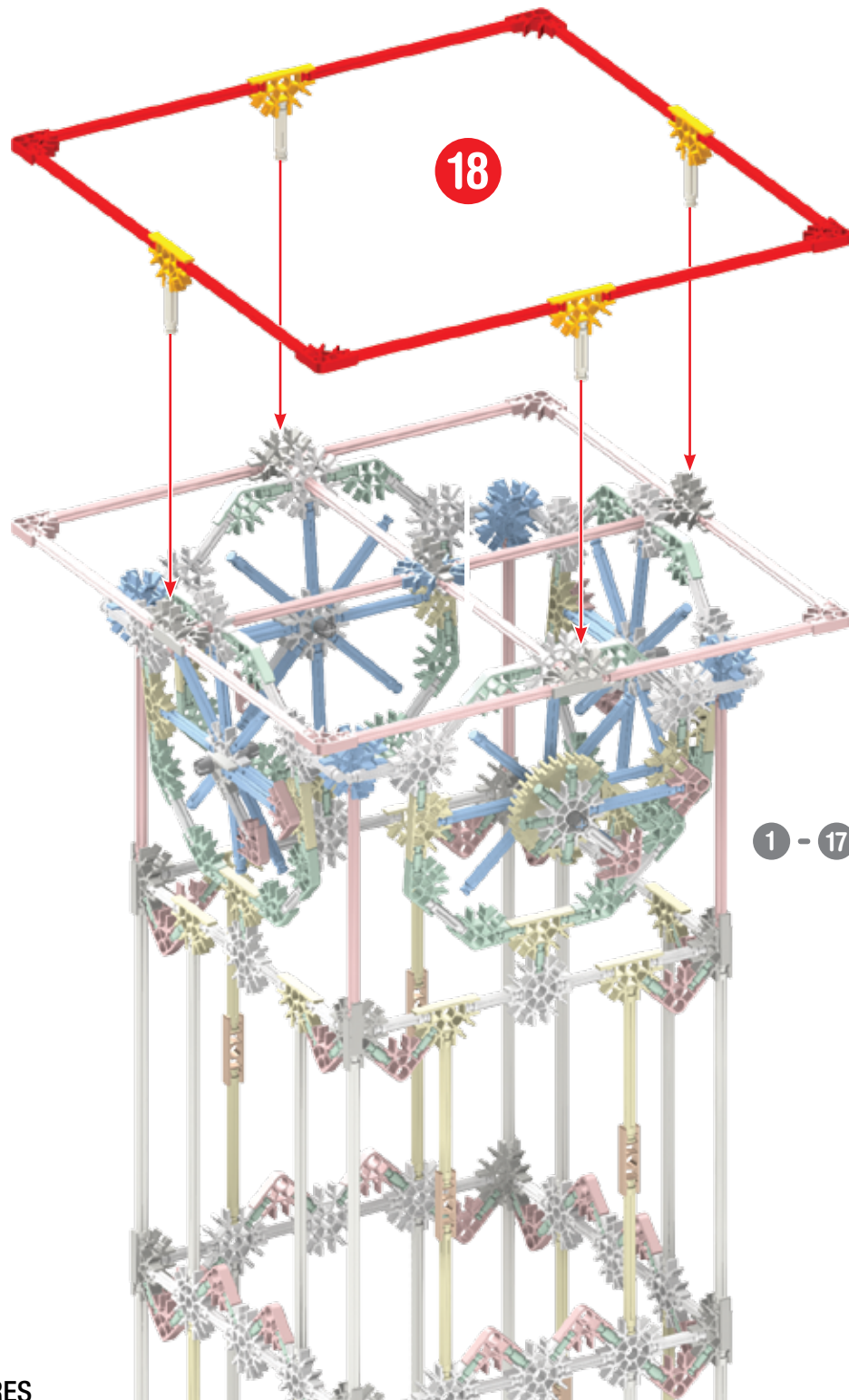

Clock Tower



1 - 20

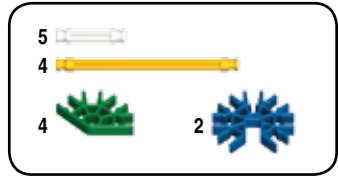

20

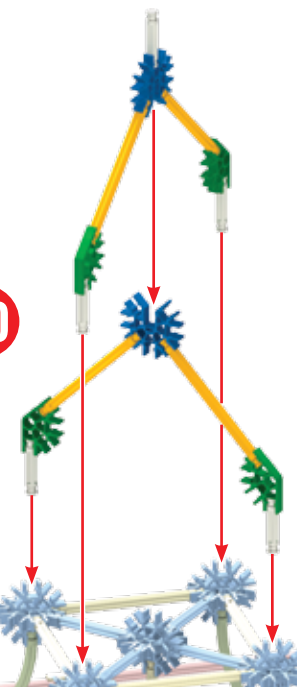

1 - 19

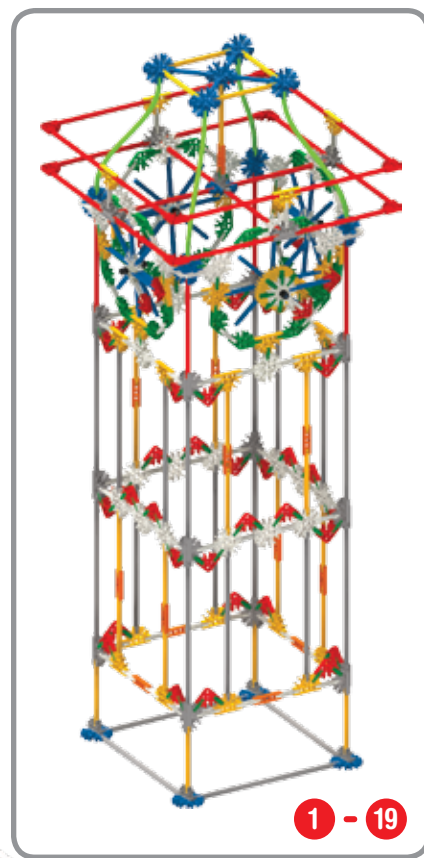
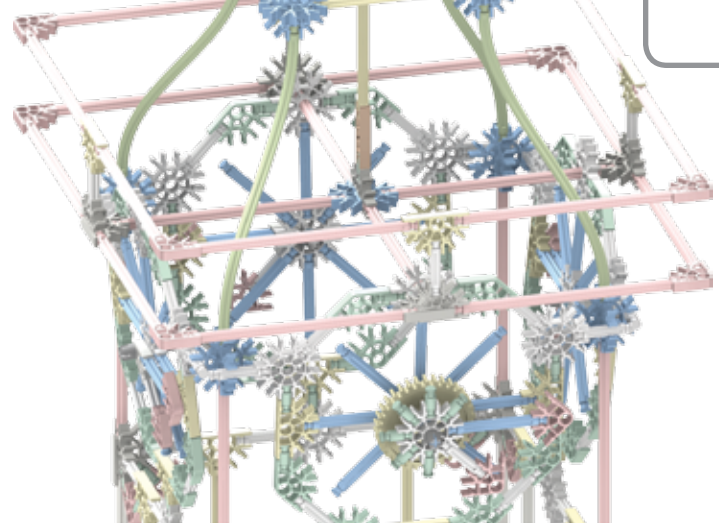

1 - 19

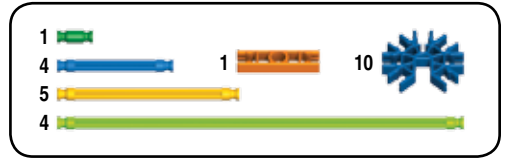

19

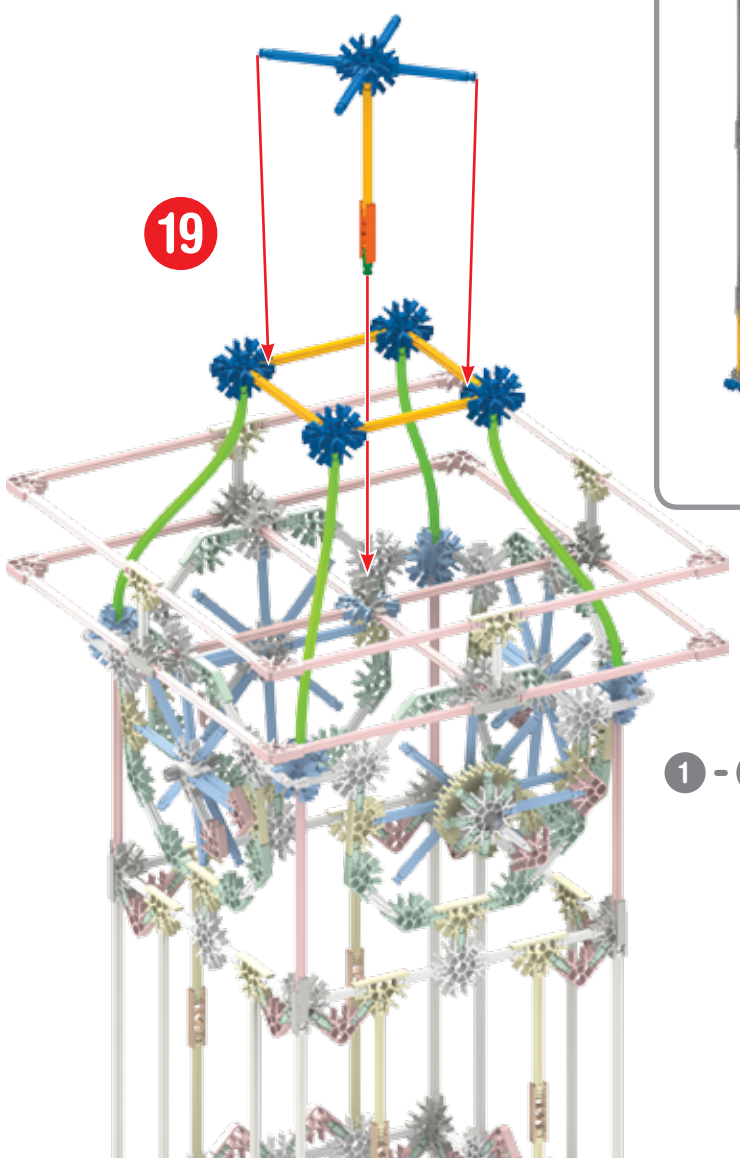

1 - 18

House

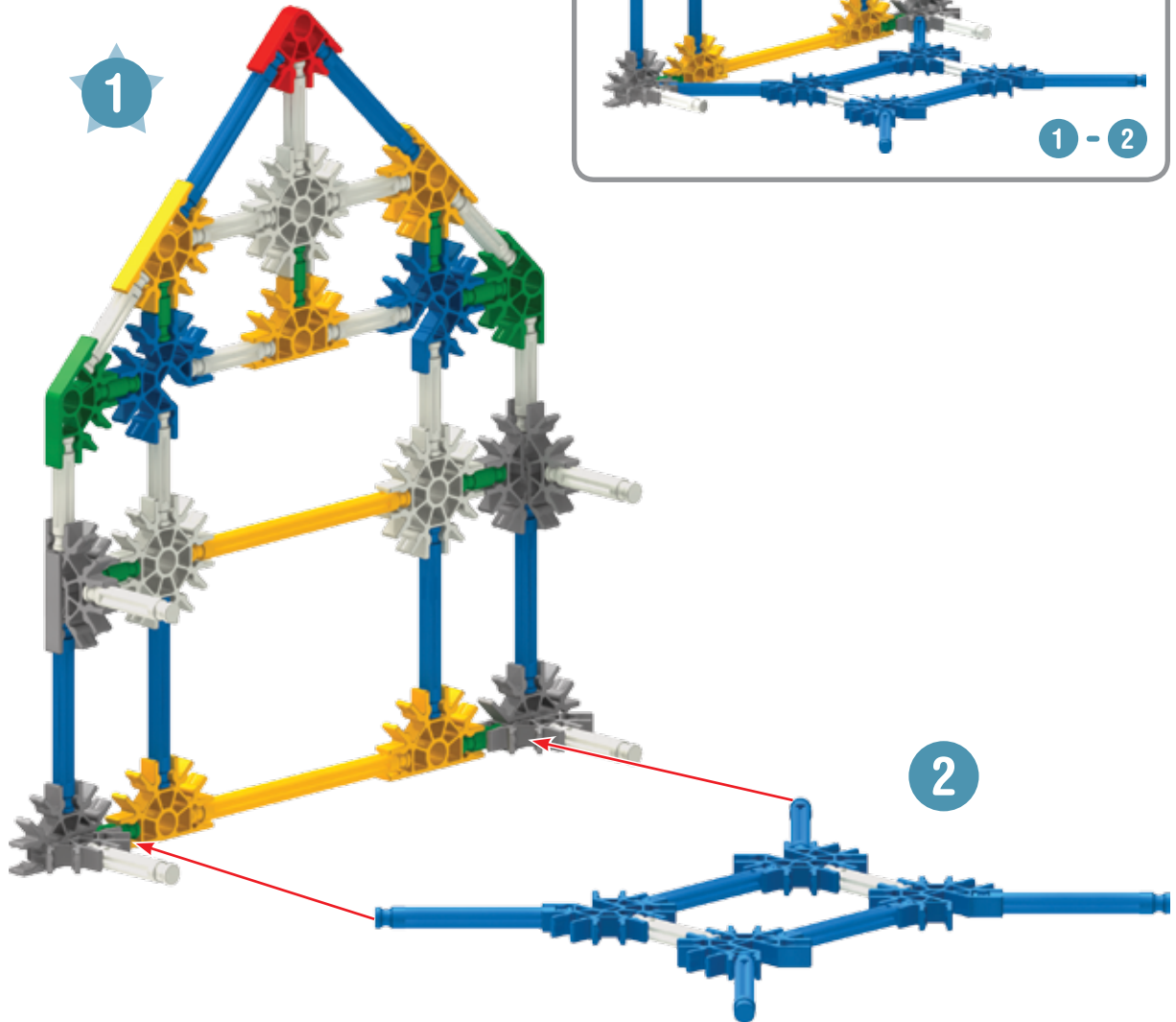
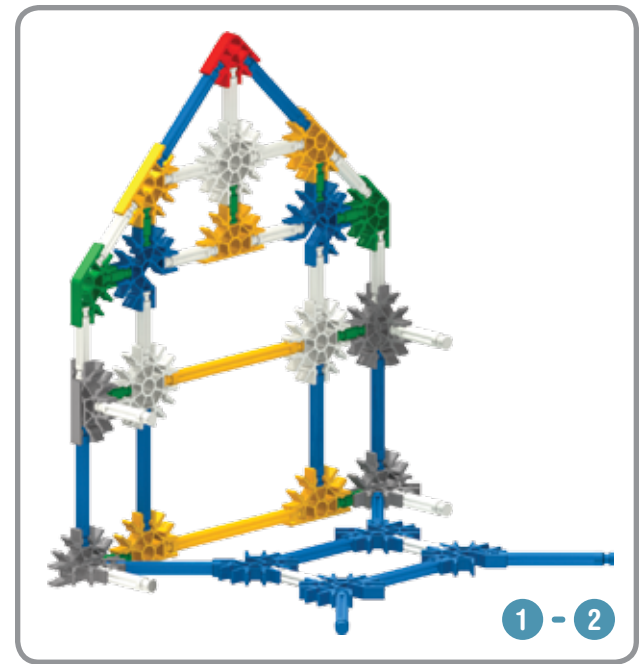
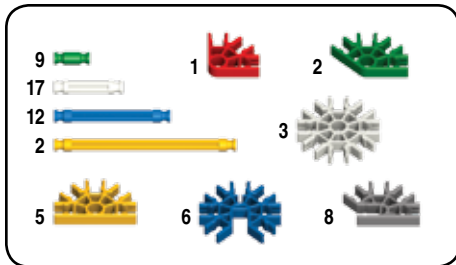
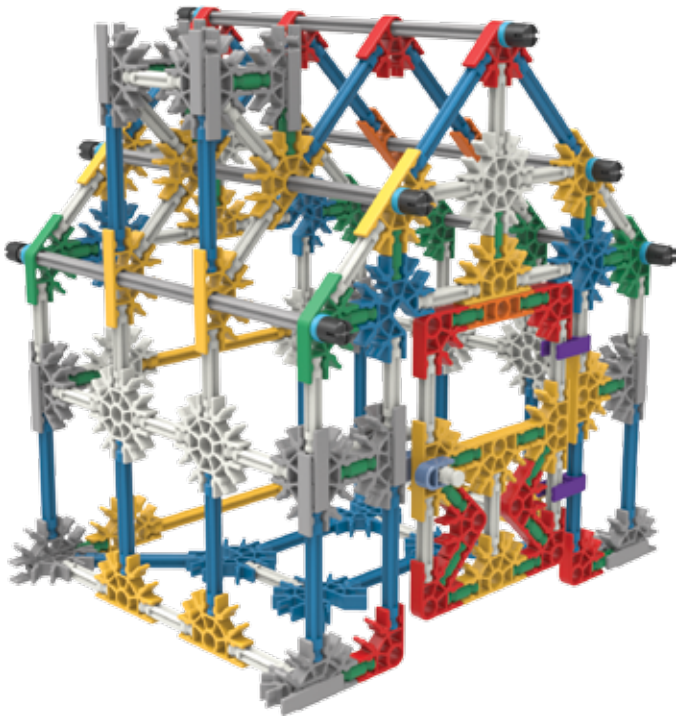

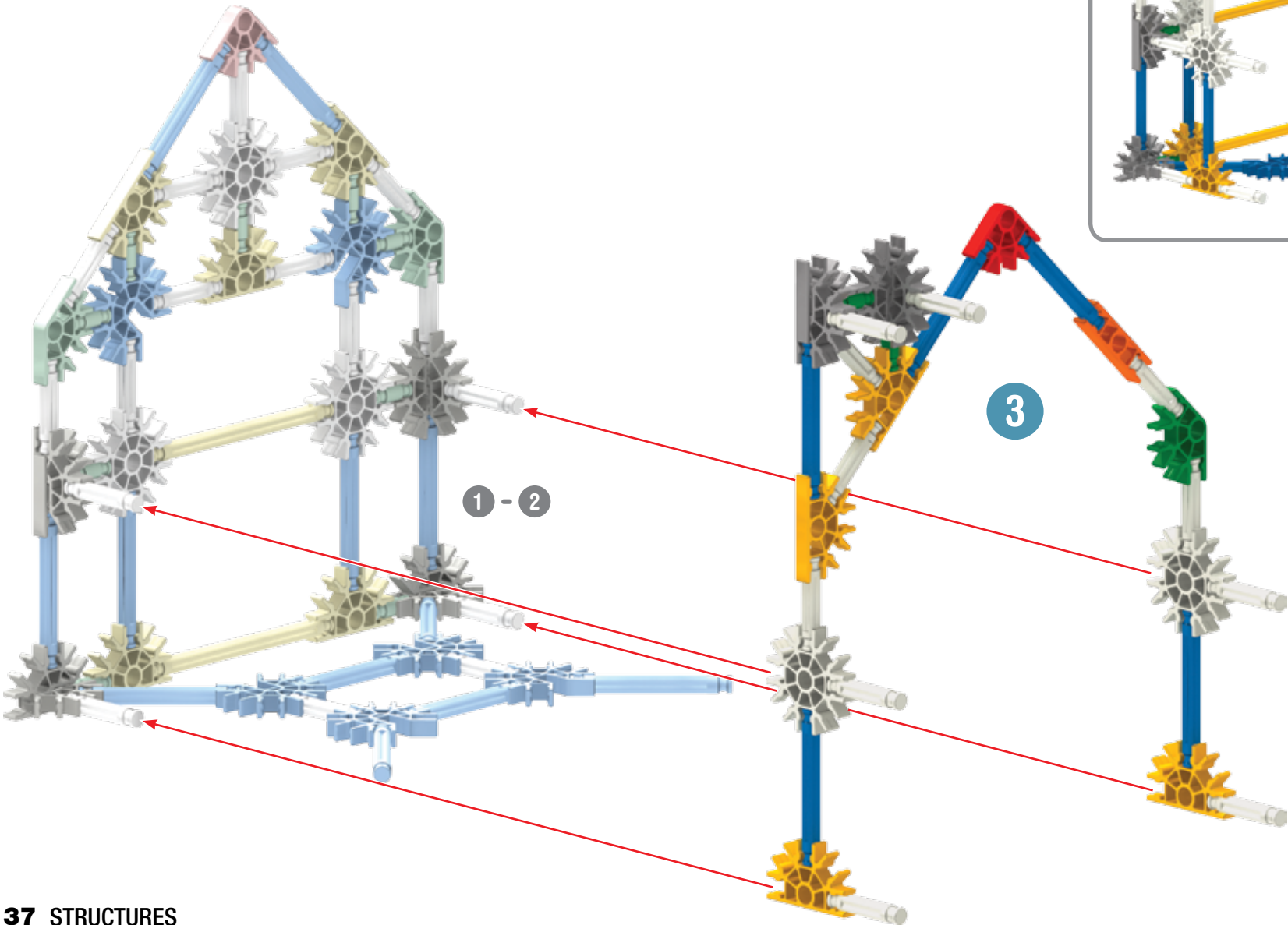
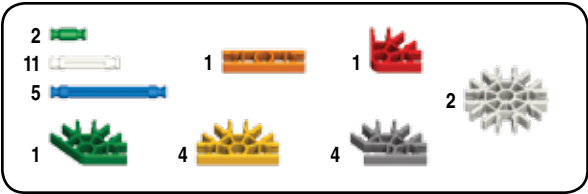

2		1		1		
9						2
5						
1		4		4		

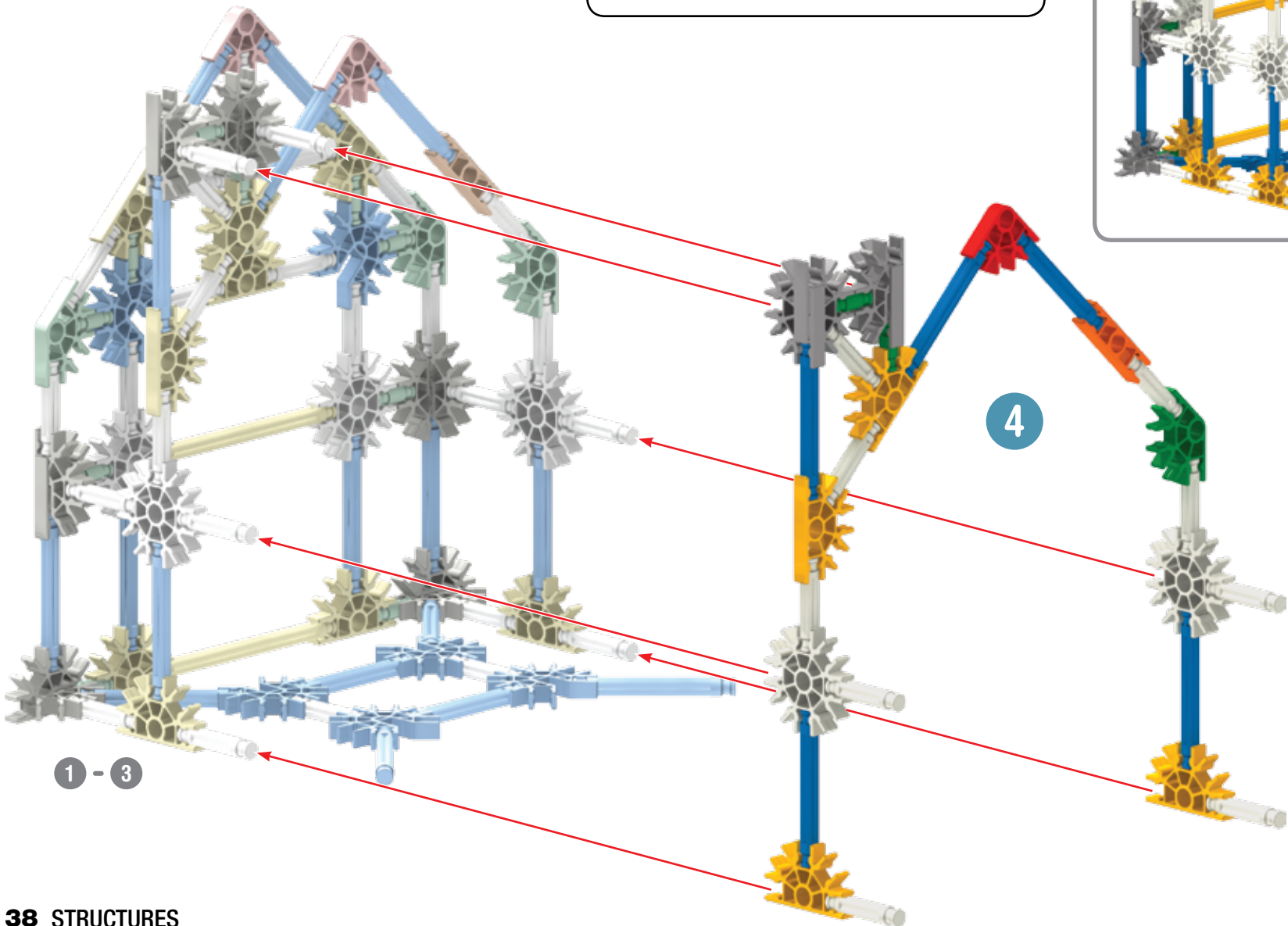

1 - 3

4

1 - 4

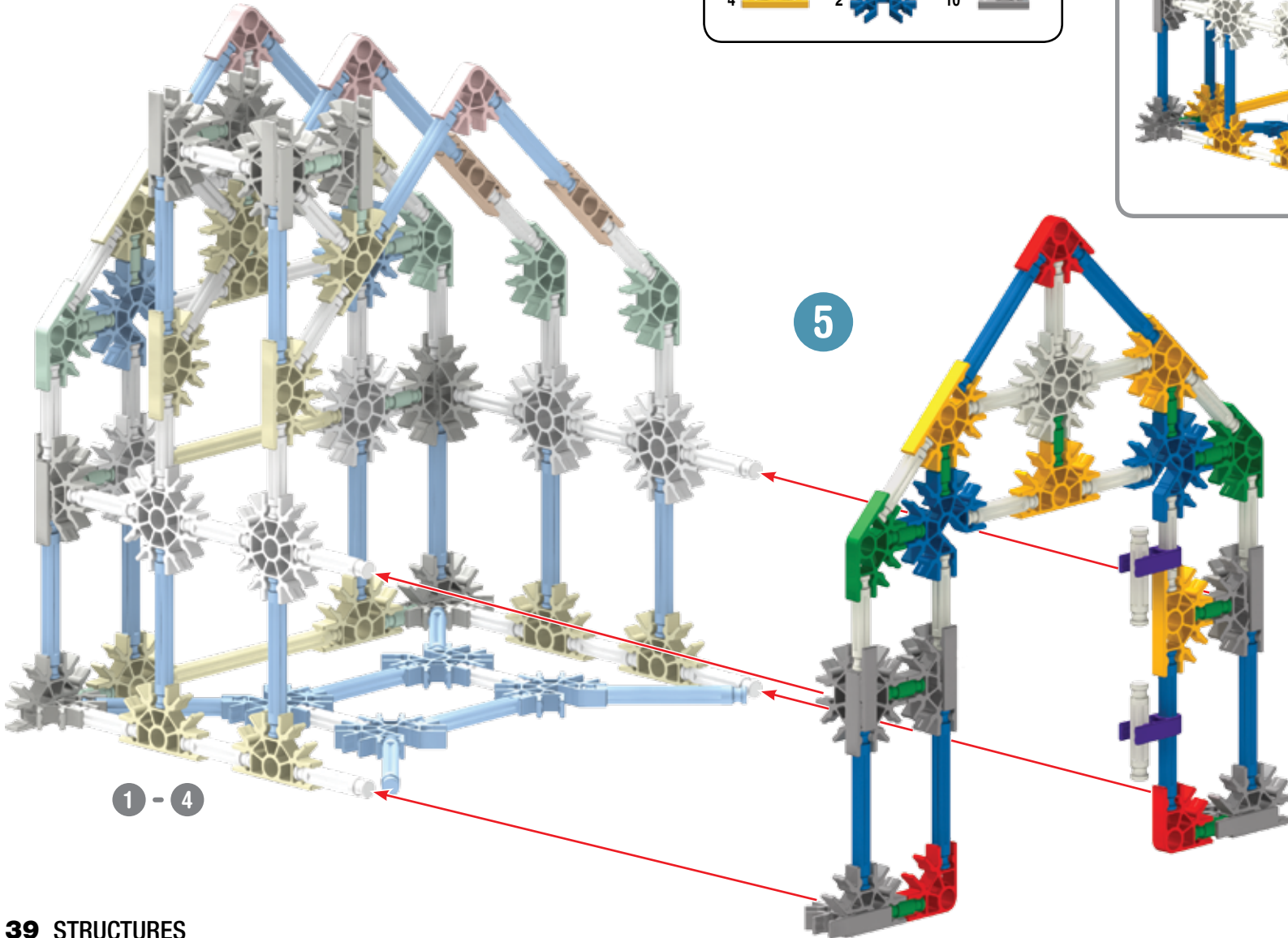
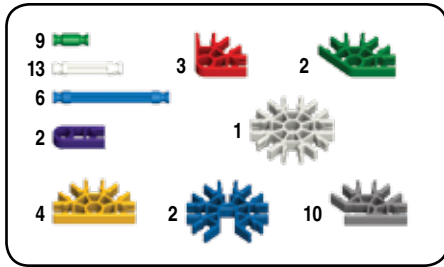

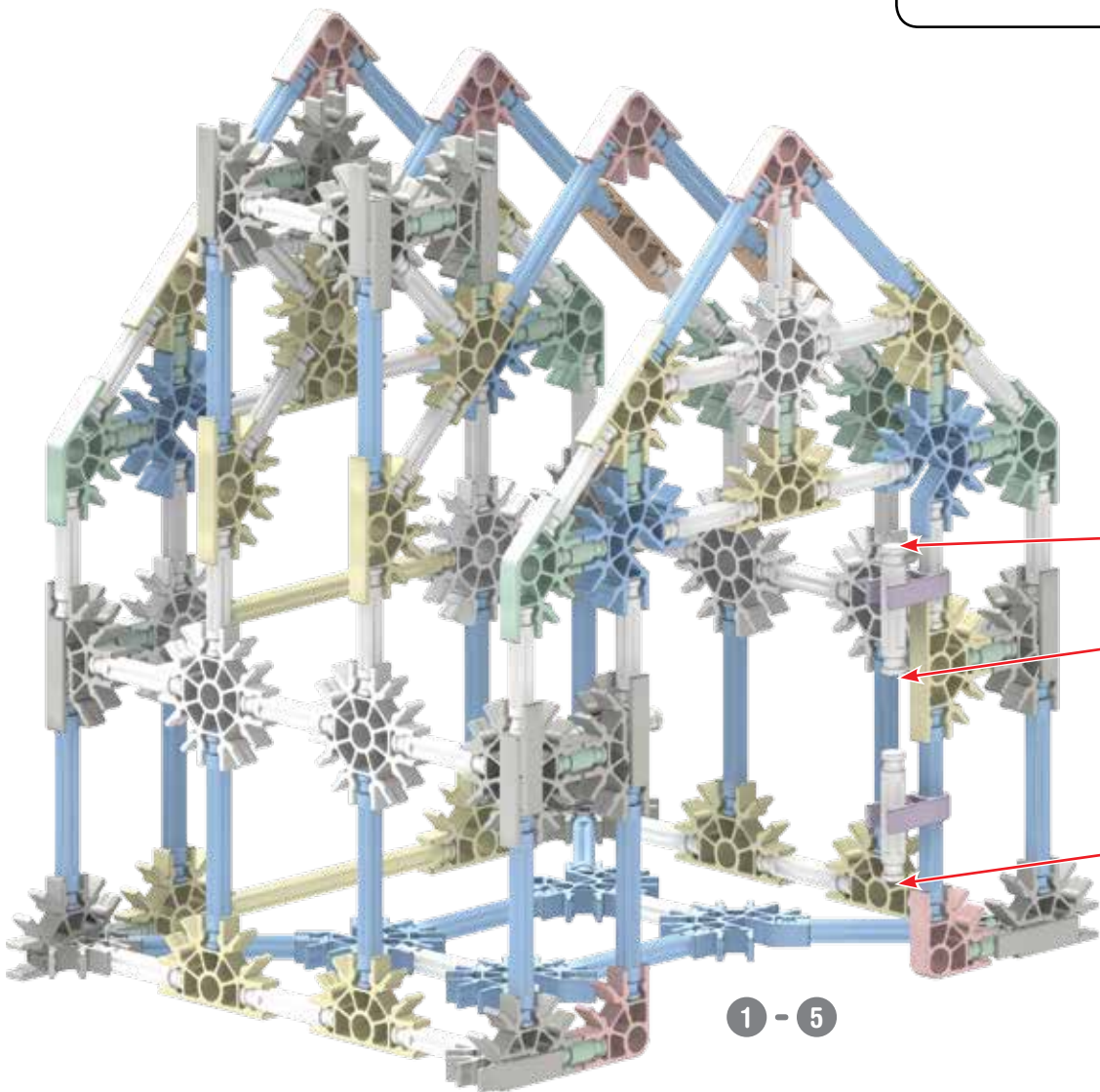

- | | | | |
|----|--|---|--|
| 10 | | 1 | |
| 4 | | | |
| 2 | | 6 | |
| | | 4 | |



6

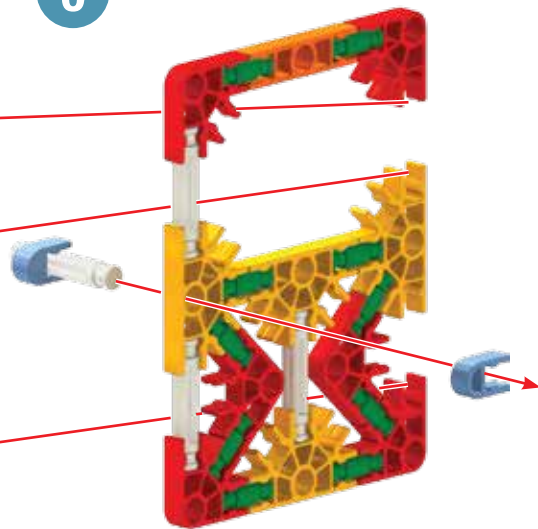

1 - 5

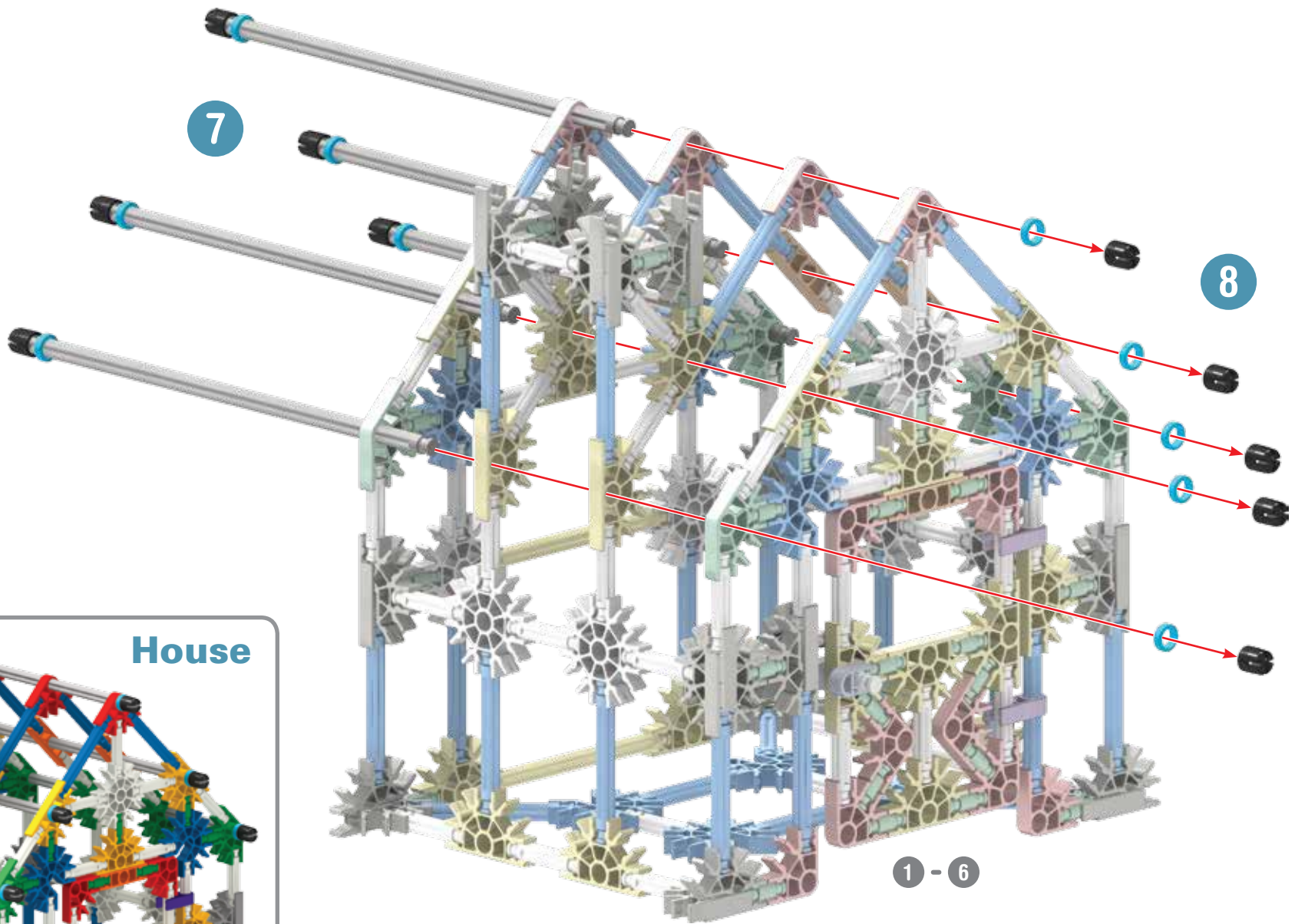

10		10	
5			

Igloo

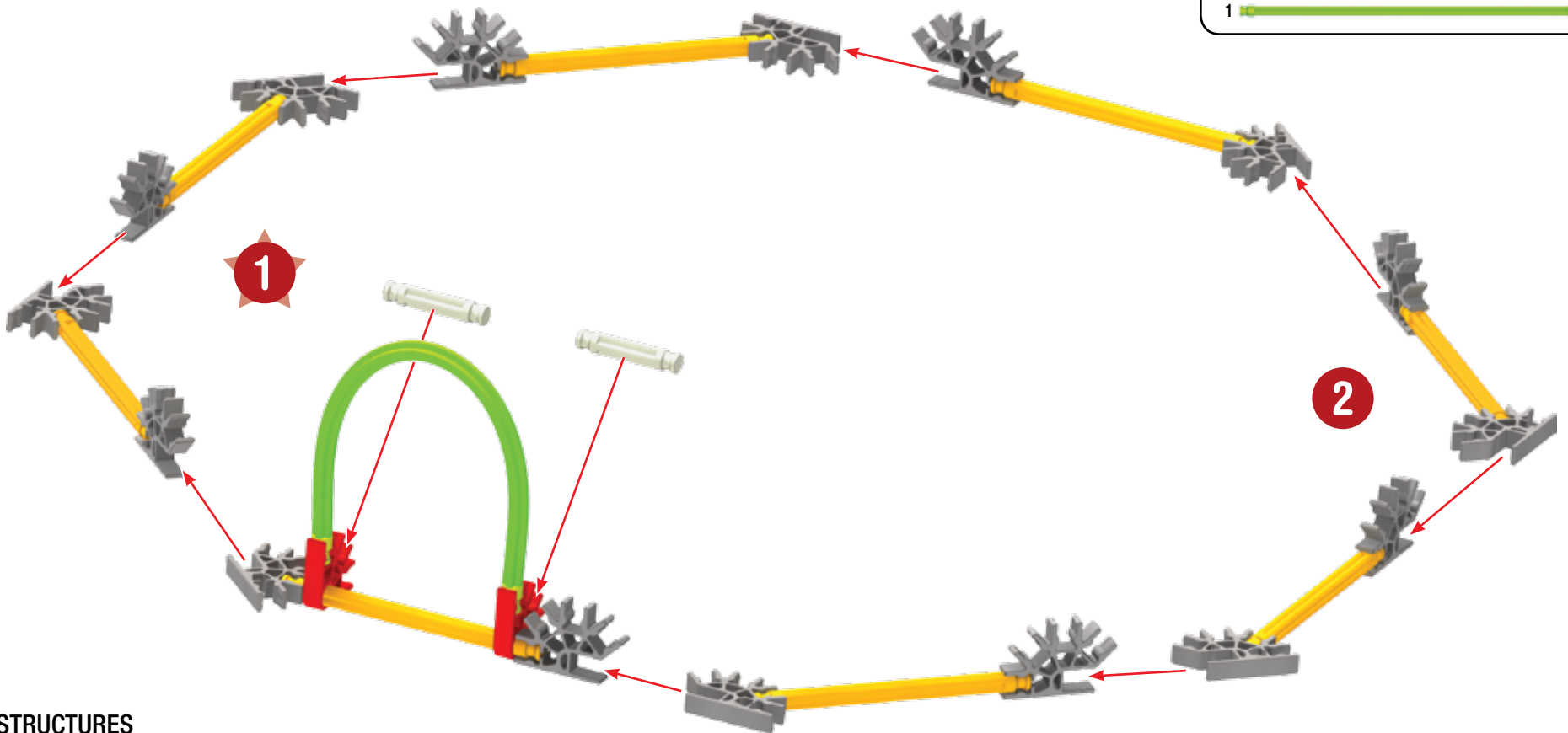
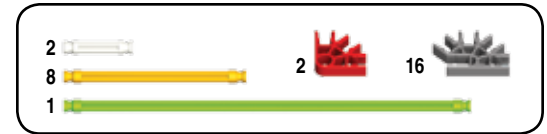
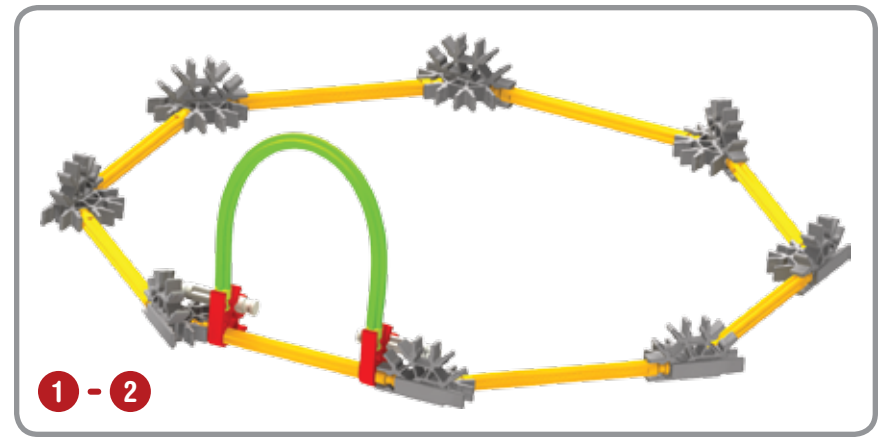
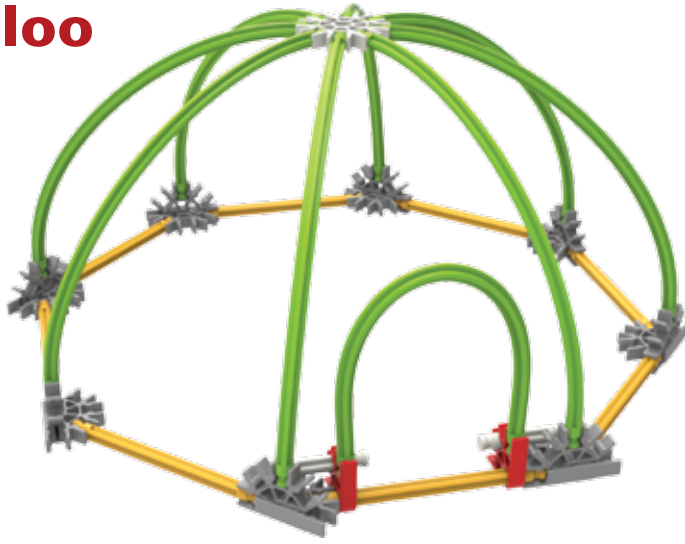

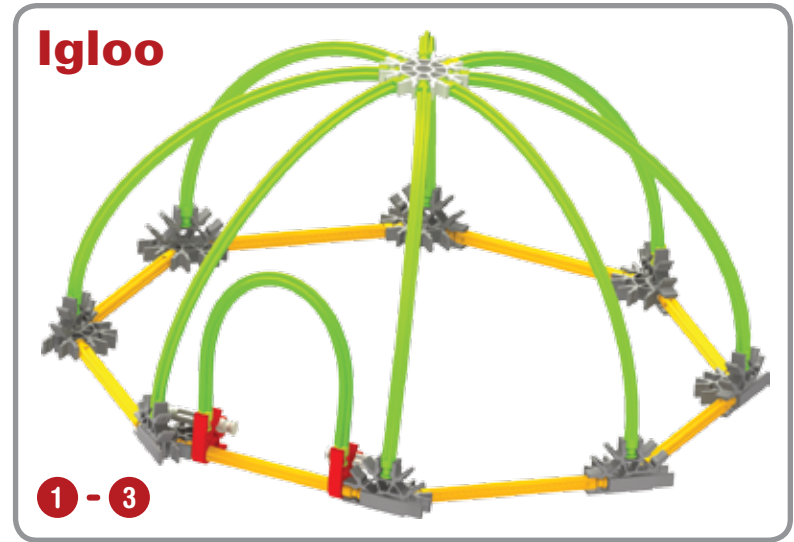
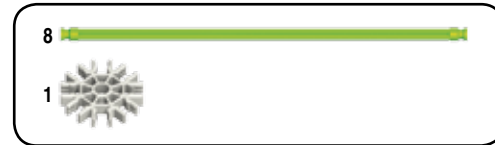
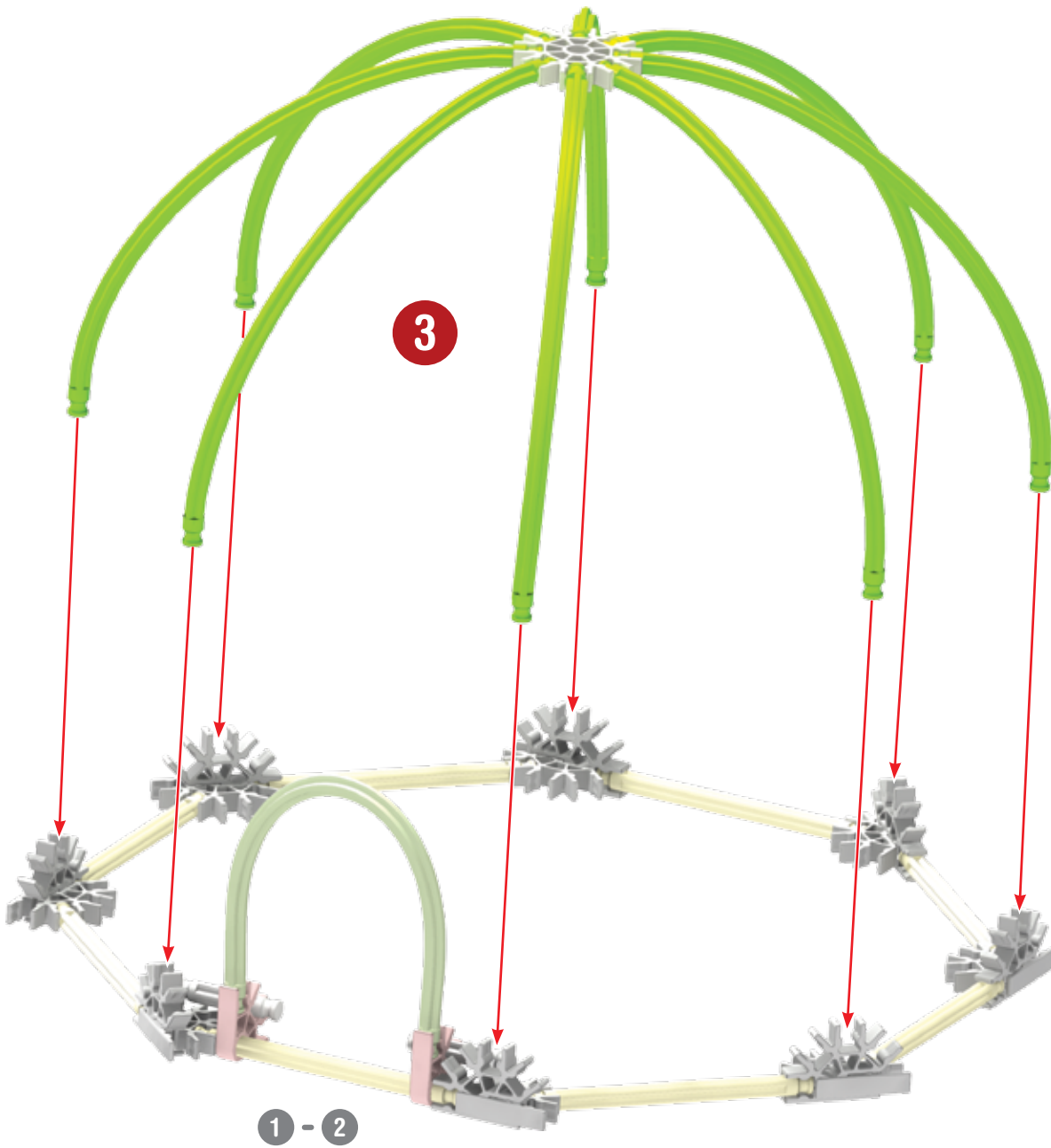

Leaning Tower

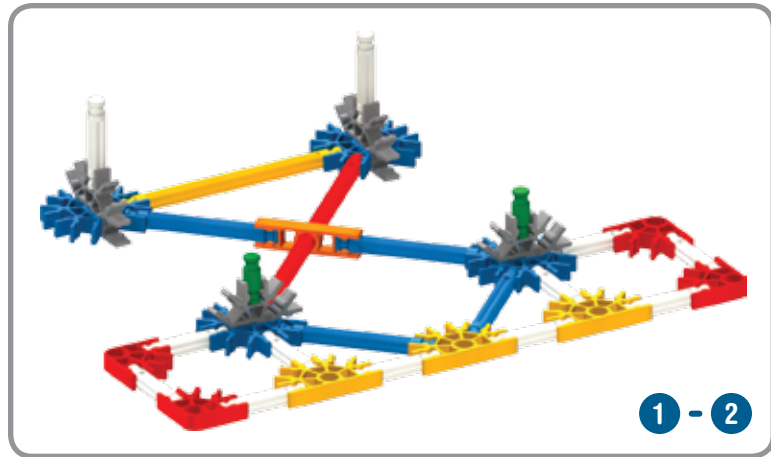
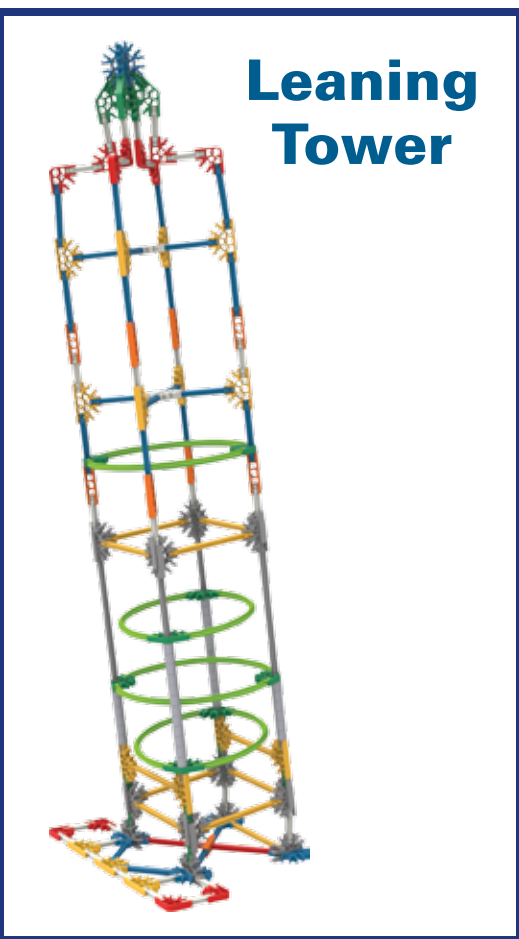

1 - 2

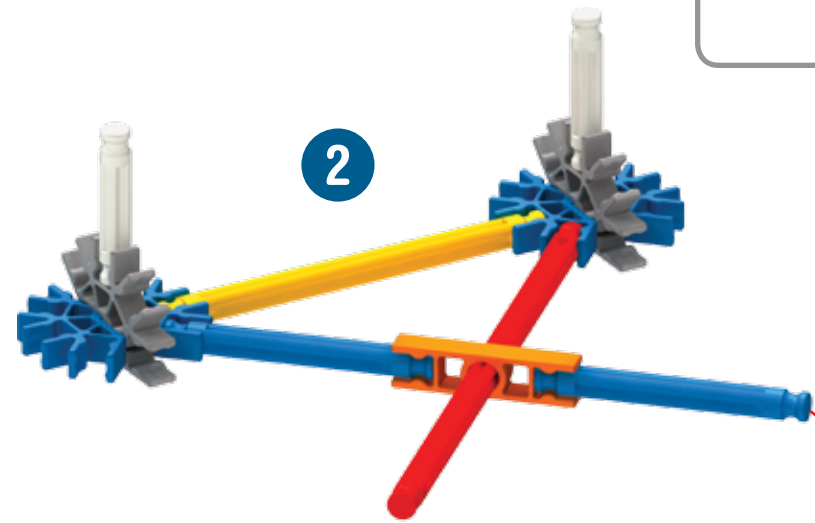

2

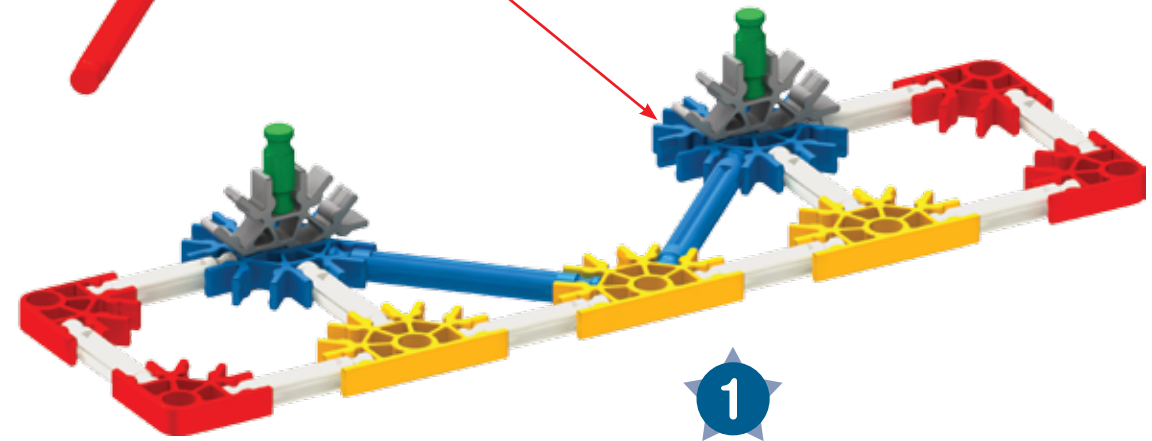

1

- | | | | | | |
|----|--|---|--|---|--|
| 2 | | 1 | | 4 | |
| 12 | | | | | |
| 4 | | | | | |
| 1 | | | | | |
| 1 | | | | | |
| 3 | | 4 | | 4 | |

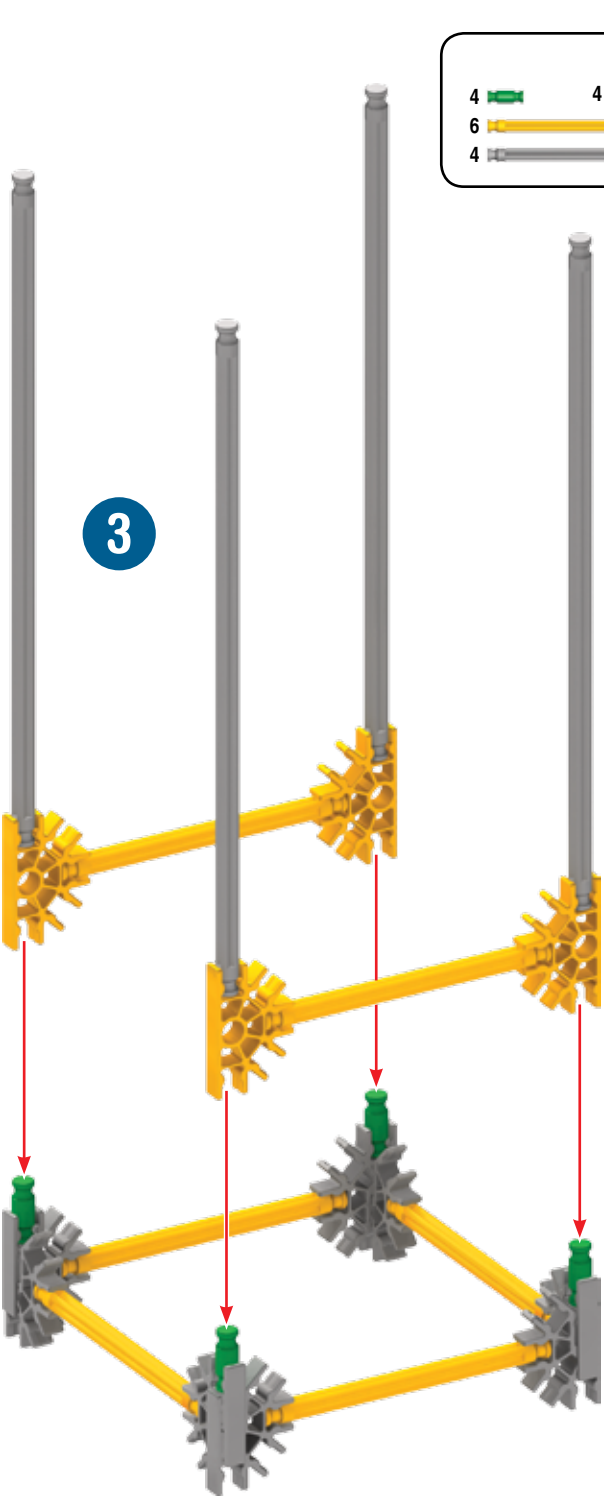

3

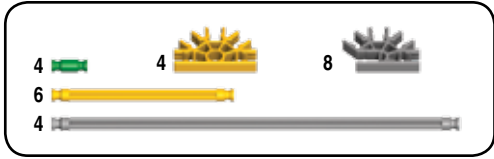

x3

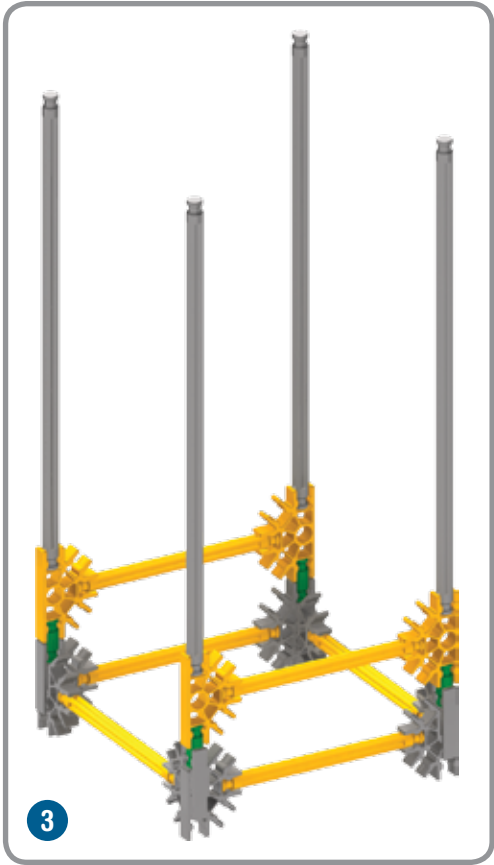

3

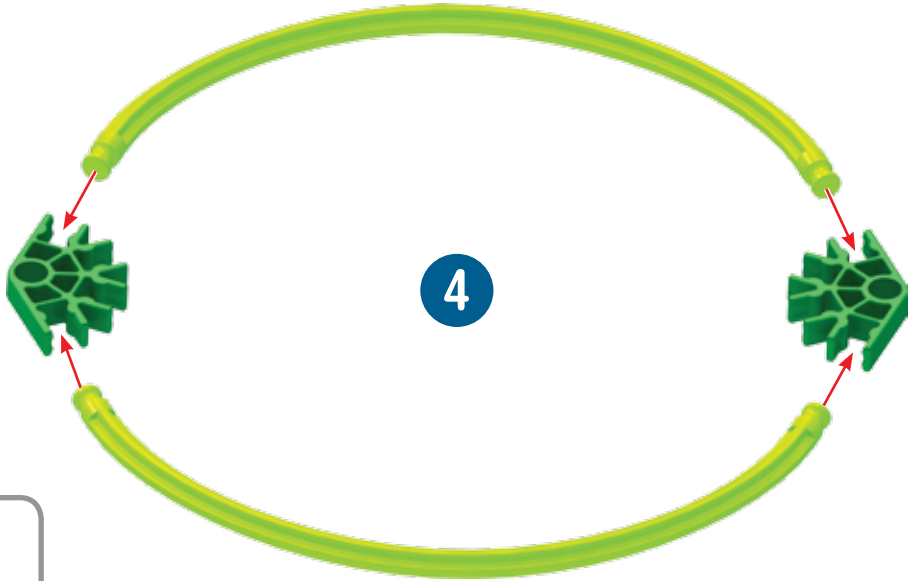

4

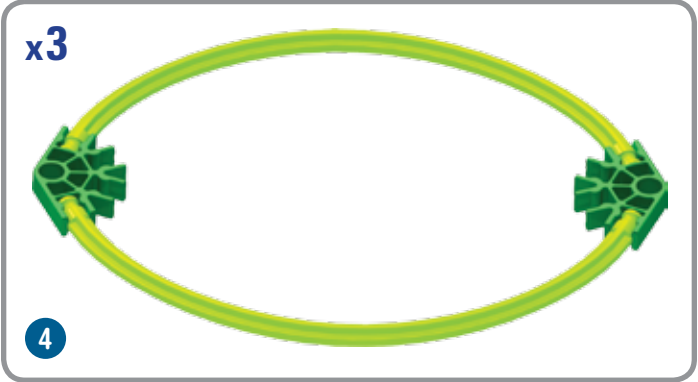

x3

4

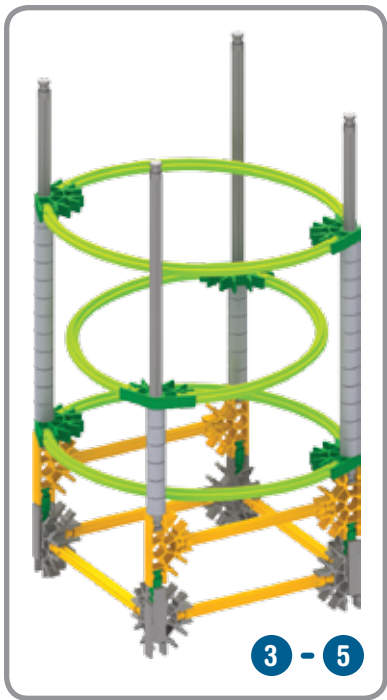

5

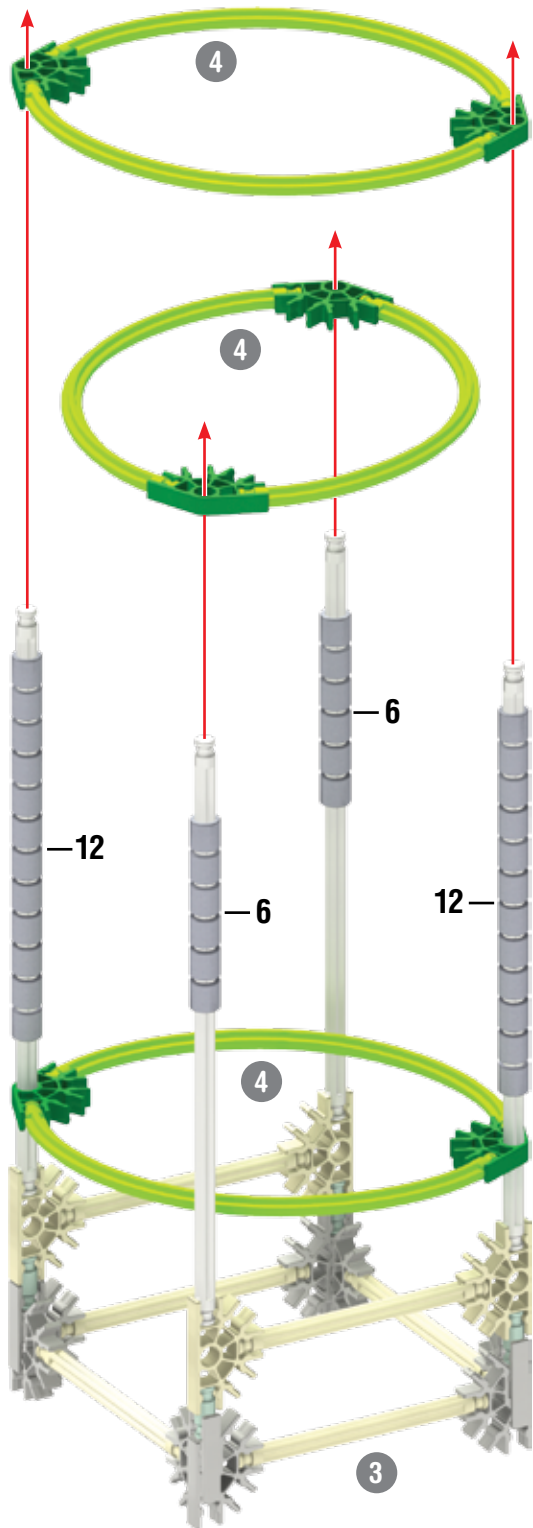

6

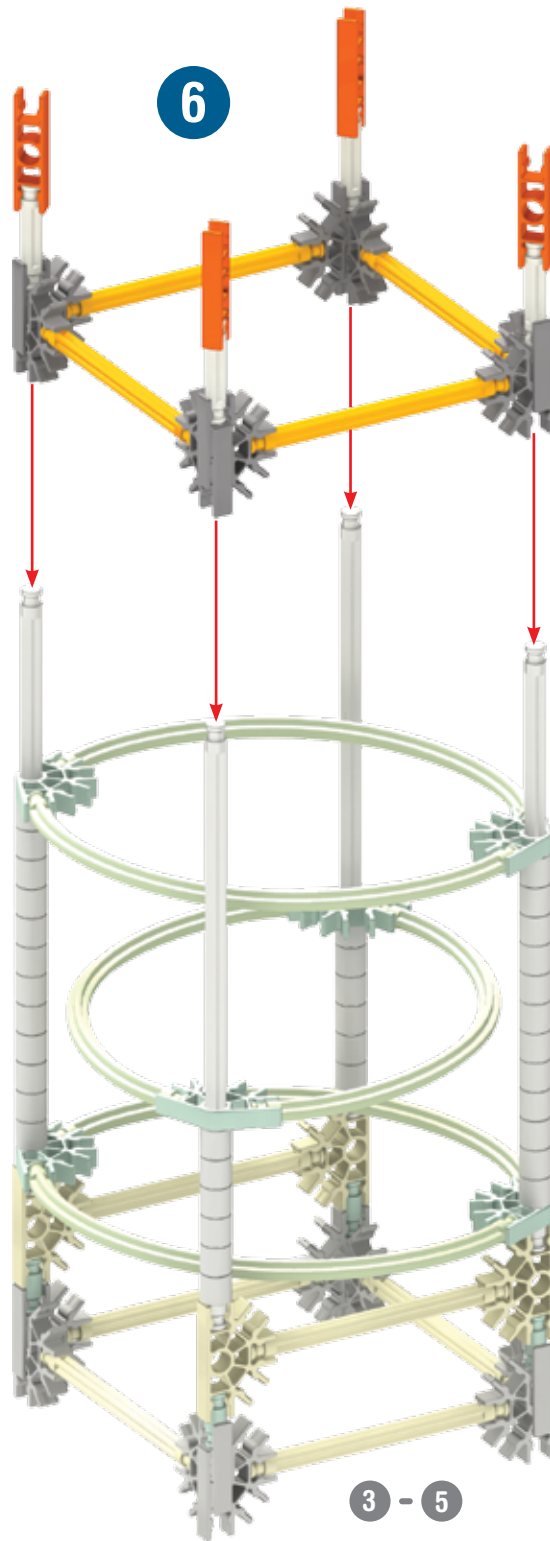

- 4
- 4
- 4
- 8

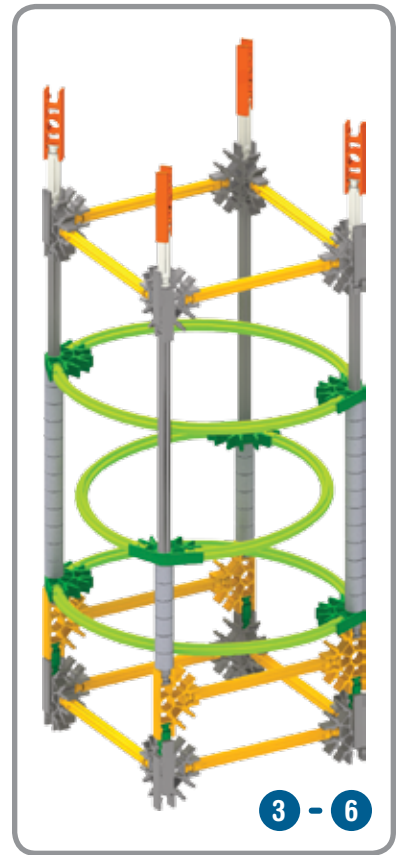

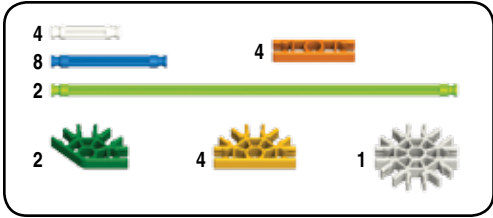

7

3 - 6

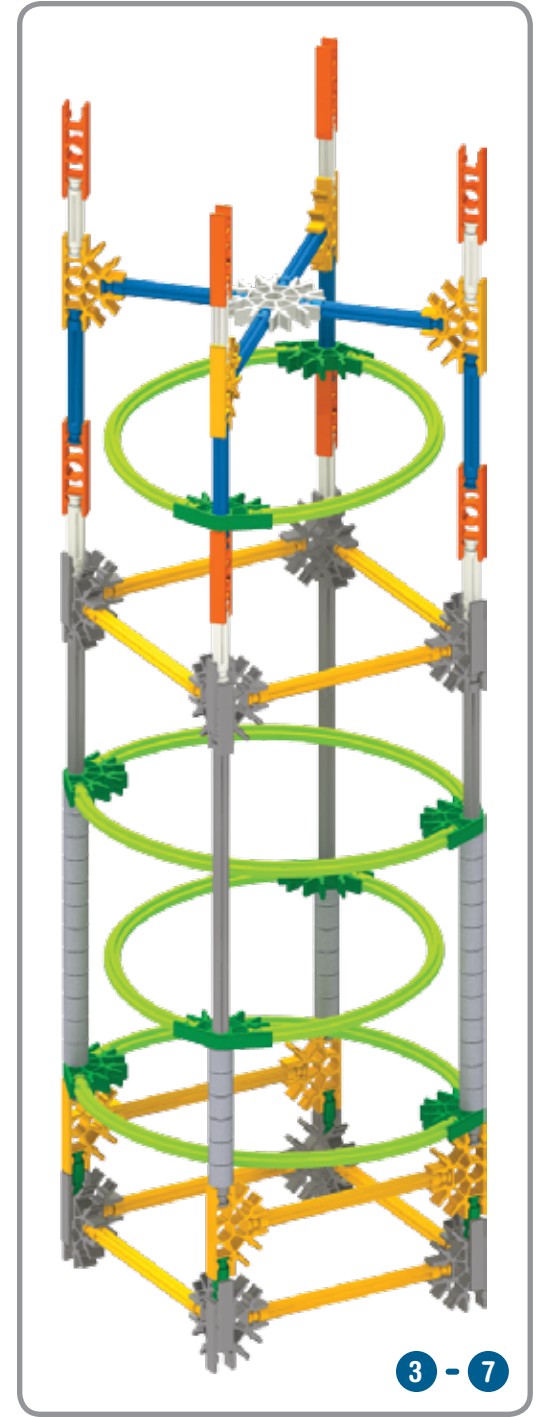
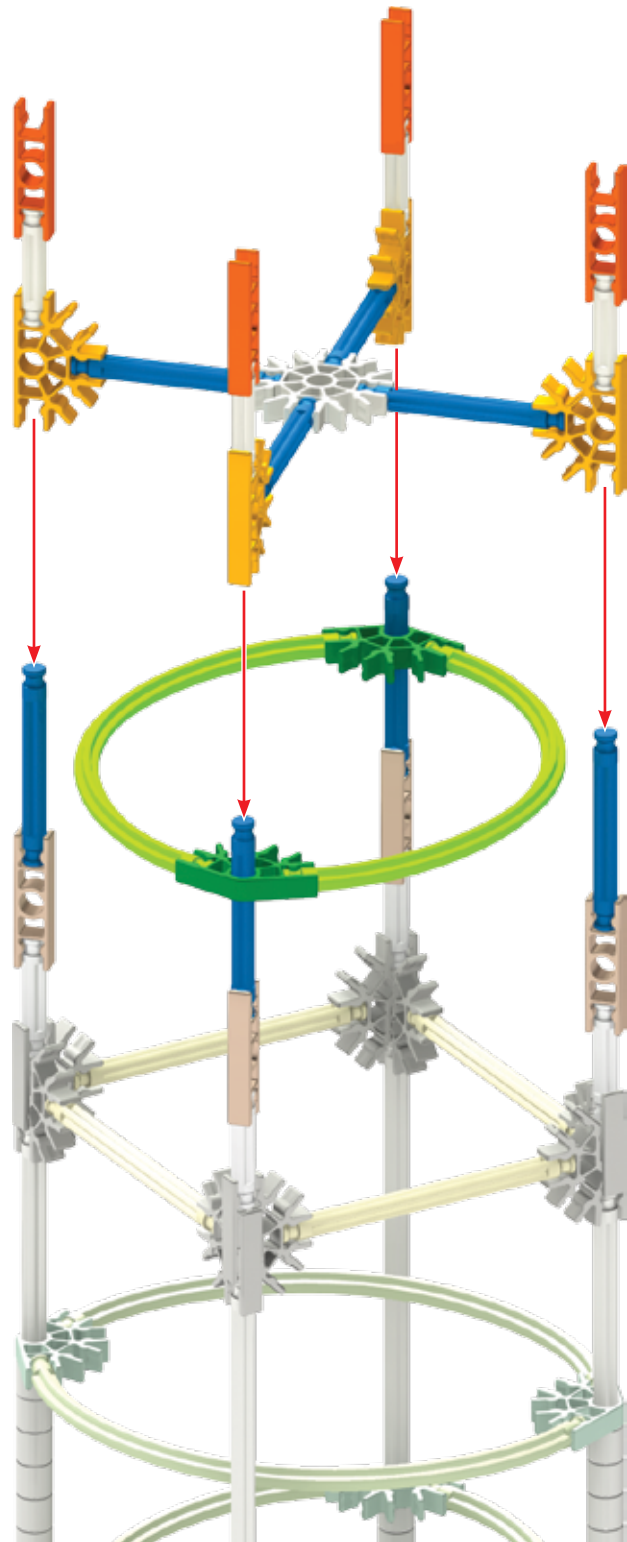

3 - 7

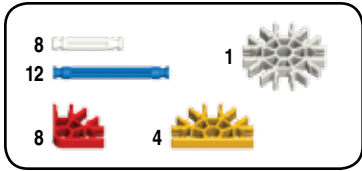

8

3 - 7

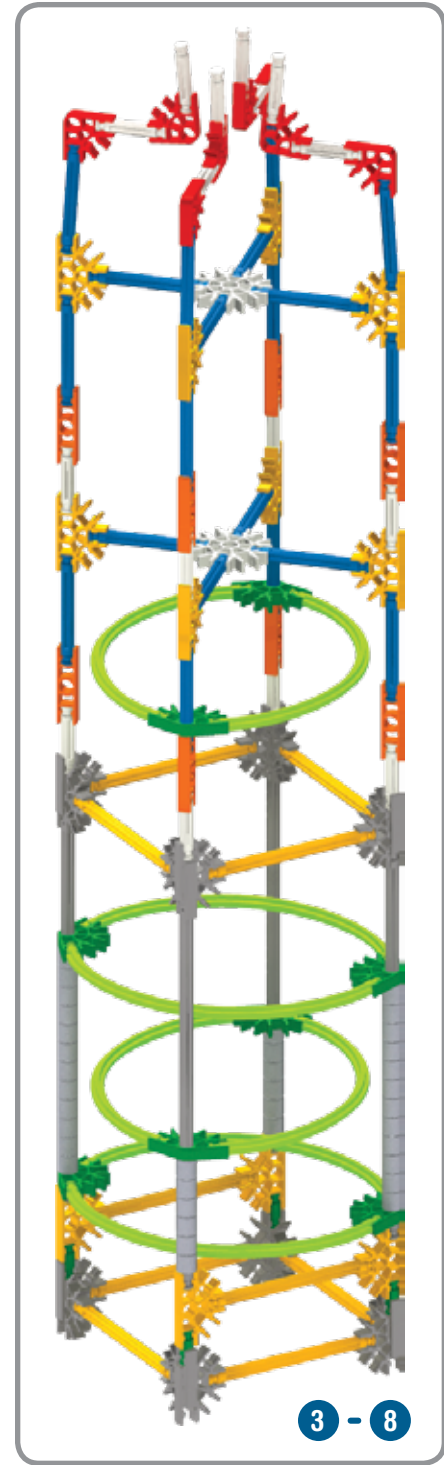
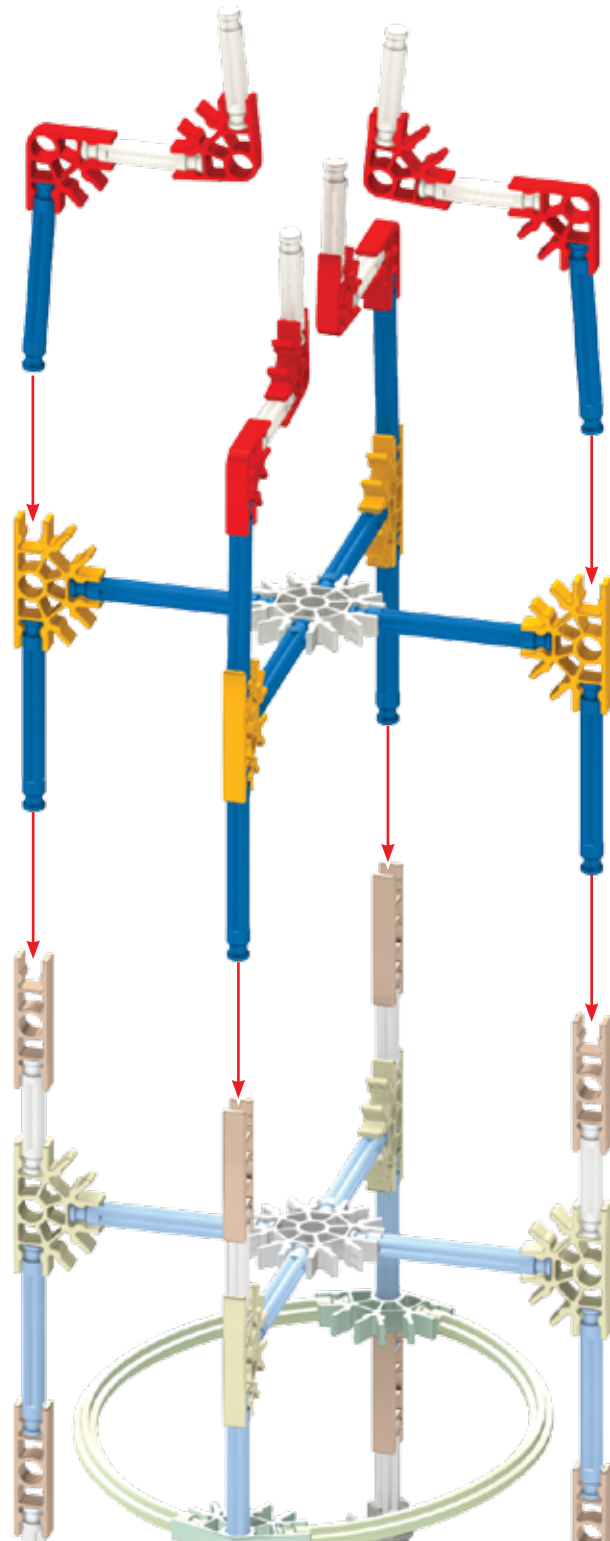

3 - 8

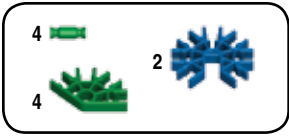

9

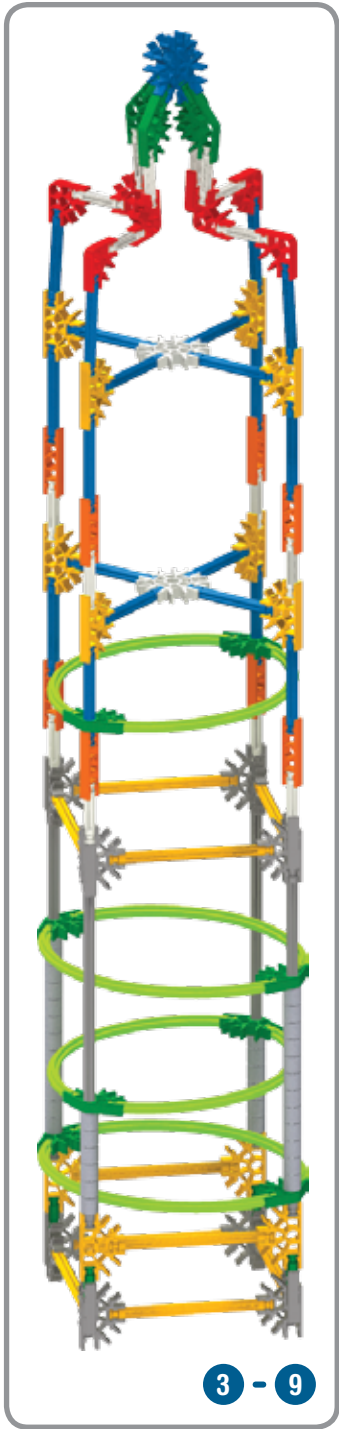
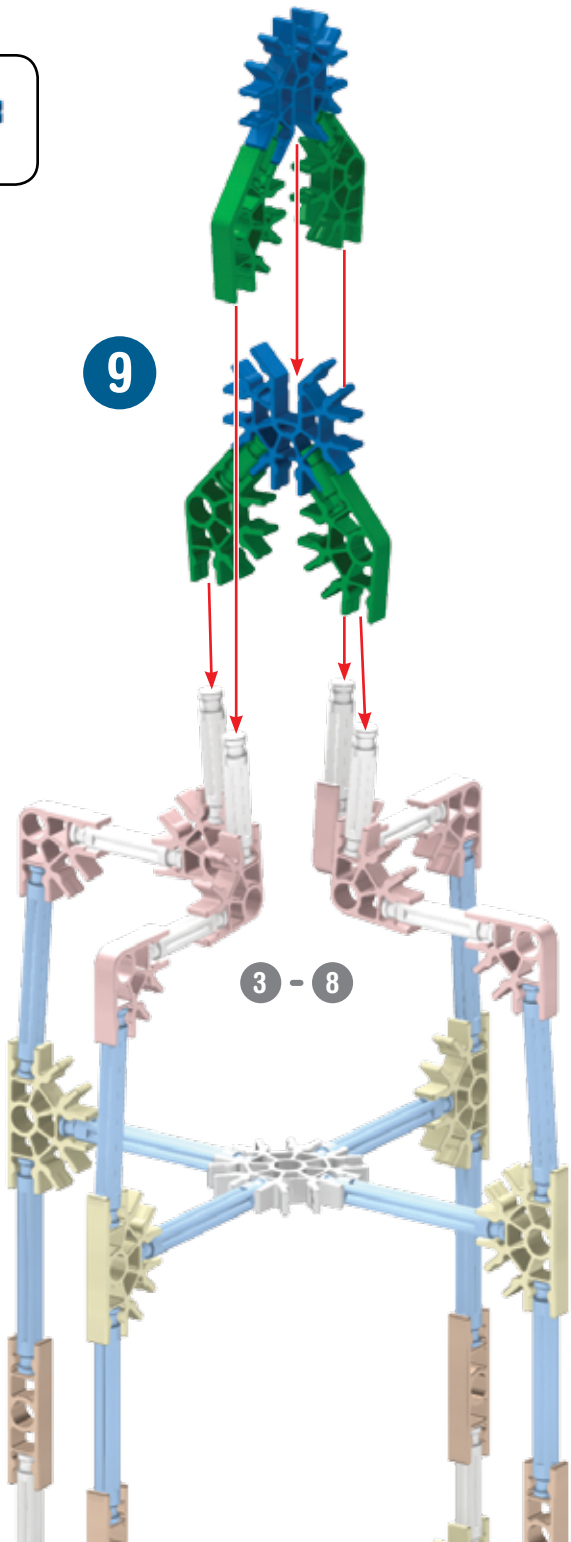

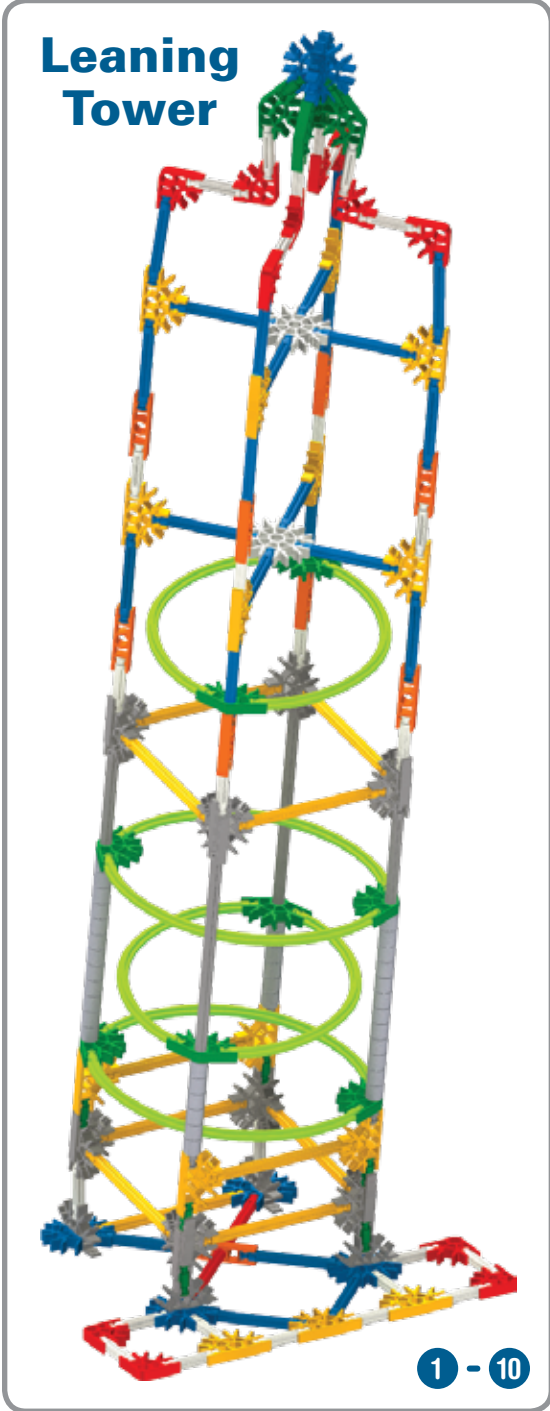
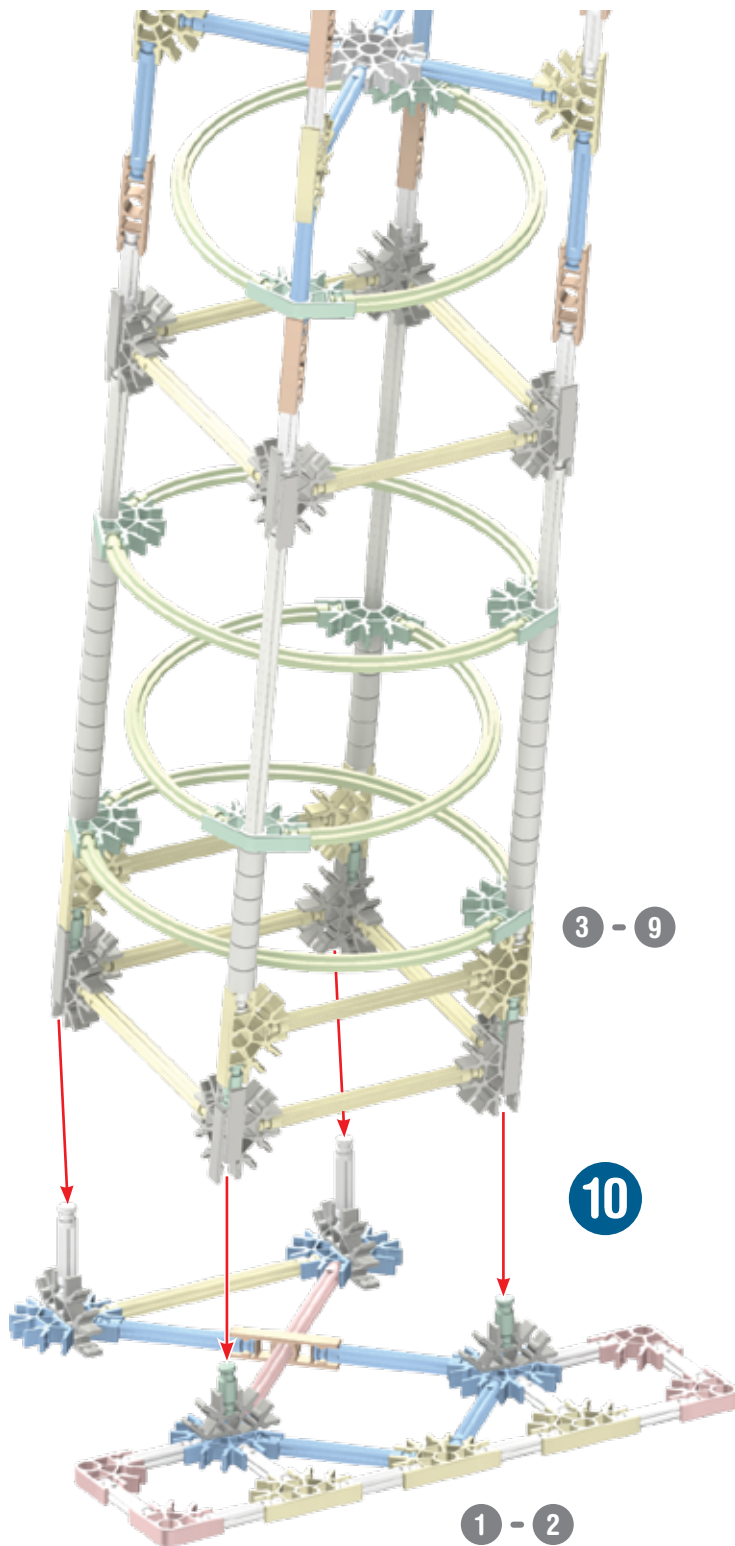

Mayan Pyramid

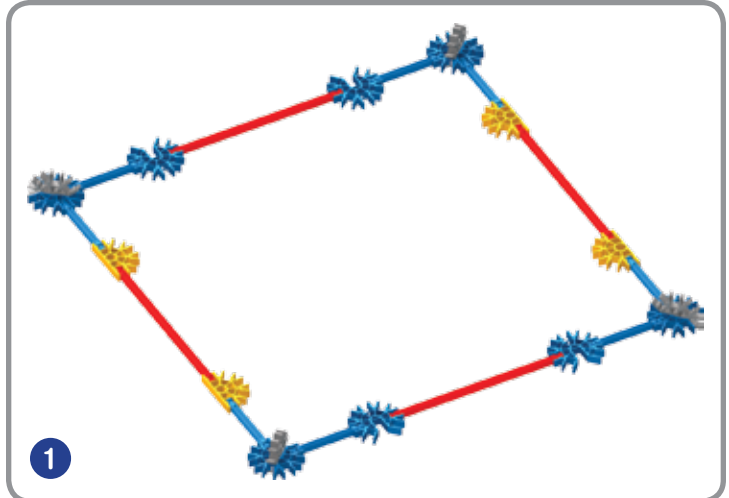
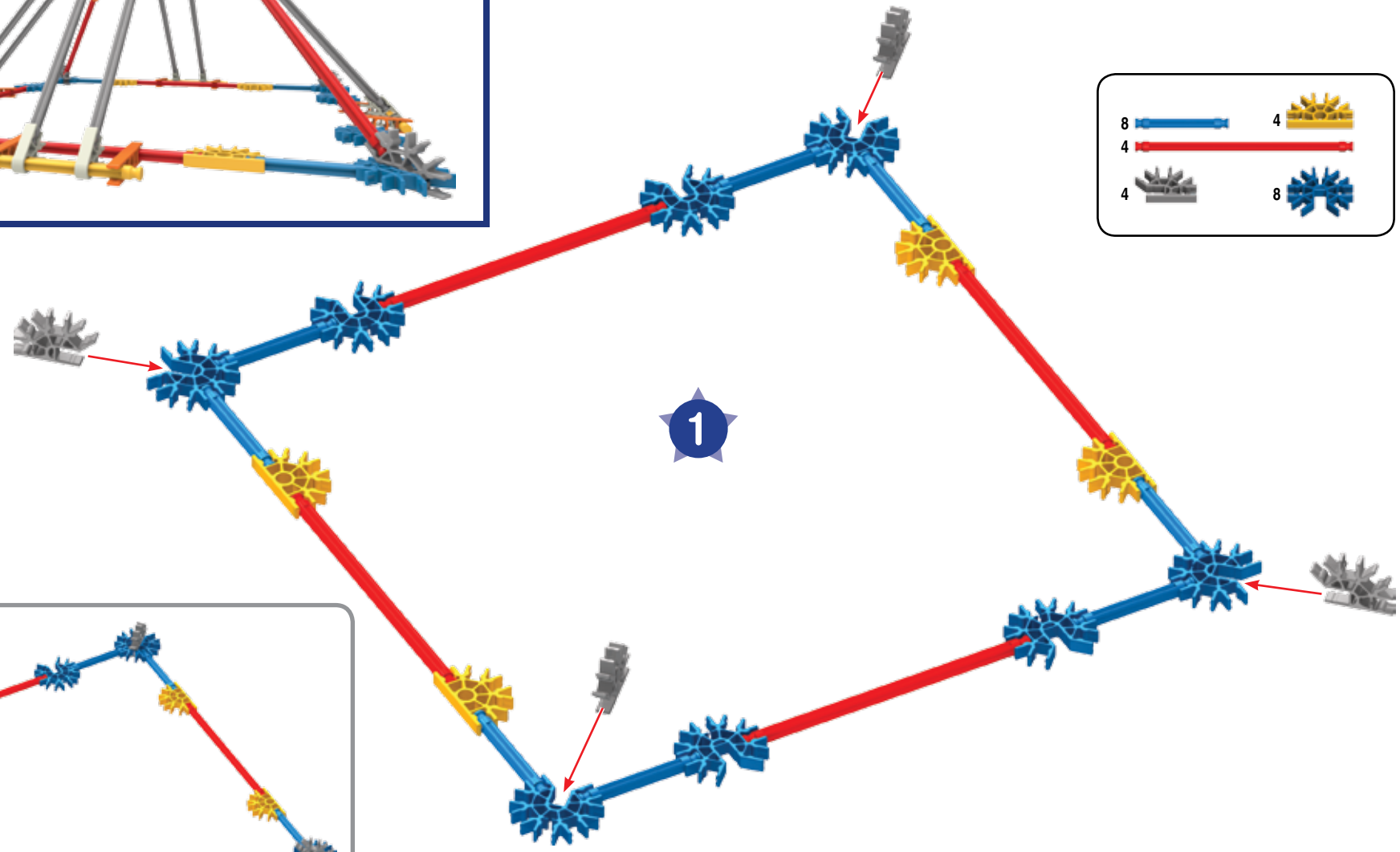
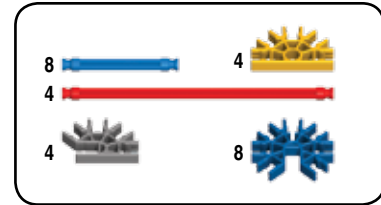

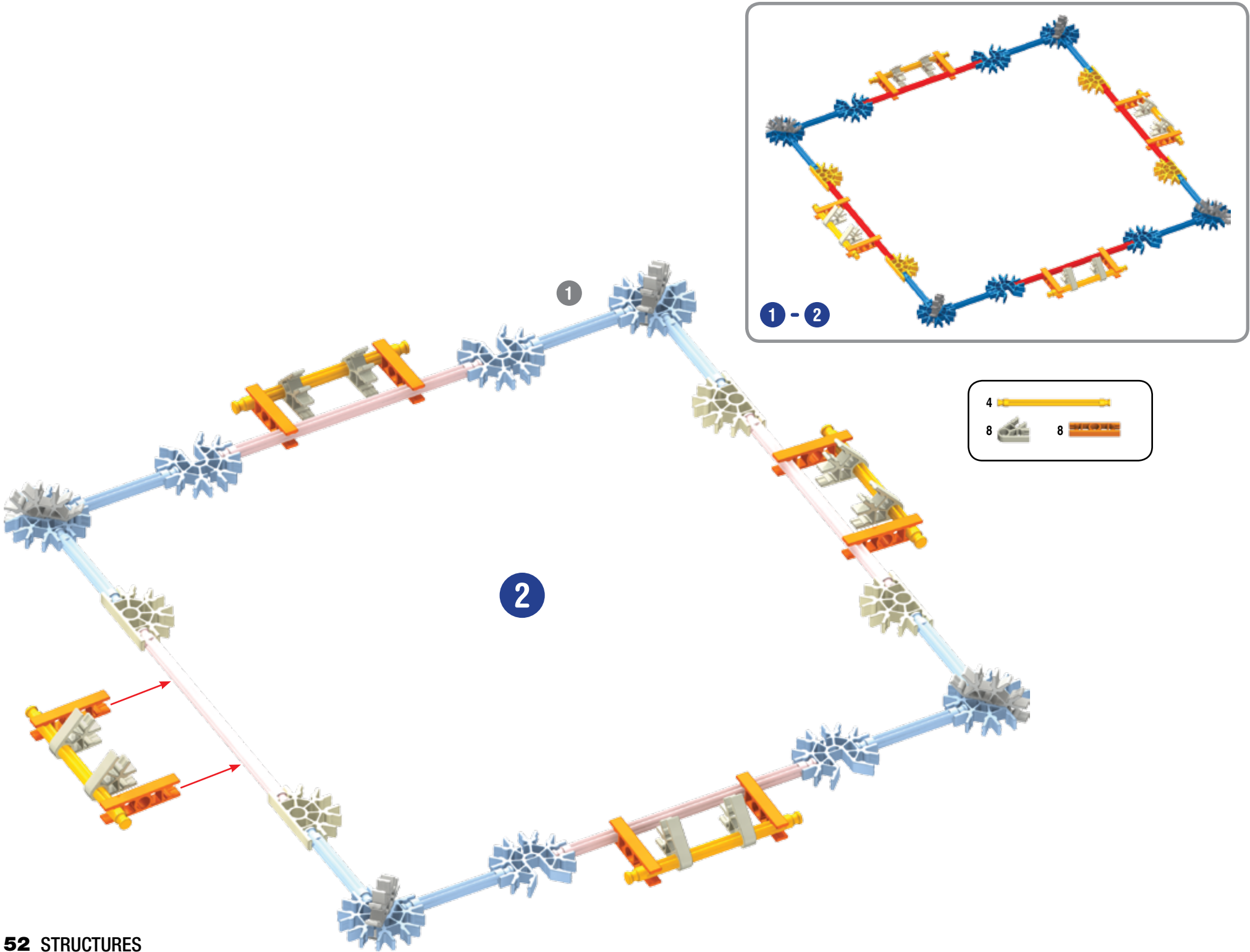

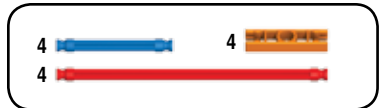
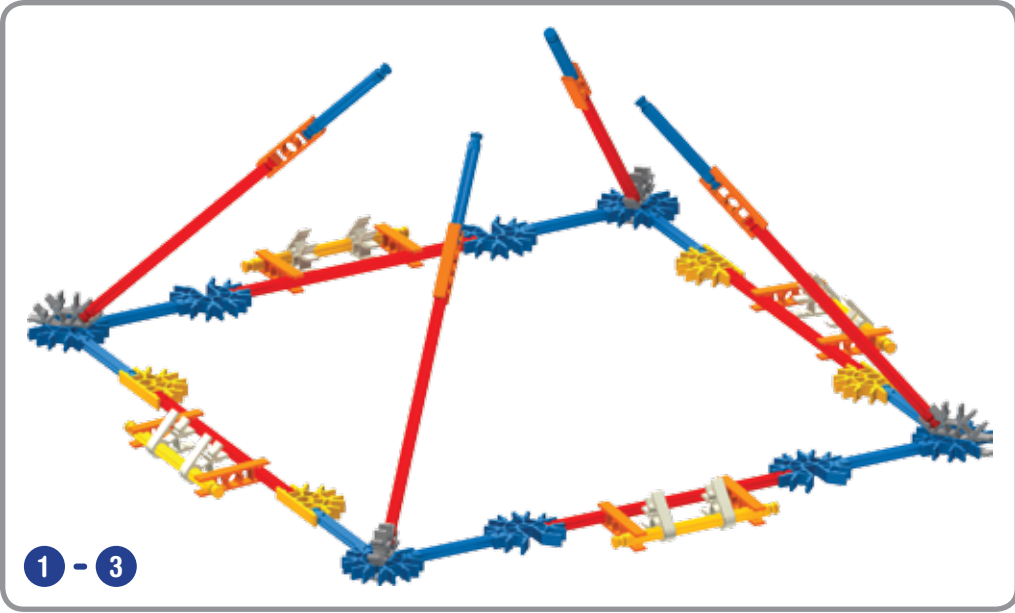
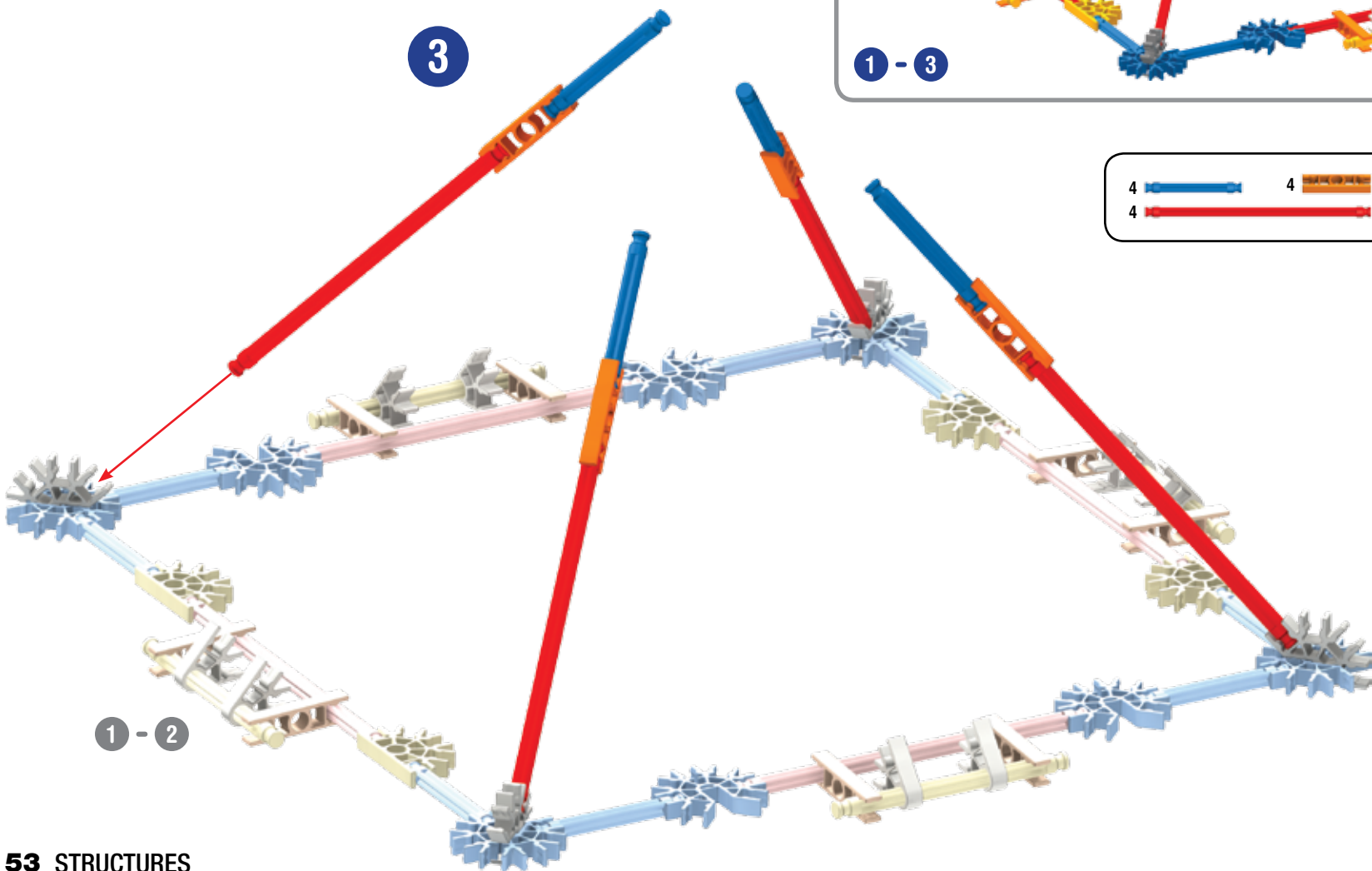

x4

4

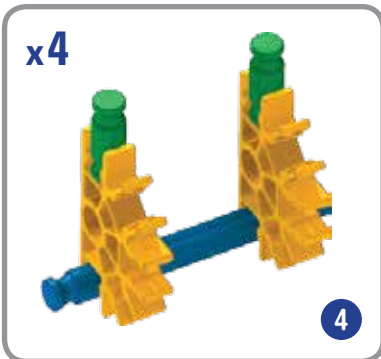
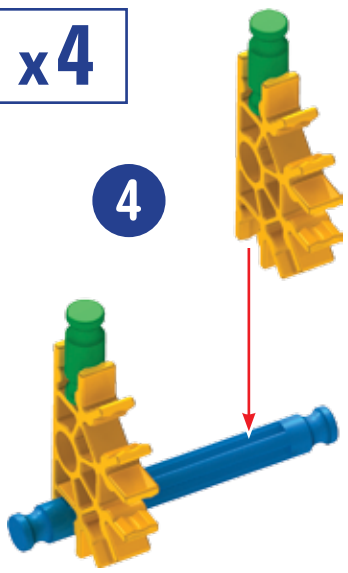

x4

4

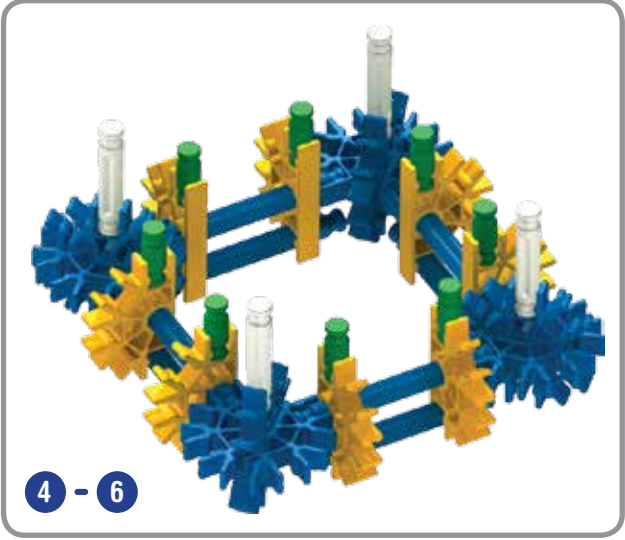

4 - 6

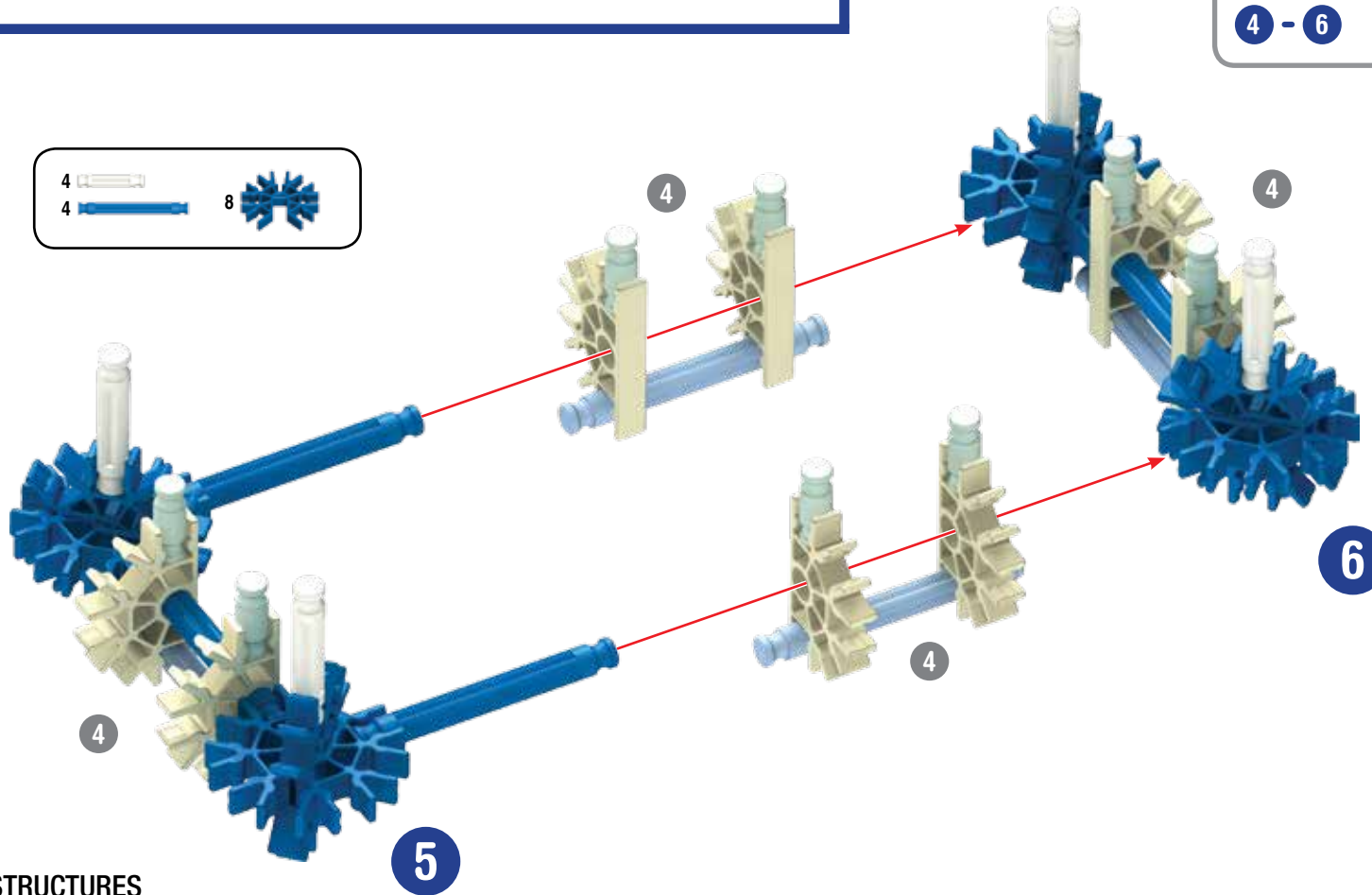
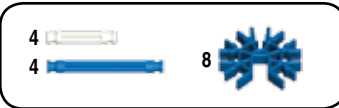

4

4

4

6

5

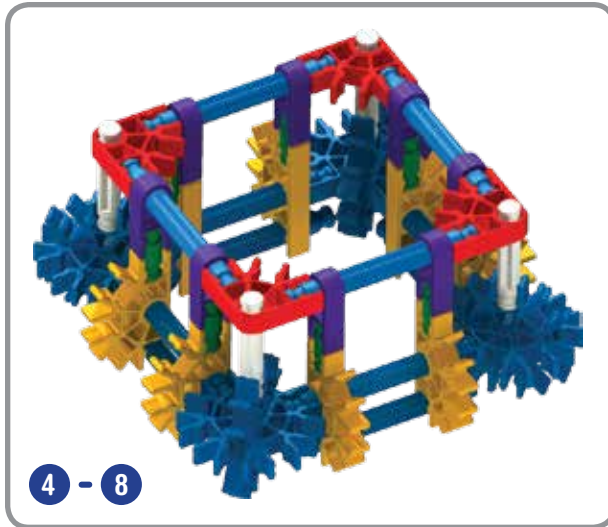
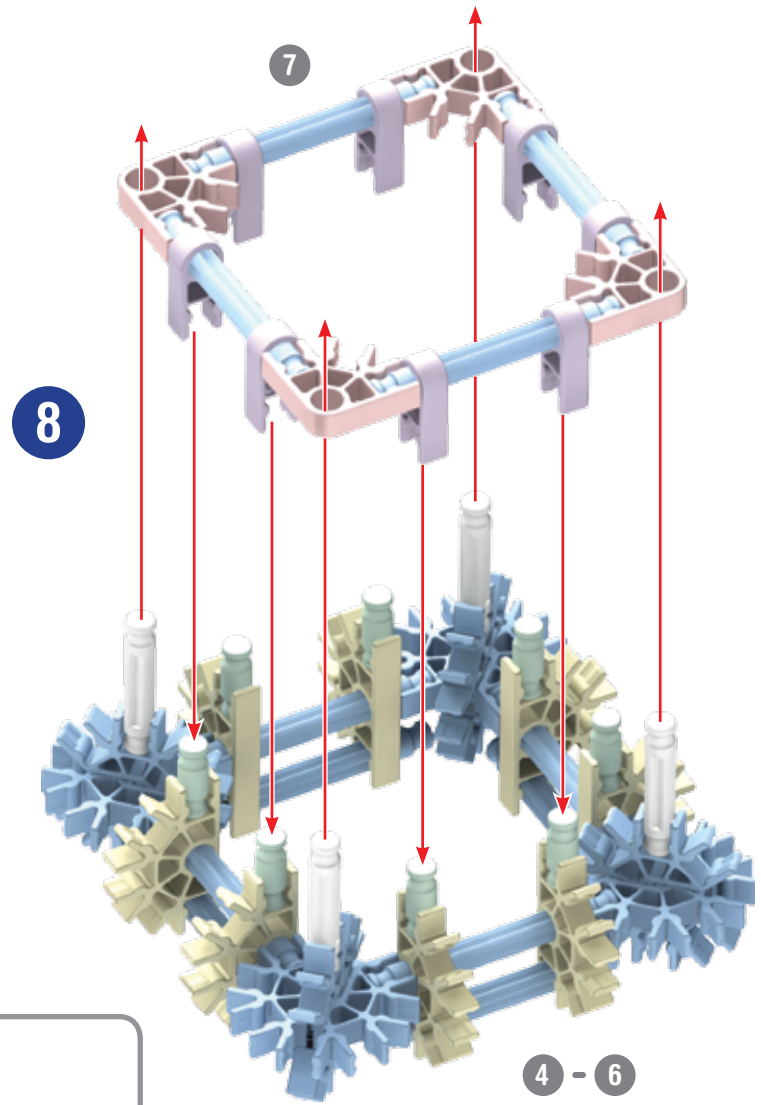
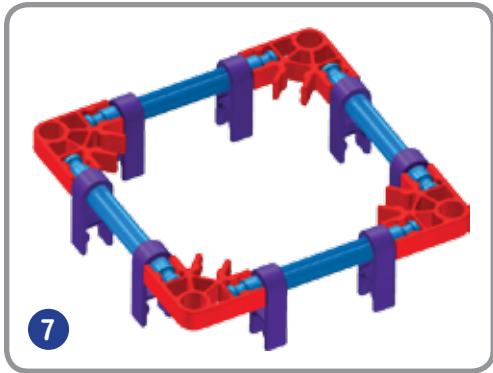
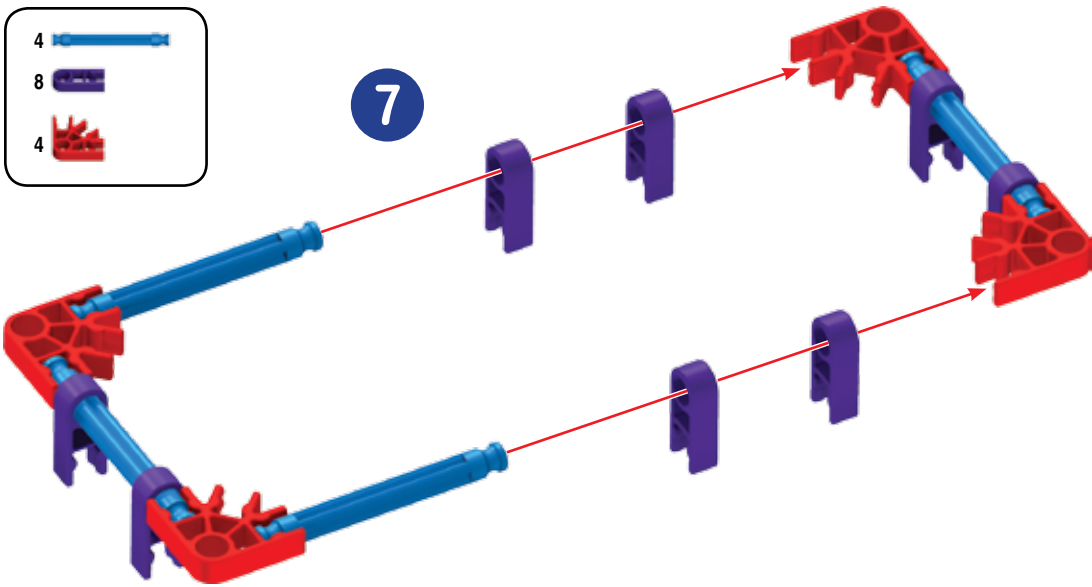
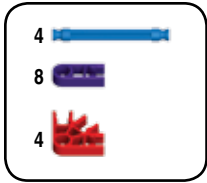

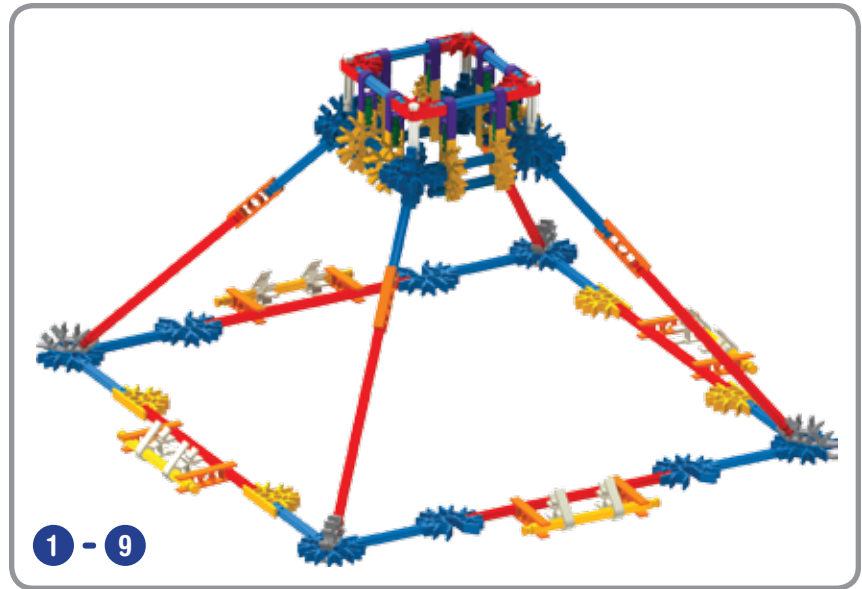
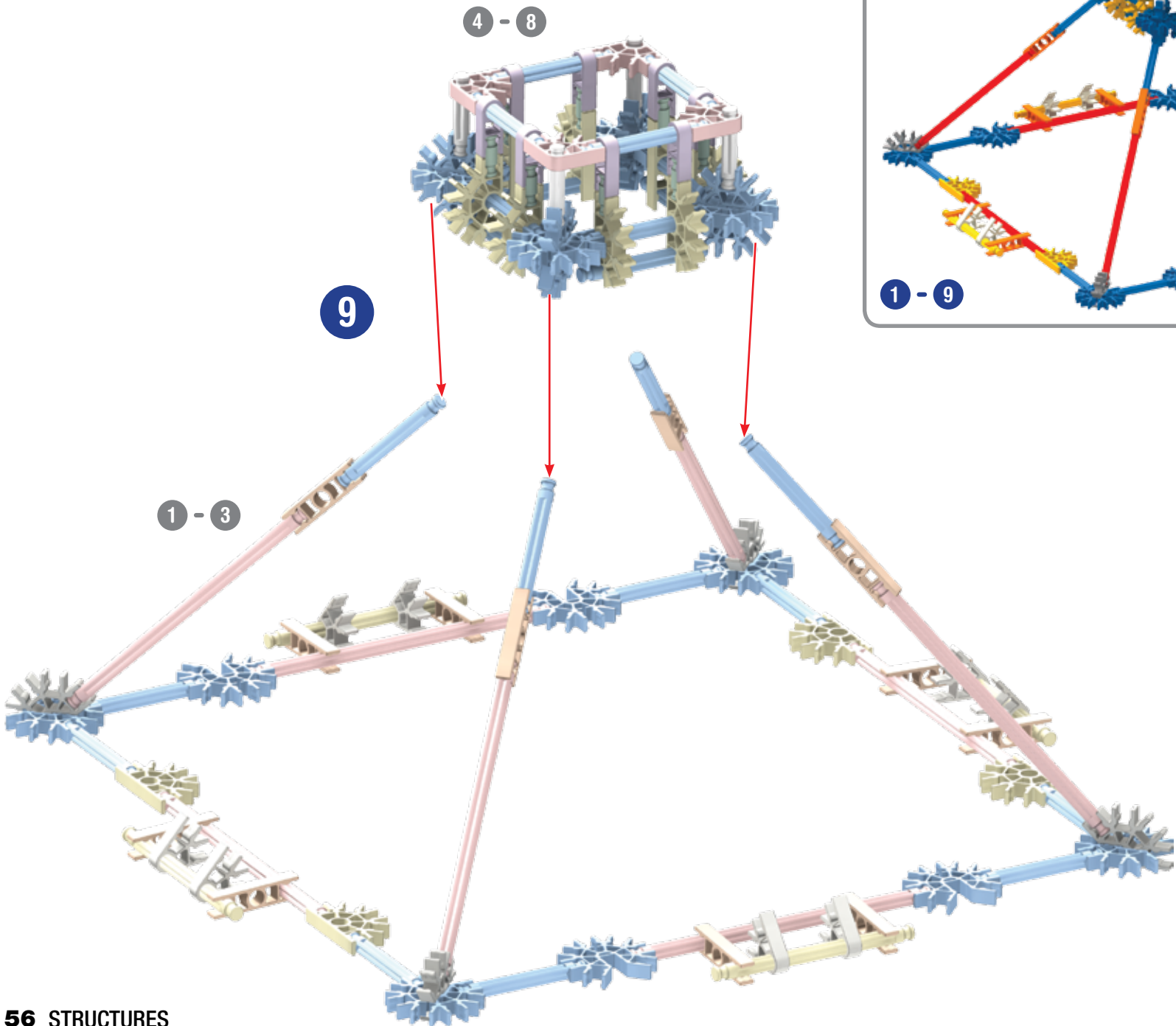

Mayan Pyramid

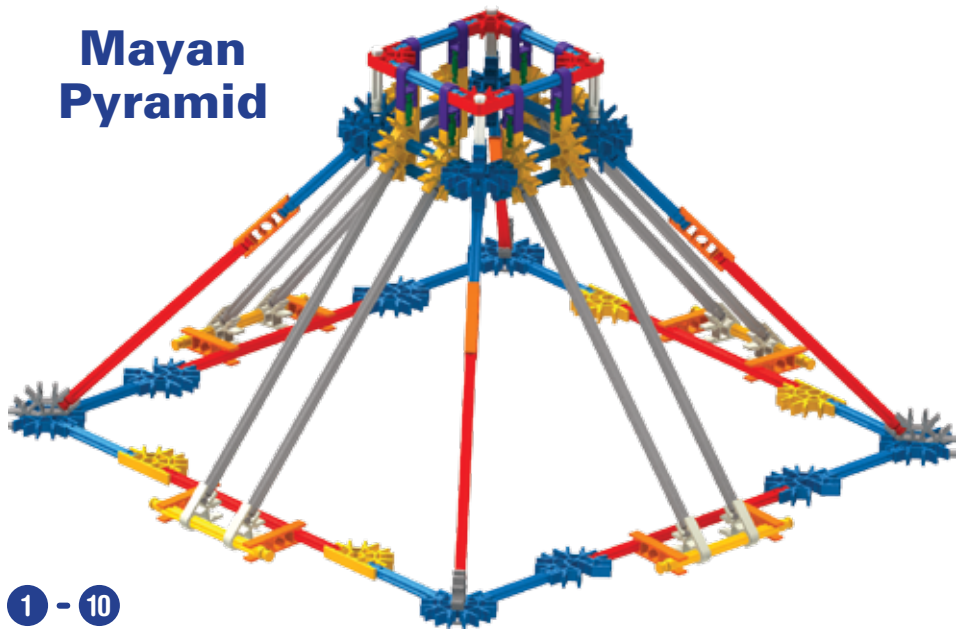

1 - 10



10

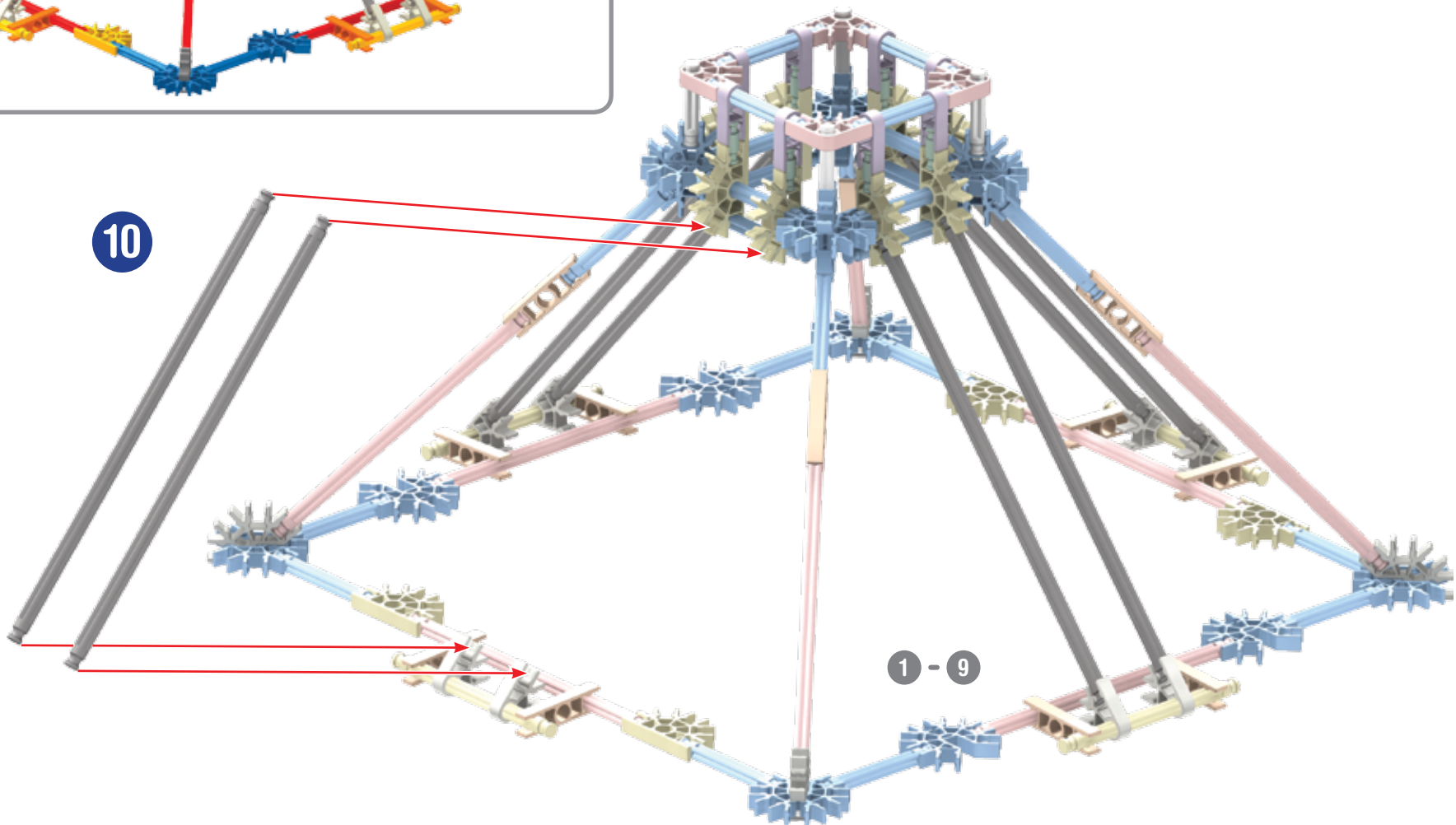

1 - 9

Observation Tower

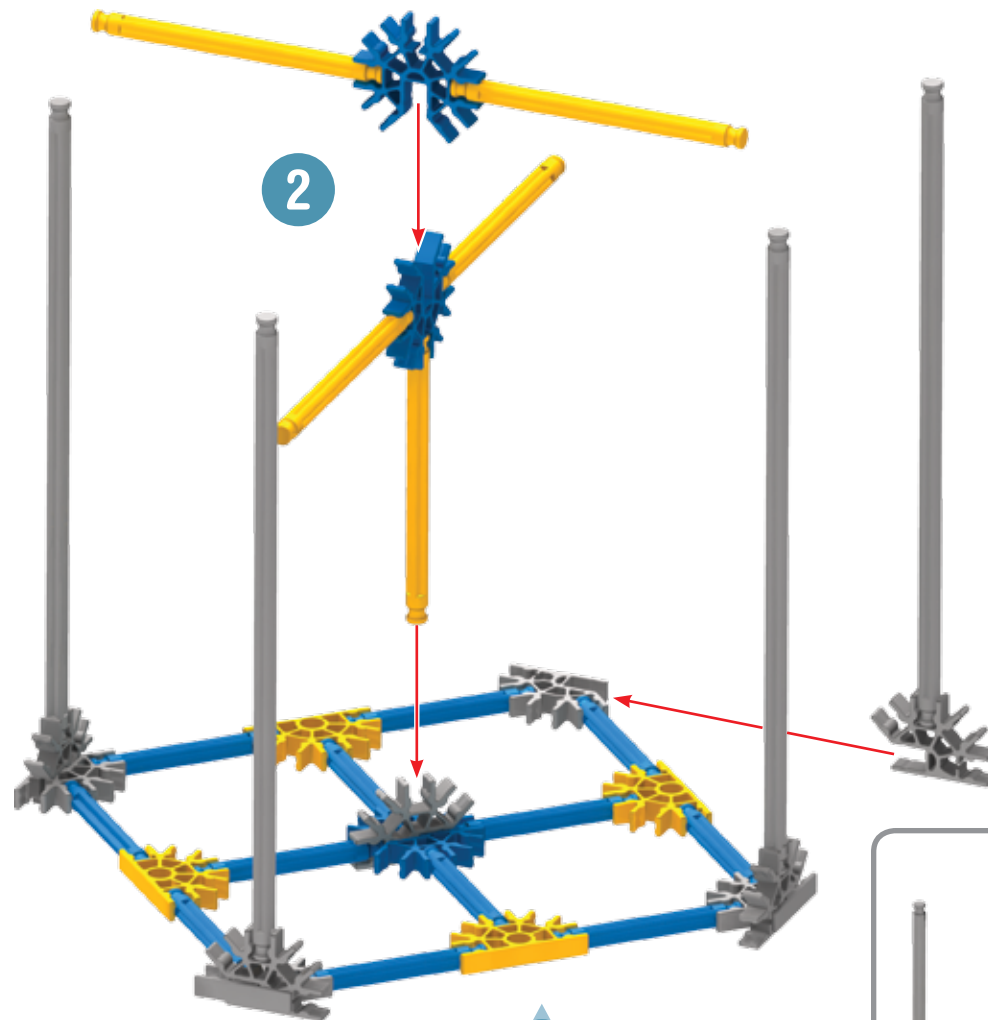
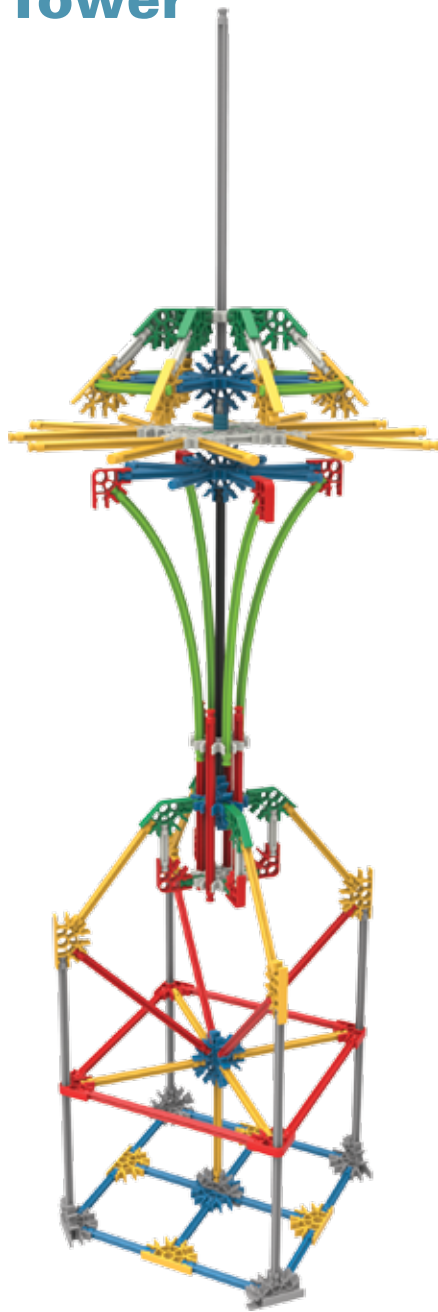

1

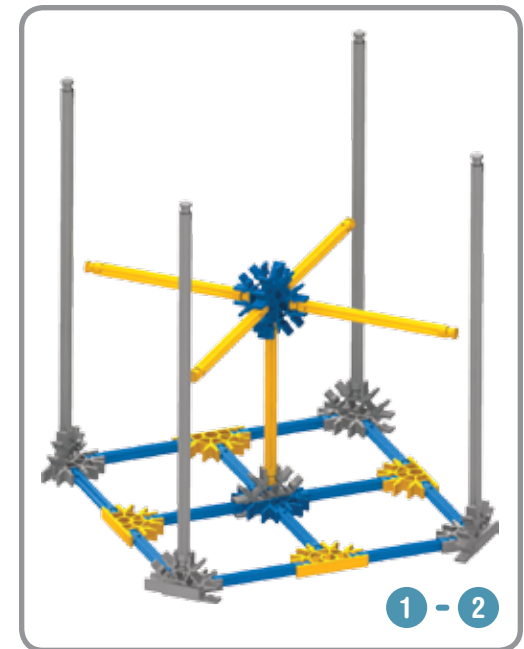
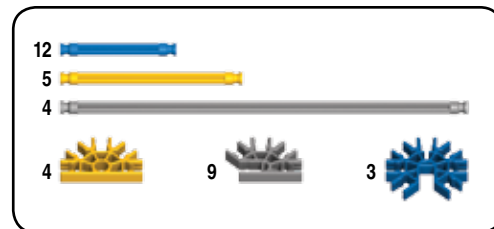

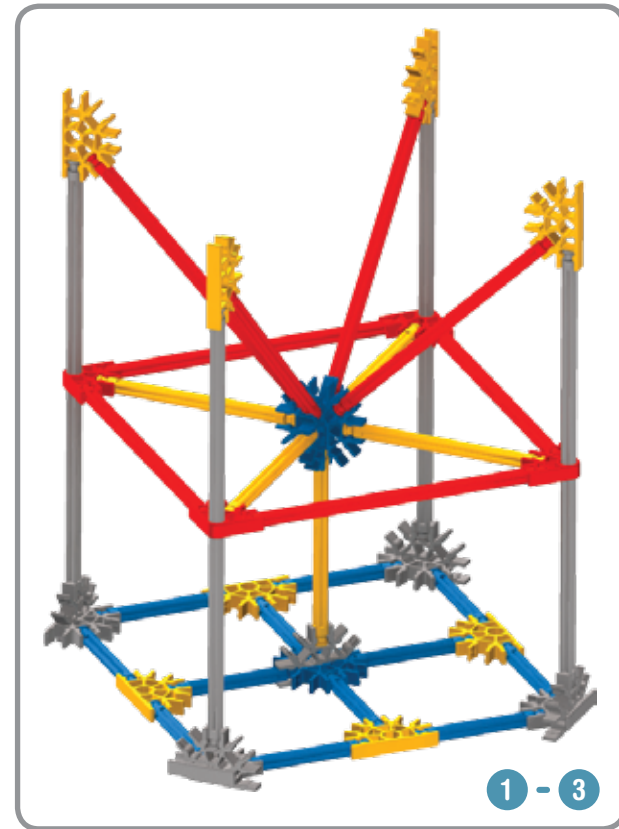
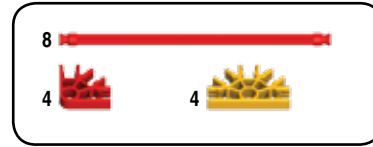
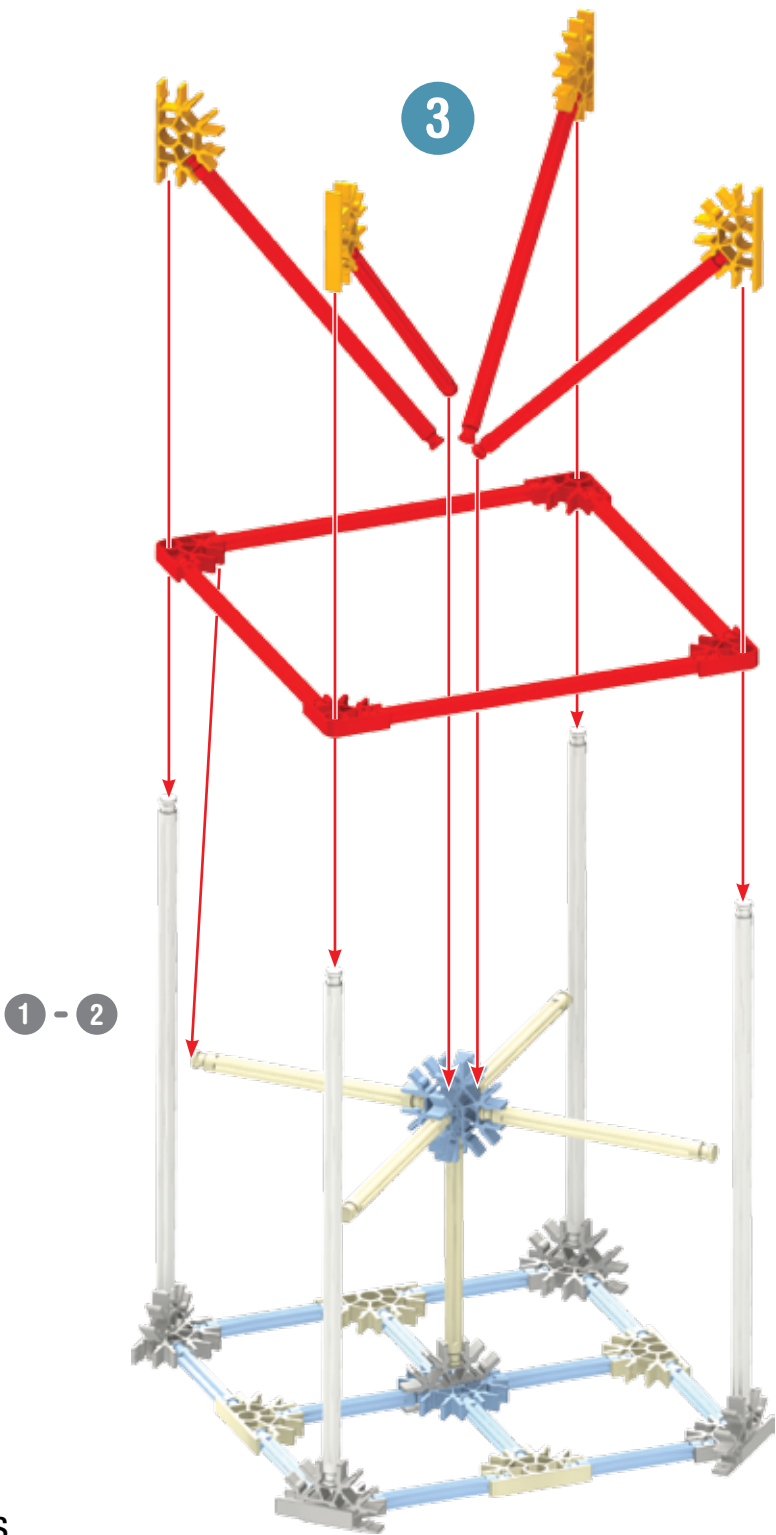

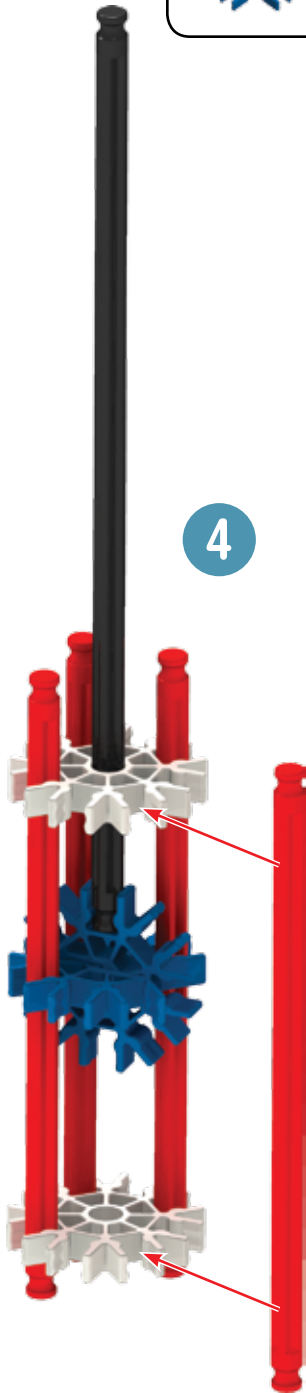
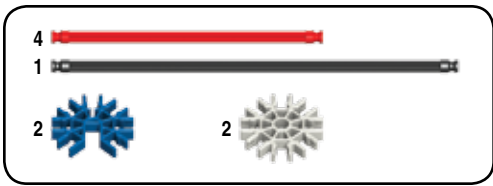
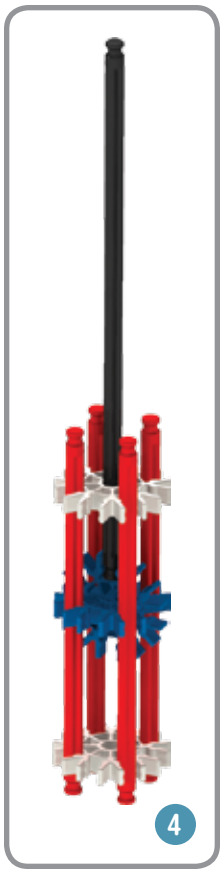

4

4

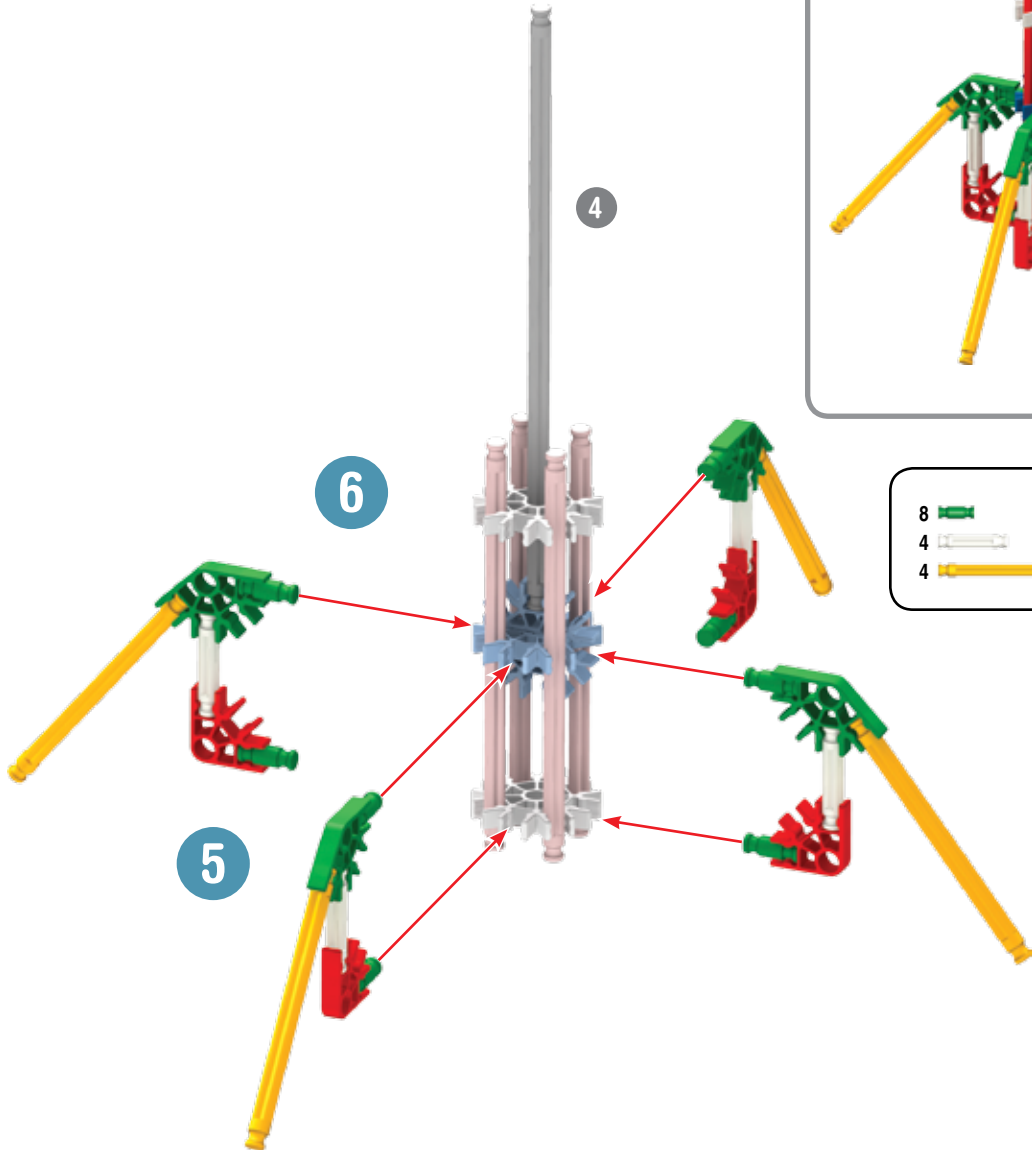

4

6

5

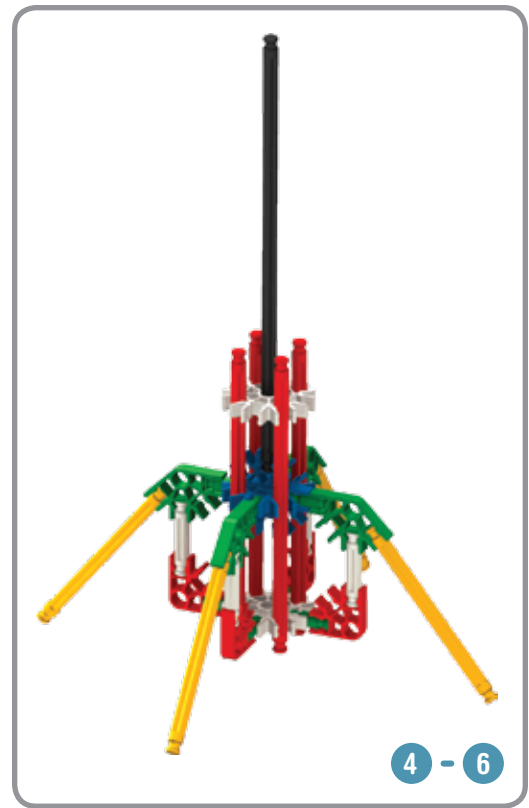

4 - 6

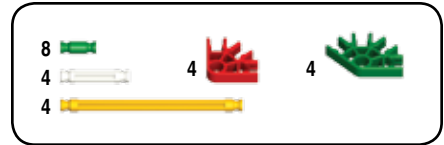

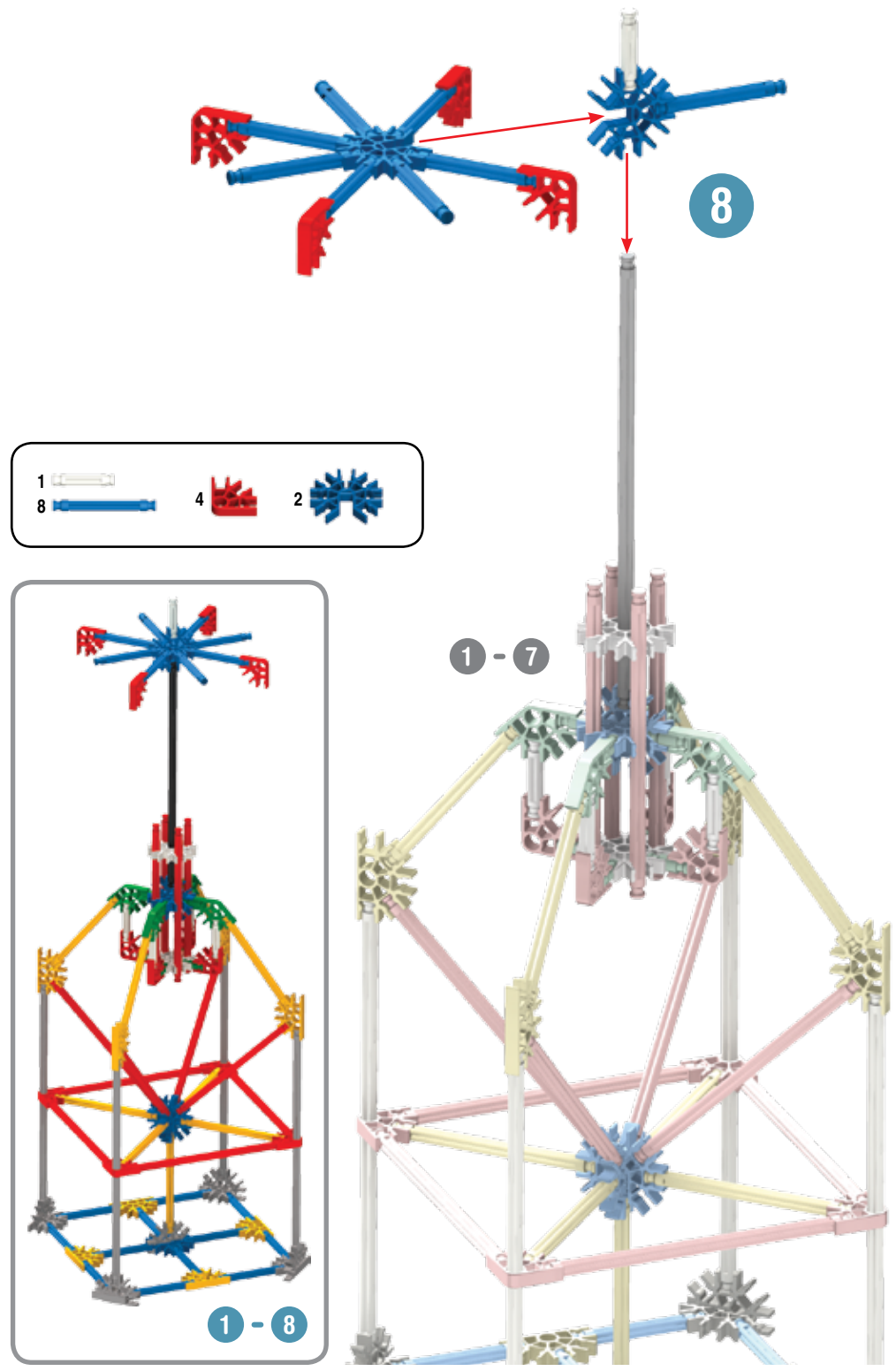
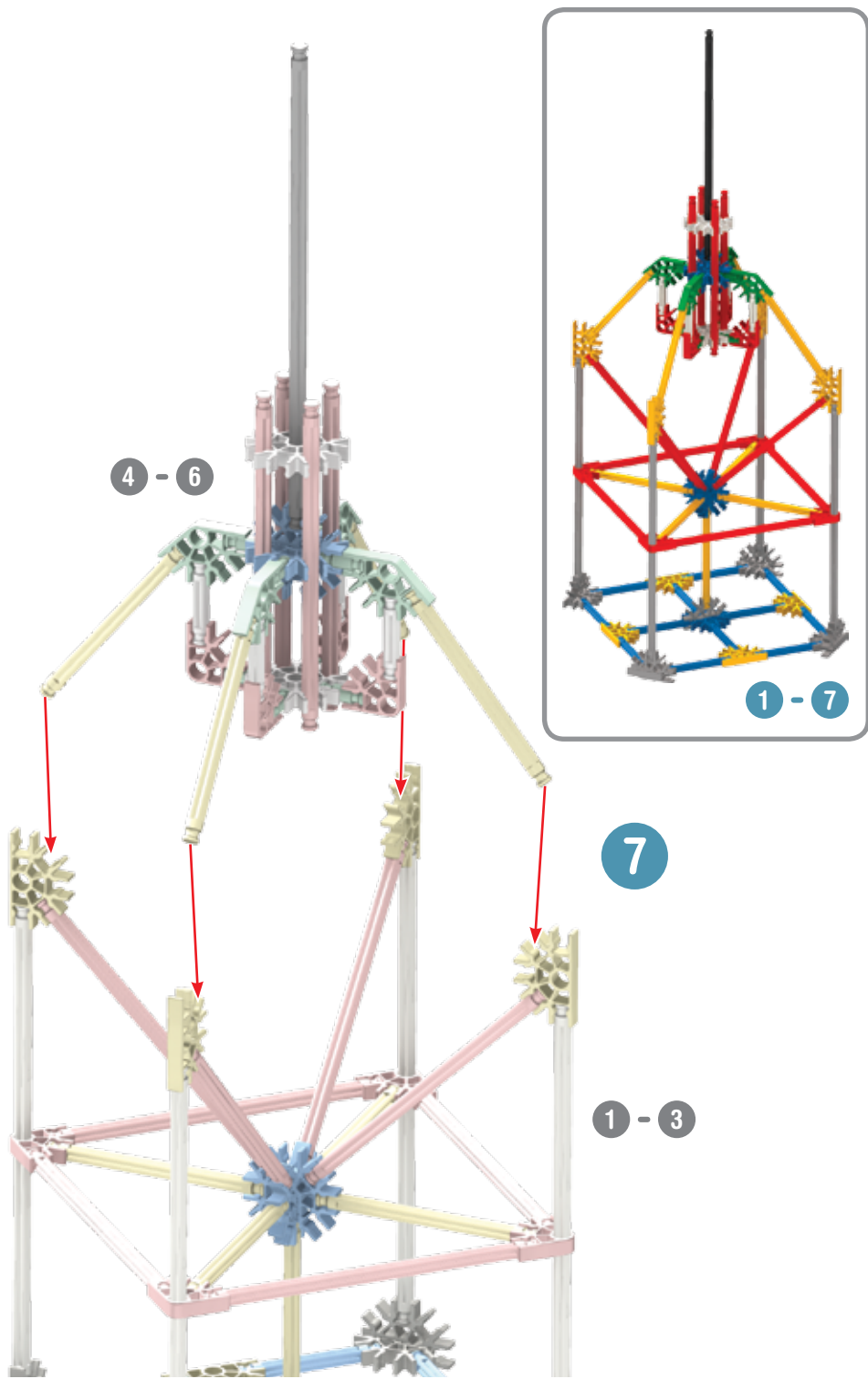

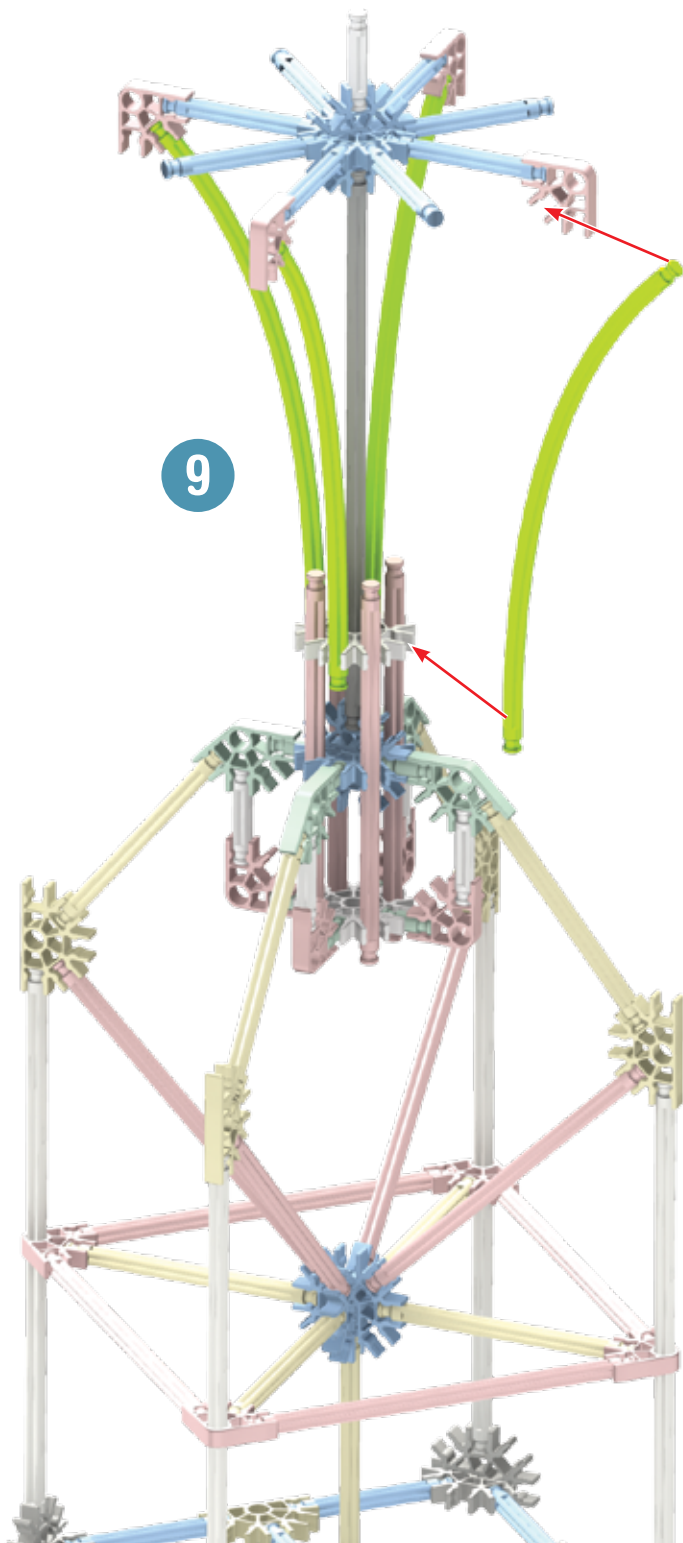

1 - 8

9

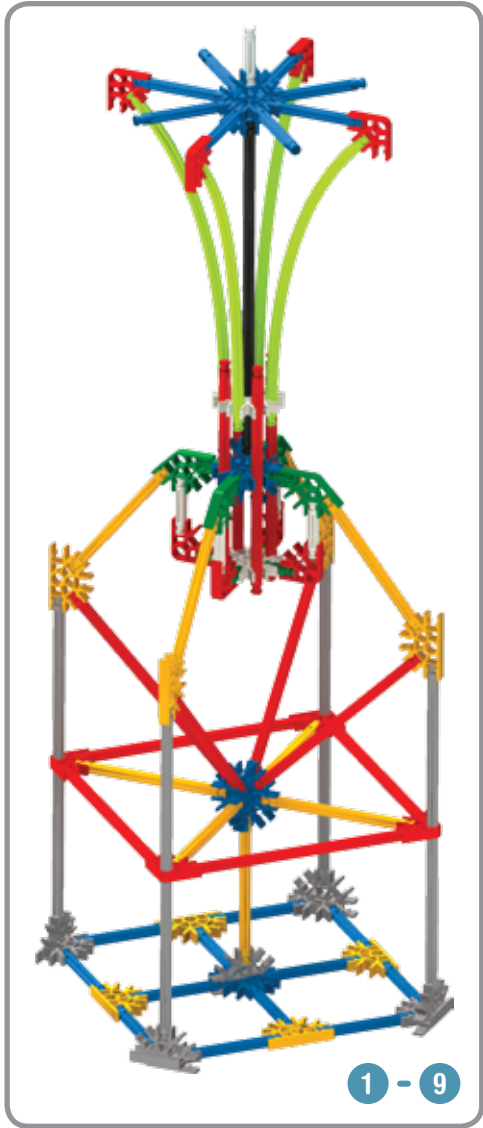

1 - 9

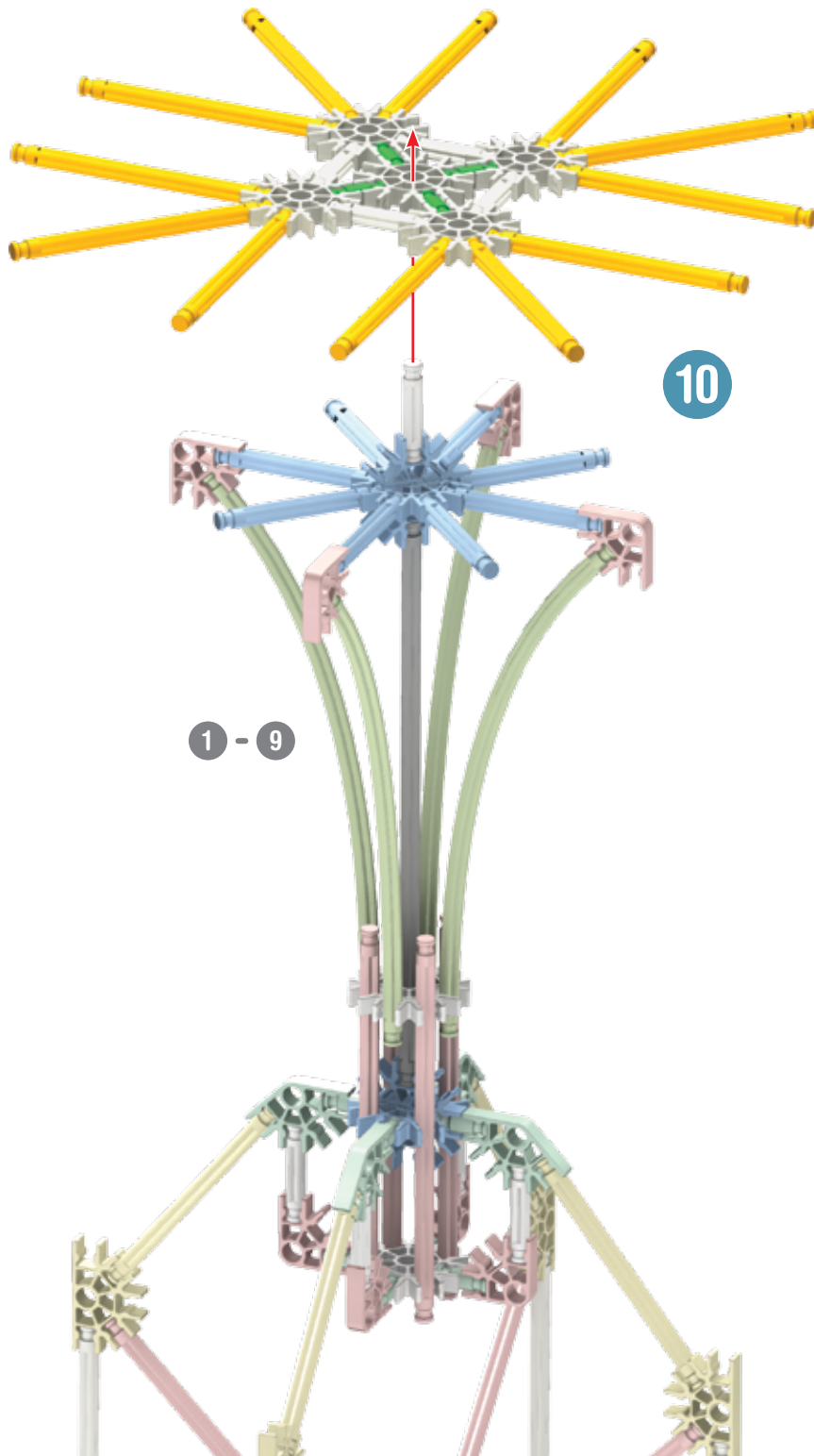

1 - 9

10

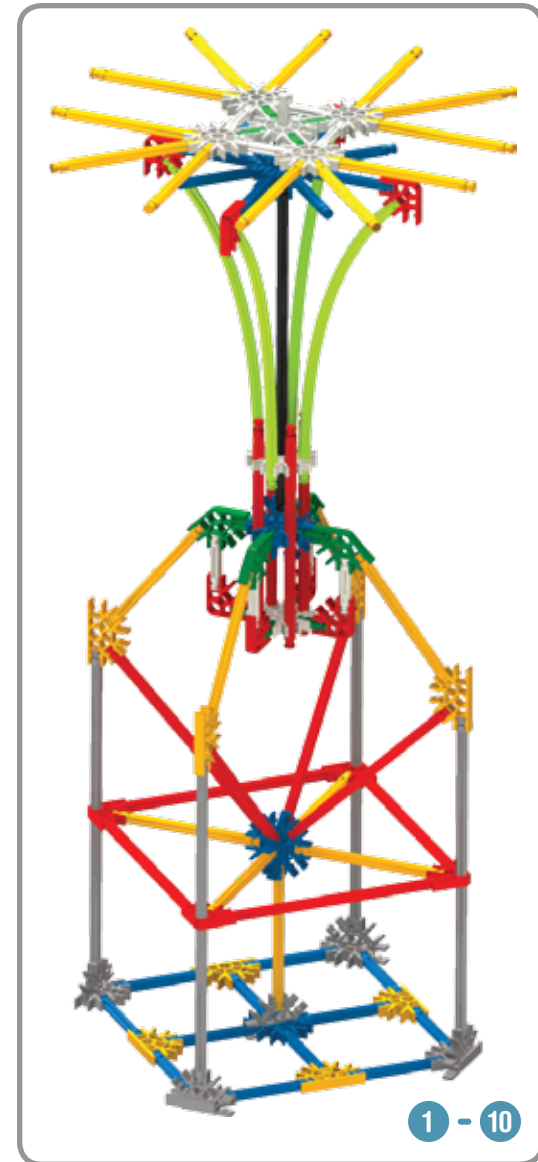
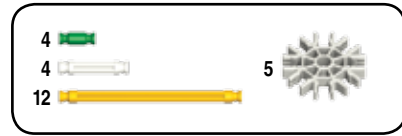

1 - 10

3		8		2	
8					

11

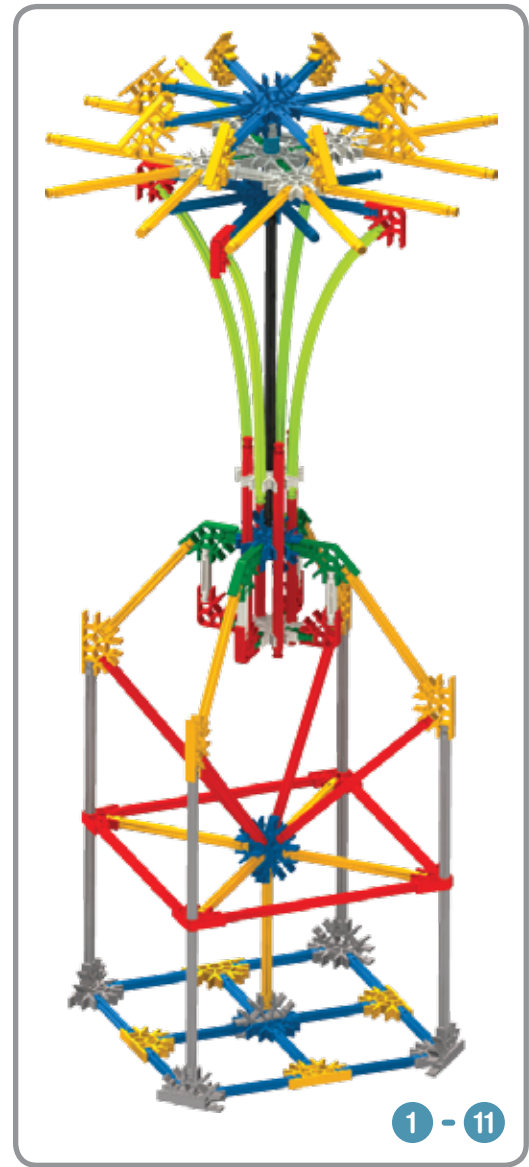
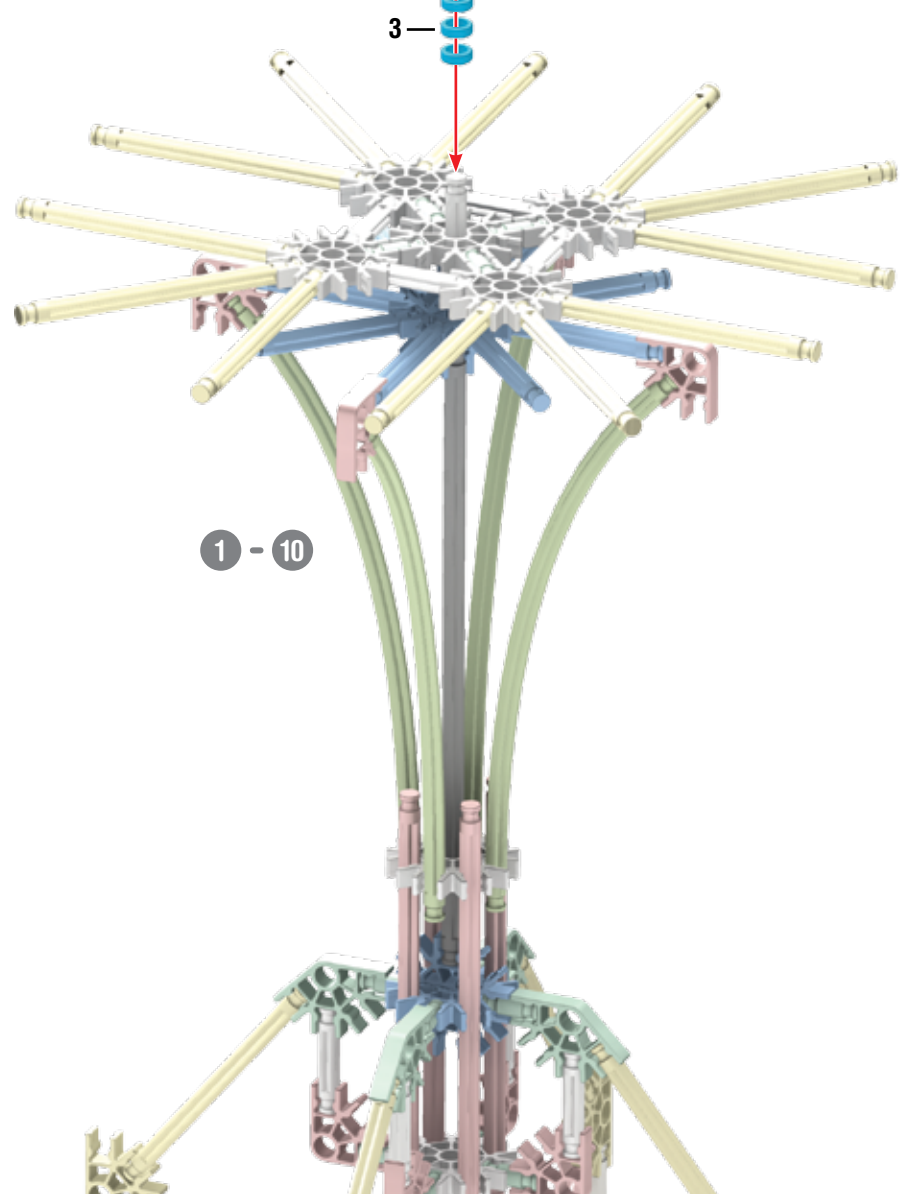
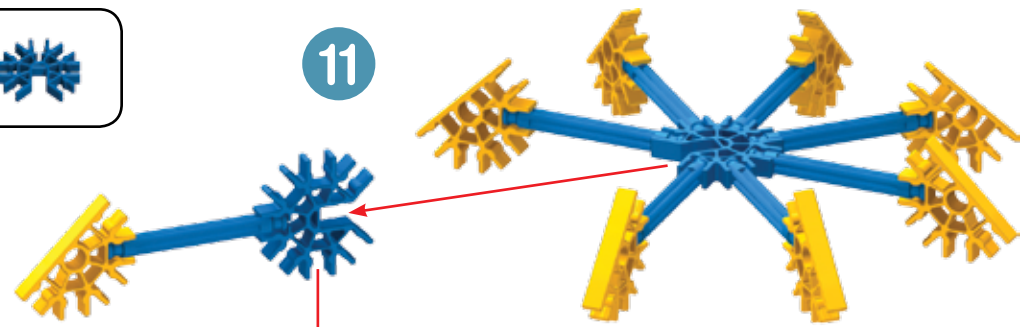

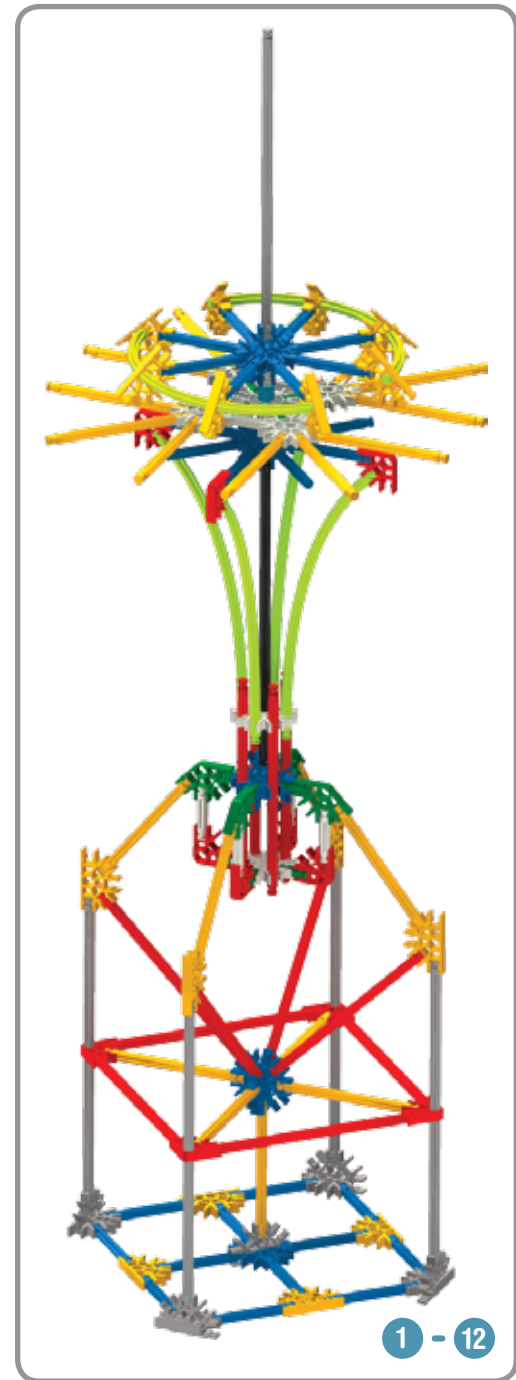
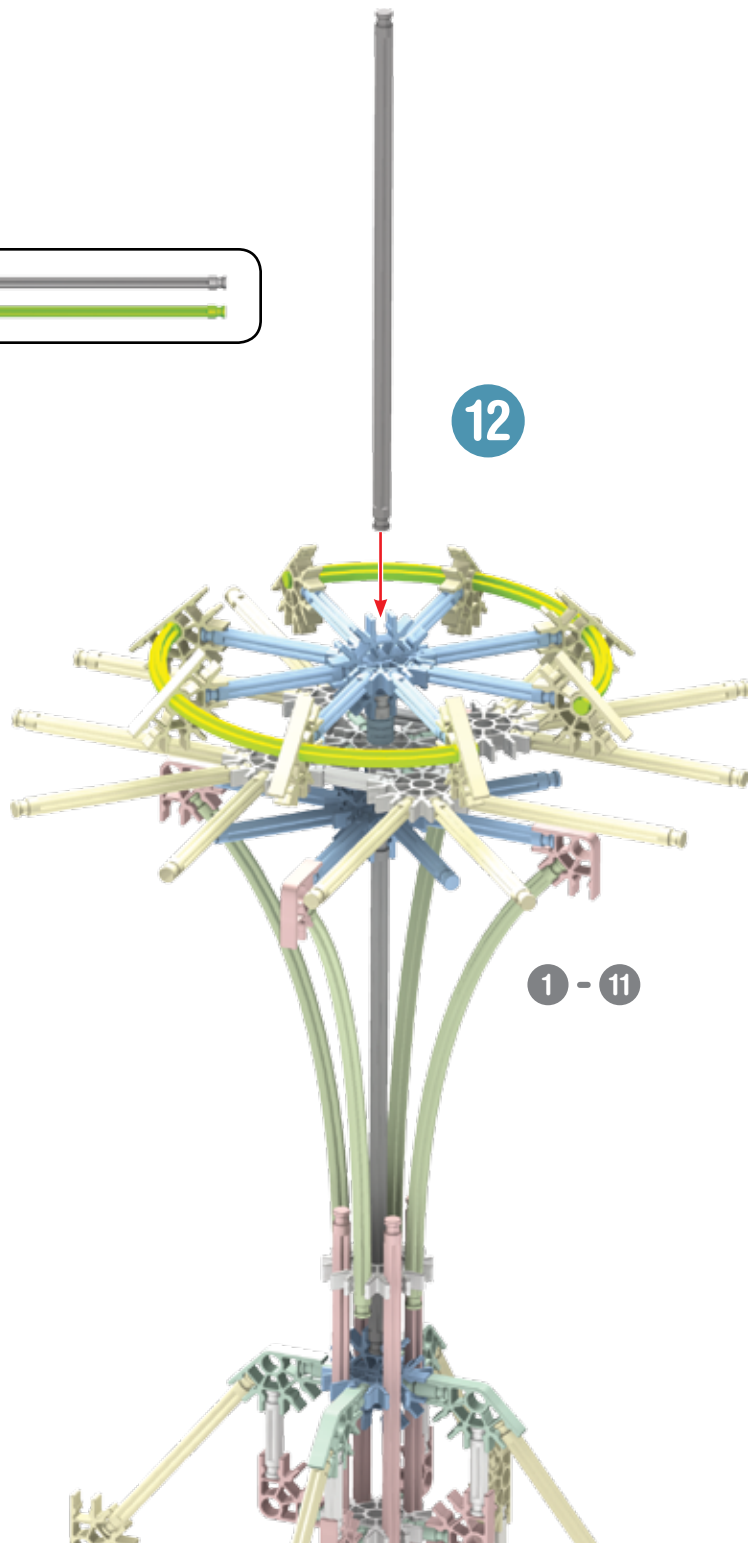

13

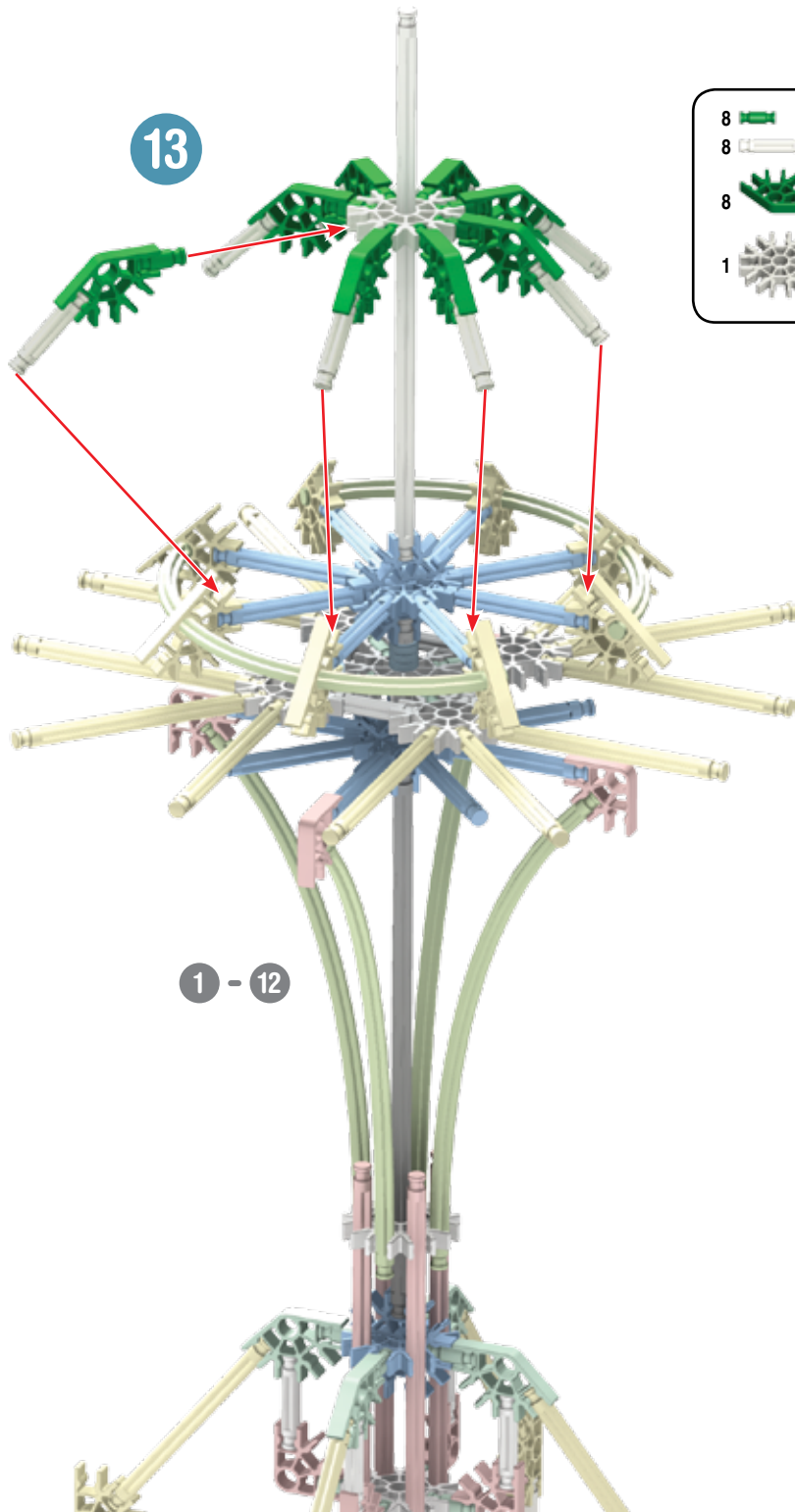

- 8
- 8
- 8
- 1

1 - 12

Observation Tower

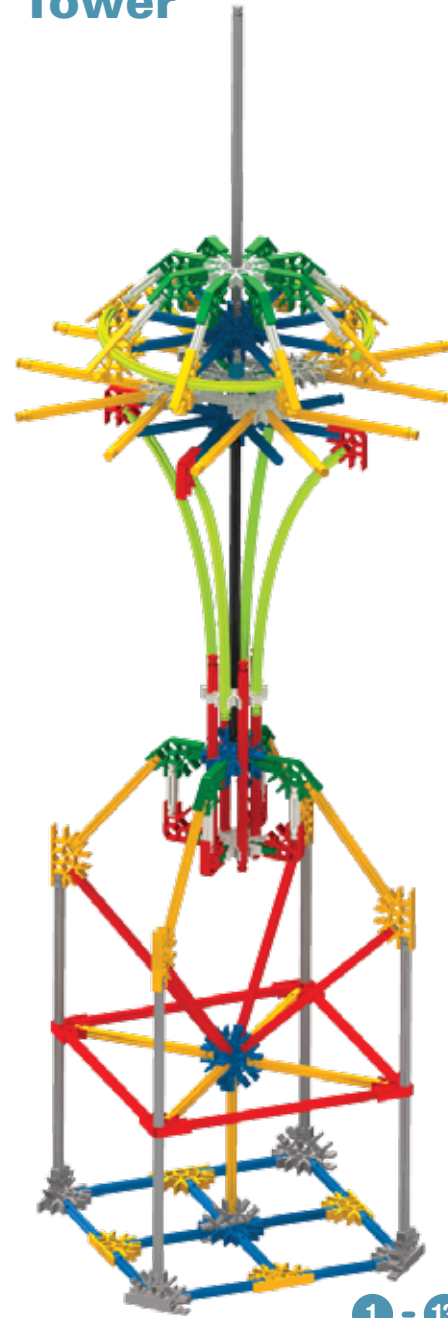

1 - 13

Palace

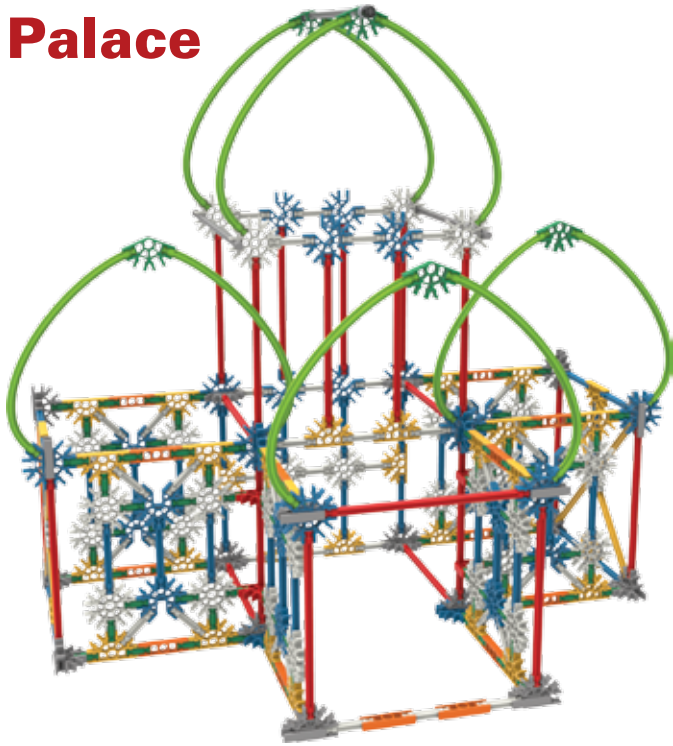

1

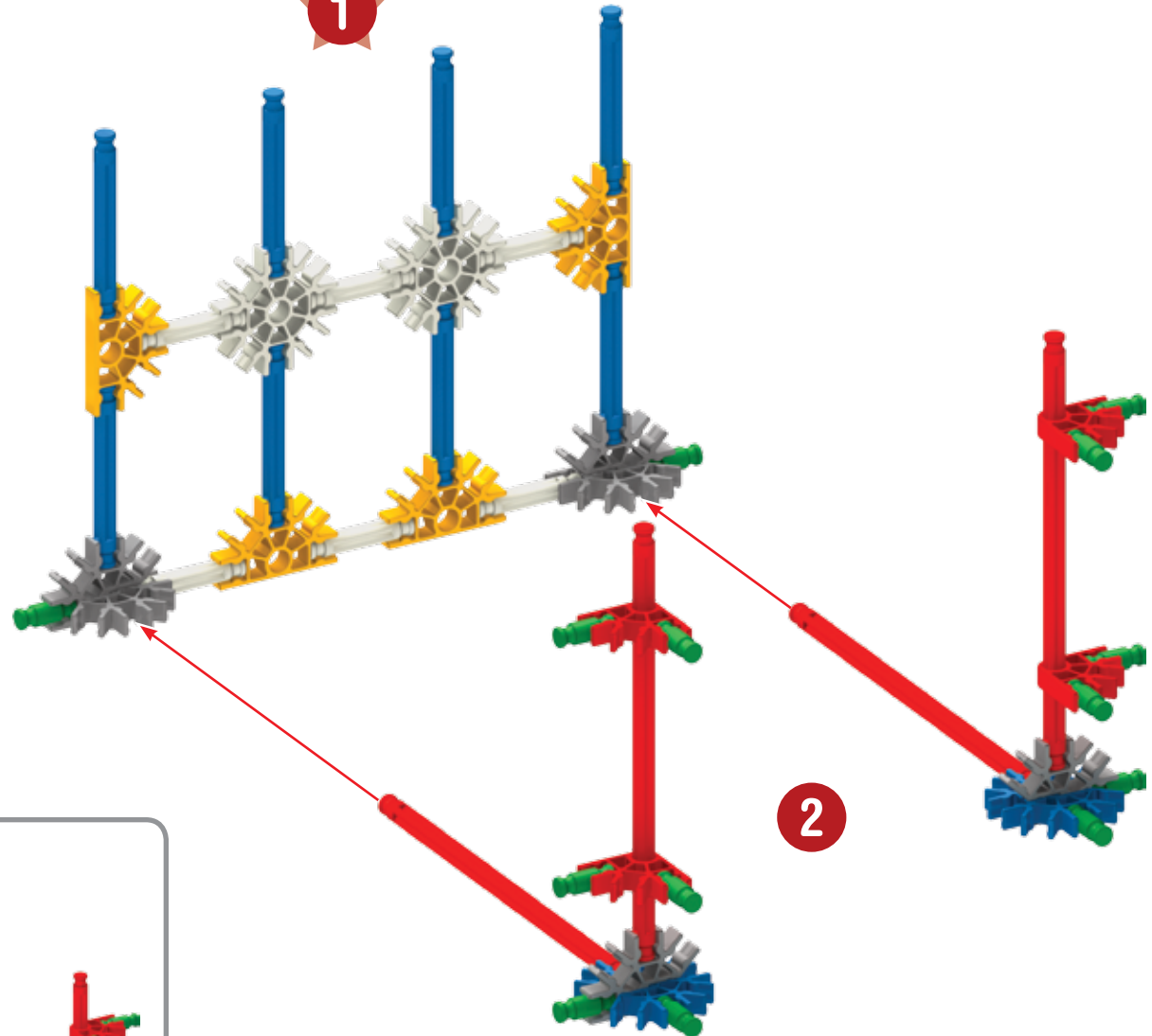

2

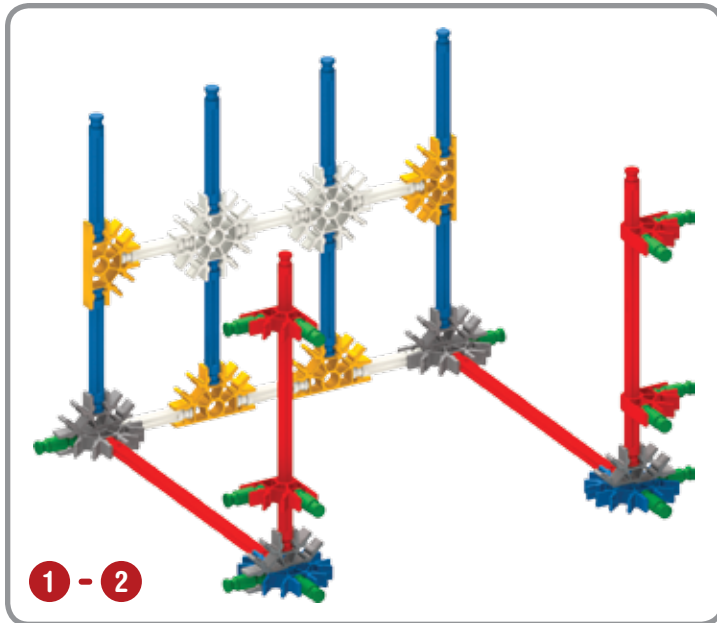

1 - 2

14		4		4	
6		4		4	
8		4		4	
4		4		4	
6		2		2	

3

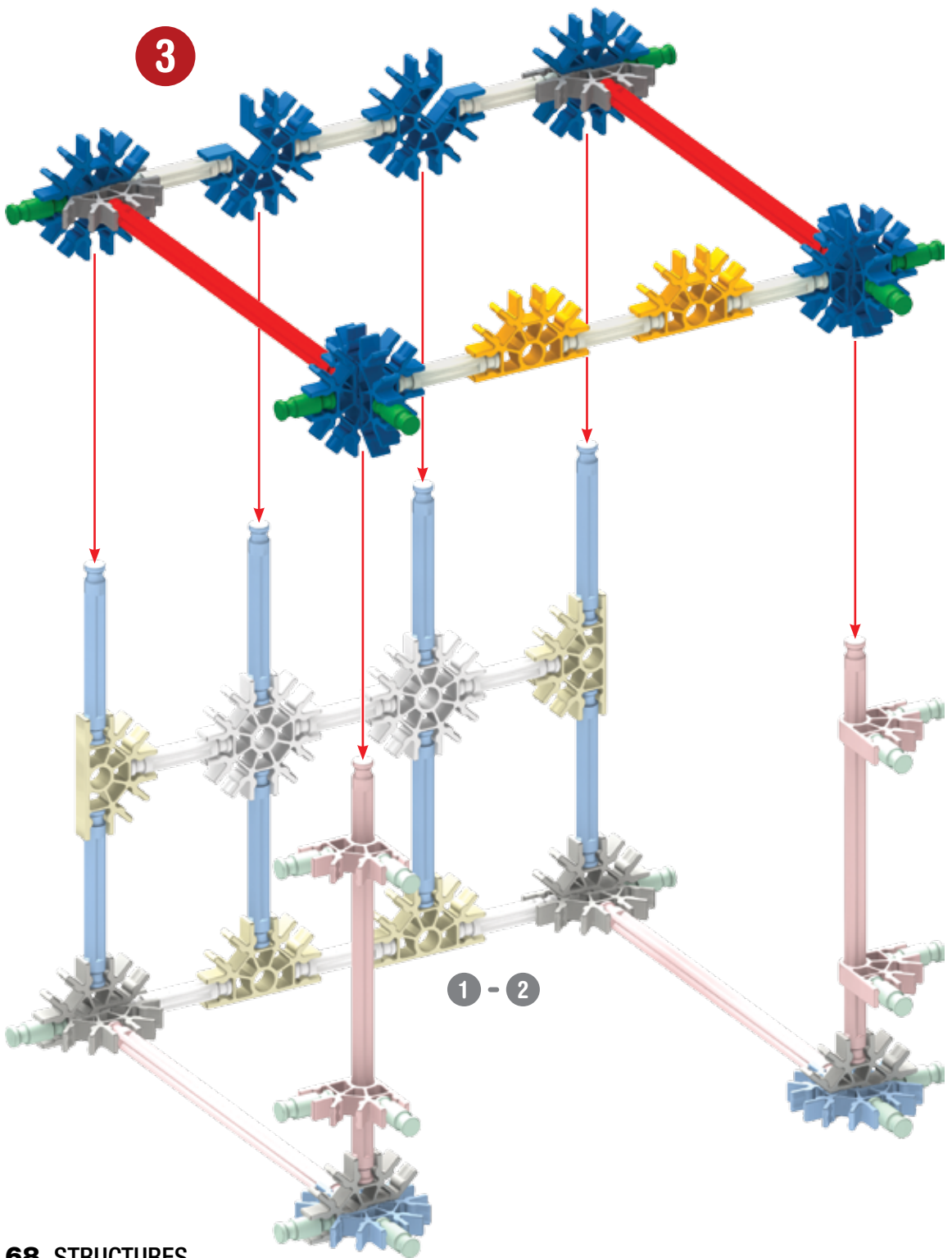

6		2	
6		2	
2		8	

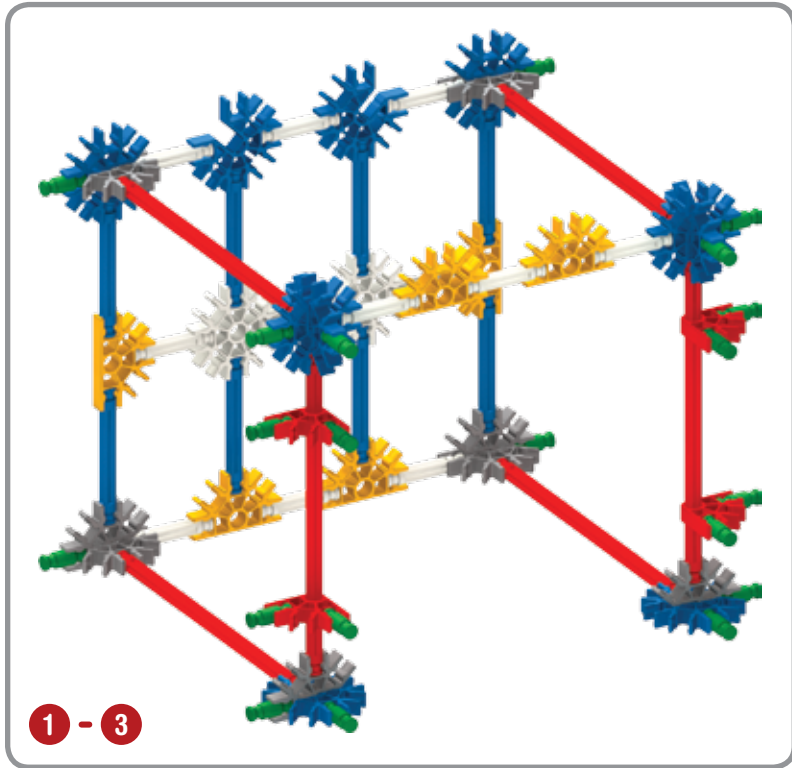

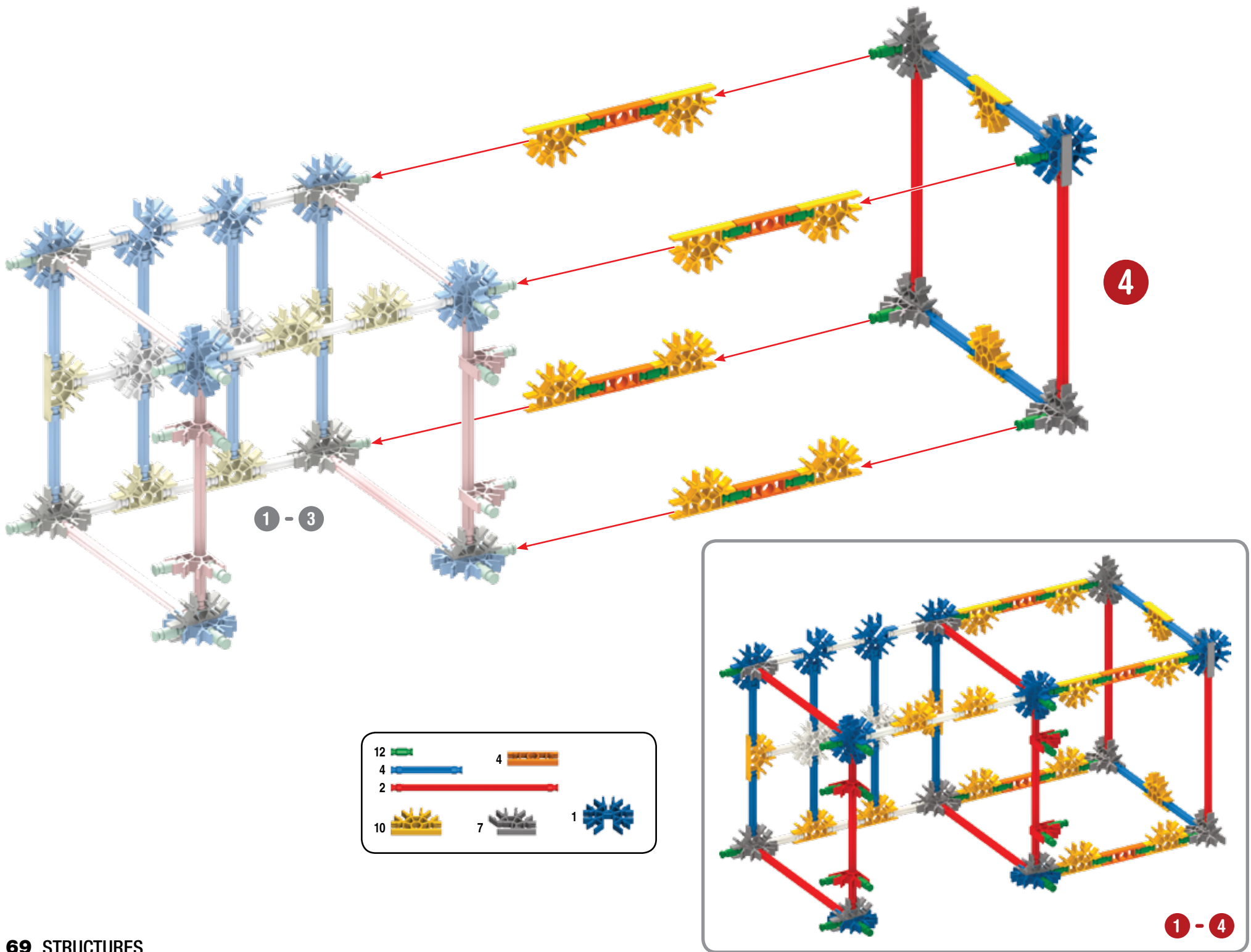

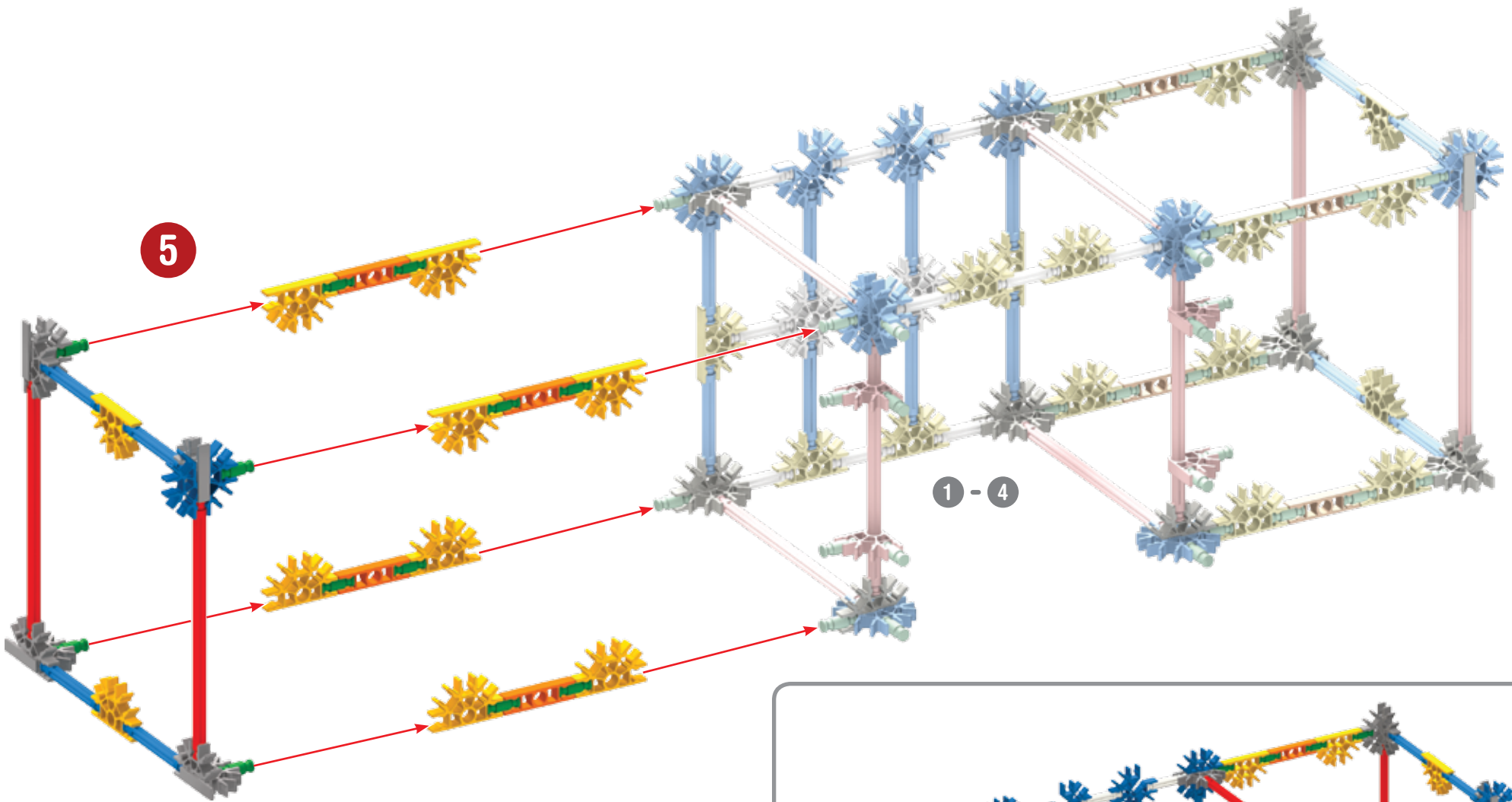

12		4	
4			
2			
10		7	
		1	

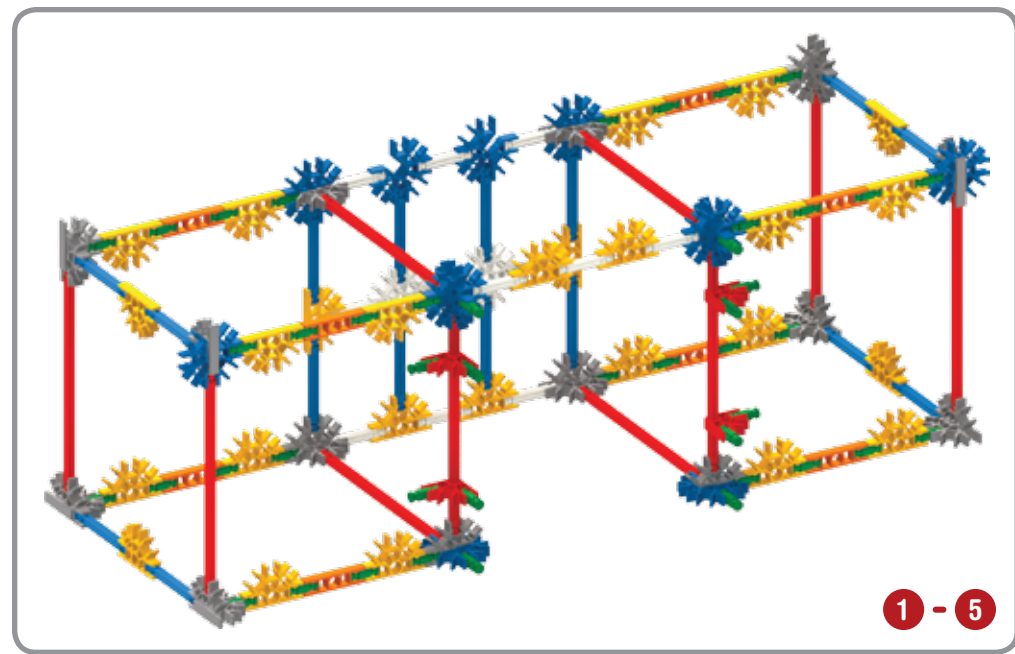

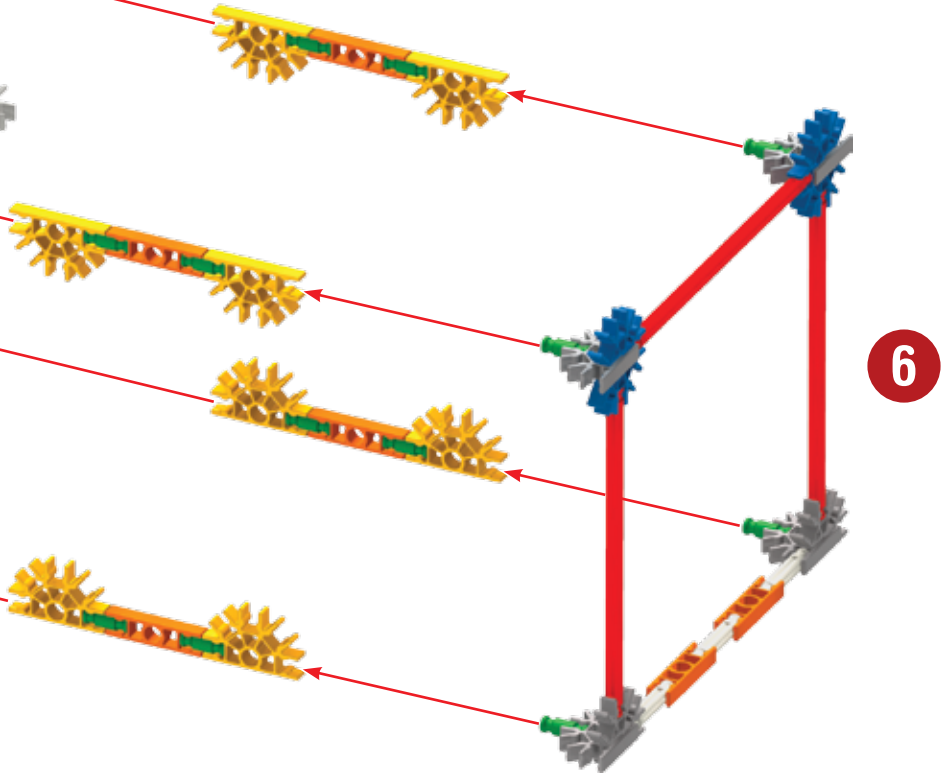
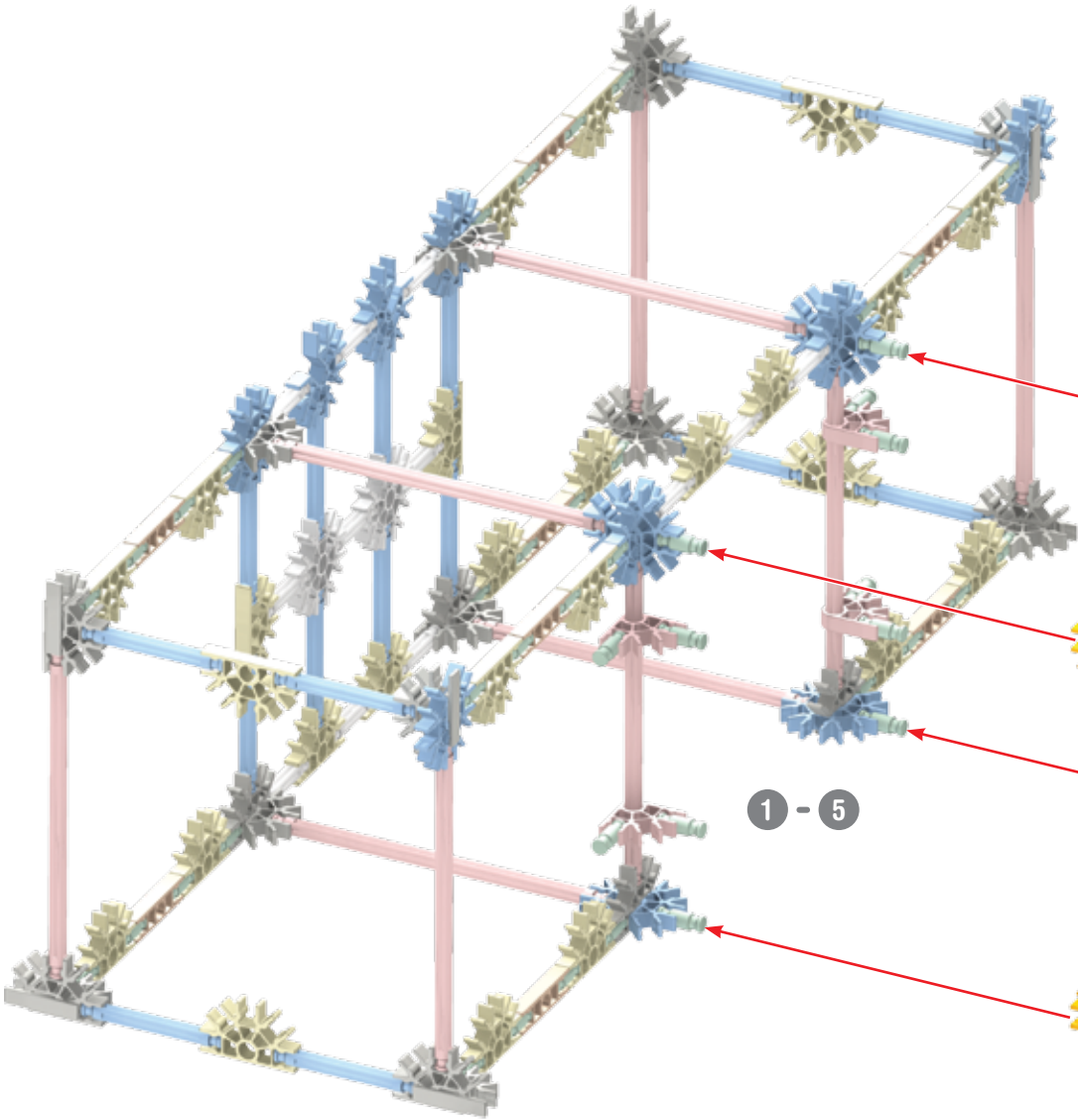
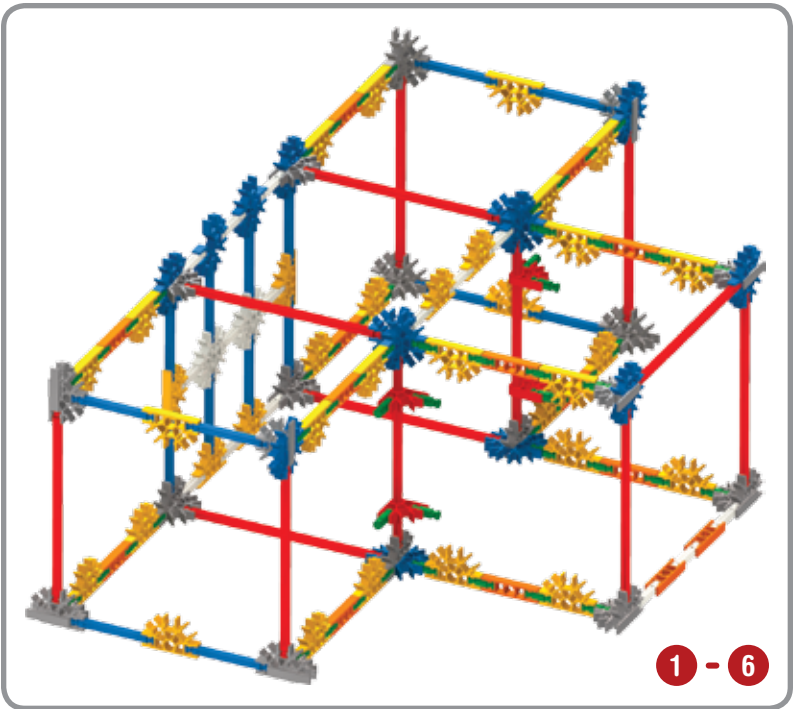
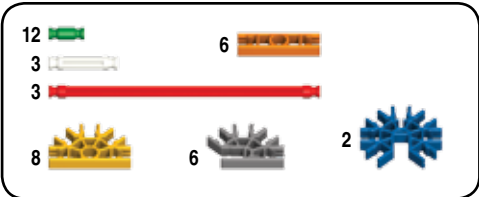

x2

7

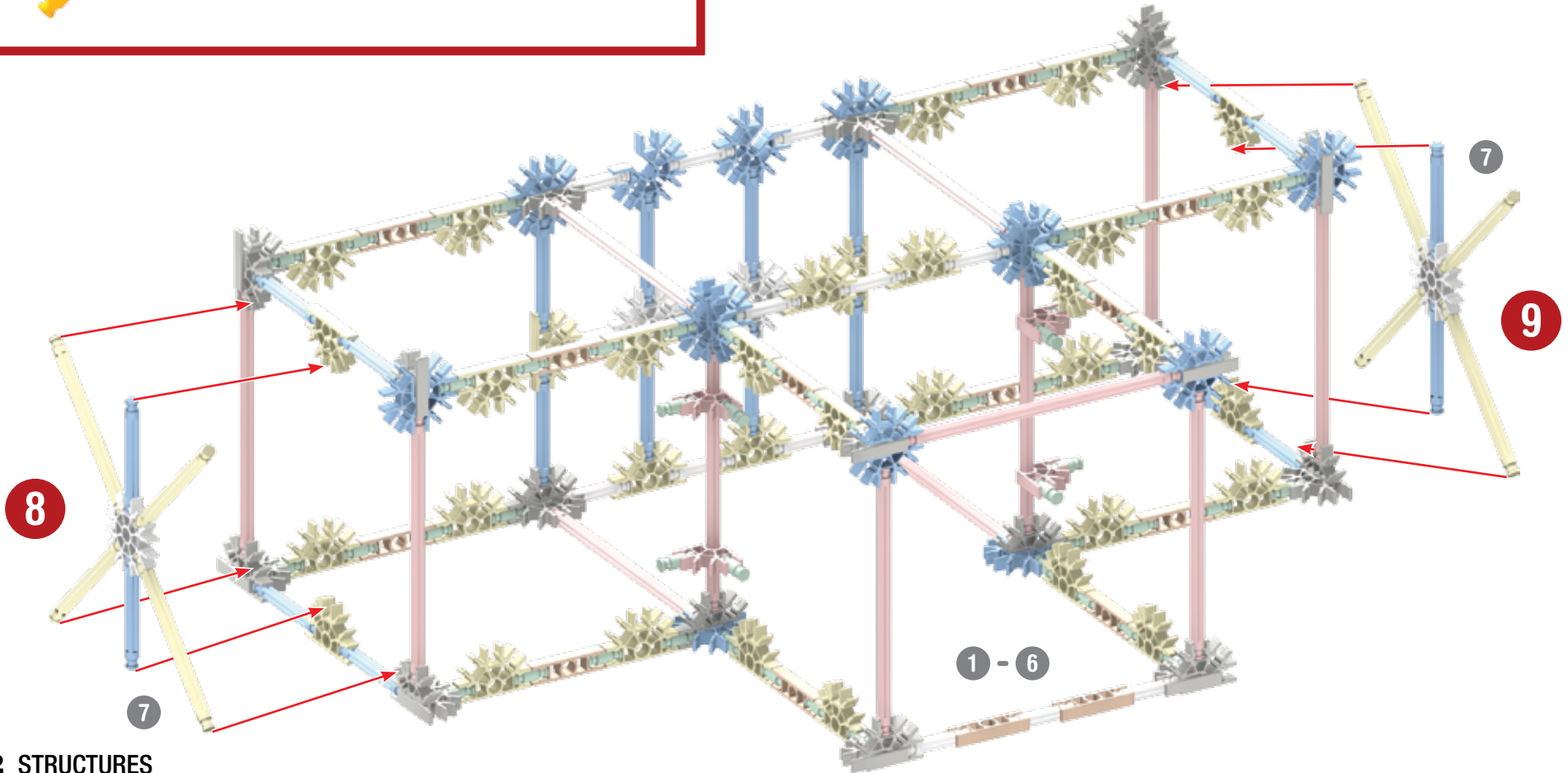
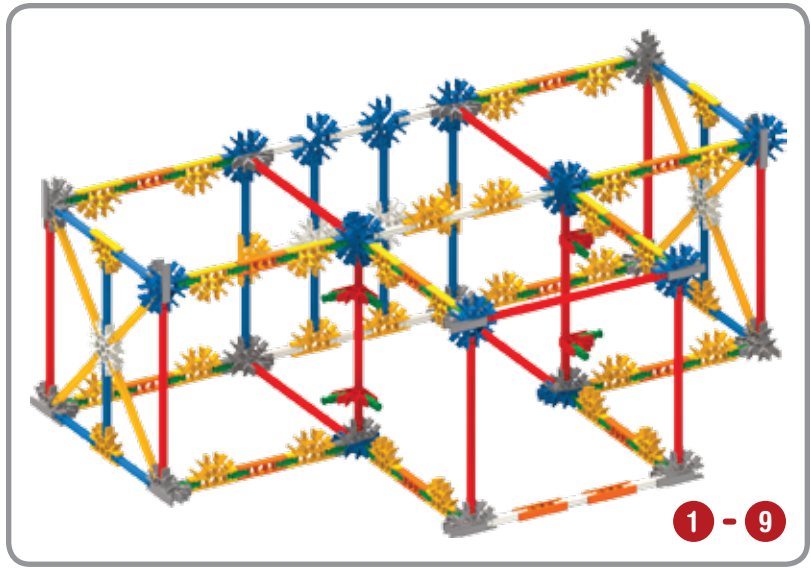
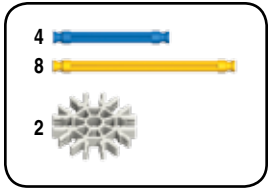
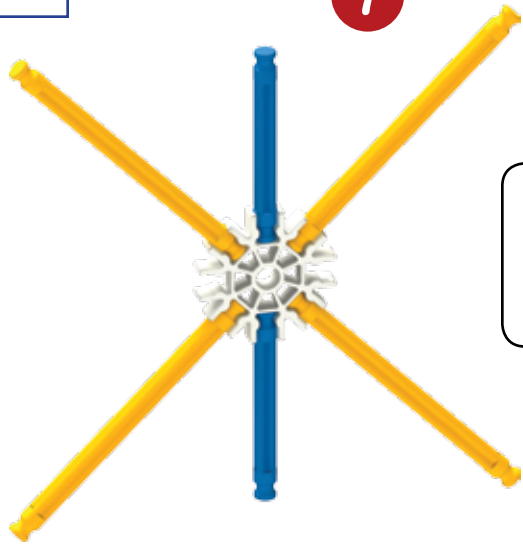

x6

10

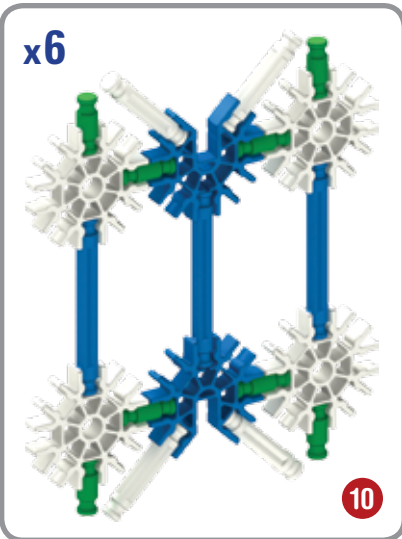
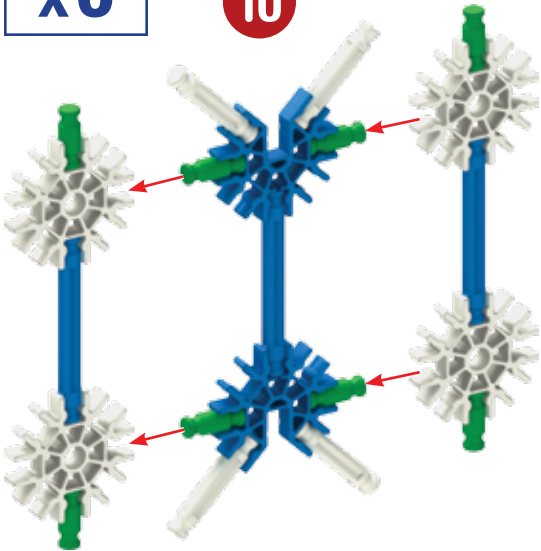

x6

10

- 48 12 24
- 24
- 18

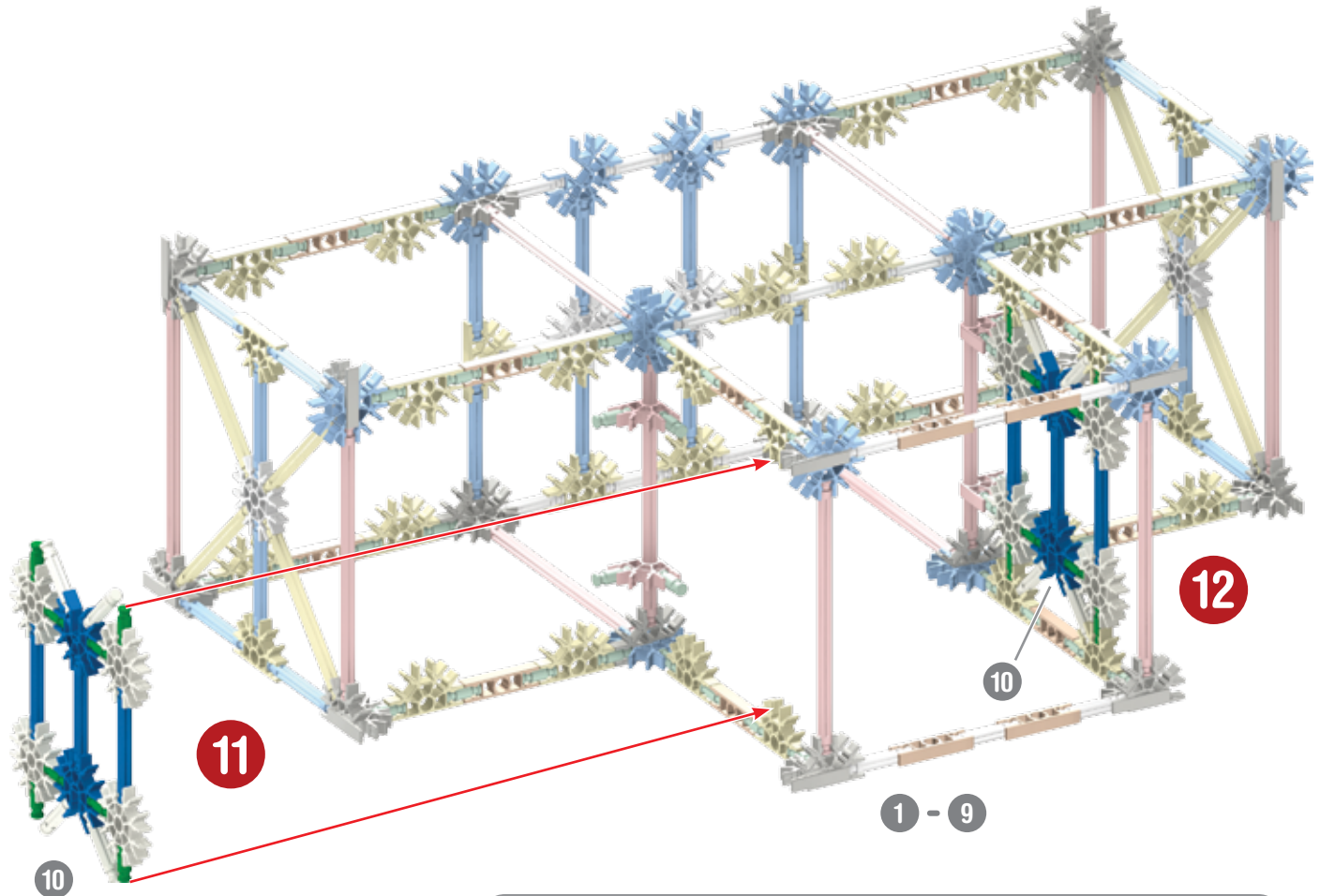

12

10

1 - 9

10

11

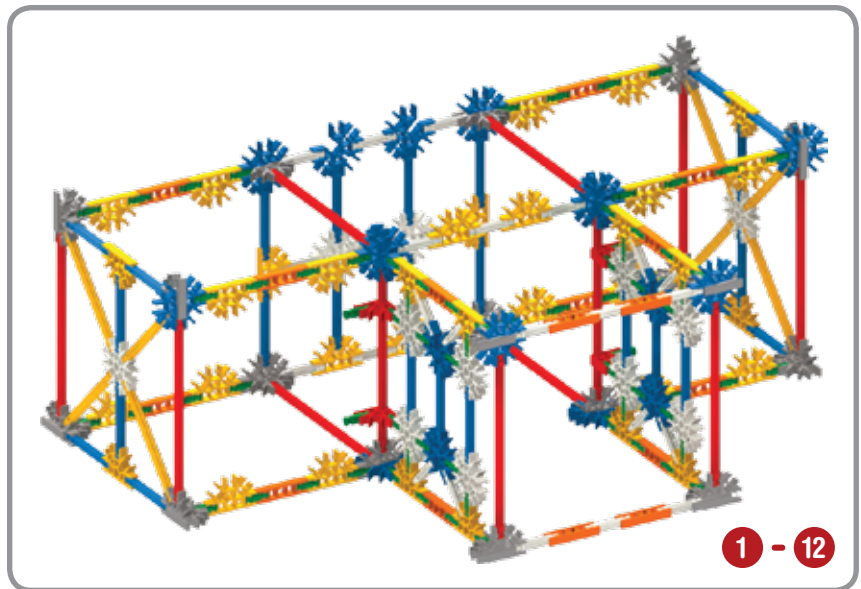
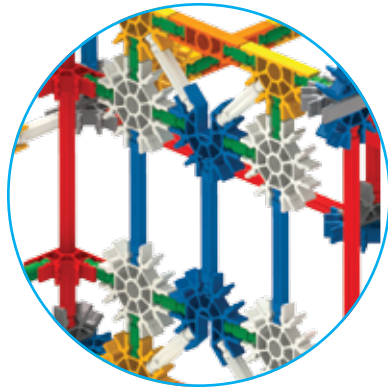

1 - 12

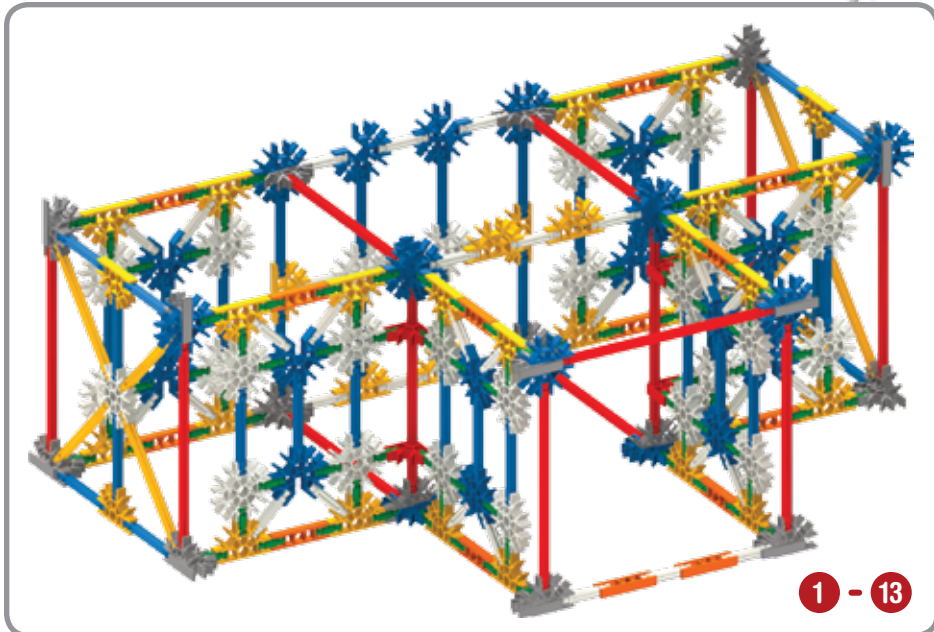
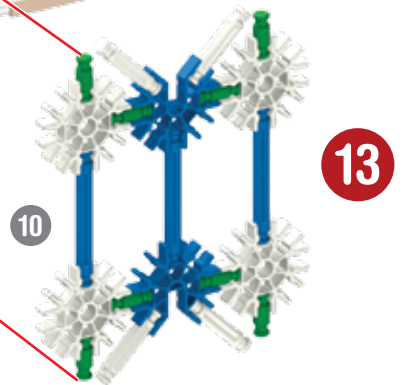
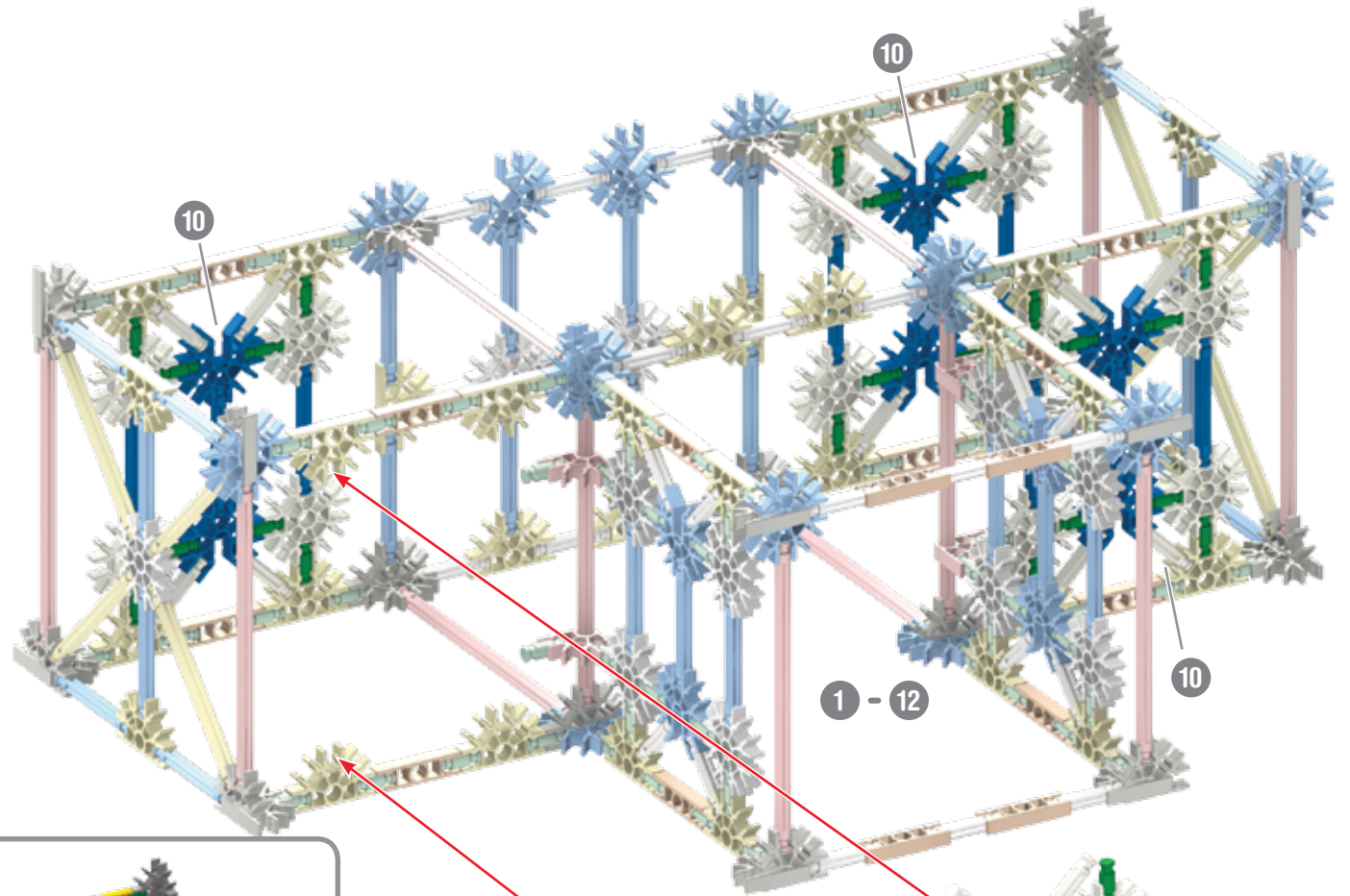
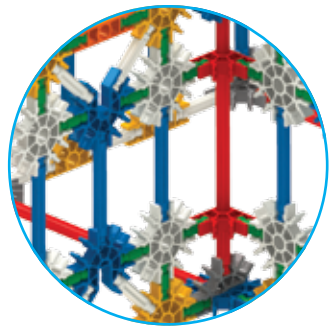

14

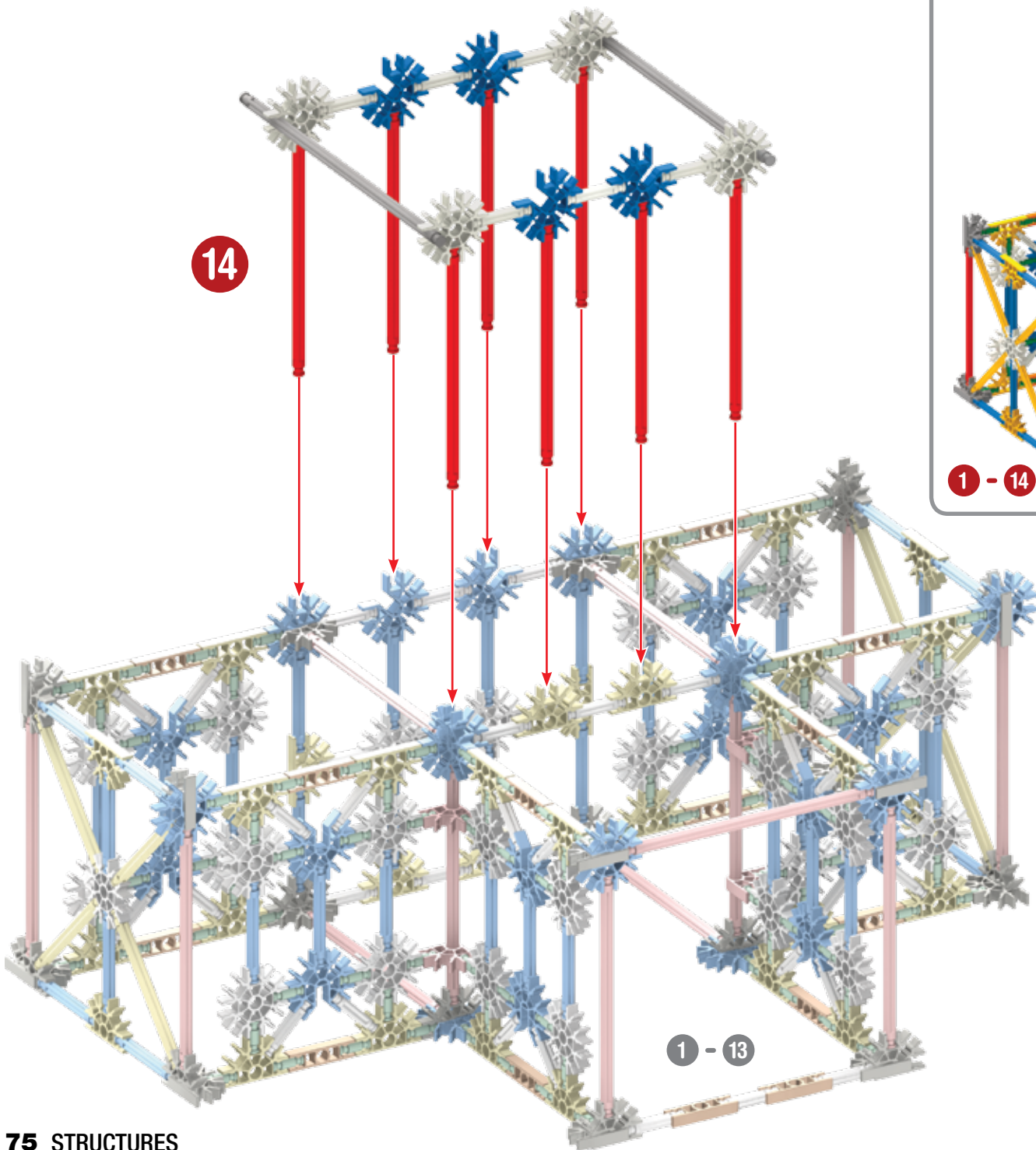

1 - 13

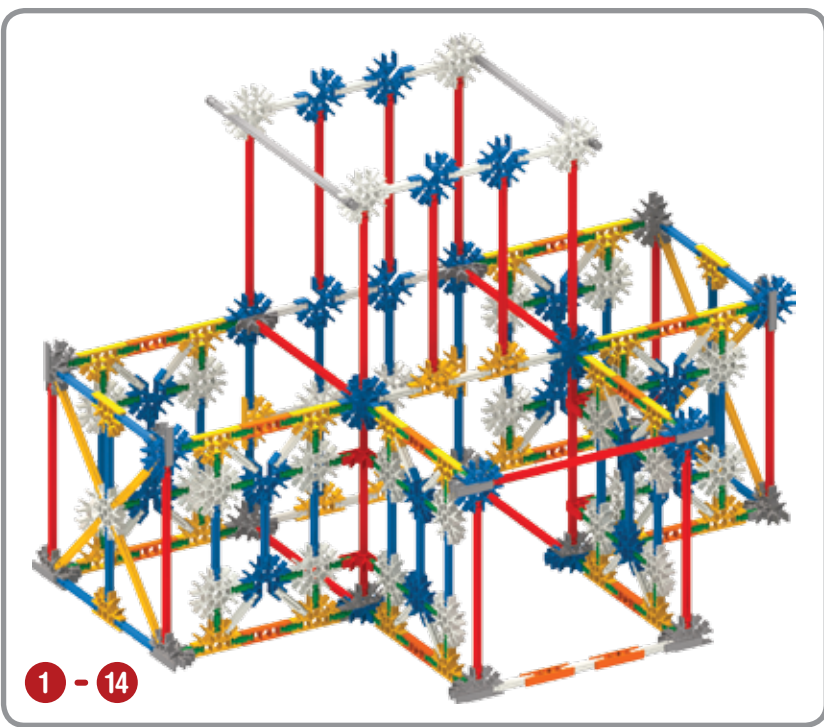

1 - 14

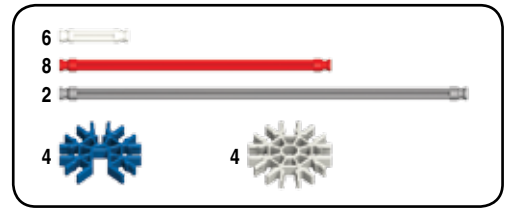

Palace

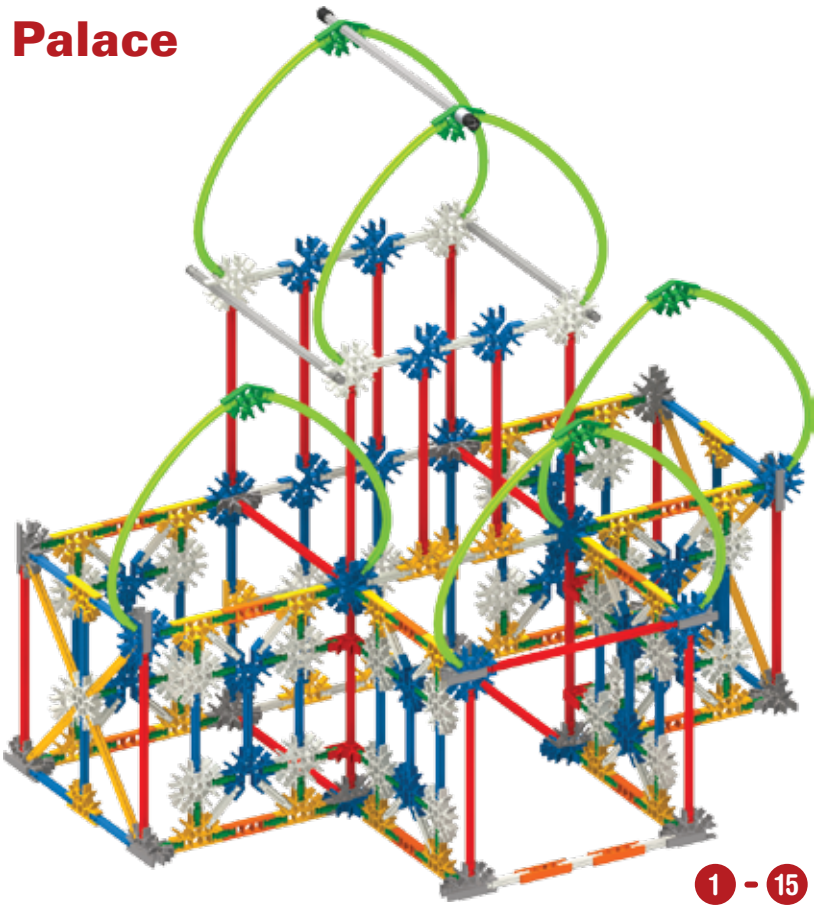

- 2
- 1
- 5
- 1
- 10

1 - 14

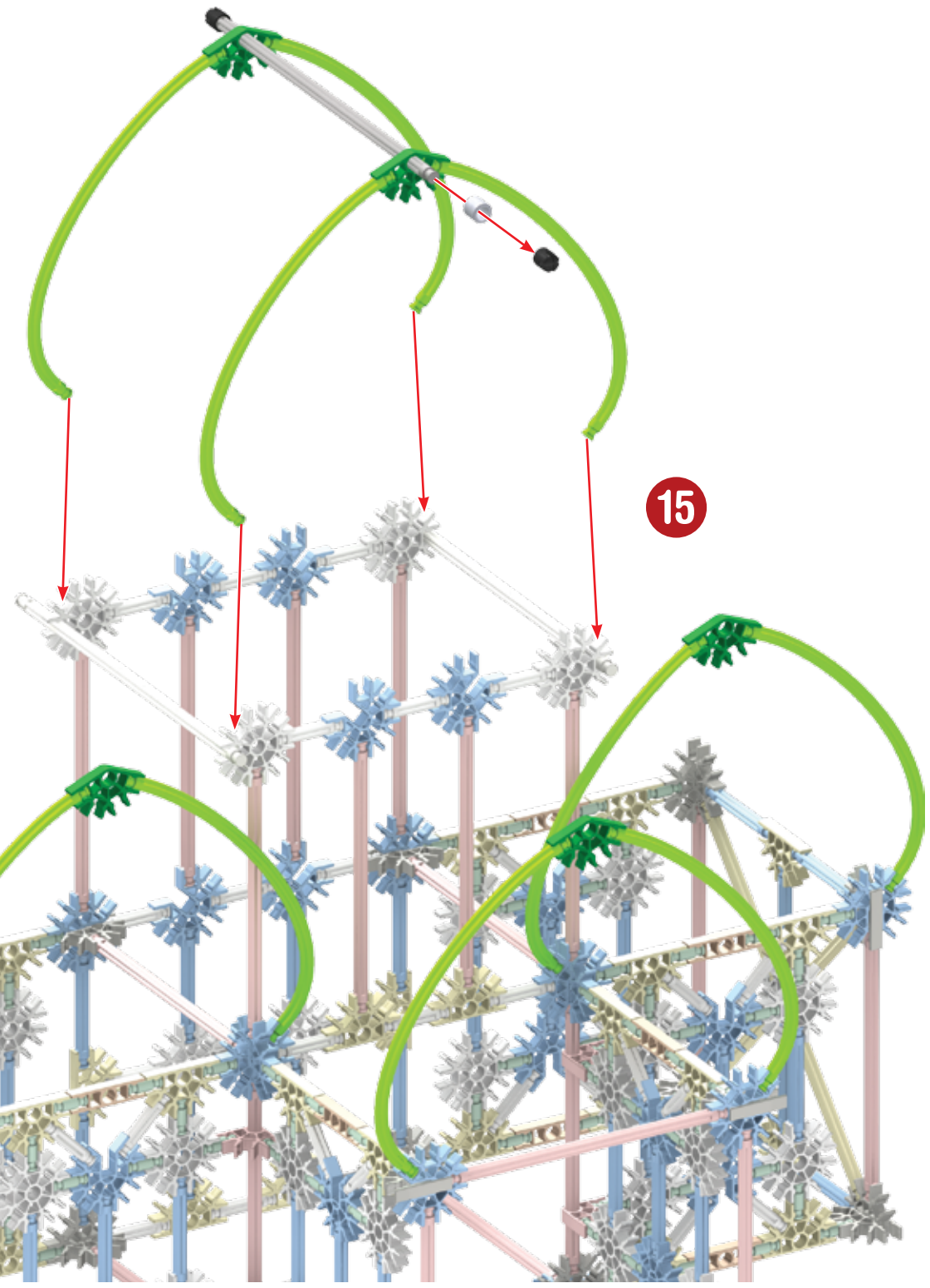

Pyramid

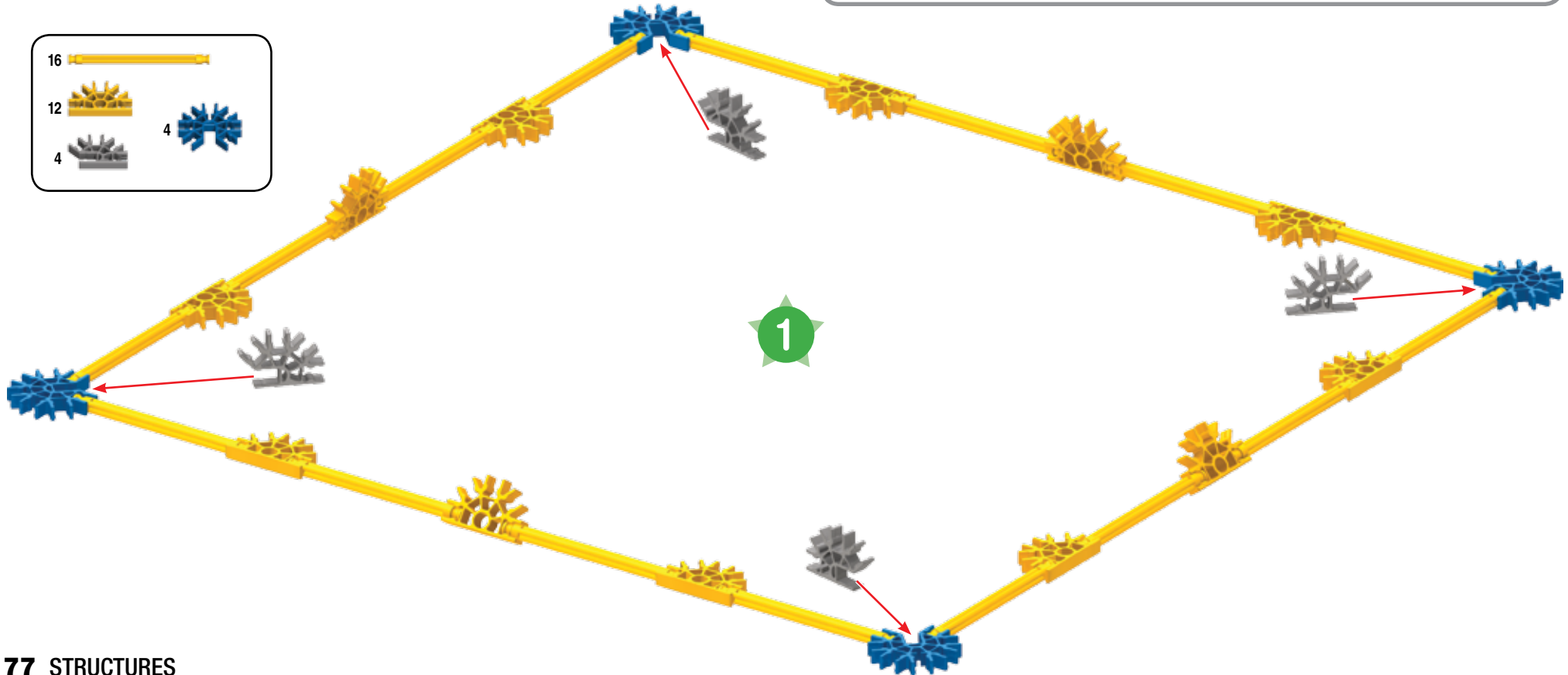
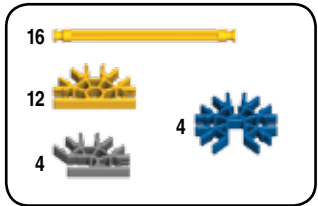
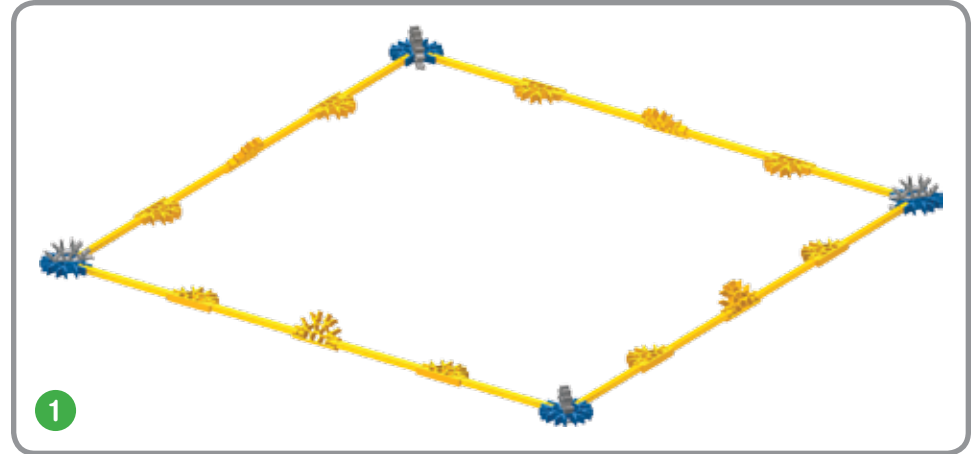
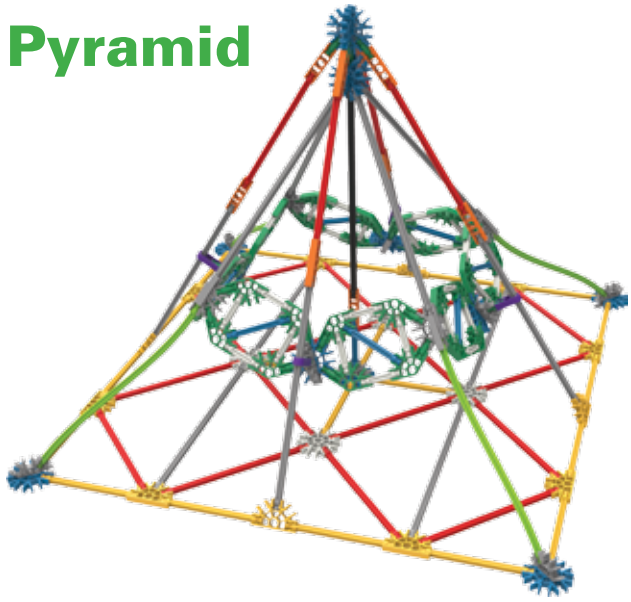

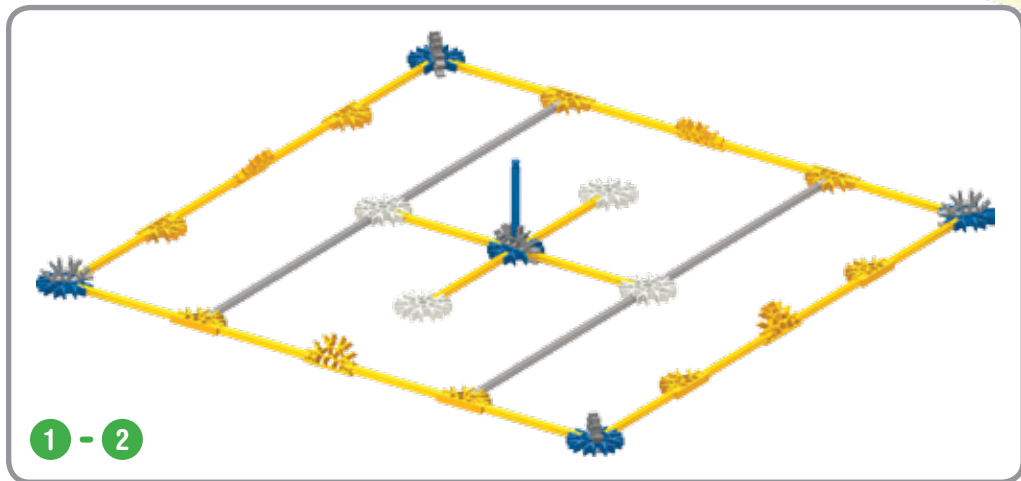
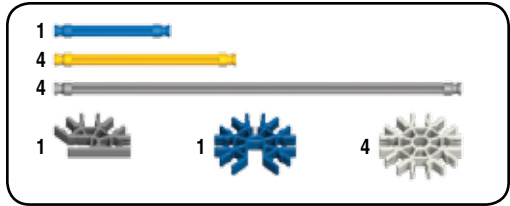
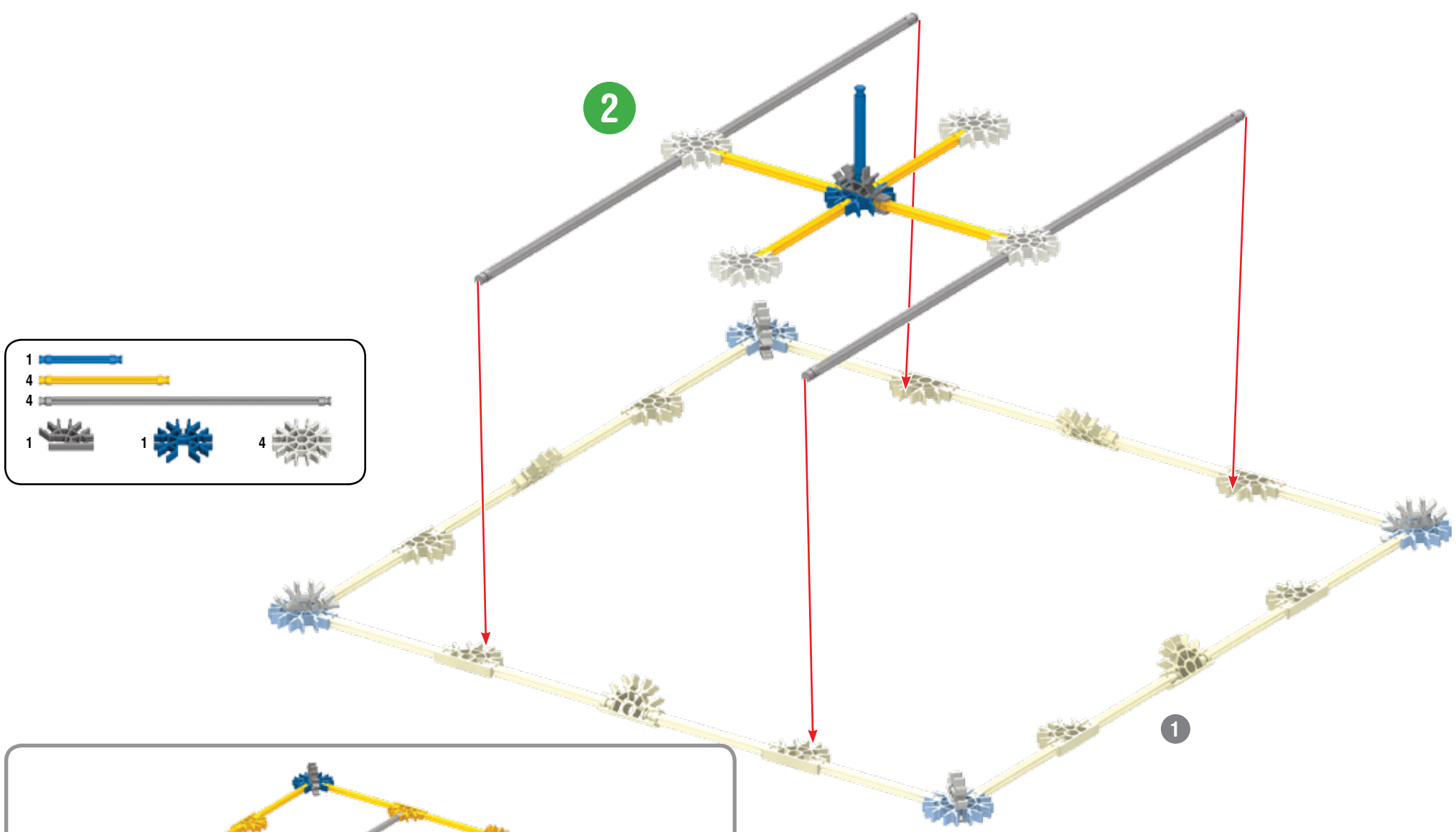

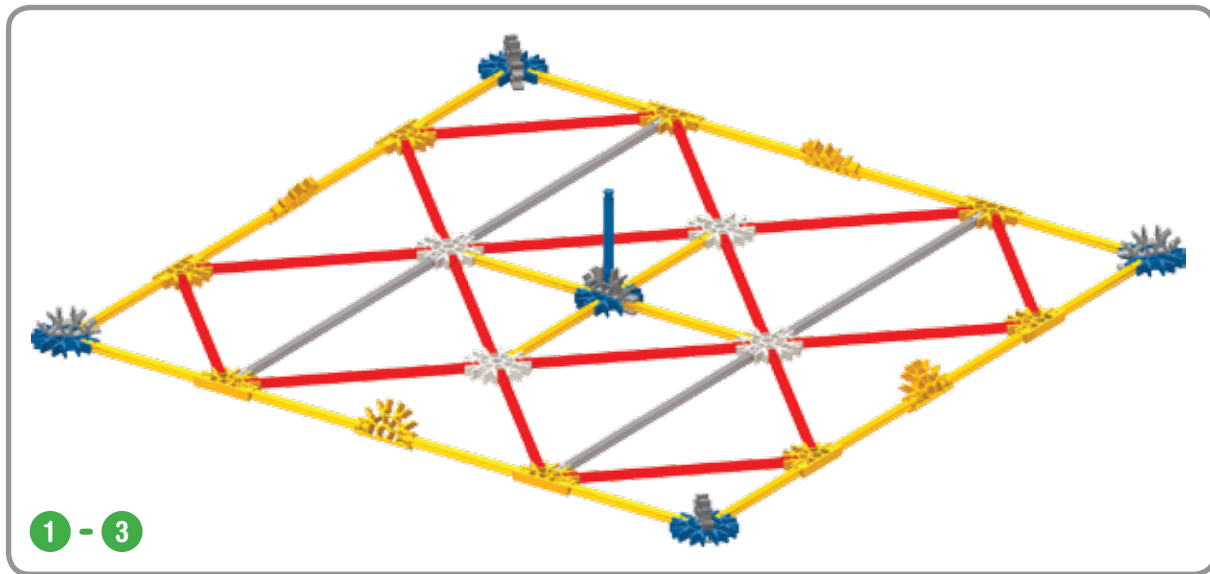
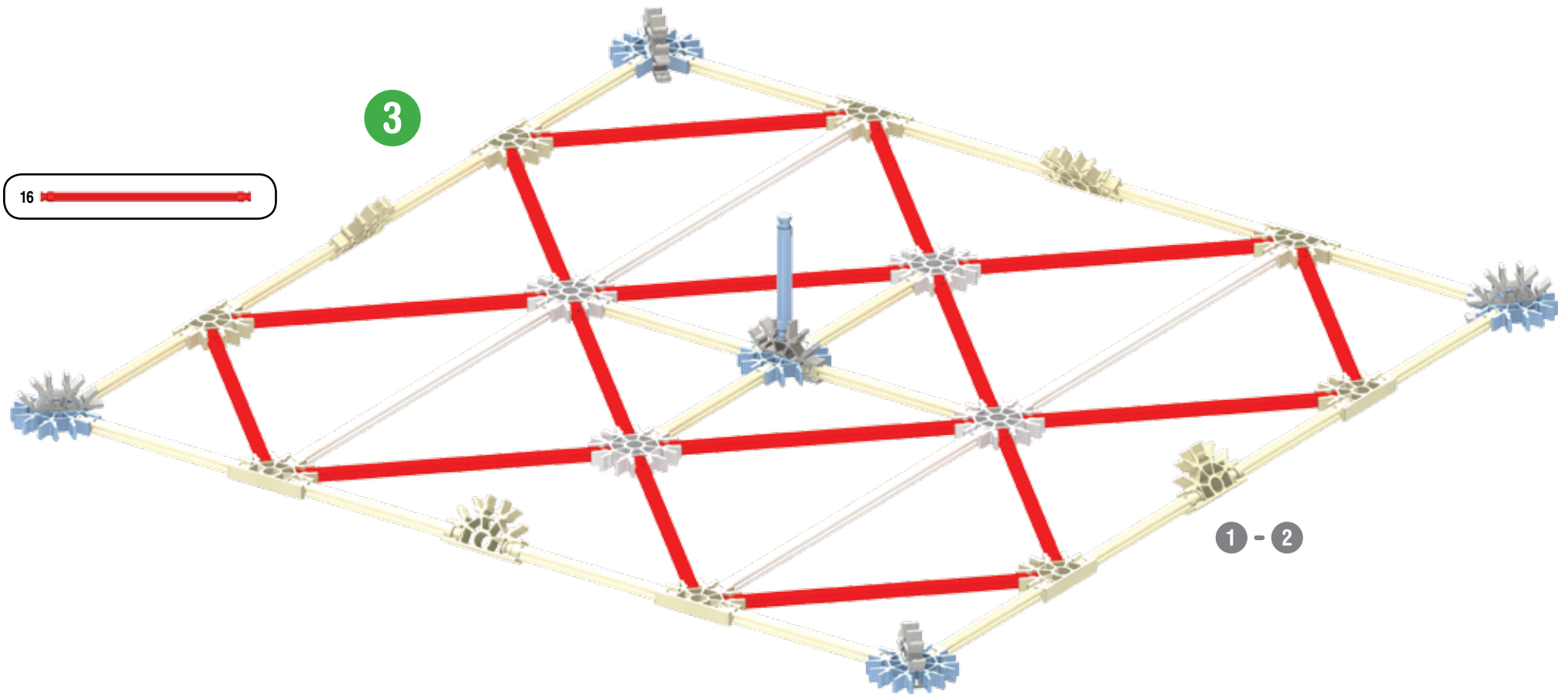

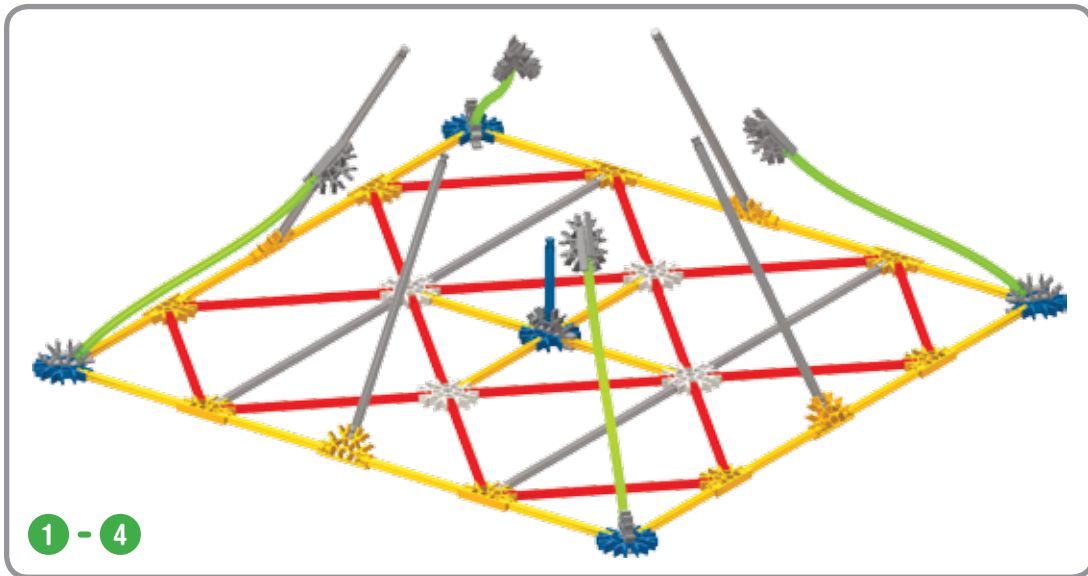
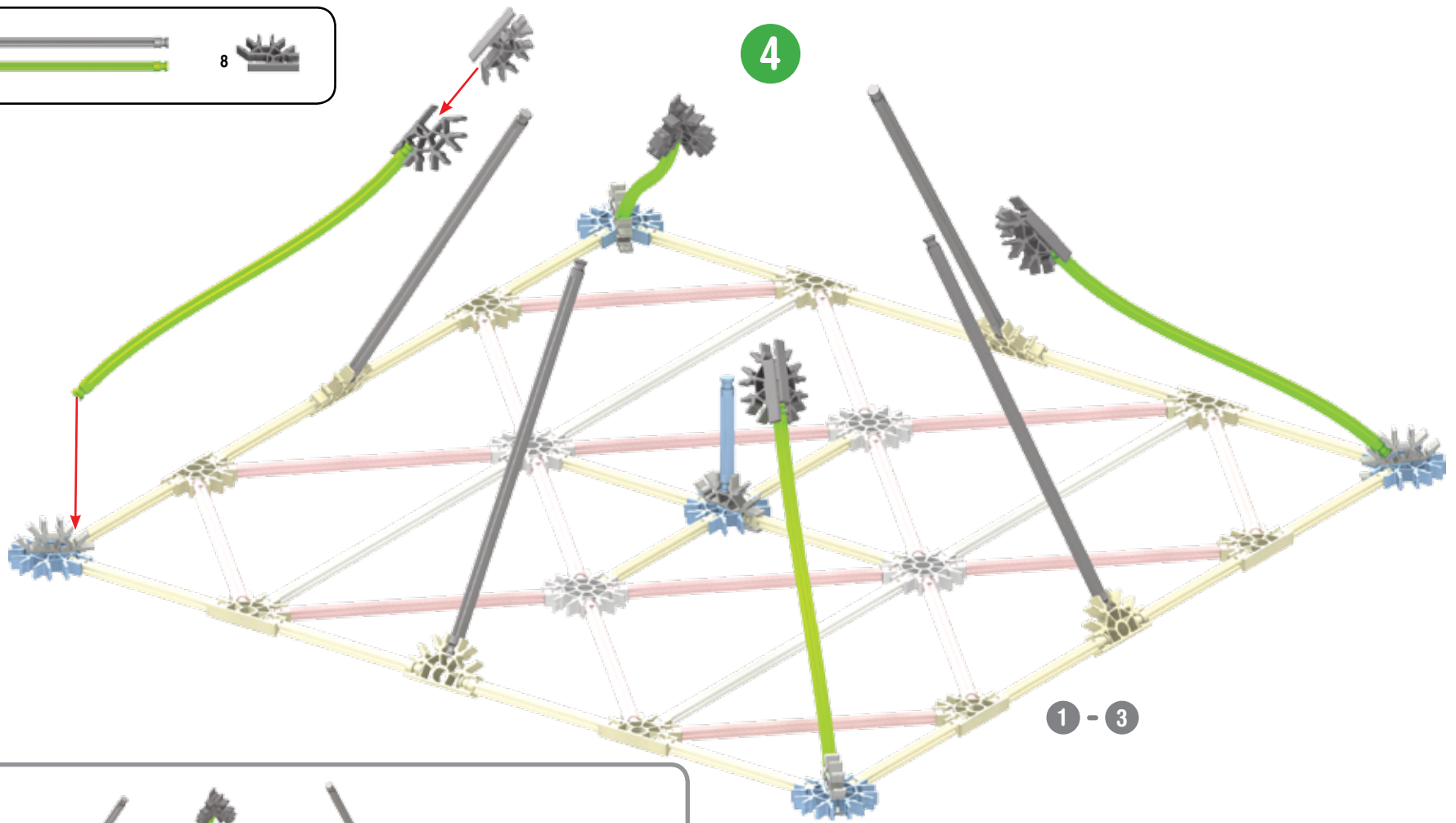

x4

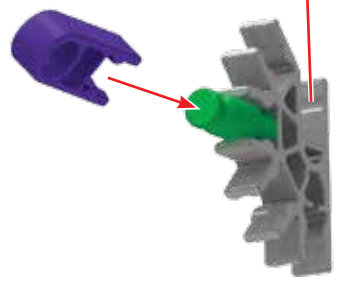
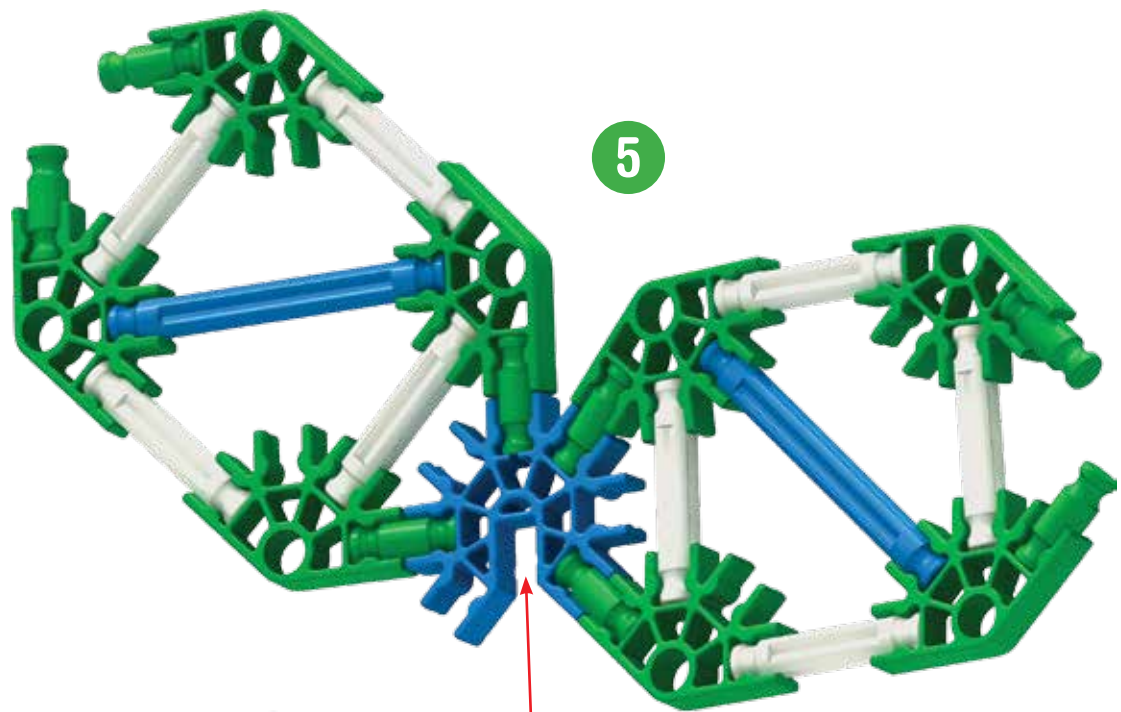

- | | | | | |
|----|--|---|--|--|
| 36 | | 4 | | |
| 32 | | | | |
| 8 | | | | |
| 32 | | 4 | | |

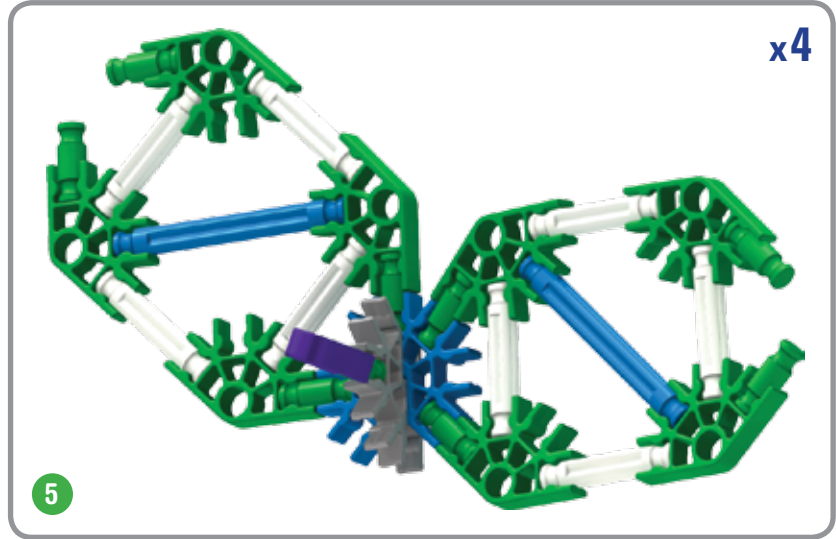

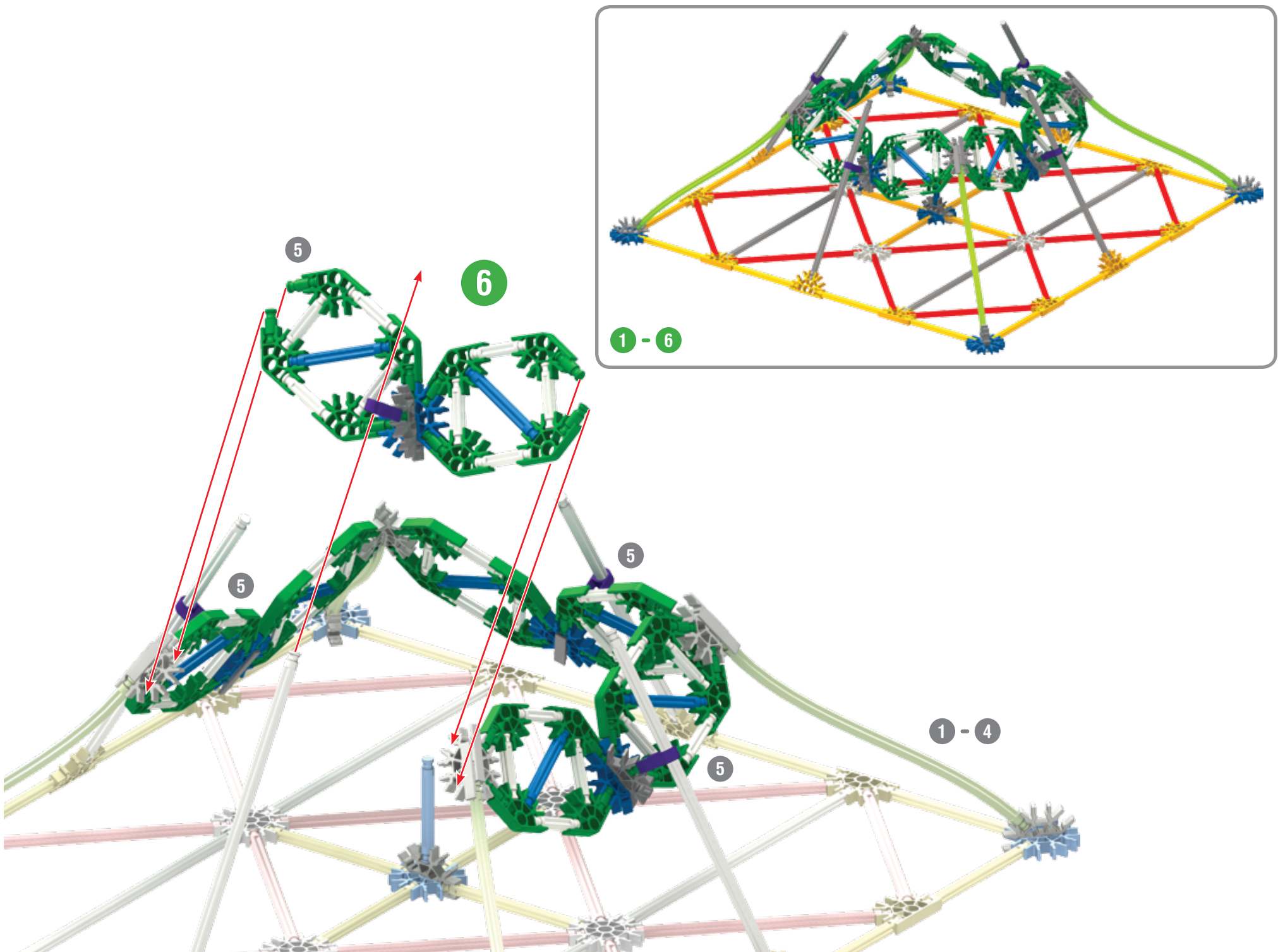

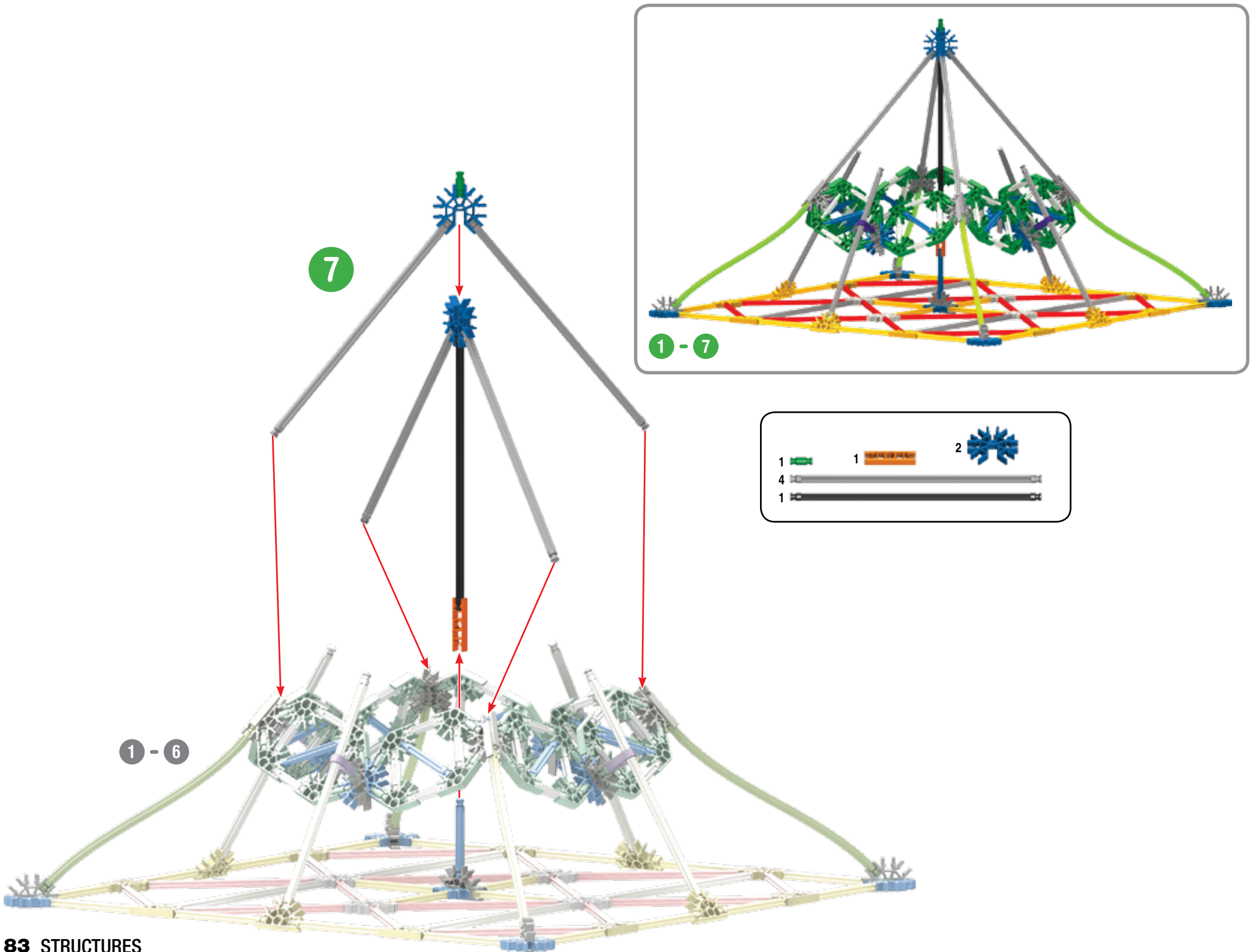

Pyramid

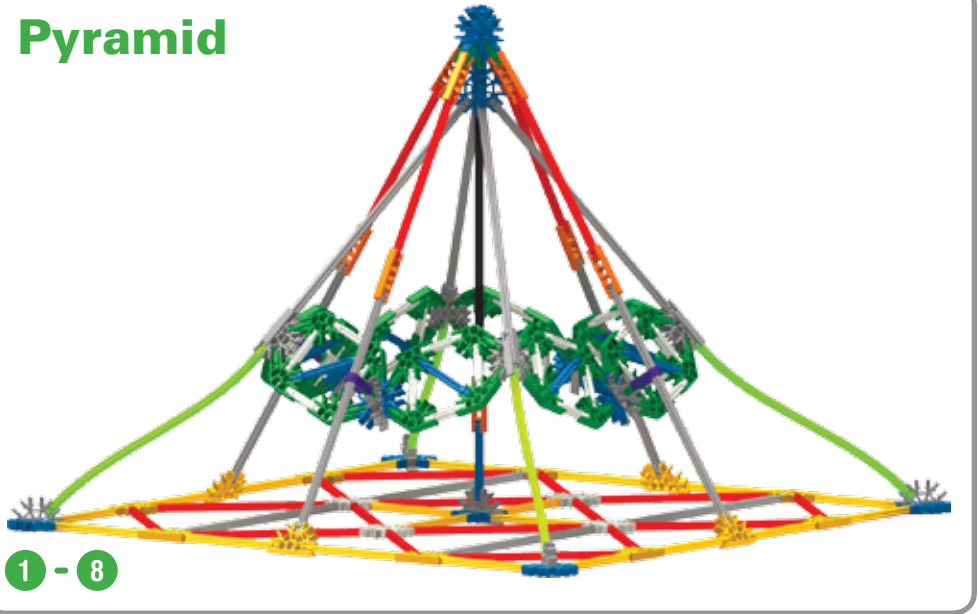

8

4		8		2	
4					

1 - 7

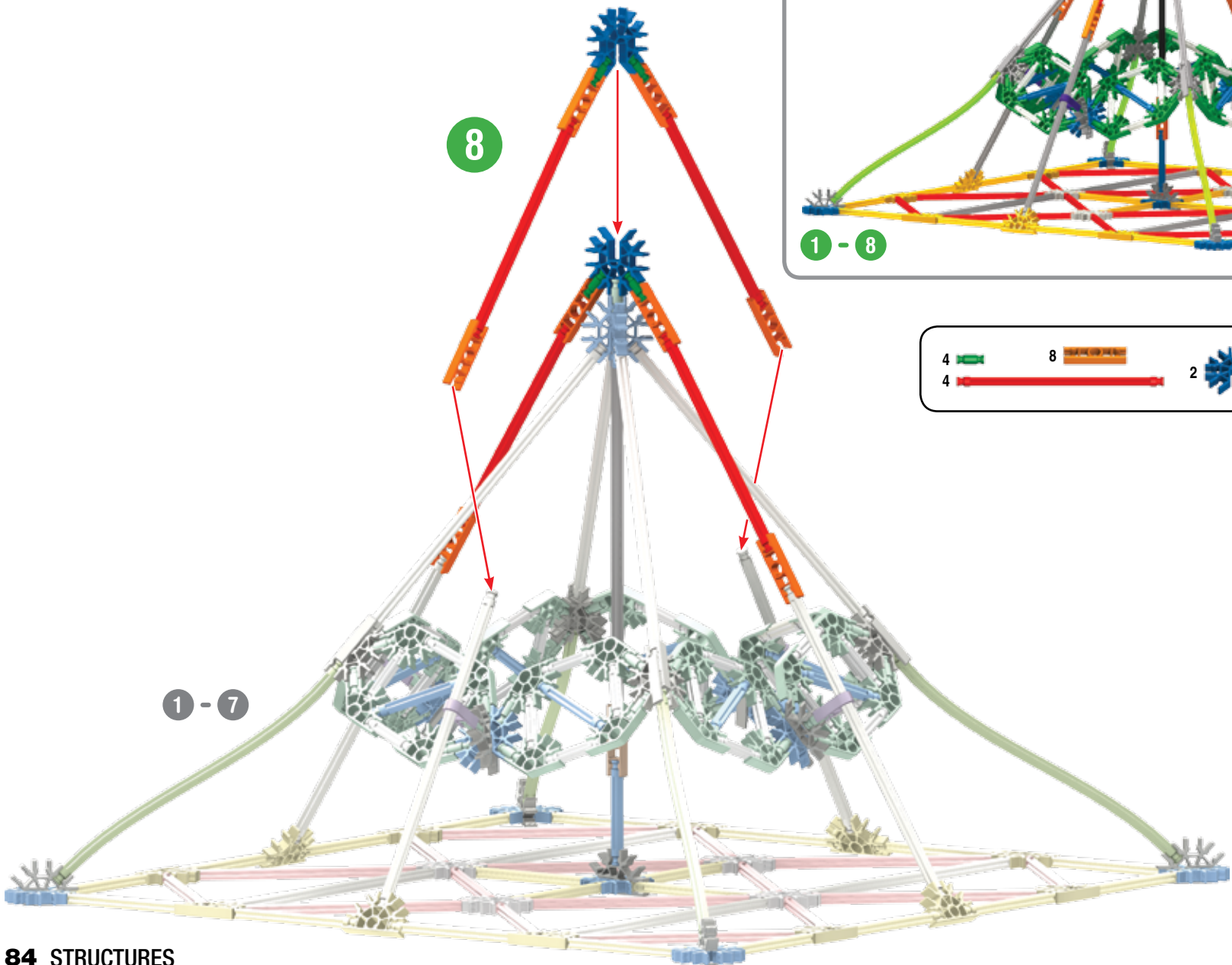

Treehouse

x2

8		12		12	
16					
4					

1

2

x2

1 - 2

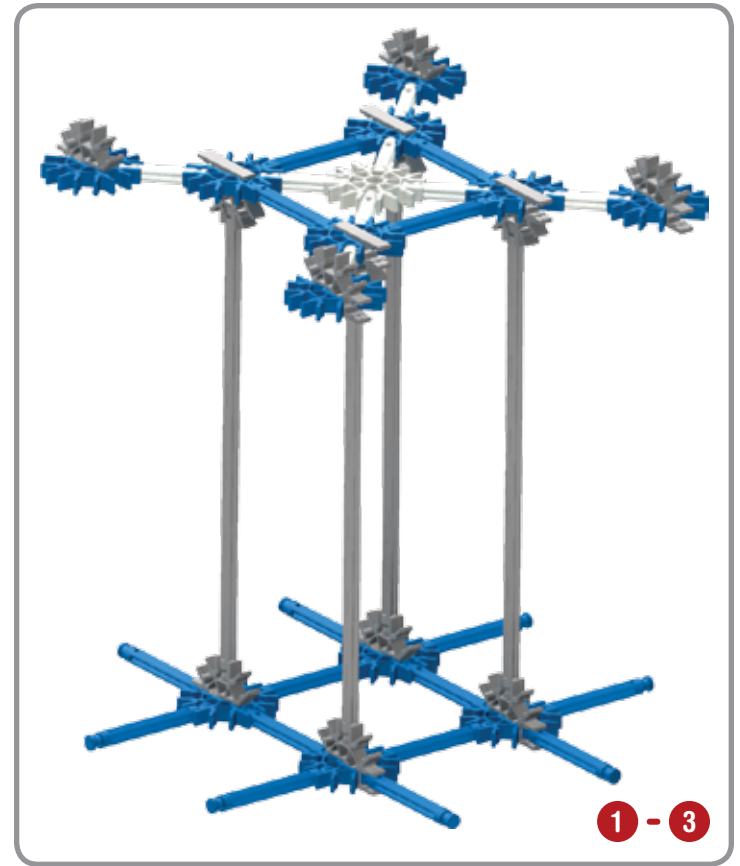
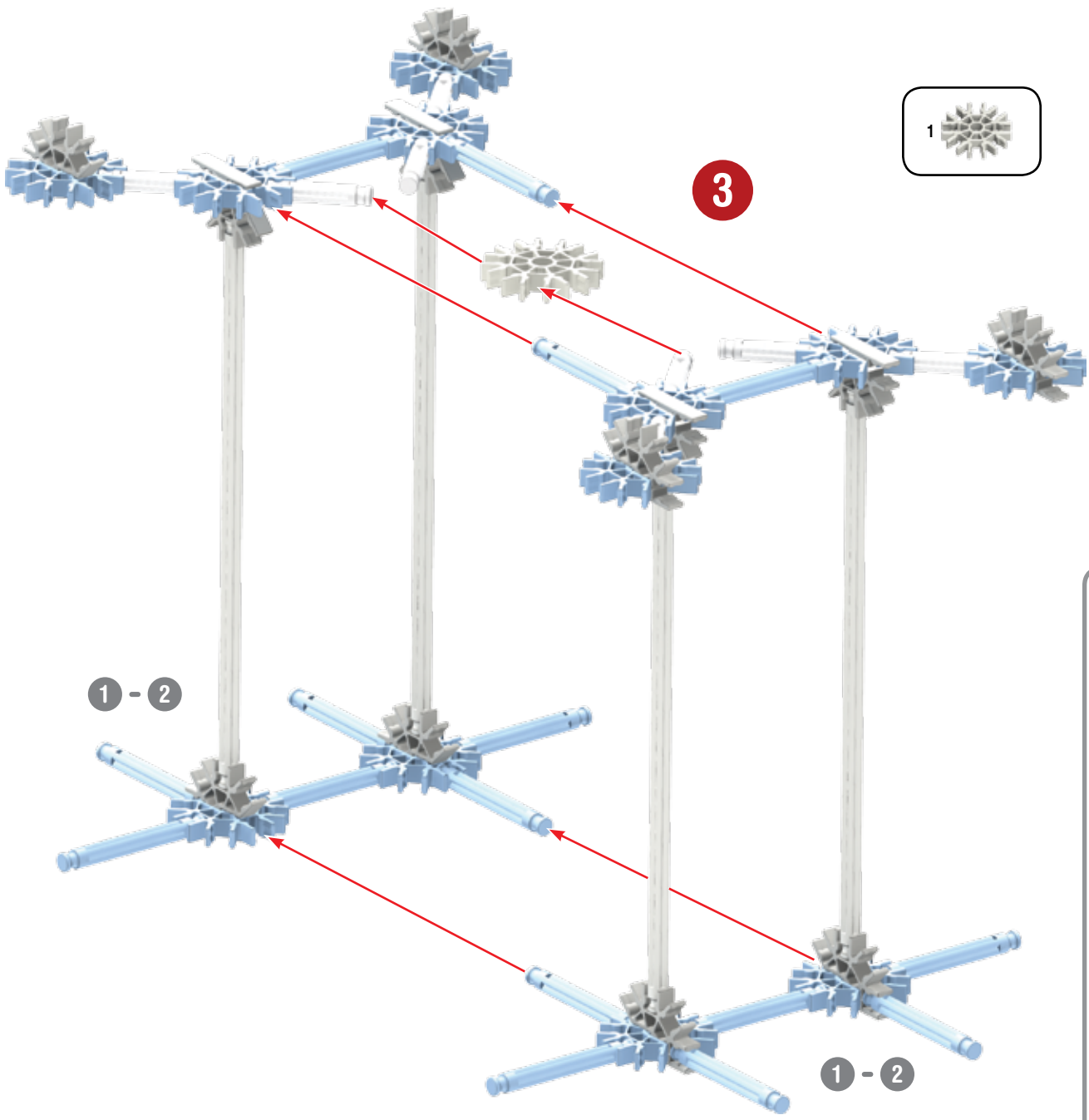

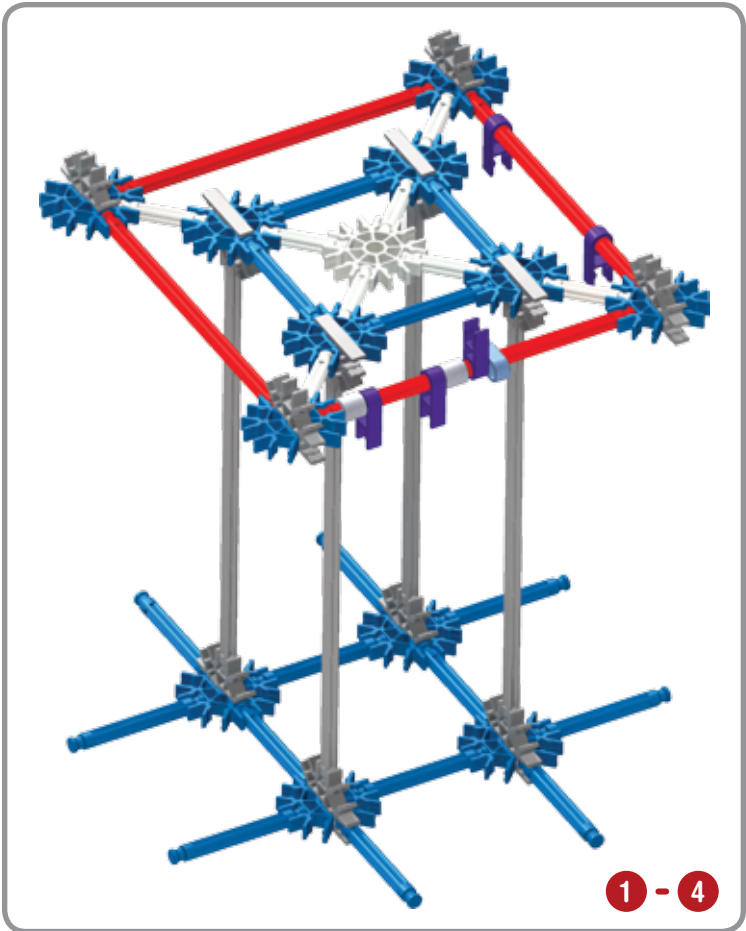
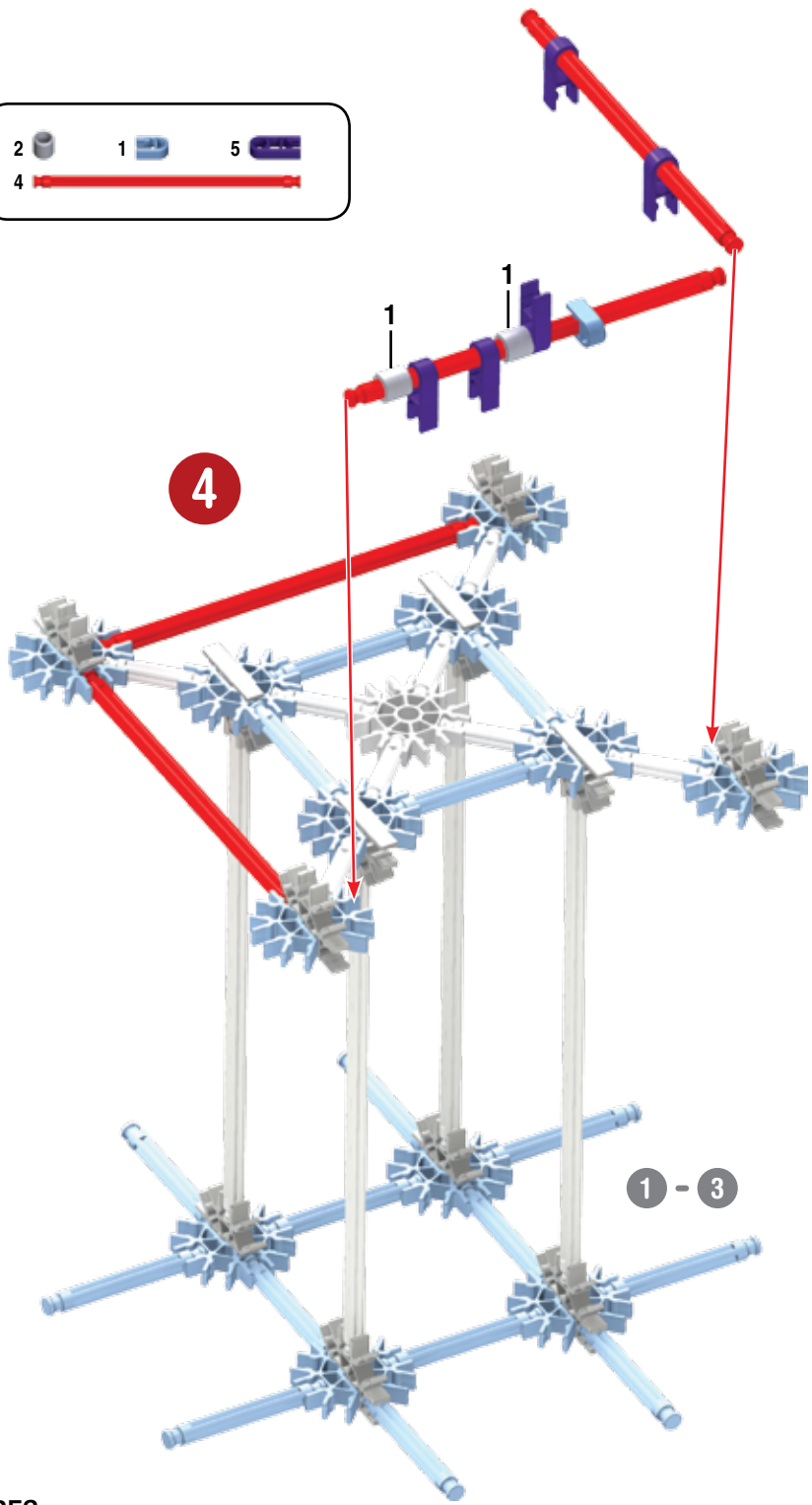

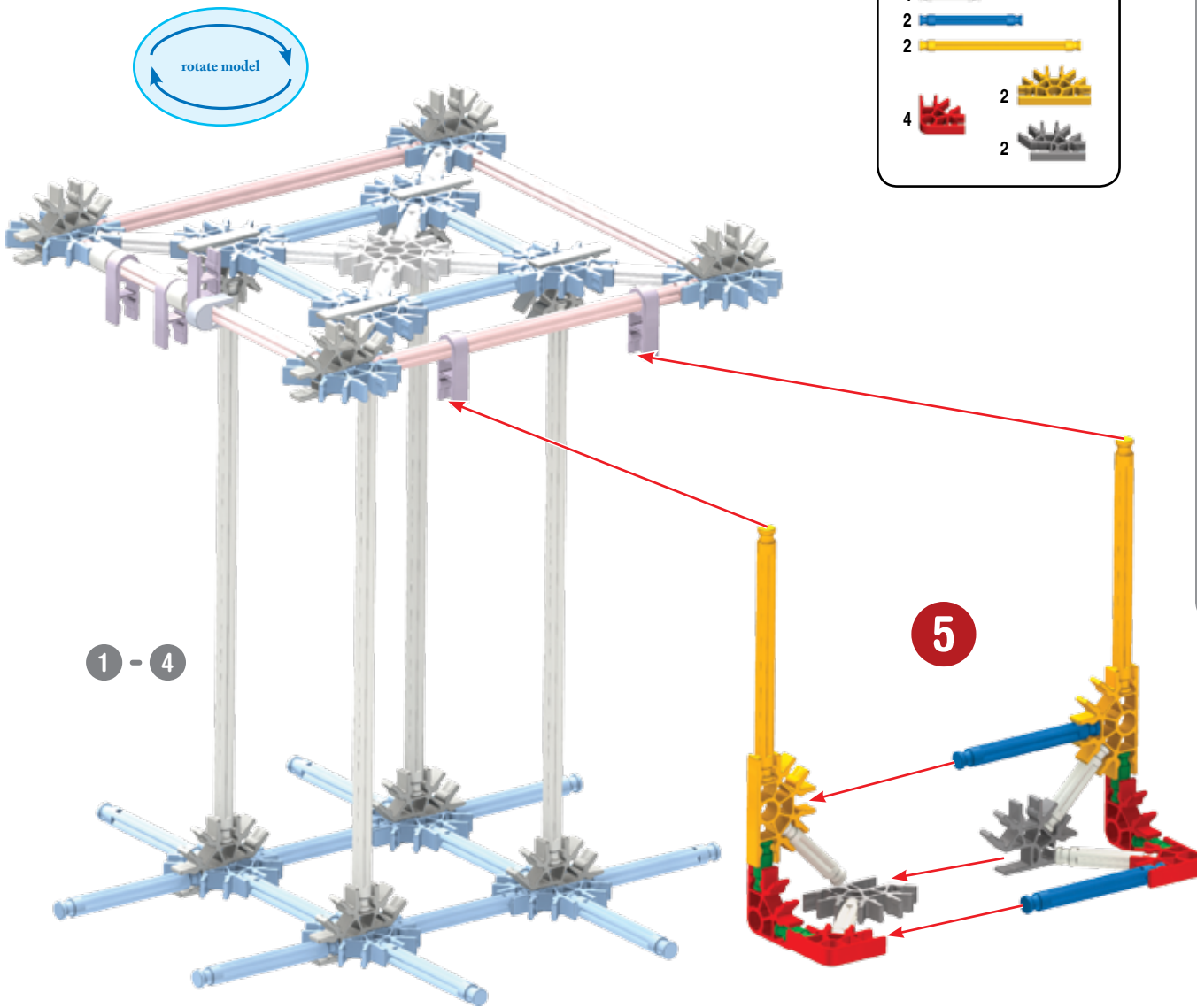

- | | |
|---|--|
| 4 | |
| 4 | |
| 2 | |
| 2 | |
| 4 | |
| 2 | |
| 2 | |

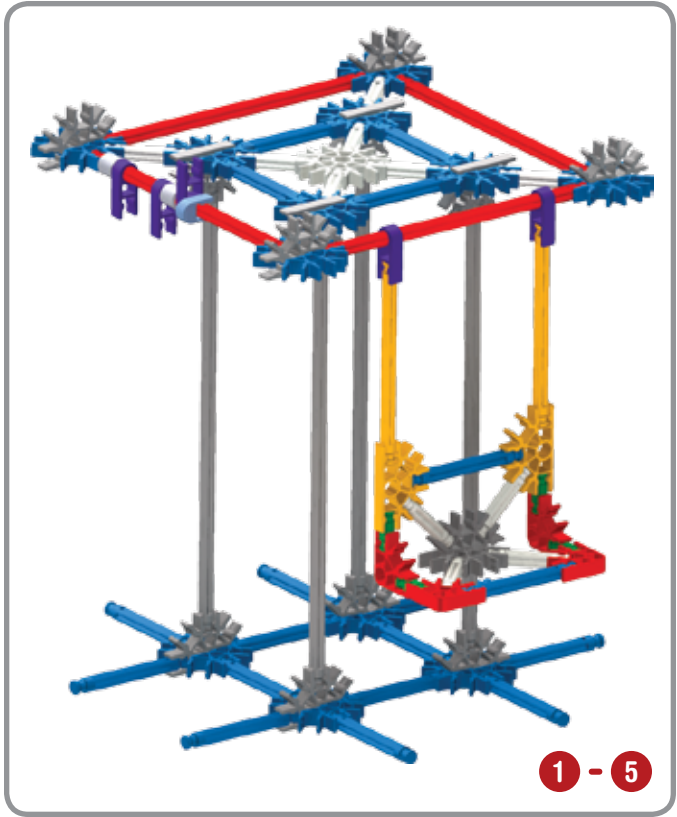

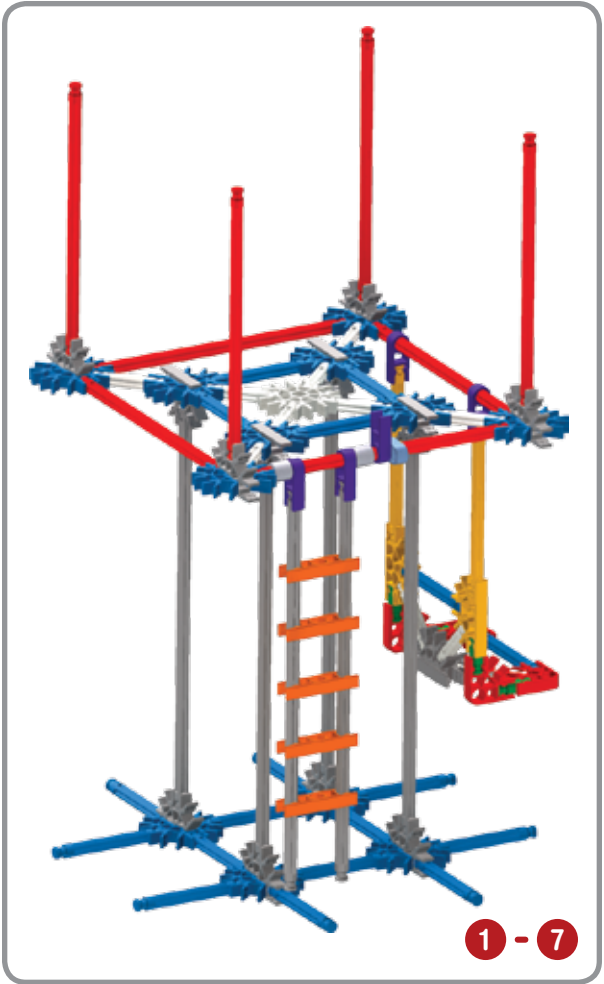
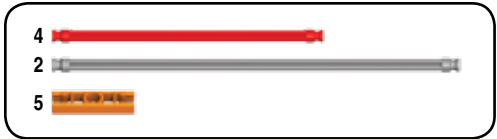
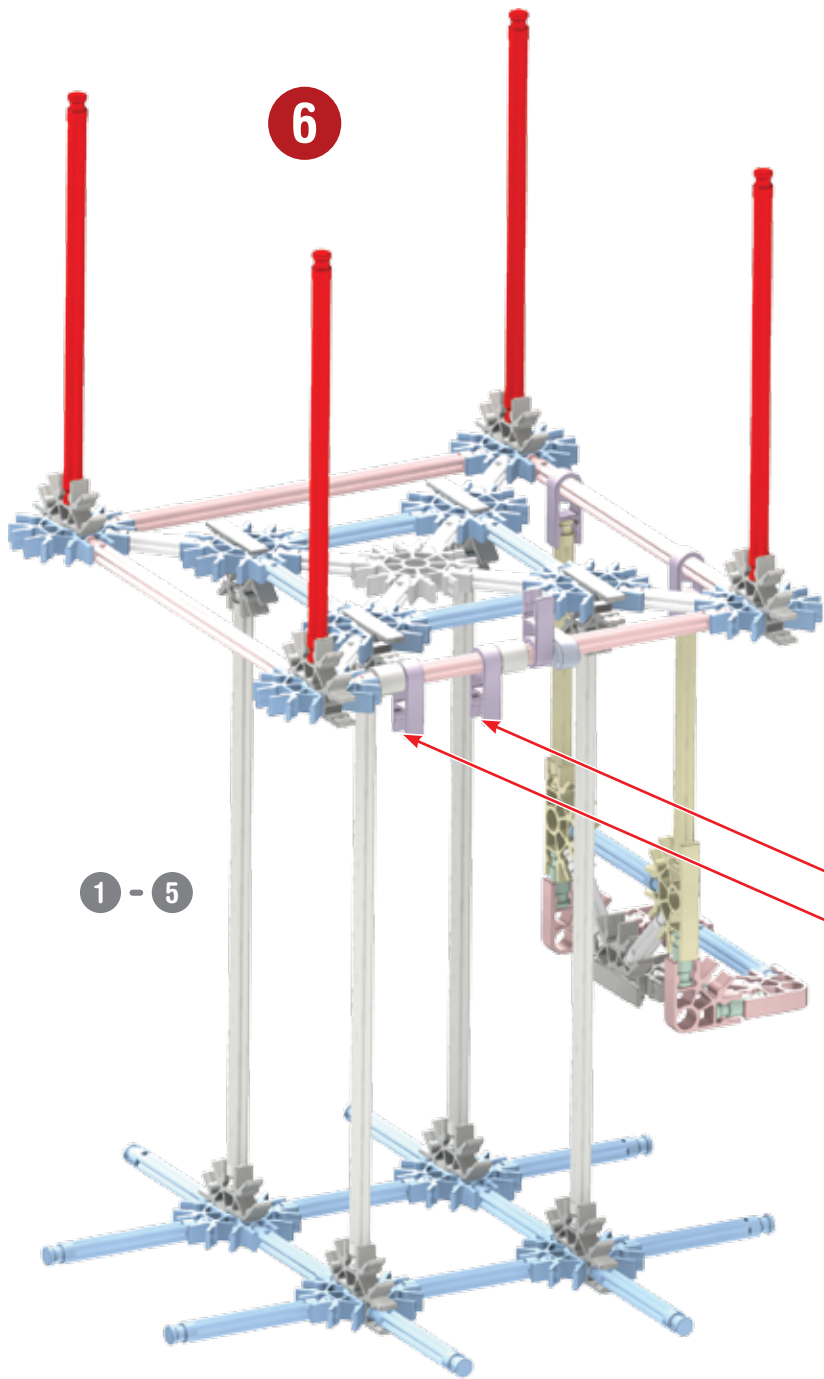

8



1 - 7

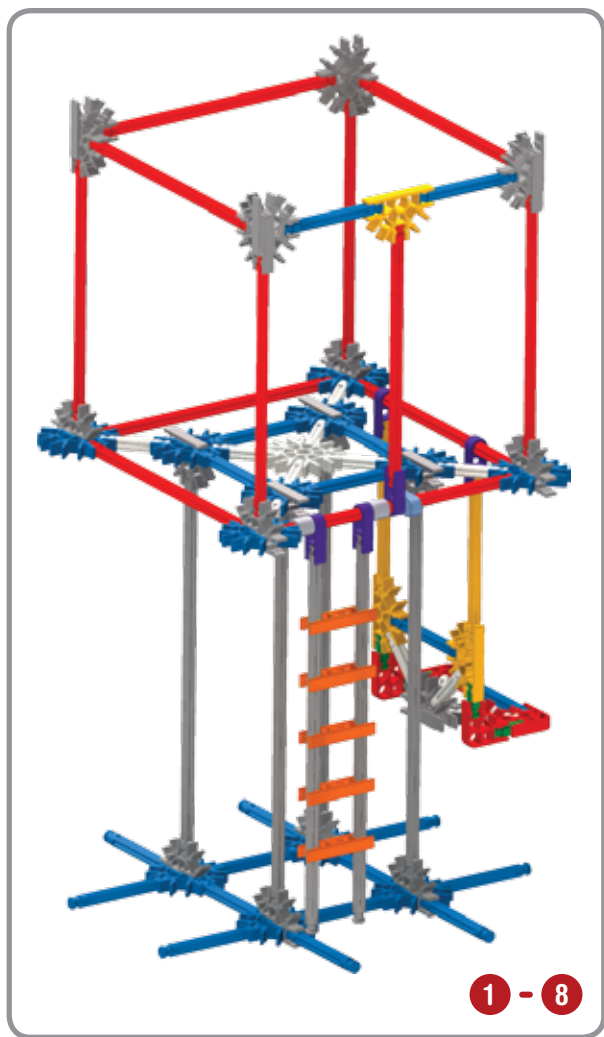
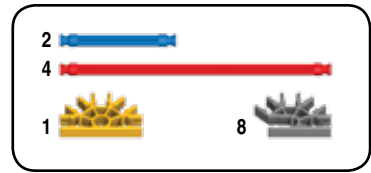

1 - 8

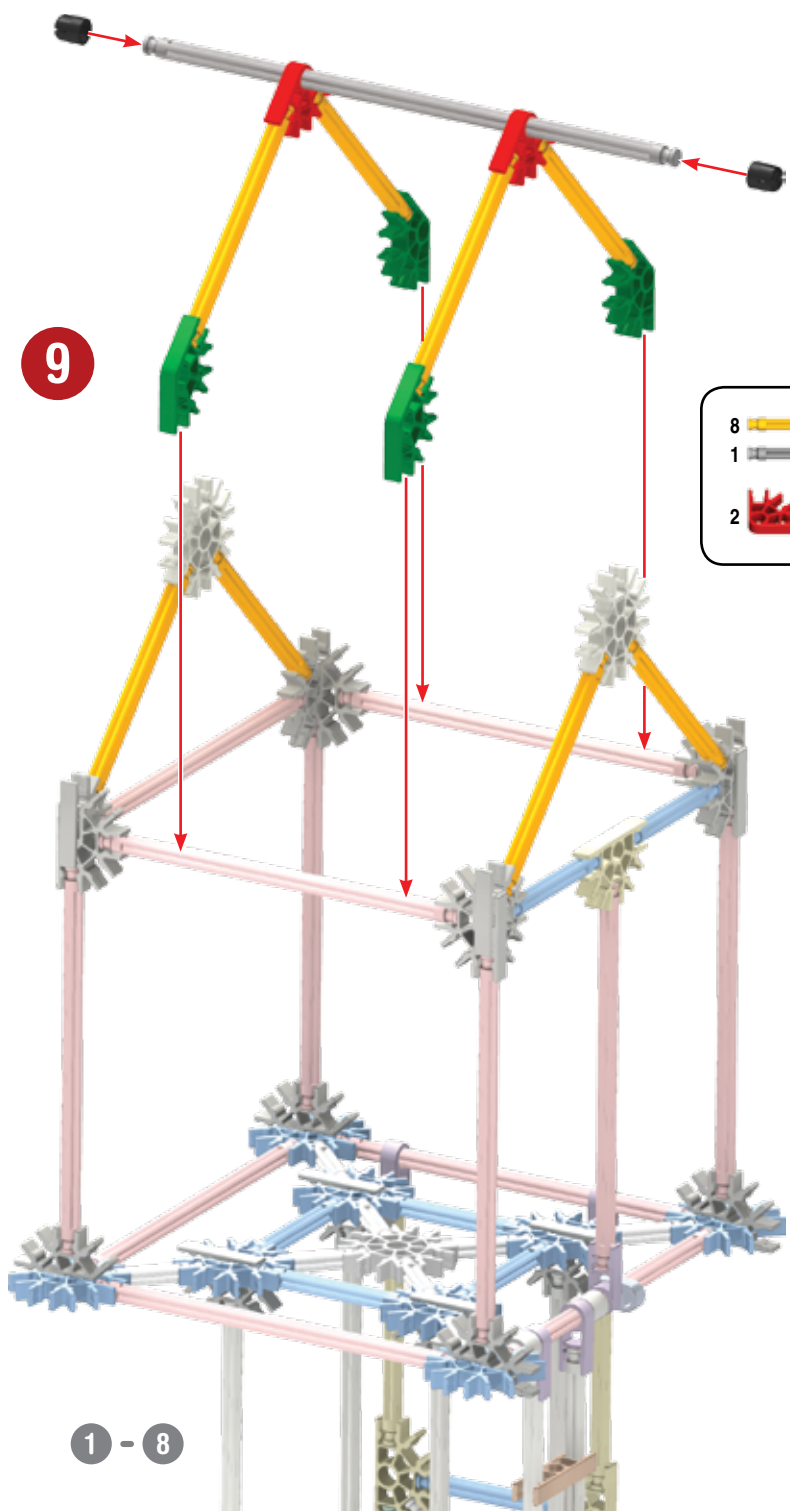

x3

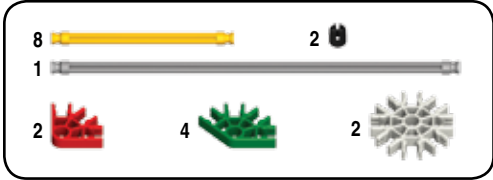

10

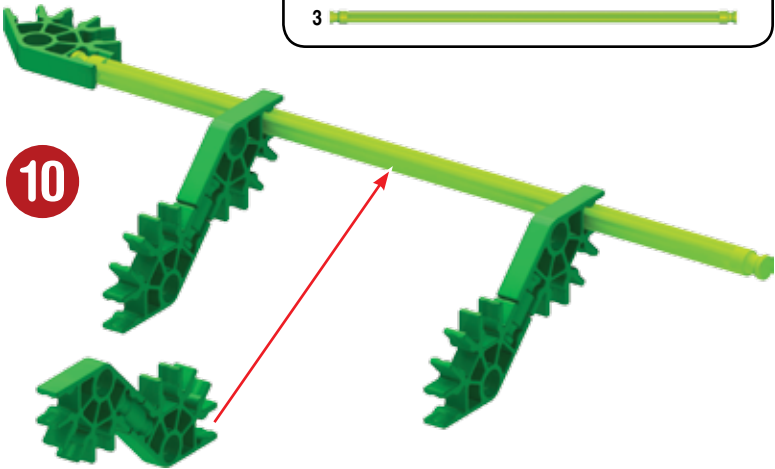

x3

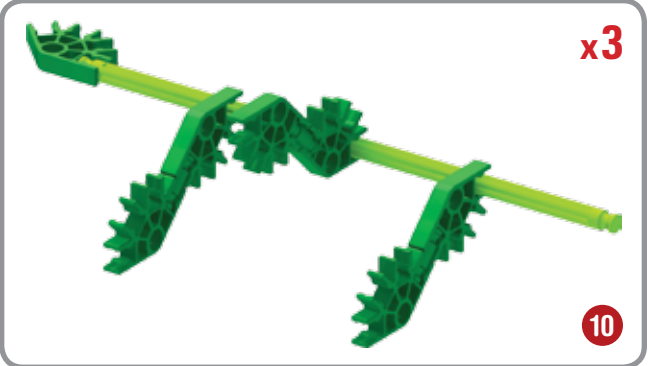

1 - 9

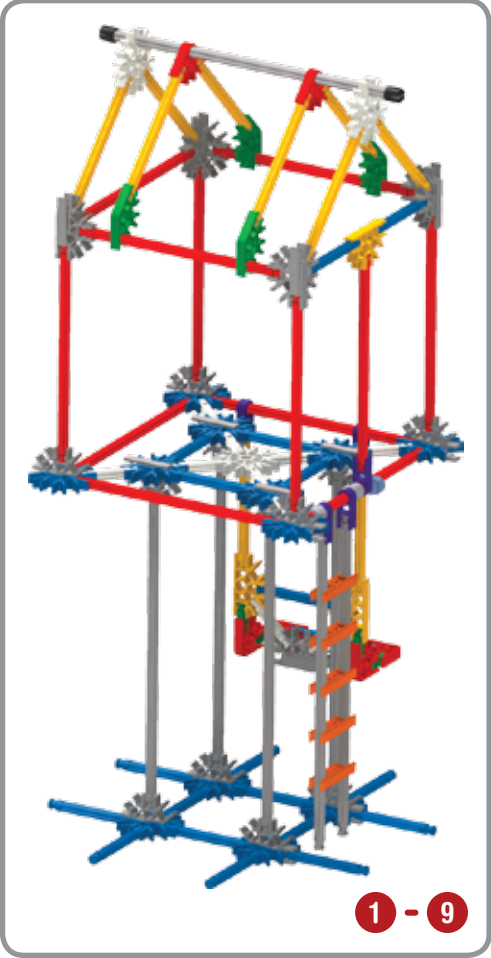

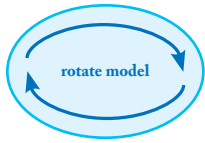

11

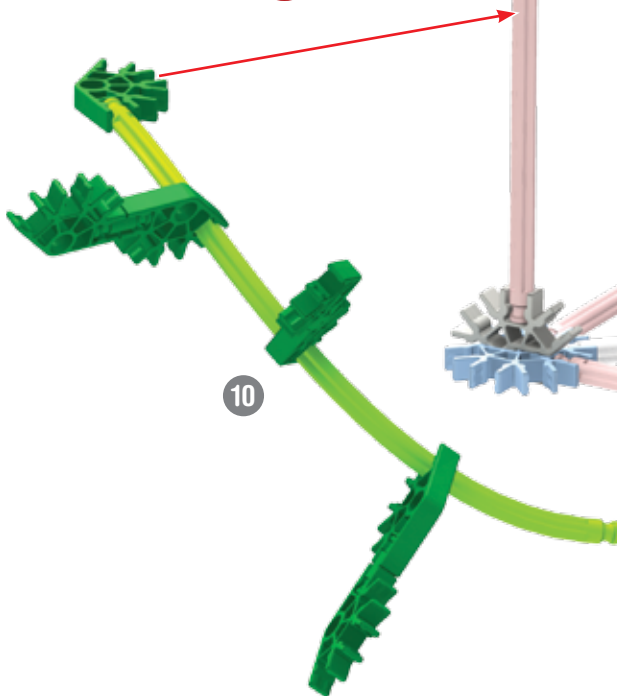

10

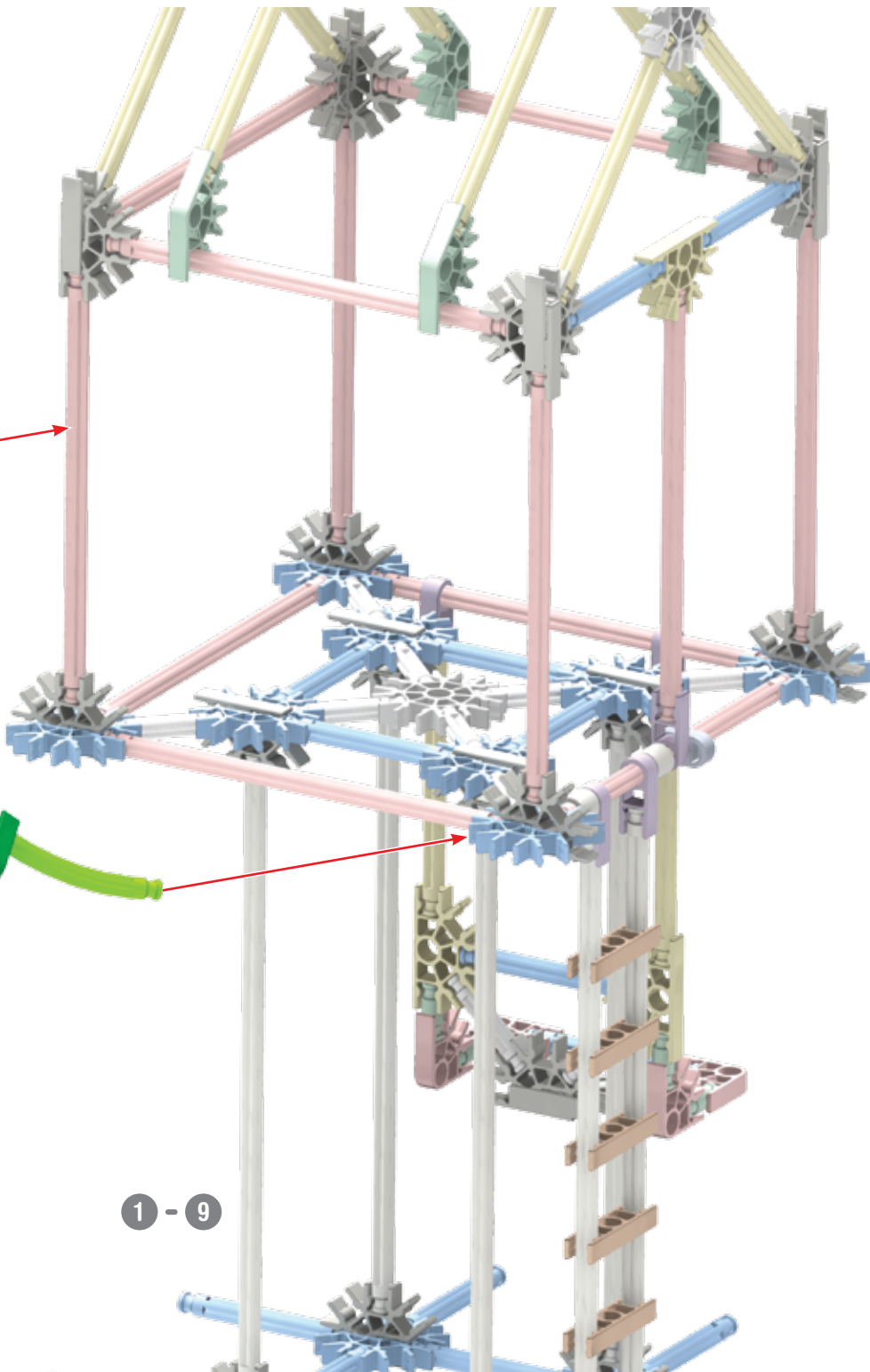

1 - 9

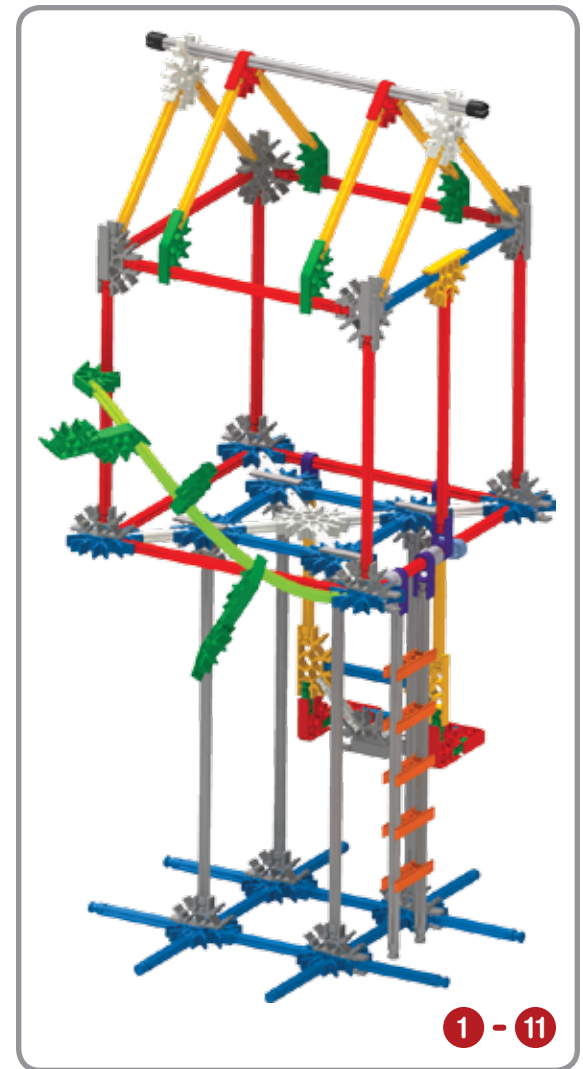

1 - 11

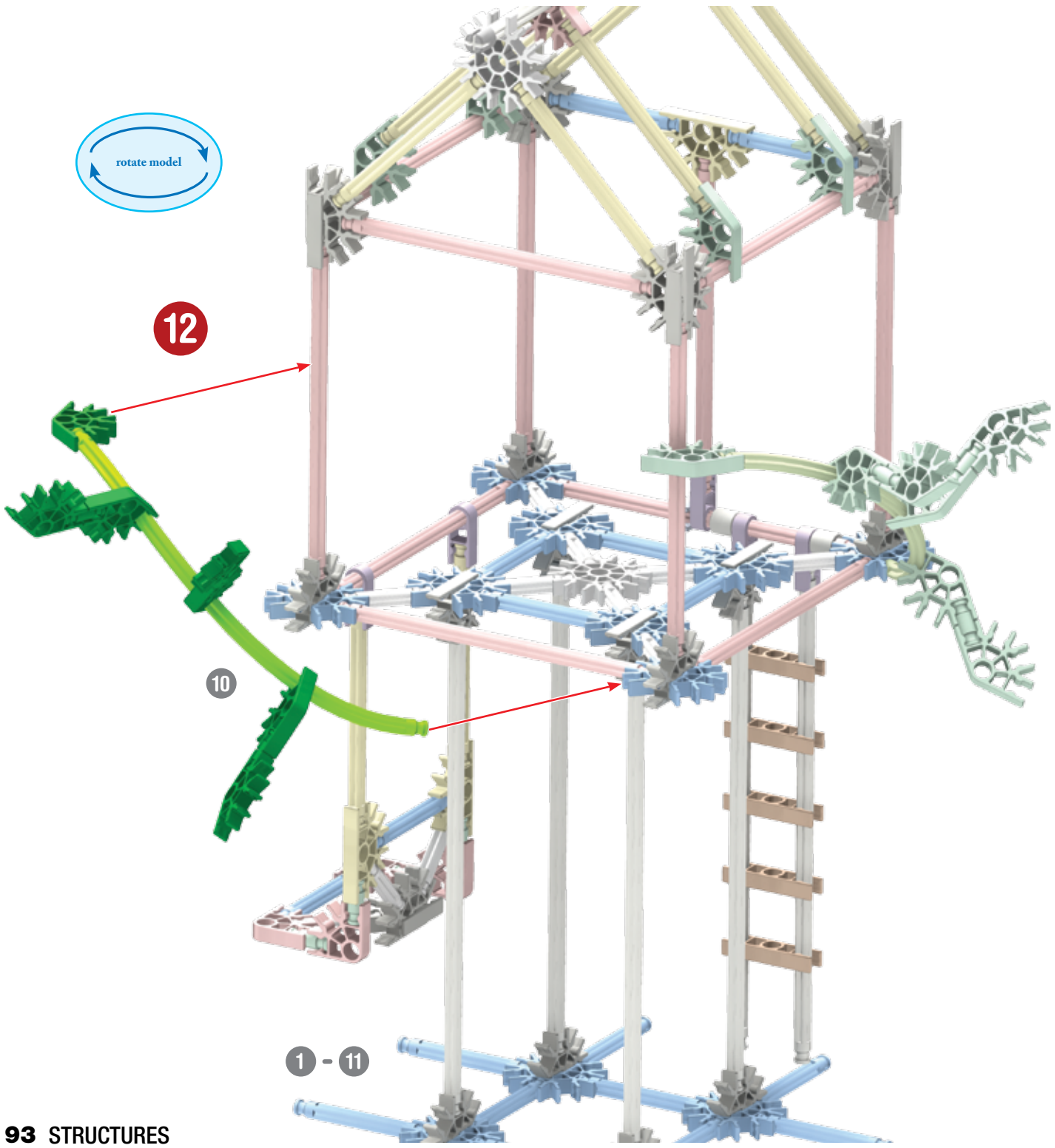
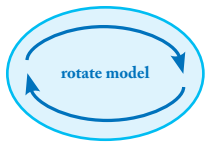

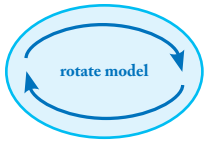

13

10

1 - 12

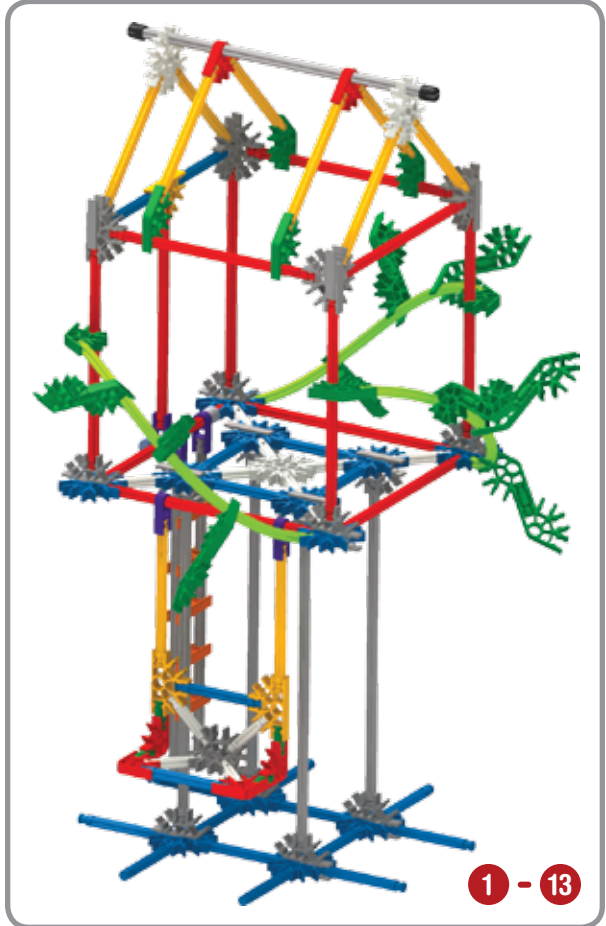
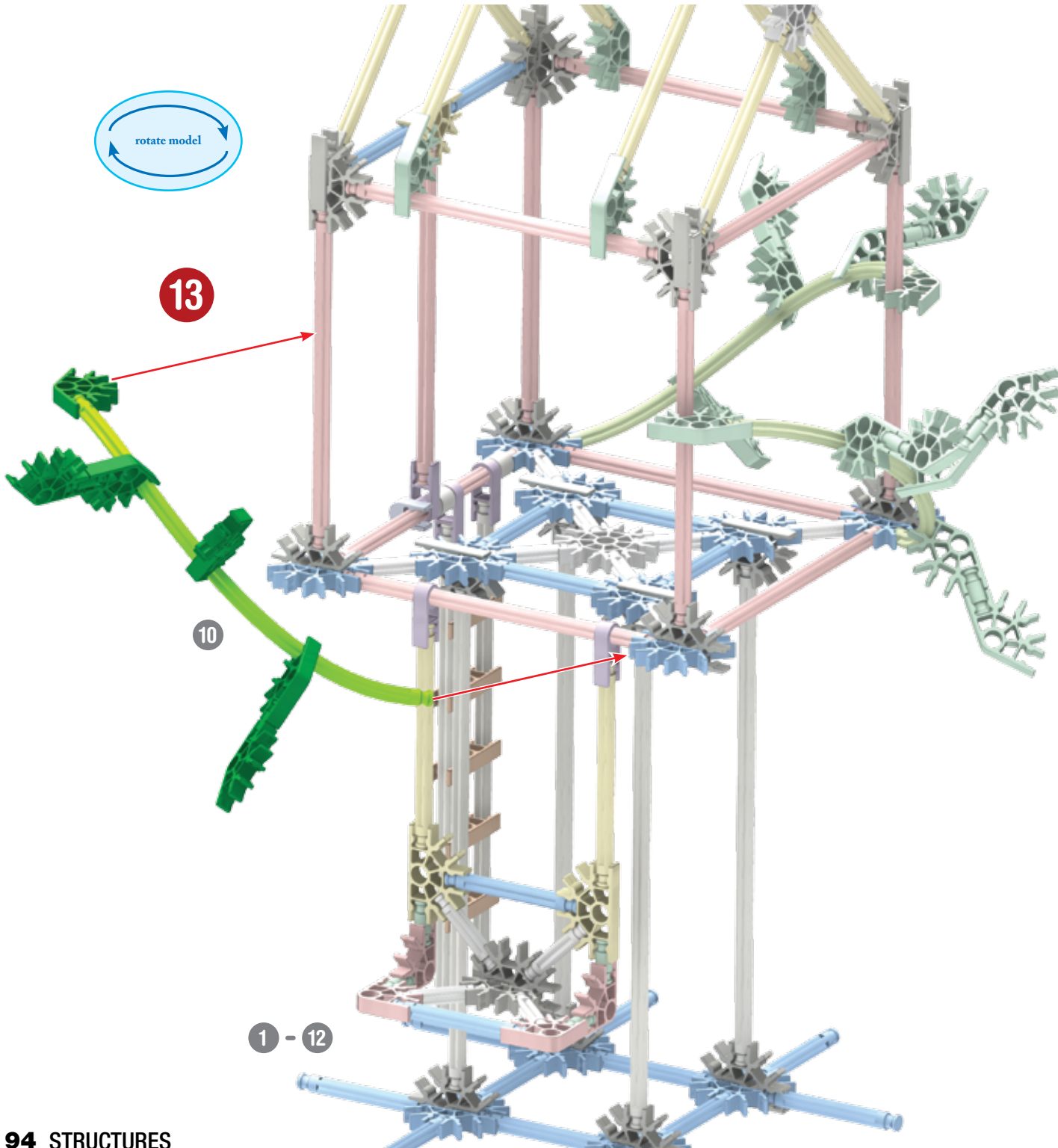

x4

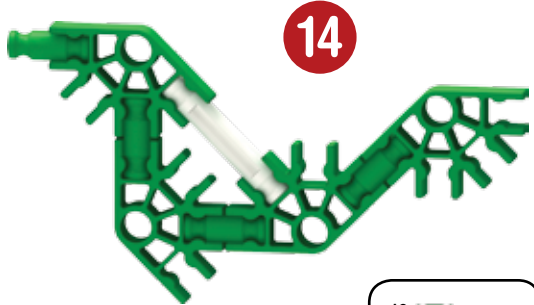

14

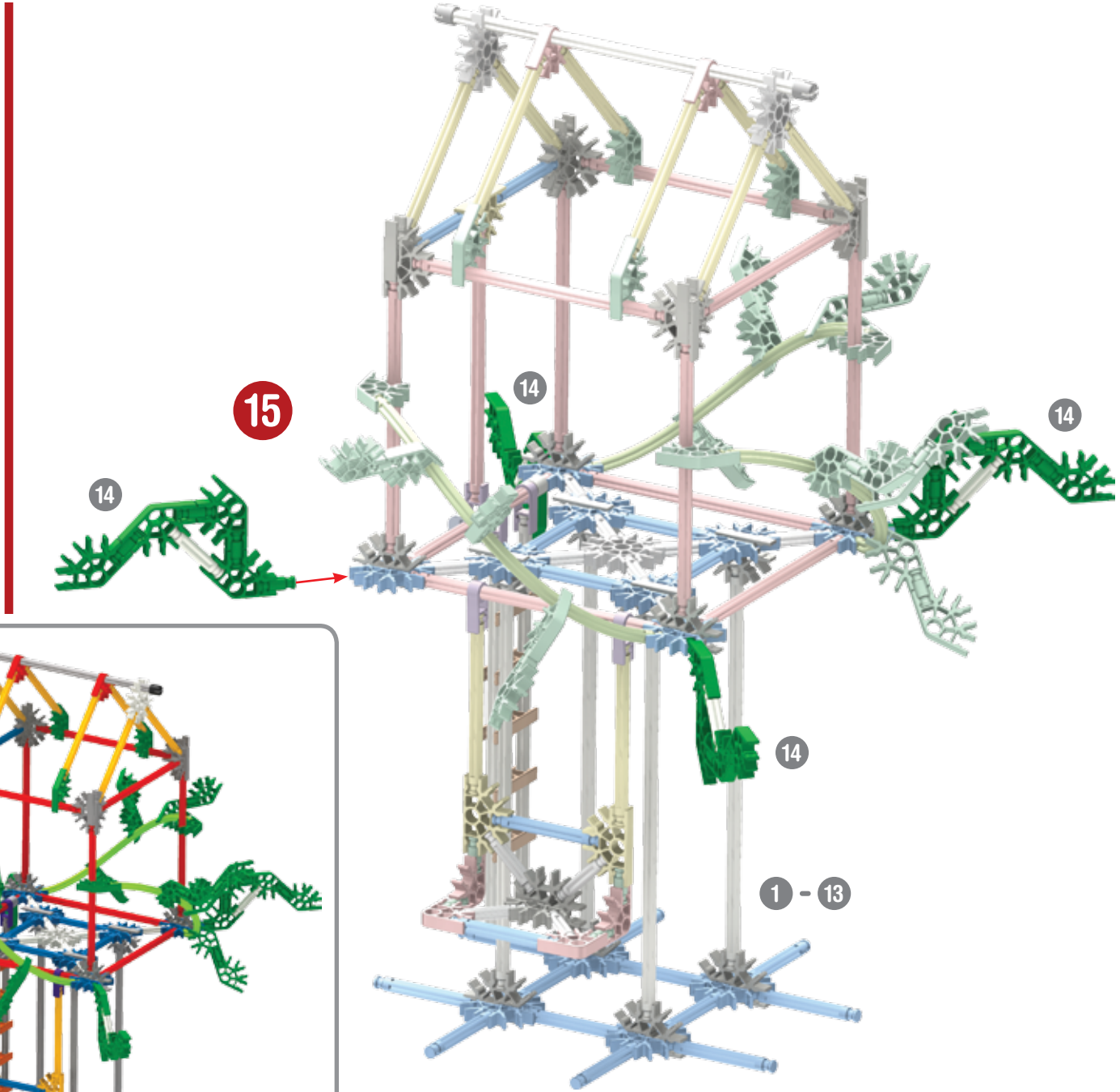
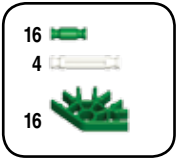

15

14

14

14

14

1 - 13

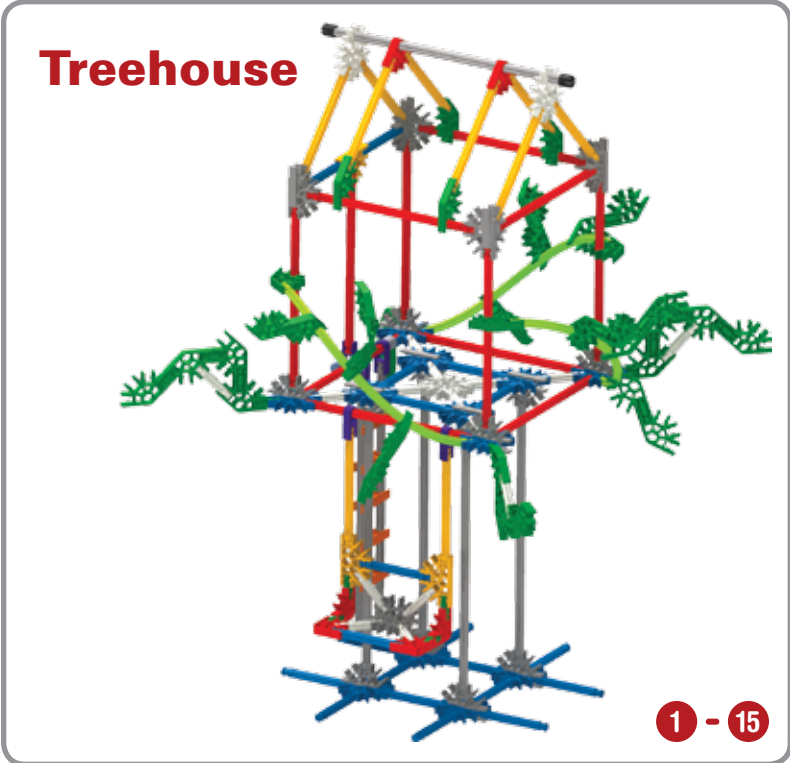

Treehouse

1 - 15

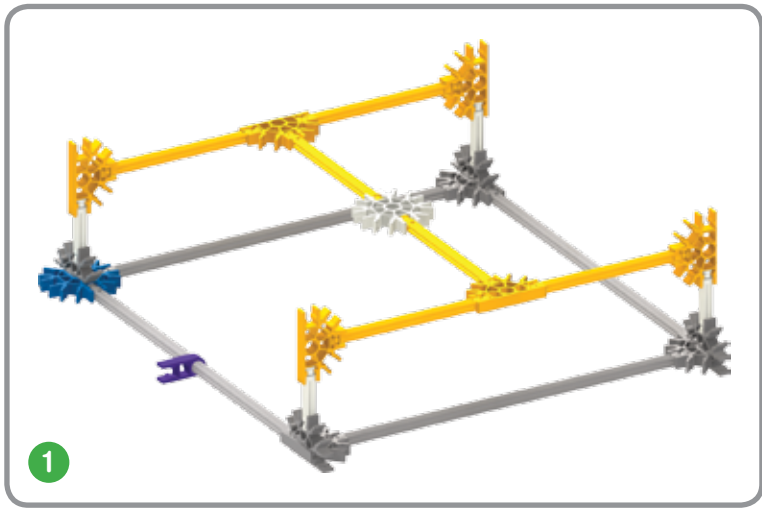
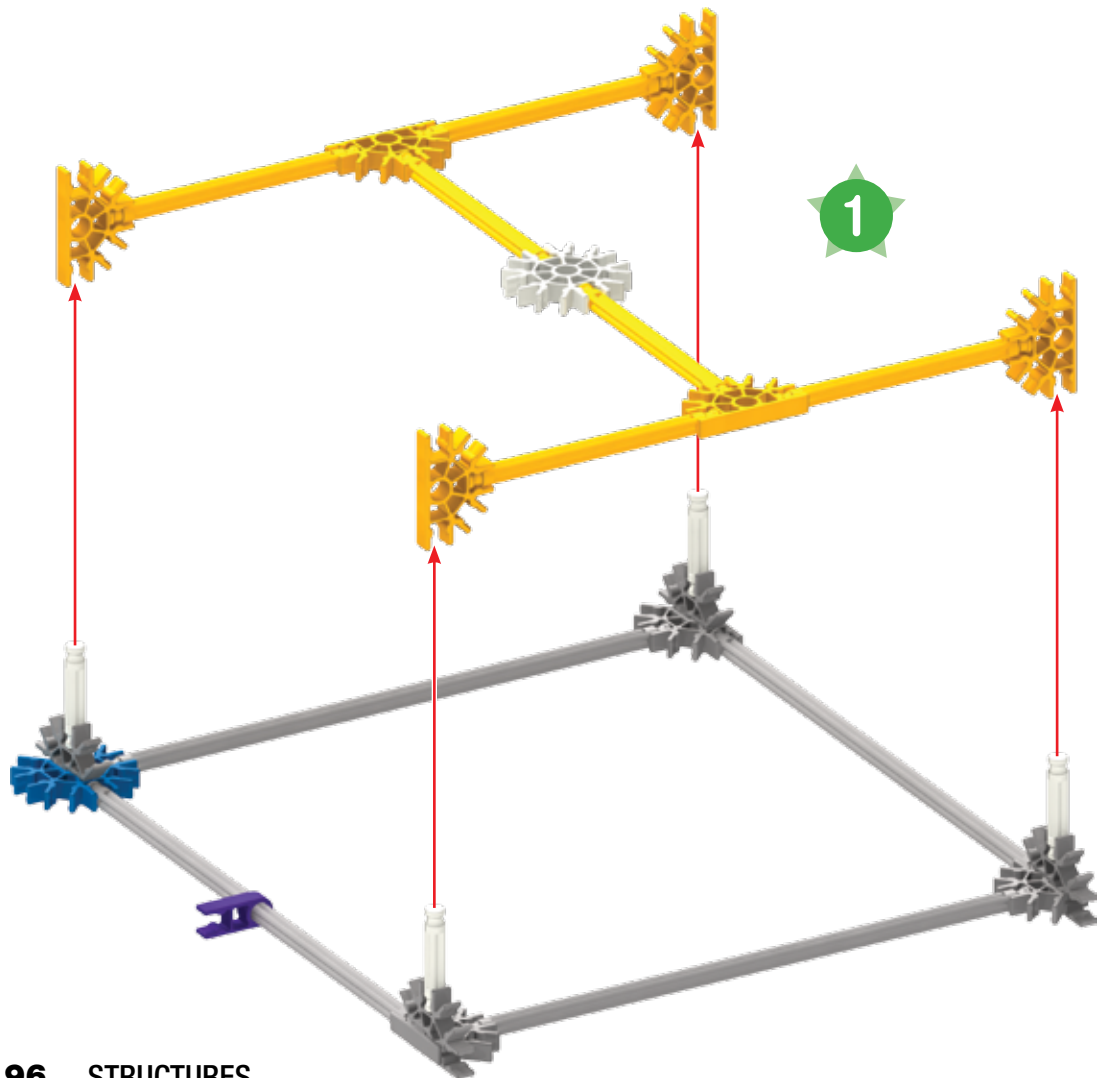

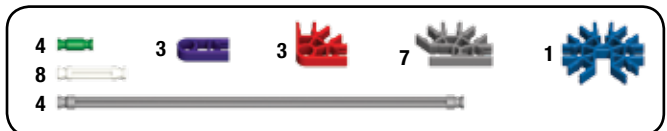
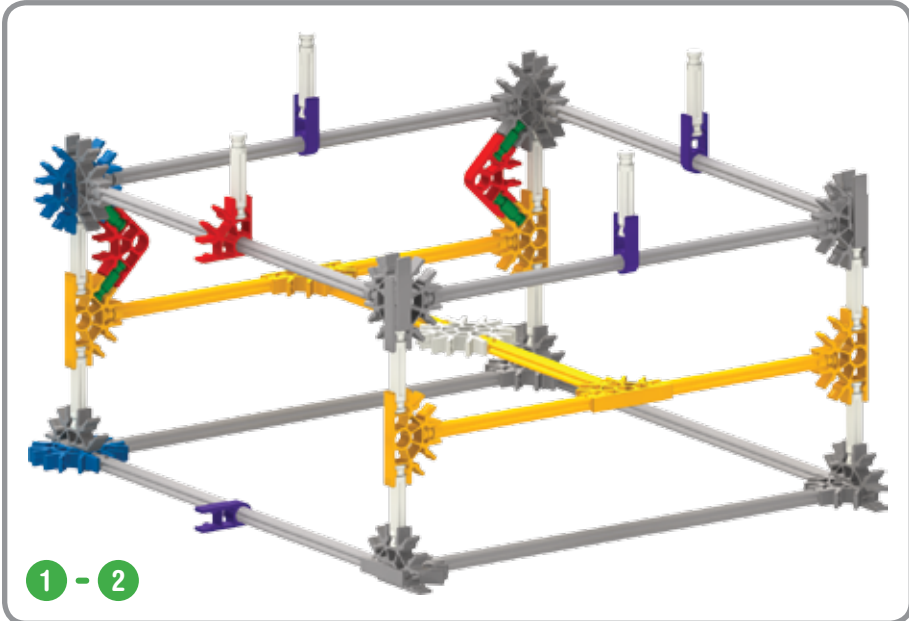
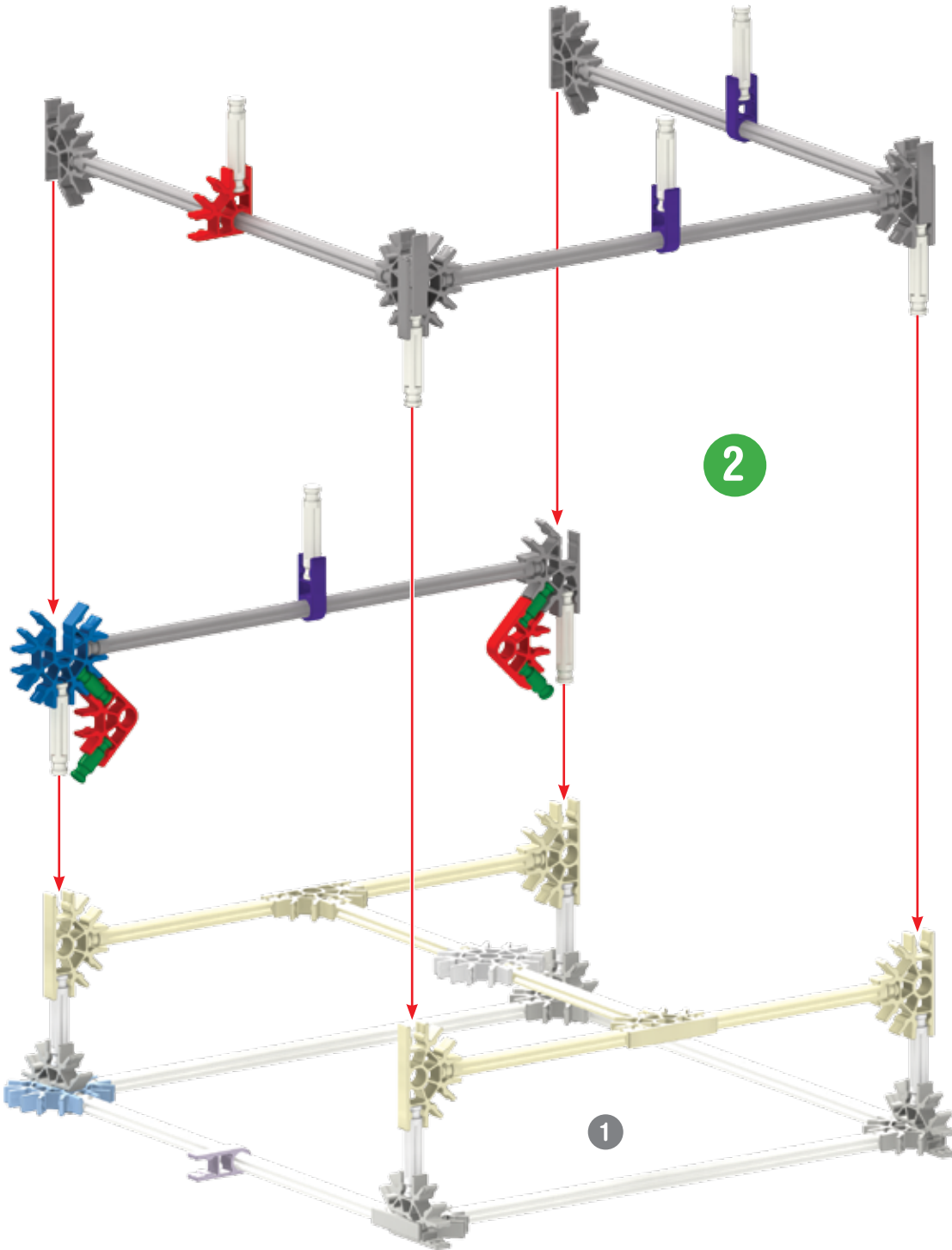

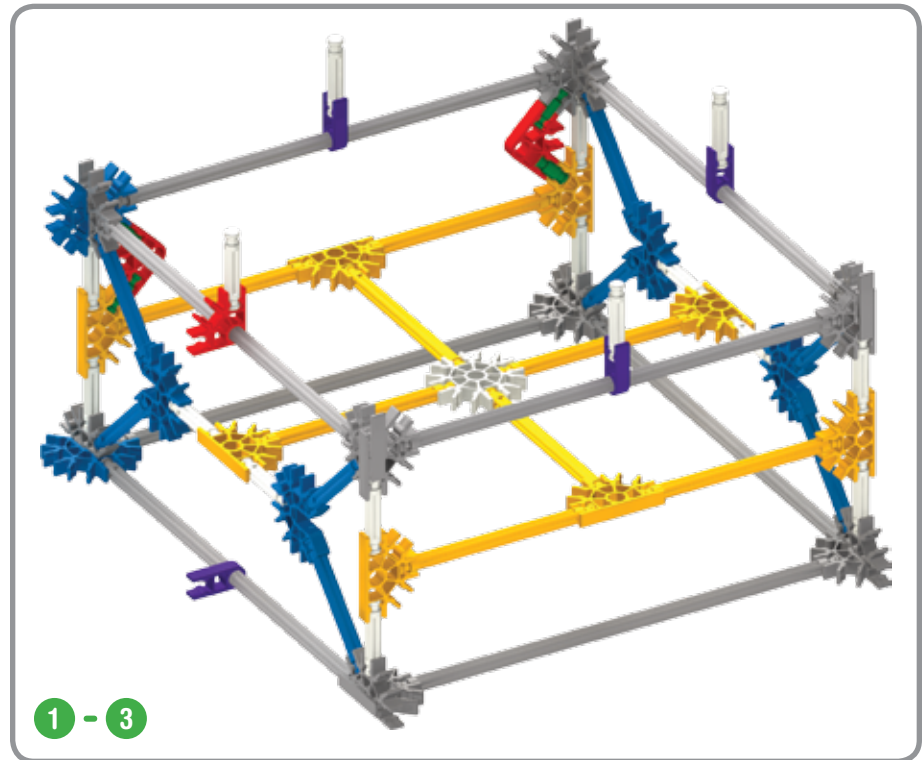
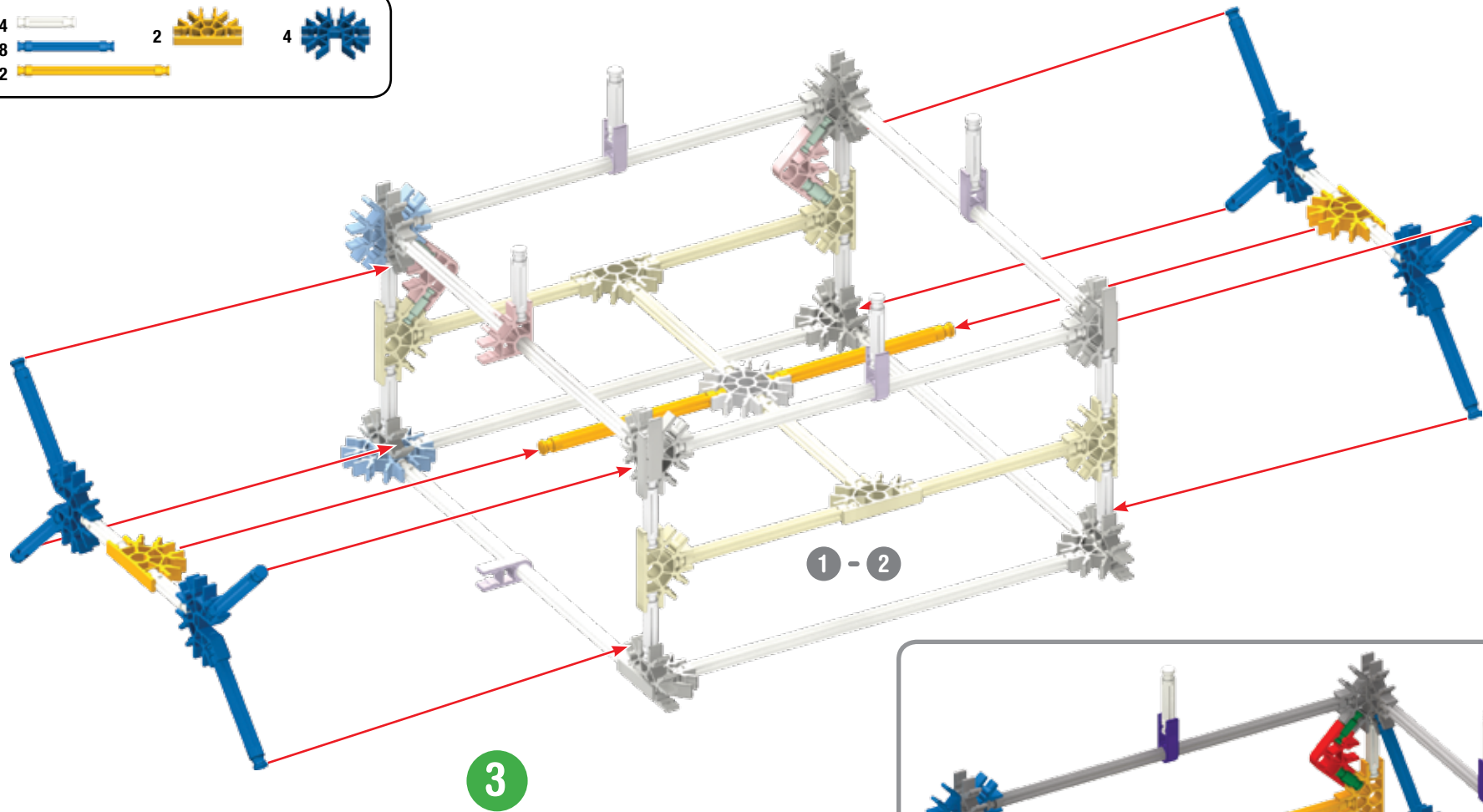
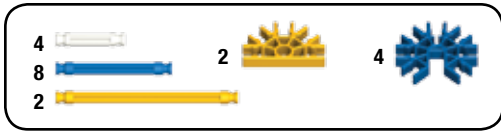

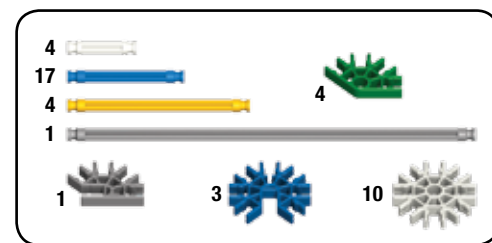
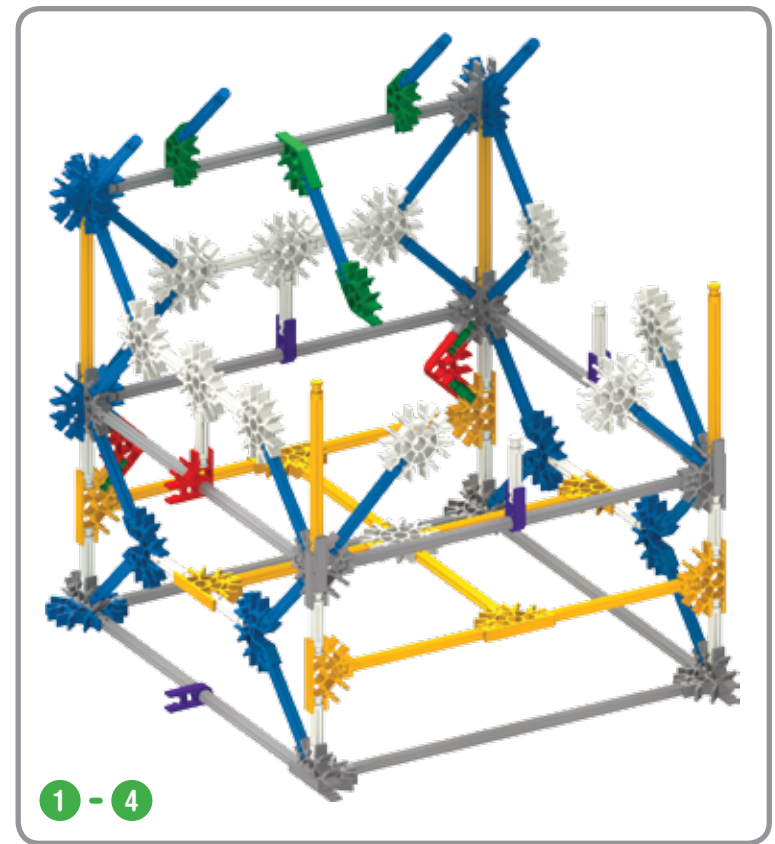
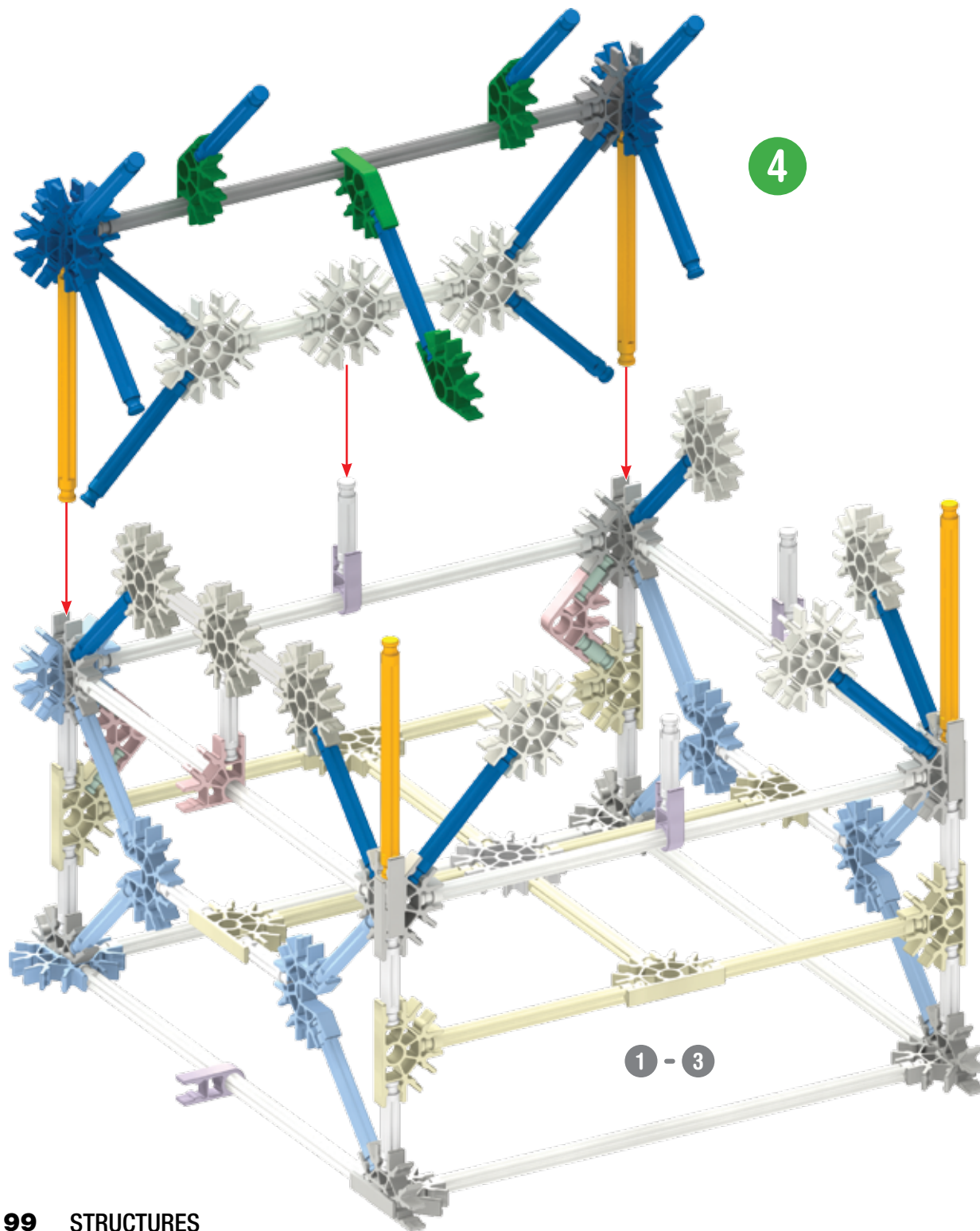

- 8 2 10 2 1 2
- 2
- 1

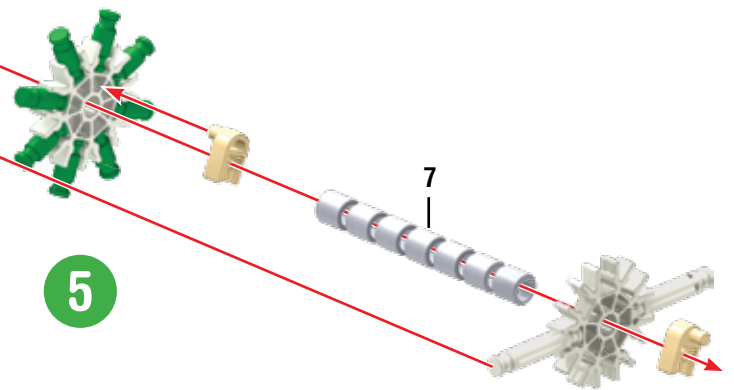
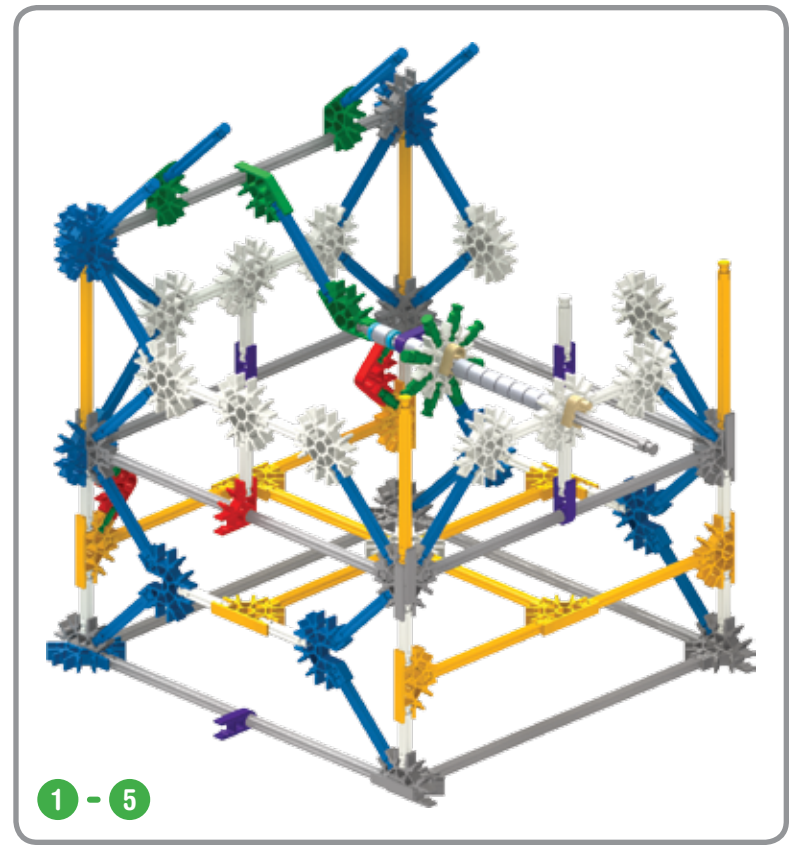
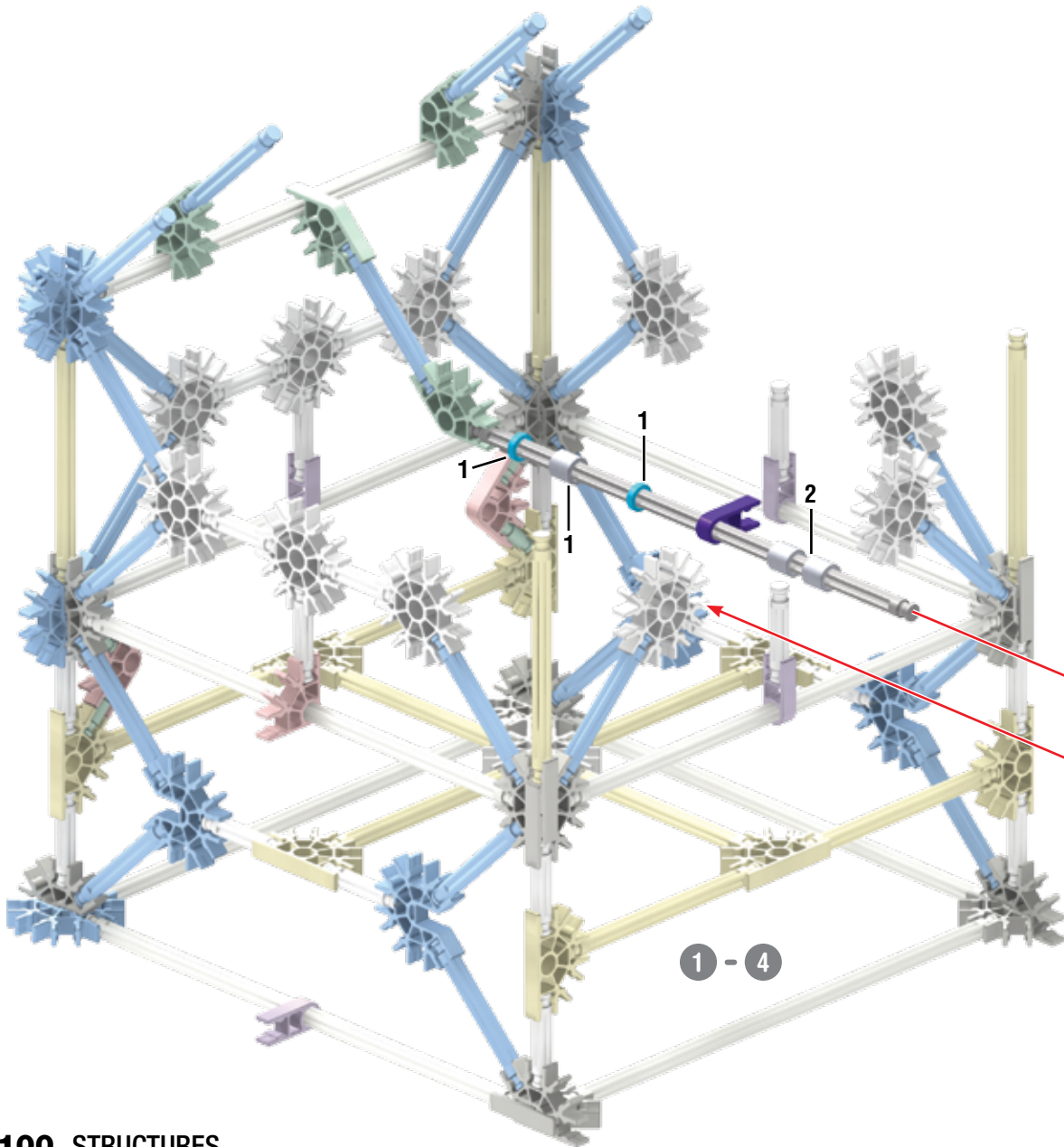

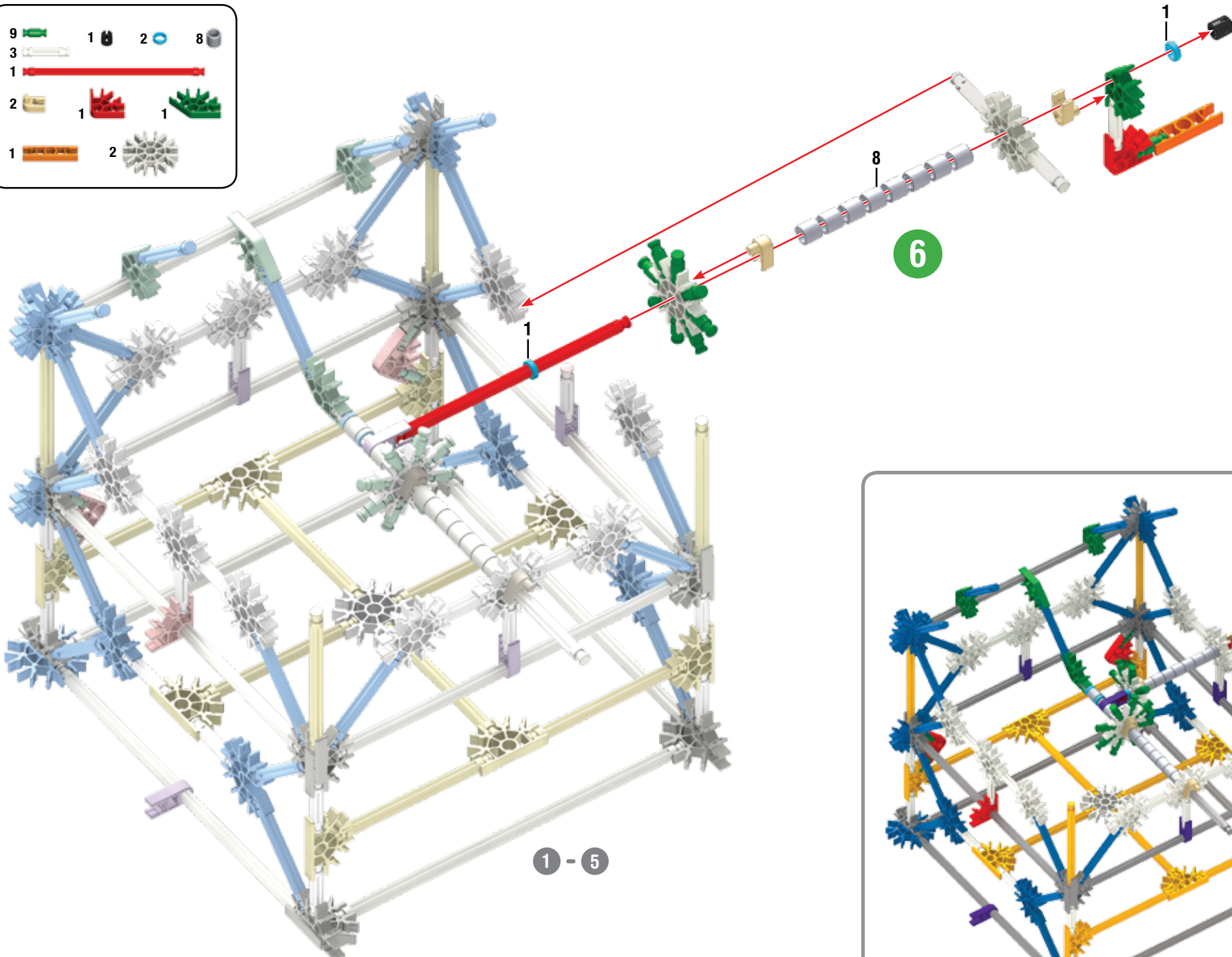
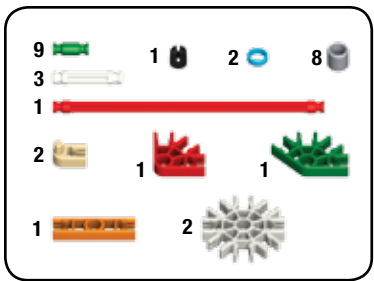

1 - 5

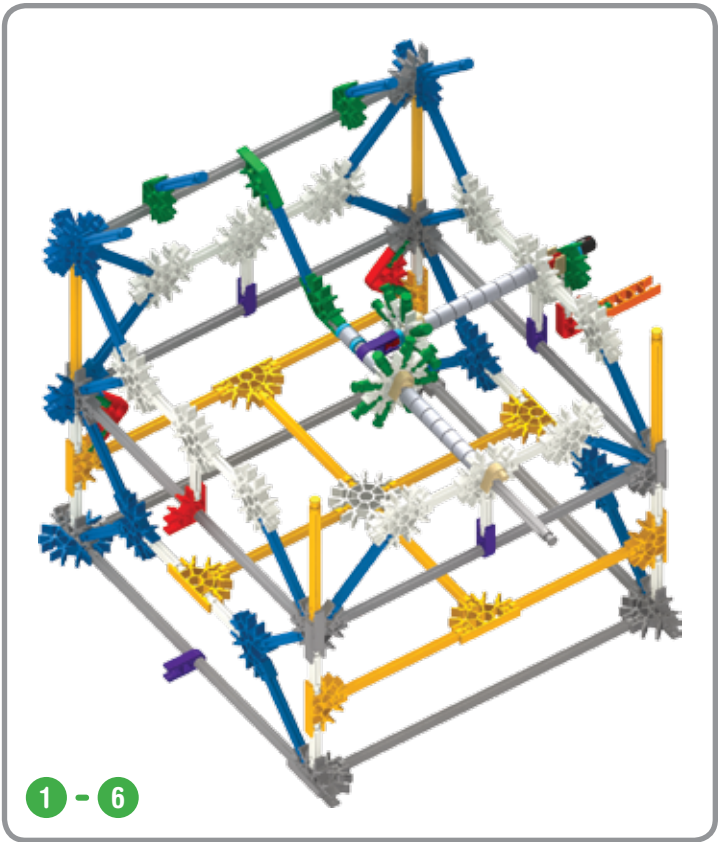

1 - 6

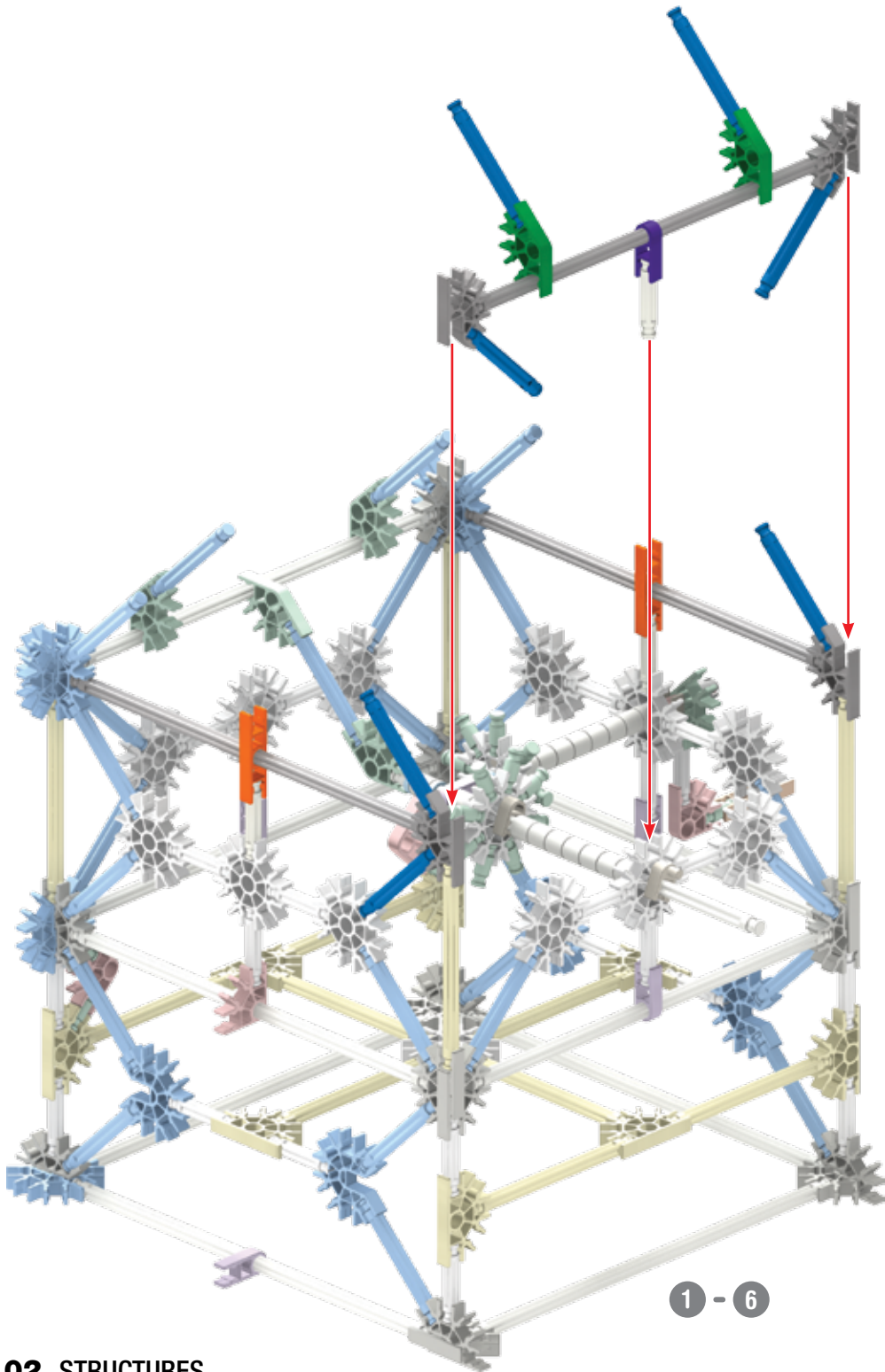

7

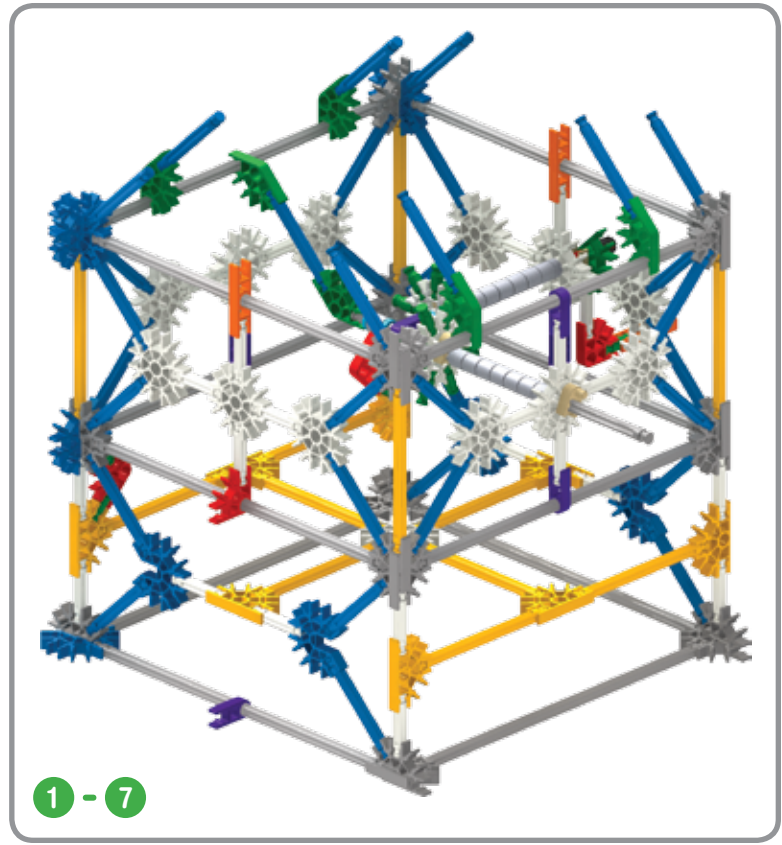

1 - 7

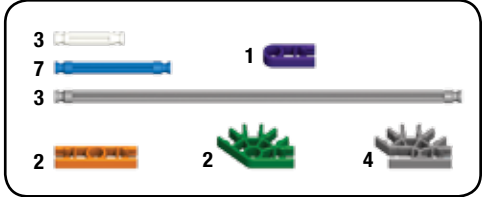

1 - 6

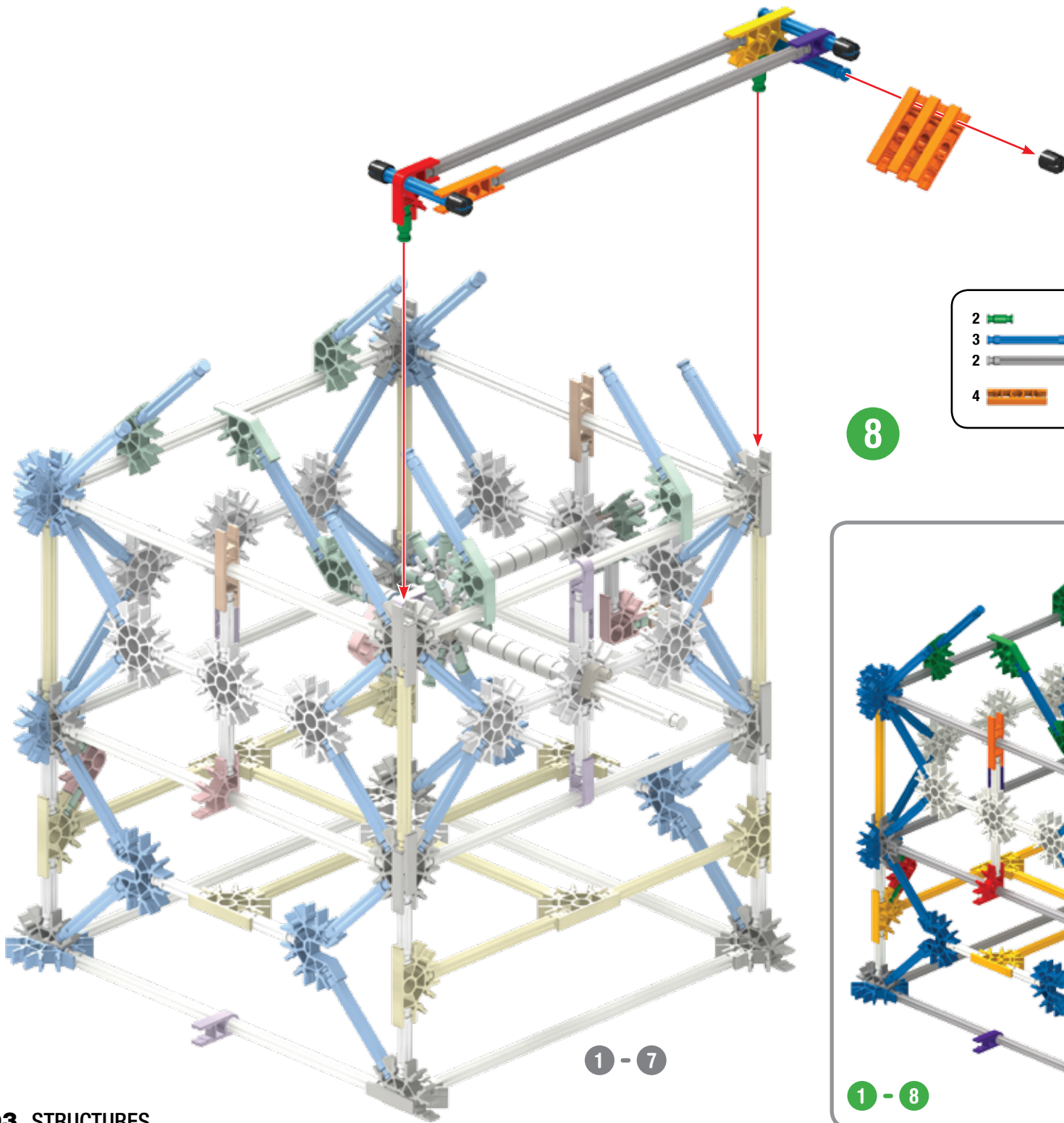

2		4		1	
3					
2					
4		1		1	

8

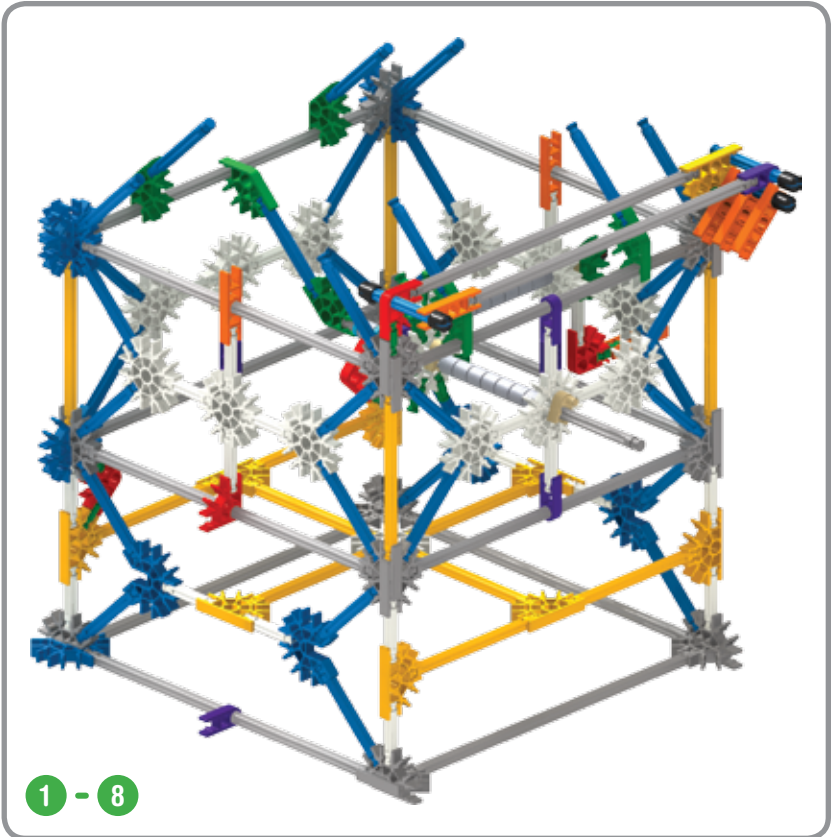

1 - 8

1 - 7

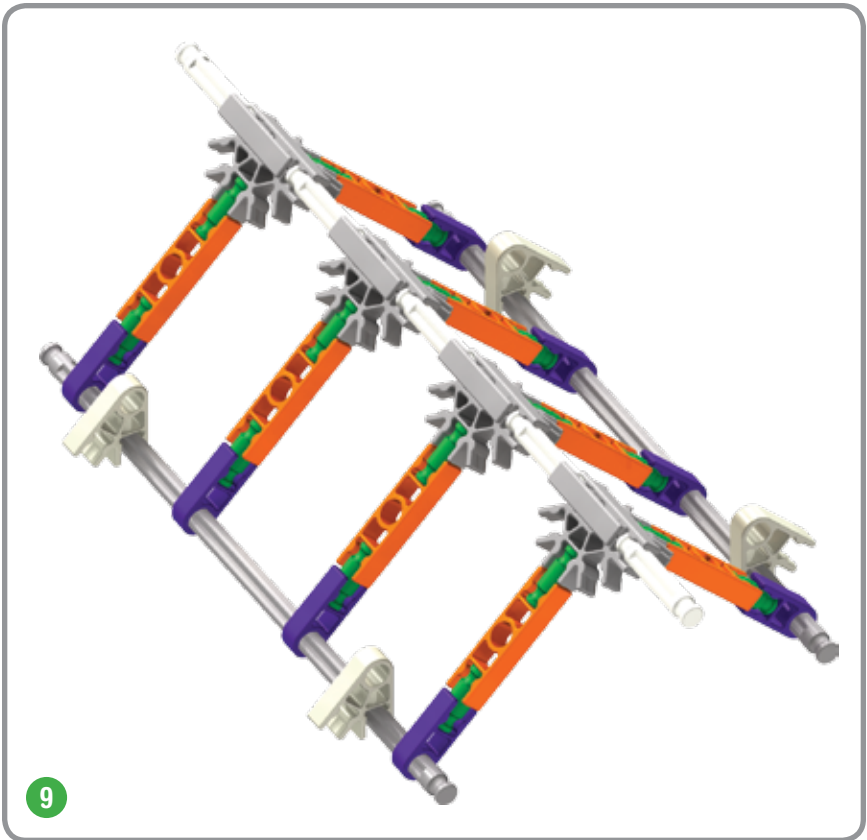
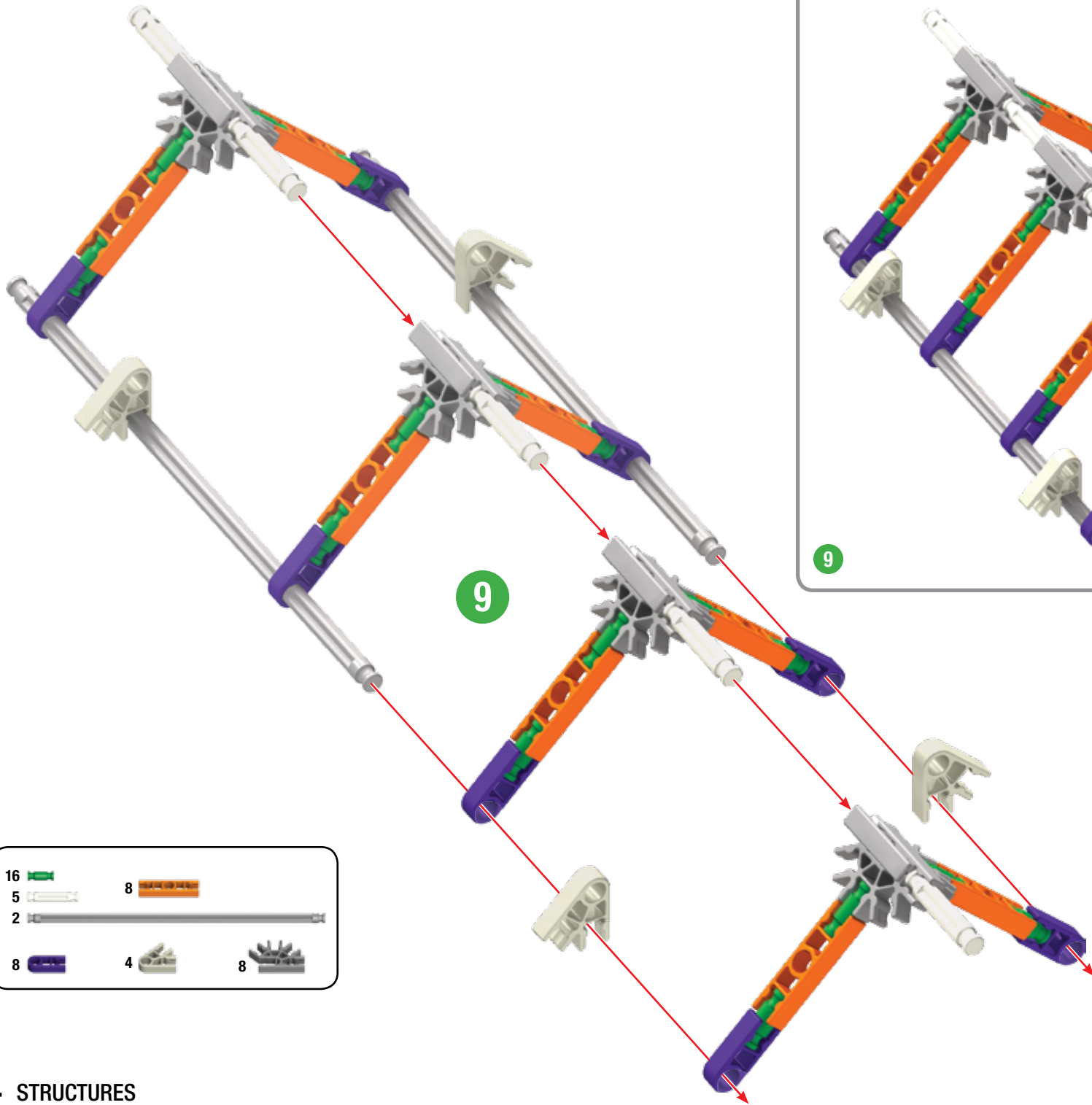

16		8	
5			
2			
8		4	
		8	

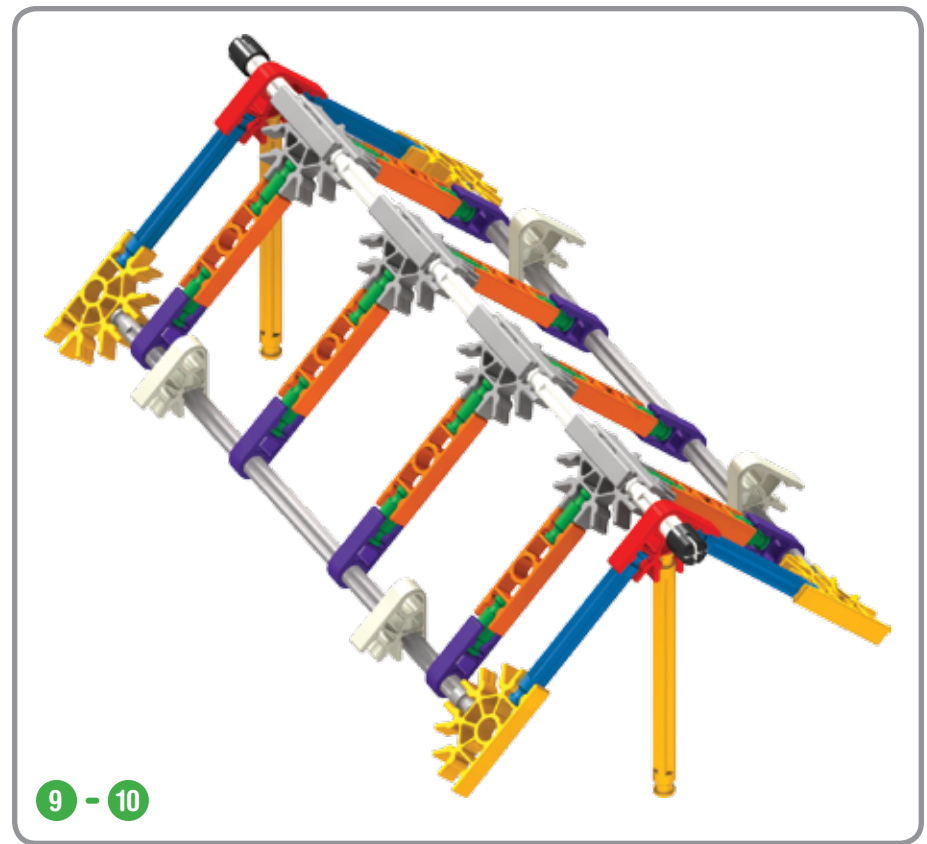
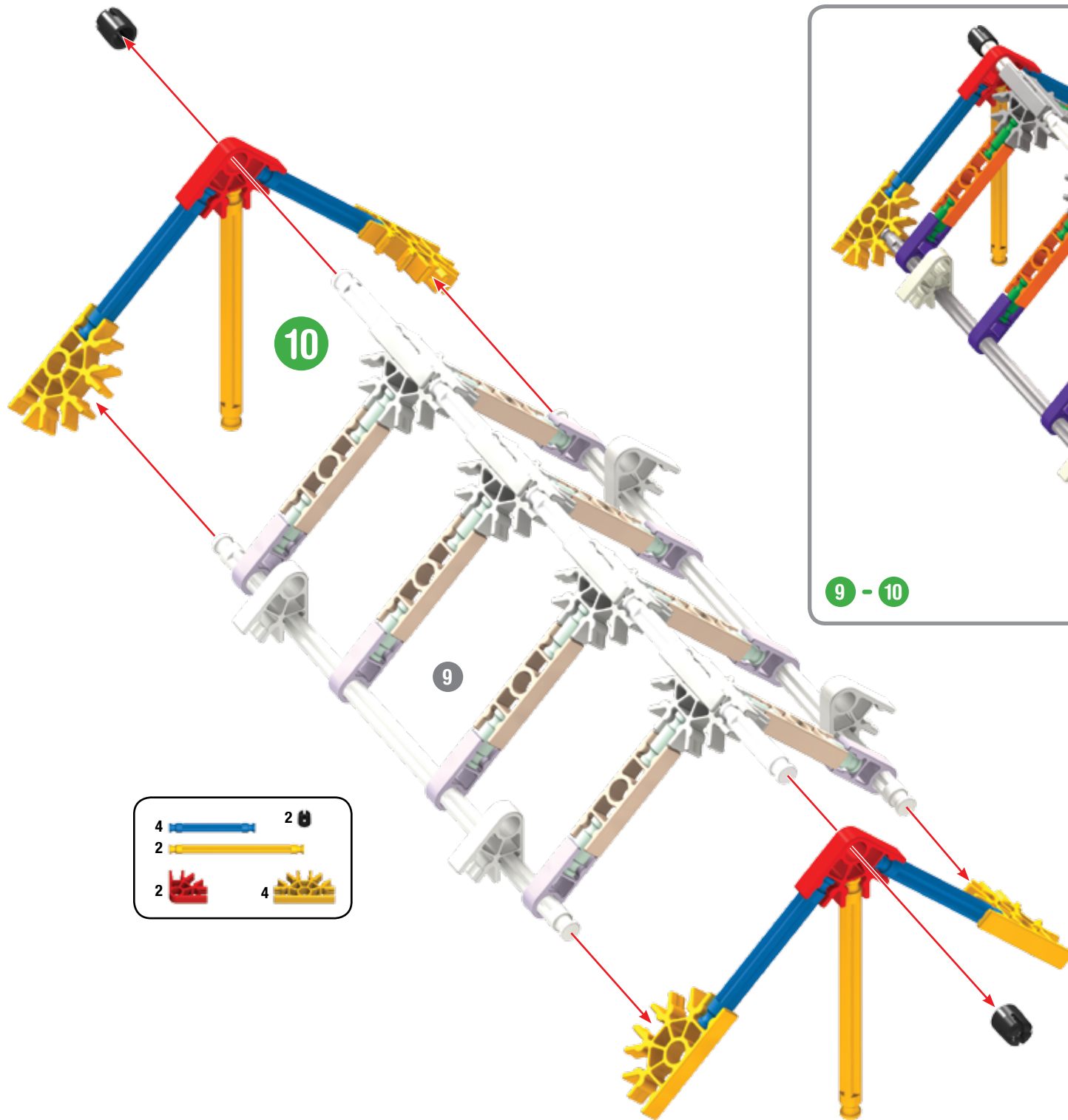

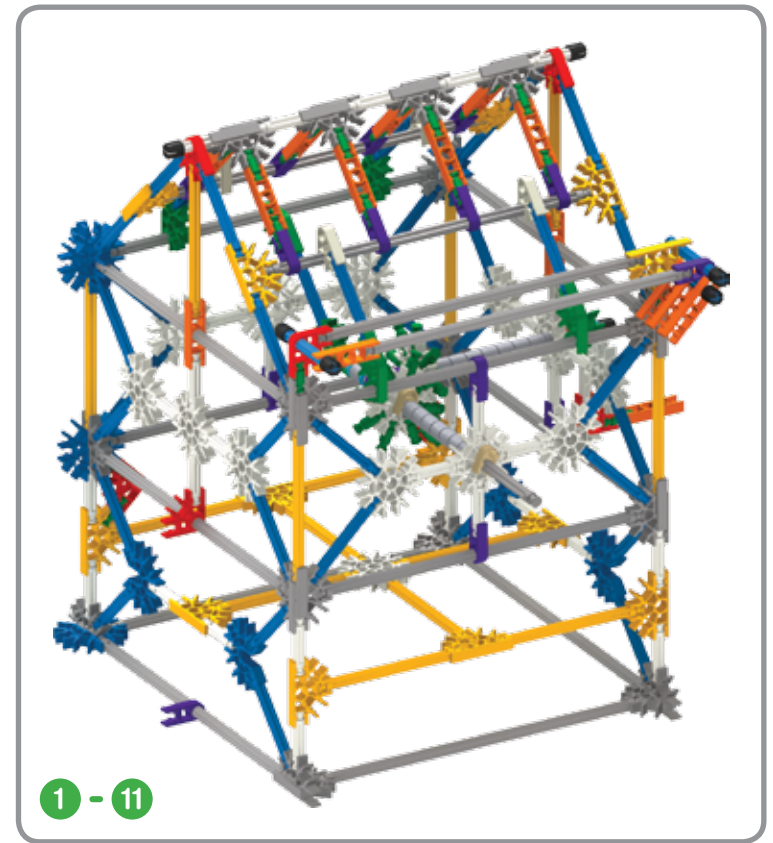
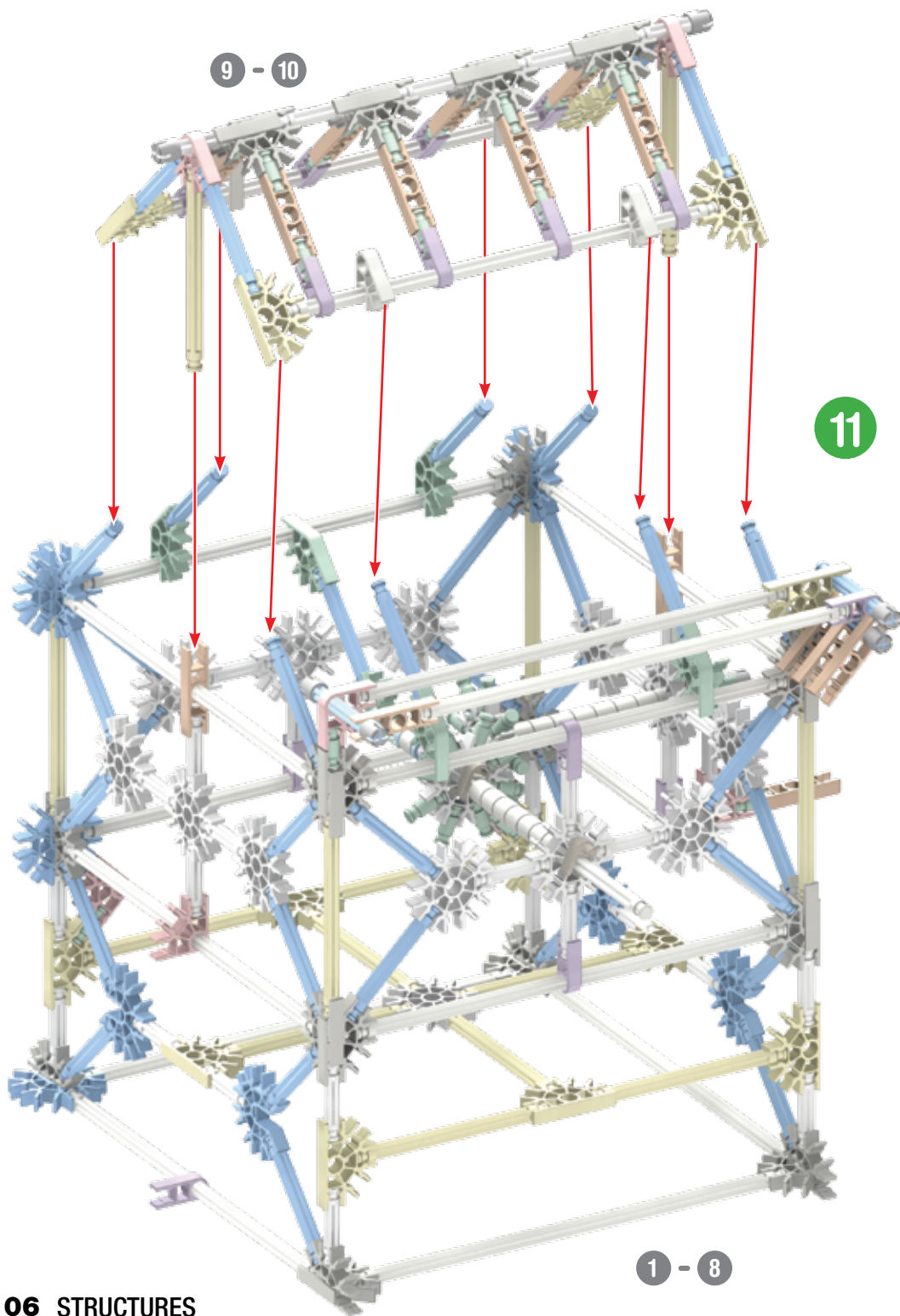



12

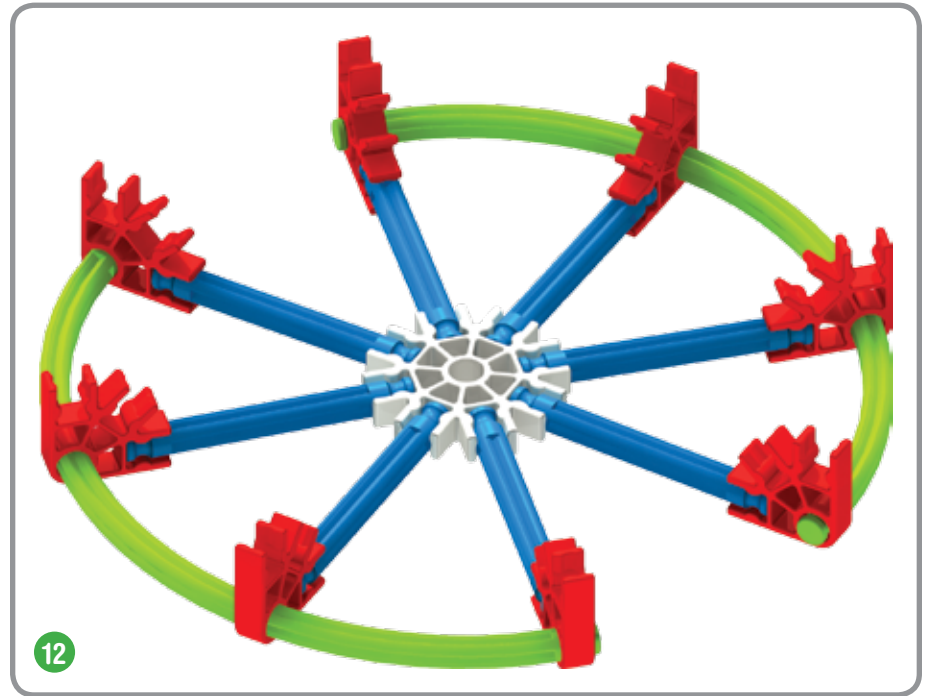
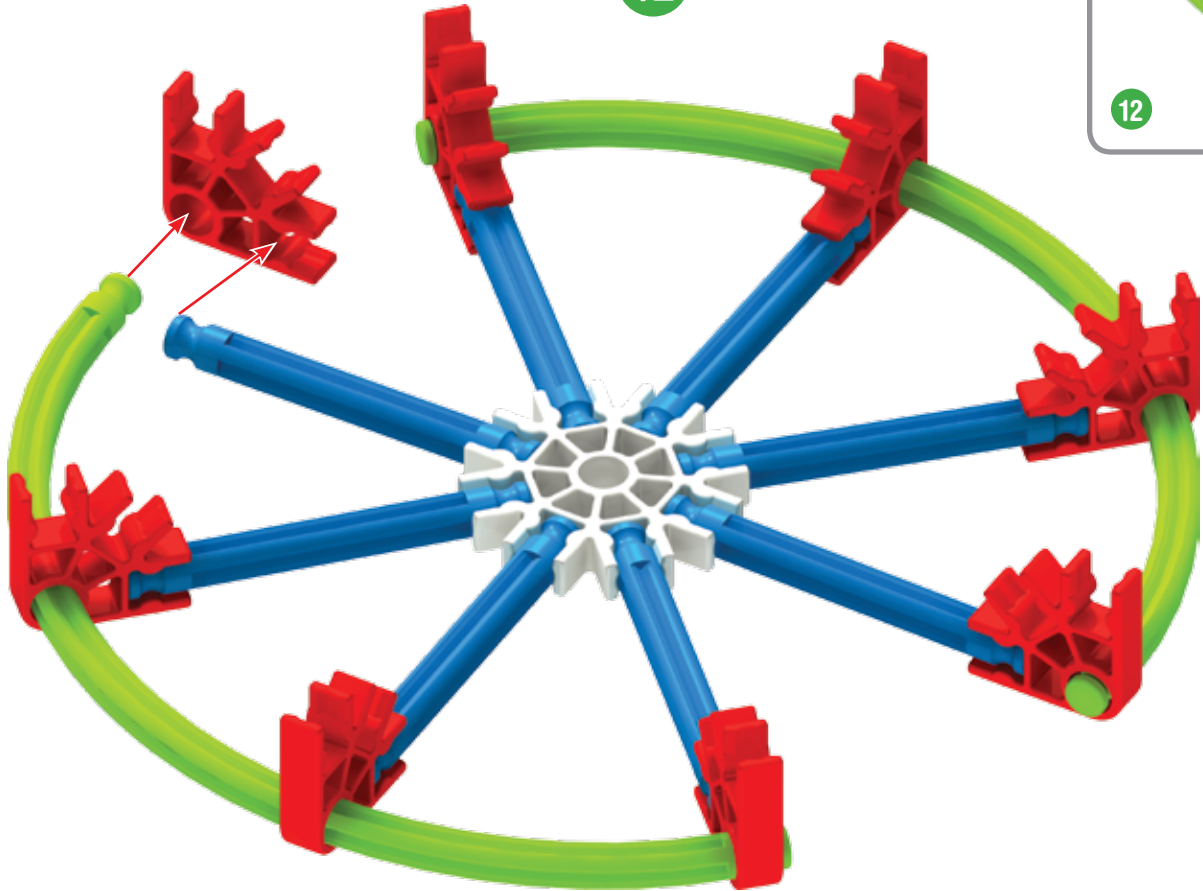

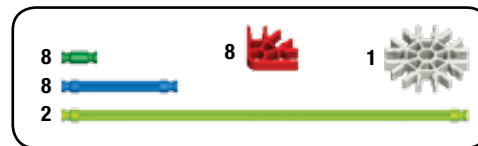
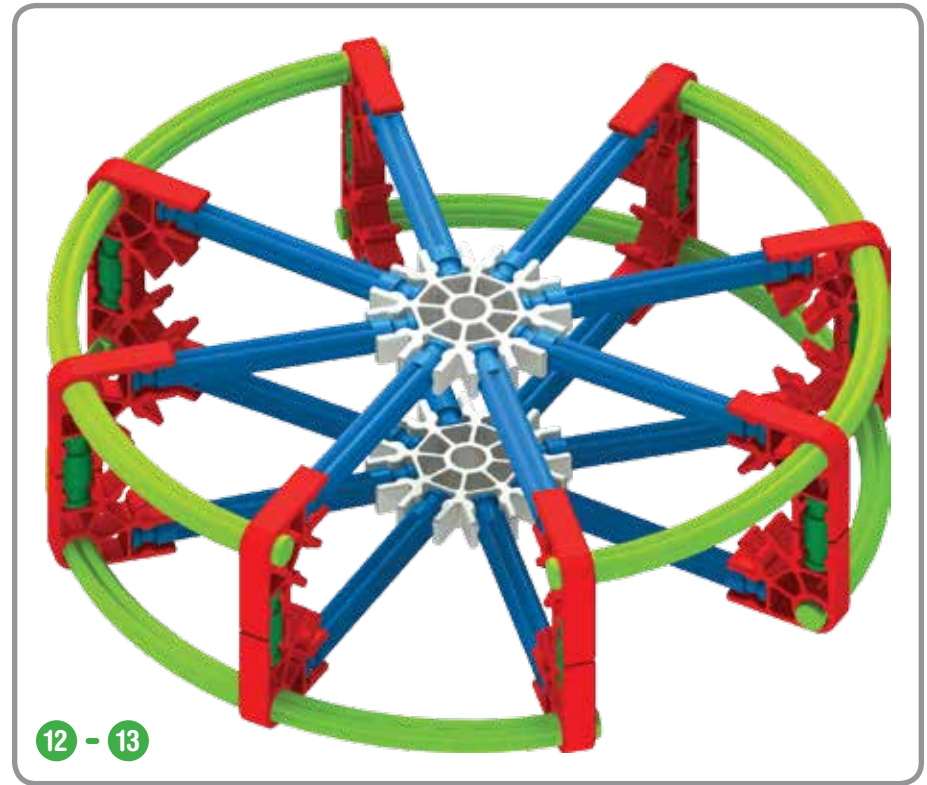
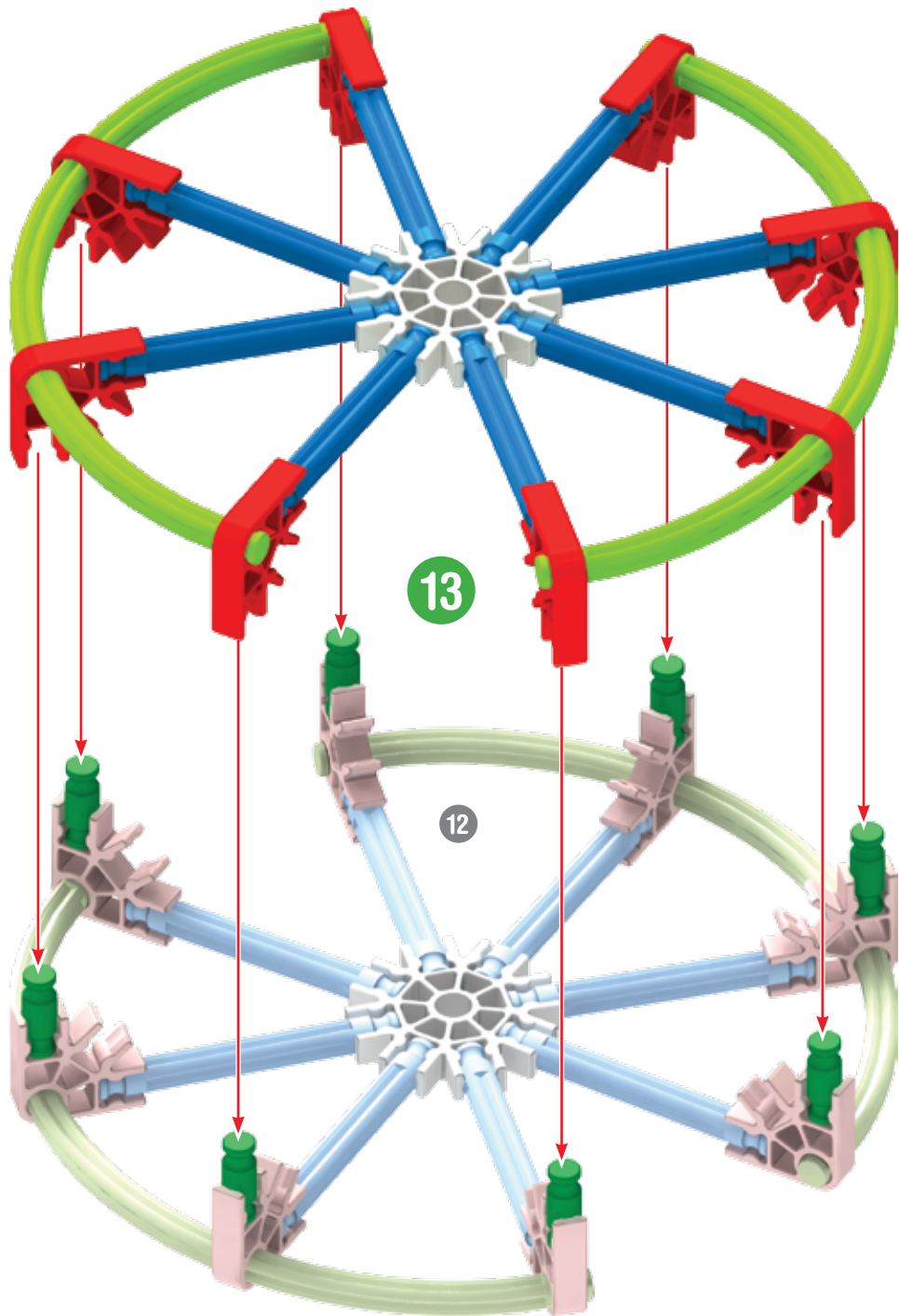

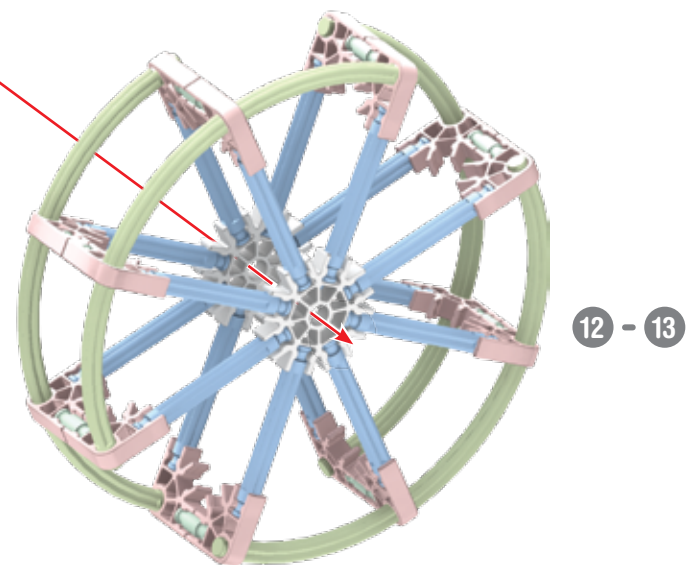
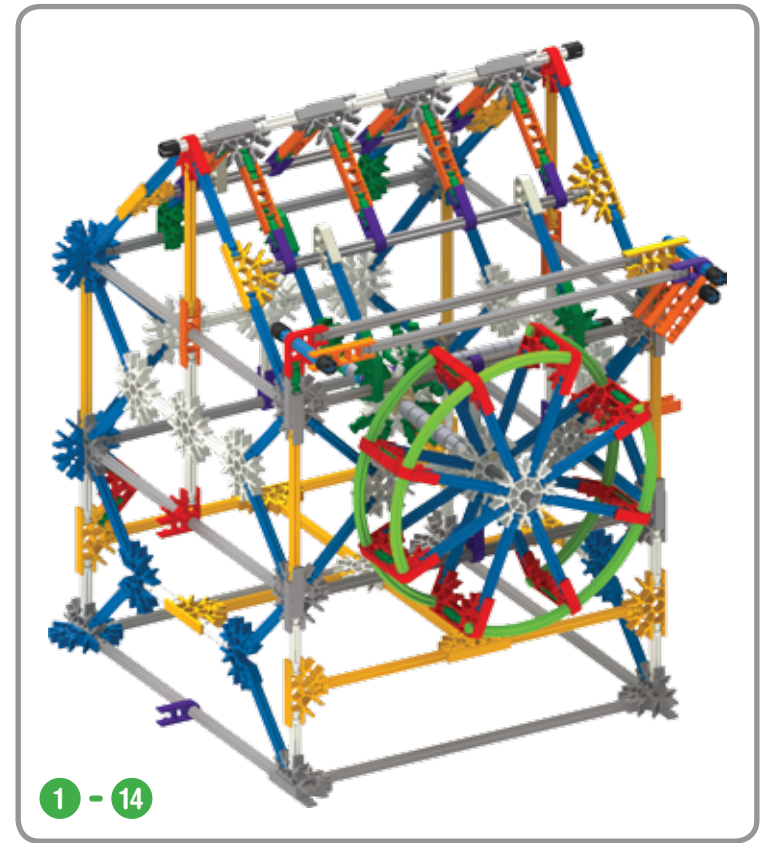
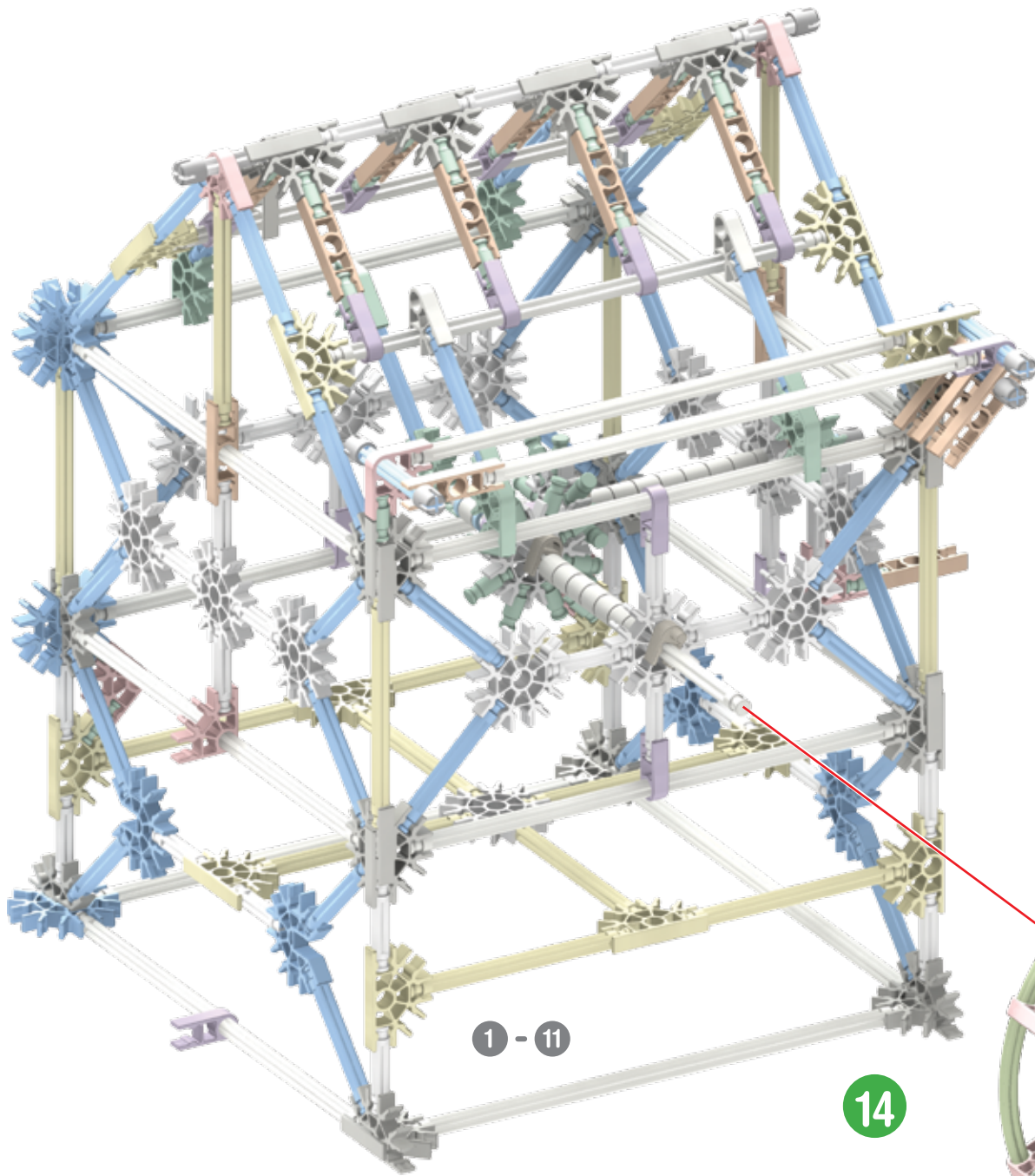

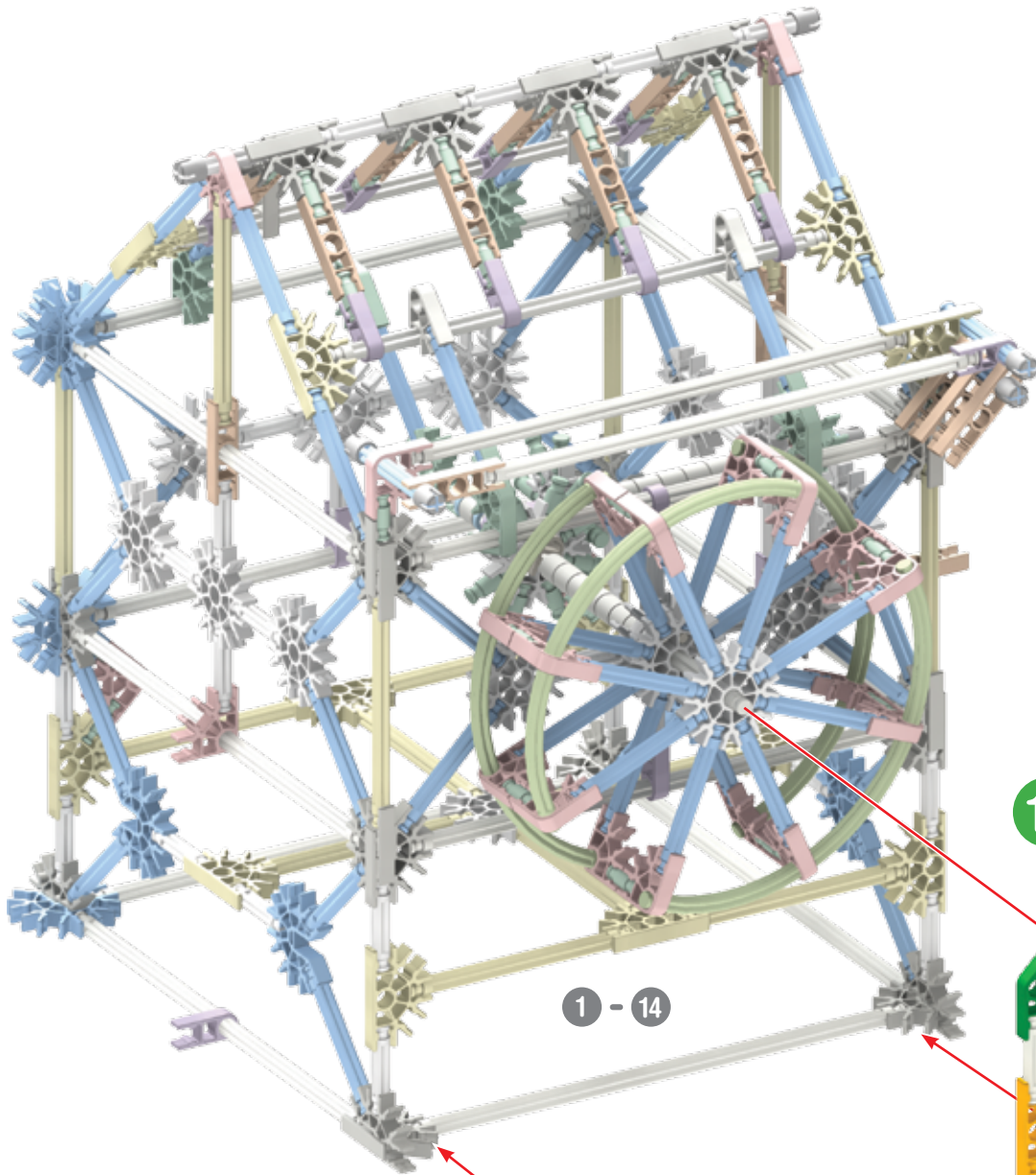

1 - 14

15

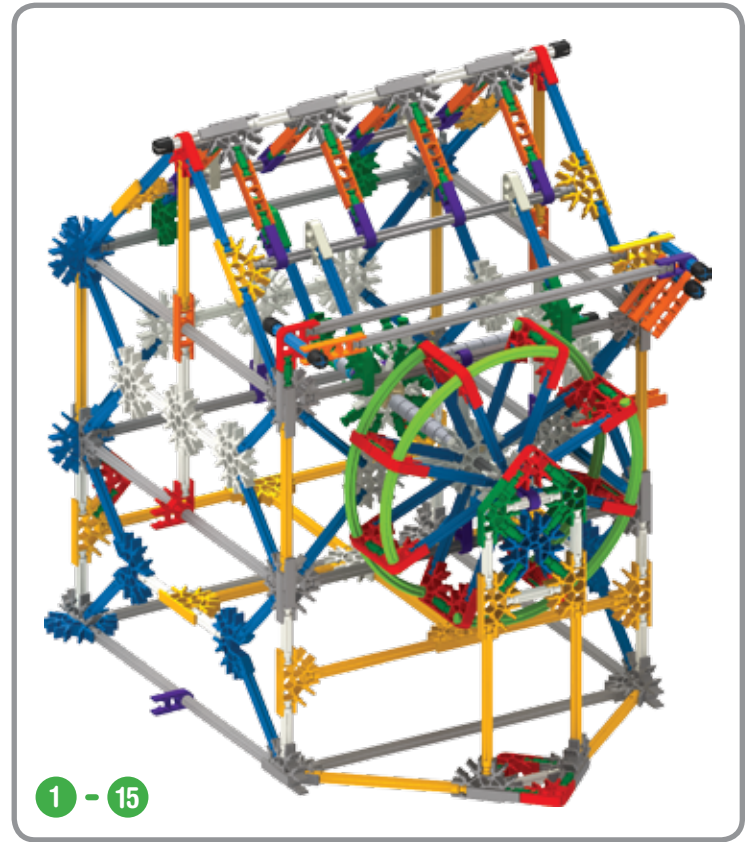

1 - 15

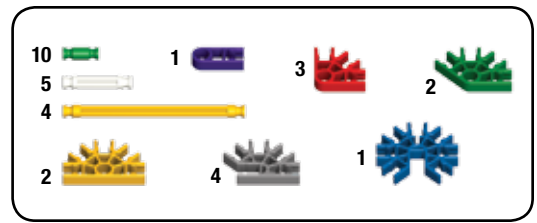

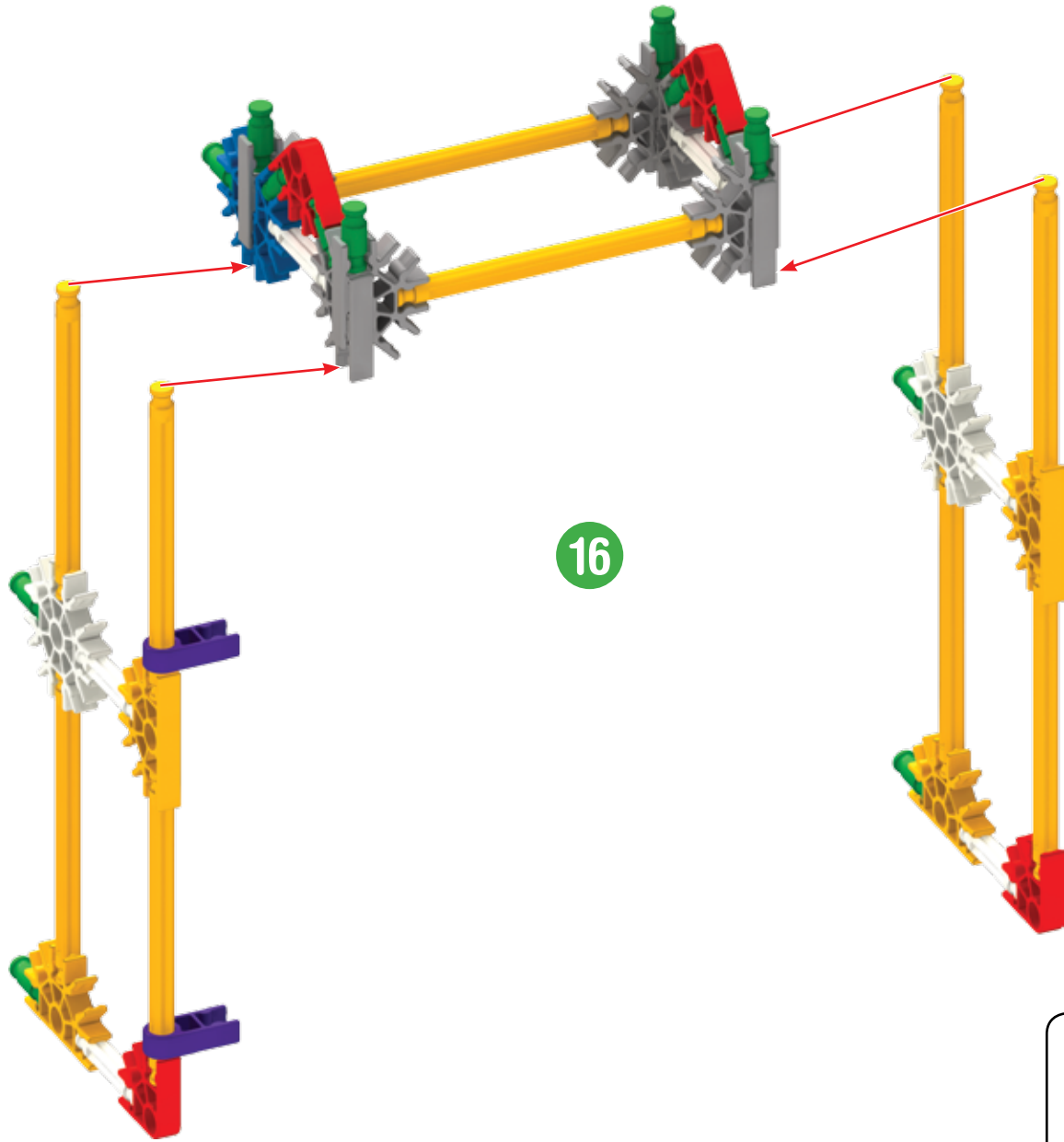

16

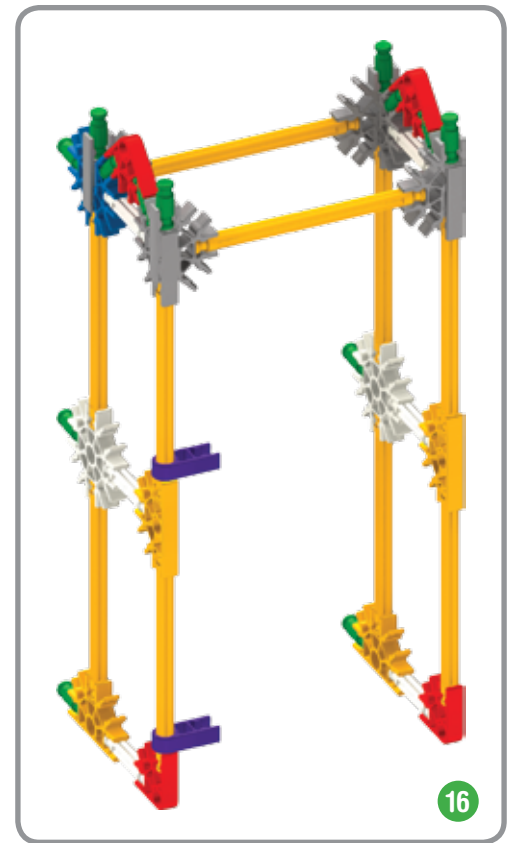

16

- | | | | | | | | |
|----|--|---|--|---|--|---|--|
| 13 | | 2 | | 4 | | 2 | |
| 6 | | | | | | | |
| 10 | | | | | | | |
| 4 | | 7 | | 1 | | | |

16		8	
4			

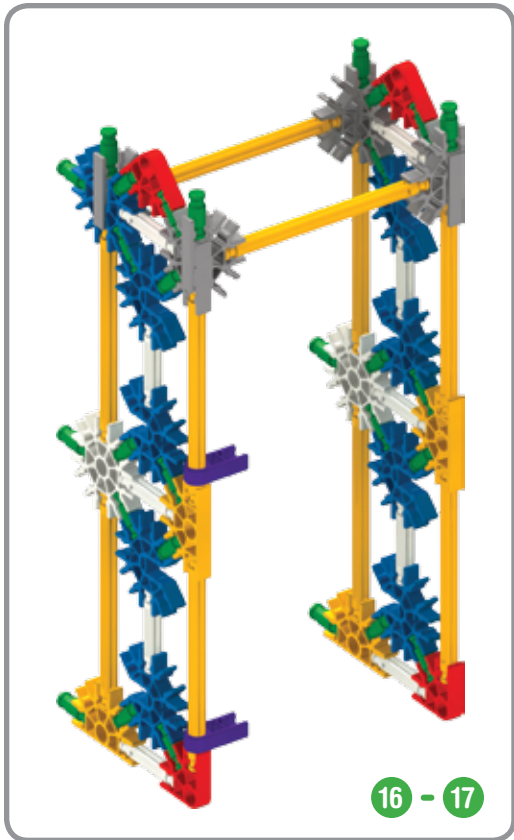
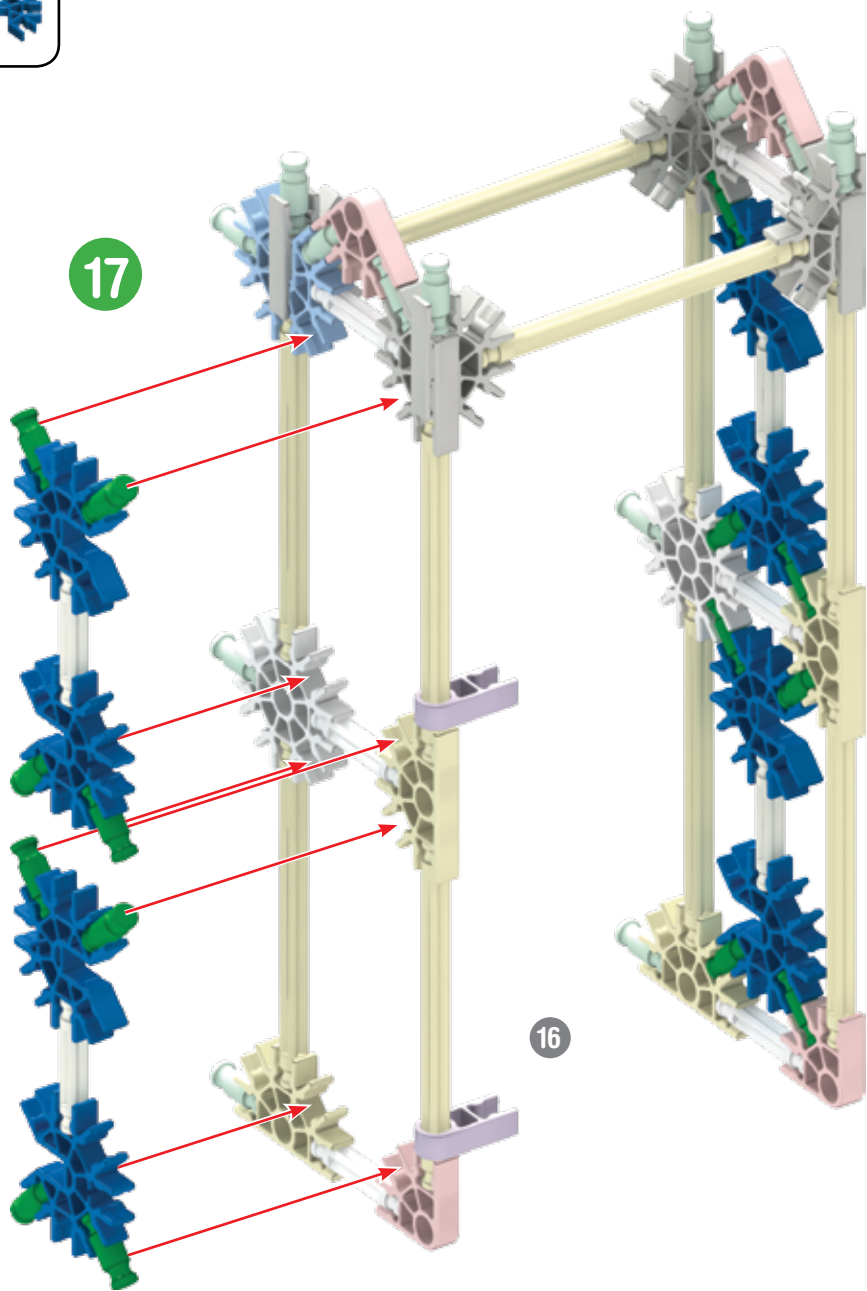

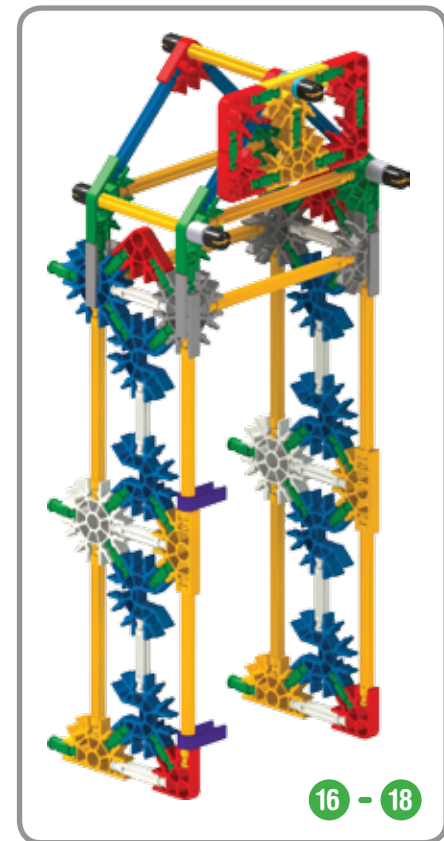
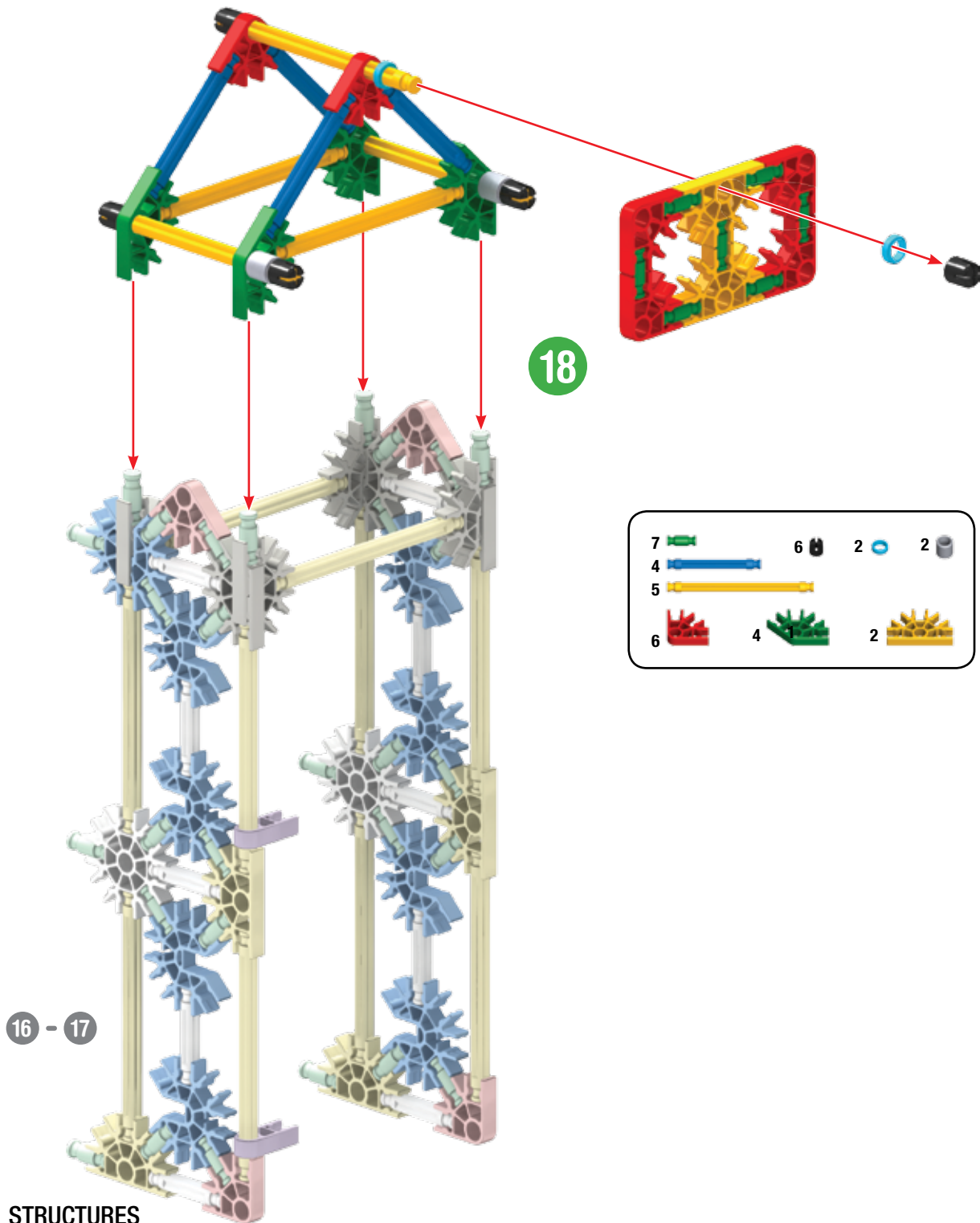

16 - 17

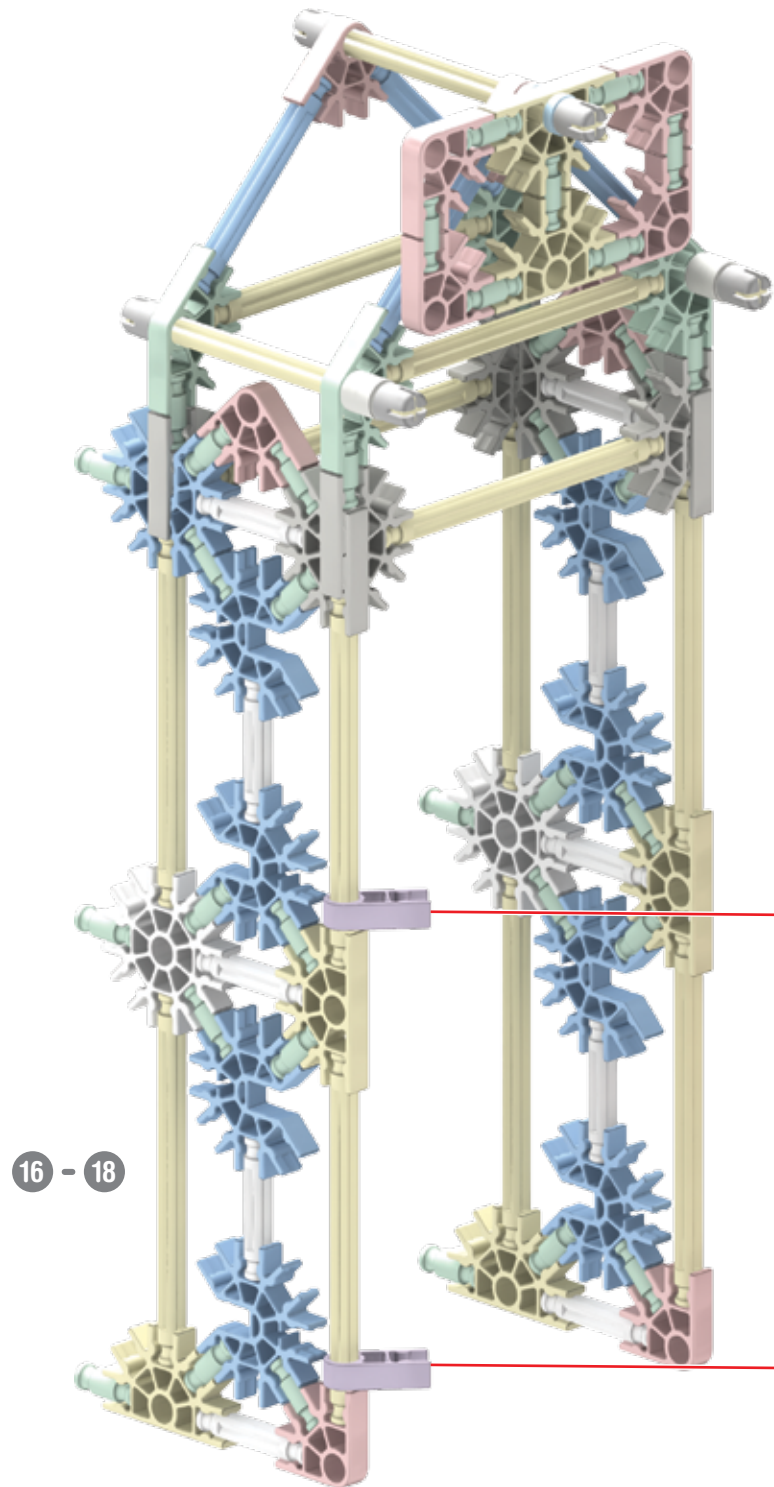

16 - 18

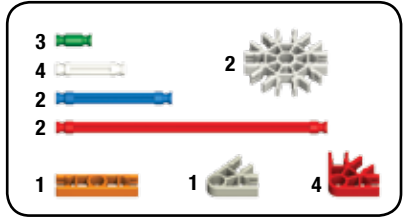

19

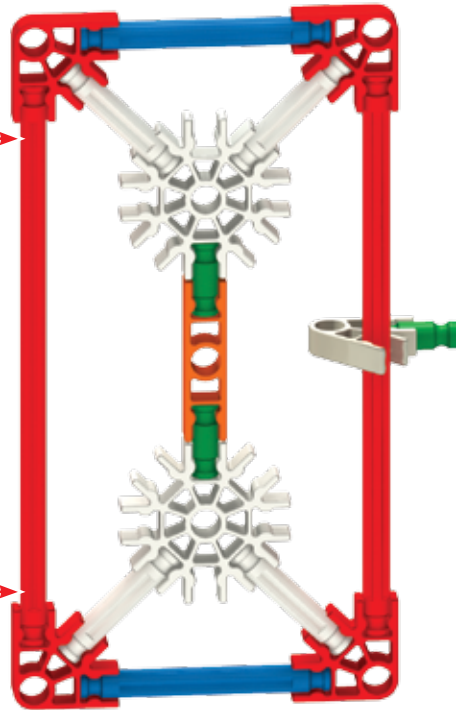

16 - 19

Watermill

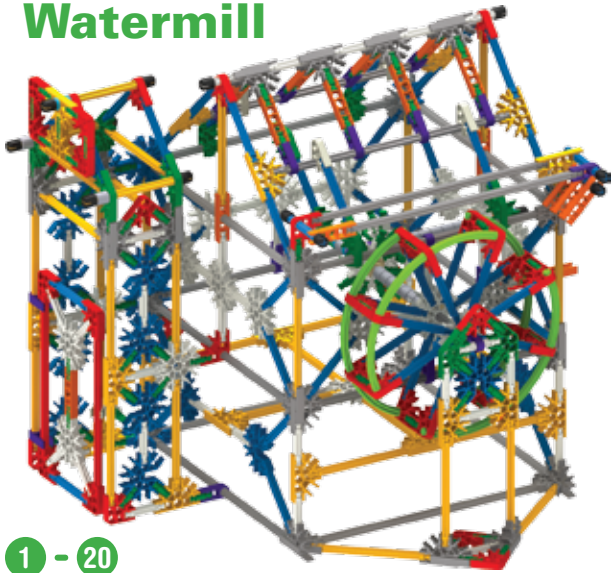

1 - 20

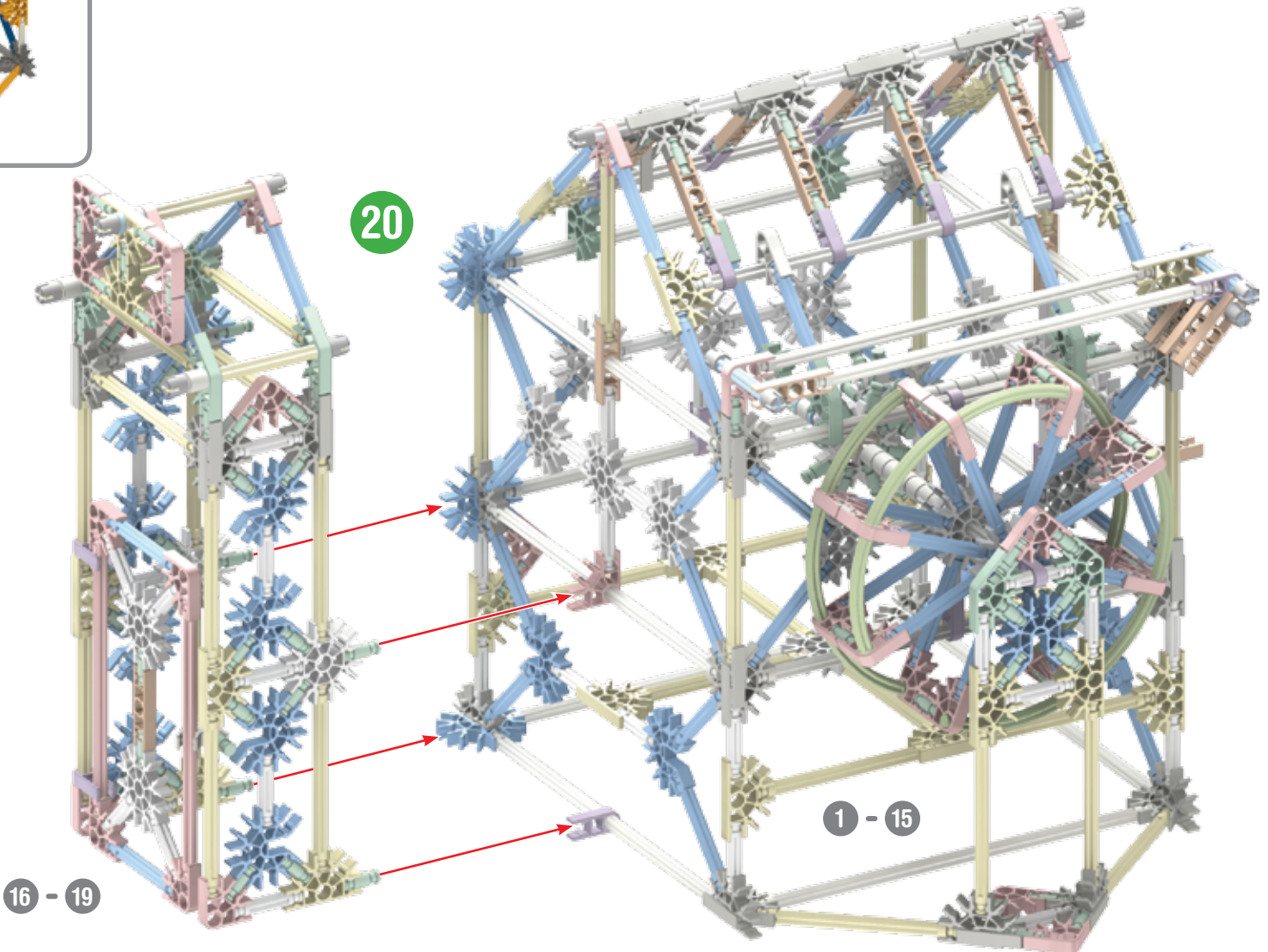

20

1 - 15

16 - 19