

# K'NEX®

Building Worlds Kids Love®

**ULTIMATE  
100 MODEL  
BUILDING SET**  
**ULTIME 100  
MODELE**  
**JEU DE CONSTRUCTION**

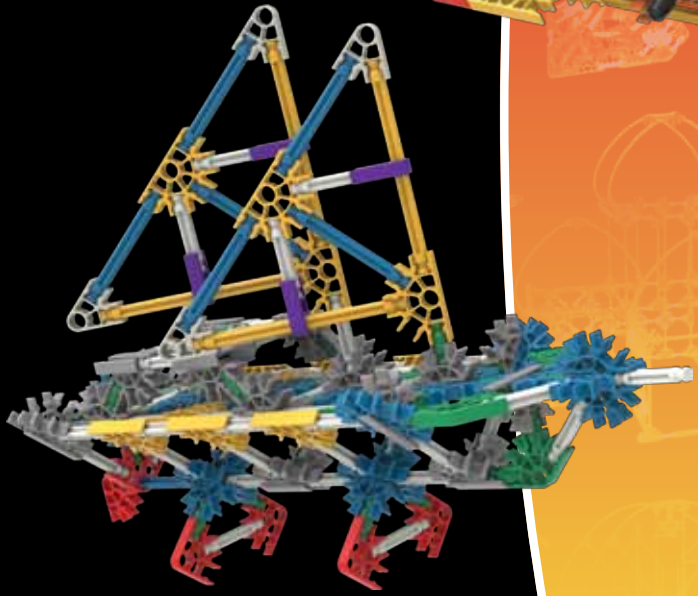

**100**  
**BUILDING IDEAS!**  
**IDÉES DE CONSTRUCTION!\***

**6+**

16457

(EN) **CONTENTS**

Bus ..... 4  
 Tic-Tac-Toe..... 4  
 Fishing Rod ..... 5  
 Skateboarder ..... 6  
 Motorcycle ..... 8  
 Dinghy ..... 10  
 Brachiosaurus ..... 13  
 Excavator..... 16  
 Space Shuttle..... 19  
 Eiffel Tower ..... 22  
 Flying Saucer ..... 26  
 Pod Spinner..... 31  
 Ambulance ..... 36  
 Large Helicopter ..... 42  
 Blimp..... 52  
 Building Ideas ..... 60

(FR) **CONTENU**

Bus ..... 4  
 Tic-Tac-Toe..... 4  
 Canne à pêche..... 5  
 Planchiste ..... 6  
 Motocyclette ..... 8  
 Barque ..... 10  
 Brachiosaurus ..... 13  
 Excavateur..... 16  
 Navette spatiale..... 19  
 La tour Eiffel..... 22  
 Soucoupe volante..... 26  
 Radar tournant..... 31  
 Ambulance ..... 36  
 Grand hélicoptère..... 42  
 Dirigeable ..... 52  
 Idées de construction..... 60

**Parts List**

Before you start building, be sure to compare the parts in your set with the parts list here. If anything is missing, call or write to us using the information on the back cover. We are here to help you!

**Liste des Pièces**

Avant de commencer à construire, assure-toi de comparer les pièces dans ta boîte à la liste de pièces fournie ici. S'il manque quelque chose, téléphone-nous ou écris-nous en te servant des informations figurant au verso de la notice. Nous sommes là pour t'aider !

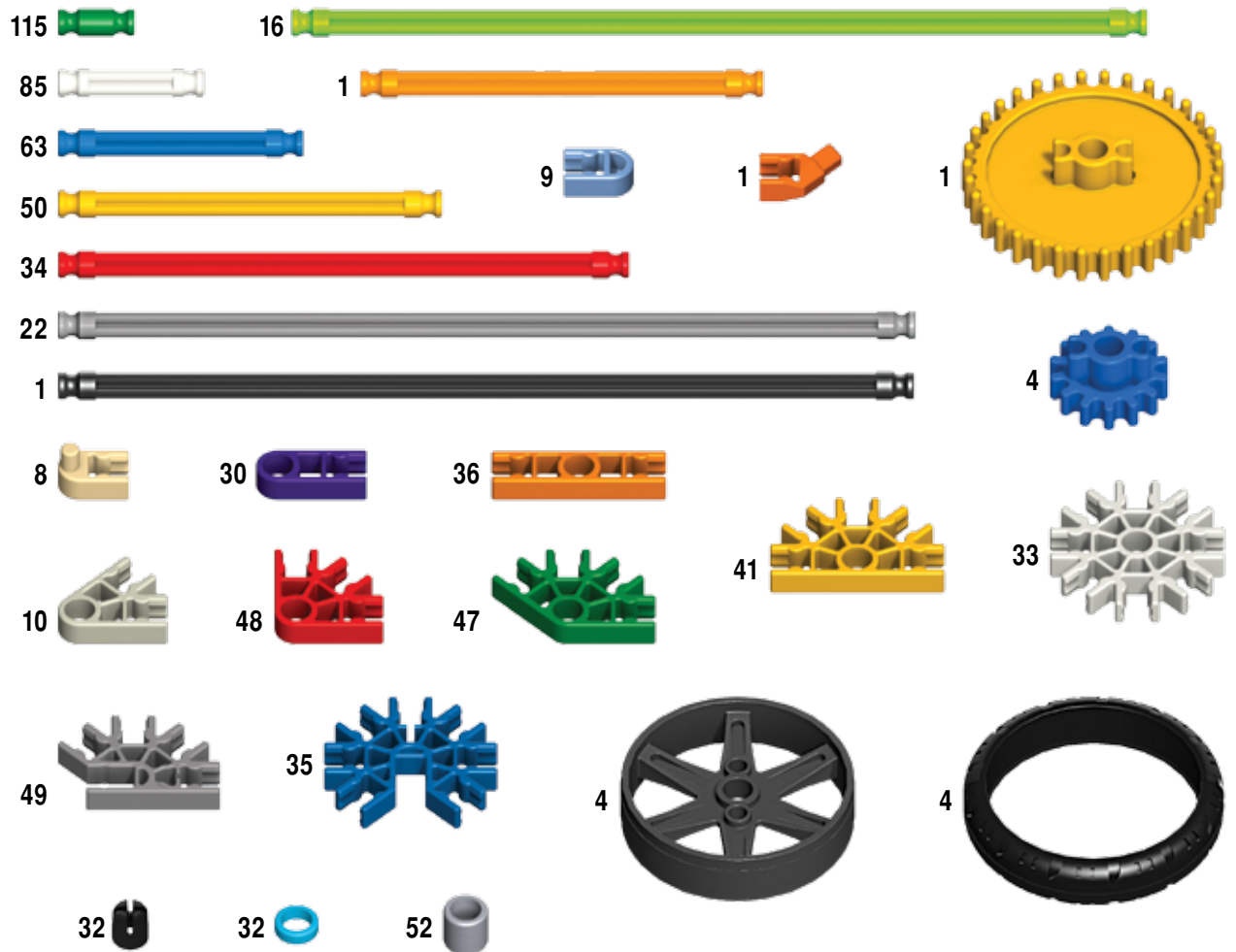



# Building Basics

## Bases de la Construction



### Start Building

To begin your model, find the **1** and follow the numbers. Each piece has its own shape and color. Just look at the pictures, find the pieces in your set that match and then connect them together. Try to face your model in the same direction as the instructions while you build. The arrows show you where the parts connect, but not all connections points have arrows. Faded colors show you this section is already built.

### Démarre ta Construction

Pour commencer ton modèle, trouve l'étape numéro **1** et suis les numéros. Chaque pièce a sa propre forme et sa propre couleur. Regarde les illustrations, trouve les pièces qui correspondent à ce que tu vois et assemble-les. Pour t'aider pendant que tu construis, oriente ton modèle dans le même sens que les instructions. Les flèches t'indiquent où les pièces s'assemblent, mais les points de raccordement n'ont pas tous des flèches. Les pièces de couleur délavée sont celles que tu as déjà assemblées.

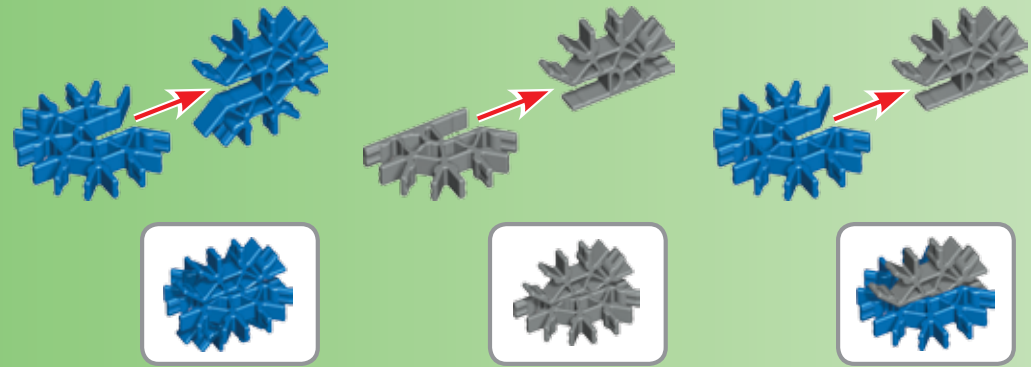

### Connectors

You can slide these special connectors together. Push tightly until you hear a "click". Pay close attention to the instructions and position them horizontally or vertically exactly as they are shown.

### Connecteurs

Vous pouvez assembler ces connecteurs tout à fait uniques en les faisant glisser l'un dans l'autre. Pousser fort jusqu'au « clic ». Lire les instructions attentivement et les positionner horizontalement ou verticalement, en suivant exactement les illustrations.

### Spacers

There are places in your model where you need to use spacers. Be sure to use the correct color and number of spacers shown in the instructions.

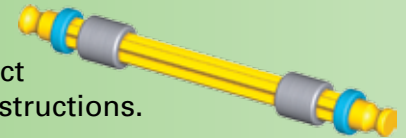

### Séparateurs

Il y a des endroits sur le modèle où des séparateurs sont nécessaires. S'assurer d'utiliser la bonne couleur et le nombre d'espaceurs indiqué sur les instructions.

### Flexible Rods

You can bend a flexible rod to make curved shapes. It will be easier to attach to your model if you bend it back and forth a few times first.



### Tiges Flexibles

Un tiges flexibles est une tige que tu peux courber pour faire des courbes. Elle pourra être attachée plus aisément à ton modèle si tu la plies en avant et en arrière plusieurs fois.

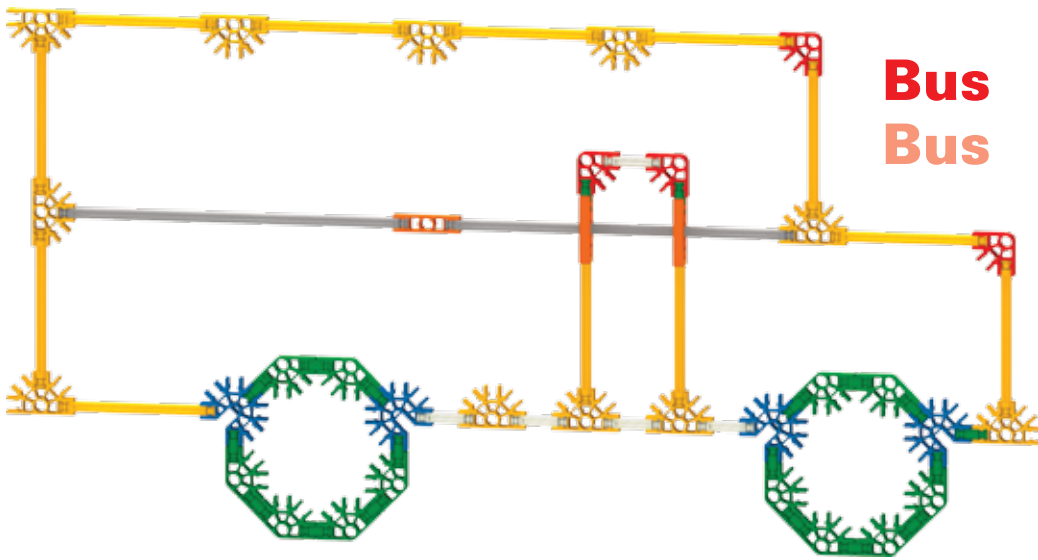

**Bus**  
**Bus**



## Tic-Tac-Toe Tic-Tac-Toe

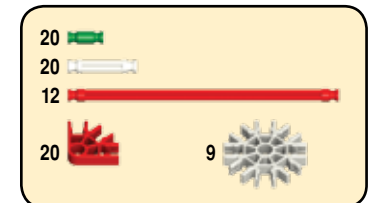
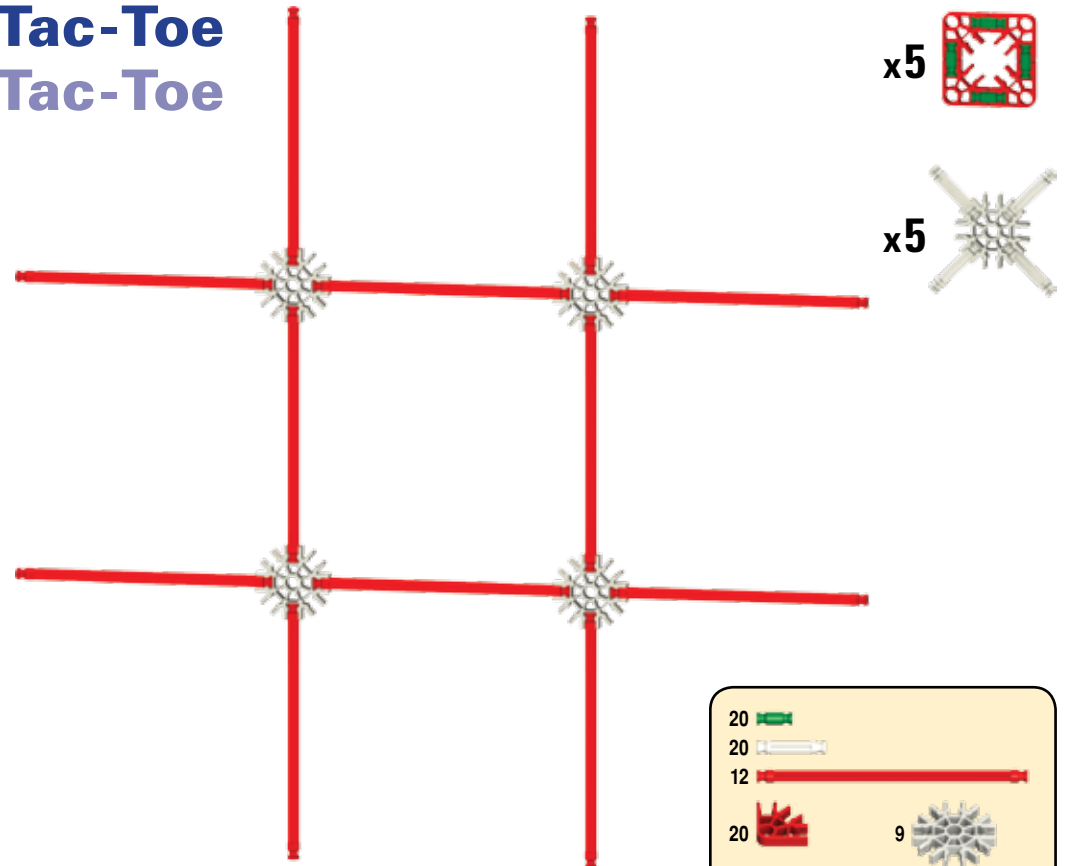

**!** (EN) **WARNING: CHOKING HAZARD** - Small parts. Not for children under 3 years.

(FR) **ATTENTION** : RISQUE D'ÉTOUFFEMENT - Pièces de petite taille. Ne convient pas aux enfants de moins de 3 ans.

(ES) **ADVERTENCIA**: PELIGRO DE ASFIXIA - Piezas pequeñas. No para niños menores de 3 años.

(DE) **ACHTUNG**: ERSTICKUNGSGEFAHR - Kleinteile. Nicht geeignet für Kinder unter 3 Jahren.

(IT) **AVVISO**: PERICOLO DI SOFFOCARE - Pezzi piccoli parti. Non adatto per bambini sotto di 3 anni.

(PT) **AVISO**: PERIGO DE SUFOCAÇÃO - Peças pequenas. Não se destina a crianças com menos de 3 anos de idade.

(NL) **WAARSCHUWING**: VERSTIKKINGSGEVAAR - Kleine onderdelen. Niet geschikt voor kinderen jonger dan 3 jaar.

# Fishing Rod Canne à pêche



**1**

**2**

**1 - 2**

14	2	1	3
6			
1		1	
1	2	1	

**1 - 2**









**3**

2	5	1
2		

**1 - 3**

# Skateboarder Planchiste



- 4 
- 14 
- 10 
- 2 
- 4 
- 4 
- 3 
- 1 
- 2 

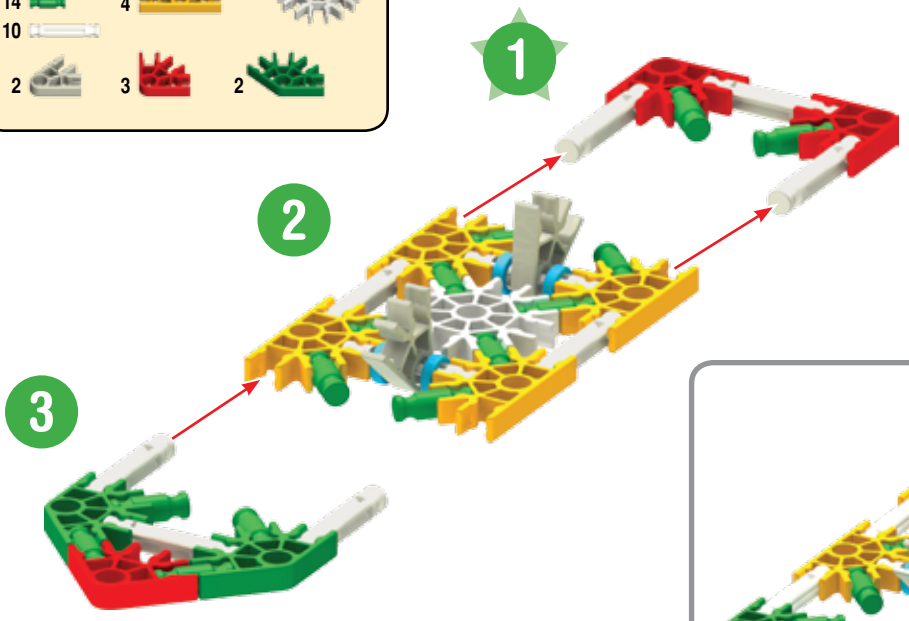



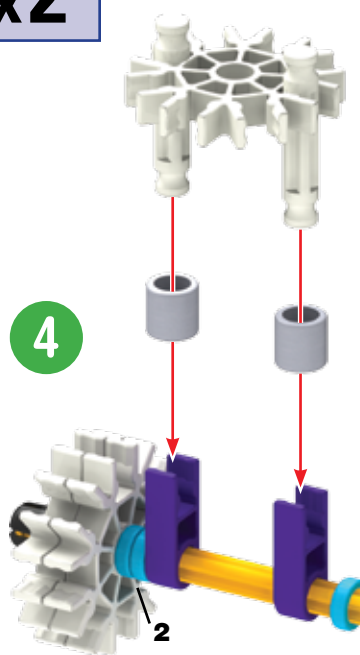

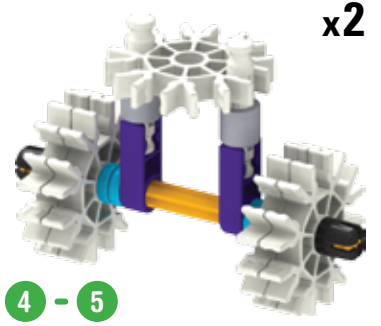

x2



4 - 5



x2

- 4 
- 4 
- 2 
- 4 
- 8 
- 4 
- 10 

5

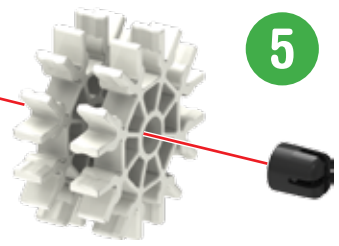

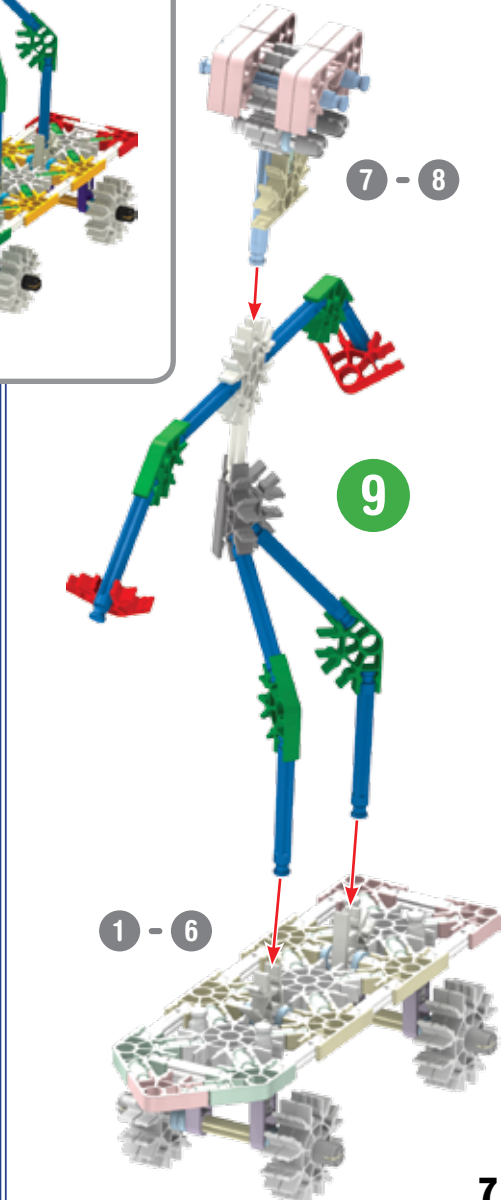
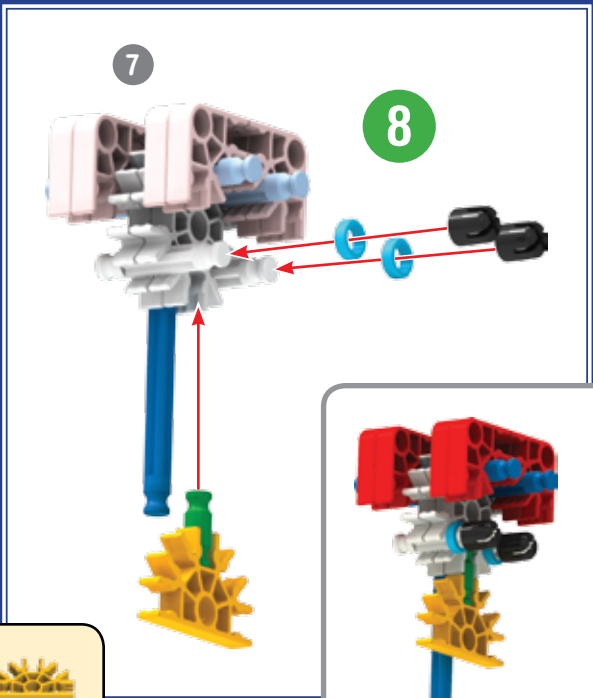
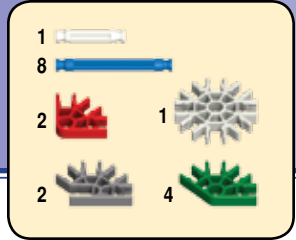
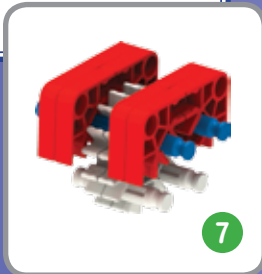
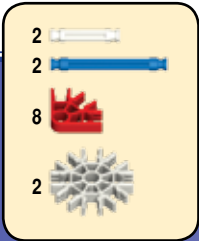
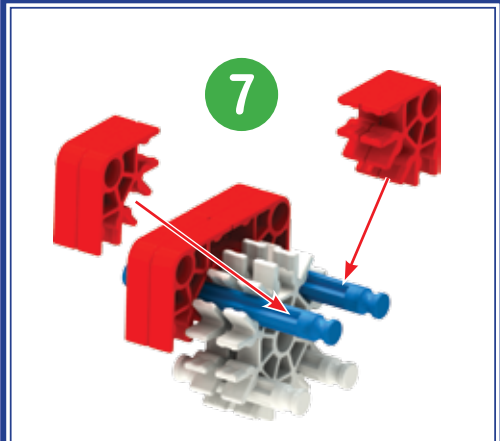
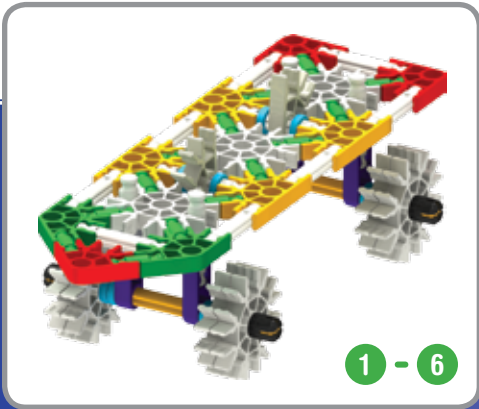
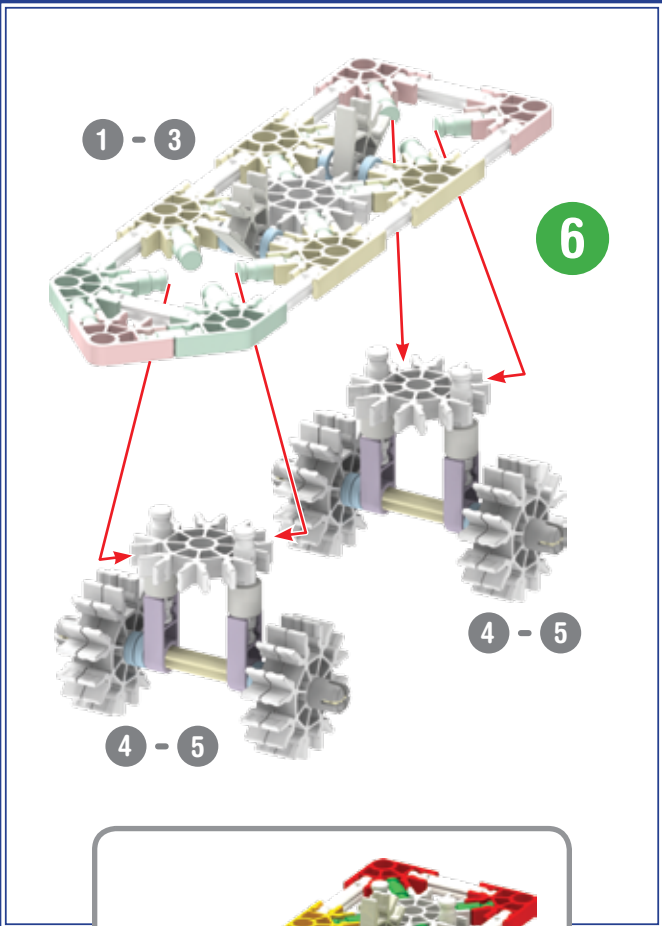

# Motorcycle Motocyclette

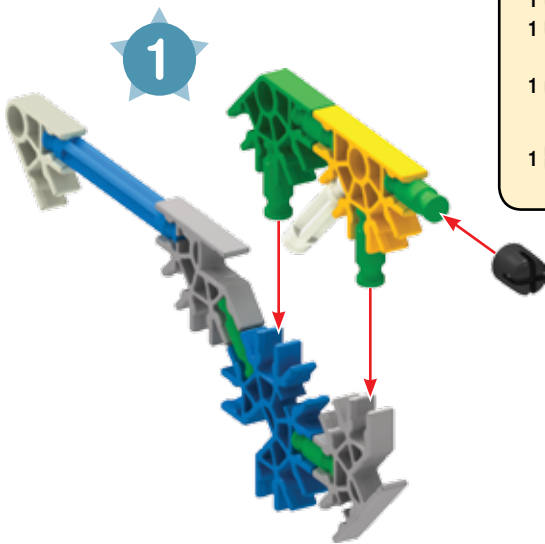
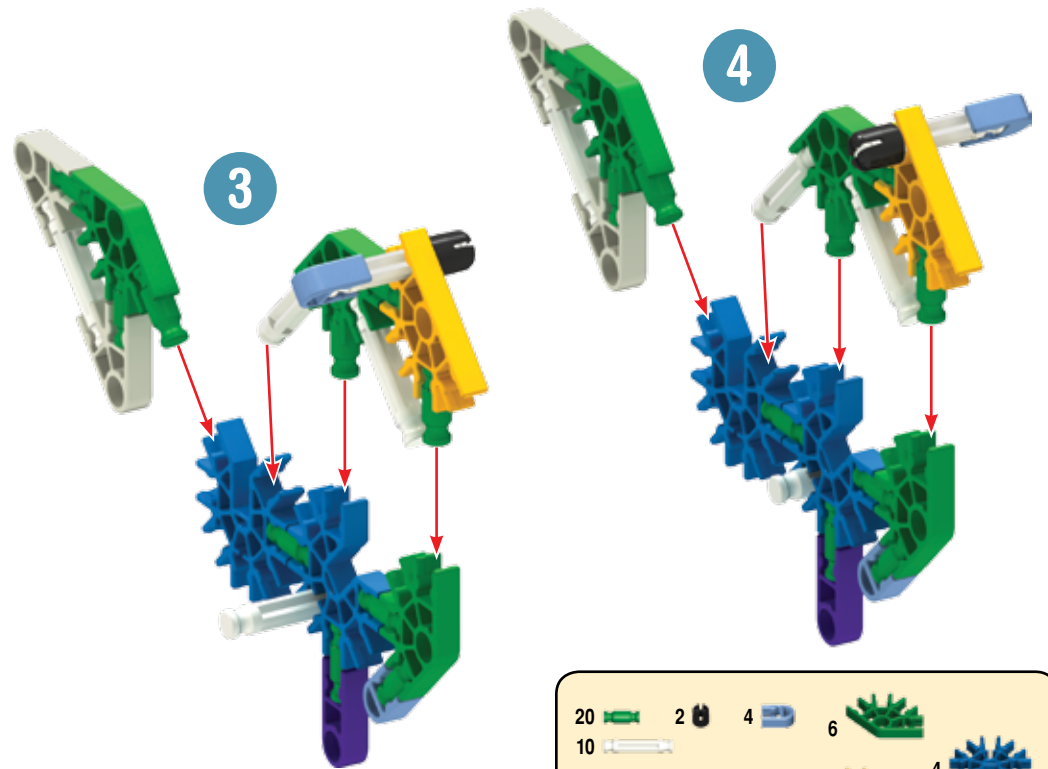

- |   |   |   |   |
|---|---|---|---|
| 6 | 1 | 1 | 1 |
| 1 | 1 | 1 | 1 |
| 1 | 1 | 1 | 1 |
| 1 | 1 | 1 | 1 |
| 1 | 1 | 1 | 1 |

- |    |   |   |   |   |
|----|---|---|---|---|
| 20 | 2 | 4 | 6 | 4 |
| 10 | 1 | 1 | 1 | 1 |
| 2  | 4 | 2 | 2 | 4 |

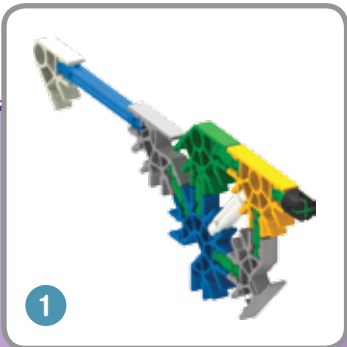
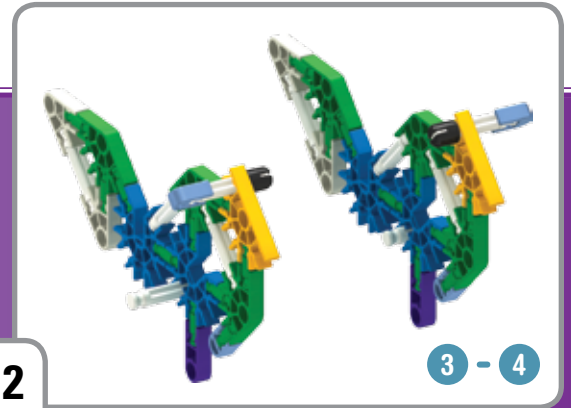
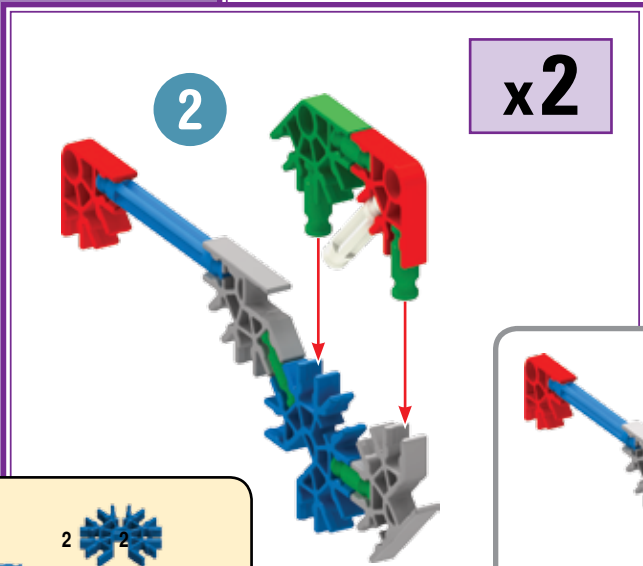

- |    |   |   |   |
|----|---|---|---|
| 10 | 2 | 2 | 2 |
| 2  | 2 | 2 | 2 |
| 2  | 2 | 2 | 2 |
| 4  | 2 | 4 | 4 |

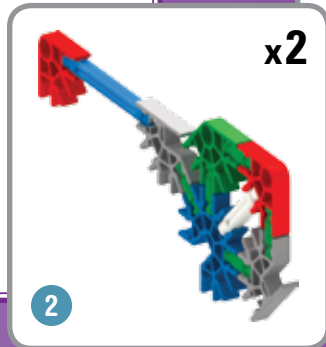

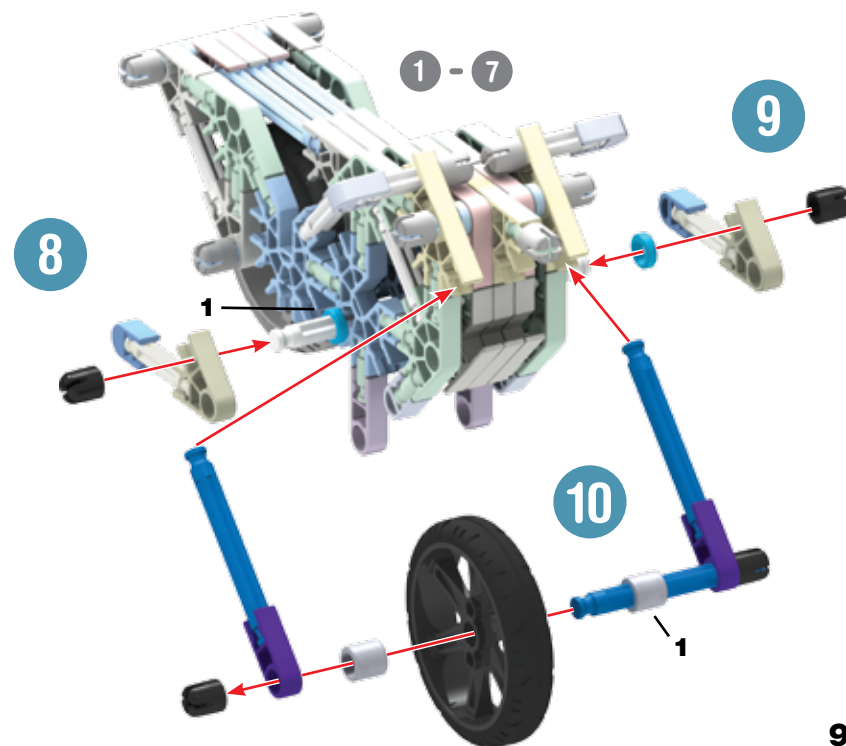
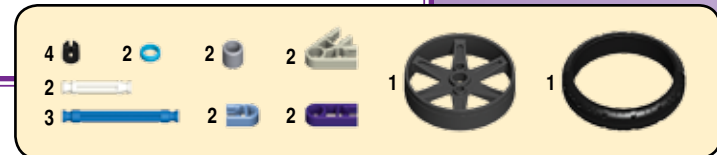
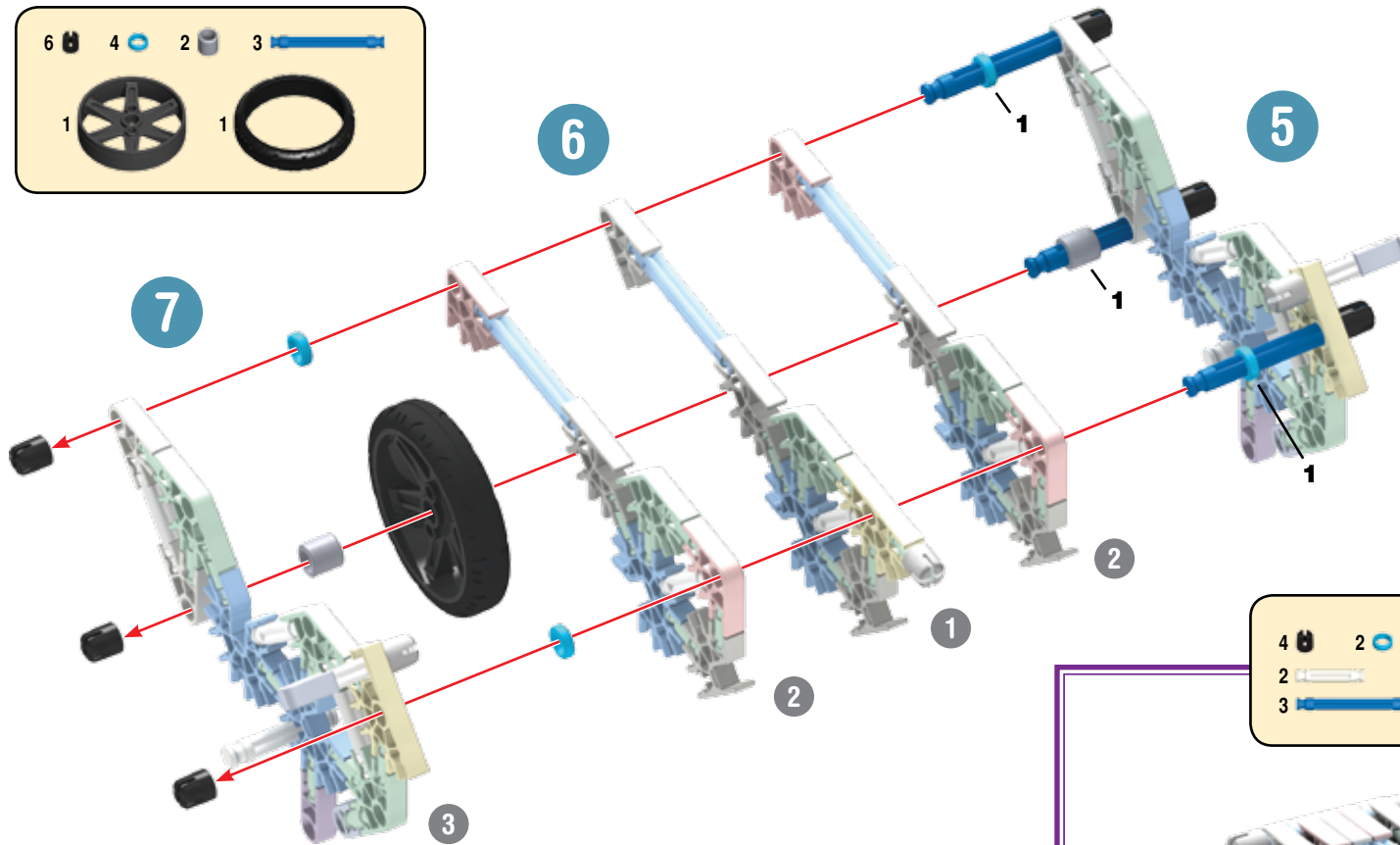
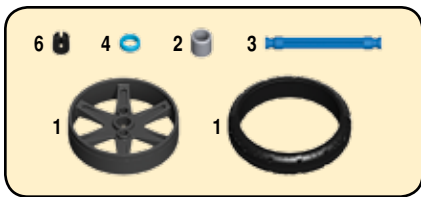

# Dinghy Barque

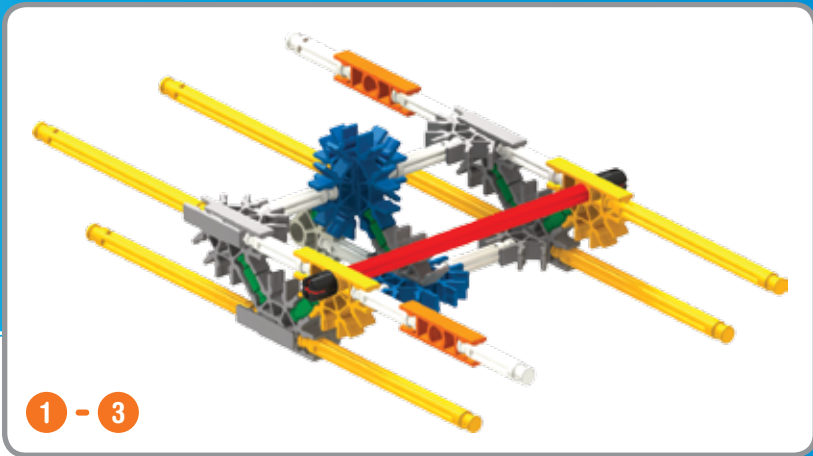

- 6
- 11
- 7
- 1
- 1
- 2
- 2
- 2
- 3
- 1
- 2
- 9

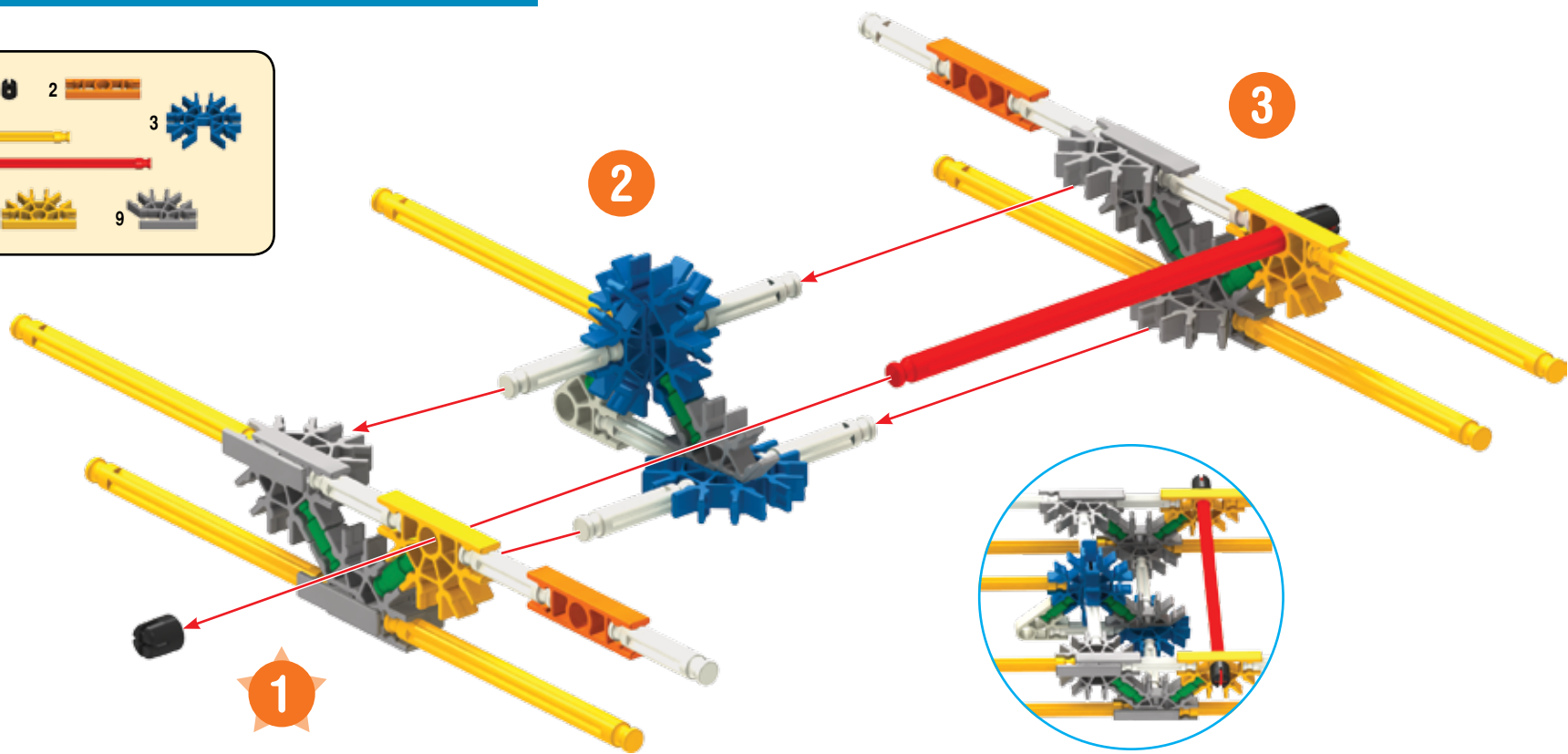

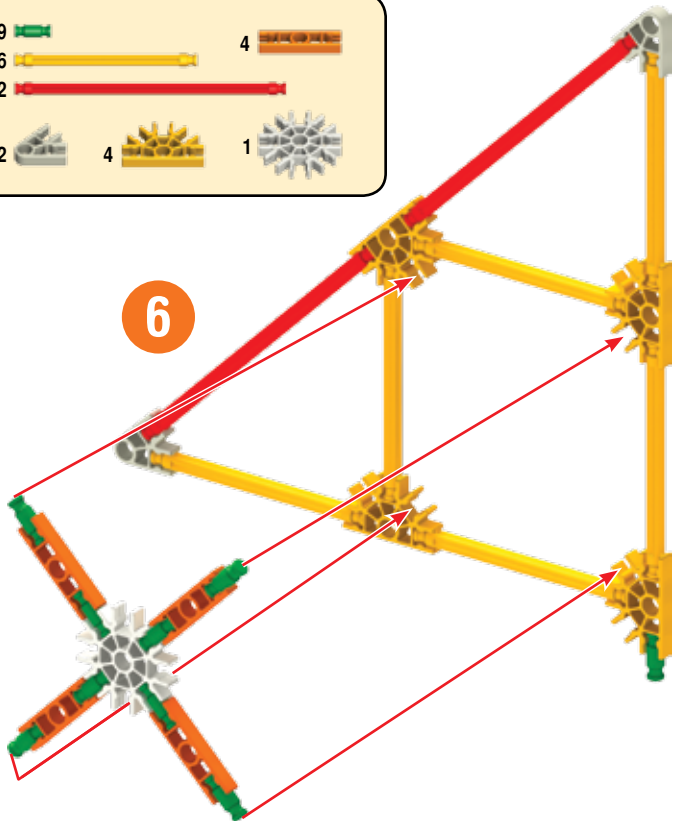
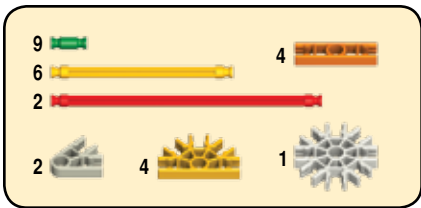
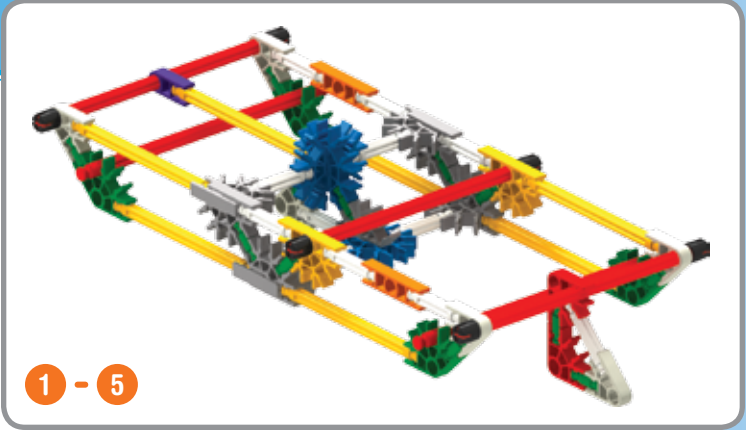
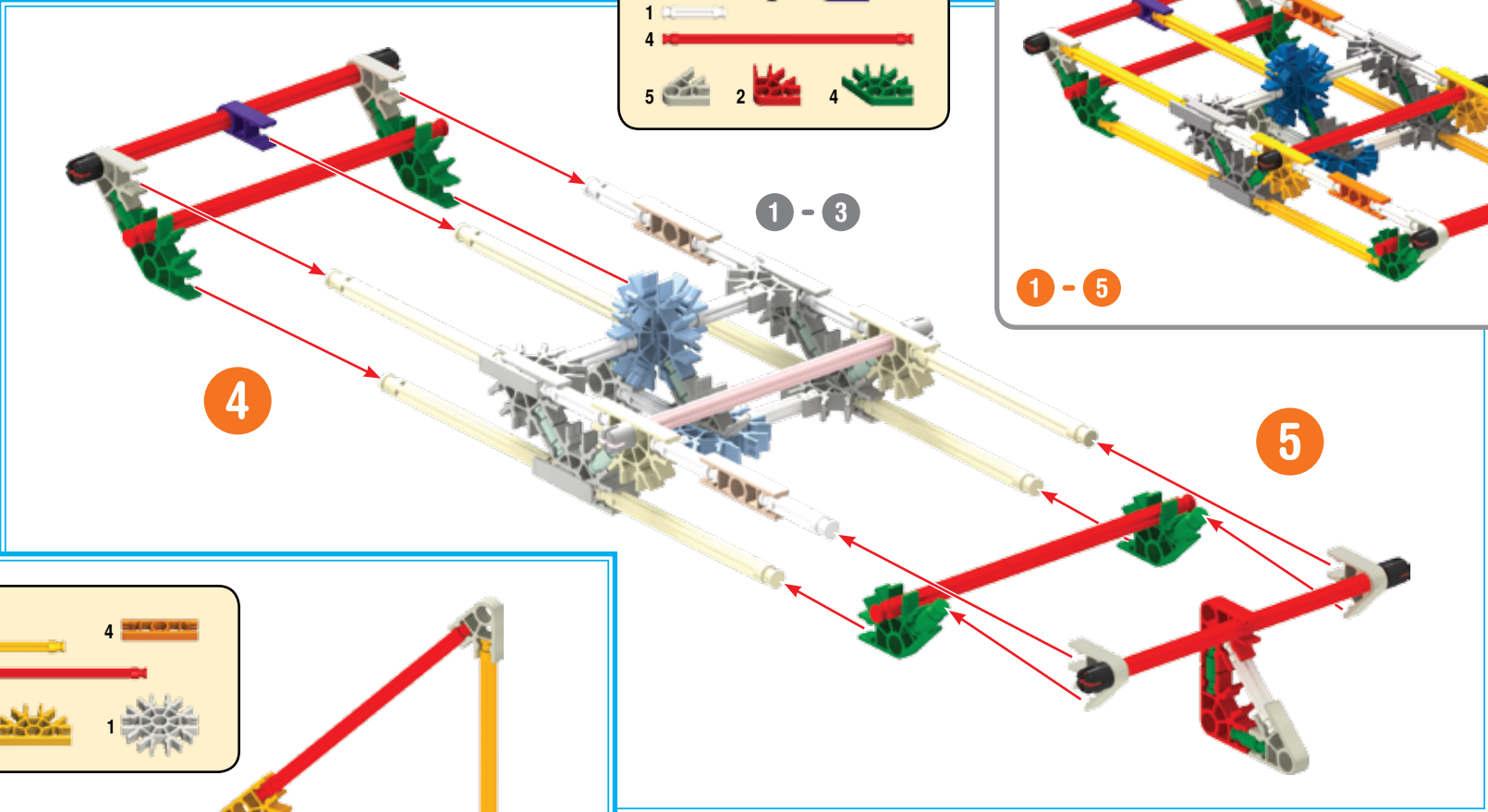
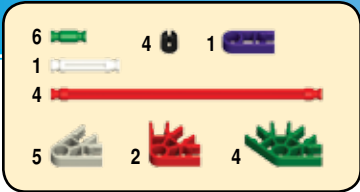

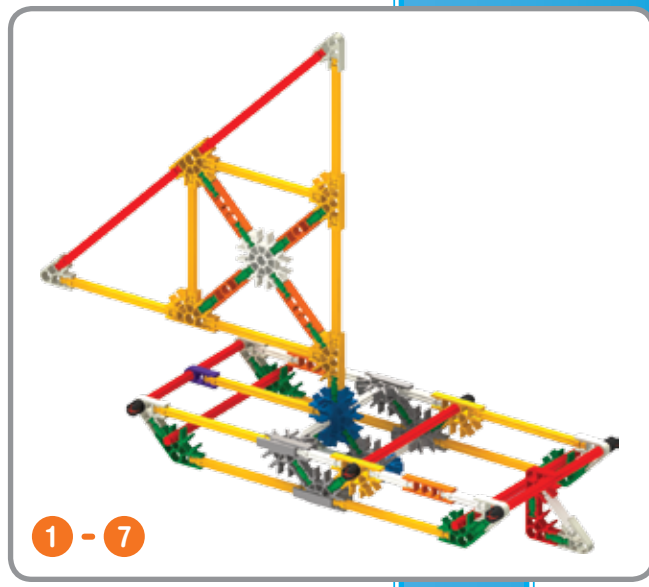
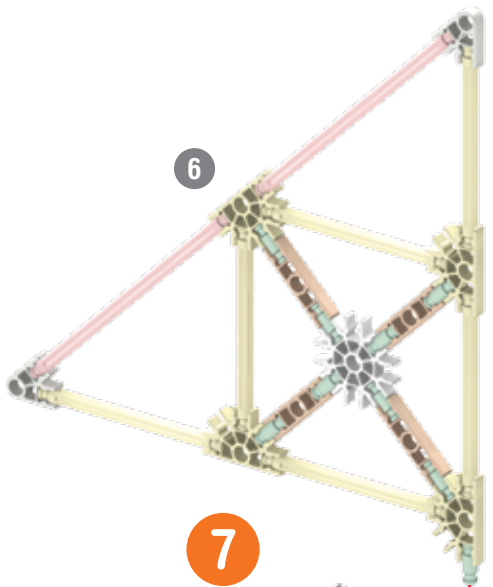



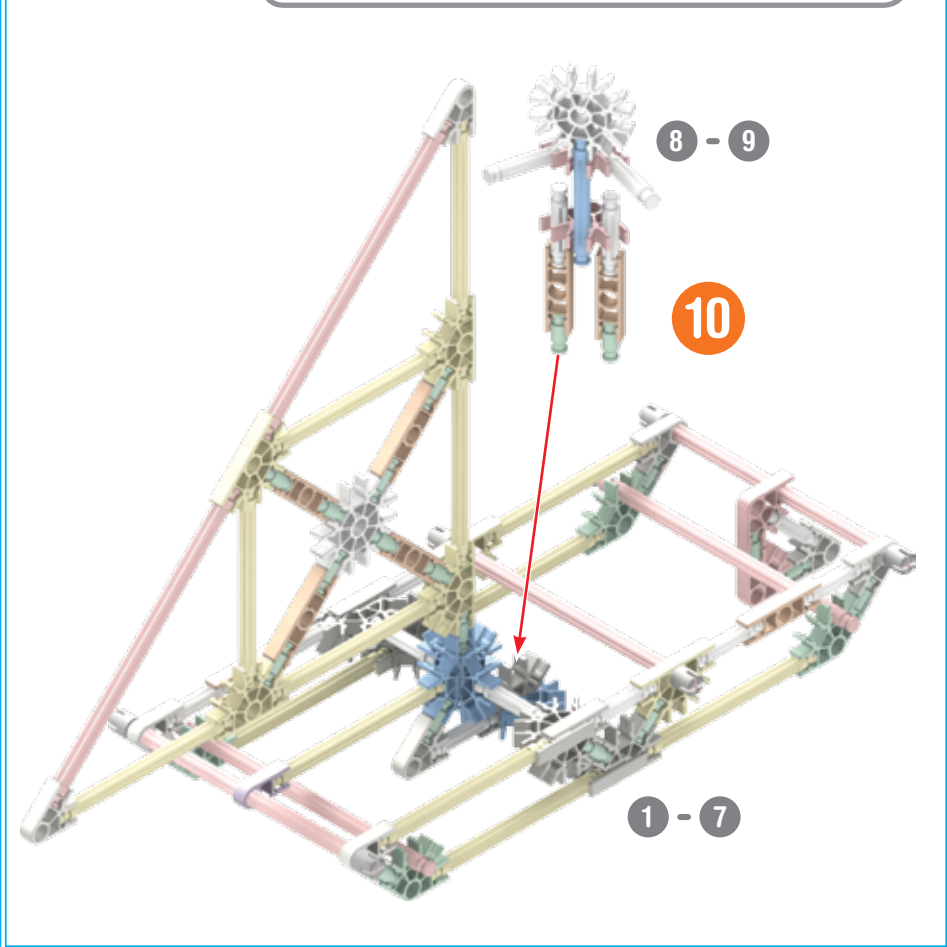
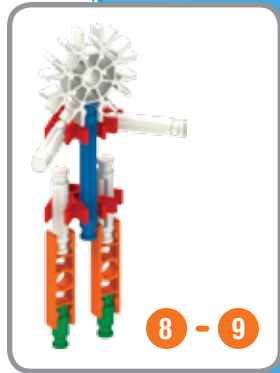
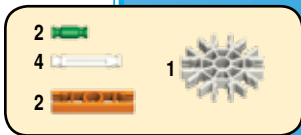
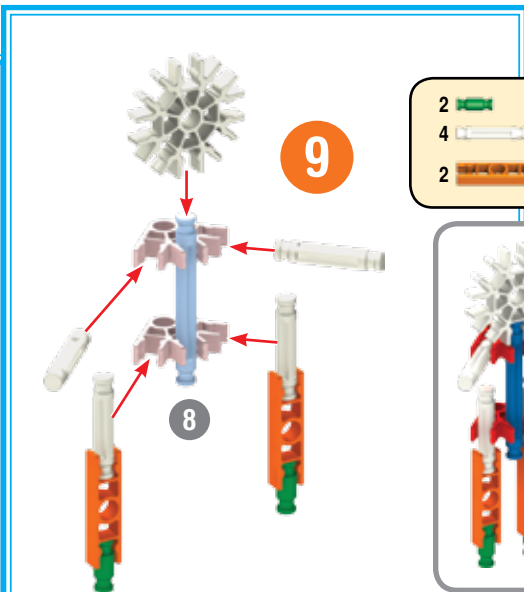
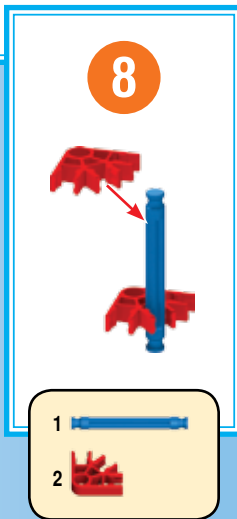
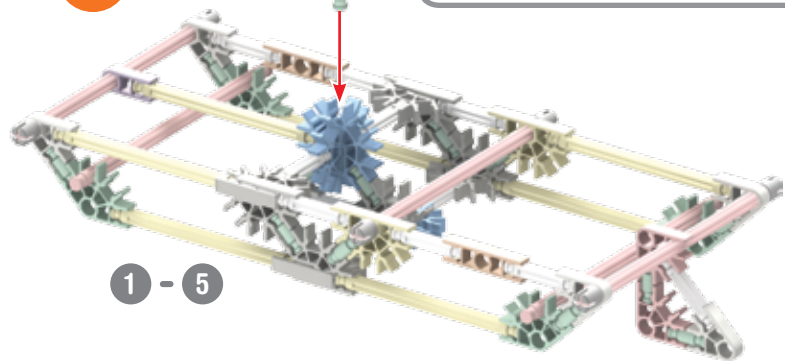



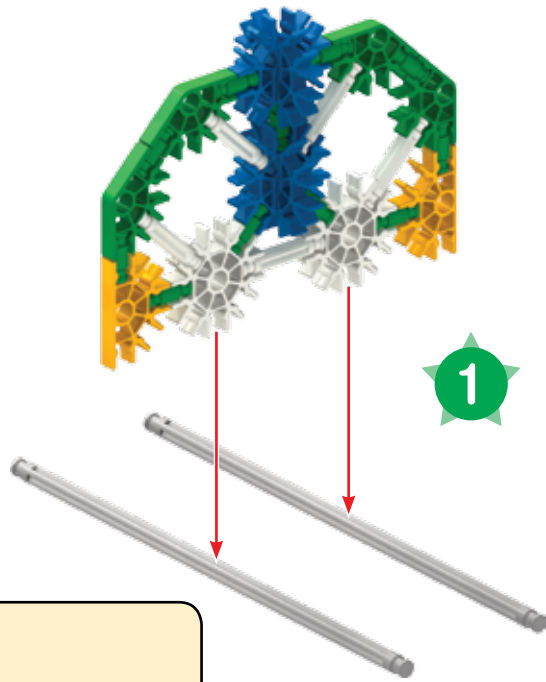

7



# Brachiosaurus

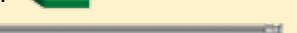



## Brachiosaurus

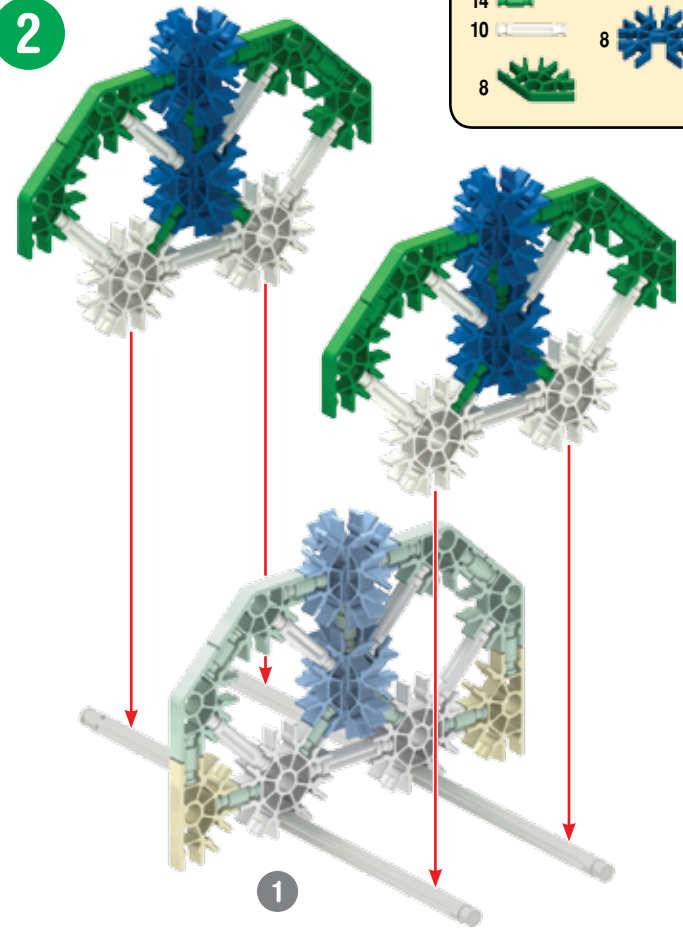

- 11  4 
- 5  2 
- 2  2  4 

2



- 14 
- 10 
- 8 
- 8 
- 4 

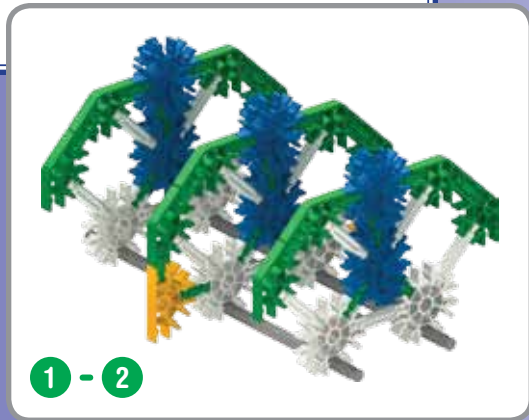
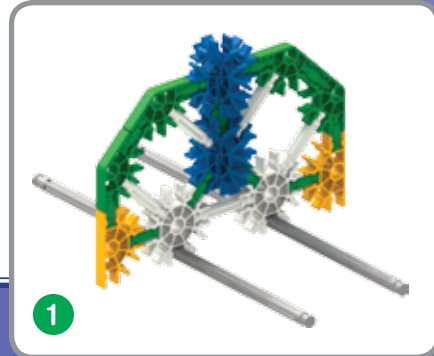

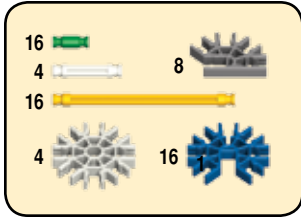
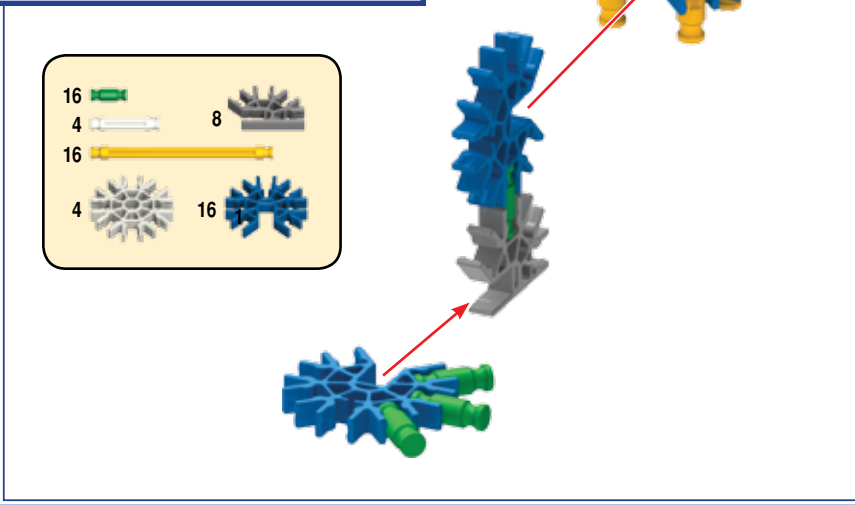
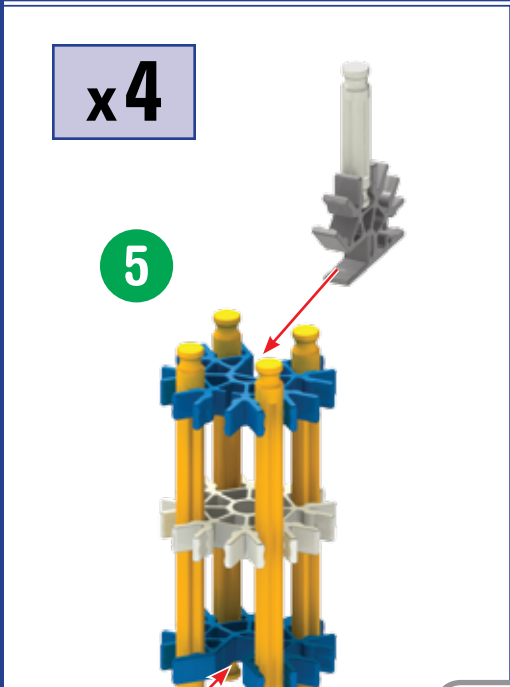
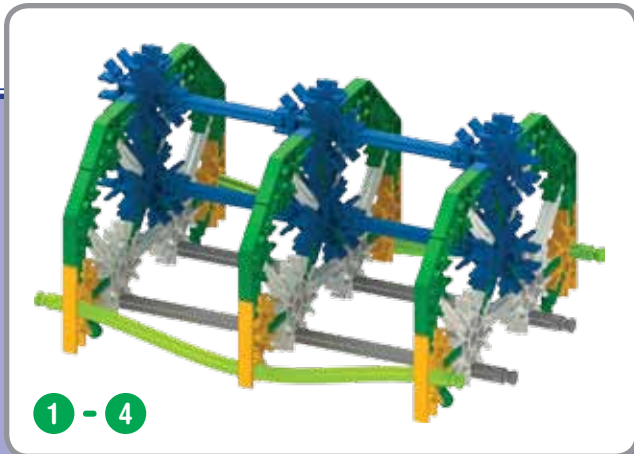
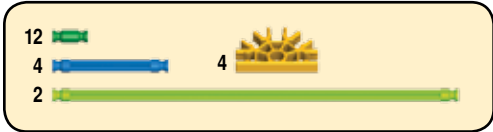
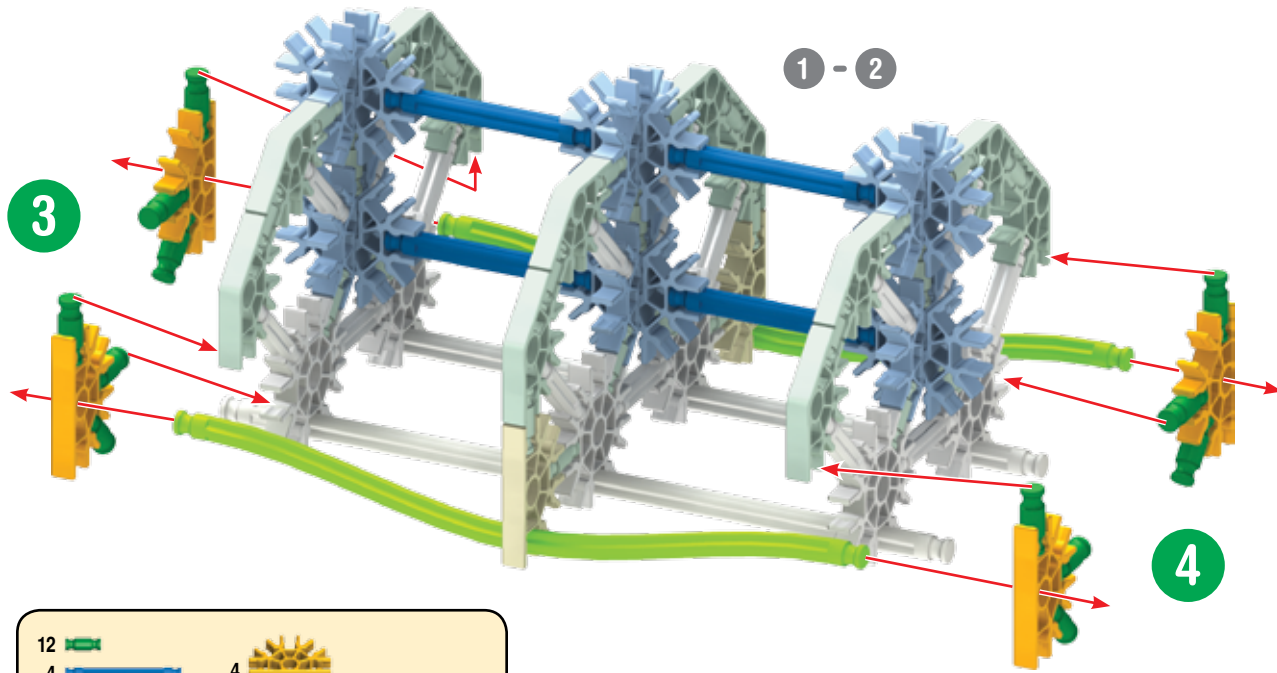

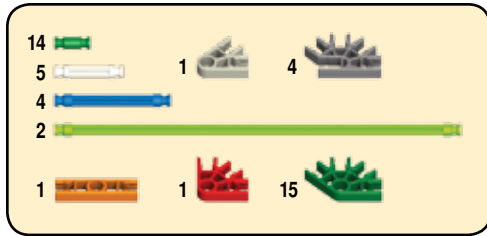
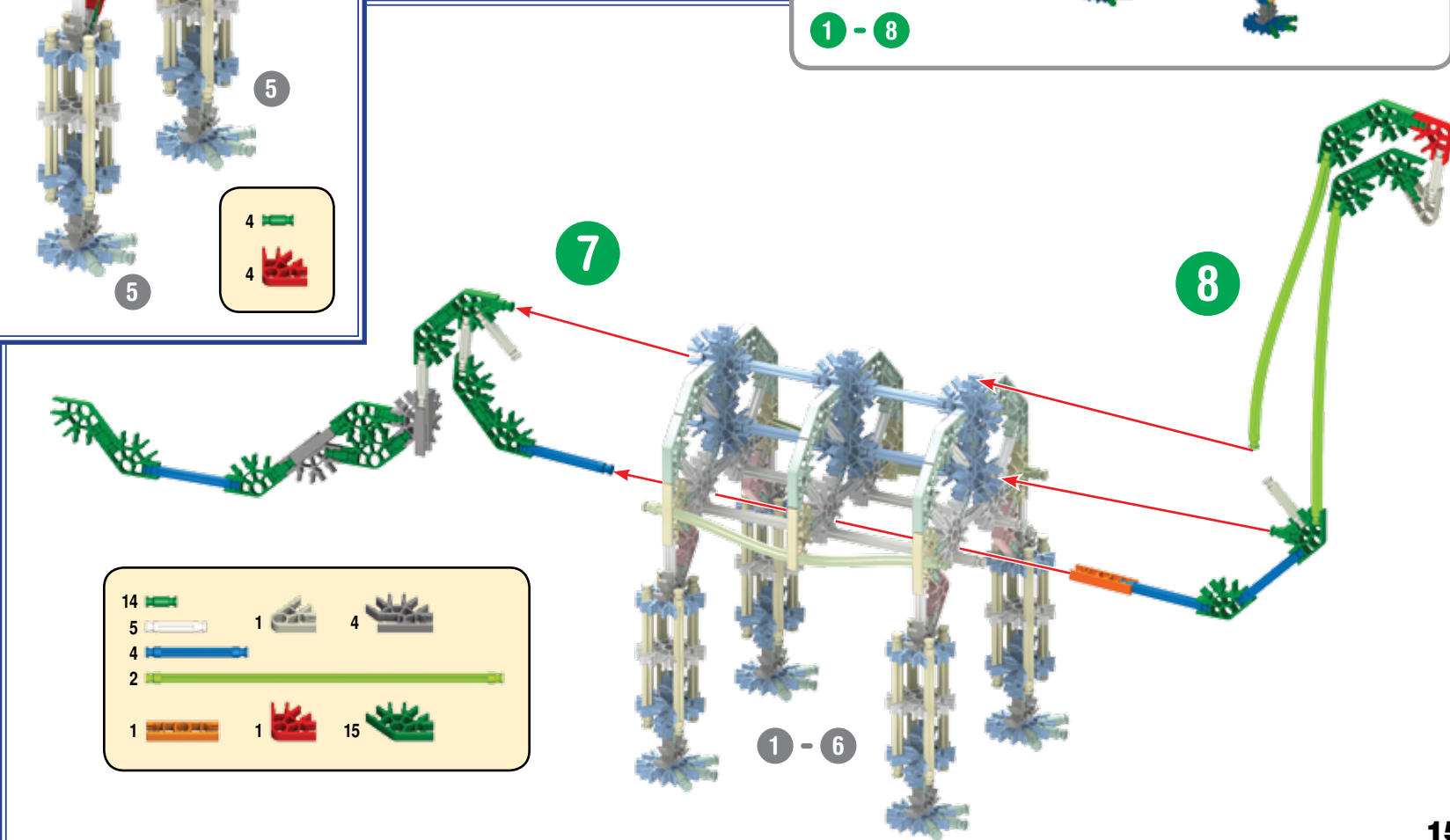
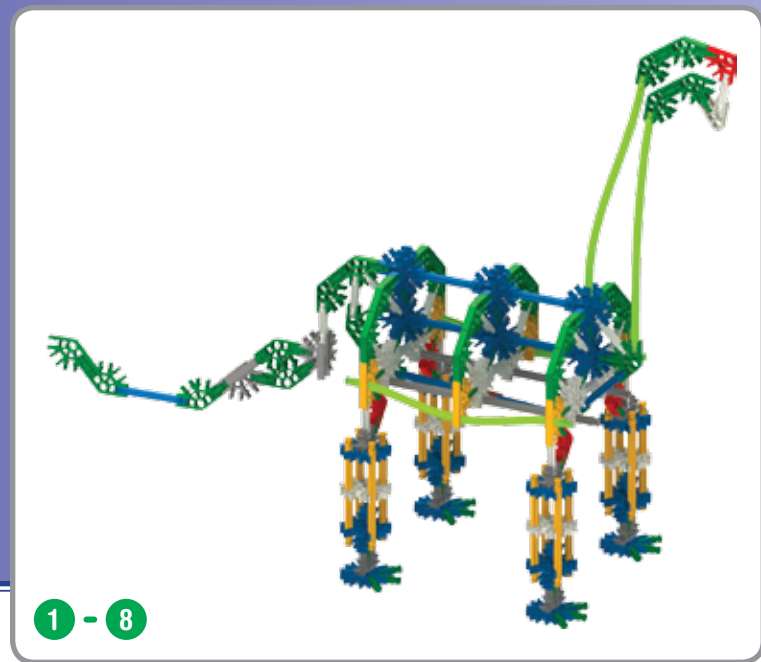
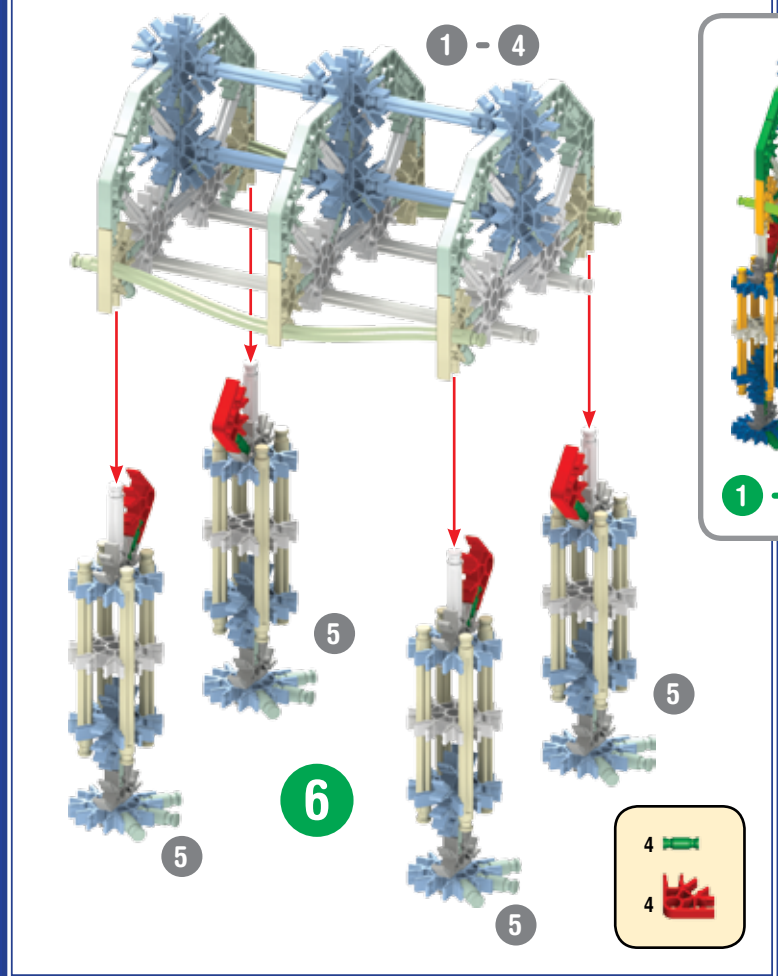

# Excavator Excavateur

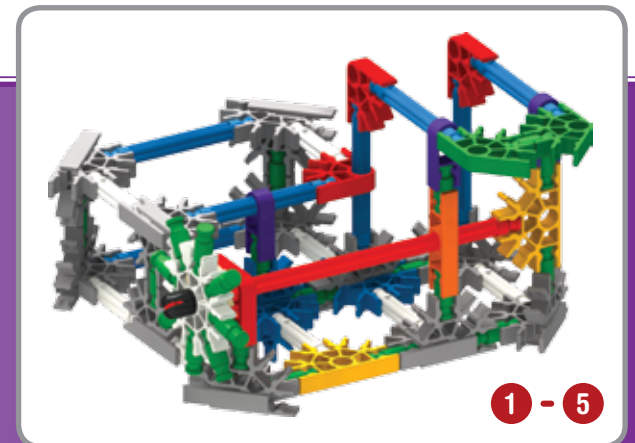
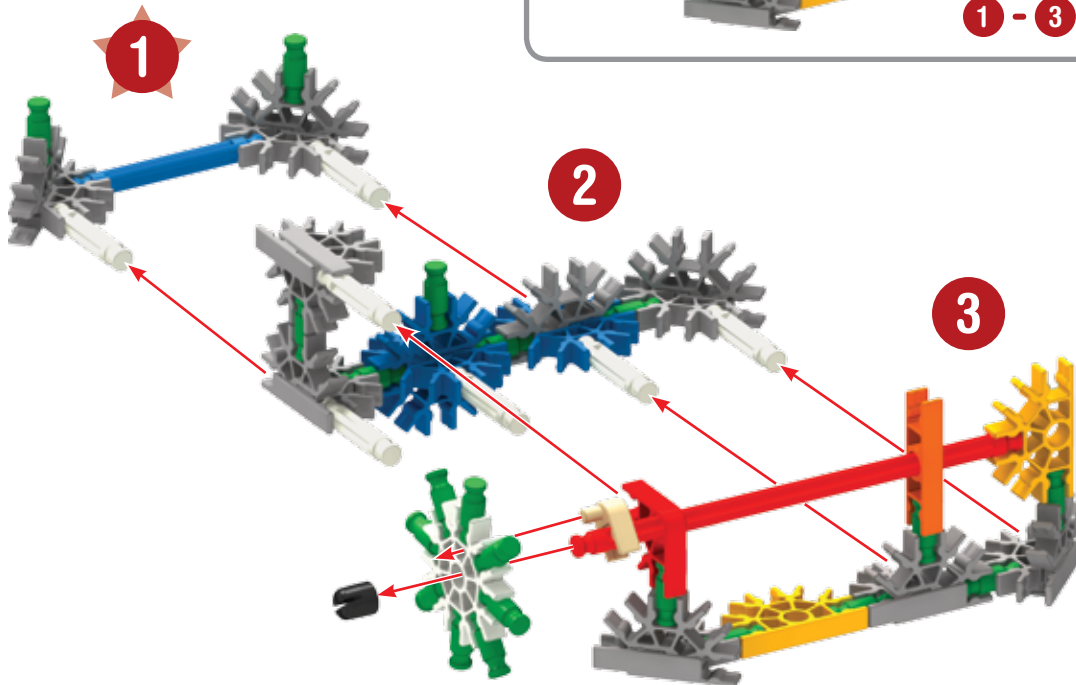
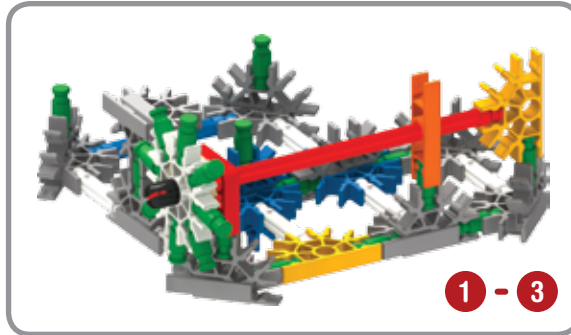
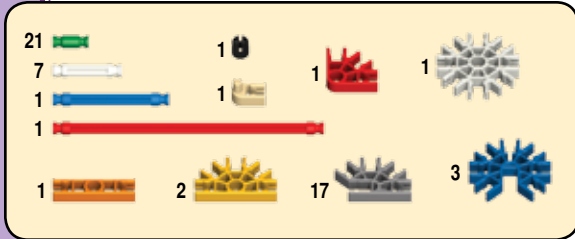
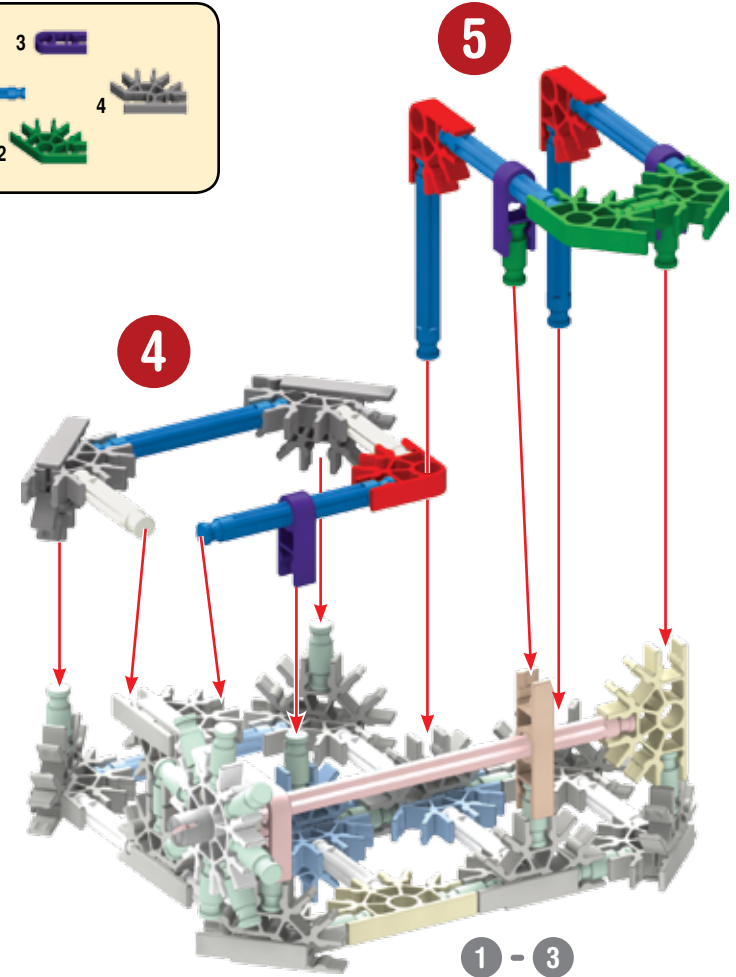
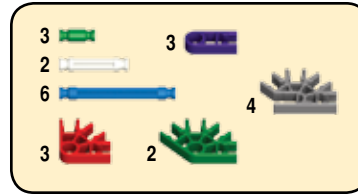

**6**

**6**

1	5	1
2		
2		

**x6**

**7**

**7**

6	12	
24		12
6		

**12**

**7**

**7**

**7**

**7**

**7**

**8**

**6**

**6 - 8**

**1 - 9**

**9**

**1 - 5**

**6 - 8**

11

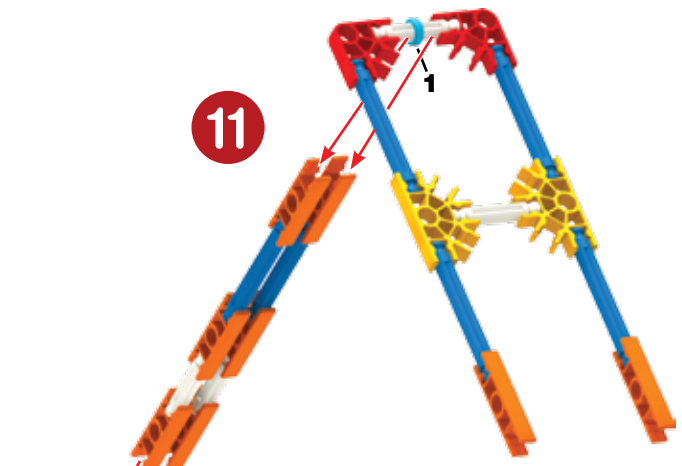

10

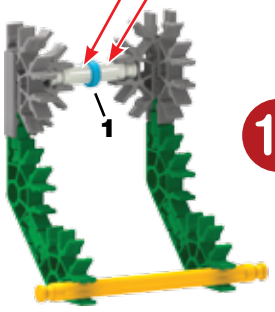

2	
4	
5	
6	
1	
8	
4	
4	
2	
2	
4	
4	



1 - 12



10 - 11

12

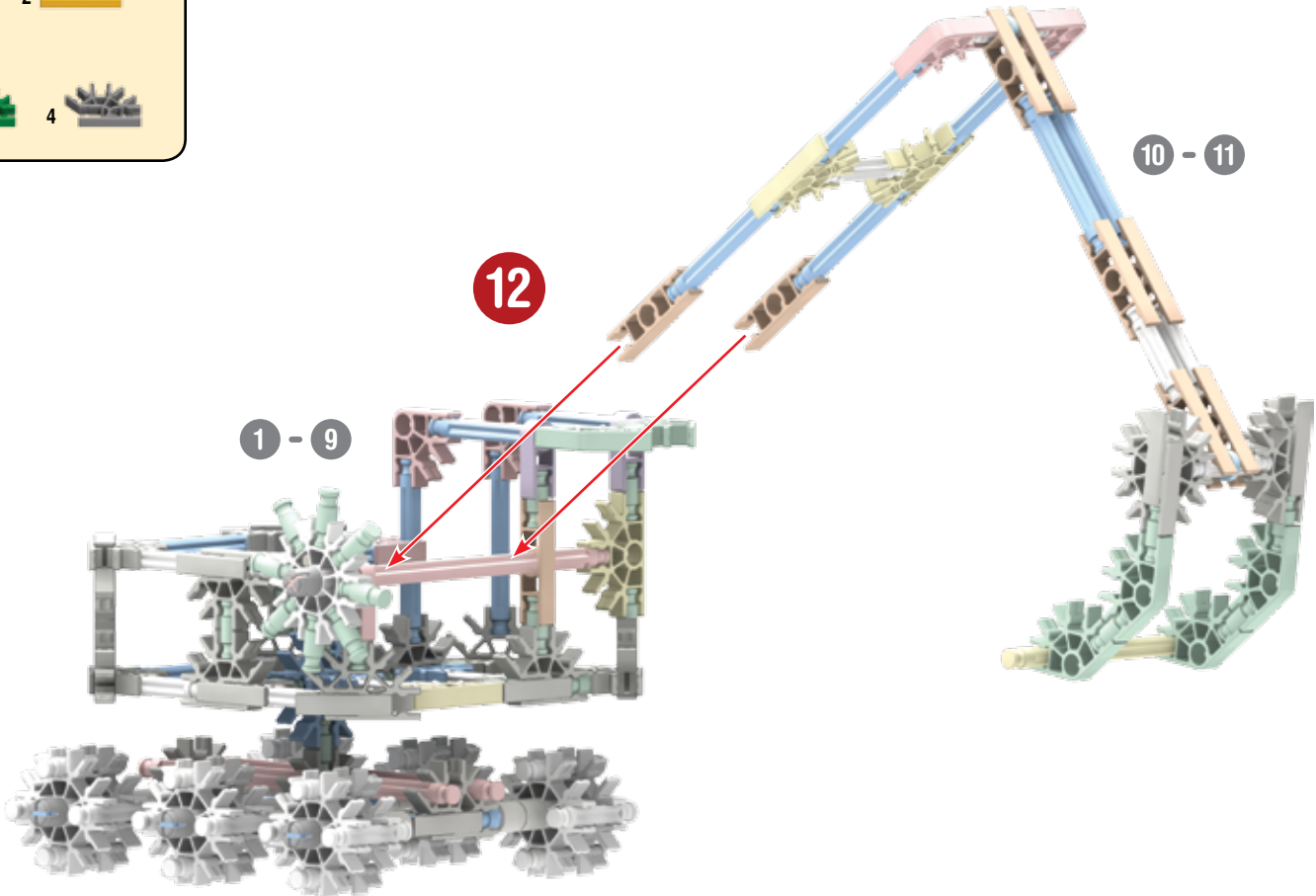

1 - 9

10 - 11

# Space Shuttle

# Navette spatiale

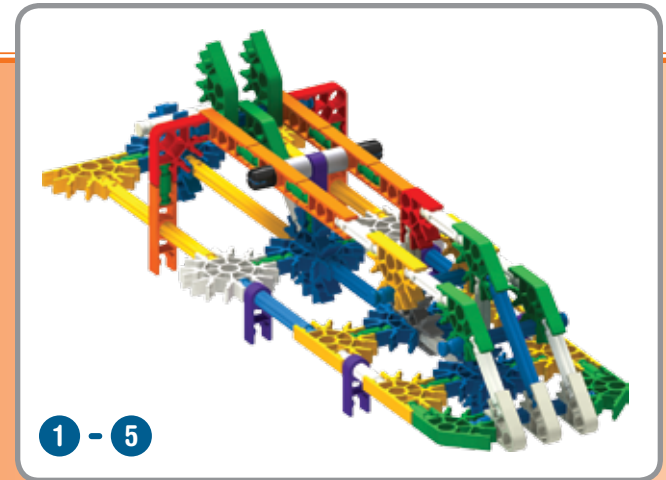
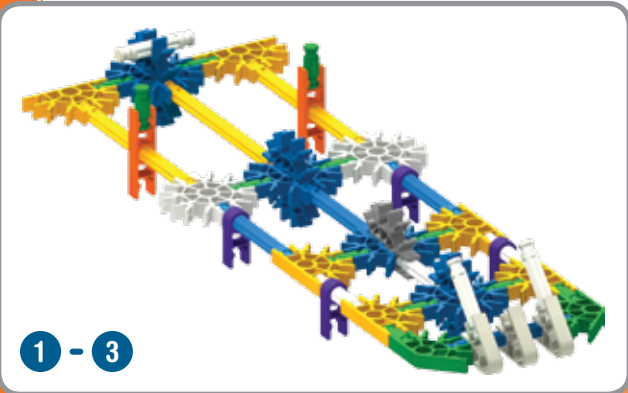
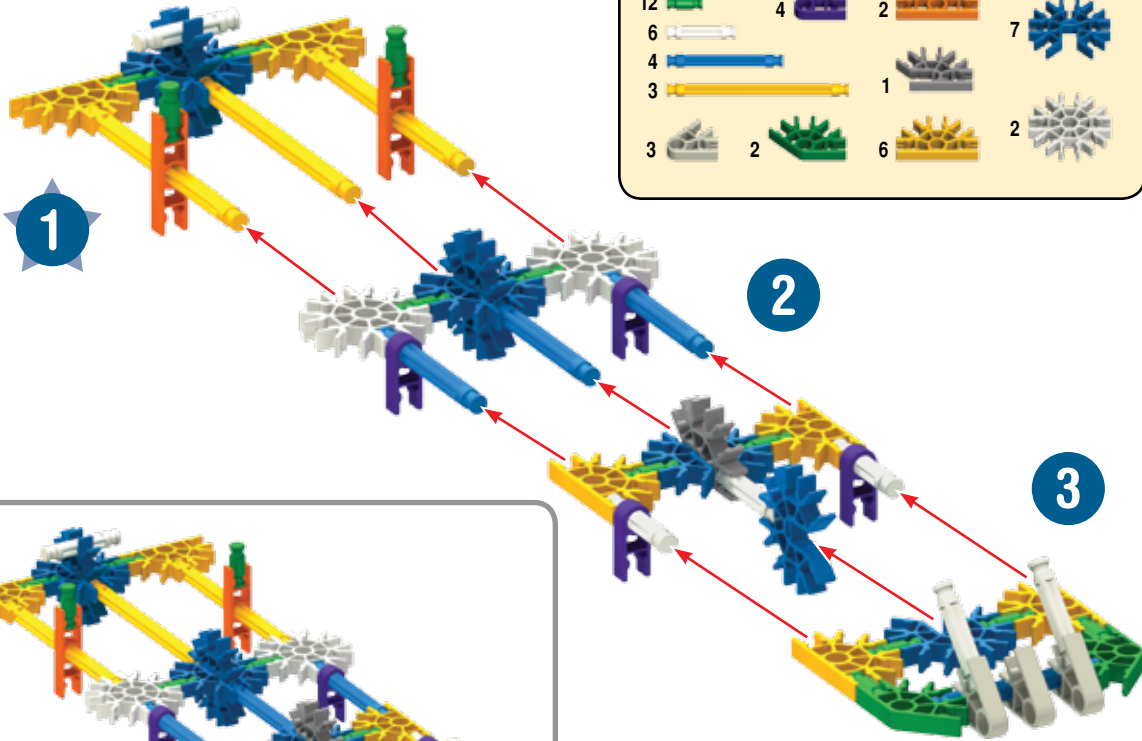
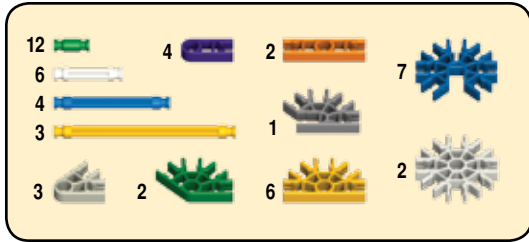
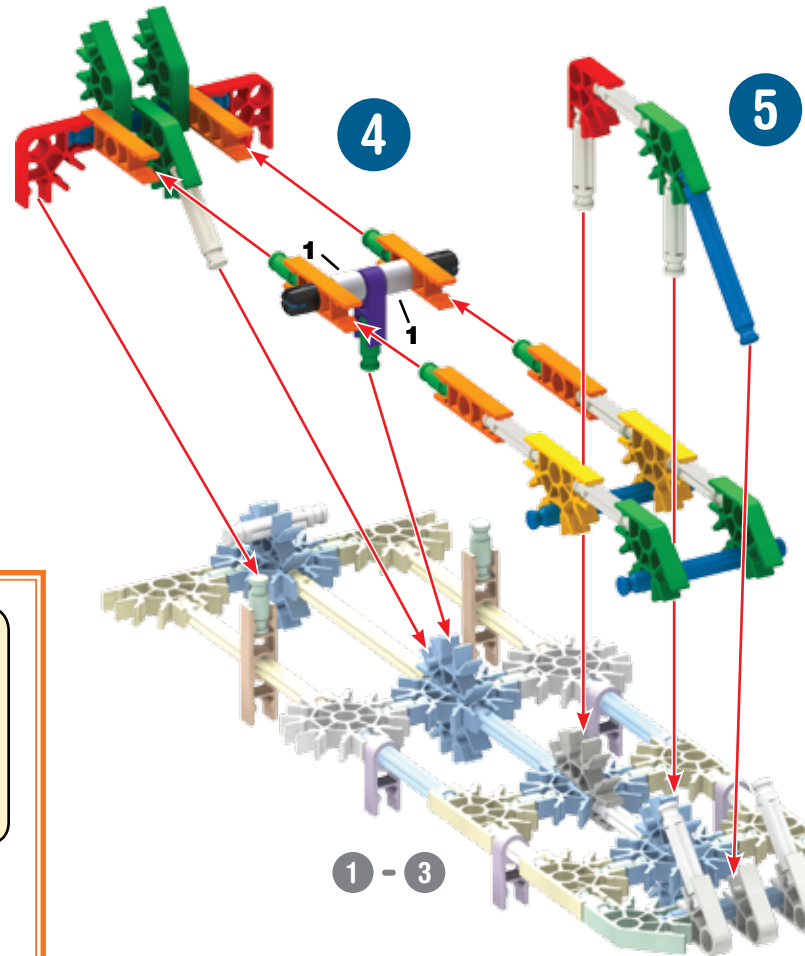
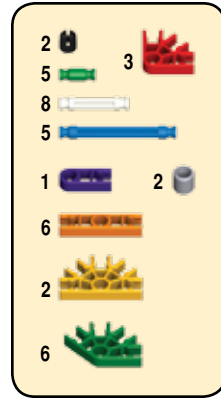
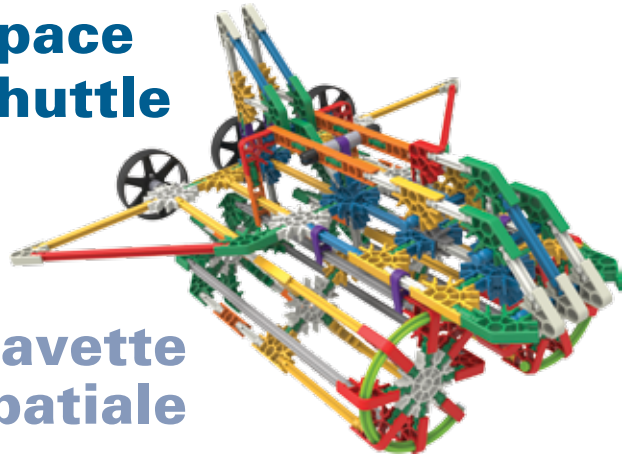

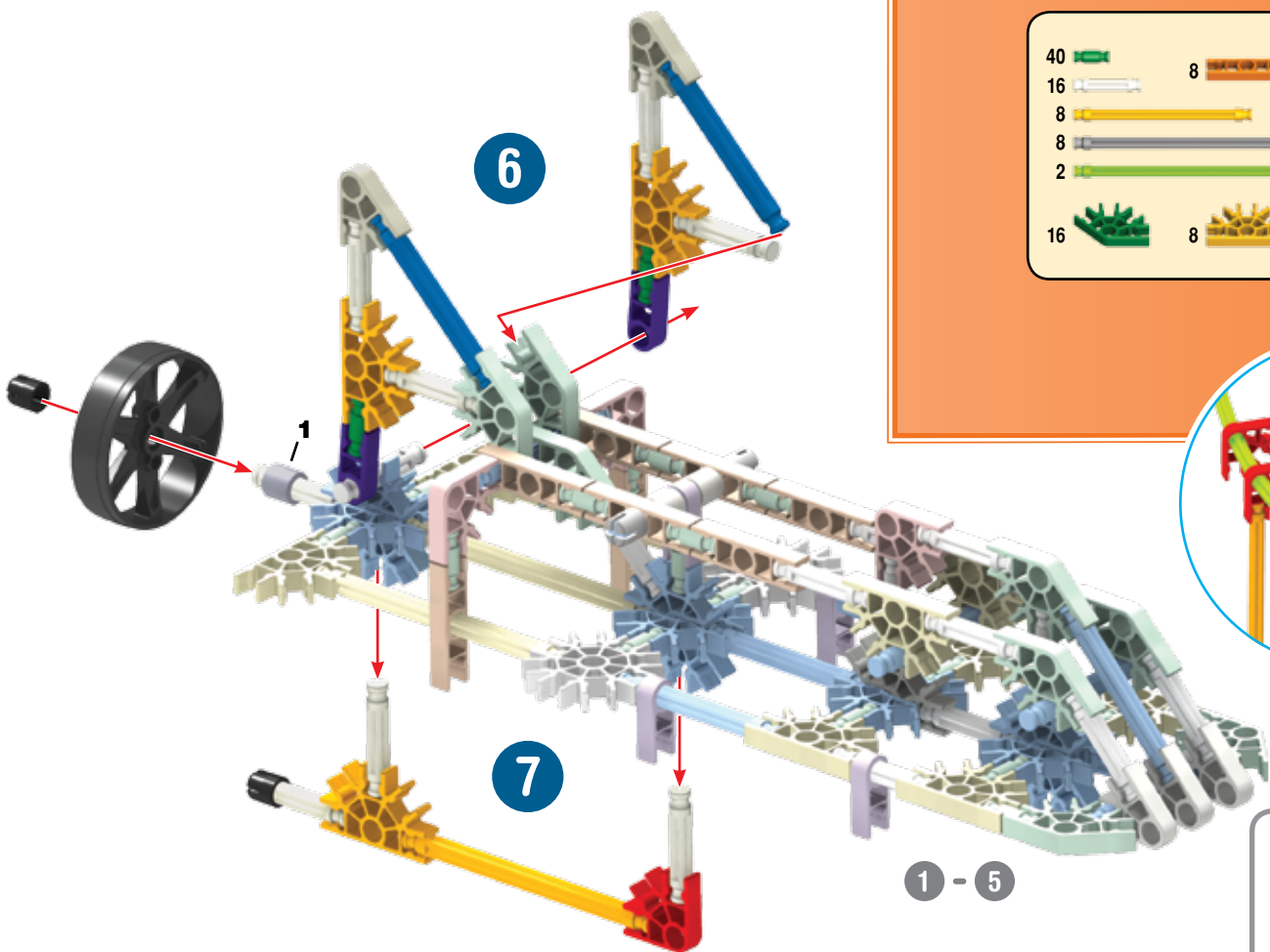

- |    |  |   |  |    |  |
|----|--|---|--|----|--|
| 40 |  | 8 |  | 16 |  |
| 16 |  |   |  |    |  |
| 8  |  |   |  |    |  |
| 8  |  |   |  |    |  |
| 2  |  |   |  |    |  |
| 16 |  | 8 |  | 6  |  |

x2

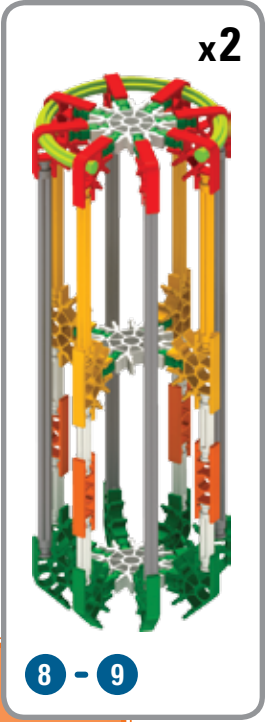
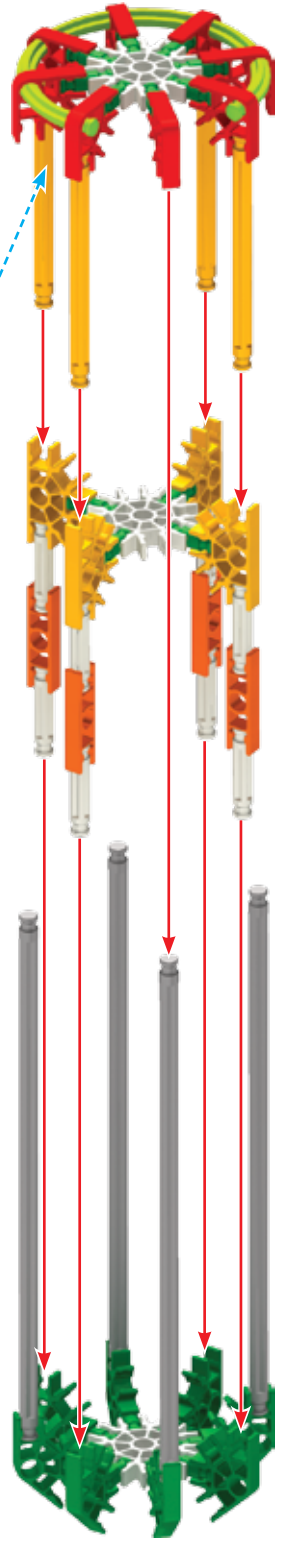

- |   |  |   |  |
|---|--|---|--|
| 2 |  | 2 |  |
| 8 |  | 1 |  |
| 2 |  |   |  |
| 1 |  |   |  |
| 2 |  | 2 |  |
| 1 |  | 3 |  |
| 1 |  |   |  |



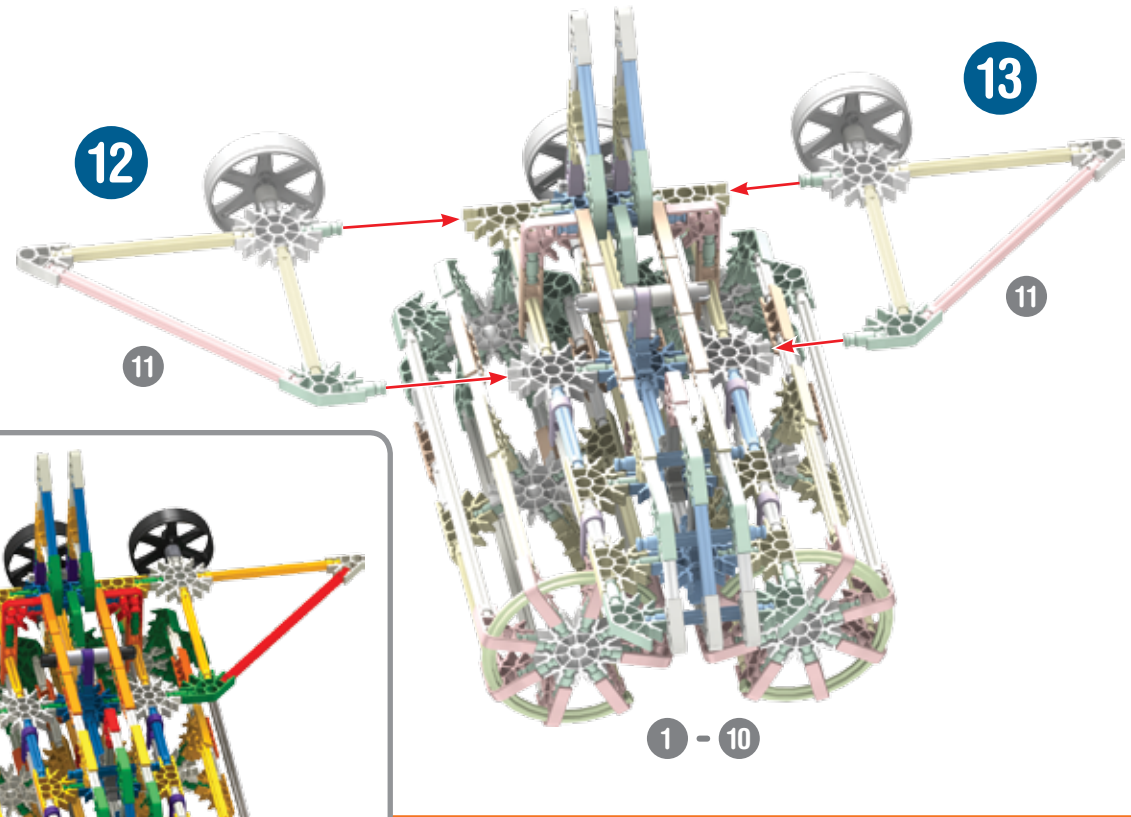
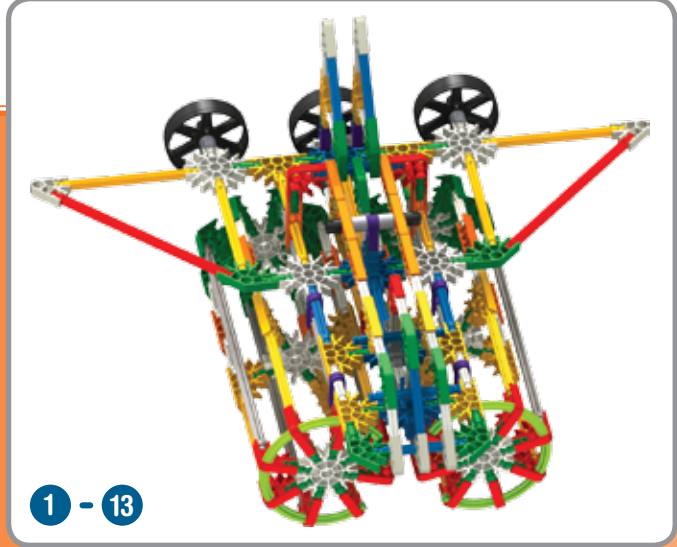
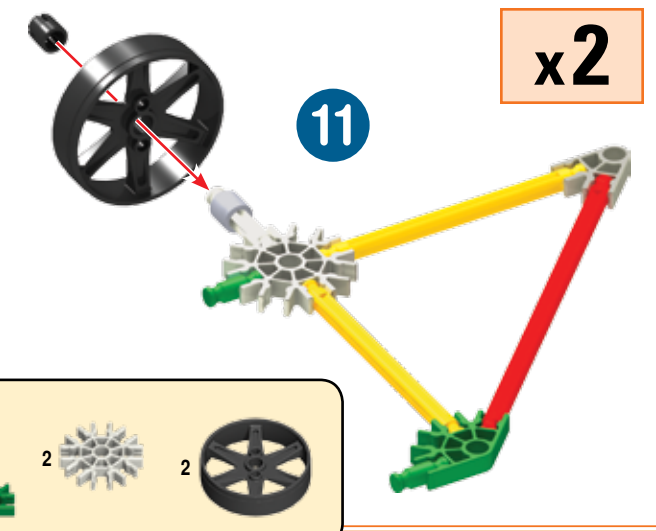
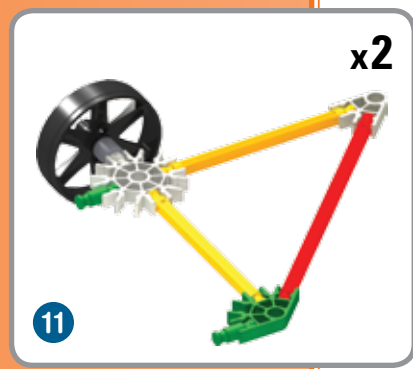
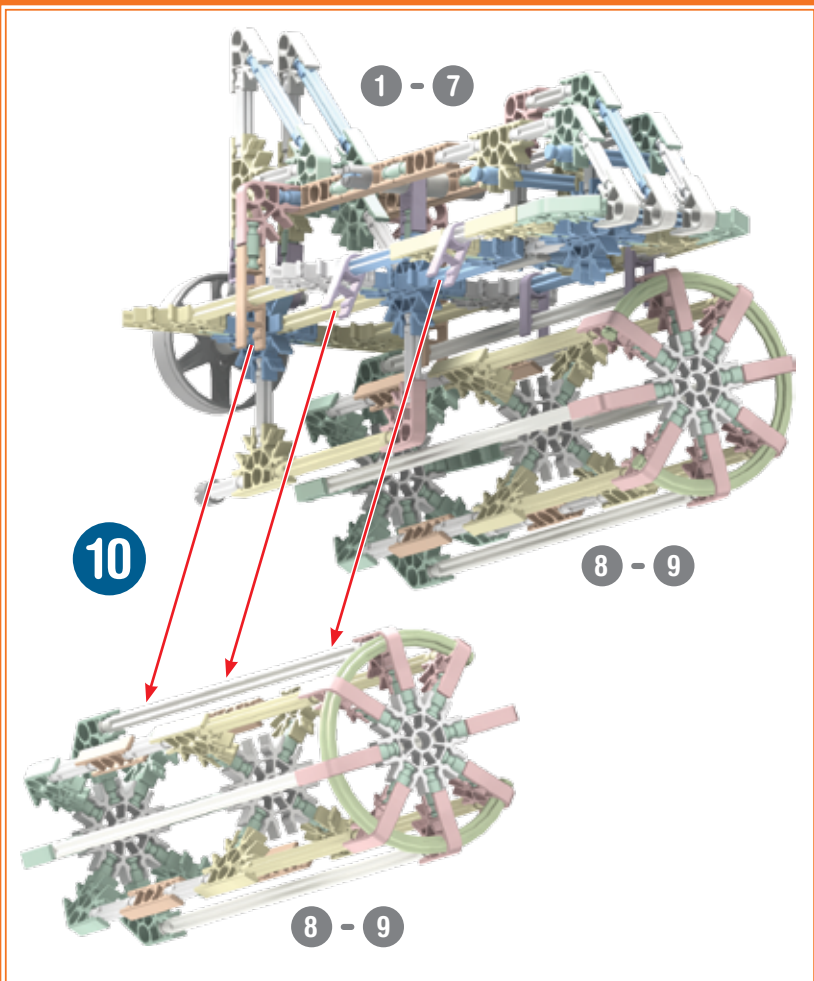

# Eiffel Tower

## La tour Eiffel

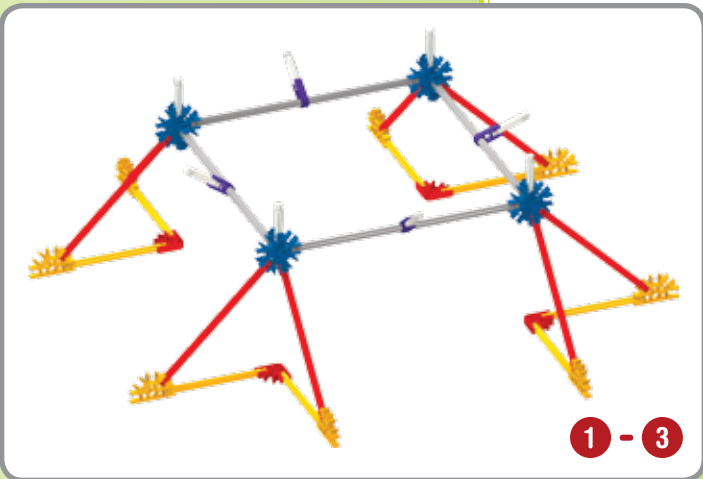
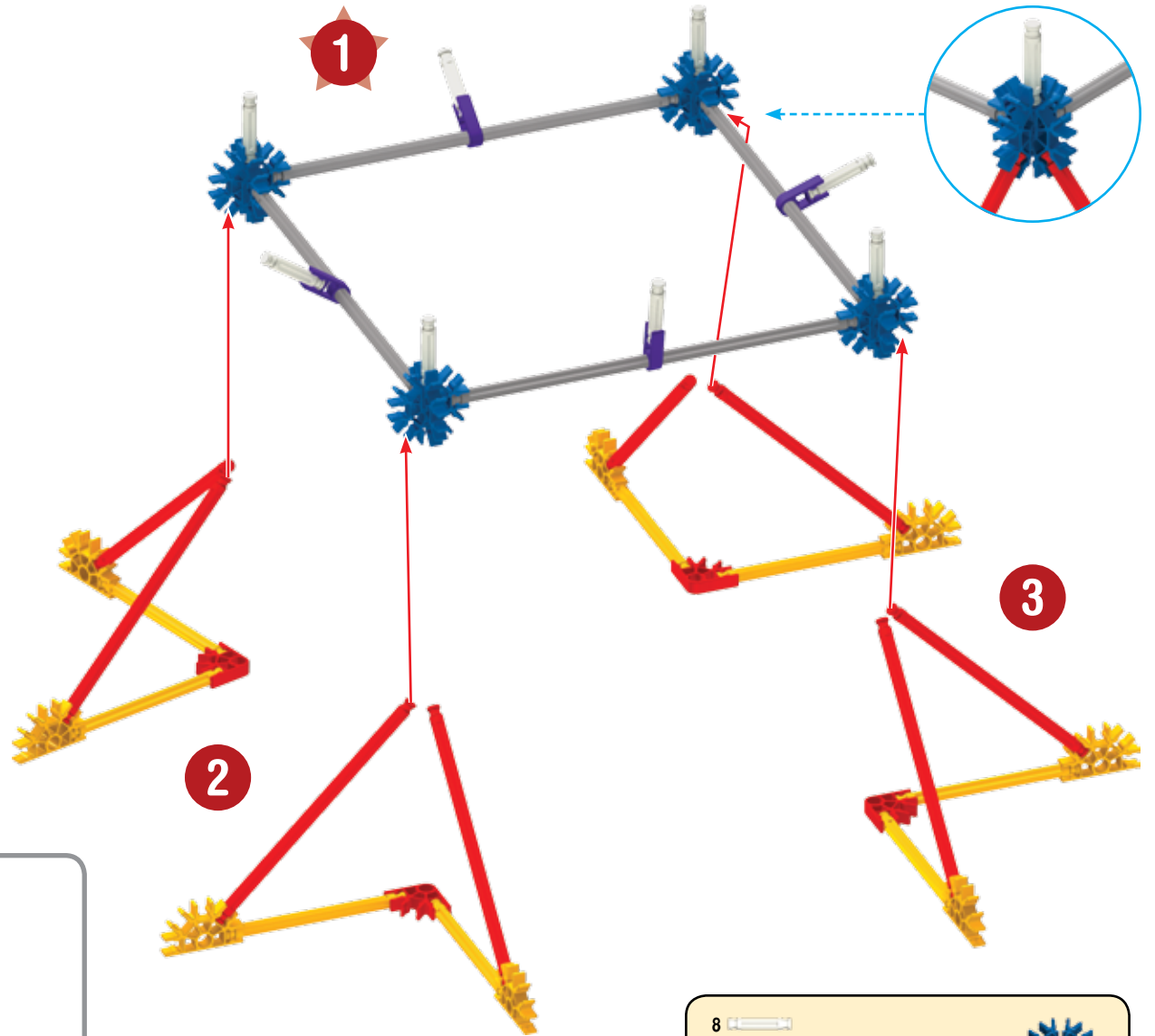

- |   |  |   |  |
|---|--|---|--|
| 8 |  | 8 |  |
| 8 |  |   |  |
| 8 |  |   |  |
| 4 |  |   |  |
| 4 |  | 4 |  |
|   |  | 8 |  |

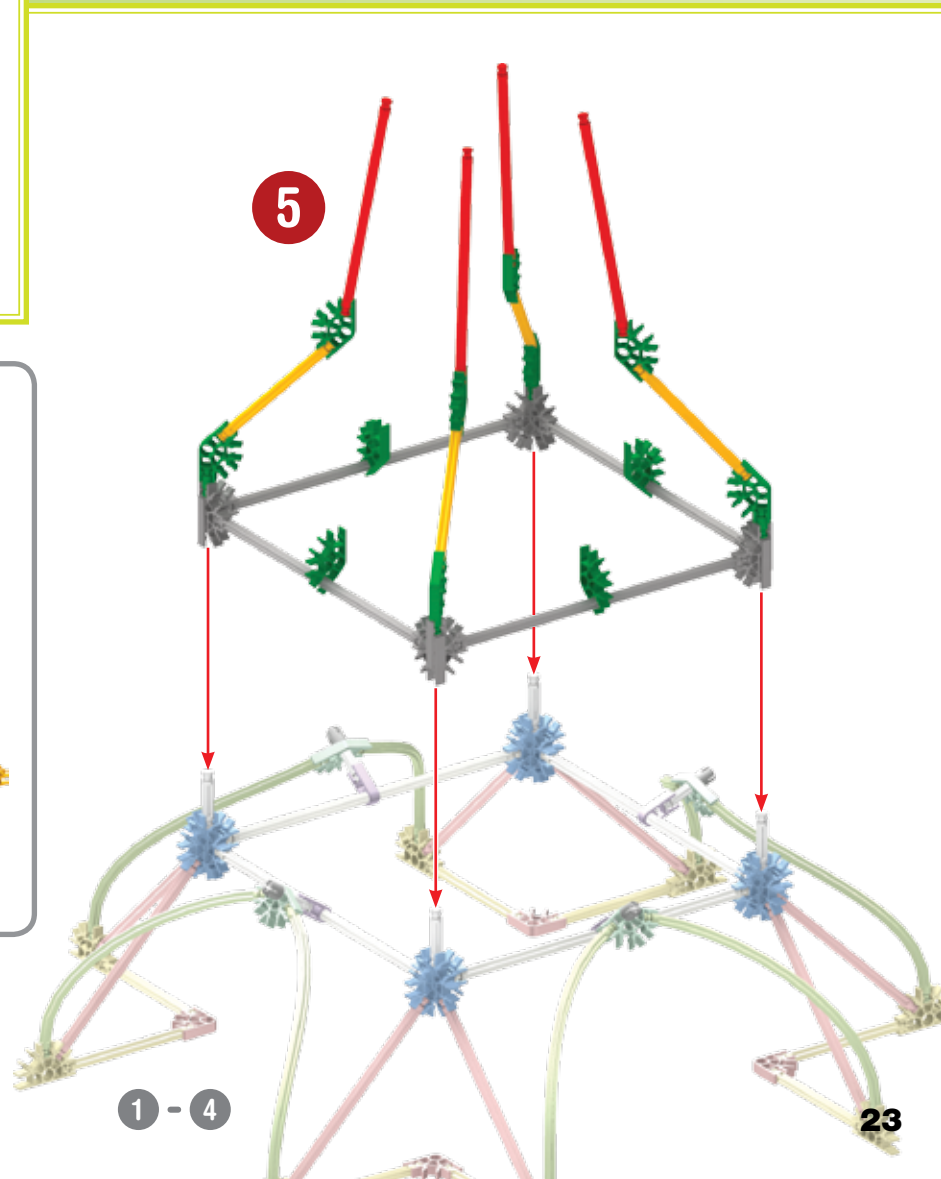
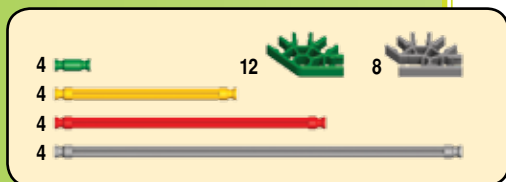
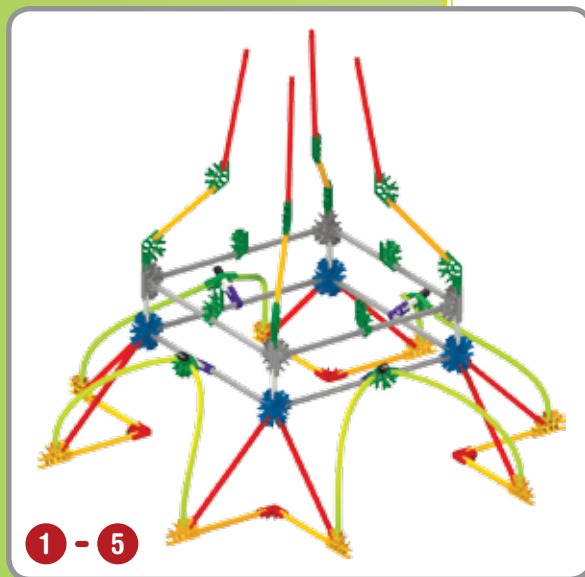
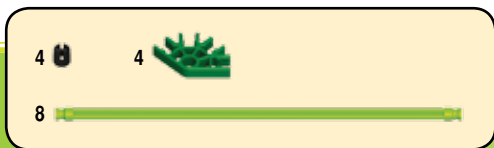
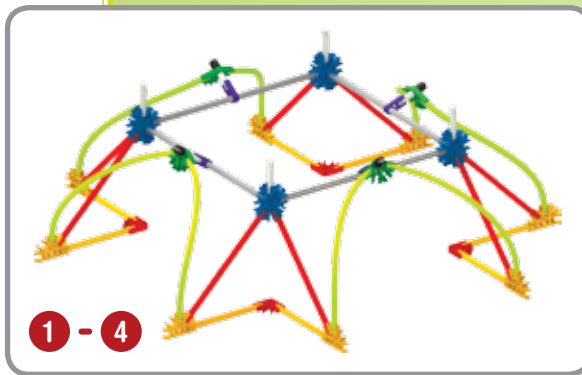
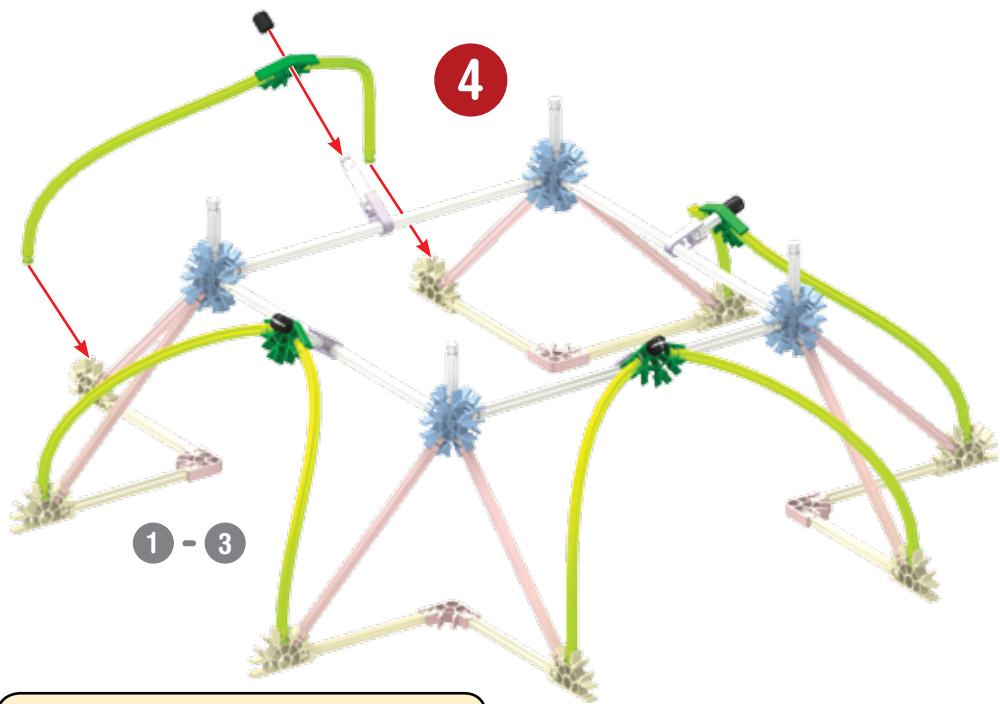

6

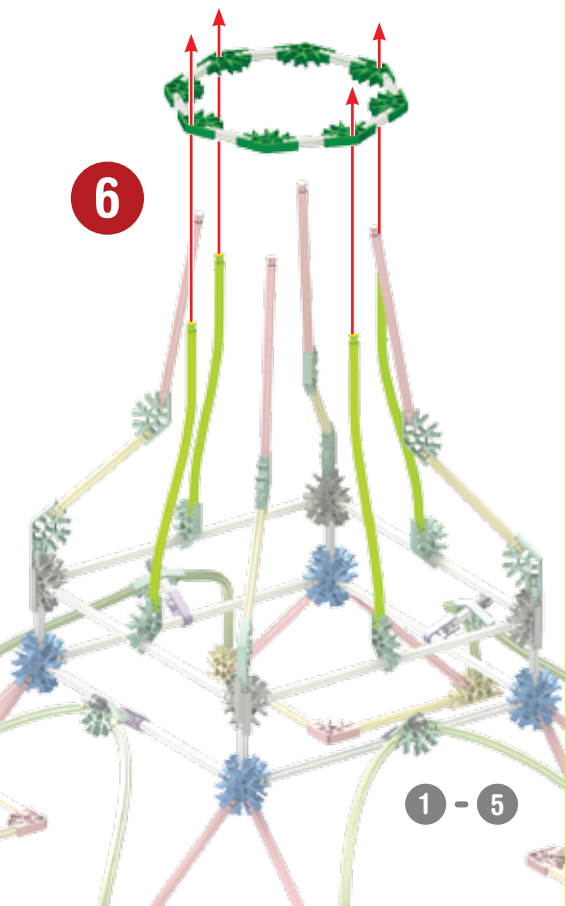

1 - 5

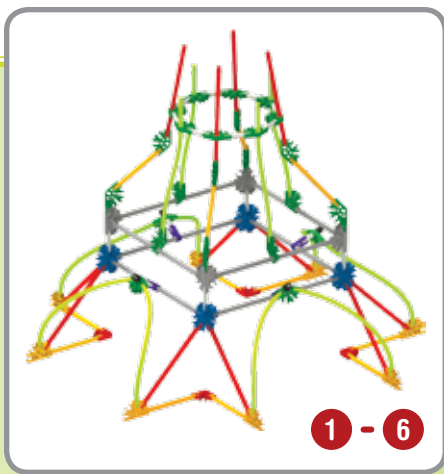
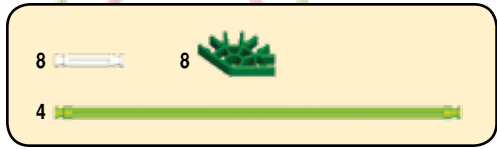

1 - 6

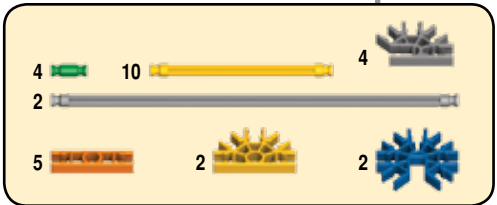

7

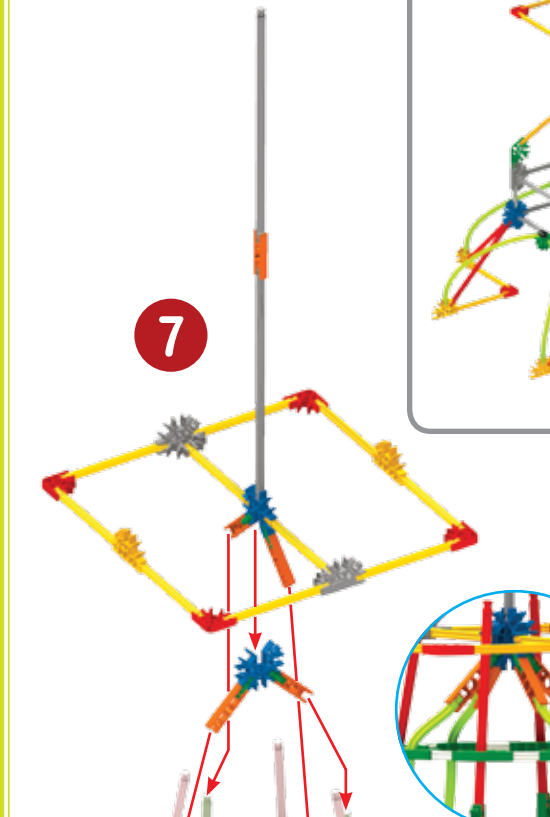

1 - 6

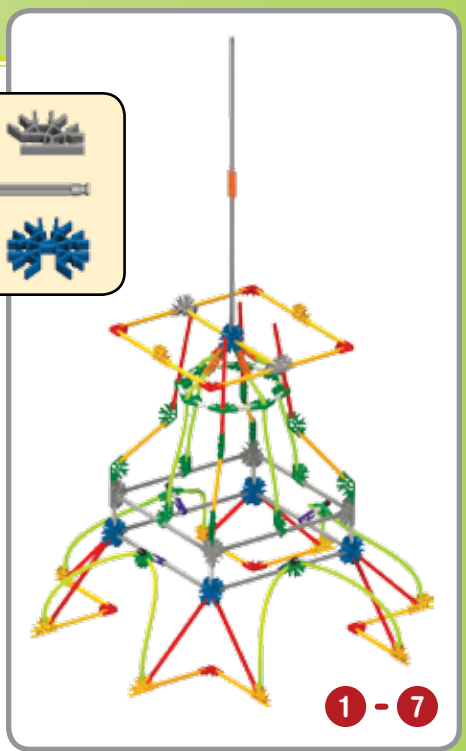
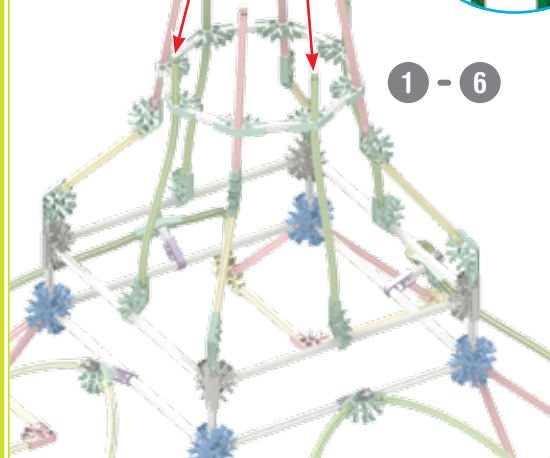

1 - 7

8

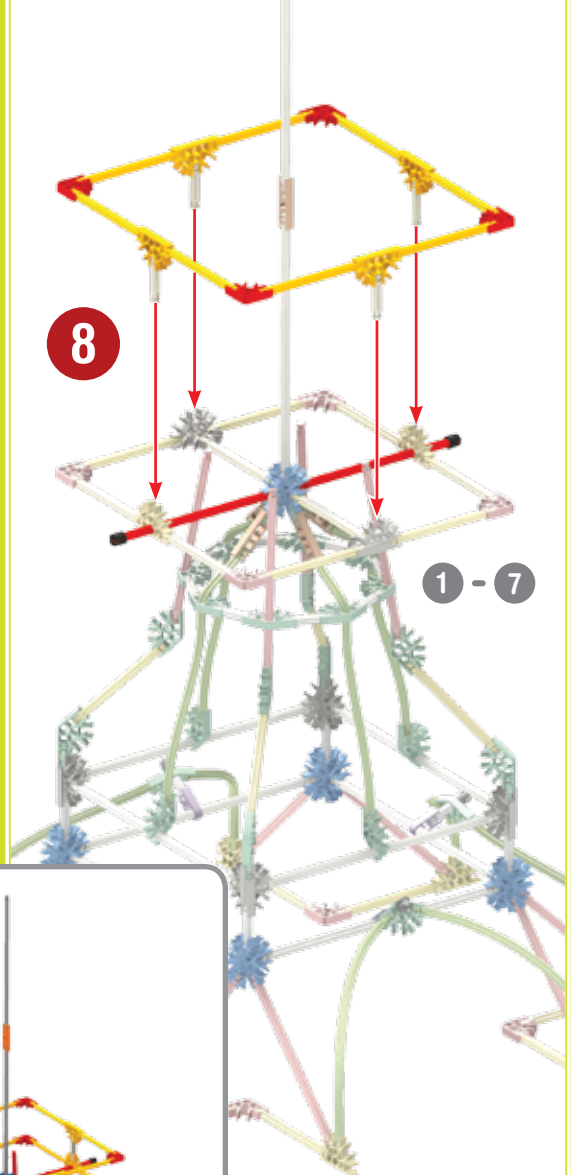

1 - 7

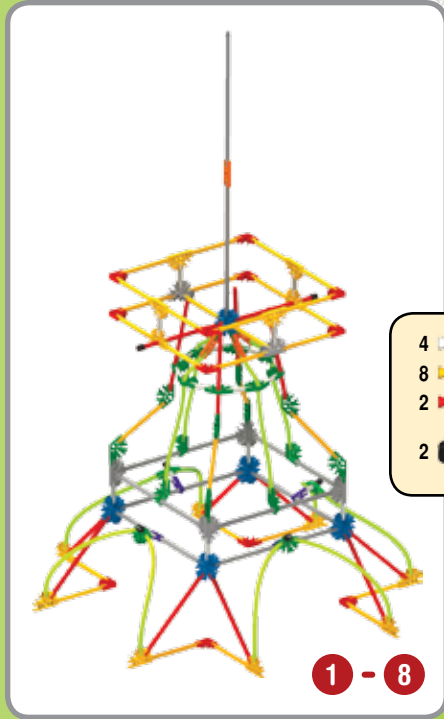
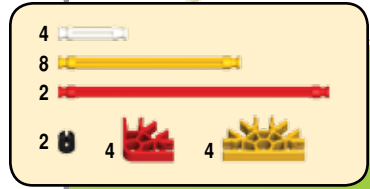

1 - 8

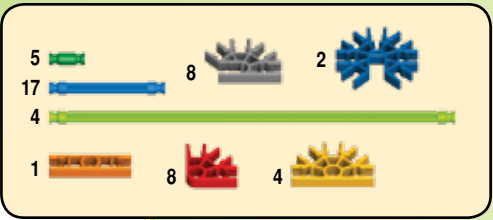

10

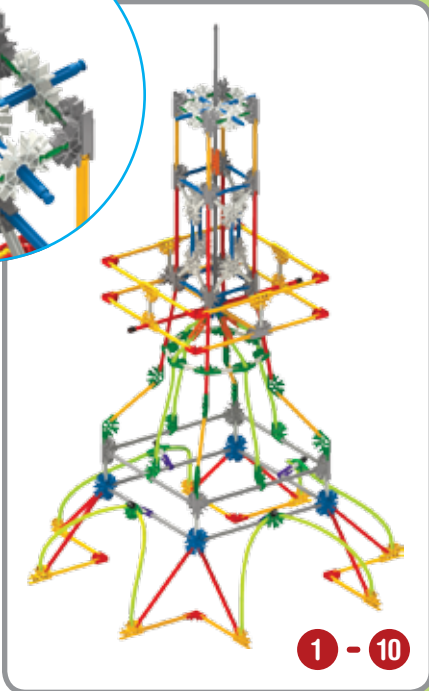

1 - 10

9

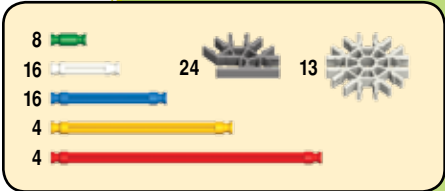

1 - 8

12

11

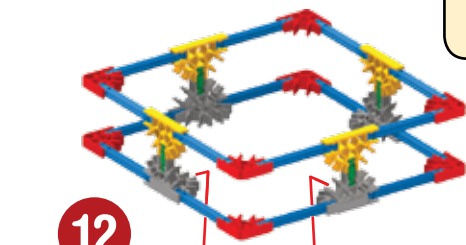

1 - 10

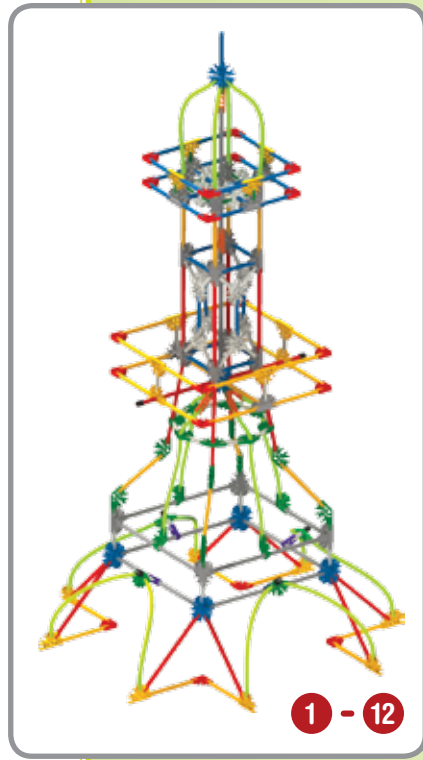

1 - 12

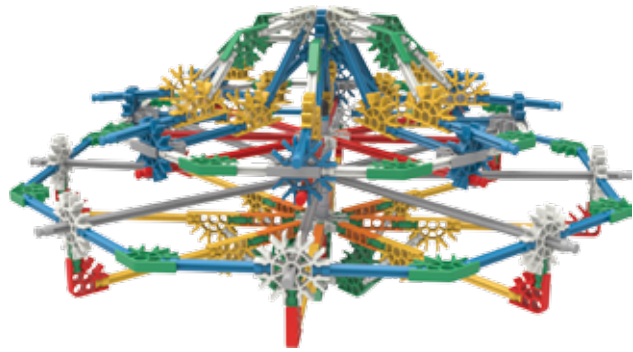

**Flying Saucer**  
Soucoupe volante

x8

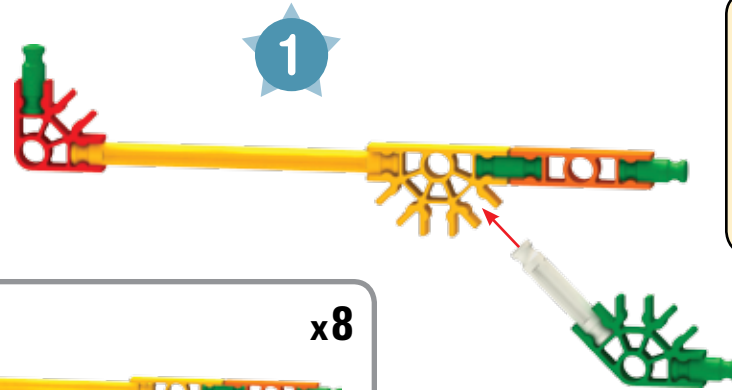

32	
8	
8	
8	
8	
8	
8	

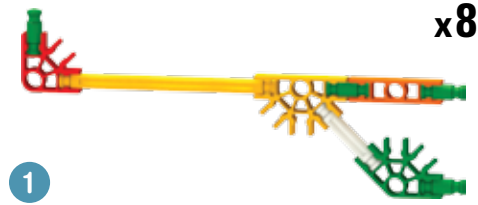

x8

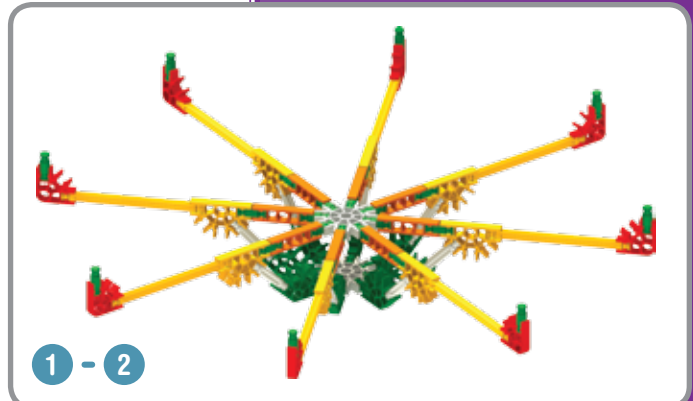
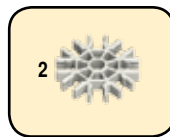
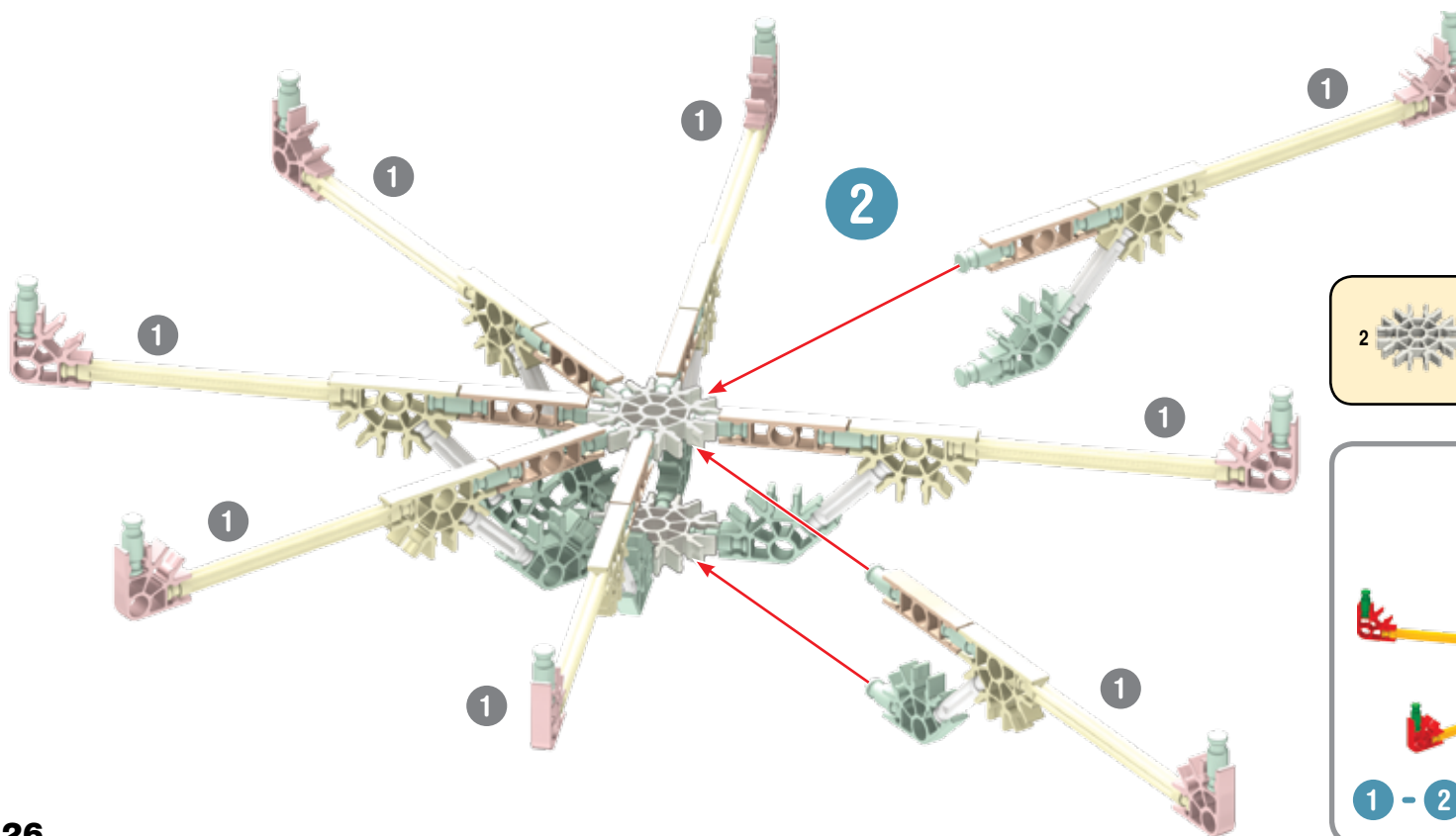

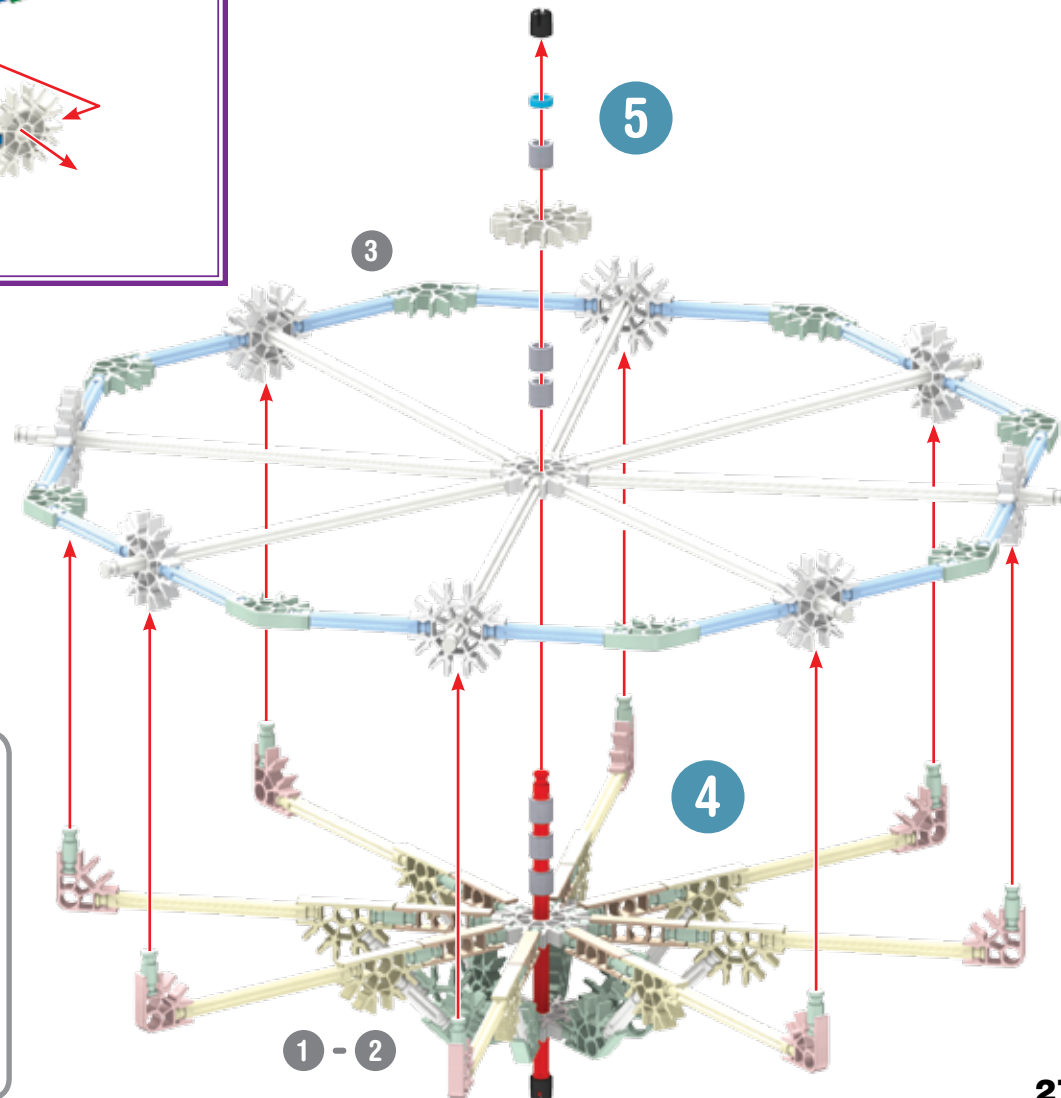
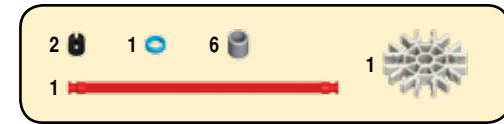
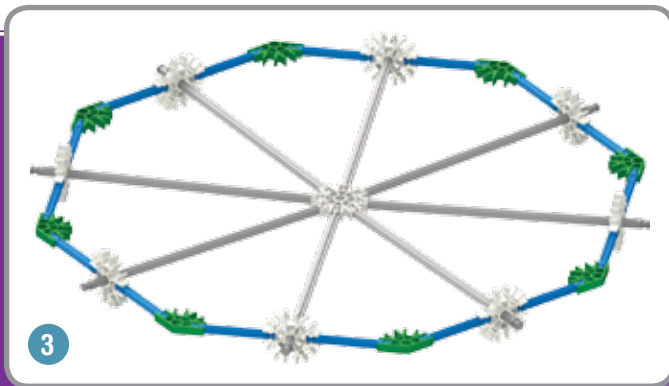
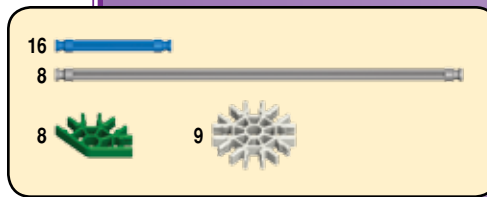
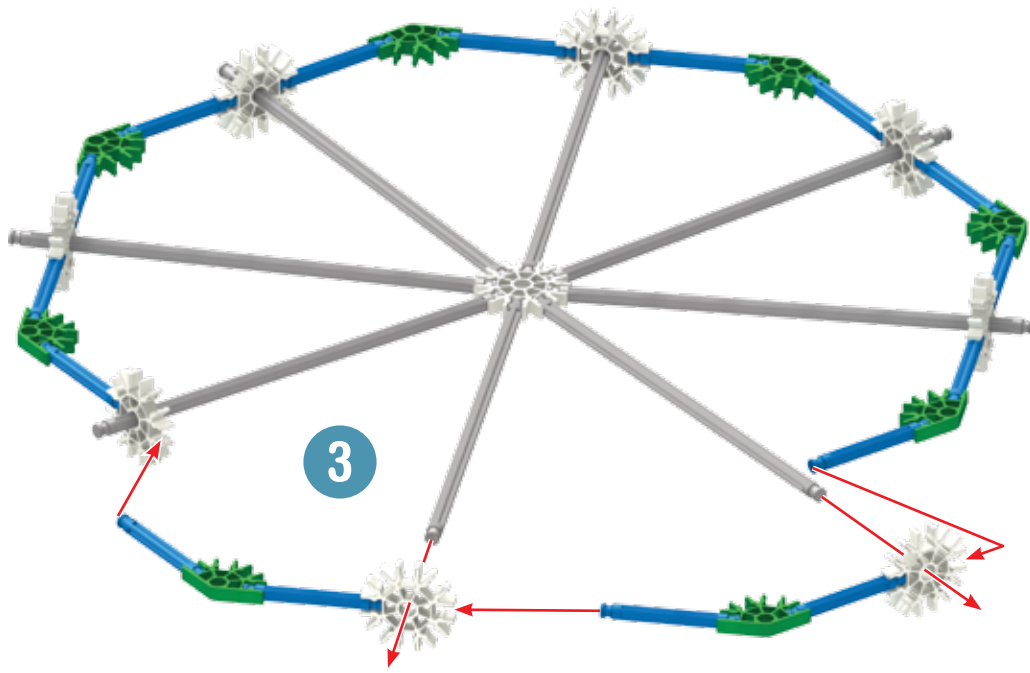

x4

6

16		8	
12		4	
12		4	

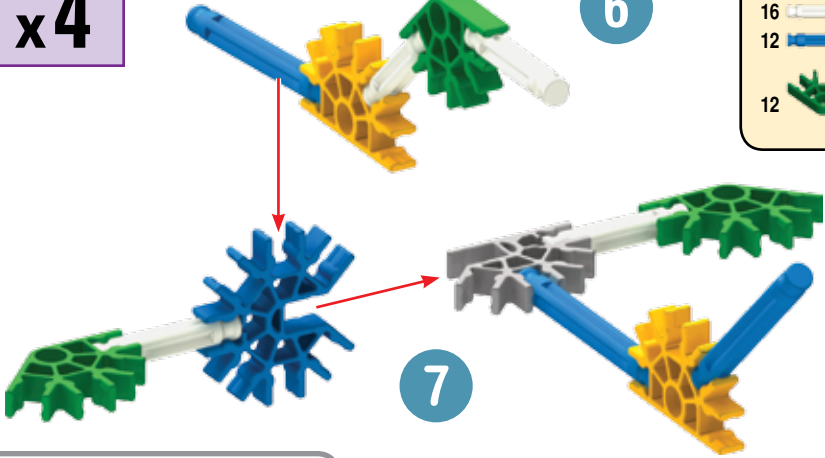

7

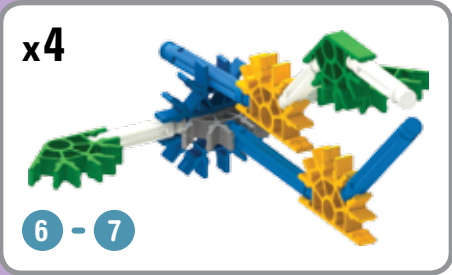

x4

6 - 7

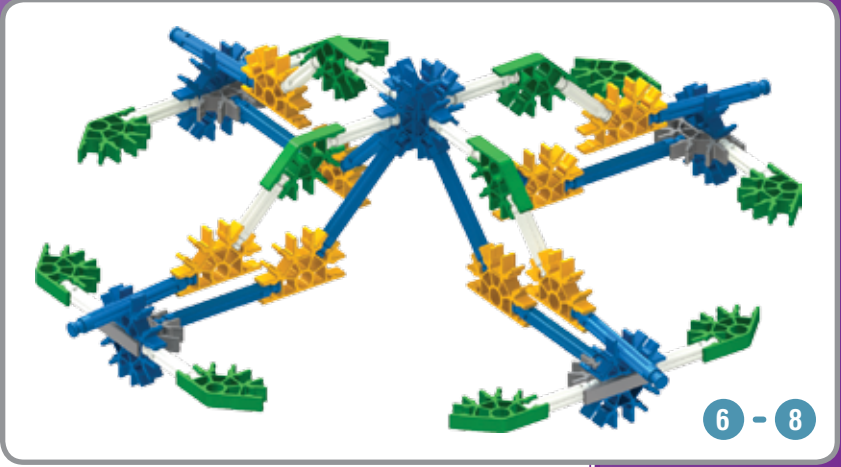

6 - 8

2

8

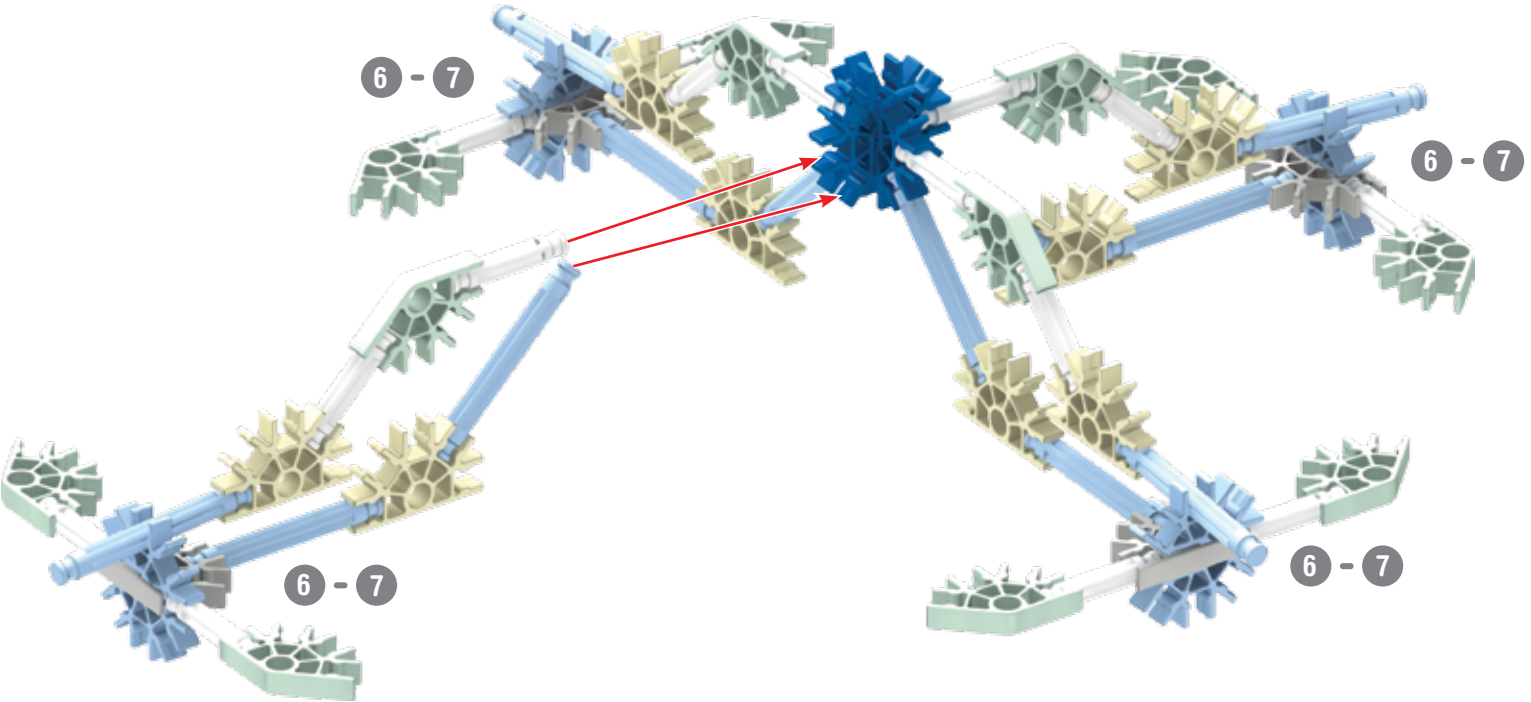

6 - 7

6 - 7

6 - 7

6 - 7



6 - 10

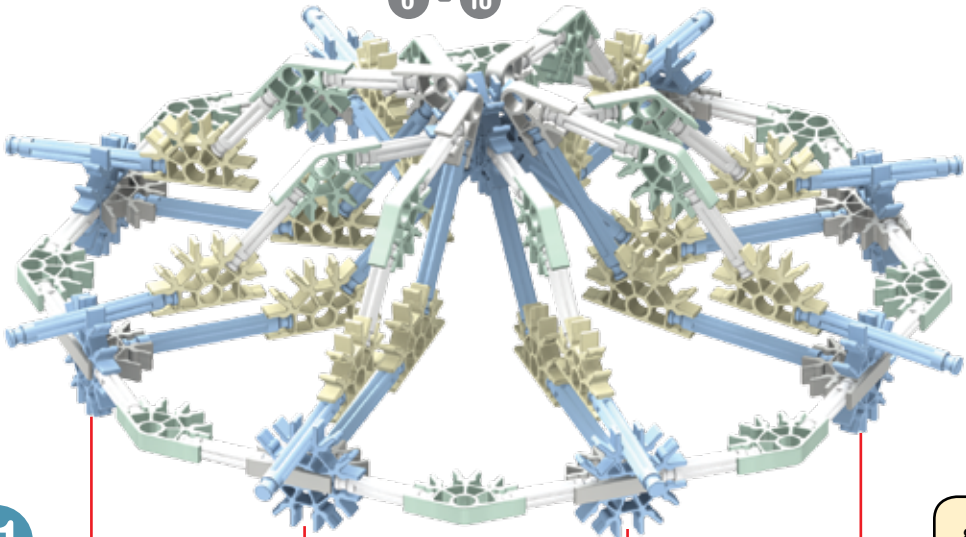

11

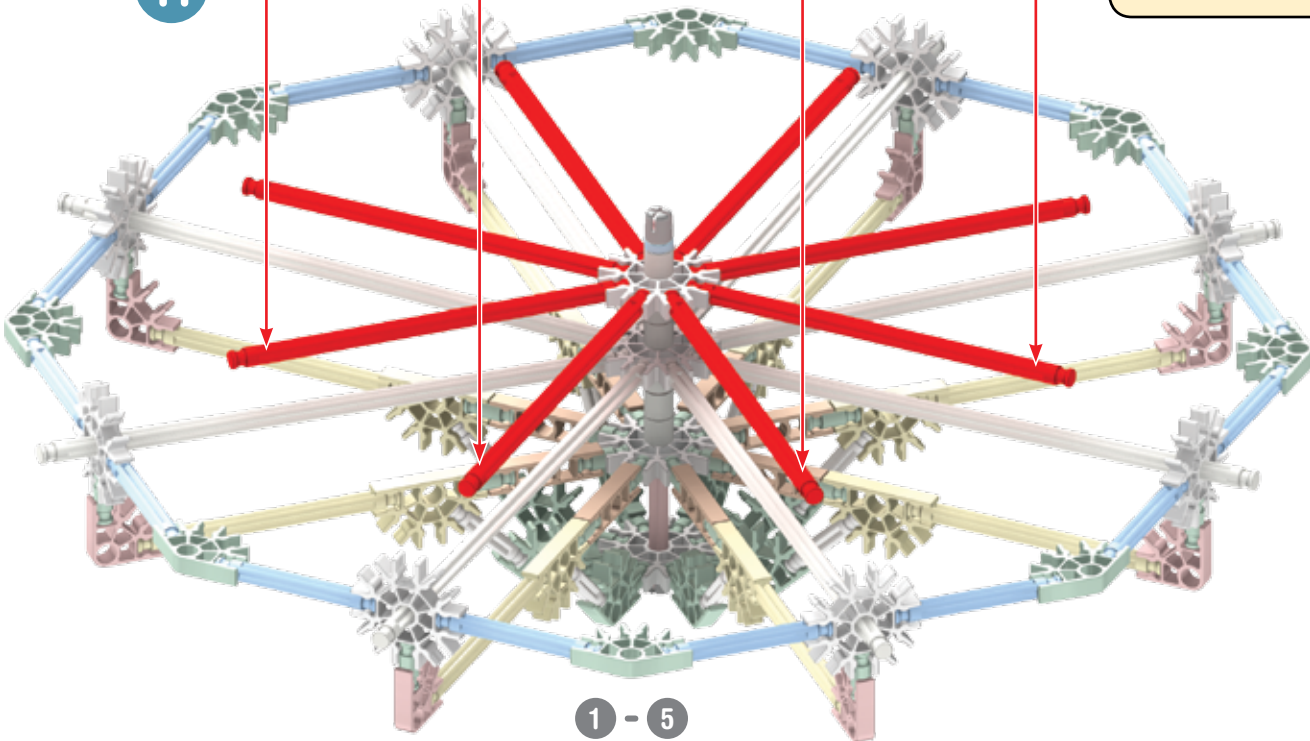

1 - 5



1 - 11

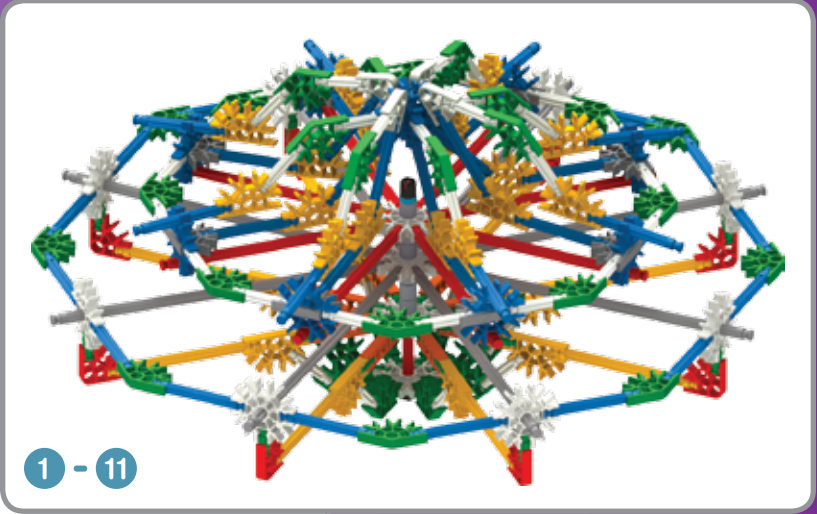

# Pod Spinner Radar tournant

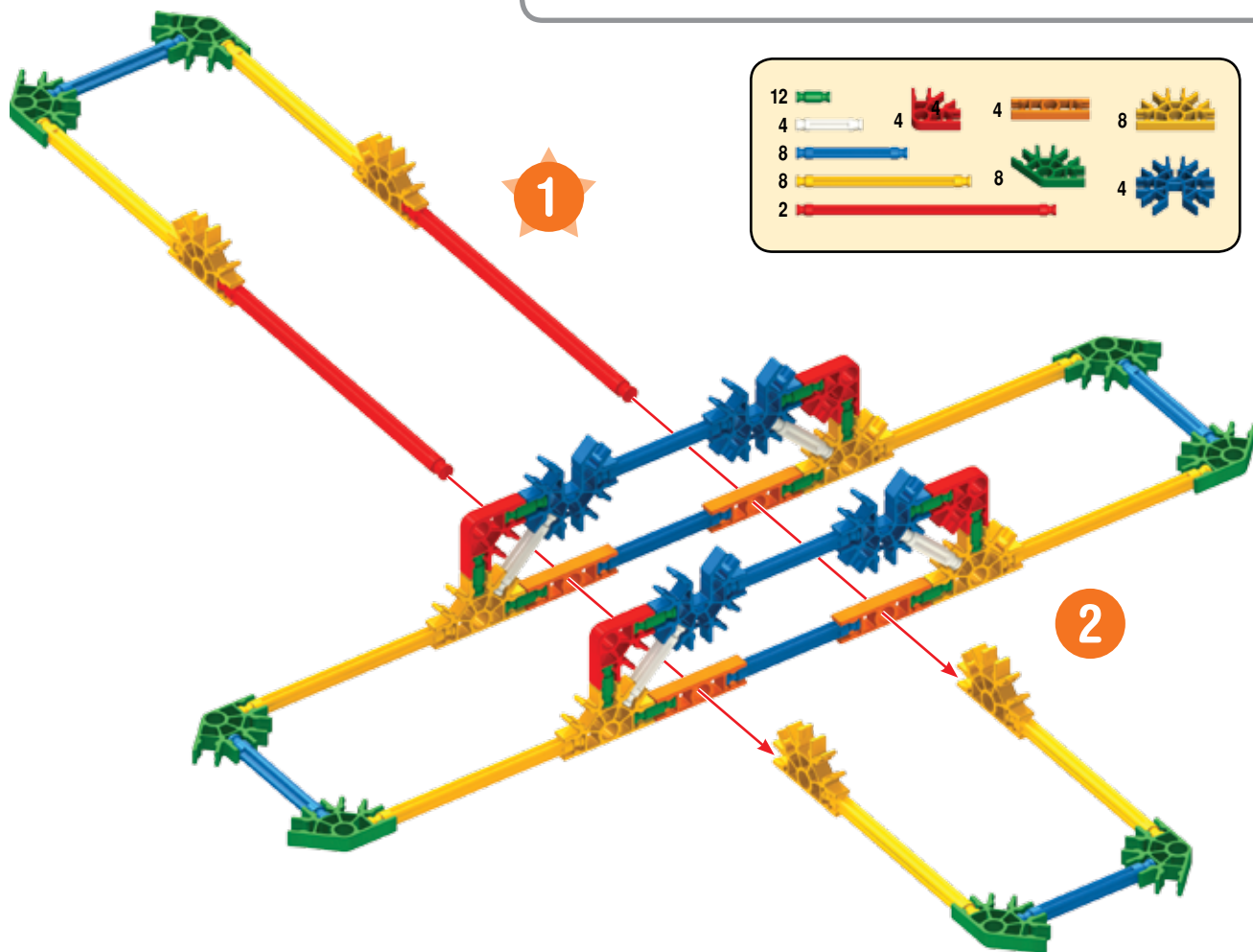
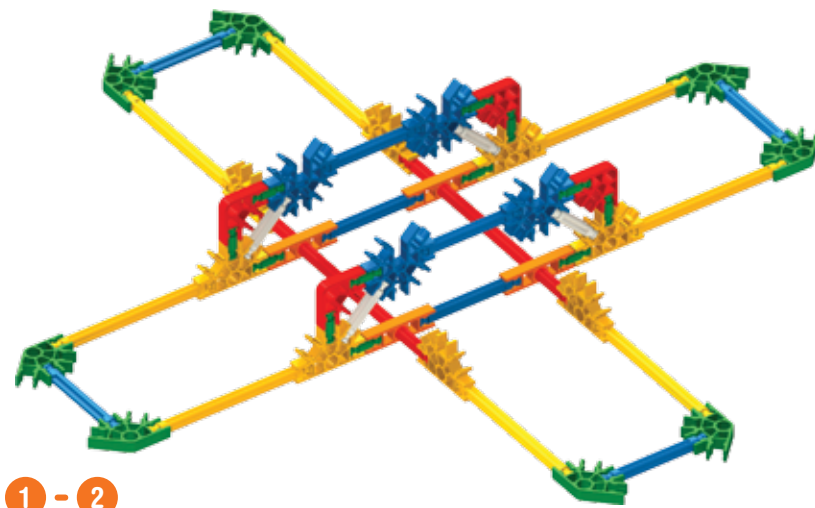
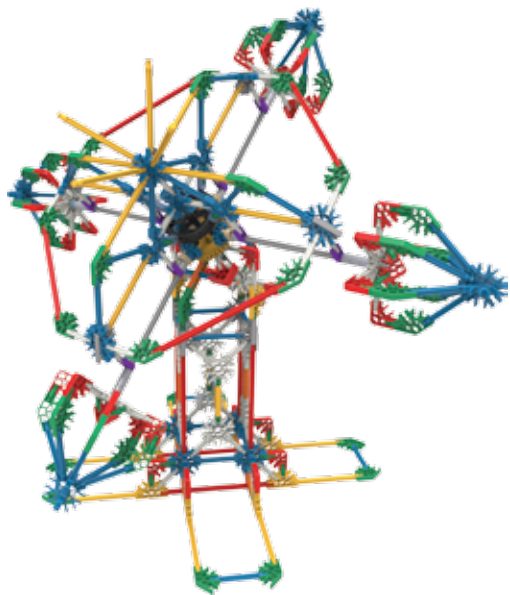

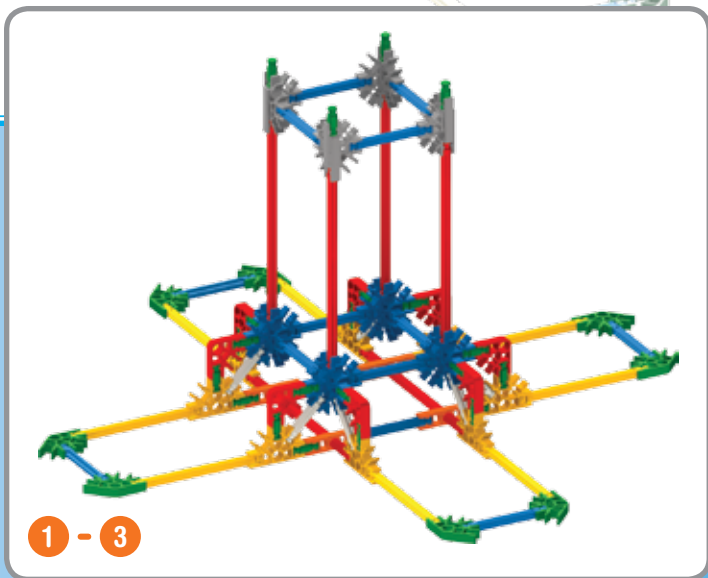
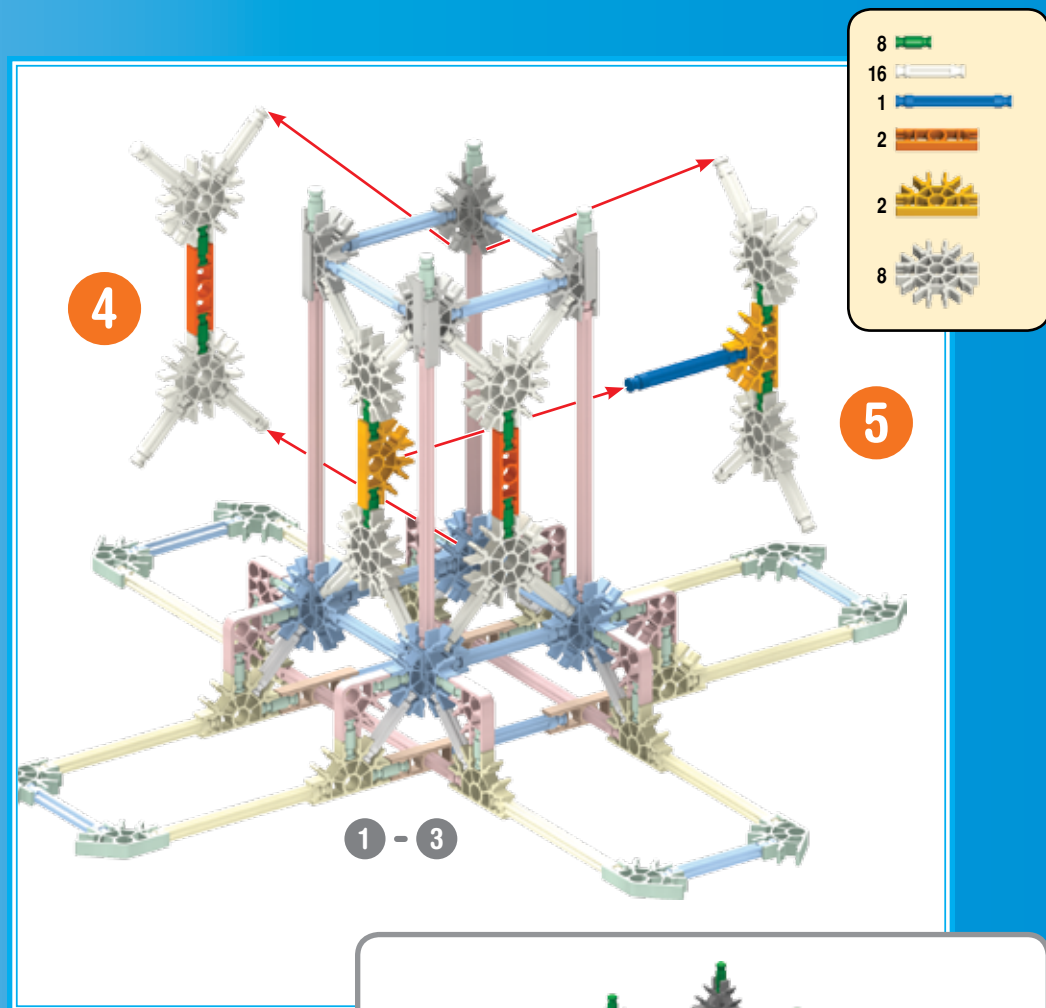
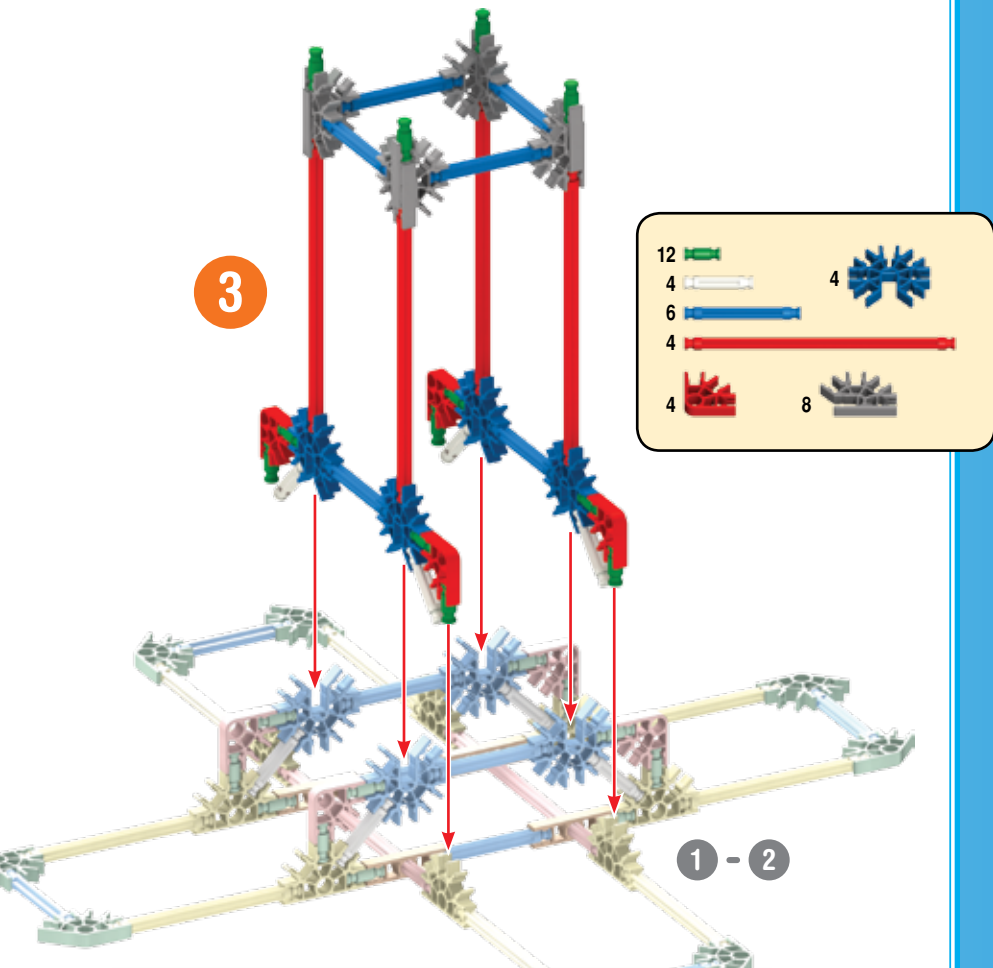

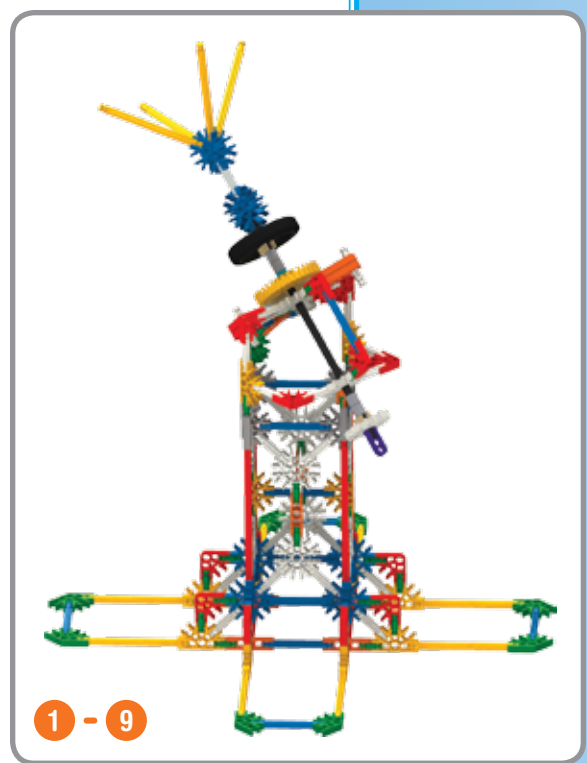
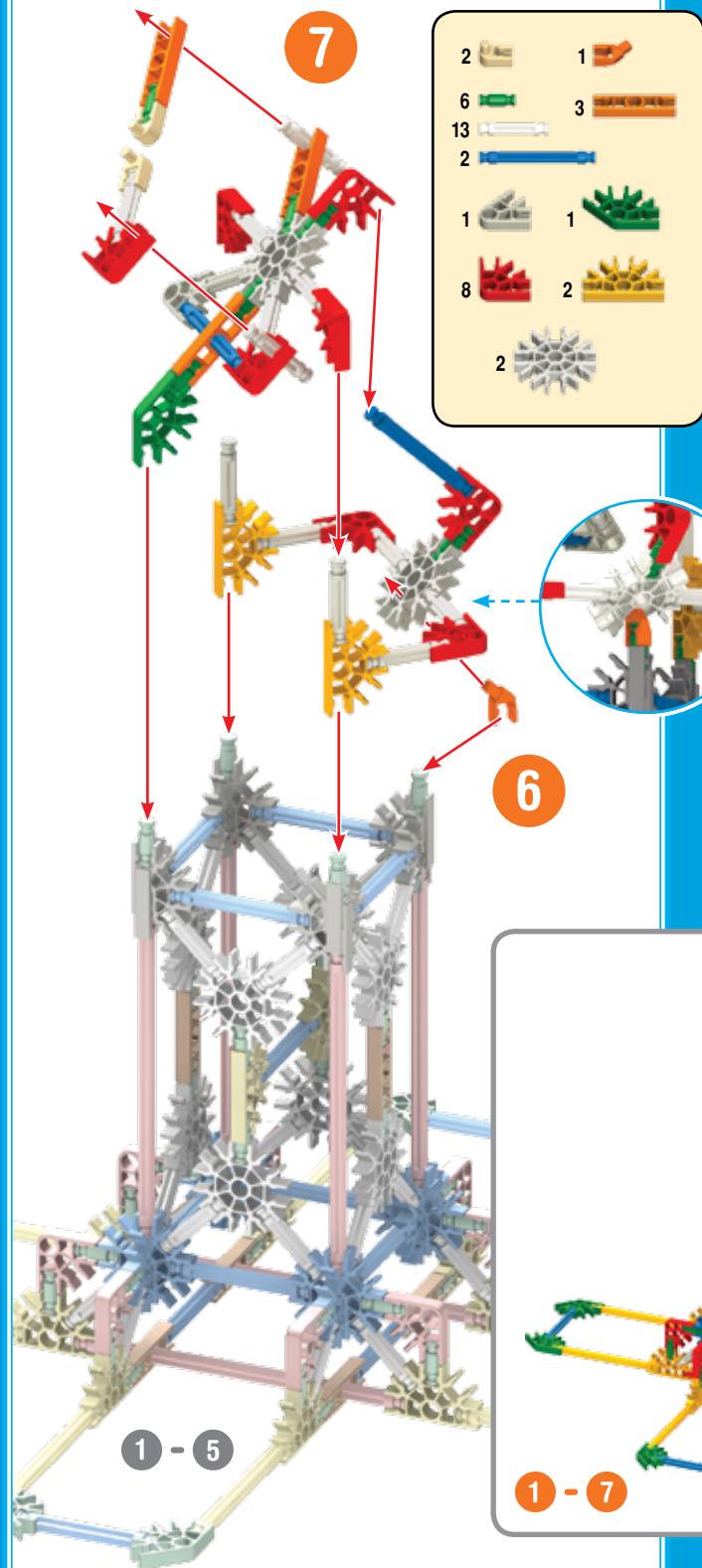

x4

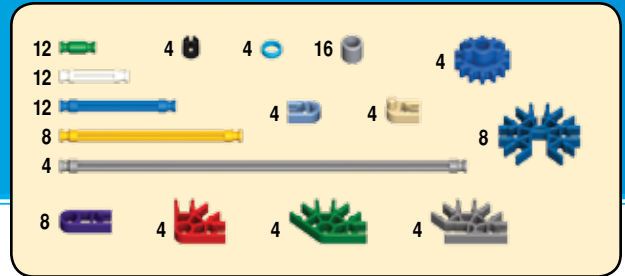
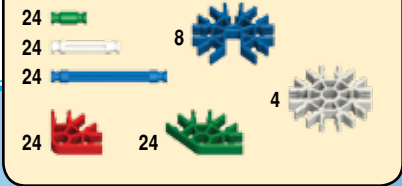
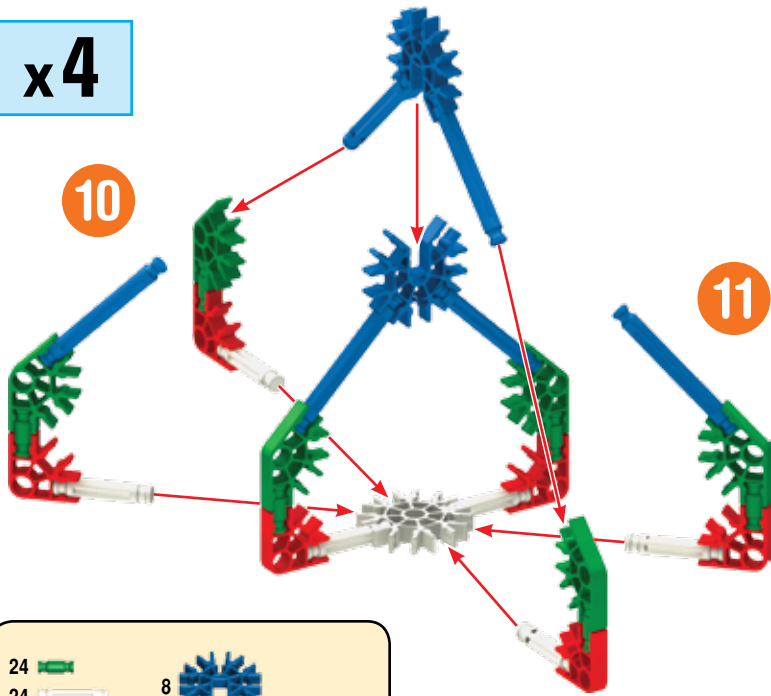

x4

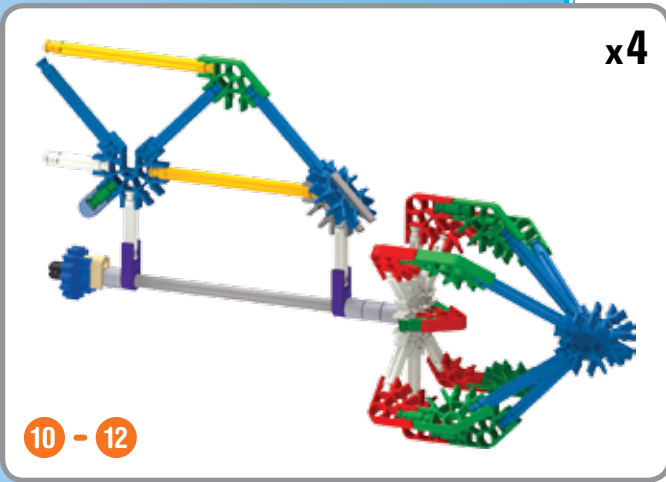
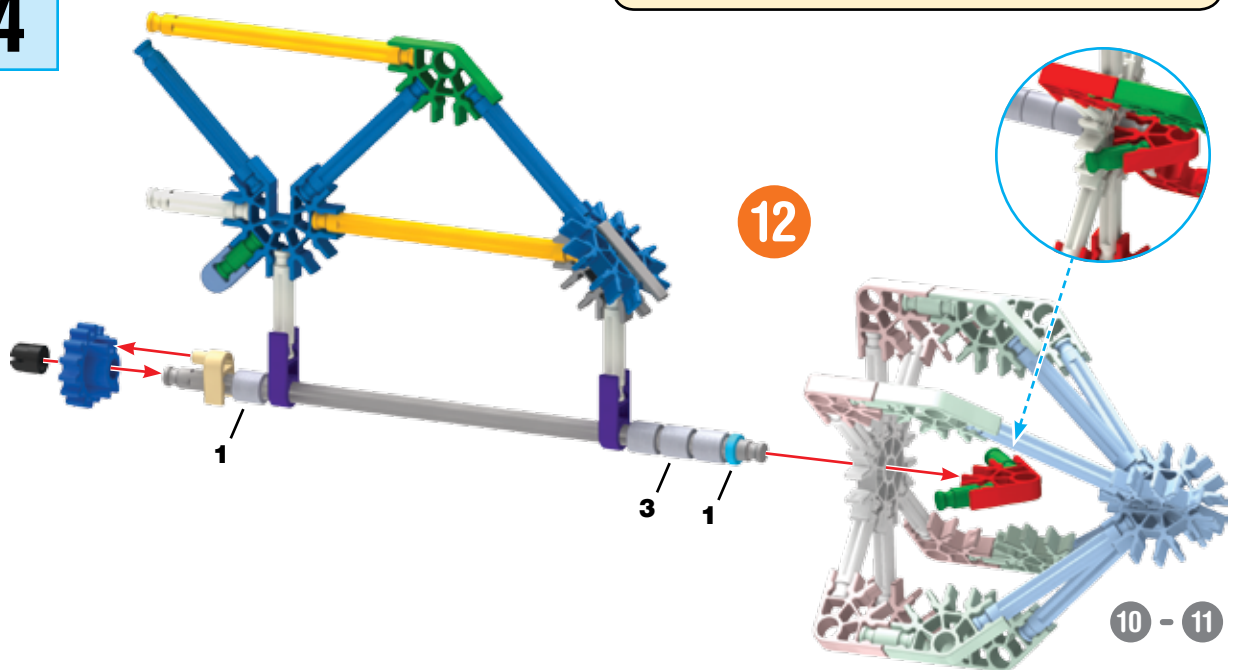

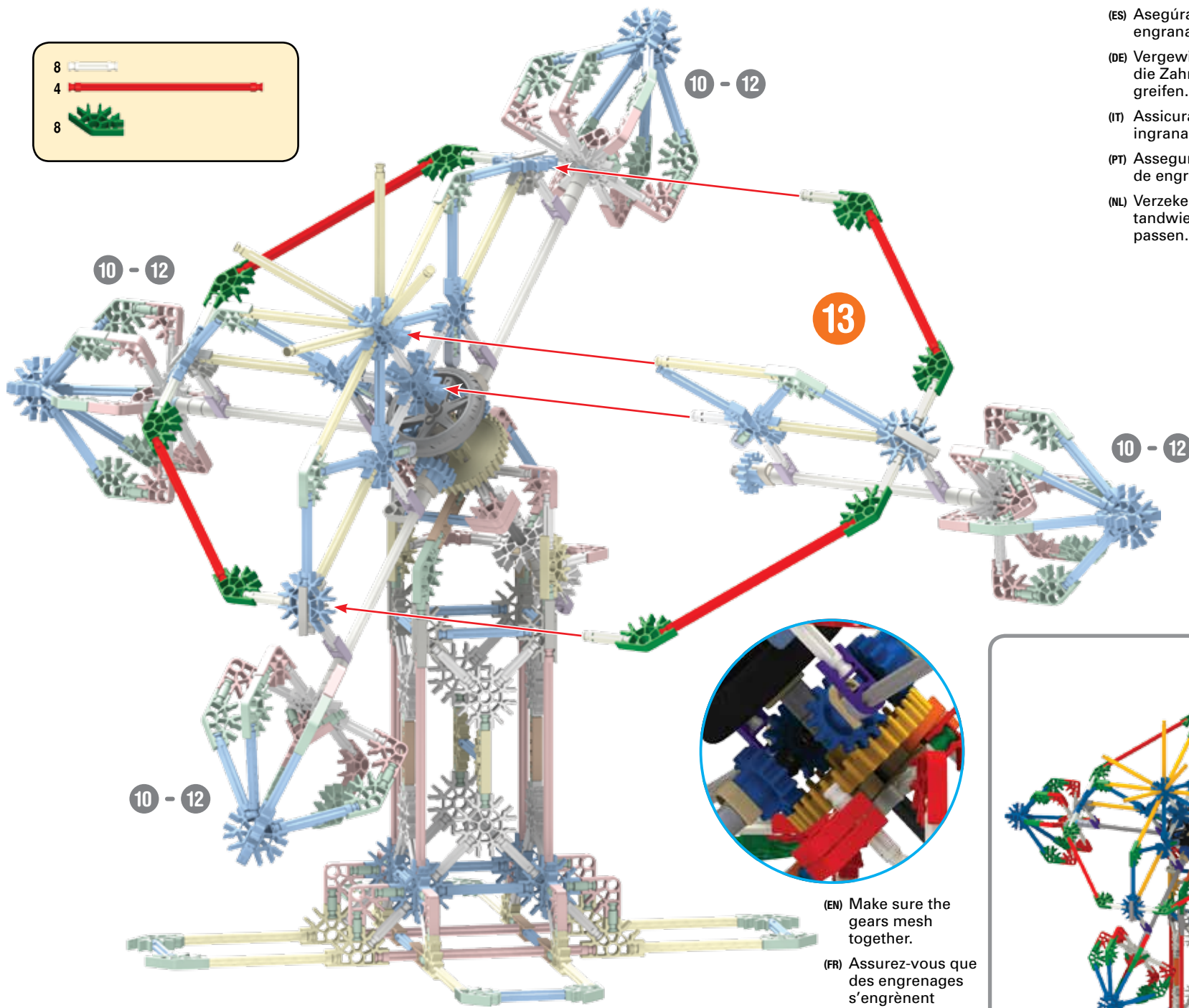
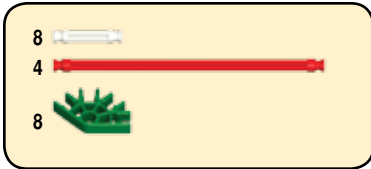

- (ES) Asegúrate de que los engranajes concuerdan.
- (DE) Vergewissere dich, dass die Zahnräder ineinander greifen.
- (IT) Assicurarsi gli ingranaggi ingranano.
- (PT) Assegure-se de que malha de engrenagens.
- (NL) Verzeker je ervan dat de tandwielen in mekaar passen.



- (EN) Make sure the gears mesh together.
- (FR) Assurez-vous que des engrenages s'engrènent correctement.

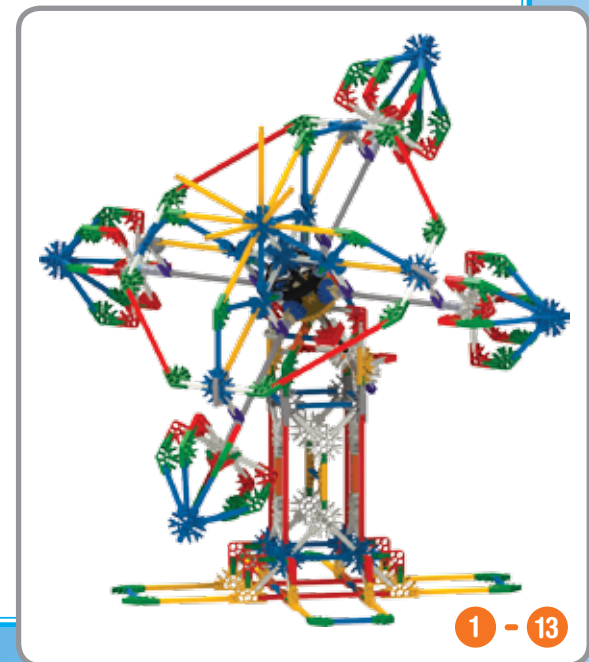

# Ambulance Ambulance

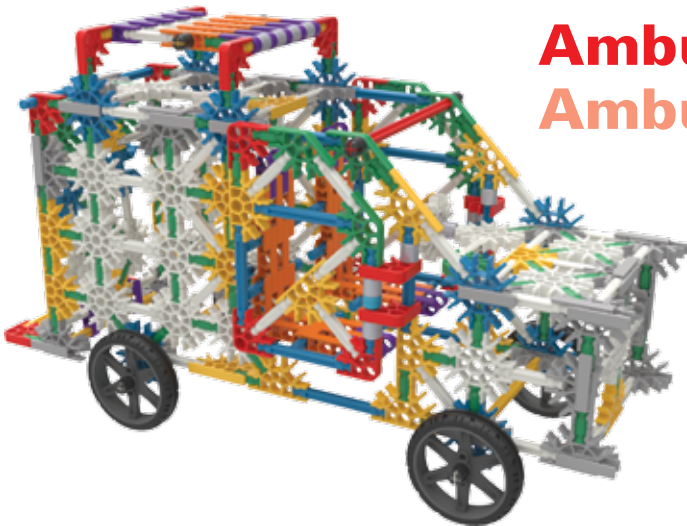

- 12 Green axle
- 6 White axle
- 2 Yellow axle
- 2 Grey axle
- 4 Yellow gear
- 2 Blue gear
- 4 White gear

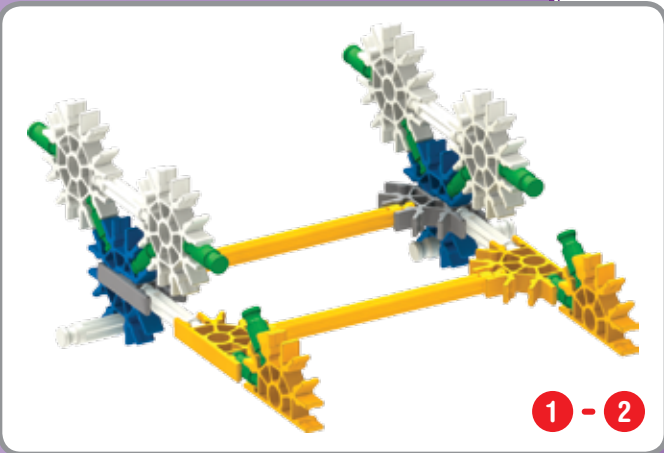
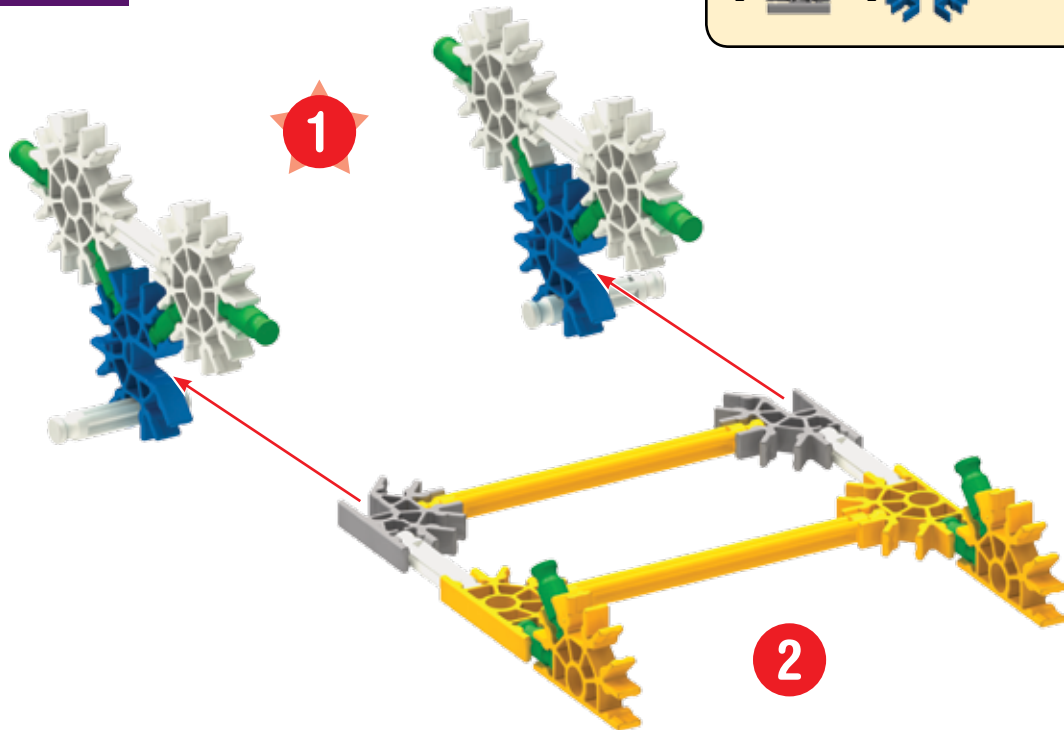

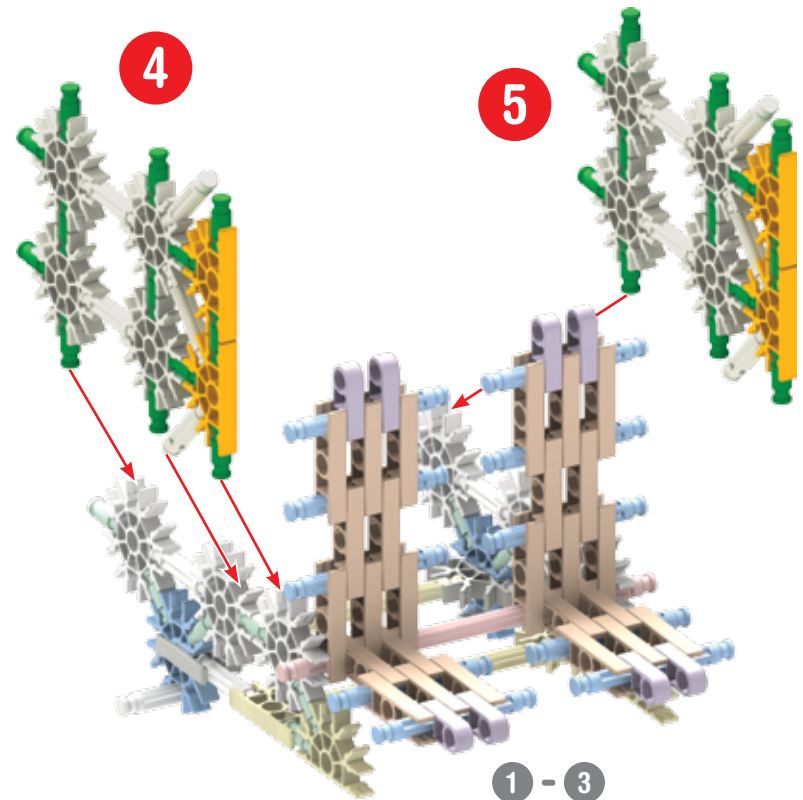
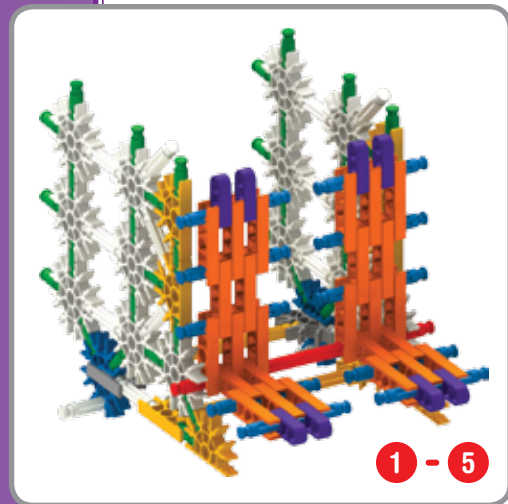
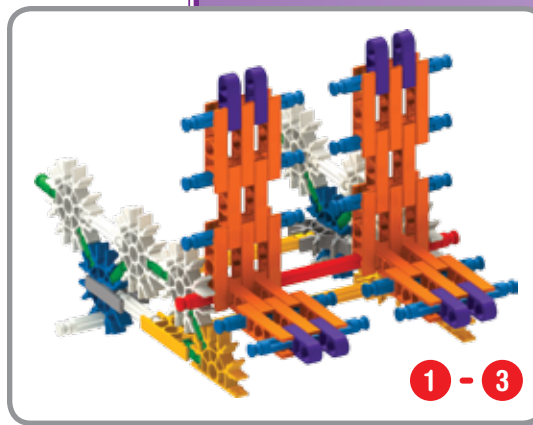
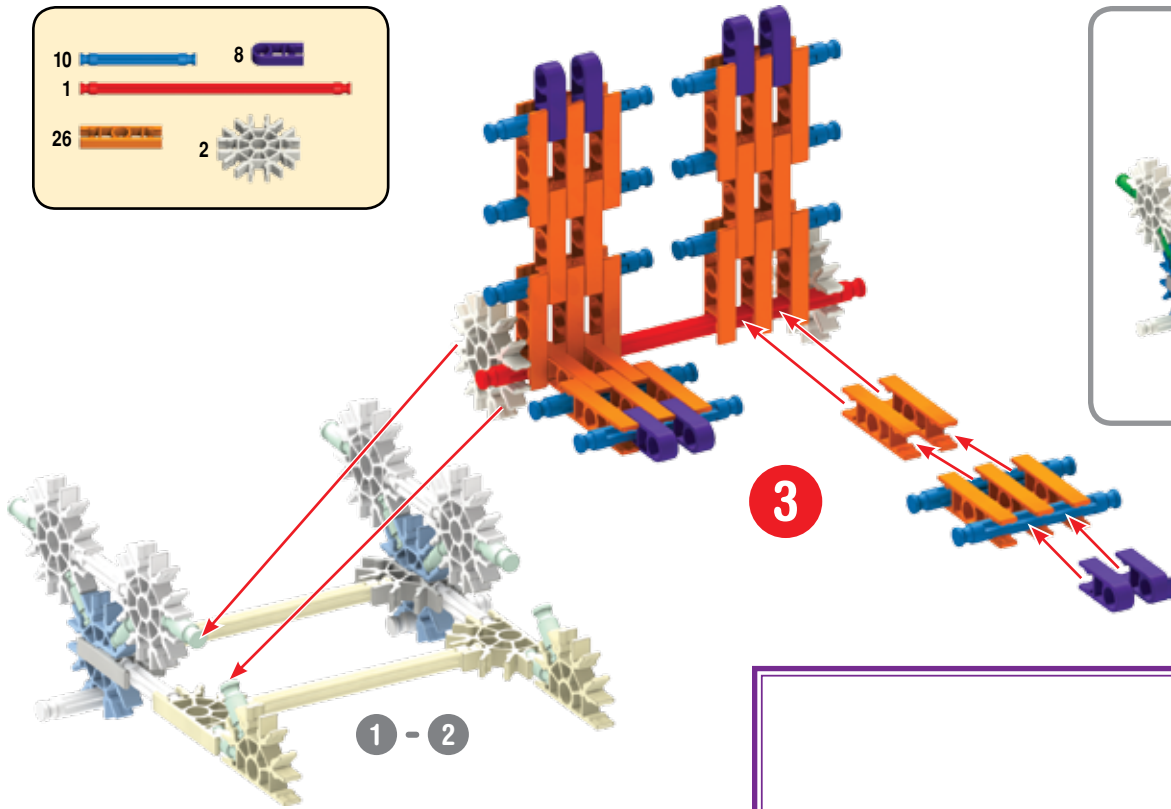
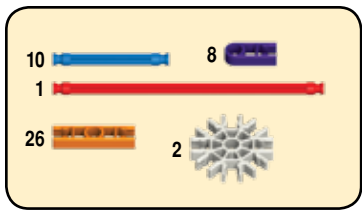

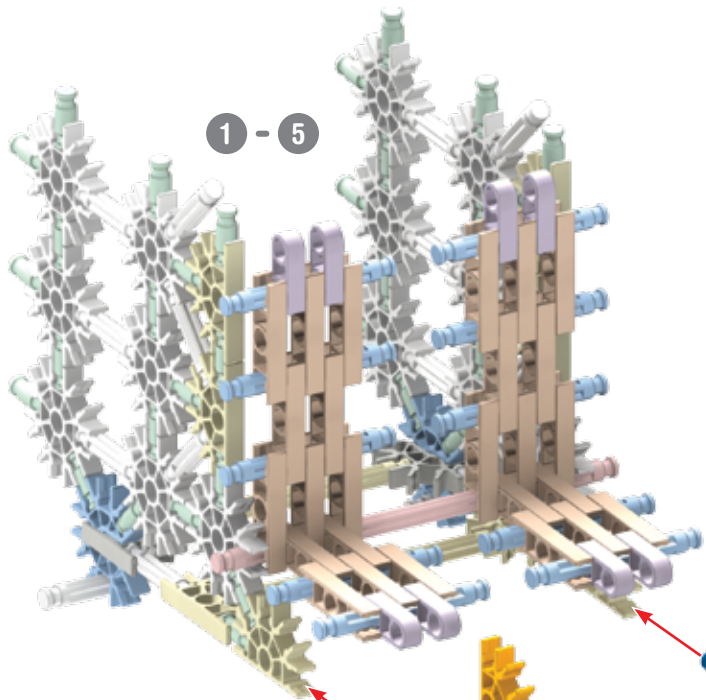

- |    |  |    |  |
|----|--|----|--|
| 16 |  | 5  |  |
| 12 |  | 3  |  |
| 2  |  | 2  |  |
| 1  |  | 10 |  |

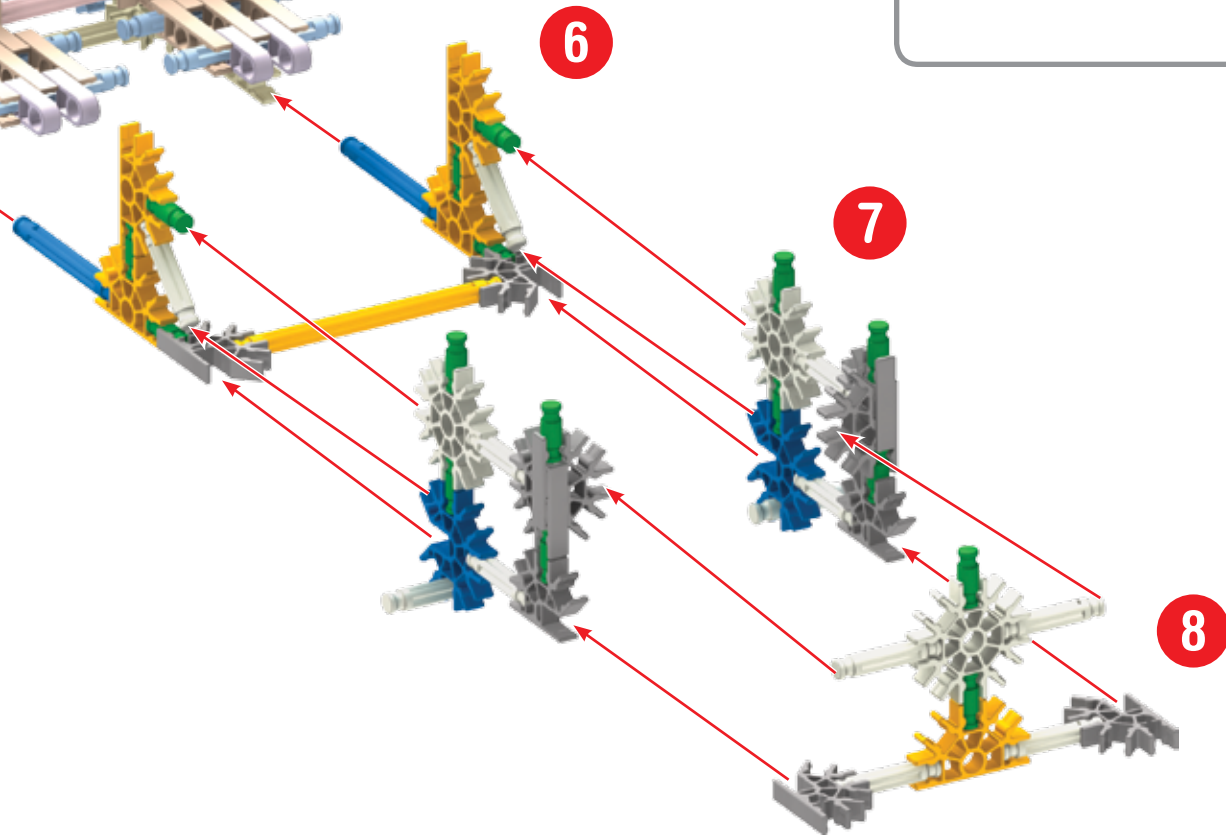
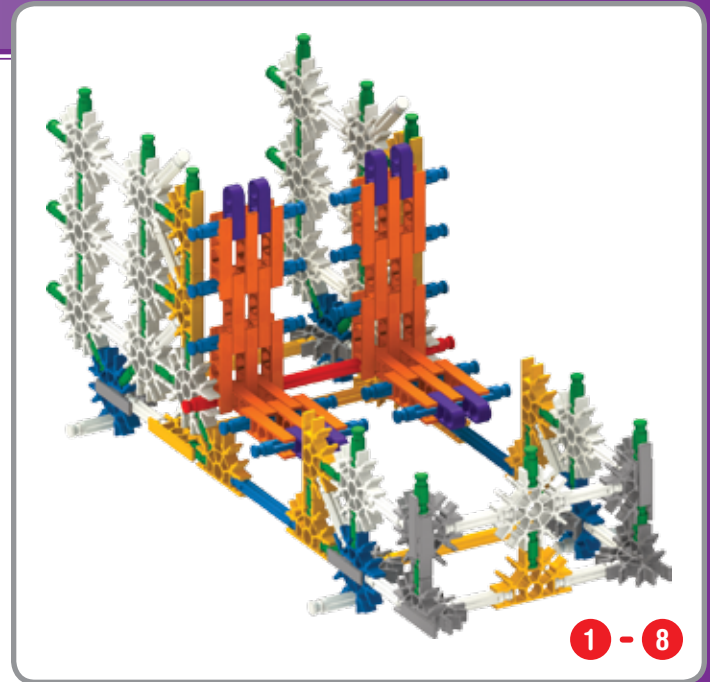

9

1	1	1	1
10	1	1	1
9	2	4	1
8	2	4	1

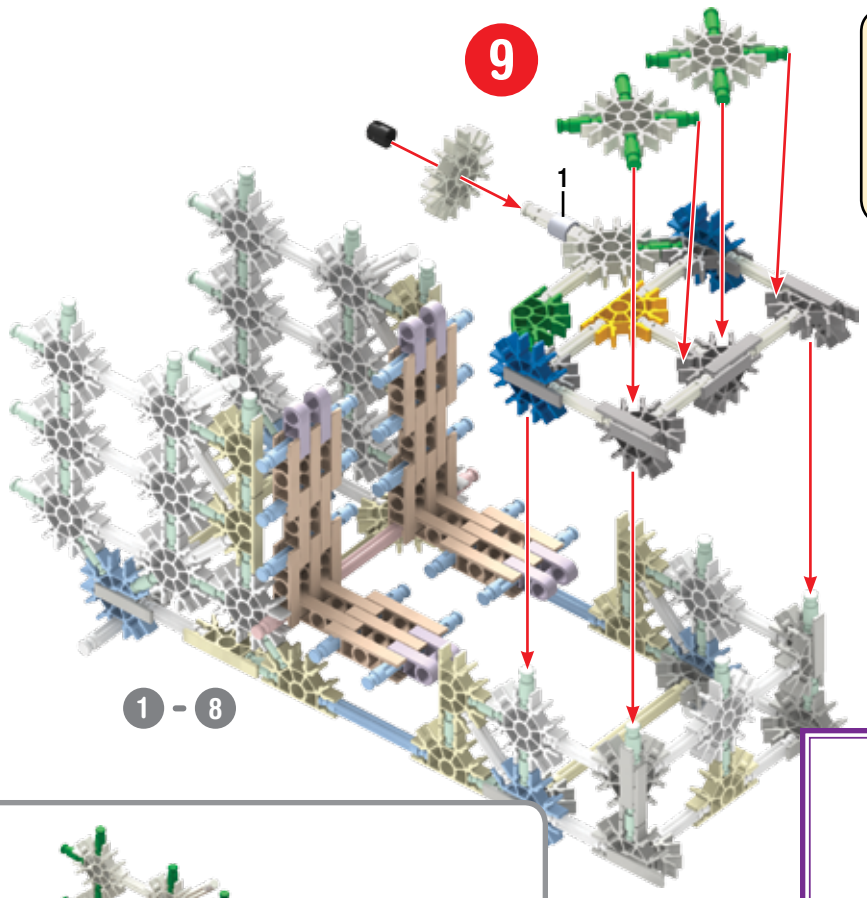

1 - 8



1 - 11

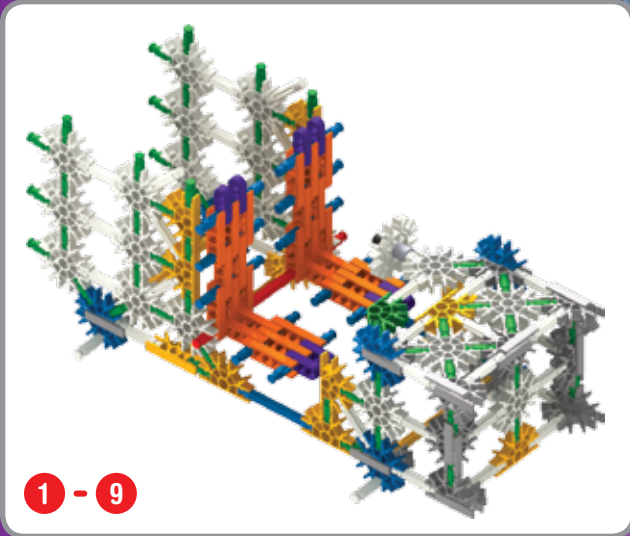

1 - 9



11

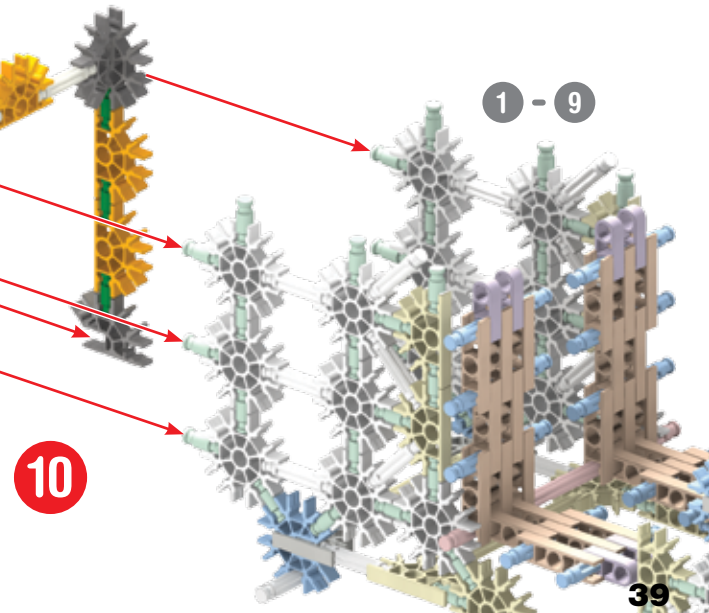

1 - 9

10

16	2	2	3
8	2	2	3
2	2	8	6
2	2	8	6

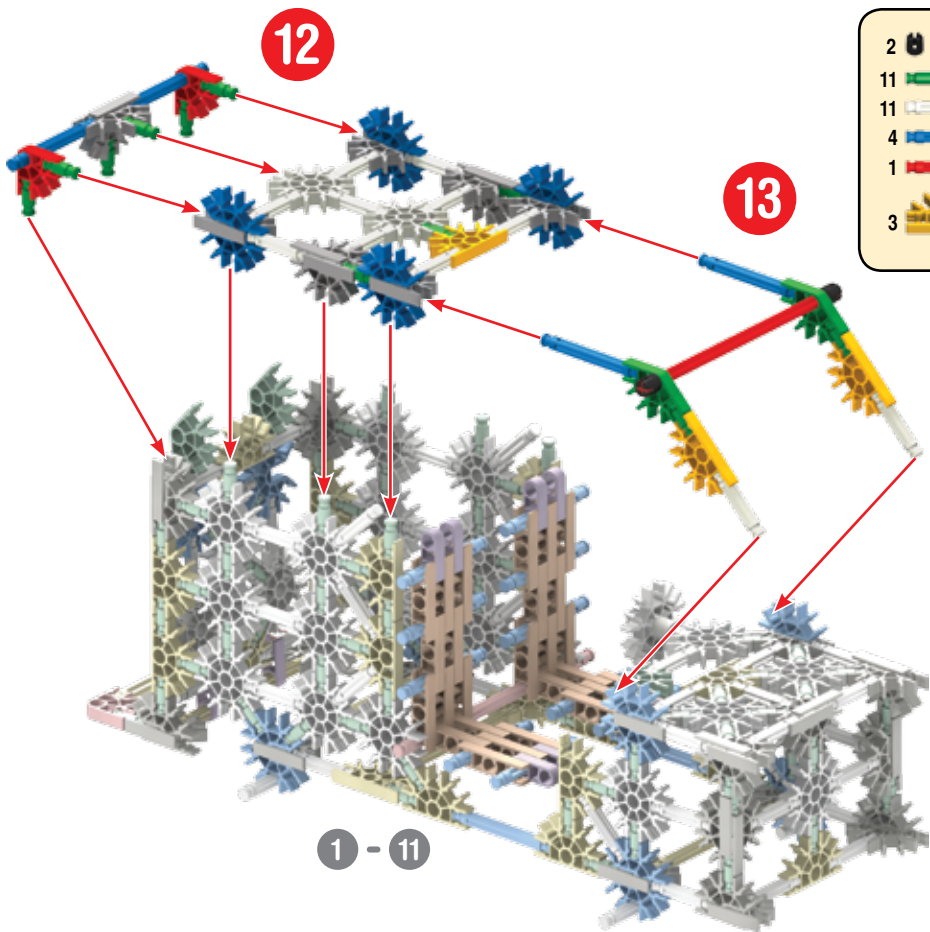

- 2
- 11
- 11
- 4
- 1
- 3
- 2
- 2
- 2
- 2
- 10
- 4

1 - 11

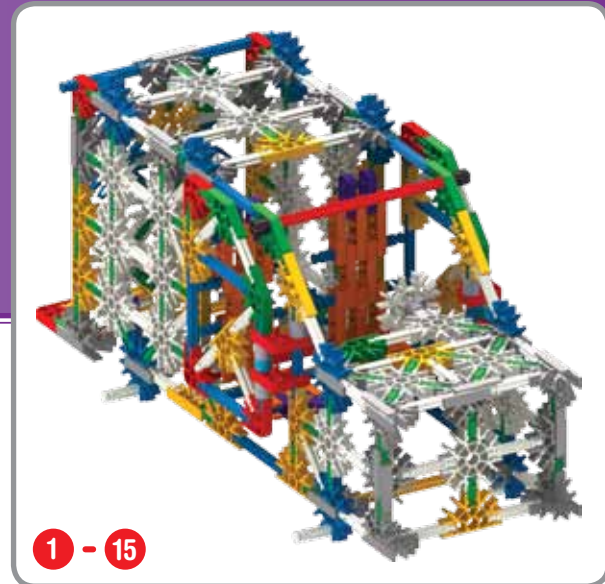

1 - 15

- 4
- 4
- 10
- 10
- 4
- 6
- 10
- 4

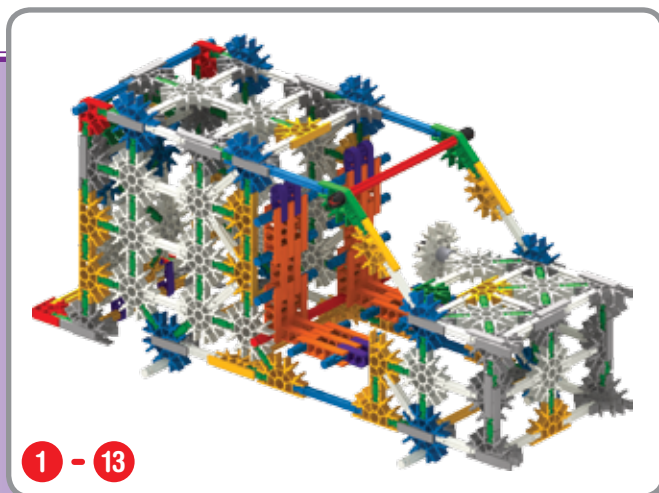

1 - 13

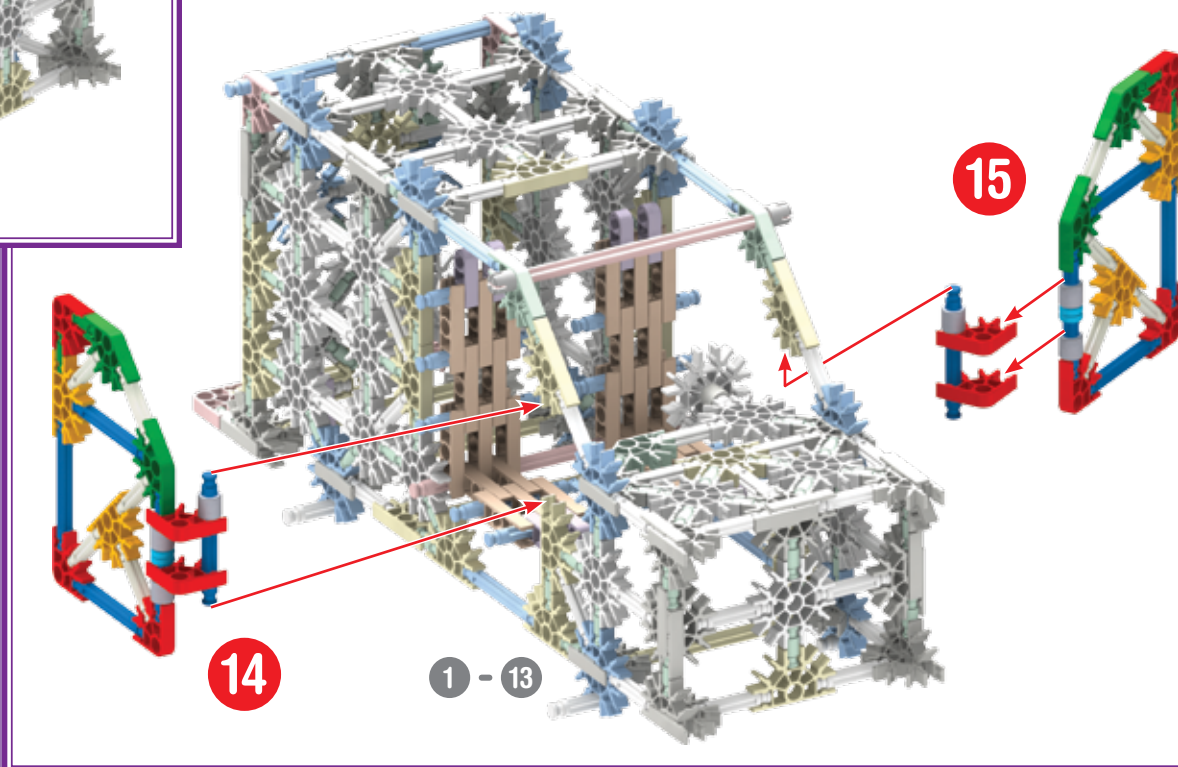

14

1 - 13

15

16

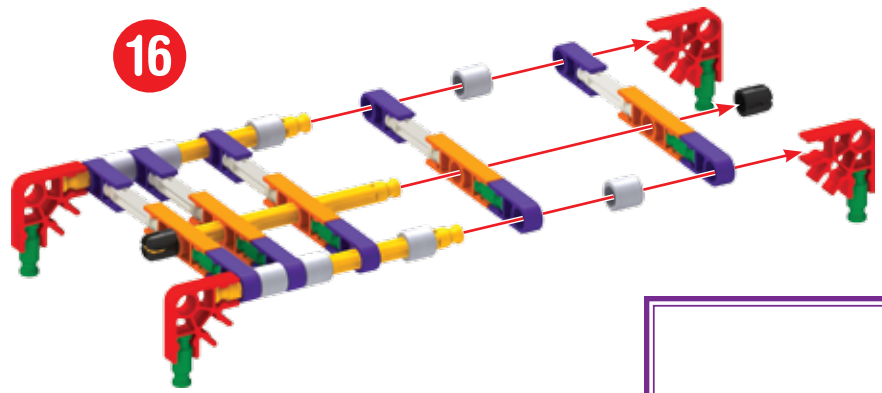

- 2 8
- 9
- 5
- 3
- 10
- 4
- 5

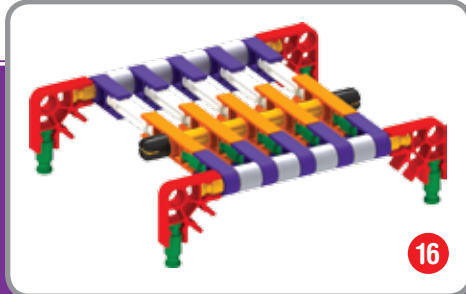

16



1 - 19

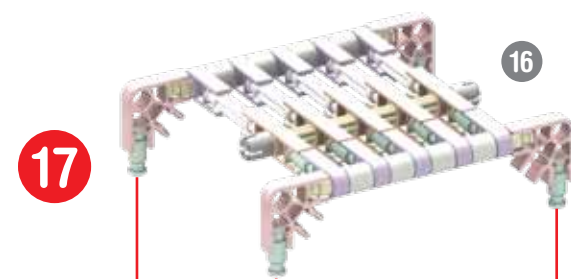

17

16

- 4
- 4
- 4
- 4

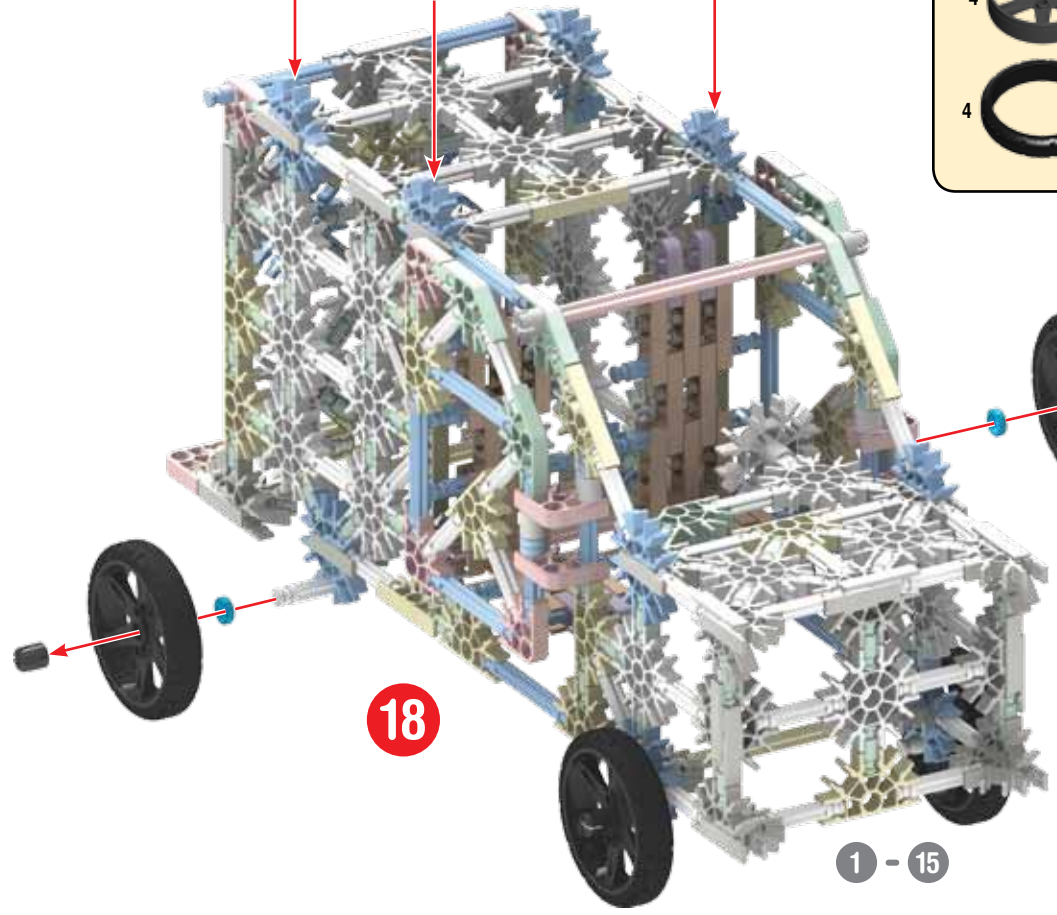

18

19

1 - 15

# Large Helicopter Grand hélicoptère

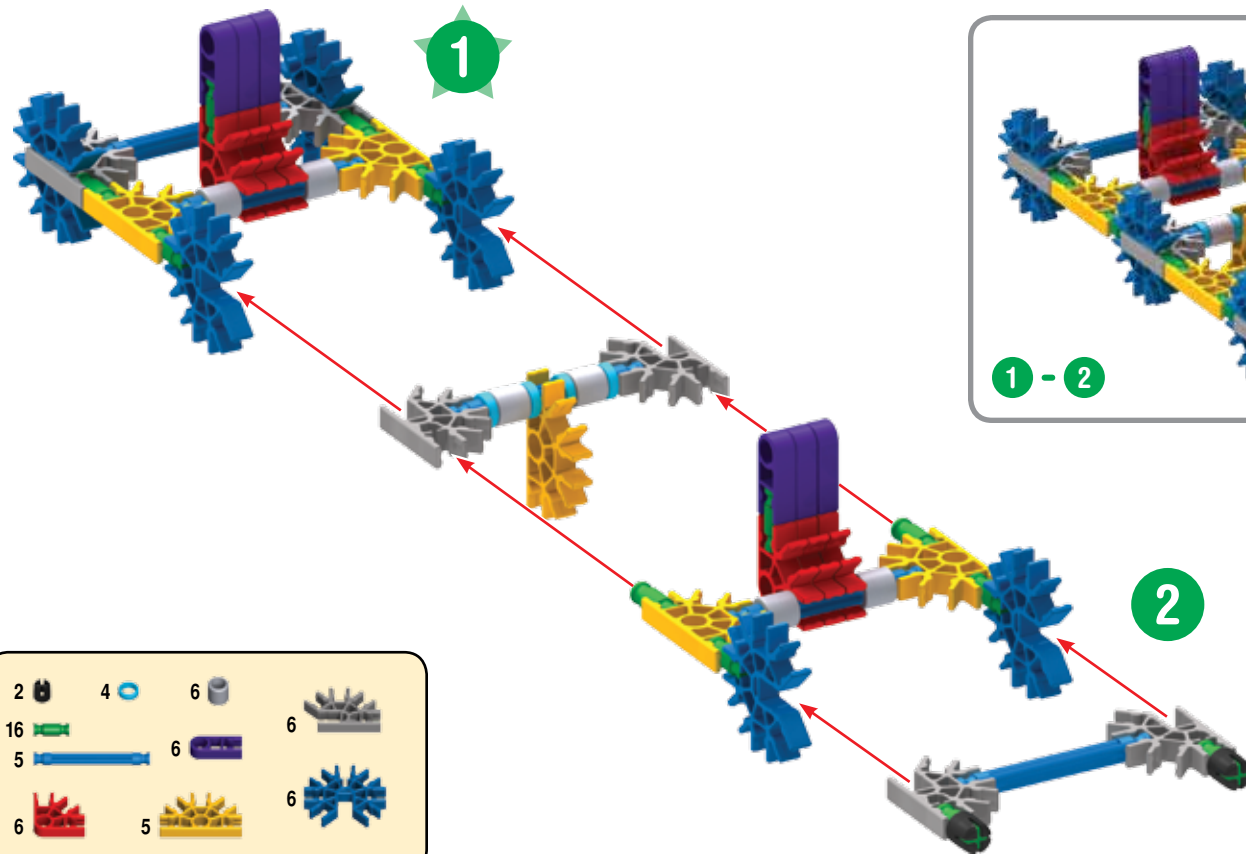

2	4	6	
16		6	6
5		5	6
6	5		6

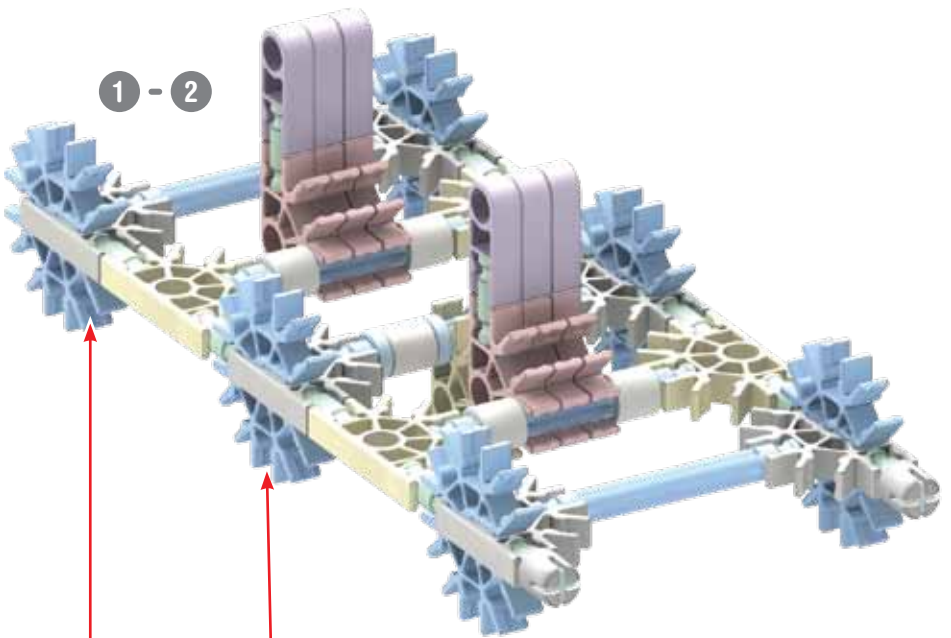

- |    |  |   |  |
|----|--|---|--|
| 4  |  | 8 |  |
| 12 |  |   |  |
| 4  |  |   |  |
| 1  |  |   |  |
| 2  |  | 2 |  |

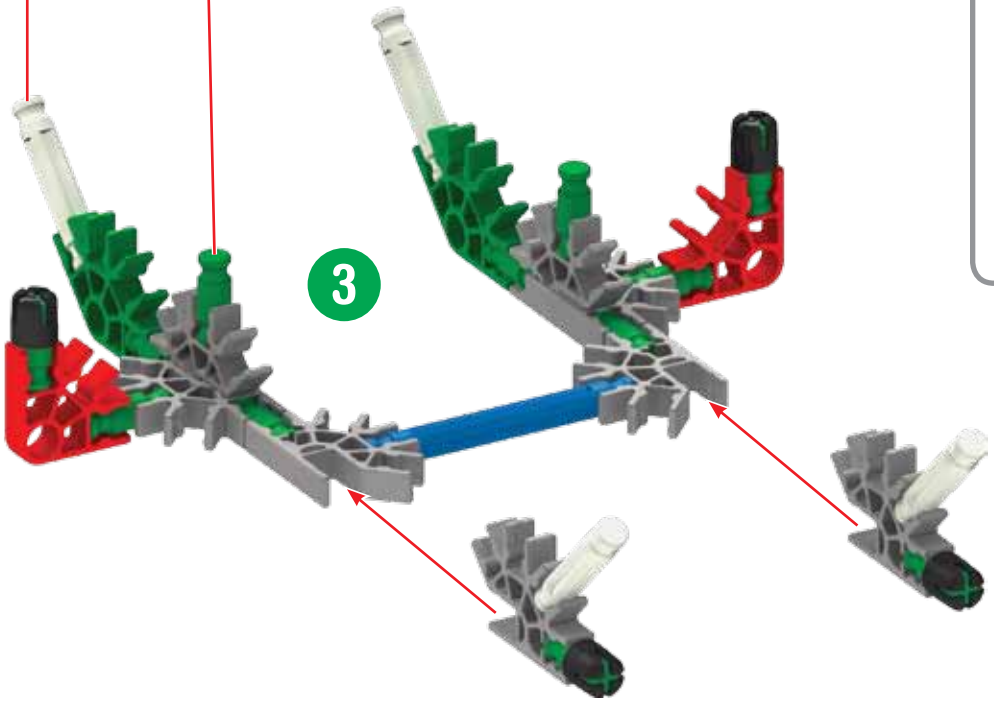

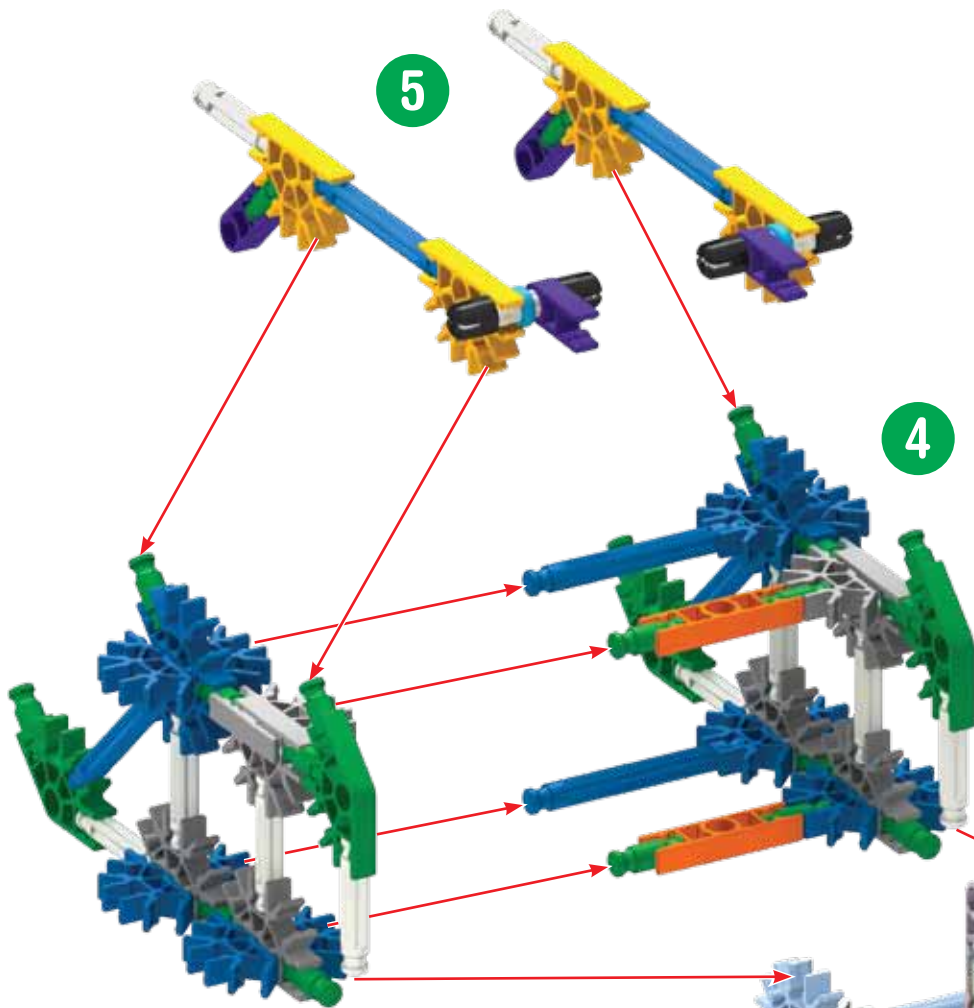

20		2		4		2	
12				4		4	
6							
4		8		8			

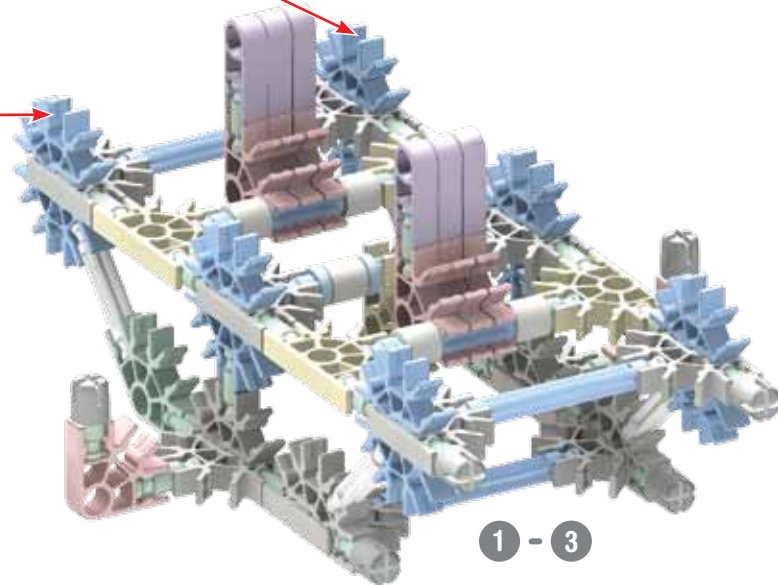

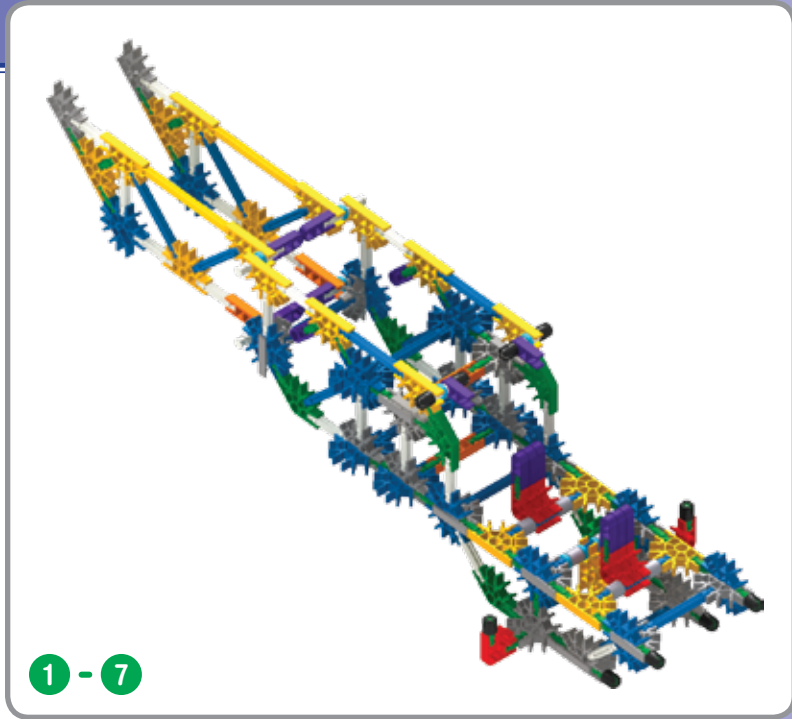
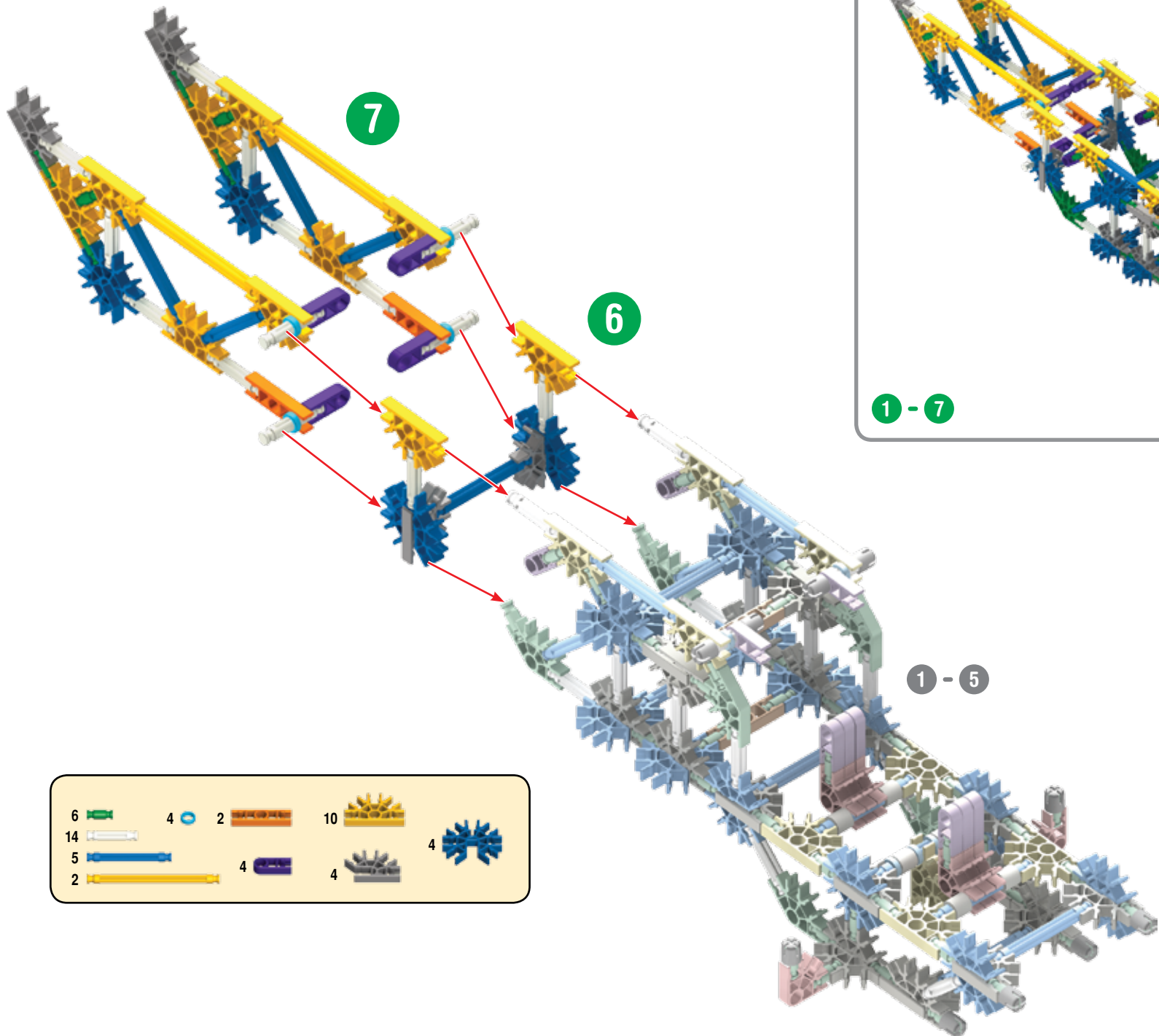

- |    |  |   |  |   |  |    |  |  |
|----|--|---|--|---|--|----|--|--|
| 6  |  | 4 |  | 2 |  | 10 |  |  |
| 14 |  |   |  |   |  |    |  |  |
| 5  |  | 4 |  | 4 |  |    |  |  |
| 2  |  |   |  |   |  |    |  |  |

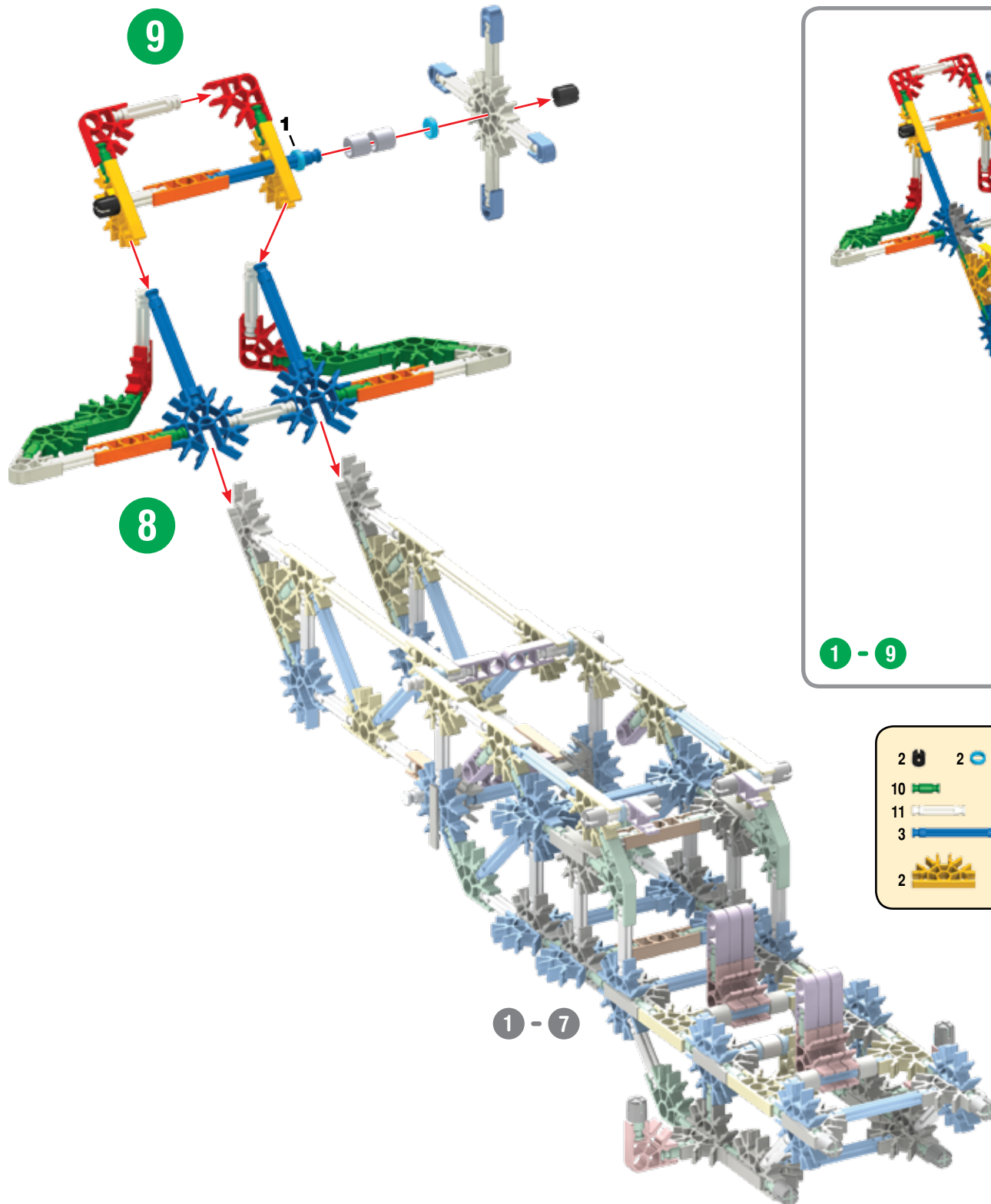

- |    |   |   |   |   |
|----|---|---|---|---|
| 2  | 2 | 2 | 2 | 3 |
| 10 |   | 4 | 4 | 4 |
| 11 |   |   |   |   |
| 3  |   | 2 | 1 |   |
| 2  |   |   |   |   |

1 - 7

1 - 9

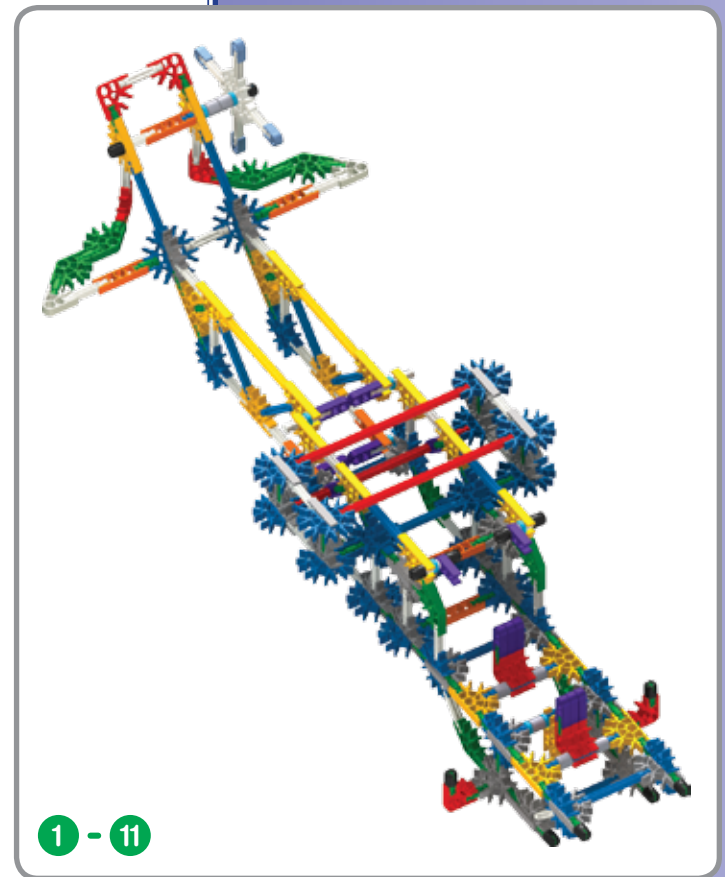
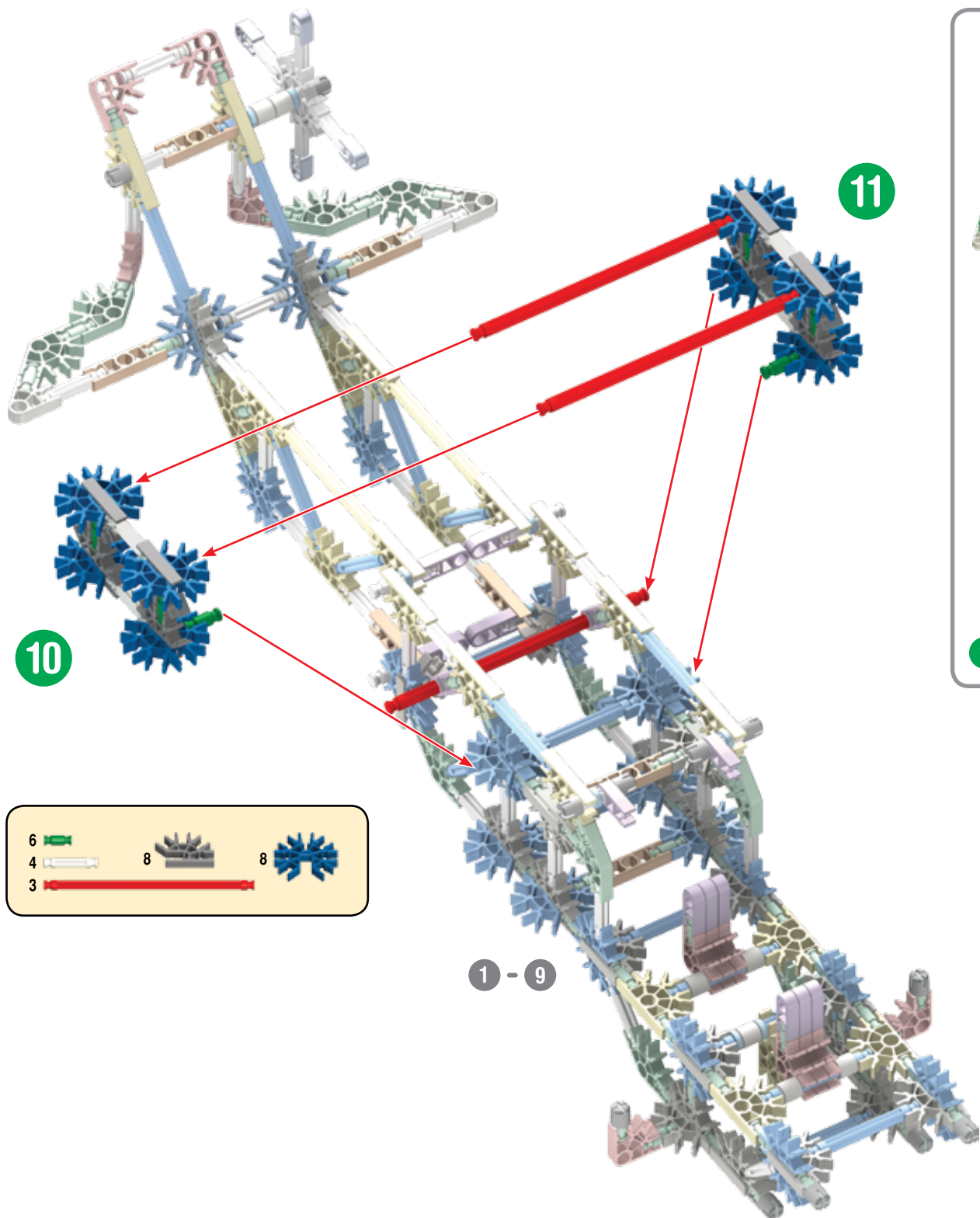

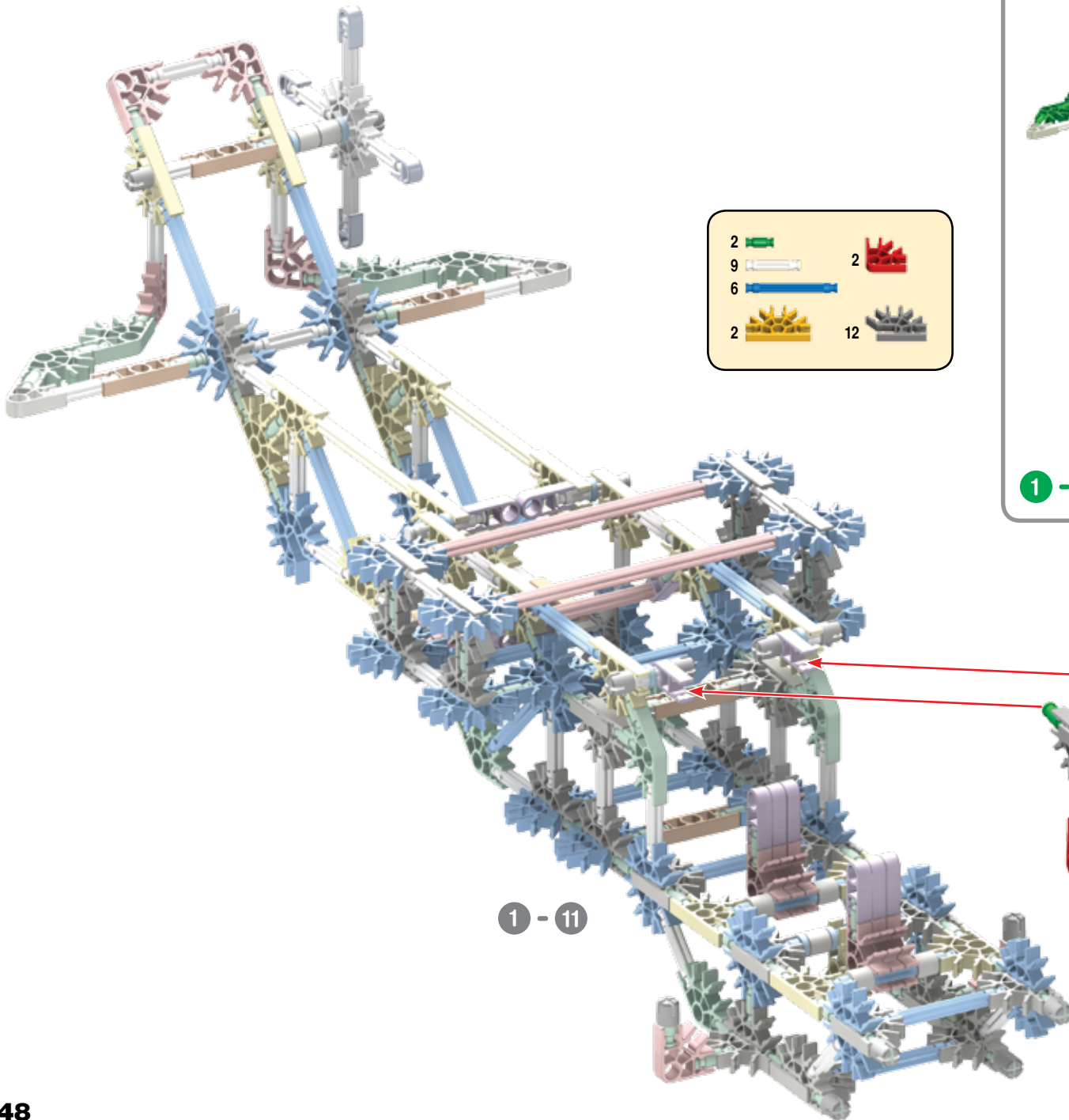

- |   |  |    |  |
|---|--|----|--|
| 2 |  | 2  |  |
| 9 |  |    |  |
| 6 |  | 12 |  |
| 2 |  |    |  |

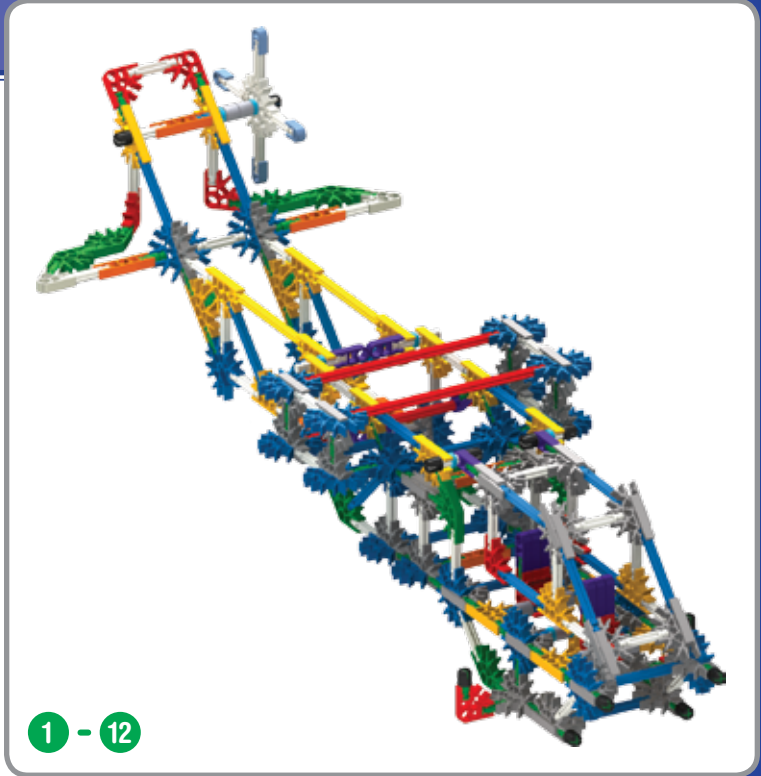

1 - 12

12

1 - 11

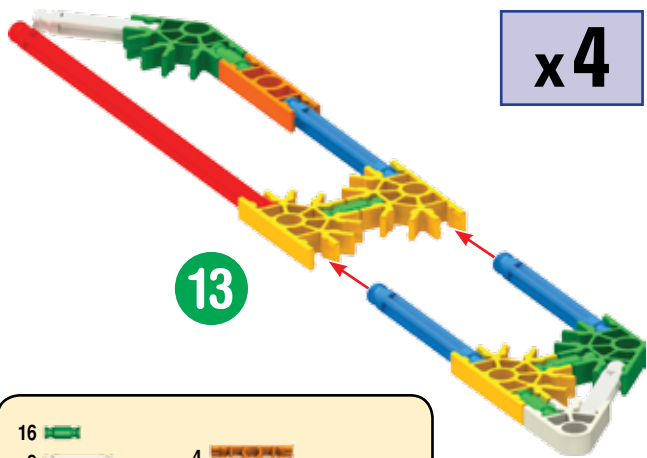

x4

13

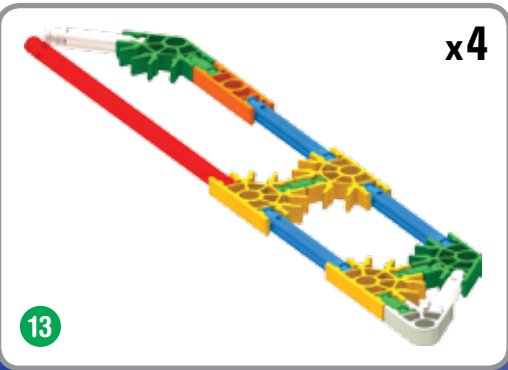
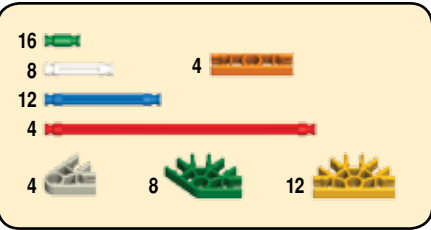

x4

13

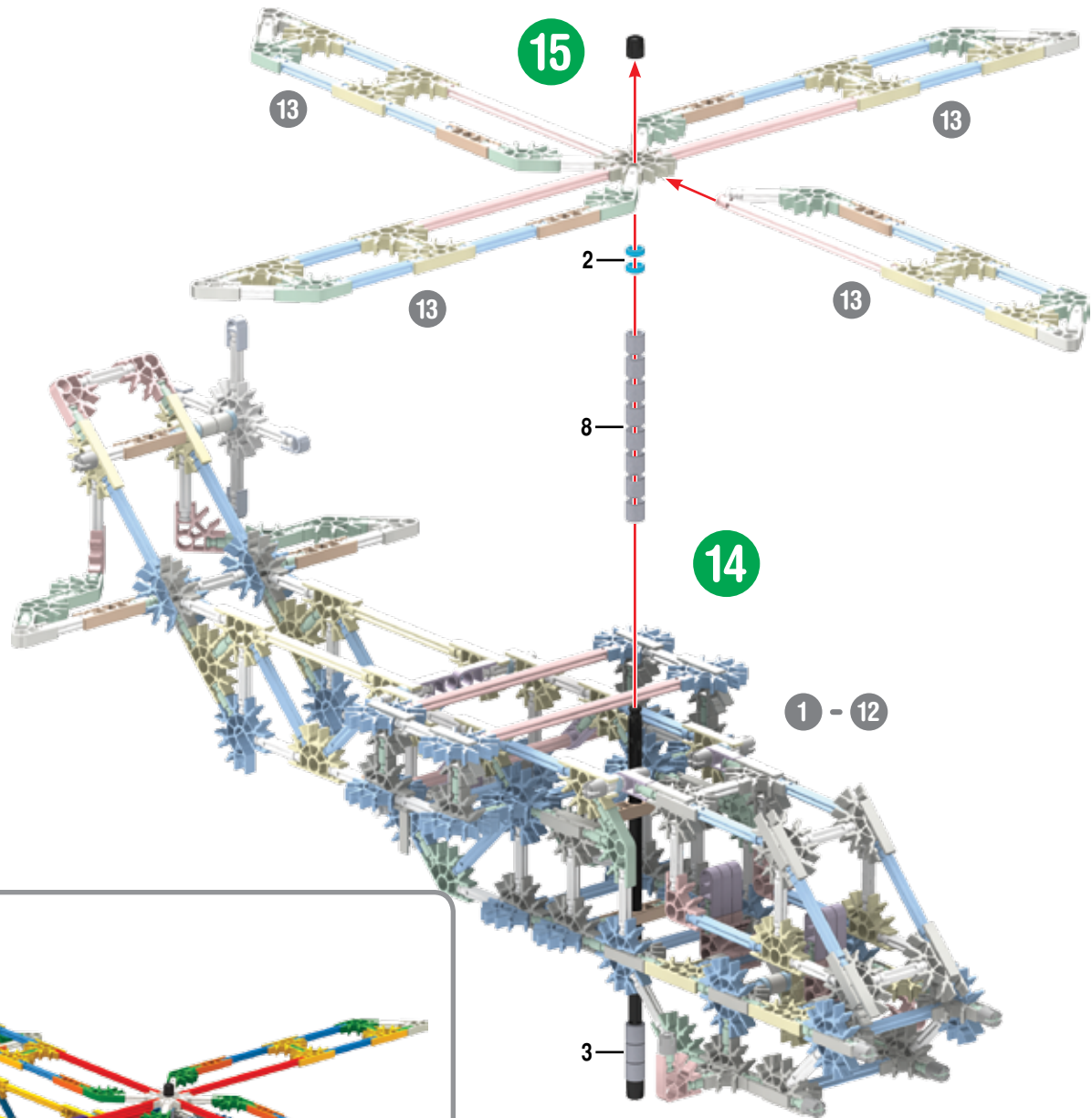

15

2

8

14

1 - 12

3

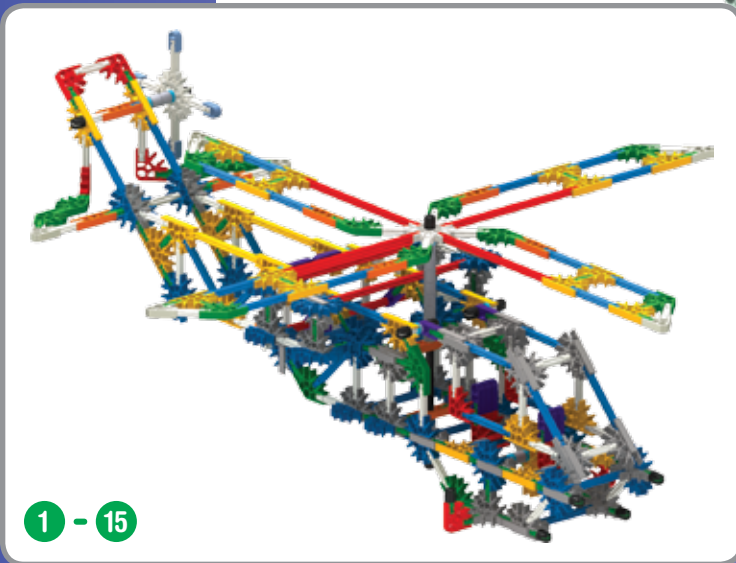

1 - 15

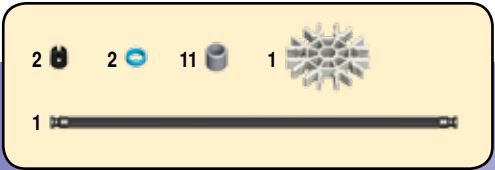

16

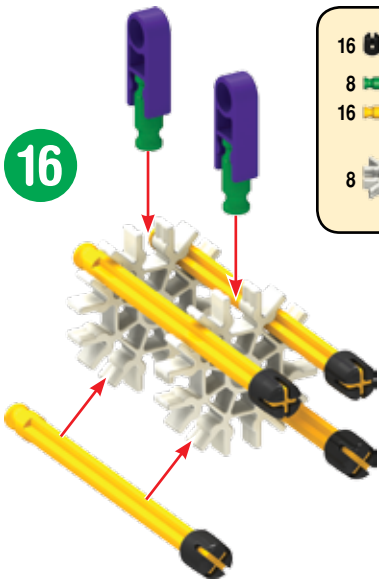

16		8	
8			
16			
8			

x4

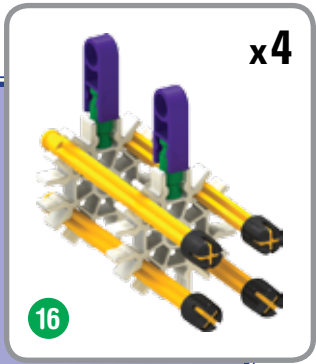

x4

16

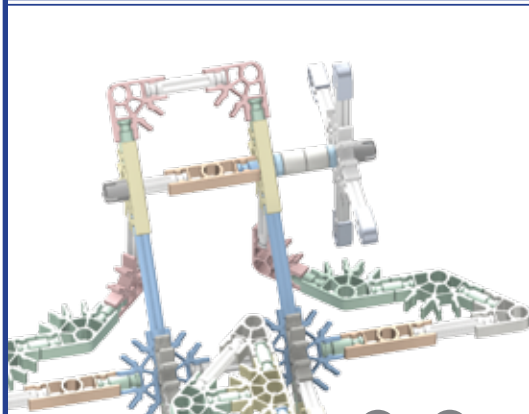

1 - 15

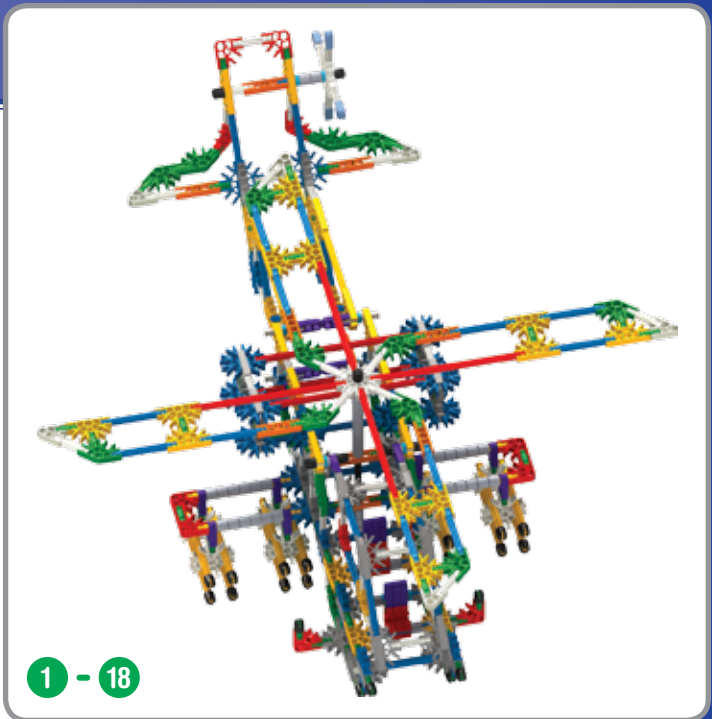

1 - 18

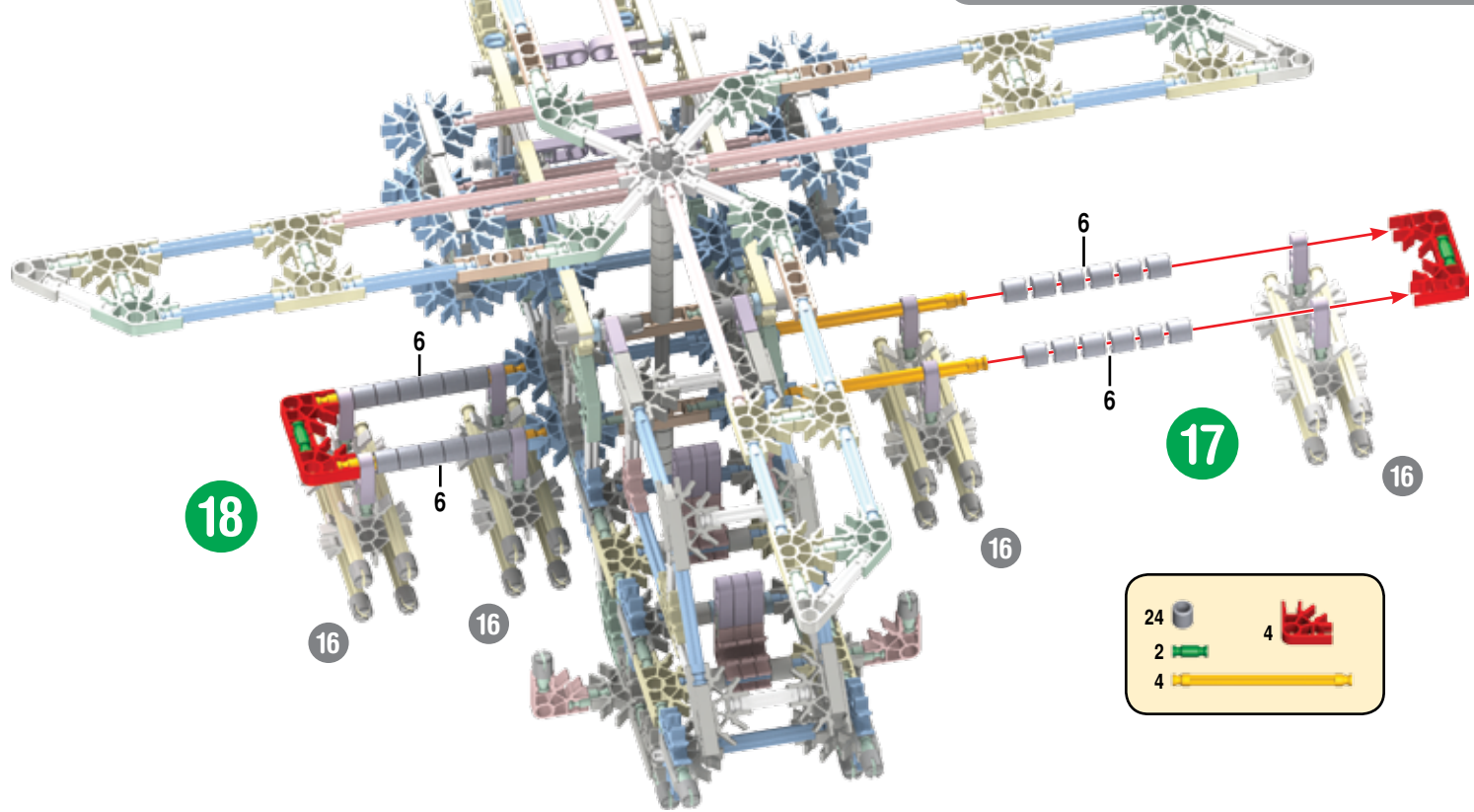

18

16

16

16

17

16

24		4	
2			
4			

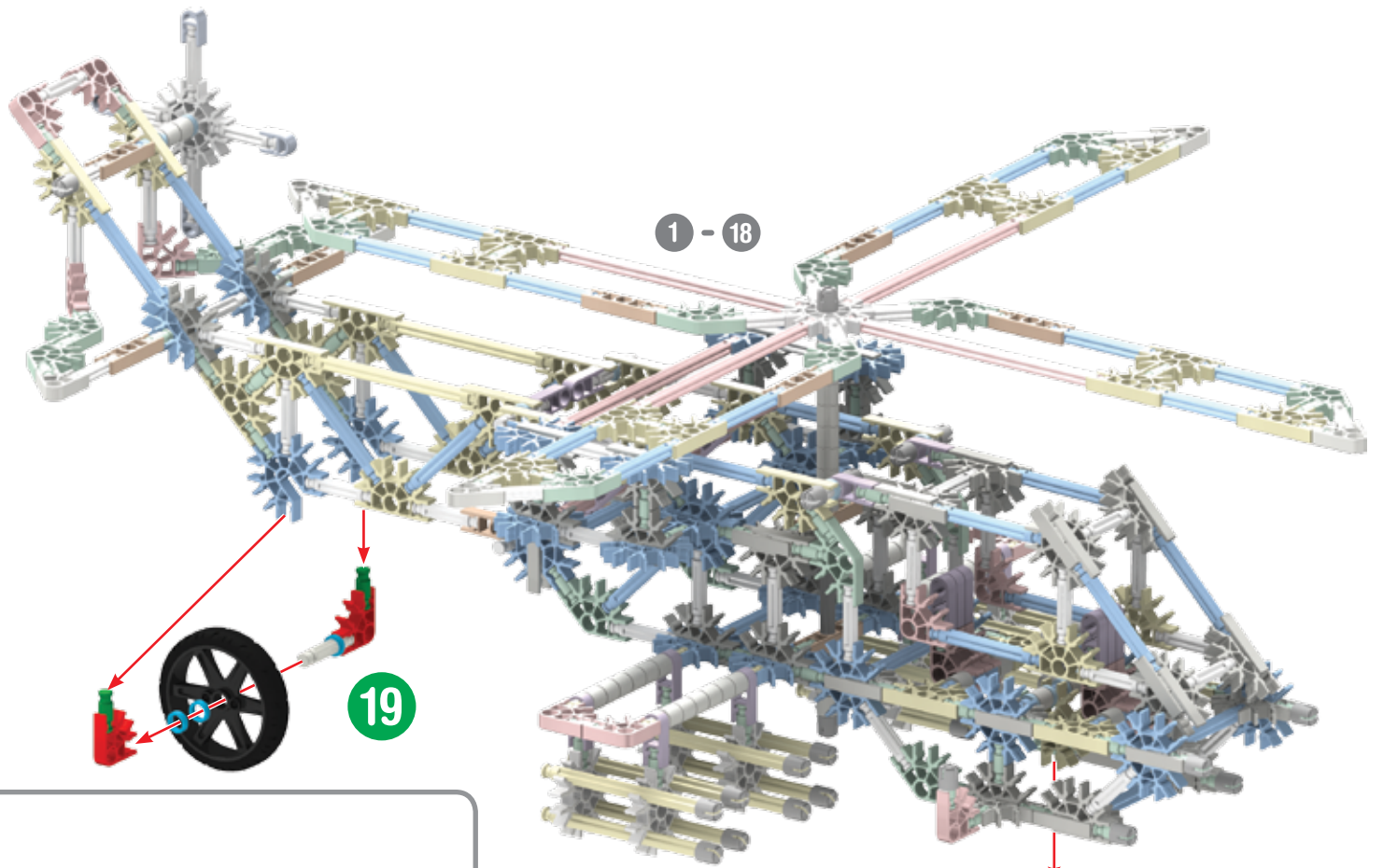

1 - 18

2		3		2	
4		1			
4					
2		2			
3					
3					

19

20

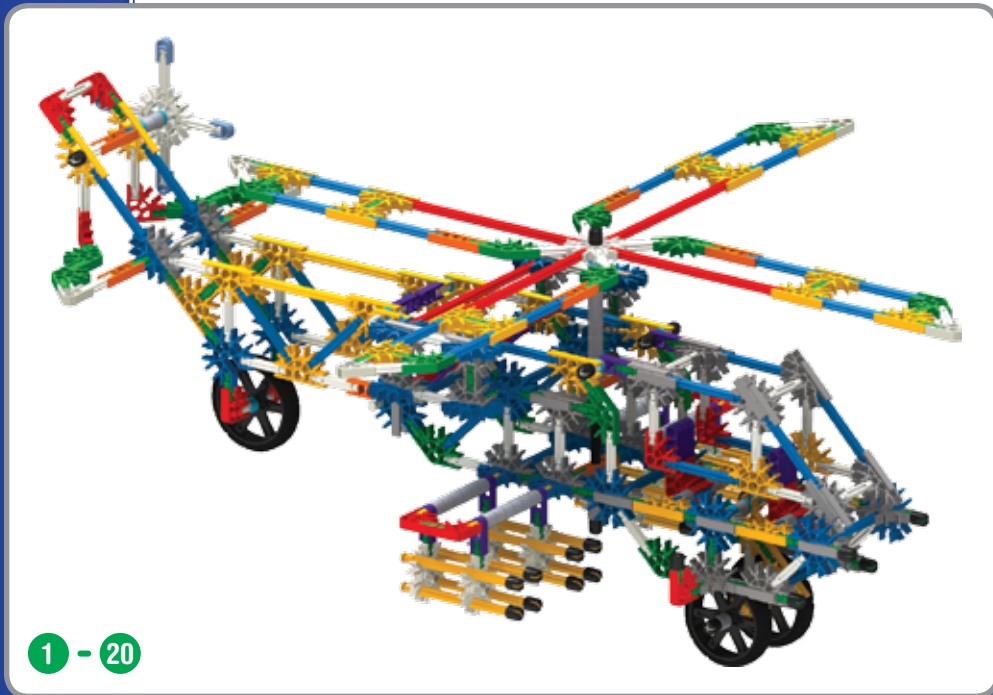

1 - 20



# Blimp Dirigeable

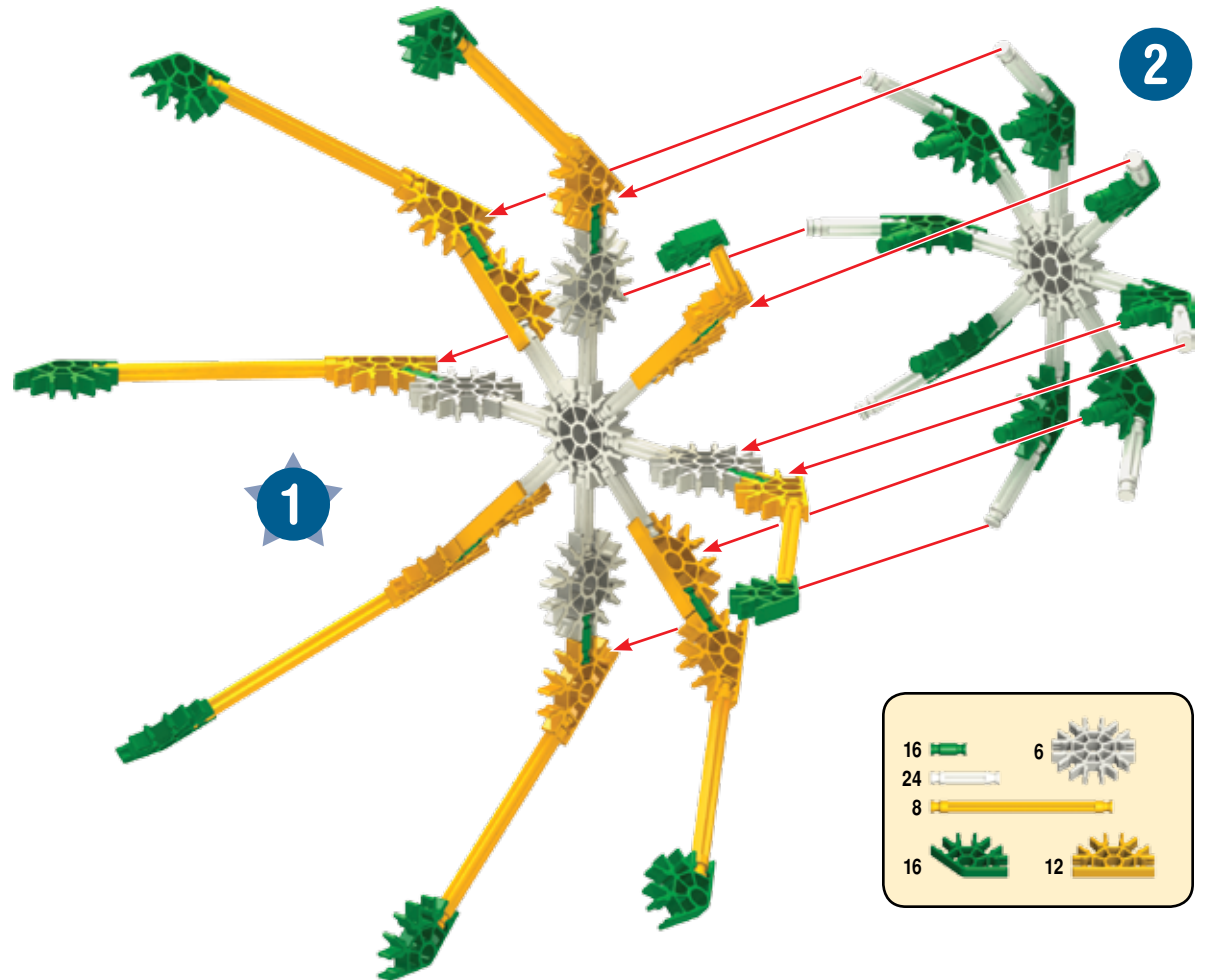
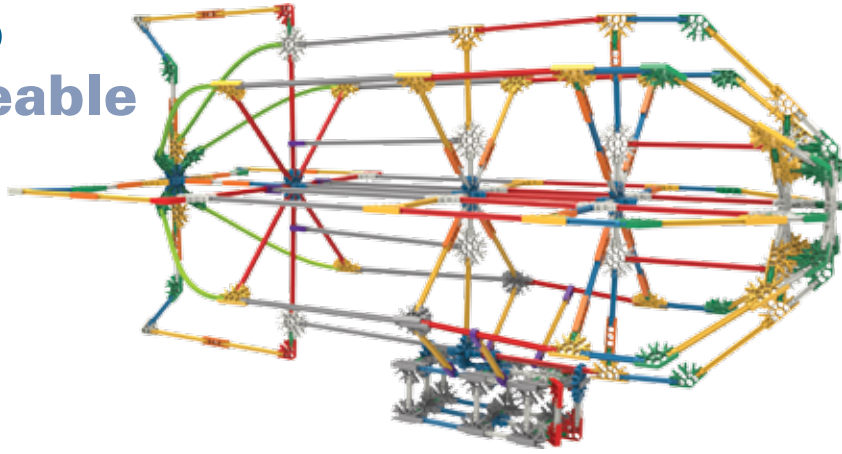

16		6	
24			
8			
16		12	

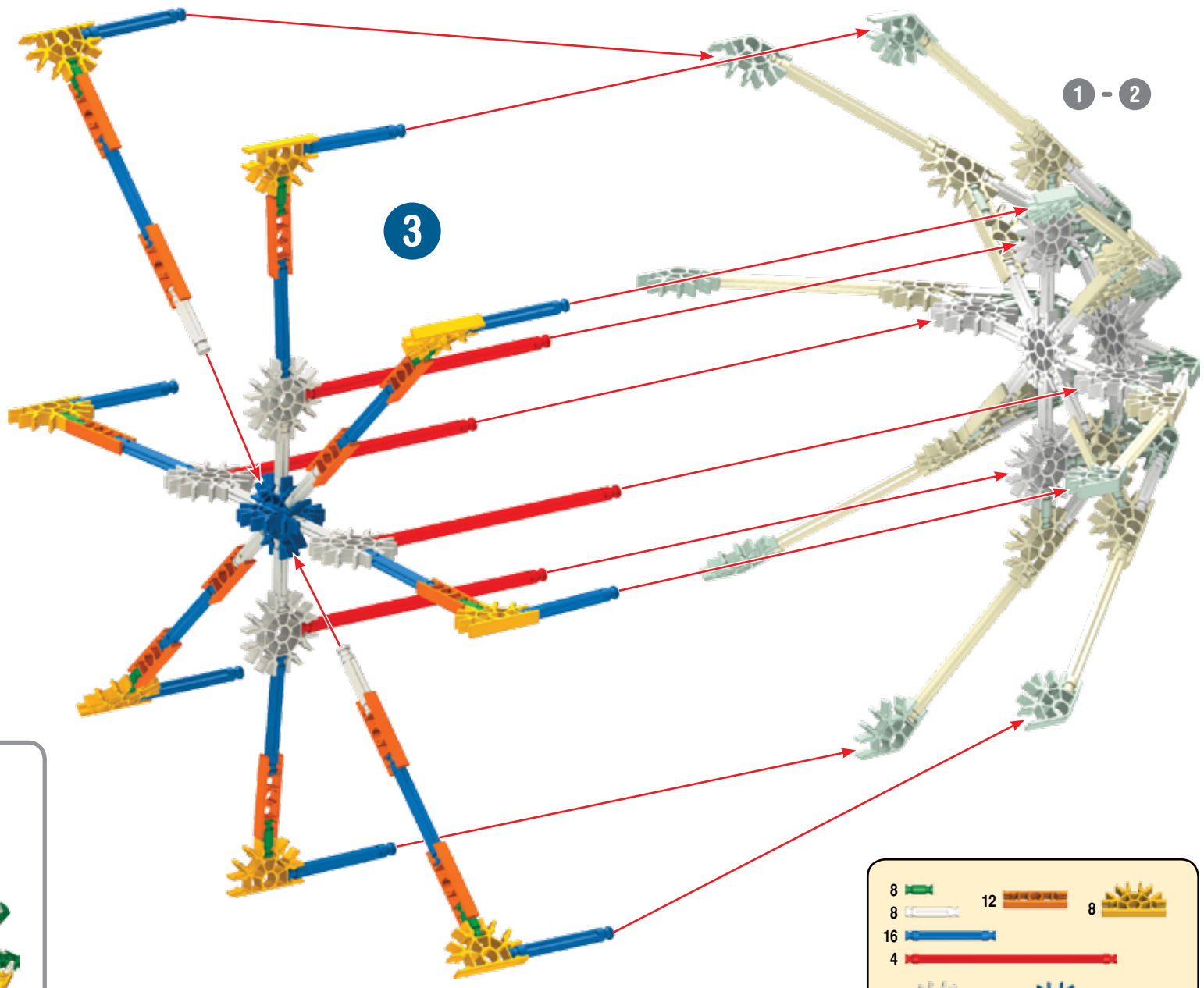

1 - 2

3

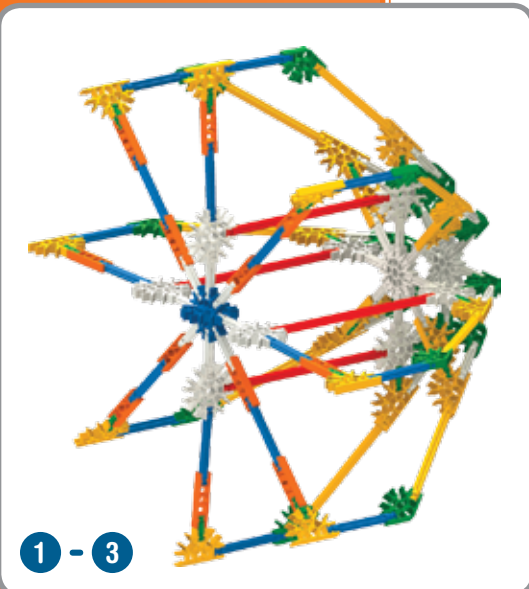

1 - 3

8		12		8	
8					
16					
4					
4					
		2			

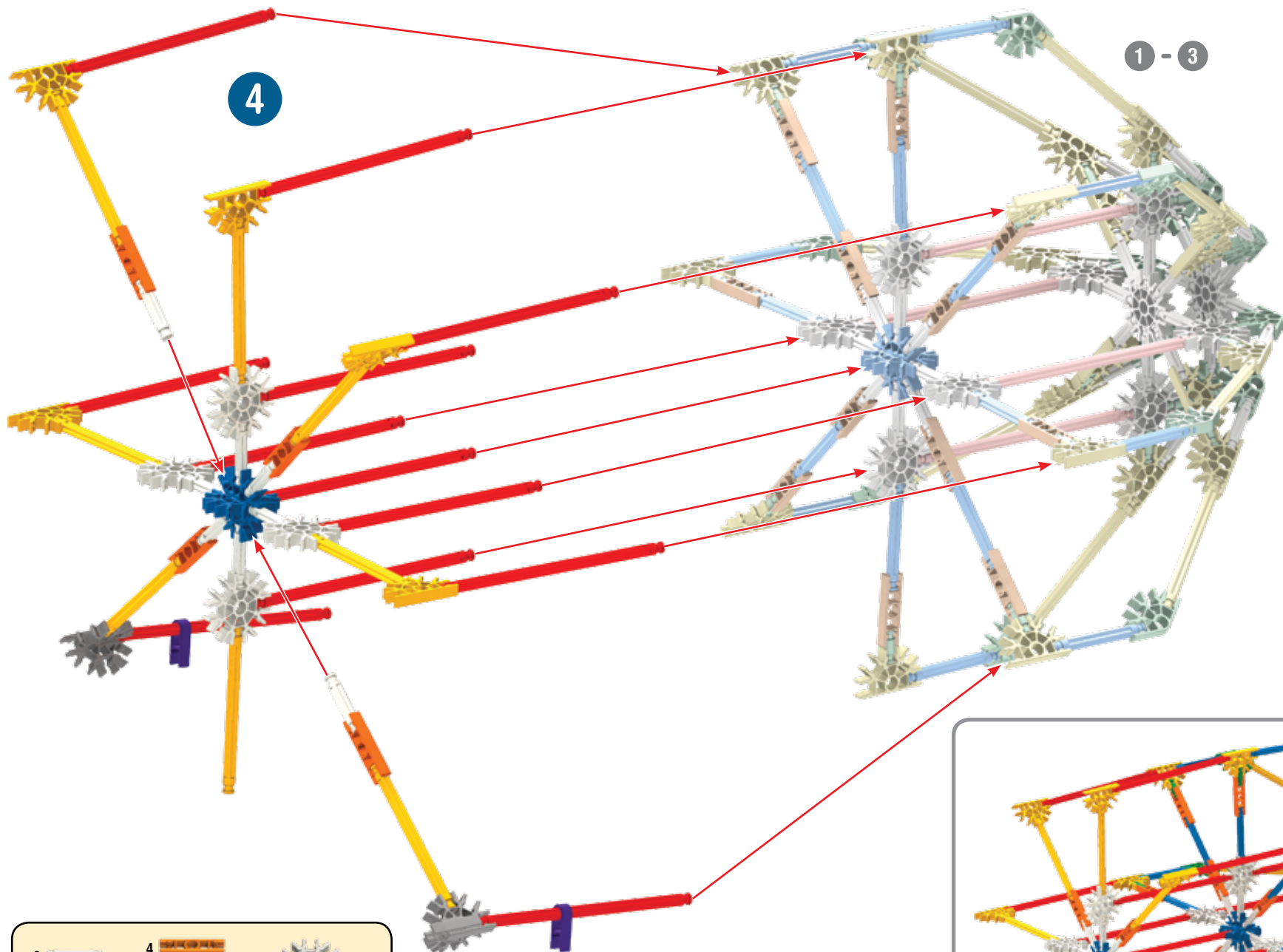

- |    |  |   |  |   |  |
|----|--|---|--|---|--|
| 8  |  | 4 |  | 4 |  |
| 8  |  |   |  |   |  |
| 12 |  |   |  |   |  |
| 5  |  | 4 |  | 2 |  |
| 2  |  |   |  |   |  |

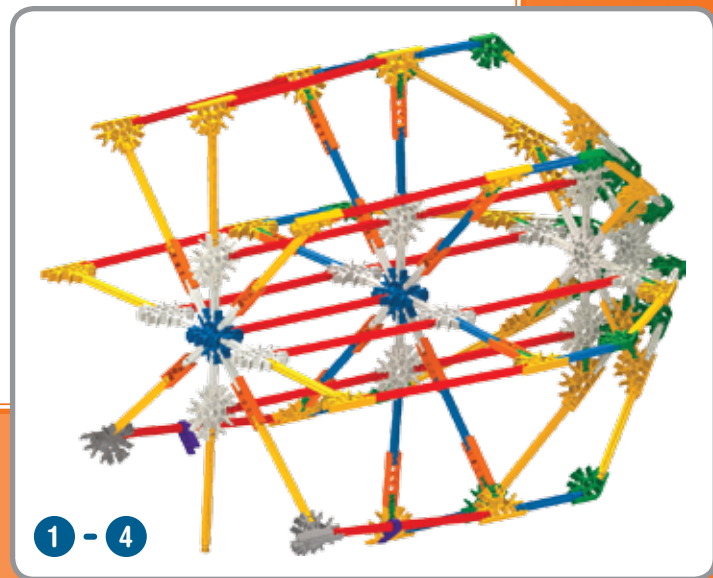

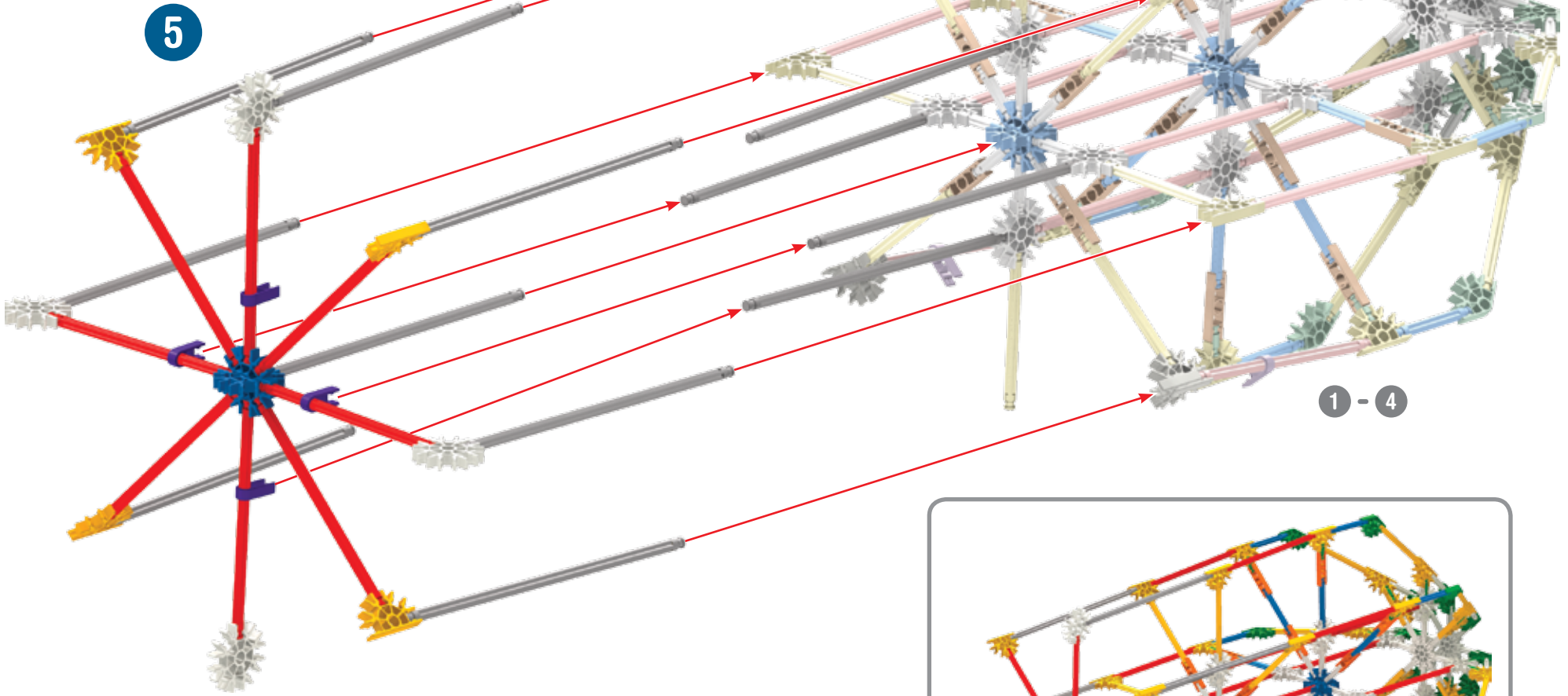
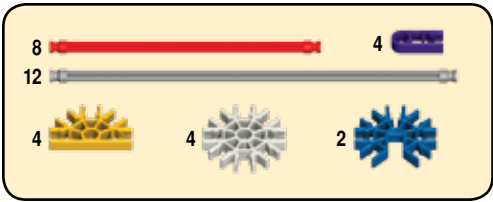

1 - 4

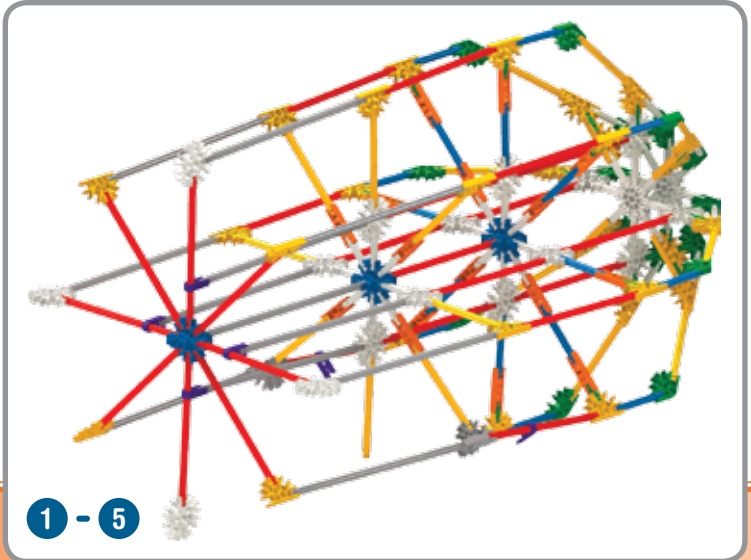

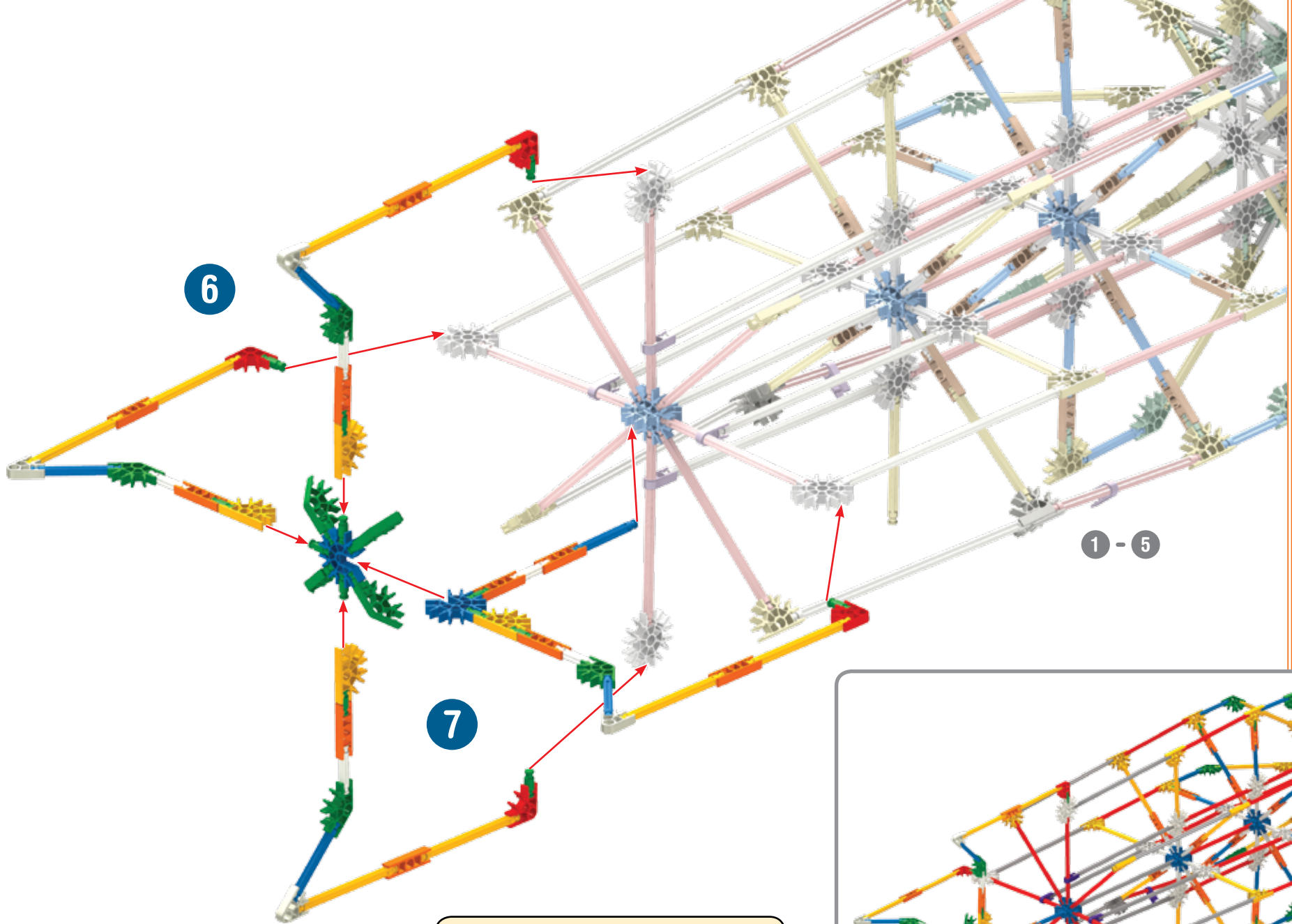

6

7

1 - 5

- |    |  |    |  |   |  |
|----|--|----|--|---|--|
| 17 |  | 10 |  | 2 |  |
| 5  |  |    |  |   |  |
| 5  |  |    |  |   |  |
| 8  |  |    |  |   |  |
| 4  |  | 4  |  | 8 |  |
|    |  |    |  | 4 |  |

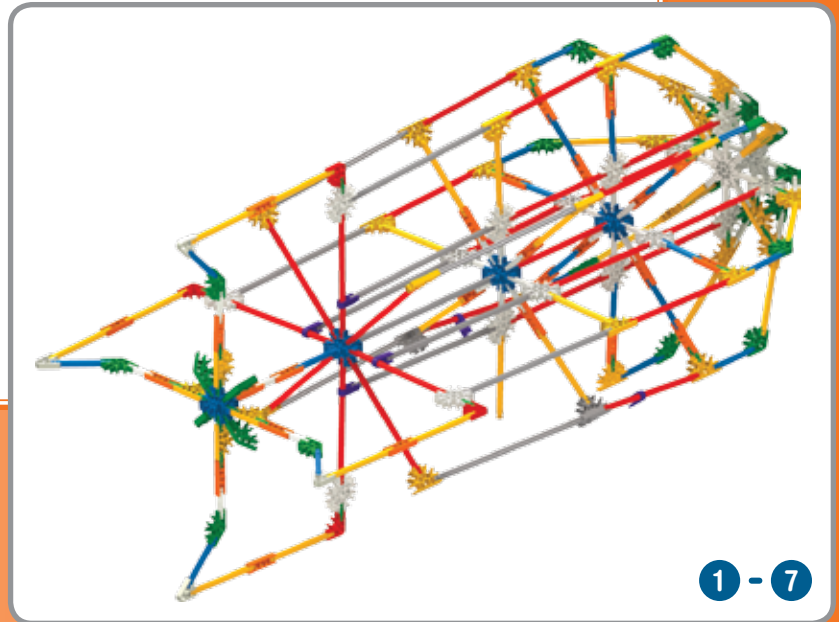

1 - 7

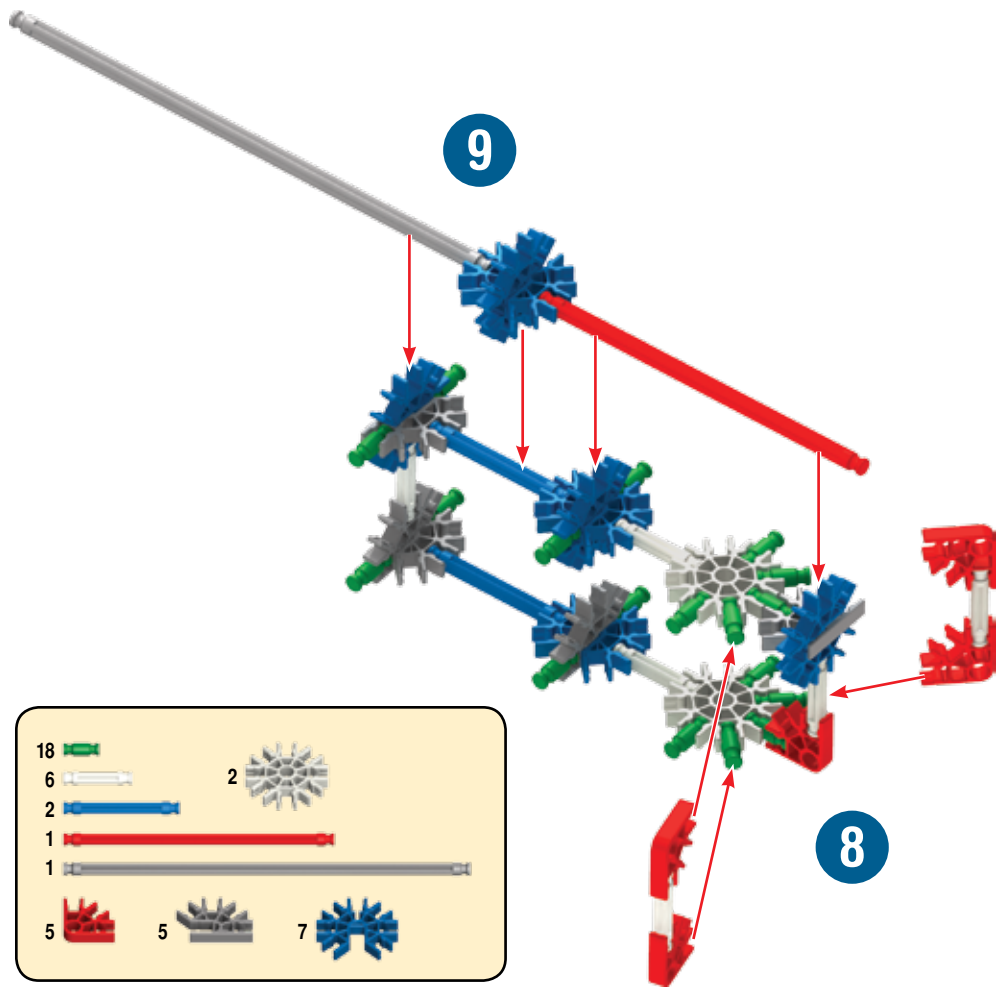

- |    |  |   |   |   |  |
|----|--|---|---|---|--|
| 18 |  |   | 2 |   |  |
| 6  |  |   |   |   |  |
| 2  |  |   |   |   |  |
| 1  |  |   |   |   |  |
| 1  |  |   |   |   |  |
| 5  |  | 5 |   | 7 |  |

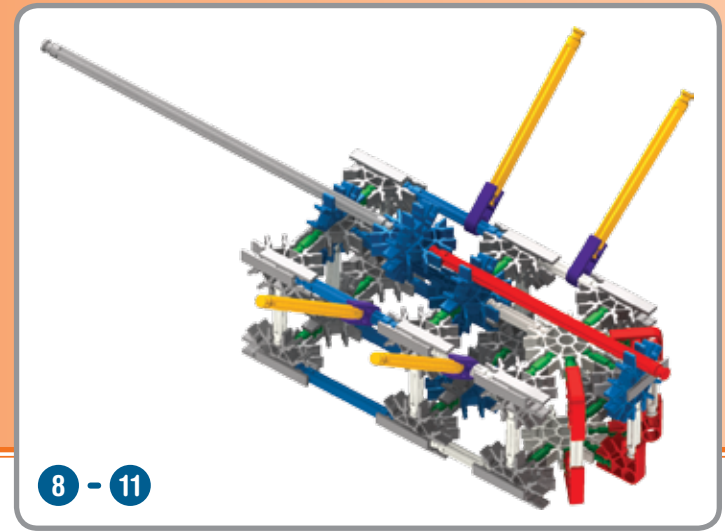
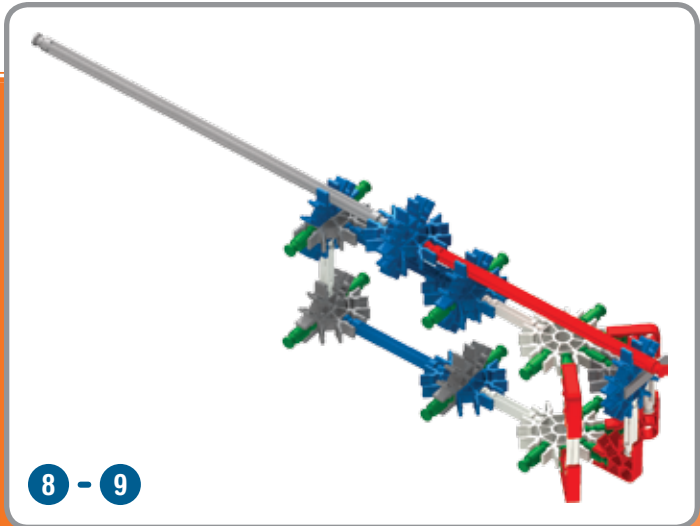

- |    |  |    |  |  |
|----|--|----|--|--|
| 10 |  |    |  |  |
| 4  |  |    |  |  |
| 4  |  |    |  |  |
| 4  |  | 24 |  |  |

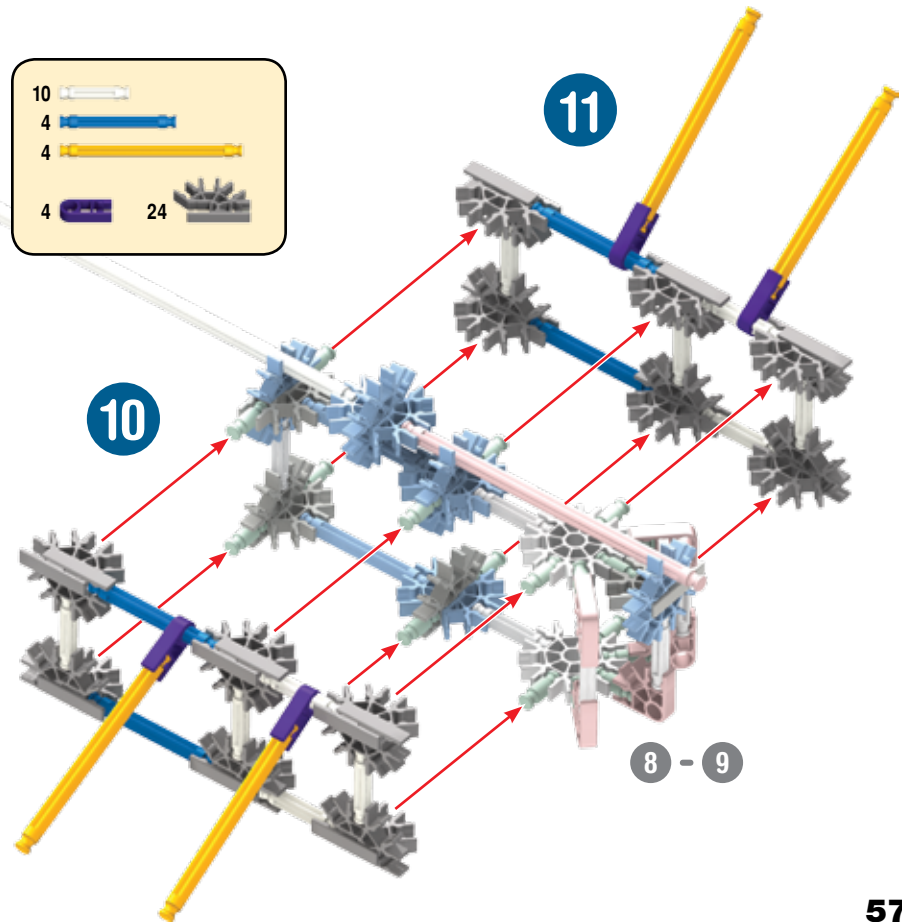

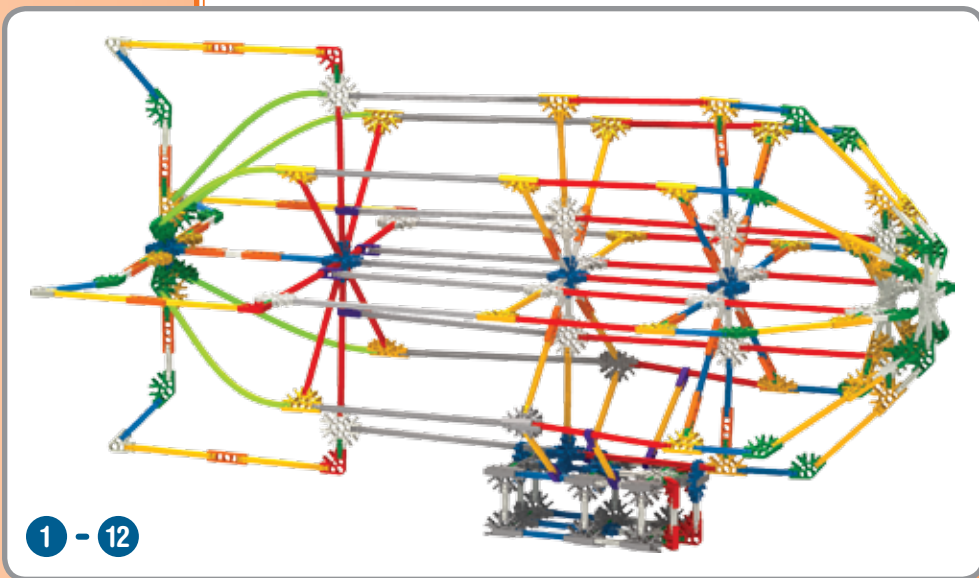
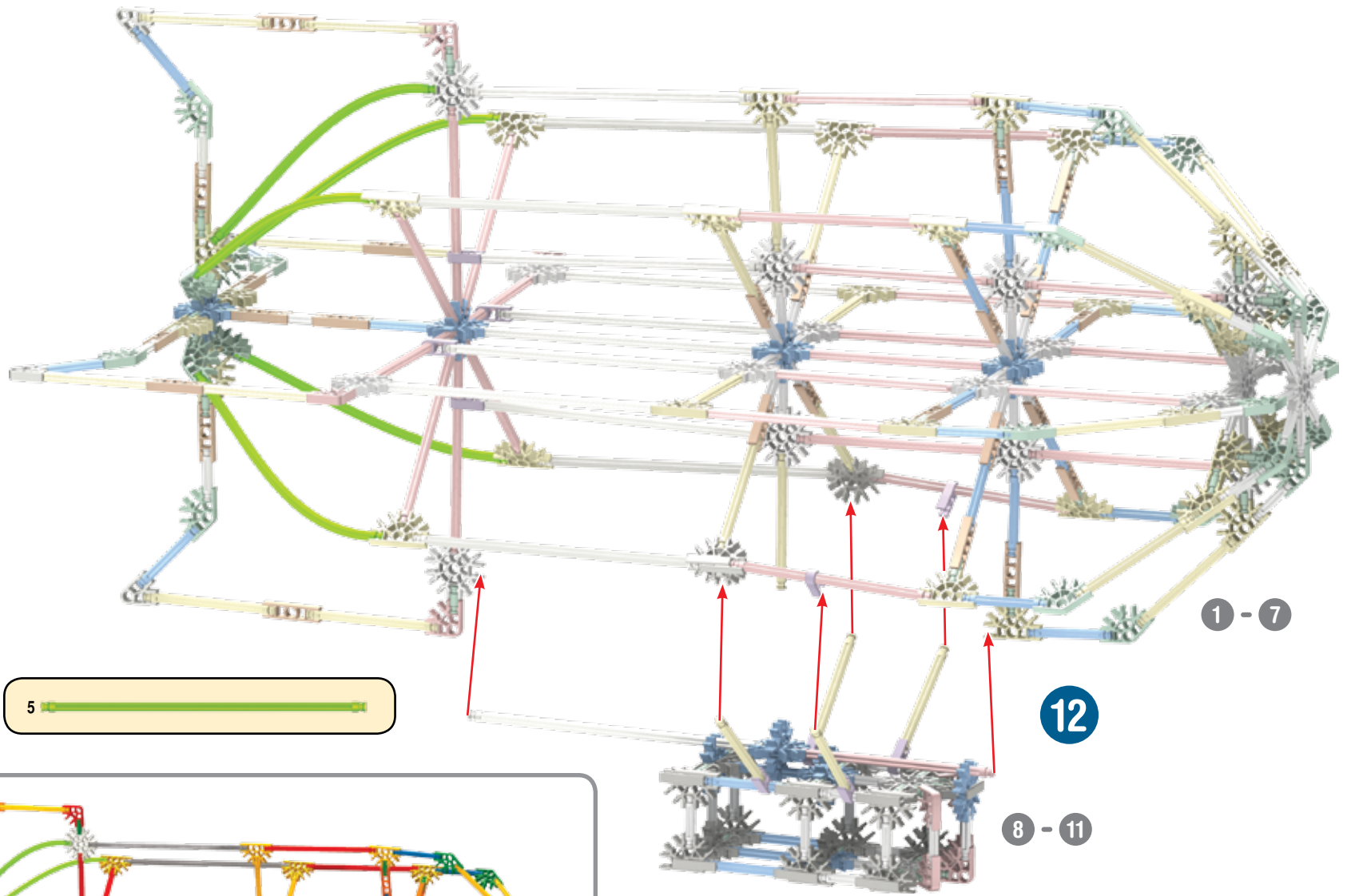

(ES) Español

## Lista de Piezas

Antes de comenzar a construir, compare las piezas de su juego con las que se enumeran aquí. Si falta algo, llámenos o escribanos utilizando la información que se encuentra en el reverso. ¡Estamos aquí para ayudarle!

## Esenciales de construcción K’NEX Empieza a Construir

Para comenzar tu modelo, busca el 1 y sigue los números. Cada pieza tiene su propia forma y color. Simplemente mira los dibujos, busca las piezas correspondientes en tu juego y después conéctalas. Mientras construyes, trata de colocar tu modelo en la misma dirección que se muestra en las instrucciones. Los colores desteñidos muestran que esta sección ya está construida. Conecta las nuevas secciones en los lugares señalados por las flechas. Las nuevas piezas que agregues estarán en colores vivos.

## Conectores

Hay conectores azules y plateados con ranuras largas especiales. Se enganchan deslizándose como ves en los dibujos. Conecta estas piezas empujándolas hasta que oigas “clic”.

## Espaciadores

Hay lugares en tu modelo donde tendrás que agregar Espaciadores azules y plateados. Cerciórate de usar el color correcto y cuéntalos con cuidado.

## Varillas Flexibles

Una varilla flexible es una Varilla que se puede doblar para formar curvas. Serán más fáciles de conectar a tu modelo si primero las doblas hacia atrás y hacia adelante.

(DE) Deutsch

## Teileliste

Bevor du mit dem Bauen anfängst, solltest du prüfen ob die Teile in deinem Bausatz mit denen auf dieser Teileliste übereinstimmen. Falls etwas fehlt, rufe uns an oder schreibe uns (siehe Rückseite). Wir sind für dich da!

## Grundlegende Bauanleitungen für K’NEX

### Los geht’s mit dem Bauen

Um mit dem Bauen deines Modells zu beginnen, suche die Nummer 1 und folge den laufenden Nummern. Jedes Teil hat seine eigene Form und Farbe. Schau dir einfach die Abbildungen an, such die Teile in deinem Bausatz, die so aussehen wie das, was du auf der Abbildung siehst und steck sie ineinander. Versuche, dein Modell beim Zusammenbauen so zu orientieren, dass es in die gleiche Richtung weist, wie es in den Anleitungen beschrieben und gezeigt wird. Blasse Farben weisen darauf hin, dass dieser Streckenabschnitt bereits zusammengebaut ist.

## Abstandsstücke

An manchen Stellen in deinem Modell musst du Abstandsstücke einbauen. Achte darauf, die richtige Farbe und Anzahl von Abstandsstücken wie in der Anleitung gezeigt zu verwenden.

## Verbindungsstücke

Blaue und silberfarbene verbindungsstücke haben besonders lange Schlitzte. Wie du vauf der Abbildung sehen kannst, lassen sie sich ineinander schieben. Achte beim Aneinanderfügen dieser Teile darauf, dass du ein Klickgeräusch hörst. Erst dann sind die Teile fest miteinander verbunden.

## Flexi-Laschen

Eine Flexi-Lasche ist eine Lasche, die du zu einer Kurve zu-rechtbiegen kannst. Sie lassen sich leichter an dein Modell anschließen, wenn du sie mehrmals hin- und herbiegst, um sie flexibler zu machen, bevor du sie das erste Mal benutzt.

(IT) Italiano

## Elenco delle parti

Prima di cominciare a costruire, accertati di confrontare le parti che sono nel tuo set con l’elenco delle parti qui. Se ne manca una chiamaci o scrivici usando le informazioni che sono nella retrocopertina. Noi siamo qui per aiutarti!

## Istruzioni di base per costruire con K’NEX

### Comincia a costruire

Per iniziare il modello, cerca il numero 1 e segui i numeri. Ogni pezzo ha una sua forma e un suo colore. Guarda la figura, trova i pezzi corrispondenti nel set e mettili insieme. Cerca di tenere il modello nella stessa direzione della figura e in tal modo sarà più semplice attaccare i pezzi nei posti giusti. I colori spenti ti dicono che questa sezione è già stata costruita. Dovrai collegare la nuova sezione al punto indicato dalla punta della freccia.

## Connettori

È molto importante posizionare i connettori blu e argento in una specifica direzione. Presta molta attenzione alle istruzioni e posiziona i connettori orizzontalmente o verticalmente proprio come illustrato. Spingi con forza fino ad udire un clic.

## Spaziatori

Ci sono punti nel tuo modello a cui dovrai aggiungere spaziatori blu e argento. Accertati si contarli attentamente.

## Flexi-stangen

Een Flexi-stangen is een stang die kan gebogen worden om bochten of curves te maken. Ze maken zich gemakkelijker vast aan je model wanneer je ze eerst een paar keer heen en weer buigt.

(PT) Português

## Lista de peças

Antes de iniciares a construção, certifica-te de que comparas as peças do teu conjunto com a lista das peças aqui. Se faltar alguma peça telefona ou escreve-nos usando as informações indicadas na contracapa. Estamos aqui para te ajudar!

## Instruções básicas para montar o K’NEX

### Inicia a construção

Para começar o teu modelo, procura o 1 e segue os números. Cada peça tem a sua própria forma definida e cor. Basta

simplesmente olhares para a ilustração, procurar as peças do teu jogo correspondentes às que estás a ver e, em seguida, conectar umas nas outras. Enquanto estás a montar as peças, tenta manter o teu modelo na mesma direcção, conforme mostrado na ilustração, para assim ligares as peças correctamente. As cores desbotadas indicam que esta secção já está montada. Passarás então a fazer a conexão da nova secção no local indicado pelas setas.

## Conectores

É muito importante que posiciones os conectores azuis e cor de prateados numa direcção específica. Presta muita atenção às instruções e coloca estes conectores horizontal ou verticalmente, exactamente conforme se mostra nas ilustrações. Junta as partes simultaneamente e com firmeza até ouvires um “estalido”.

## Espaçadores

Existirão certos pontos no teu modelo que necessitam a colocação de espaçadores azuis e prateados. Assegura-te que os contas cuidadosamente.

## Varetas flexíveis

Uma vareta flexível é uma vareta que podes dobrar para formar curvas. Para montares no teu modelo, será mais fácil se dobras primeiro a vareta para trás e para a frente.

(NL) Nederlands

## Onderdelenlijst

Voor je begint te bouwen, vergewis je ervan de onderdelen in je geheel na te gaan met de onderdelenlijst hier. Wanneer iets ontbreekt, bel ons op of schrijf ons door gebruik te maken van de informatie op het achterblad. We staan er om je te helpen !

## Basisstappen voor K’NEX bouwen Begin te bouwen

Om met je model te beginnen, vind eerst het nummer 1 en volg de nummers. Elk stuk heeft zijn eigen vorm en kleur. Kijk gewoonweg naar de afbeeldingen, vind de overeenstemmende stukken terug in je geheel en maak ze aan mekaar vast. Tracht je model in dezelfde richting te plaatsen als de aanwijzingen terwijl je bouwt en monteert. De vervaagde kleuren duiden aan dat dit deel reeds is opgebouwd. Gelieve het nieuwe deel vast te koppelen op de plaats aangeduid door de pijlen.

## Koppelstukken

Er zijn blauwe en zilveren koppelstukken met speciale lange gleuven. Ze schuiven in mekaar zoals je kunt zien op de afbeeldingen. Duw deze onderdelen in mekaar tot je een “klik” hoort.

## Tussenstukken

In je model zijn er plaatsen waar blauwe en zilveren tussenstukken moeten toegevoegd worden. Verzeker je ervan de juiste kleur te gebruiken en tel ze zorgvuldig.

## Flexi-stangen

Een Flexi-stangen is een stang die kan gebogen worden om bochten of curves te maken. Ze maken zich gemakkelijker vast aan je model wanneer je ze eerst een paar keer heen en weer buigt.

For instructions of these models go to [www.knex.com/instructions](http://www.knex.com/instructions) and enter code **16457**.

Pour les instructions de ces modèles vont à [www.knex.com/instructions](http://www.knex.com/instructions) et entrez dans le code **16457**.

Ya que las instrucciones de los estos modelos van a [www.knex.com/instructions](http://www.knex.com/instructions) y introducir el código **16457**.

Für Anweisungen dieser Modelle gehen sie zu [www.knex.com/instructions](http://www.knex.com/instructions) und geben sie Code **16457** ein.

Per istruzioni di questi modelli vai a [www.knex.com/instructions](http://www.knex.com/instructions) e inserire il codice **16457**.

Para obter instruções destes modelos vá em [www.knex.com/instructions](http://www.knex.com/instructions) e digite o código **16457**.

Voor instructies van deze modellen naar [www.knex.com/instructions](http://www.knex.com/instructions) en vul de code **16457**.









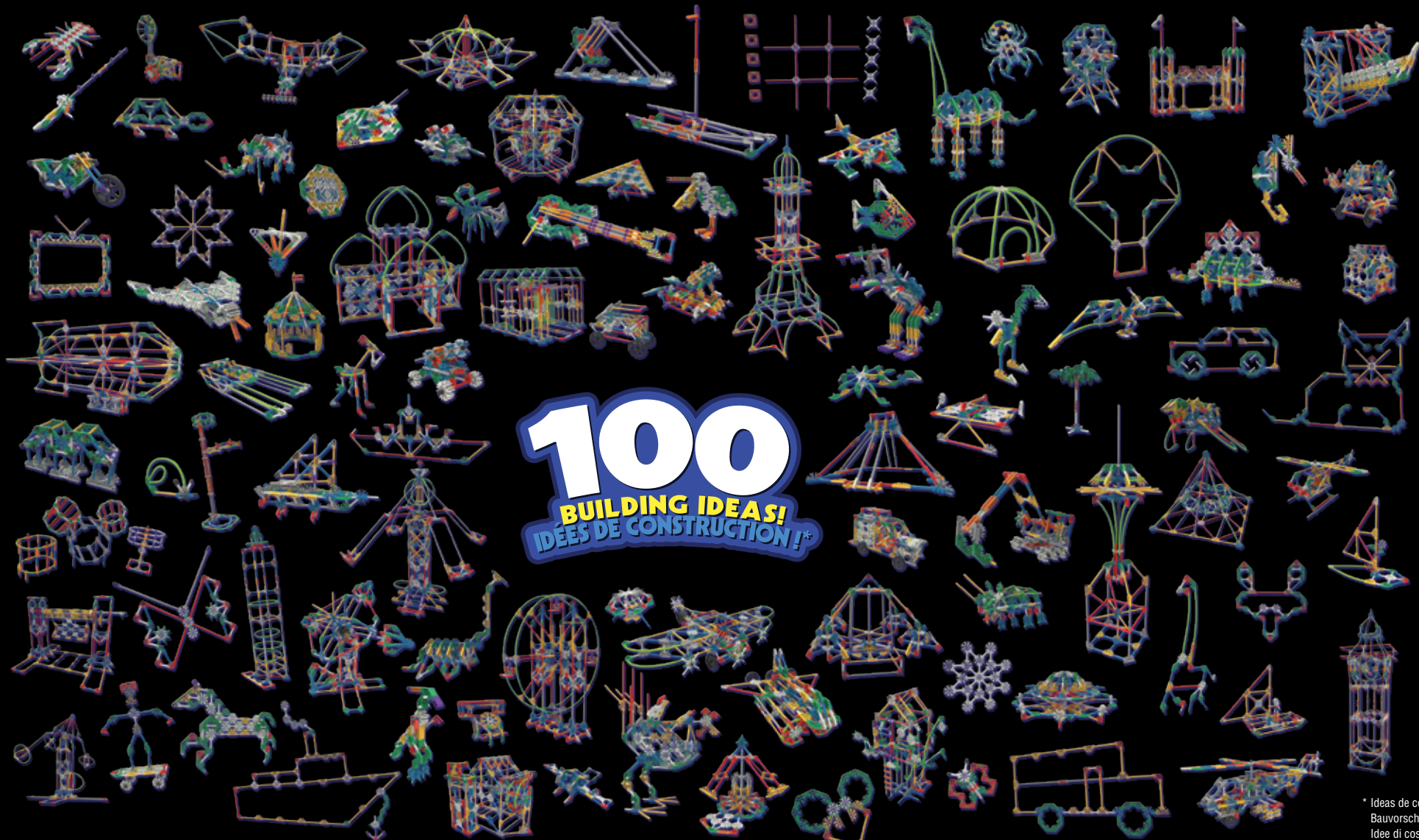

# 100

**BUILDING IDEAS!**  
**IDÉES DE CONSTRUCTION!\***

(EN) K'NEX and Building Worlds Kids Love are registered trademarks of K'NEX Limited Partnership Group.

(FR) K'NEX et Building Worlds Kids Love sont des marques déposées de K'NEX Limited Partnership Group.

(ES) K'NEX y Building Worlds Kids Love son marcas registradas de K'NEX Limited Partnership Group.

©2016 K'NEX Limited Partnership Group, P.O. Box 700, Hatfield, PA 19440-0700; 1-800-KID-KNEX (USA/Canada/États-Unis/EE.UU.); email@knex.com; knex.com. K'NEX UK Ltd., P.O. Box 3083, Reading RG1 9YQ, England. For customers outside the USA/Canada please contact your local distributor at [www.knex.com/distributors](http://www.knex.com/distributors).

(FR) Pour les clients en dehors du Canada et des États-Unis, veuillez contacter votre distributeur local que vous pouvez trouver sur [www.knex.com/distributors](http://www.knex.com/distributors)

(ES) El cliente que no vive en EE.UU./Canadá se pone en contacto con el distribuidor local. Encuentre la información para el distribuidor local en [www.knex.com/distributors](http://www.knex.com/distributors)

# KNEX.COM

(EN) Product & colors may vary. Most models can be built one at a time.

(FR) Le produit et ses couleurs peuvent varier. Les différents modèles ne peuvent être construits qu'un par un.

(ES) El producto y los colores pueden variar. La mayoría de los modelos se pueden construir uno a la vez.

(DE) Produkte und Farben können abweichen. Die meisten Modelle können immer nur einzeln gebaut werden.

(IT) Prodotti e colori possono differire. La maggior parte dei modelli si può costruire autonomamente.

(PT) O produto e as cores podem variar. A maioria dos modelos pode ser montado um de cada vez.

(NL) Product en kleuren kunnen variëren. De meeste modellen kunnen uitsluitend een voor een worden gebouwd.

\* Ideas de construcción  
Bauvorschläge  
Idee di costruzione  
Idéias de construção  
Bouwideeën



@knexbrands



facebook.com/knex

116457-V1-06/16