

K'NEX®

Transport Chopper Building Set™

7+

MOTOR

342 pc/pza/pc



11977

Transport Chopper Building Set™



Also builds.
También construye.
Também constrói.

Visit www.knex.com/instructions and enter code **11977** to find instructions for these models.
Visita www.knex.com/instrucciones e introduzca el código **11977** para encontrar las instrucciones para estos modelos.
Visite www.knex.com/instrucoes e digite o código **11977** para encontrar as instruções para esses modelos.

Parts List

Before you start building, be sure to compare the parts in your set with the parts list here. If anything is missing, call or write to us using the information on the back cover. We are here to help you!

Lista de piezas

Antes de comenzar a construir, compare las piezas de su juego con las que se enumeran aquí. Si falta algo, llámenos o escríbanos utilizando la información que se encuentra en el reverso.

¡Estamos aquí para ayudarle!

Lista das peças

Antes de começar a montar, compare as partes do seu conjunto com as partes enumeradas aqui. Se houver algo que estiver faltando, ligue ou escreva para nós usando as informações na capa de trás. Estamos aqui para servir e ajudar.

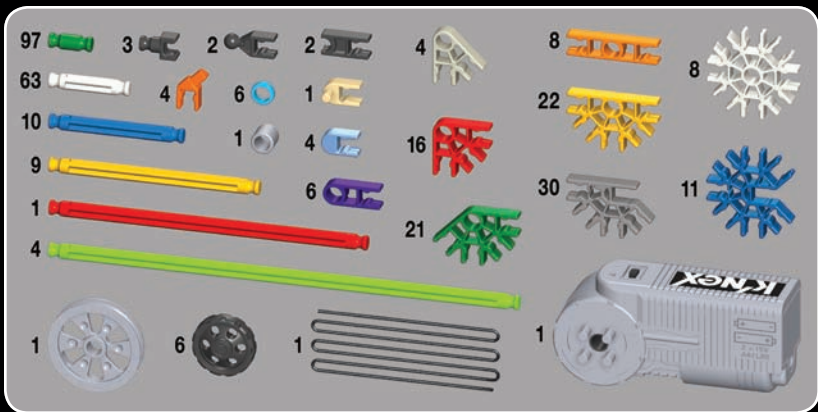



BUILDING BASICS

CAUTION: Keep hands, face, hair and clothing away from all moving parts.

Start Building

To begin your model, find the **1** and follow the numbers. Each piece has its own shape and color. Just look at the pictures, find the pieces in your set that match and then connect them together. Try to face your model in the same direction as the instructions while you build. The arrows show you where the parts connect, but not all connections points have arrows. Faded colors show you this section is already built.

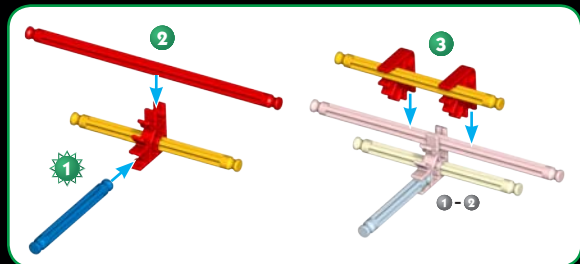

Connectors

You can slide these special connectors together. Push tightly until you hear a "click". Pay close attention to the instructions and position them horizontally or vertically exactly as they are shown.

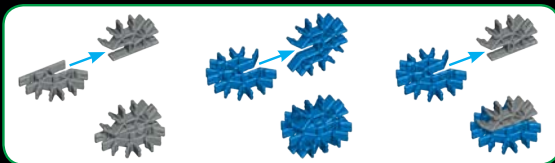

Flexi-rods

A Flexi-rod is a rod that you bend to make curves. It will be easier to attach to your model if you bend it back and forth first.



BATTERY INFORMATION

CAUTION:

- Be sure to insert the batteries correctly and always follow the toy and battery manufacturers' instructions.
- Do not mix old and new batteries or alkaline, standard (carbon-zinc) or rechargeable (nickel-cadmium) batteries. Only batteries of the same or equivalent type recommended should be used.
- Always remove weak or dead batteries from the product; do not short-circuit supply terminals.
- Insert batteries with correct polarity (+/-) as shown.

Important Tips

- Alkaline batteries are recommended.
- Rechargeable batteries are not recommended.
- Remove rechargeable batteries from toy before charging; they must be charged only under adult supervision.
- Non-rechargeable batteries must not be recharged.
- Keep components free of dust; do not immerse or use in water.
- Do not dispose of batteries in a fire; they could leak or explode and cause injury.

- Remove all batteries if the toy will not be used for a long period of time.
- Do not put rods smaller than 2 inches in any openings of the motor; they will damage the motor, and cannot be removed.
- Help the environment by disposing of your product and packaging responsibly. The wheelie bin symbol indicates that the product and batteries must not be disposed of in the domestic waste as they contain substances which can be damaging to the environment and health. Please use designated collection points or recycling facilities when disposing of the item or batteries.

How to Insert and Remove Batteries

Use a small Phillips head screwdriver to loosen the screw. Insert 2 fresh AA batteries (LR6) into the compartment with the correct polarity (+/-) as shown here.



Transport Chopper™

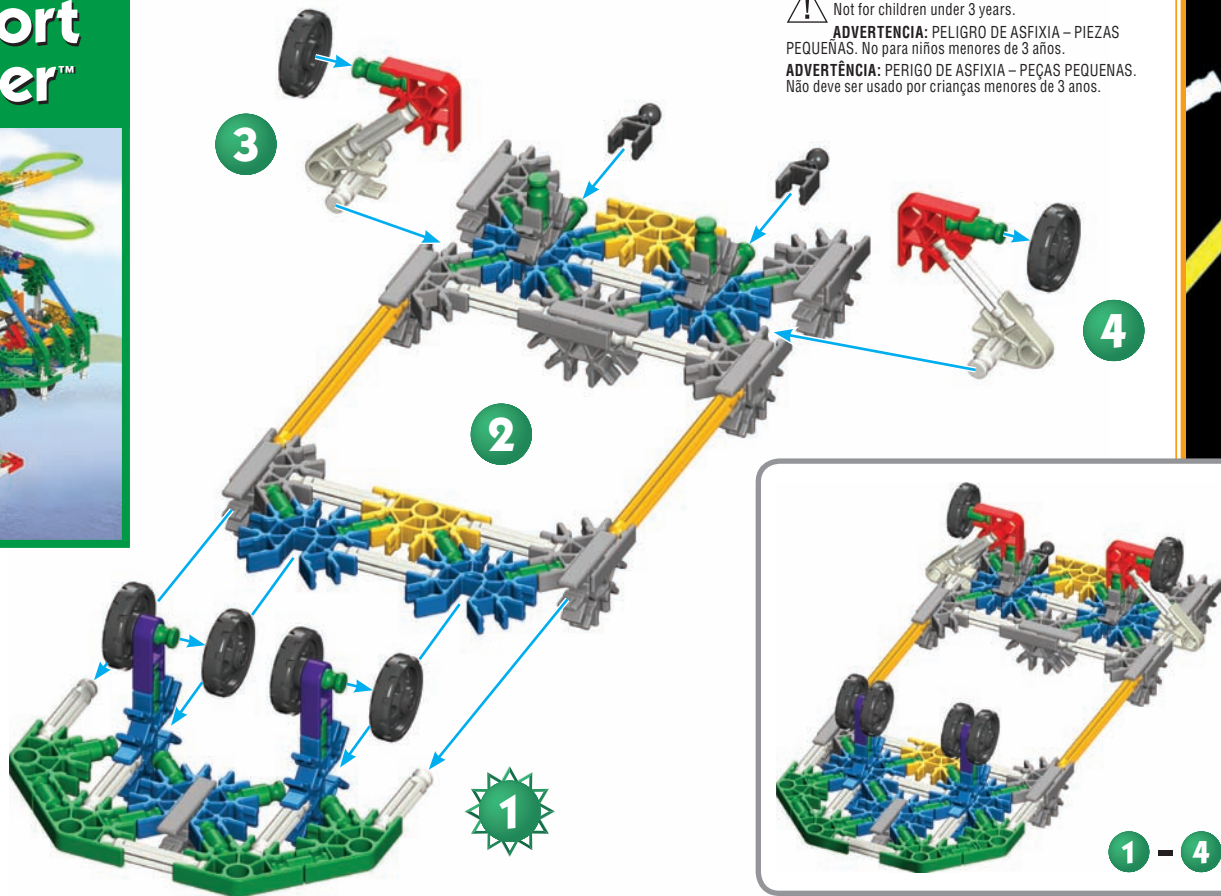

! **WARNING: CHOKING HAZARD – SMALL PARTS.**
Not for children under 3 years.

ADVERTENCIA: PELIGRO DE ASFIXIA – PIEZAS PEQUEÑAS. No para niños menores de 3 años.

ADVERTÊNCIA: PERIGO DE ASFIXIA – PEÇAS PEQUENAS. Não deve ser usado por crianças menores de 3 anos.

 x6

 x7

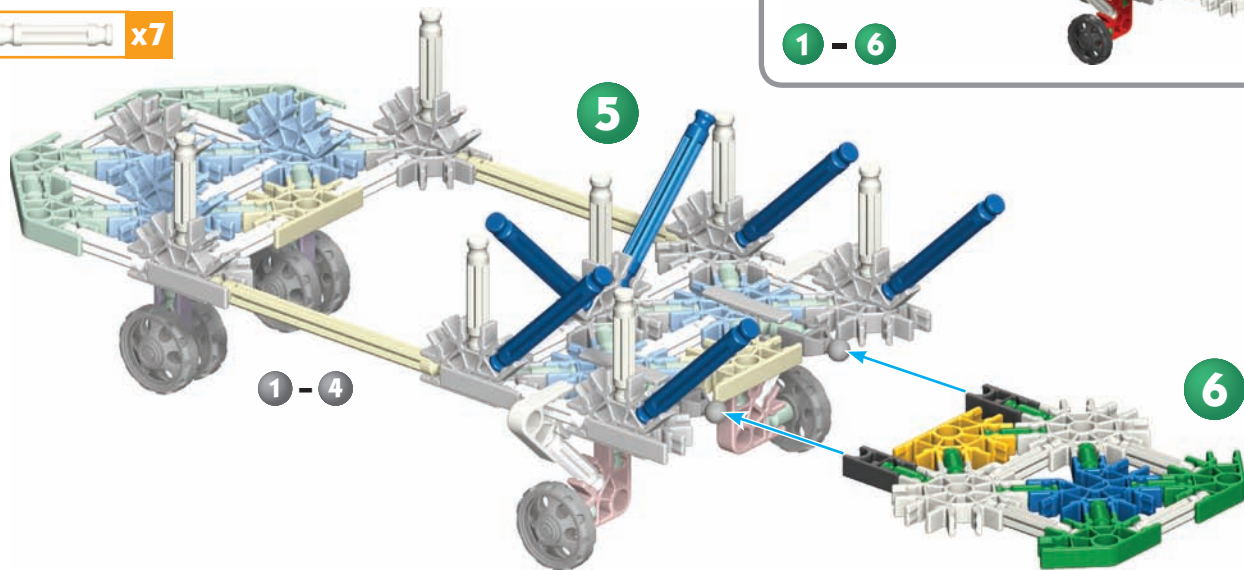

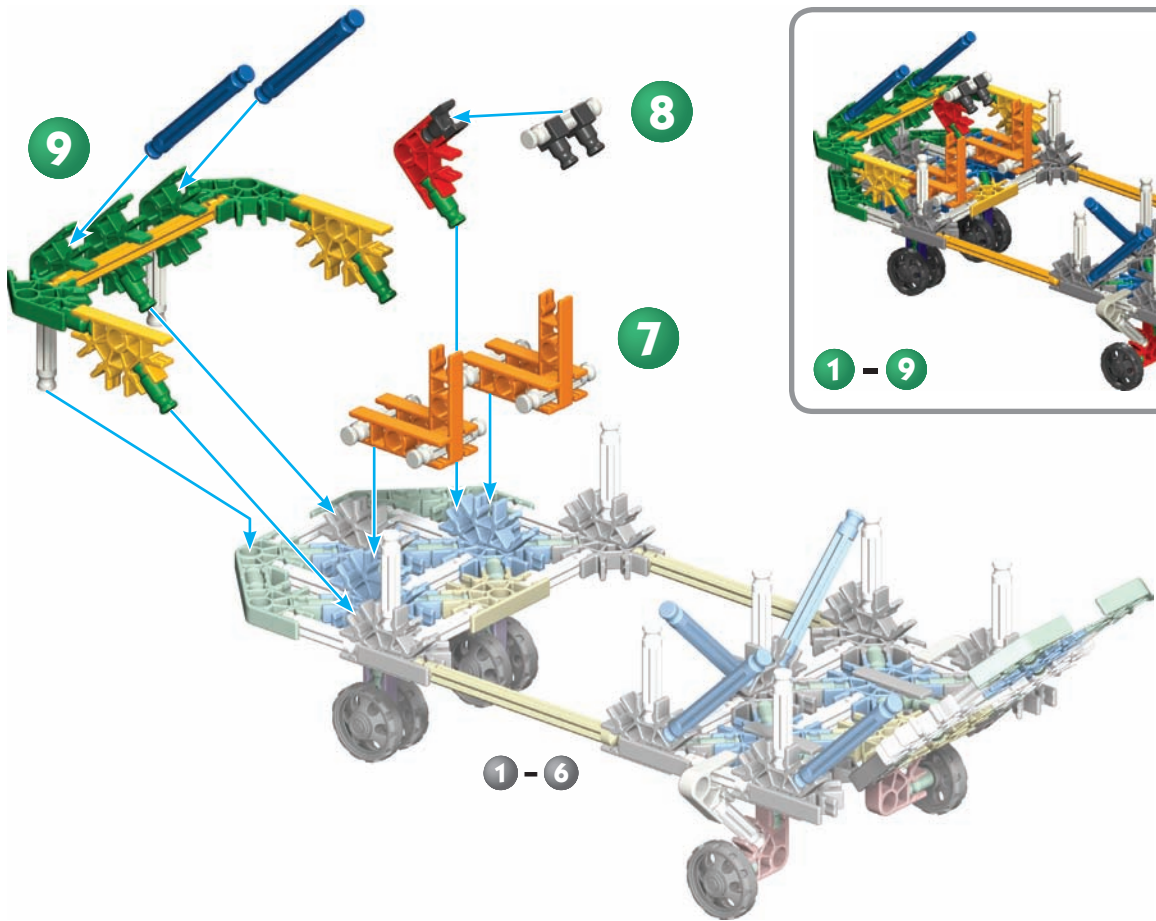

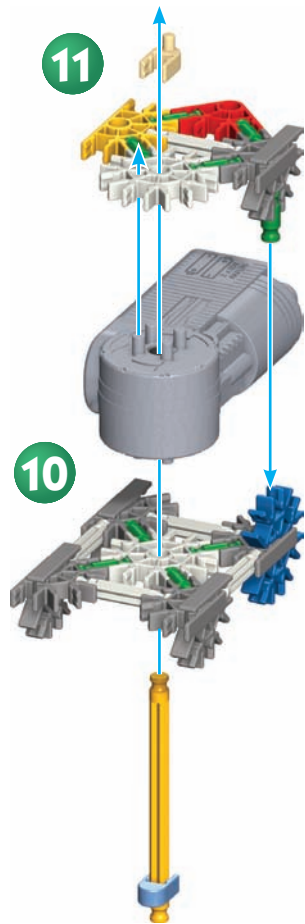

- EN** Did you install 2 AA (or LR6) batteries in the motor?
- ES** ¿Instaló 2 baterías AA (o LR6) en el motor?
- PT** Você instalou 2 pilhas AA (ou LR6) no motor?

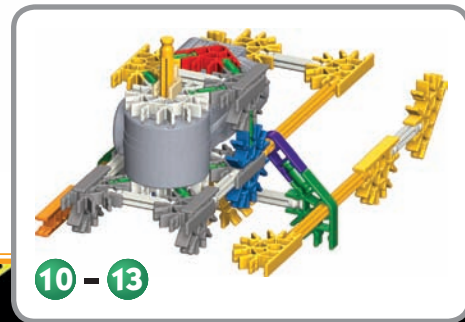
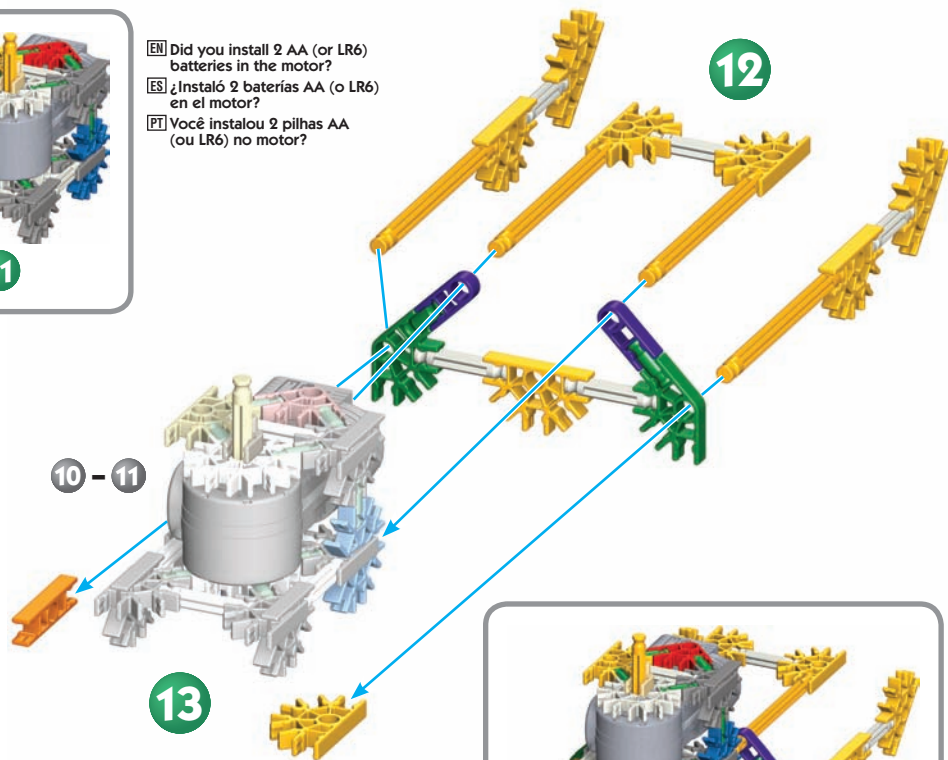

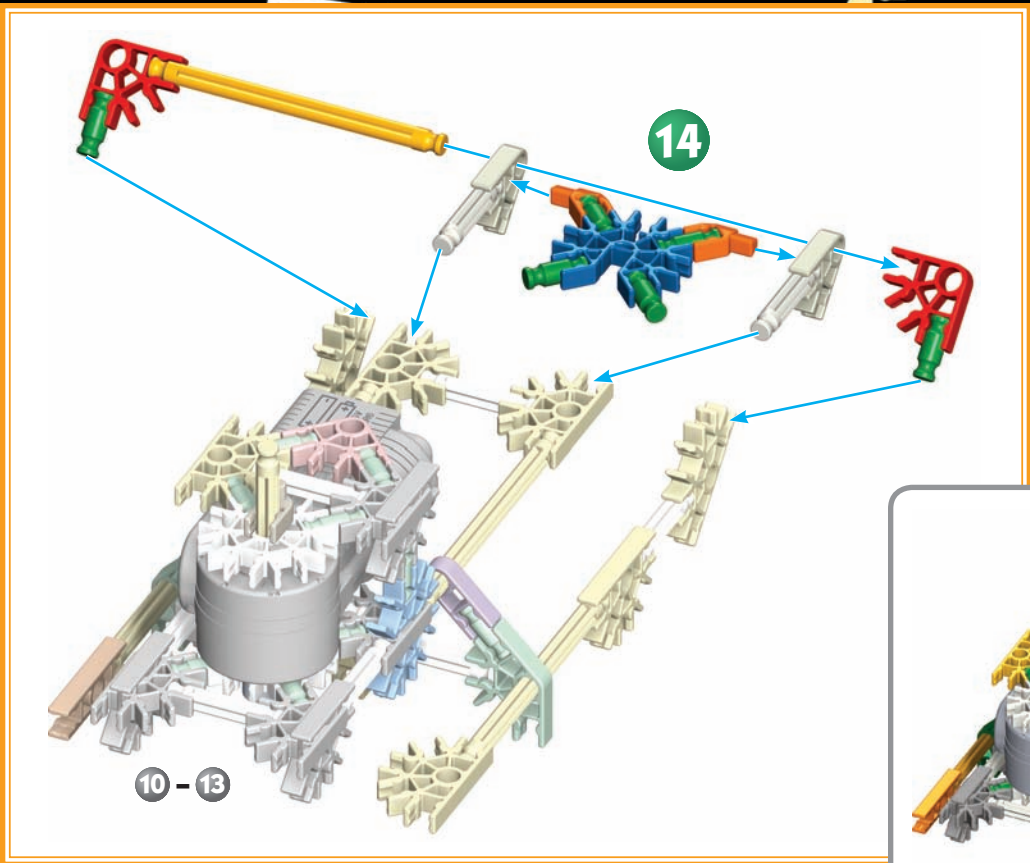

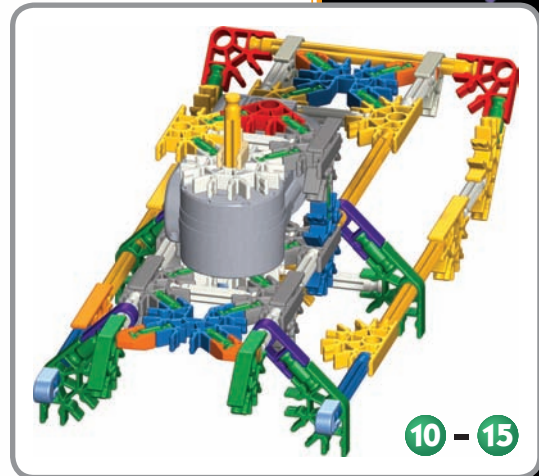
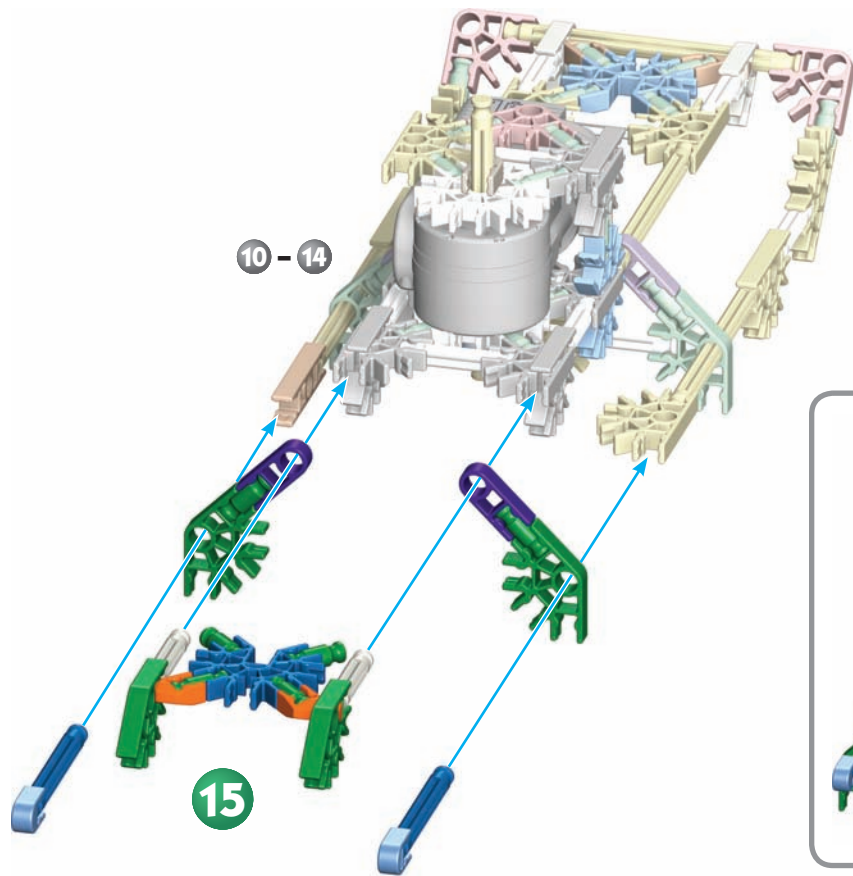

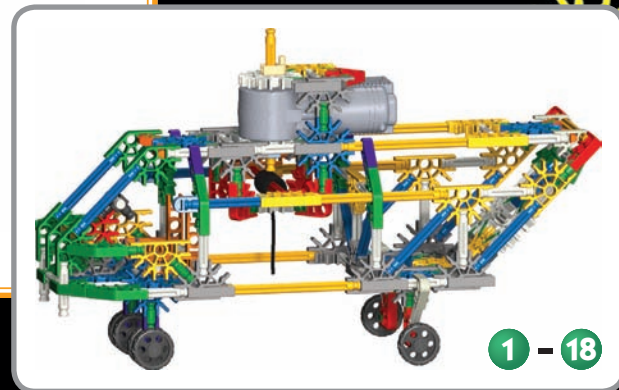
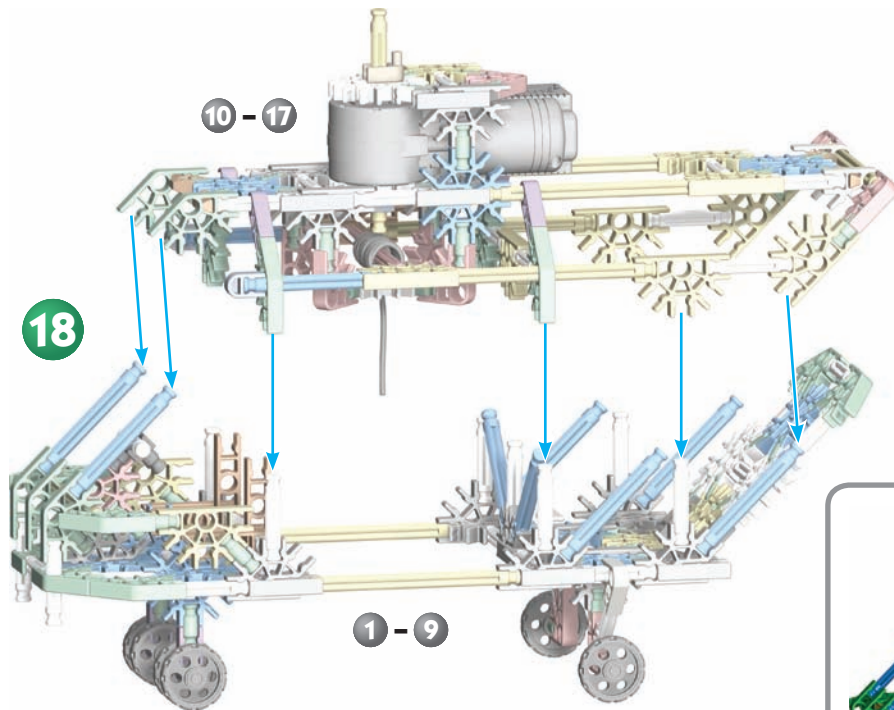

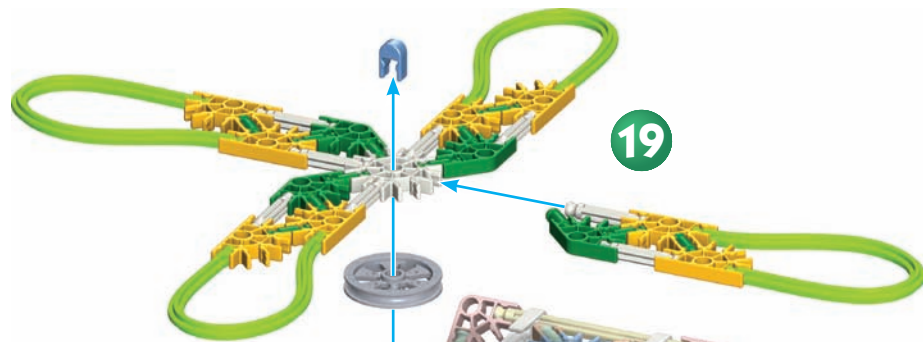

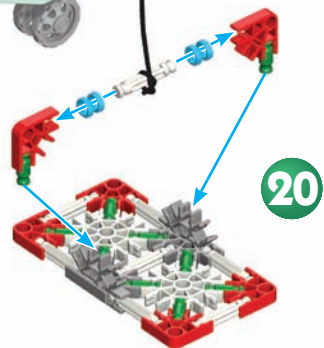
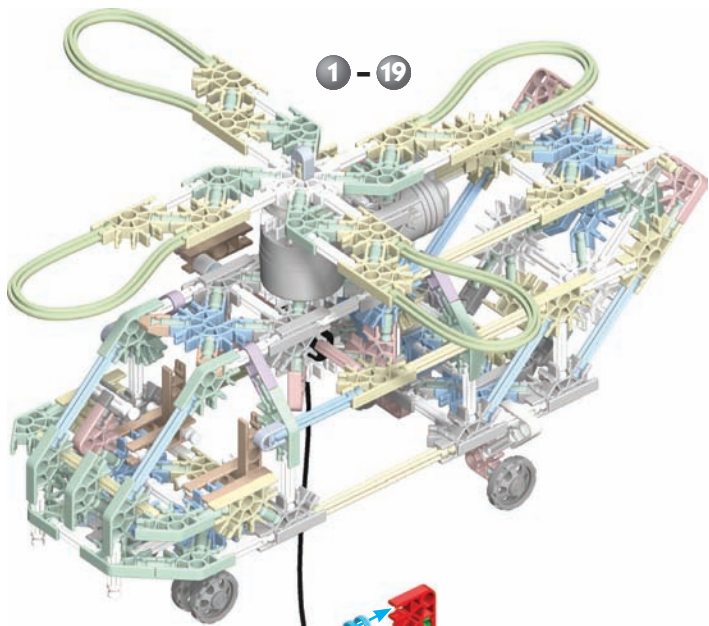

PRECAUCIÓN: Mantenga las manos, la cara, el pelo y la ropa lejos de las partes que se muevan.

Para comenzar a construir

Para comenzar el modelo, encuentre el número **1** del paso y siga los números. Cada pieza tiene su propia forma y color. Observe las imágenes, encuentre las piezas que sean iguales a las que se muestran y conéctelas. Colocar el modelo en la misma dirección que se encuentra en las instrucciones le facilitará la construcción. Las flechas muestran en dónde se conectan las piezas, pero no todos los puntos de conexión tienen flechas. Las partes de color tenue son las que ya armó.

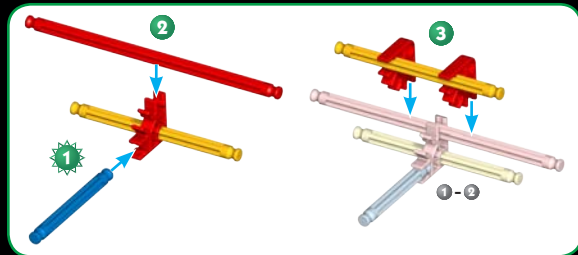

Conectores

Puede unir estos conectores especiales deslizándolos. Presione con fuerza hasta que oiga un "clic". Preste especial atención a las instrucciones y colóquelos de forma horizontal o vertical, exactamente como se muestra.

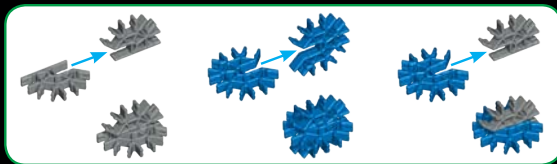

Información sobre las baterías

PRECAUCIÓN:

- Asegúrese de colocar las baterías correctamente y siga siempre las instrucciones del fabricante del juguete y de las baterías.
- No mezcle baterías viejas y nuevas o alcalinas, estándar (carbón-zinc) o recargables (níquel-cadmio). Se recomienda usar solamente baterías del mismo tipo o equivalentes.
- Siempre retire las baterías descargadas del producto; no cause un corto circuito en las terminales de alimentación.
- Coloque las baterías con la polaridad correcta (+/-) como se muestra.

Consejos importantes

- Se recomiendan baterías alcalinas AA (LR6).
- No se recomienda el uso de baterías recargables.
- Retire las baterías recargables del juguete antes de cargarlas; solamente se deben recargar bajo la supervisión de un adulto.
- Las baterías no recargables no se deben recargar.
- Mantenga los componentes limpios y libres de polvo; no los sumerja ni utilice en el agua.

- No arroje las baterías al fuego; pueden tener fugas o explotar y provocar heridas.
- Retire todas las baterías del juguete si no lo usará por un periodo prolongado.
- No coloque varillas de menos de 2 pulgadas en ninguna de las aberturas del motor; lo dañarán y no se pueden retirar.
- Ayude al medio ambiente al desechar de manera responsable el producto y el empaque. El símbolo del contenedor indica que el producto y las baterías no se deben desechar en la basura doméstica pues contienen sustancias que pueden ser dañinas para la salud y el medio ambiente. Utilice los centros de recolección designados o centros de reciclado para desechar el producto o las baterías.

Cómo colocar y retirar las baterías

Utilice un destornillador Phillips pequeño para aflojar el tornillo. Inserte 2 baterías AA nuevas (LR6) en el compartimiento con la polaridad correcta (+/-), como se muestra aquí.



Varillas flexibles

Una Varilla Flexible es una Varilla que se puede doblar para formar curvas. Serán más fáciles de conectar a tu modelo si primero las doblas hacia atrás y hacia adelante.





Instruções básicas para montar o K'NEX

CUIDADO: Mantenha as mãos, rosto, cabelo e roupas longe das partes em movimento.

Comece a montar

Para começar a montar o modelo, encontre o número do passo e siga os números. Cada peça tem a sua própria forma e cor. Estude as ilustrações, encontre as peças que coincidem com o que você estiver vendo e conecte-as. Fique de frente para o modelo, na mesma direção que as figuras mostradas nas instruções. As setas mostram onde as peças se conectam, mas nem todos os pontos de conexão têm setas. As partes com cores desbotadas são as que você já montou.

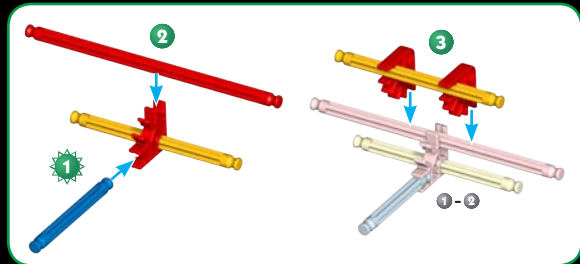

Conectores

Você pode fazer com que estes conectores se deslizem e se conectem. Empurre até ouvir um "clique". Preste atenção às instruções e posicione-os horizontal ou verticalmente exatamente conforme a ilustração.

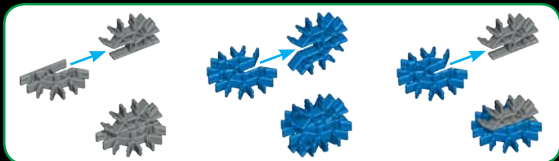

Informações sobre as pilhas

CUIDADO:

- Coloque as pilhas corretamente e sempre siga as instruções de fabricantes de brinquedos e pilhas.
- Não misture pilhas velhas com pilhas novas ou alcalinas, ou pilhas padrão (carvão-zinco) com pilhas recarregáveis (níquel-cádmio). Somente pilhas do mesmo tipo ou tipo equivalente devem ser usadas.
- Sempre remova as pilhas fracas ou descarregadas do produto; não provoque um curto circuito nos terminais.
- Coloque as pilhas com a polaridade correta (+/-), como exibido.

Dicas importantes

- Recomenda-se usar pilhas alcalinas AA (LR6).
- Não é recomendado o uso de pilhas recarregáveis.
- Remova as pilhas recarregáveis do brinquedo antes de carregar; elas devem ser carregadas somente sob a supervisão de um adulto.
- As pilhas não recarregáveis não devem ser colocadas.
- Mantenha os componentes livres de pó e não submerja ou use abaixo d'água.
- Não descarte as pilhas perto do fogo, pois elas podem vazarem ou explodir e causar ferimentos.

- Remova todas as pilhas se o brinquedo não estiver sendo usado por um longo período de tempo.
- Não coloque varas menores do que 2 polegadas (2,54 centímetros) em qualquer abertura do motor; elas danificarão o motor e não poderão ser removidas.
- Ajude ao meio ambiente descartando o produto e a embalagem de maneira responsável. O símbolo da lata de lixo com rodinhas indica que o produto e as pilhas não devem ser descartados no lixo doméstico, pois eles contêm substâncias que podem ser prejudiciais ao ambiente e à saúde. Use os pontos designados de coleta de lixo ao descartar o item ou as pilhas.

Como colocar e remover as pilhas

Use uma pequena chave de fenda para desparafusar o parafuso. Coloque 2 pilhas pequenas, tamanho AA novas (LR6) no compartimento com a polaridade correta (+/-), conforme mostrado aqui.



Varetas flexíveis

Uma vareta flexível é uma vareta que puedes dobrar para formar curvas. Para montares no teu modelo, será mais fácil se dobrares primeiro a vareta para trás e para a frente.



KNEX.COM

Transport Chopper Building Set™



** Sold separately. Se venden por separado. Vendido separadamente.



+



=



COMBO BUILD™

Visit www.knex.com/instructions and enter code 11977 to find instructions for this model.

Visita www.knex.com/instructions e introduzca el código 11977 para encontrar las instrucciones para este modelo.

Visite www.knex.com/instructions e digite o código 11977 para encontrar as instruções para este modelo.

Product & colors may vary. K'NEX is a registered trademark of K'NEX Limited Partnership Group.
El producto y los colores pueden variar. K'NEX es una marca registrada de K'NEX Limited Partnership Group.
O produto e as cores podem variar. K'NEX é uma marca registrada do K'NEX Limited Partnership Group.

1-800-KID-KNEX. (USA/EE.UU./États-Unis/Canada); email@knex.com; www.knex.com. Customer outside the USA/Canada contact your local distributor at www.knex.com/distributors (ES) Los clientes fuera de EE. UU./Canadá pueden contactar a su distribuidor local en www.knex.com/distributors (PT) Consumidores fora dos EUA ou Canadá devem entrar em contato com distribuidores locais da www.knex.com/distributors (AU) (BE) (CL) (DE) (MX) (NL) (NZ) www.knex.com/distributors. (UK) TOMY Careline, PO Box 20, Totton, Hants, SO40 3YF; Tel 023 8066 2600. (FR) ALLO TOMY SAV, Parc d'affaires international, 74166 ARCHAMPS; Tél 0 820 013 013. (DE) (FR) (NL) (UK) www.tomy.eu

* Aniversario
Aniversário



TOMY S040 3SA England

©2012 K'NEX Limited
Partnership Group
P.O. Box 700
Hatfield, PA
19440-0700

111977-V1-02-12



facebook.com/buildknex