

# K'nex

## T-REX FURY

Roller Coaster  
Building Set

## FUREUR DU T-REX

Montagnes Russes  
Jeu de construction

# THRILL RIDES

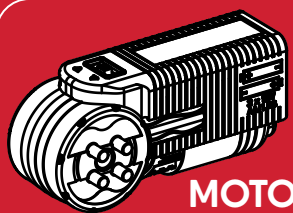
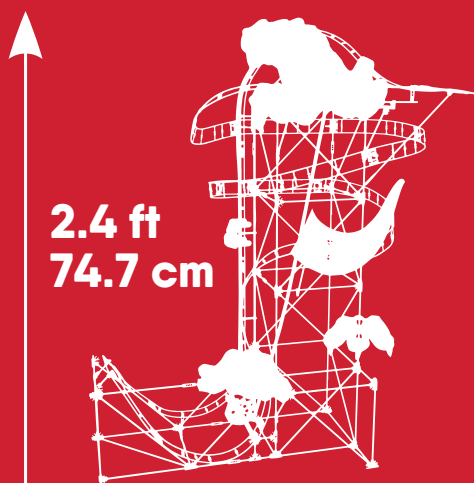

AA (LR6) AA (LR6)

Not Included

### ⚠ WARNING:

CHOKING HAZARD – Small parts.  
Not for children under 3 years.

### ⚠ ATTENTION :

RISQUE D'ÉTOUFFEMENT – Pièces de petite taille.  
Ne convient pas aux enfants de moins de 3 ans.

Ages

9-14

27152



K'nex  
RIDE IT!

**BUILD & RIDE APP  
+ VIEWER INCLUDED**

# Keep this important information for future reference

**WARNING:** CHOKING HAZARD – Small parts. Not for children under 3 years.

**CAUTION:** Keep hands, face, hair and clothing away from all moving parts.

**CAUTION:** Be careful not to tip the model over. Model should be placed on a flat and hard surface.

Do not obstruct track with objects or any part of your body.

## Battery Information

### How to Insert and Remove Batteries

Use a small Phillips head screwdriver to loosen the screw. Insert 2 fresh AA batteries\*\* (LR6) into the compartment with the correct polarity (+/-) as shown here. Install batteries before building models.

\*\* Not included



### CAUTION: To Avoid Battery Leakage

- Insert batteries with correct polarity (+/-) as shown.
- Do not mix different types of batteries.
- Do not mix alkaline, standard (carbon-zinc) or rechargeable batteries.
- Do not mix new and used batteries. Only batteries of the same or equivalent type recommended should be used.
- Remove exhausted batteries from the toy; do not short-circuit supply terminals.
- Remove all batteries if the toy will not be used for a long period of time.

### Important Tips

- Alkaline batteries are recommended.
- Rechargeable batteries are not recommended.
- Remove rechargeable batteries before recharging; they must be charged only under adult supervision.
- Non-rechargeable batteries must not be recharged.
- Keep components free of dust; do not immerse or use in water.
- Do not dispose of batteries in a fire; they could leak or explode and cause injury.

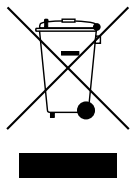

The wheeled bin indicates this product cannot be disposed of with household waste due to presence of hazardous substances.

To protect human health and environment, check your local authority for recycling advice and facilities (2012/19/EU, Europe only).

# Gardez précieusement cette notice pour vous y référer ultérieurement

**ATTENTION :** RISQUE D'ÉTOUFFEMENT – Pièces de petite taille. Ne convient pas aux enfants de moins de 3 ans.

**ATTENTION :** Garde les cheveux, les doigts, la figure et les vêtements à l'écart de toutes les pièces mobiles.

**ATTENTION :** Faire attention de ne pas renverser le modèle. Le modèle devrait être placé sur une surface plate et dure.

Ne pas bloquer les rails avec des objets ou la corps.

## Informations sur les Piles

### Comment mettre et retirer des piles

Utiliser un petit tournevis pour desserrer la vis et pour enlever le couvercle des piles. Insérer 2 piles AA (LR6)\*\* neuves dans le compartiment en respectant une polarité (+/-). Installe les piles avant de réaliser tes constructions.

\*\* Pas inclus

### ATTENTION : Pour éviter la fuite des piles

- Insérez les piles en respectant la polarité (+/-) comme indiqué.
- Ne pas mélanger différents types de piles.
- Ne pas mélanger des piles alcalines avec des piles standard (carbone-zinc), ou des piles rechargeables.
- Ne pas mélanger des piles neuves avec des piles usées. Il convient d'utiliser uniquement des piles du type recommandé ou d'un type équivalent.
- Retirer toujours les piles faibles ou mortes du produit ; ne pas faire court-circuiter les terminaux.
- Retirez toutes les piles si le jouet ne sera pas utilisé pendant une longue période de temps.

### Conseils Importants

- Les piles alcalines sont recommandées.
- Les piles rechargeables ne sont pas recommandées.
- Retirer les piles rechargeables du jouet avant de les recharger; elles doivent être chargées exclusivement en présence d'un adulte.
- Les piles qui ne sont pas rechargeables ne doivent pas être rechargées.
- Veiller à ce que les éléments restent à l'abri de la poussière ; ne pas les plonger ni les utiliser dans l'eau.
- Ne pas jeter les piles dans le feu ; elles risqueraient de fuir ou d'exploser et d'entraîner des blessures.



Le symbole "poubelle à roulettes" indique que ce produit ne peut pas être éliminé avec vos déchets ménagers en raison de la présence de substances dangereuses.

Afin de protéger votre santé et l'environnement, renseignez-vous auprès de vos autorités locales afin d'obtenir des conseils sur le recyclage et la localisation des installations adaptées (2012/19/EU, Europe uniquement).

## Start Building

Each piece has its own shape and color. Just look at the pictures, find the pieces in your set that match and then connect them together. Try to face your model in the same direction as the instructions while you build. The arrows show you where the parts connect, but not all connections points have arrows. Faded colors show you this section is already built.

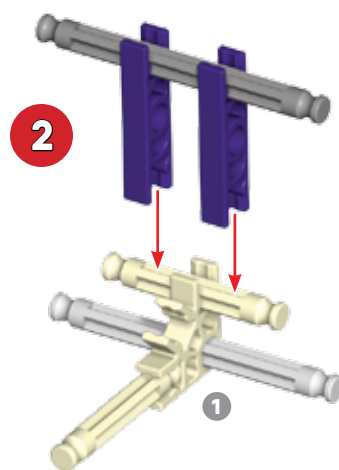
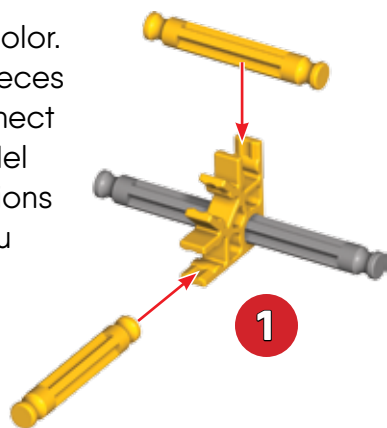

## Démarre ta Construction

Chaque pièce a sa propre forme et sa propre couleur. Regarde les illustrations, trouve les pièces qui y correspondent et les assemble-les. Pour te faciliter la tâche, oriente le modèle dans le même sens que les instructions. Les flèches indiquent où les pièces s'assemblent, mais les points de raccordement n'ont pas tous des flèches. Les pièces ayant une couleur estompée sont celles déjà assemblées.

## Connectors

You can slide these special connectors together. Push tightly until you hear a "click". Pay close attention to the instructions and position them horizontally or vertically exactly as they are shown.

## Connecteurs

Tu peux assembler ces connecteurs spéciaux en les faisant glisser l'un dans l'autre. Pousse fort jusqu'à entendre un « clic ». Lis attentivement les instructions et positionne-les horizontalement ou verticalement, en suivant exactement les illustrations.

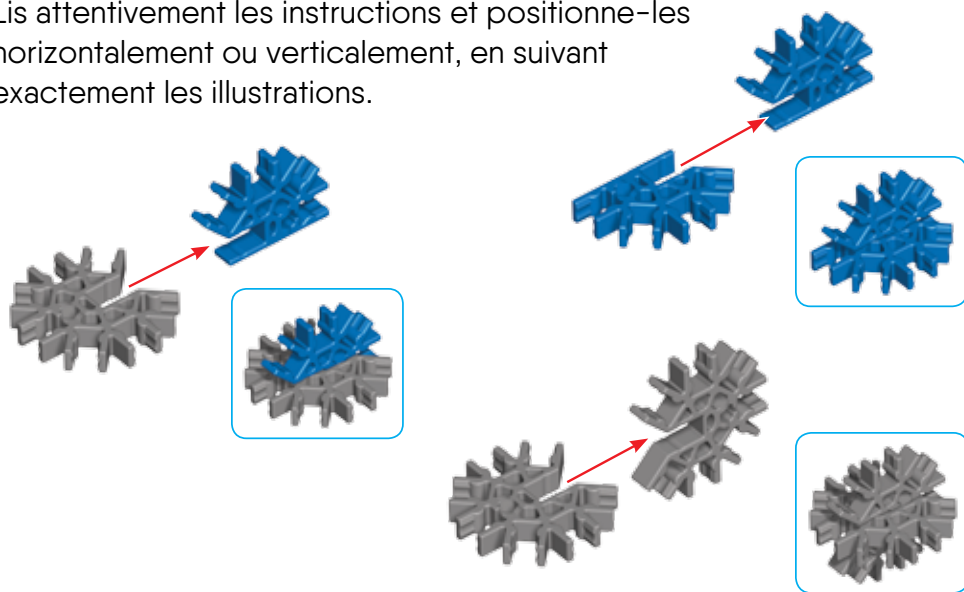

## Spacers

There are places in your model where you need to add spacers. Be sure to use the correct number of spacers shown in the instructions.



## Séparateurs

Il y a des endroits sur le modèle où des séparateurs sont nécessaires. Assure-toi d'utiliser la bonne nombre de séparateurs, comme indiqué sur les instructions.

## Chain

Be sure to attach all the chain links in the same direction.



## Chaîne

Assure-toi de fixer tous les maillons de la chaîne dans le même sens.



## VR Viewer Warnings and Instructions

Keep this important information for future reference.  
Read before use:

- Use viewer only when sitting. **DO NOT** use viewer while standing or walking.
- **CAUTION!** Hold the viewer with both hands to prevent damage to your device. Viewer does not provide protection for a device.
- Discontinue use if you experience motion sickness.
- Avoid using the VR in potentially dangerous surroundings which include sharp objects, balconies, stairwells and furnishings that are easy to break.
- Anyone who has had a seizure, loss of awareness, or other symptom linked to an epileptic condition should see a doctor before using a viewer.
- Avoid prolonged use of a viewer, which can negatively impact hand-eye coordination, balance, and multi-tasking ability. Limit the time spent using a viewer and take breaks during use. Always ask an adult before using the VR viewer.
- Viewer can hold a device up to 6.2" x 3.0" x 0.30".
- Compatible devices can be used with most VR viewers.

## Instruction et mise en grade pour utilisateur du VR

Garde précieusement cette notice pour t'y référer ultérieurement. Lisez avant utilisation :

- Utilisez la visionneuse uniquement lorsque vous êtes assis. **N'UTILISEZ PAS** la visionneuse lorsque vous êtes debout ou en train de marcher.
- **Mise en garde !** Tenez la visionneuse à deux mains pour éviter d'endommager votre appareil. La visionneuse n'offre aucune protection pour le périphérique.
- Cessez d'utiliser si vous souffrez du mal des transports.
- Évitez d'utiliser le VR dans un environnement potentiellement dangereux, notamment des objets tranchants, des balcons, des cages d'escaliers et des meubles faciles à briser.
- Toute personne qui a eu une crise, une perte de conscience ou tout autre symptôme lié à une maladie épileptique devrait consulter un médecin avant d'utiliser la visionneuse.
- Évitez tout l'utilisation prolongée de la visionneuse, ce qui peut nuire à la coordination œil-main, à l'équilibre et à la capacité multitâche. Limitez le temps passé en visionneuse et prenez des pauses pendant l'utilisation. Demandez toujours à un adulte avant utilisation du VR visionneuse.

• La visionneuse peut supporter un appareil jusqu'à 15.75cm x 7.60cm x 0.75cm.

• Les appareils compatibles peuvent être utilisés avec la plupart des VR visionneuses.

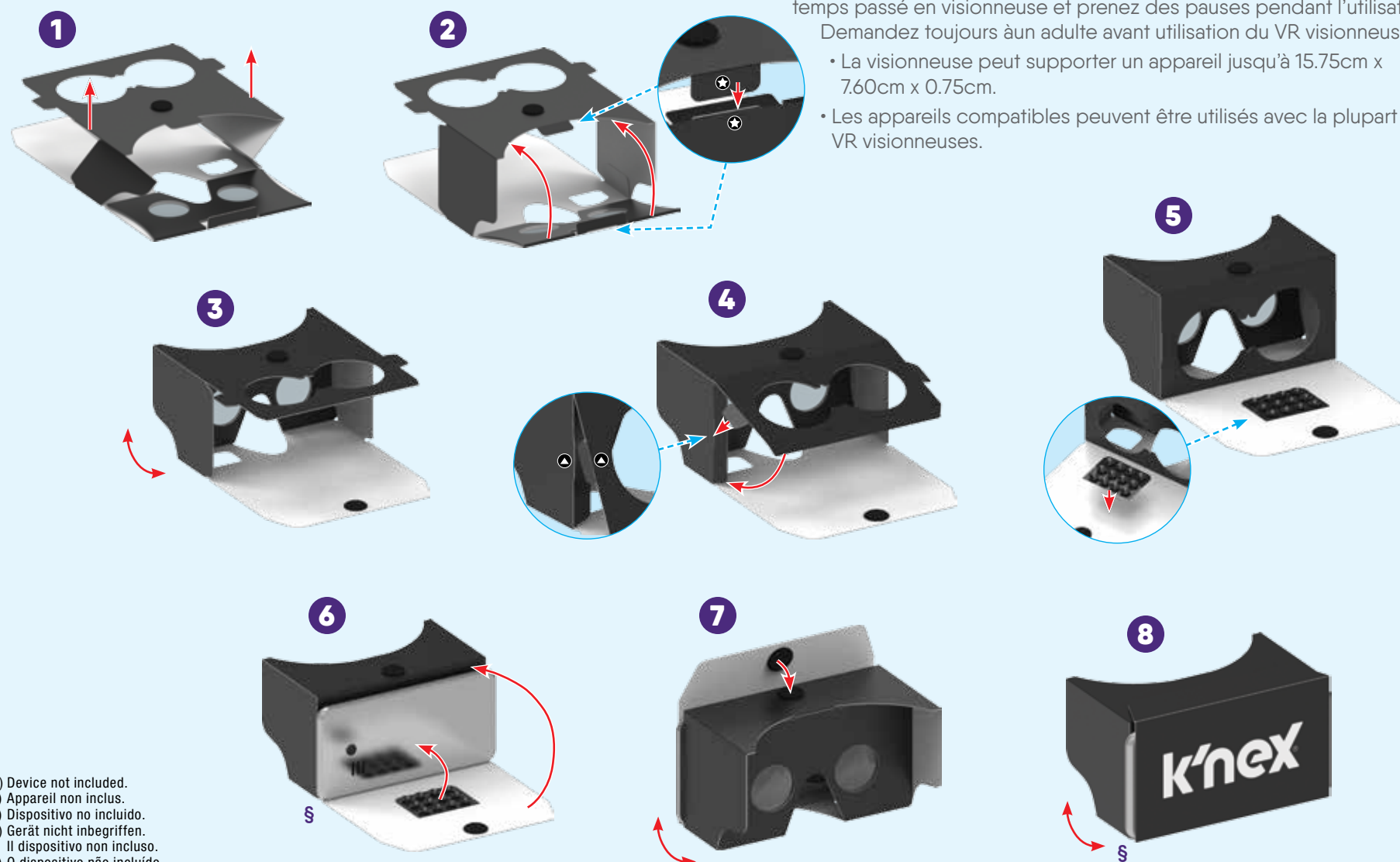

§ (EN) Device not included.  
(FR) Appareil non inclus.  
(ES) Dispositivo no incluido.  
(DE) Gerät nicht inbegriffen.  
(IT) Il dispositivo non incluso.  
(PT) O dispositivo não incluso.  
(NL) Apparaat niet meegeleverd.

**k'nex**

# T-REX FURY FUREUR DU T-REX



**TIP:** While you're building make sure you face your model in the same direction as the pictures show in the instructions.

**CONSEIL :** Essaye de situer ton modèle dans le même sens que les instructions durant le montage.

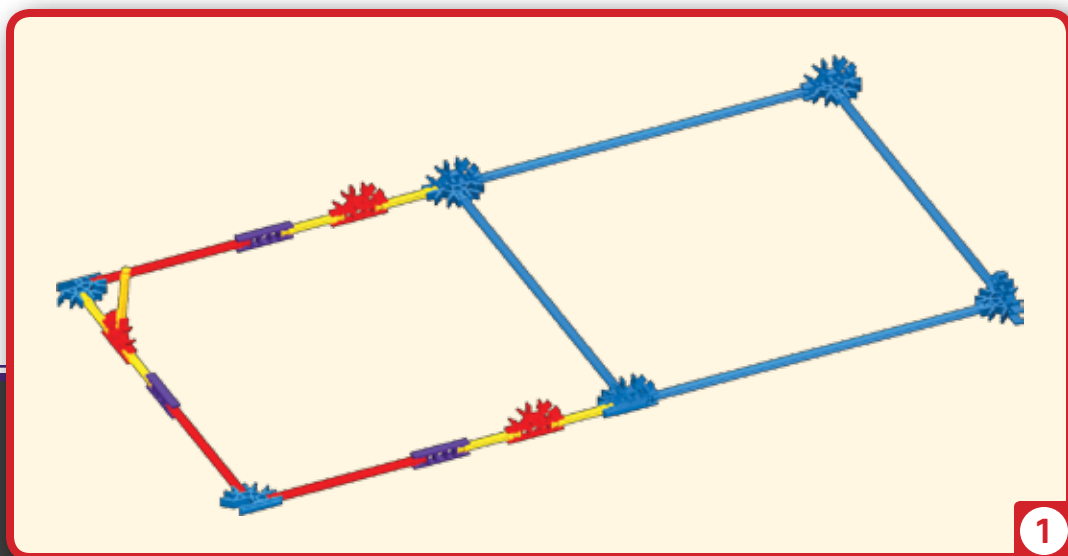
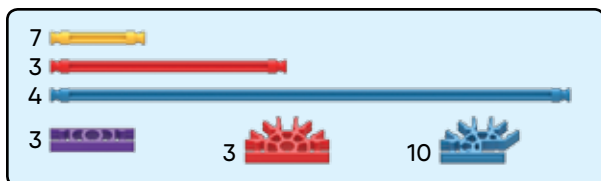
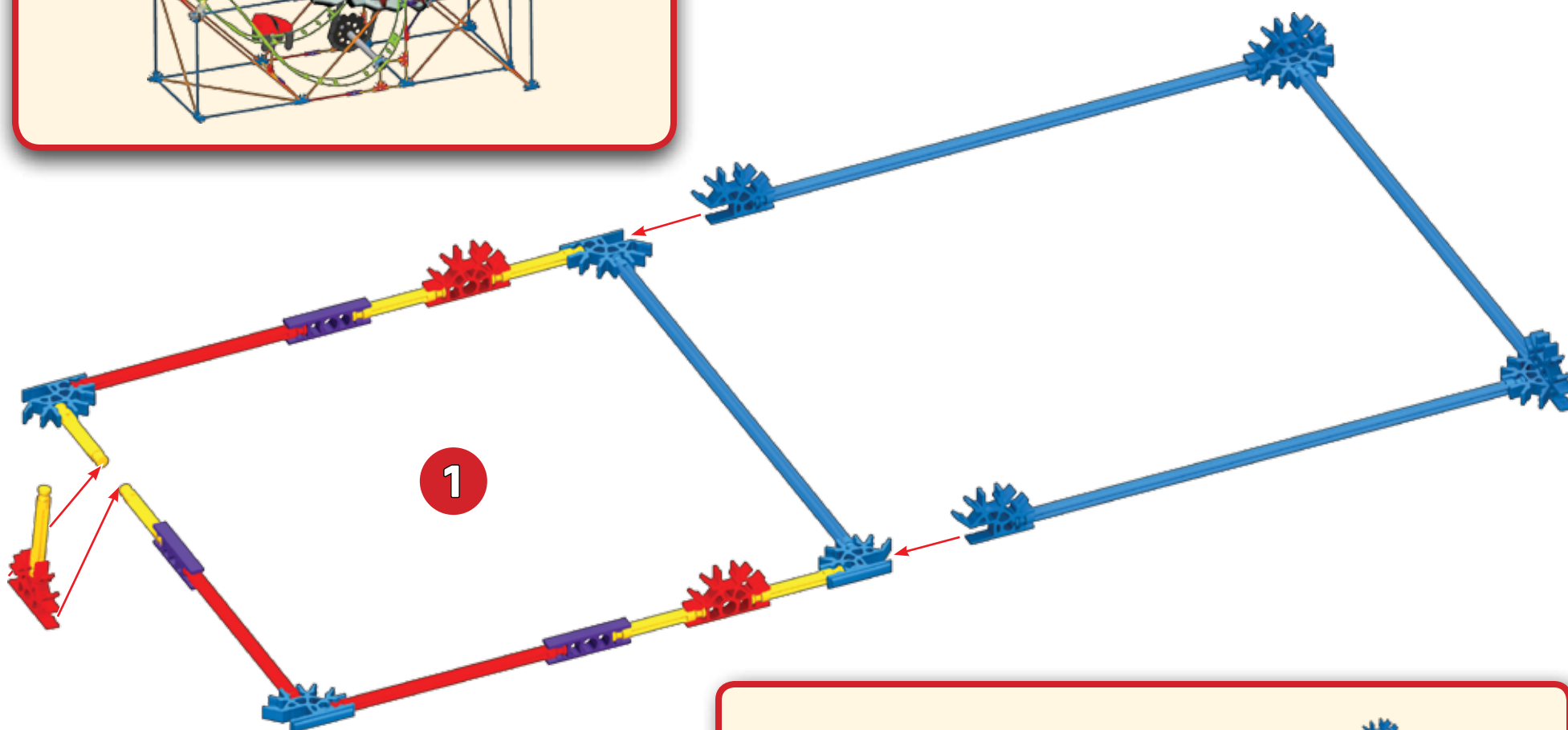

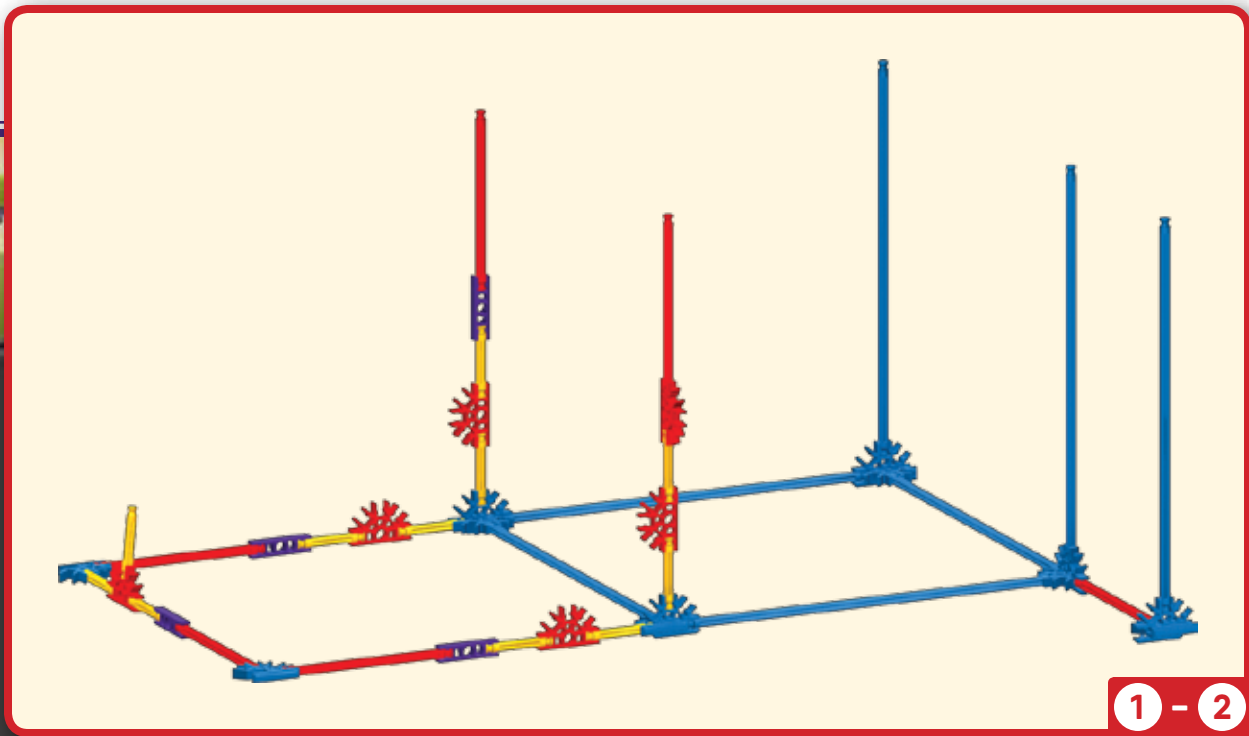
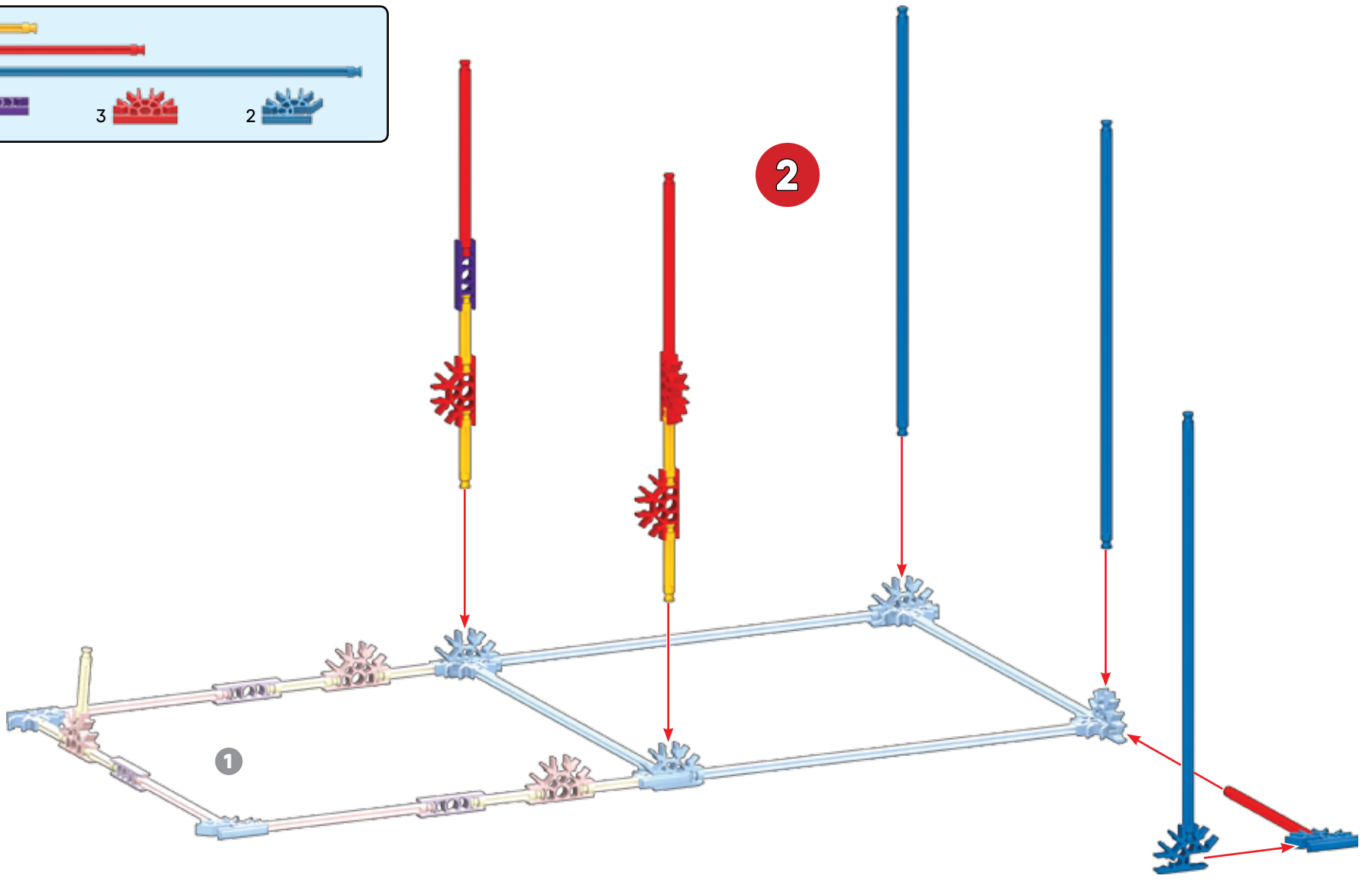
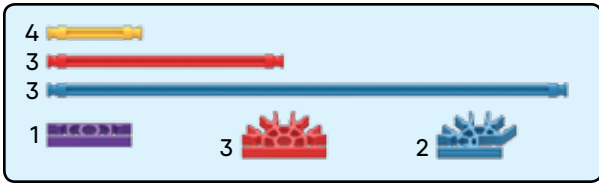

3

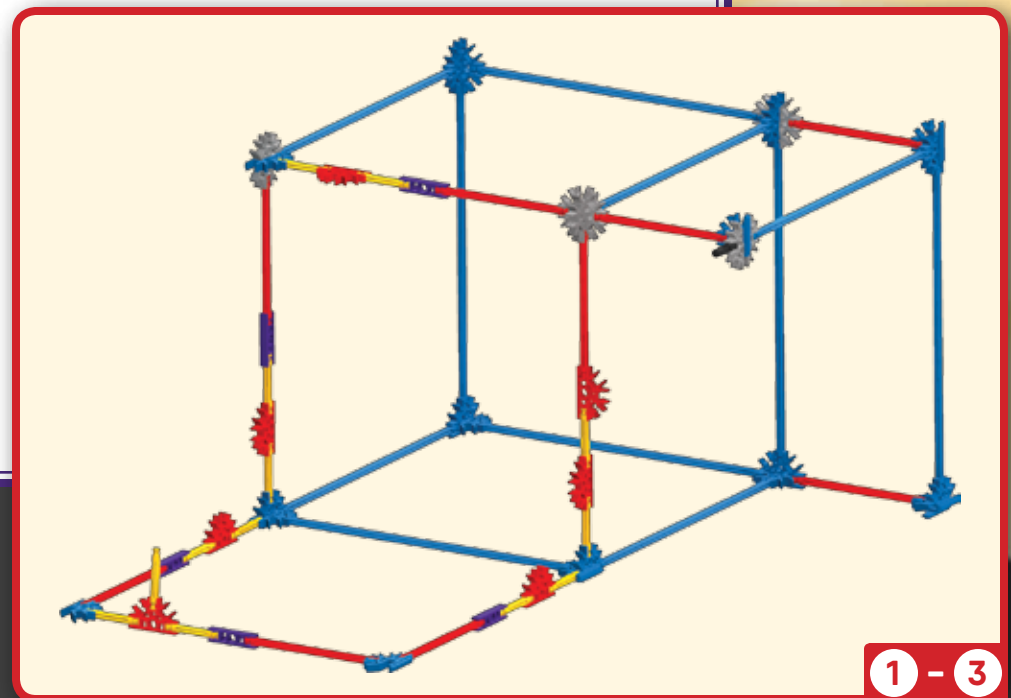
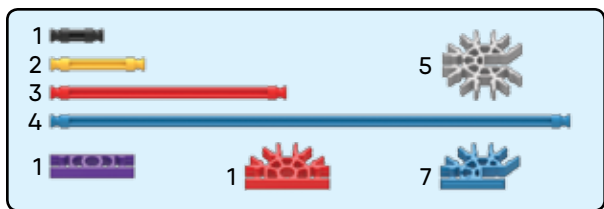
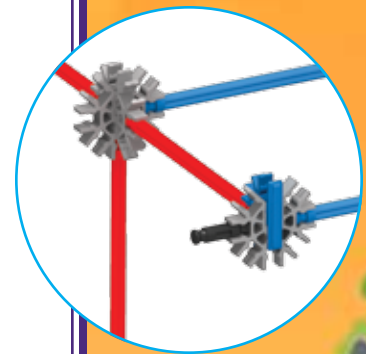
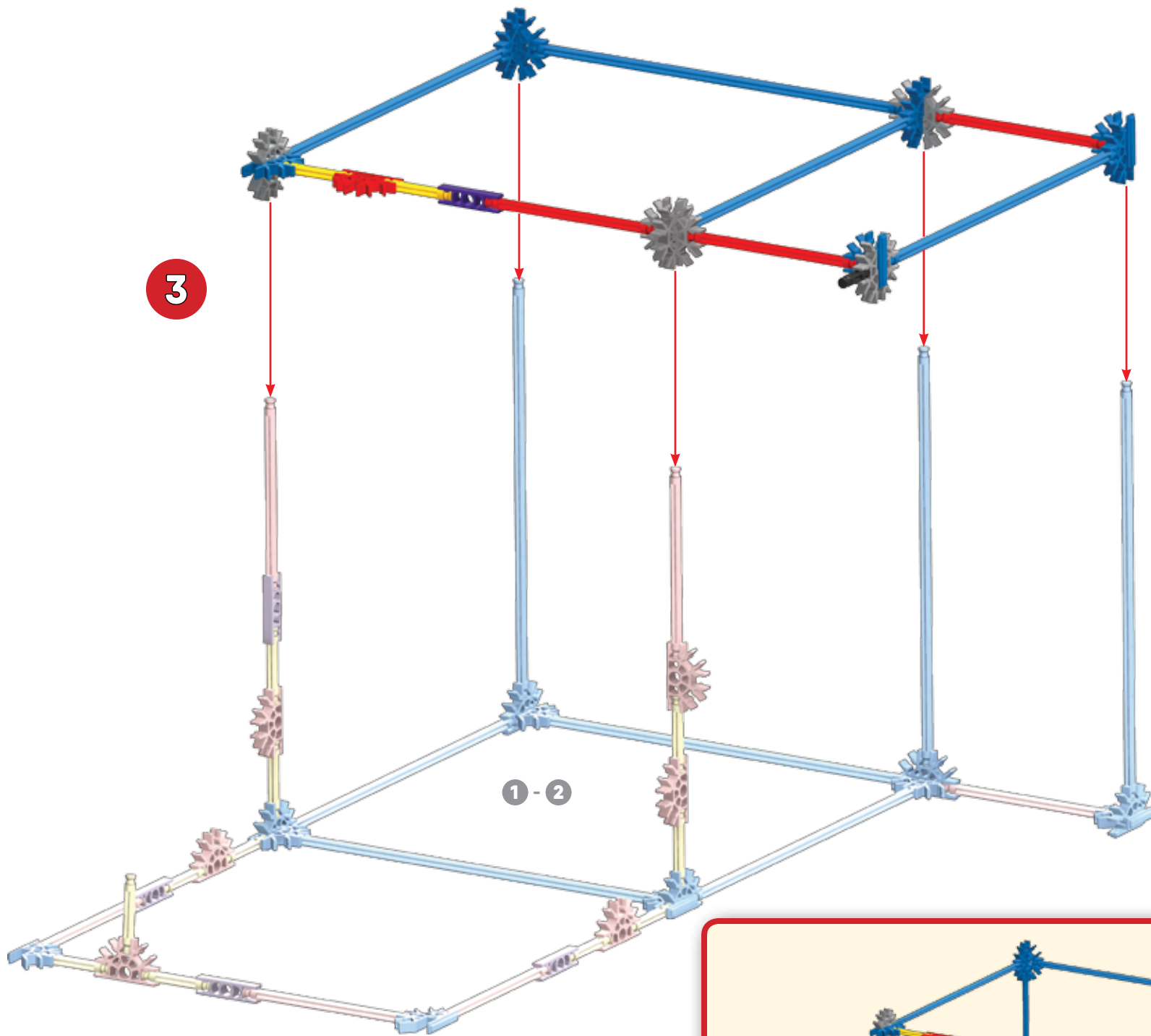

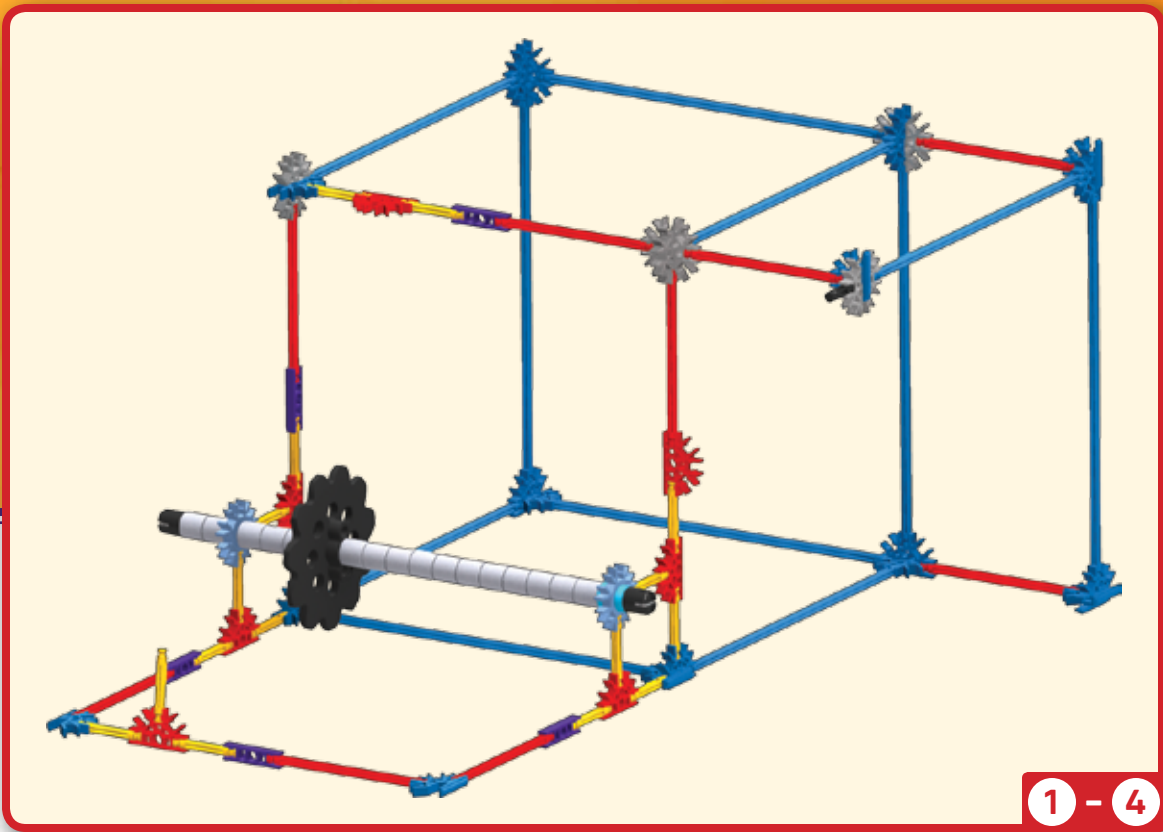

1 - 4

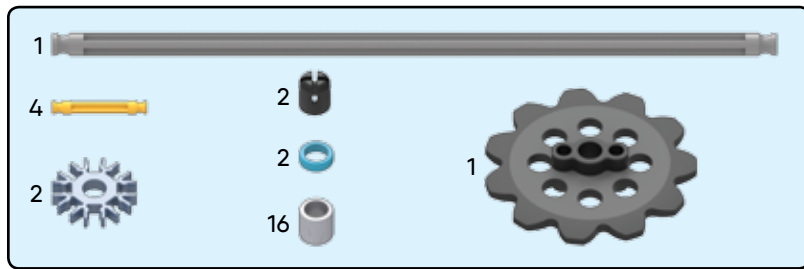

4

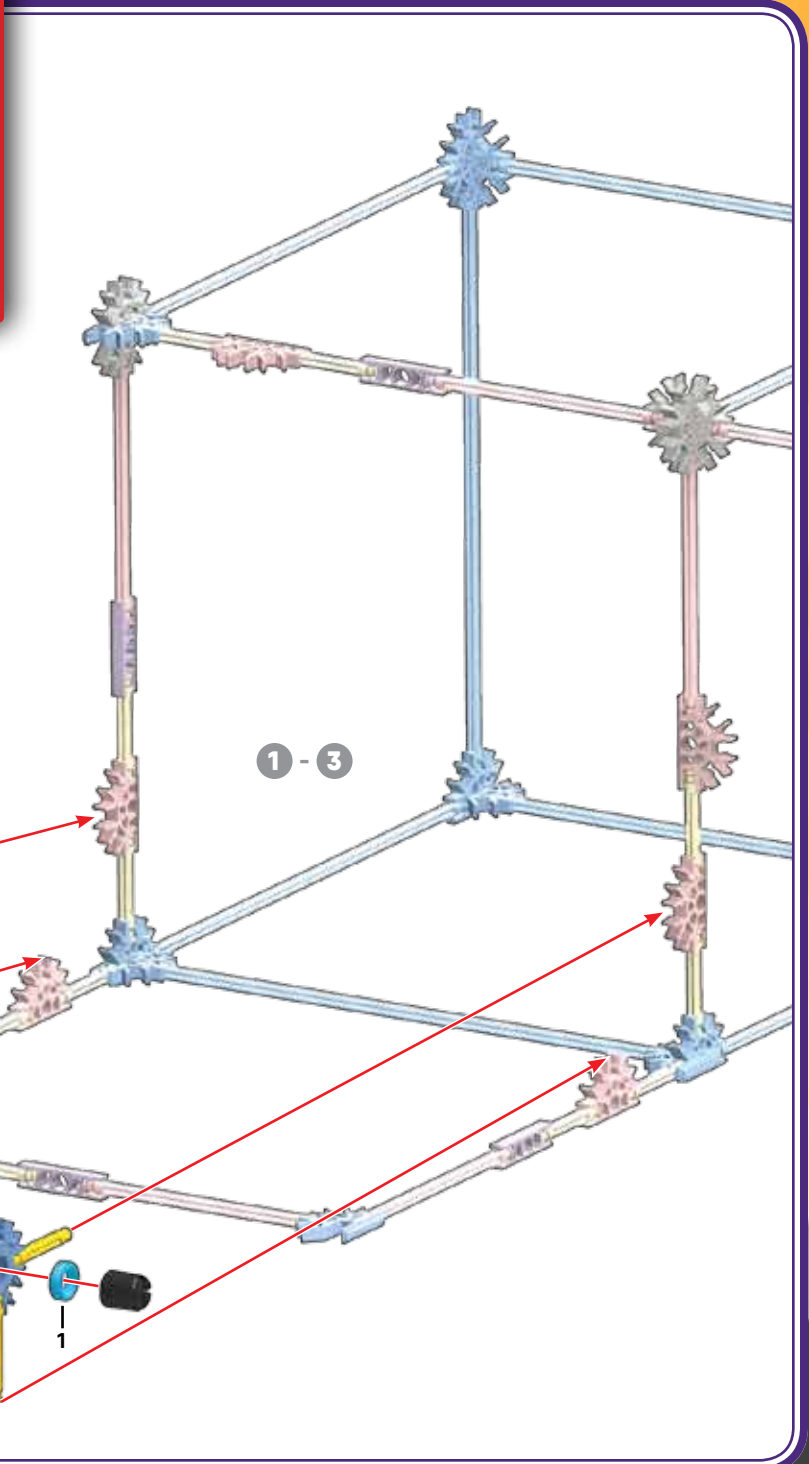
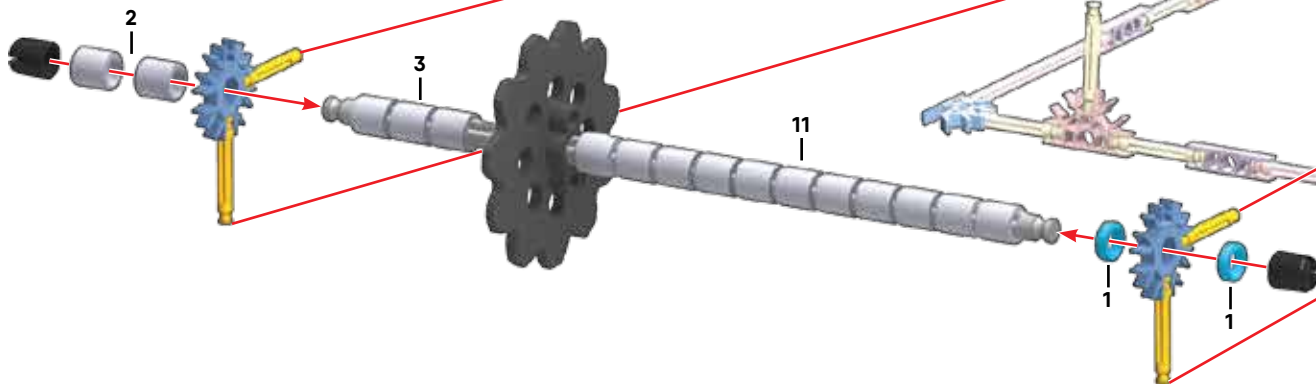

1 - 3

- |   |  |   |  |
|---|--|---|--|
| 1 |  |   |  |
| 2 |  |   |  |
| 2 |  |   |  |
| 7 |  |   |  |
| 1 |  | 1 |  |
|   |  | 9 |  |
| 1 |  | 1 |  |
|   |  | 1 |  |

5

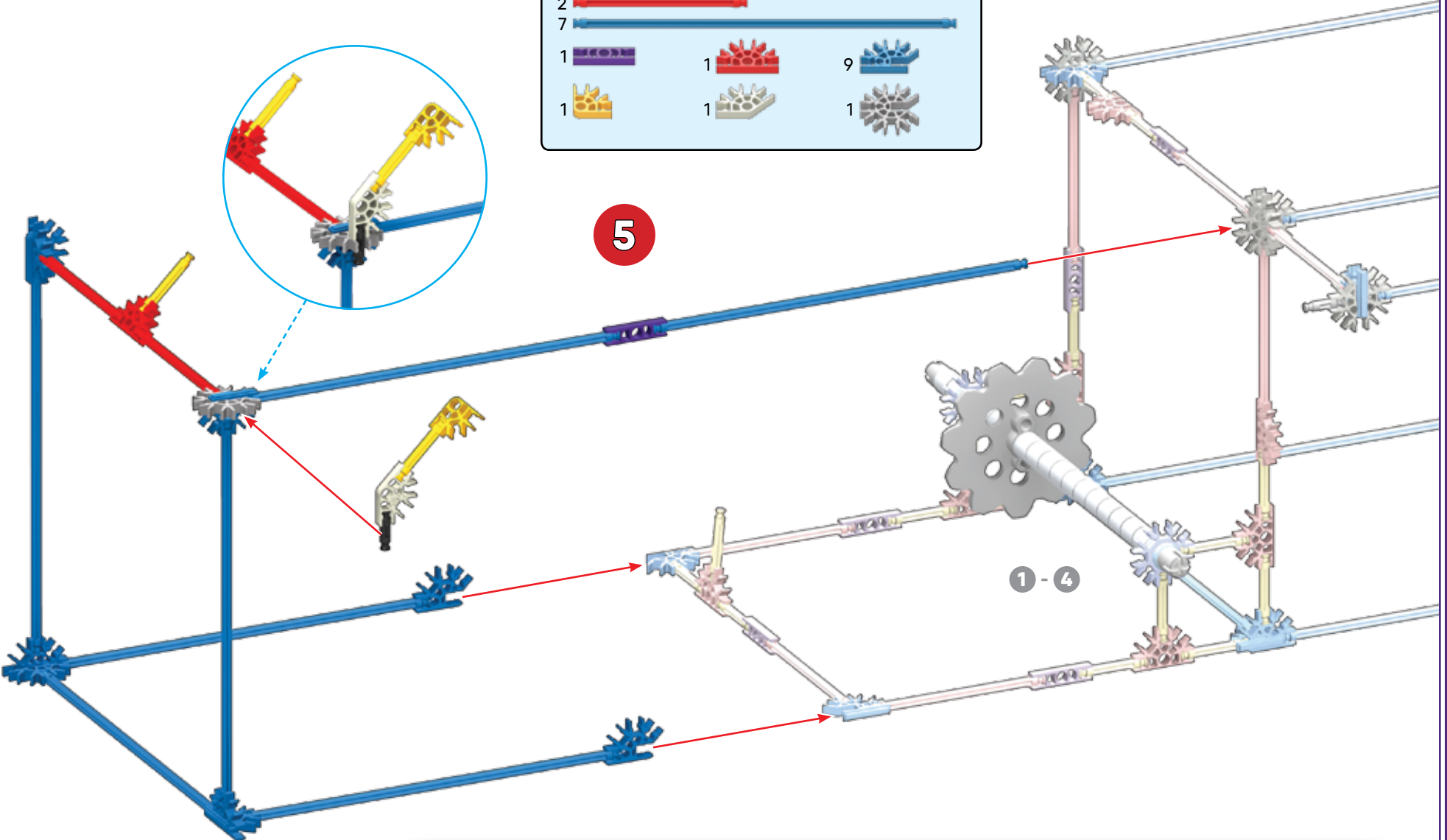

1 - 4

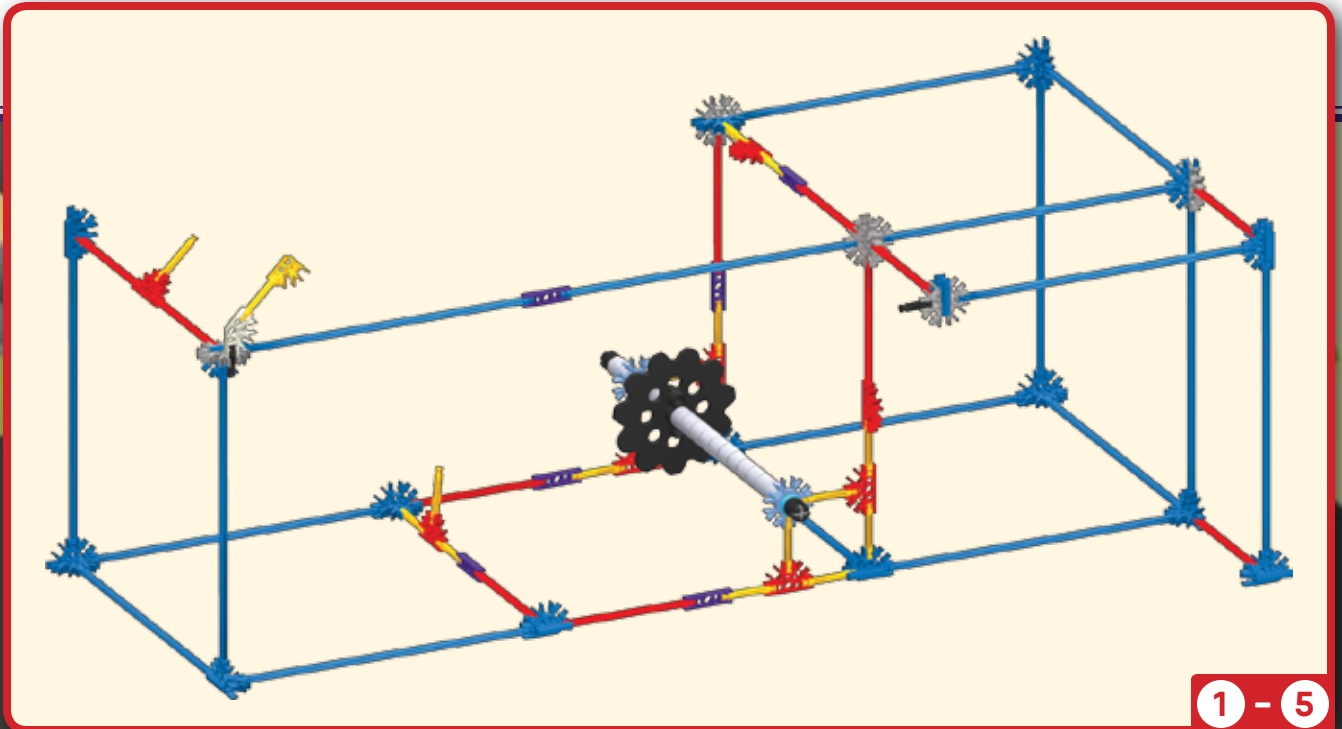

1 - 5

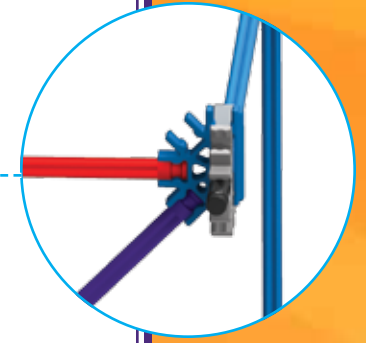
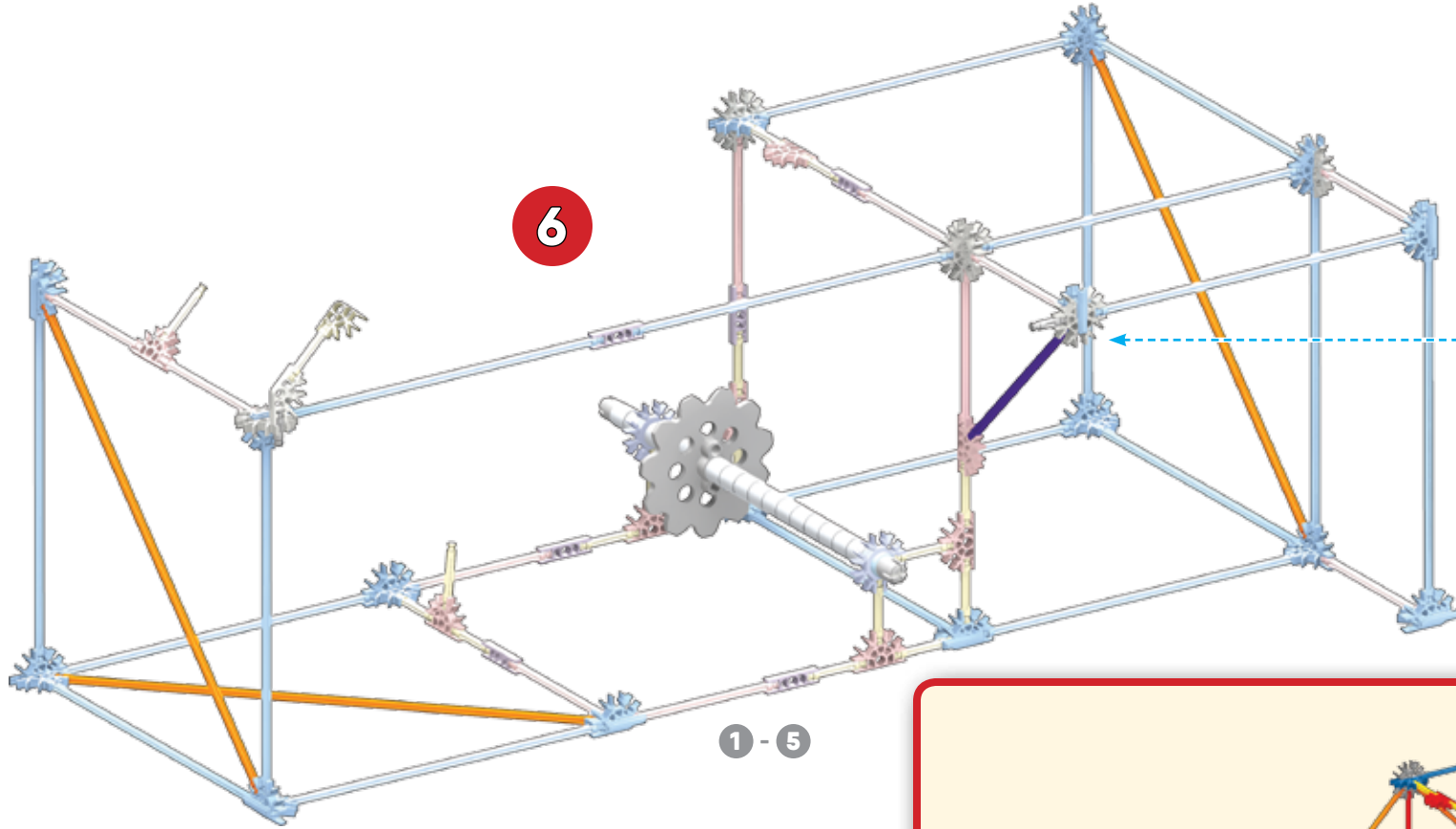

1 - 5

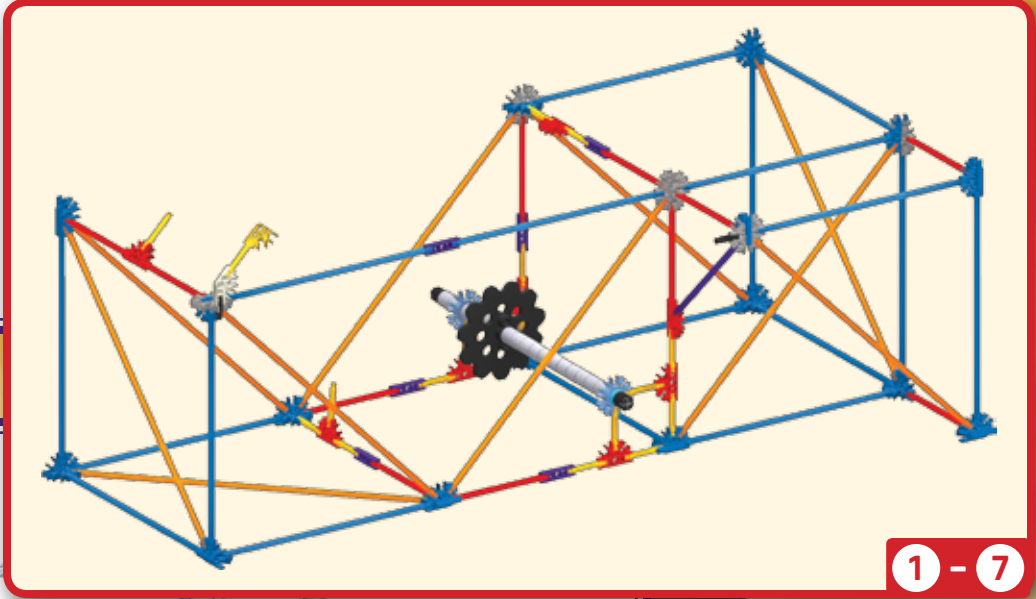

1 - 7

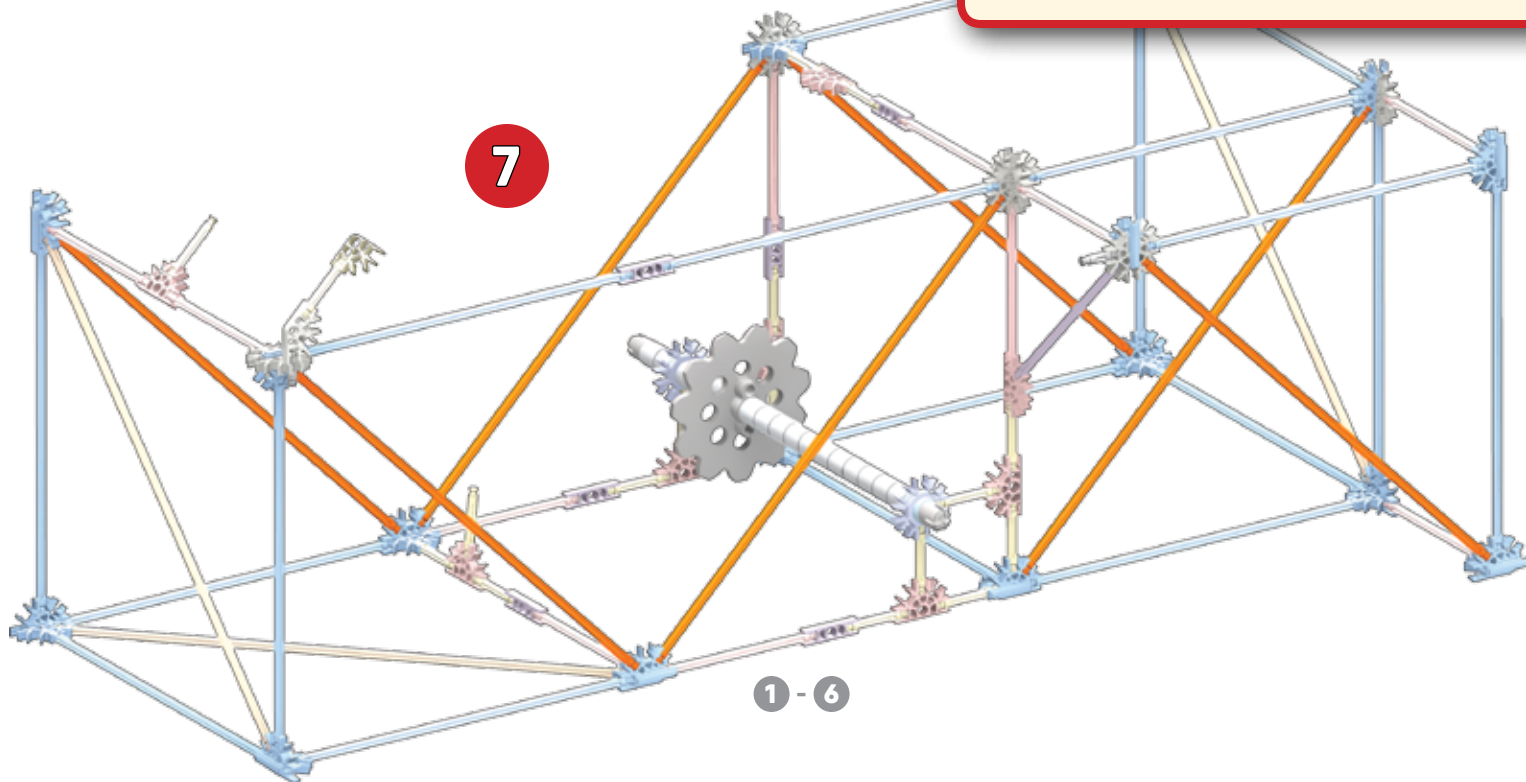

1 - 6

8

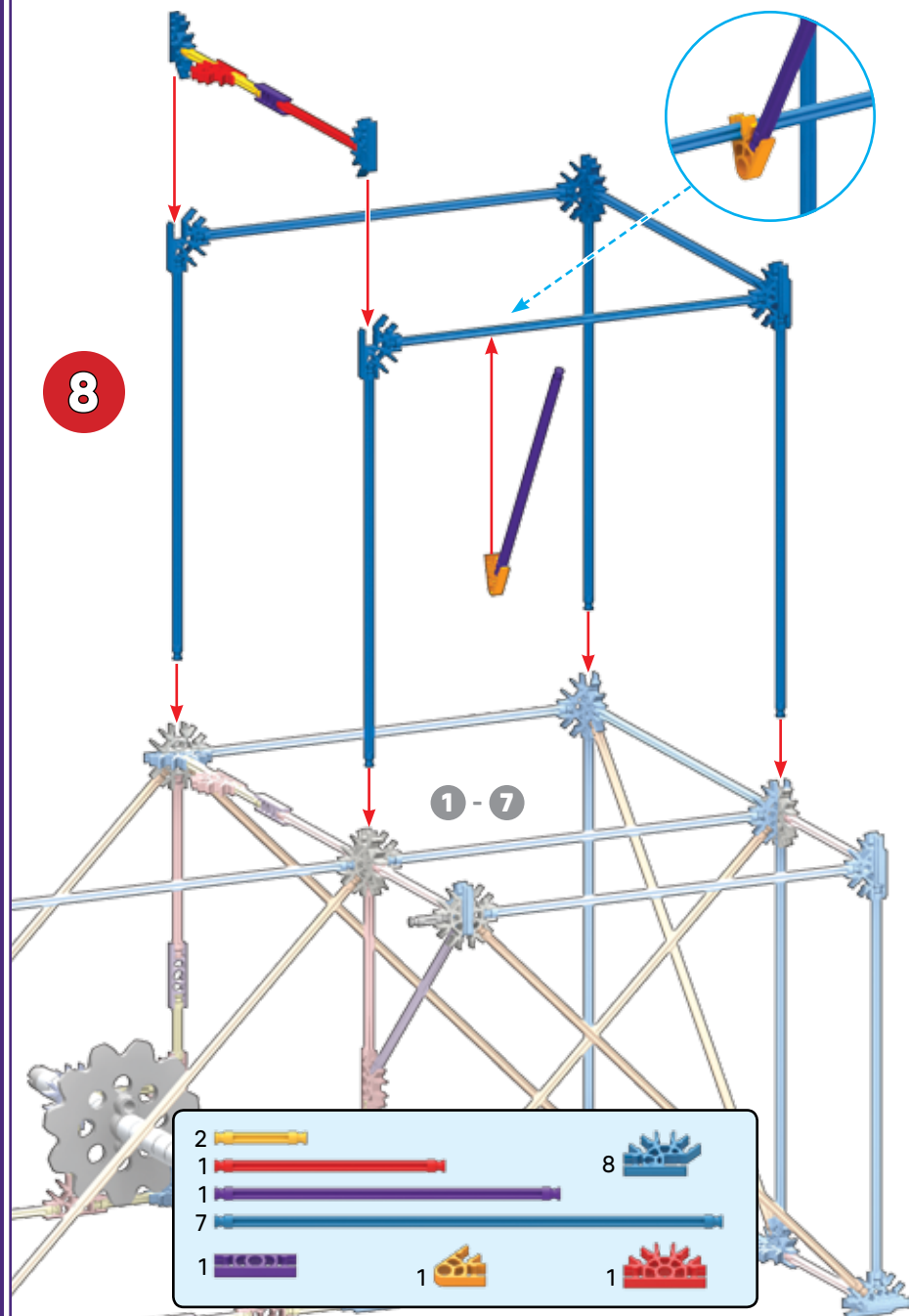

- 2
- 1
- 1
- 7
- 1
- 1
- 1
- 8

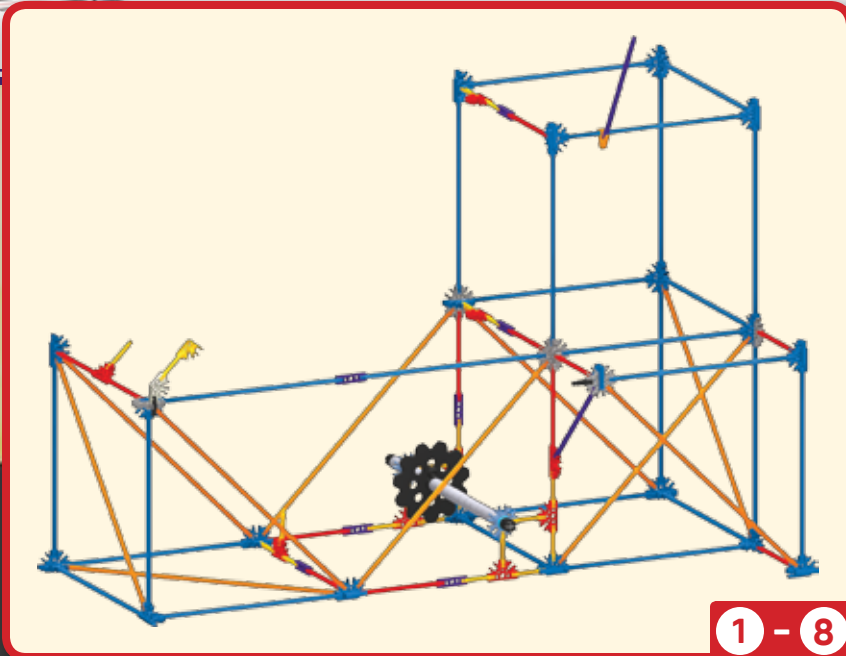

1 - 8

9

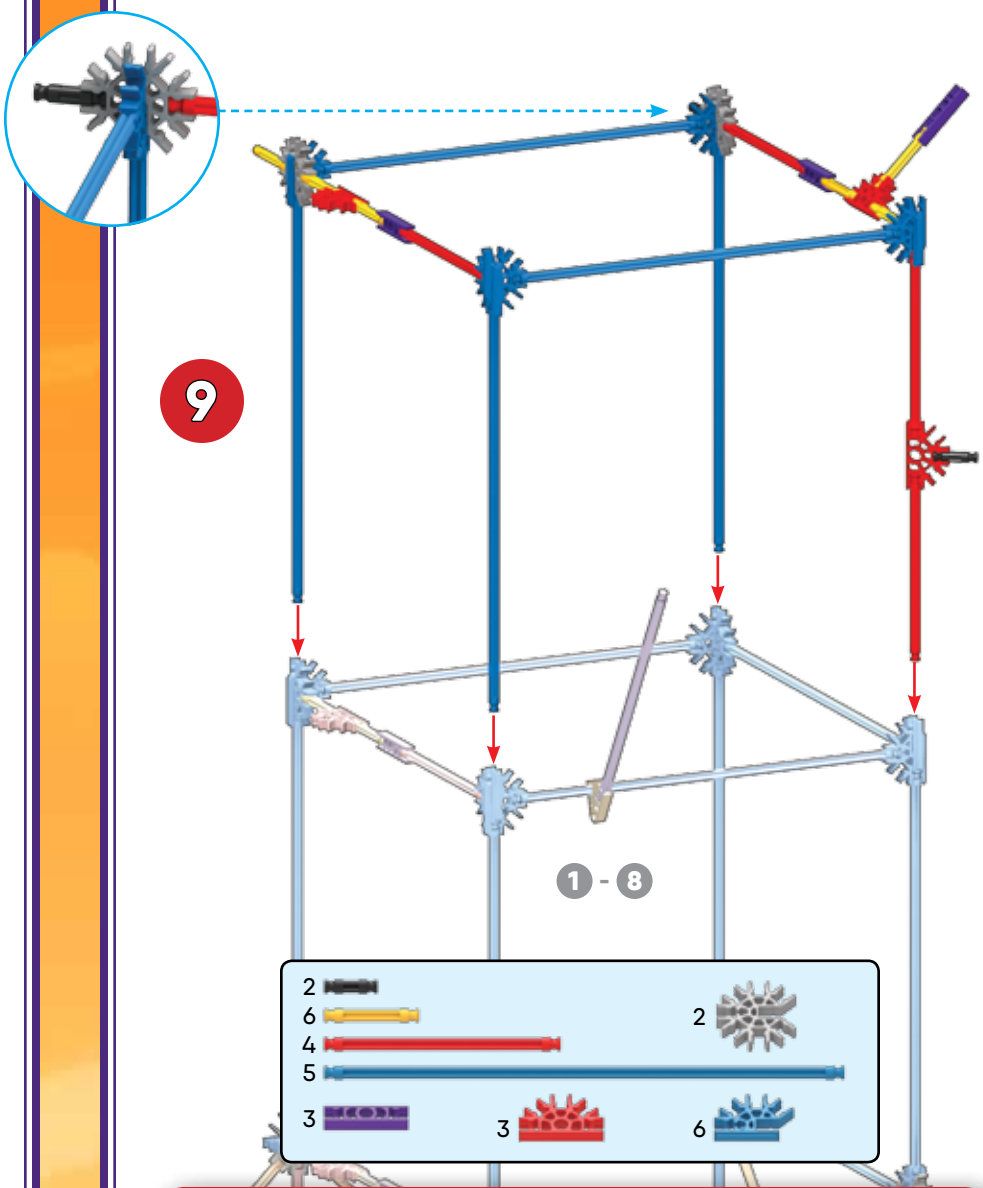

- 2
- 6
- 4
- 5
- 3
- 3
- 2
- 6

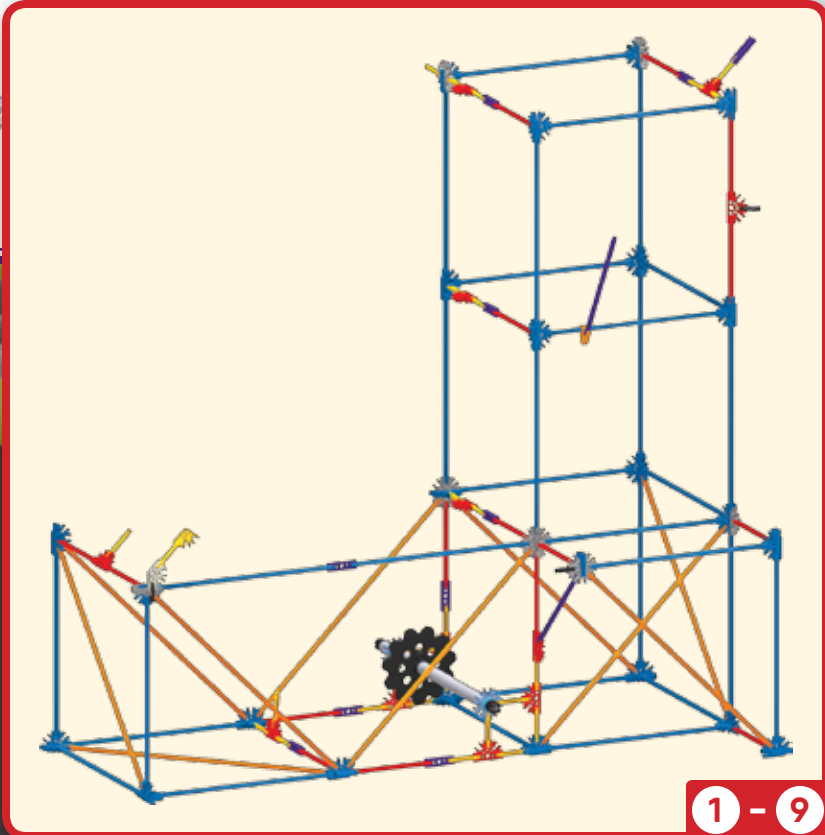

1 - 9

10

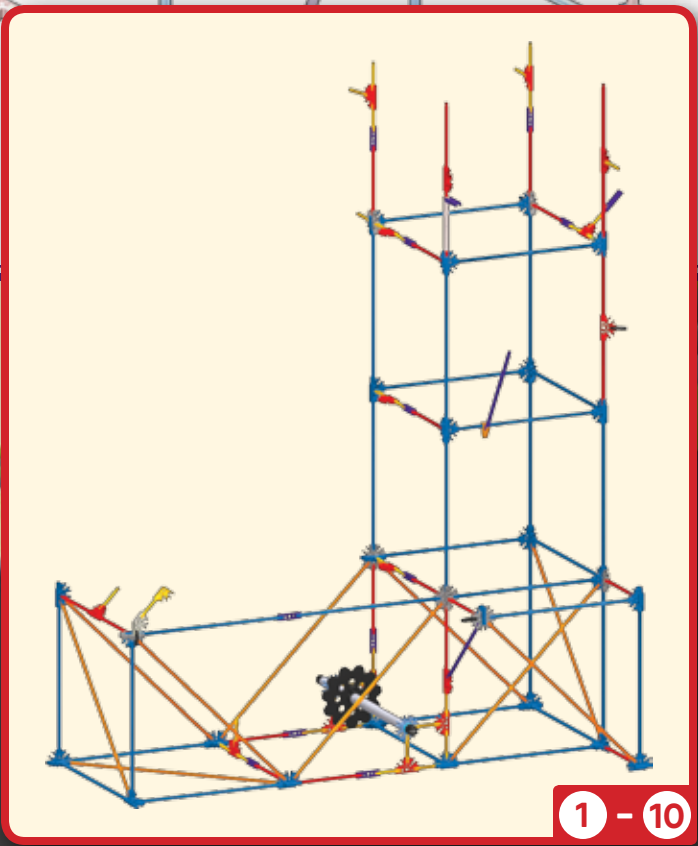
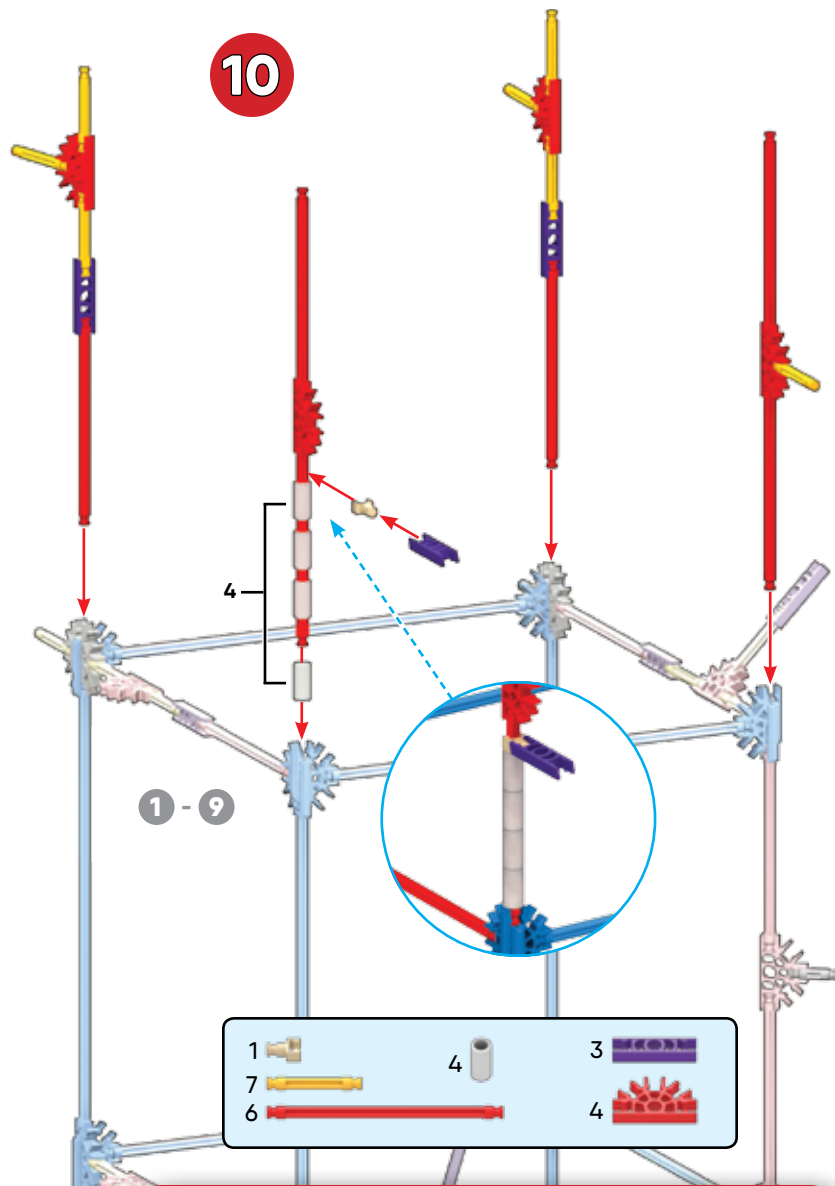

11

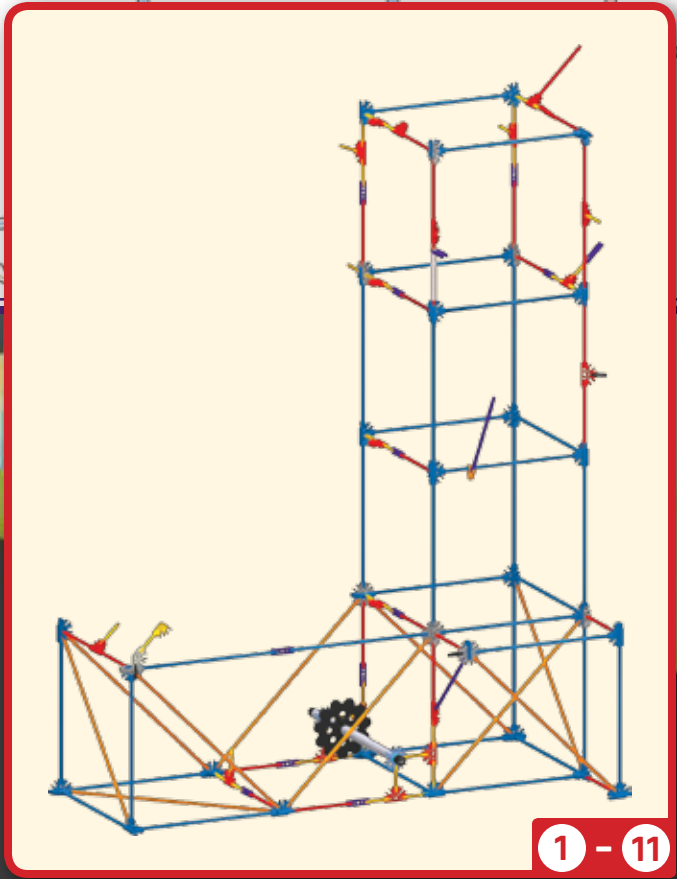
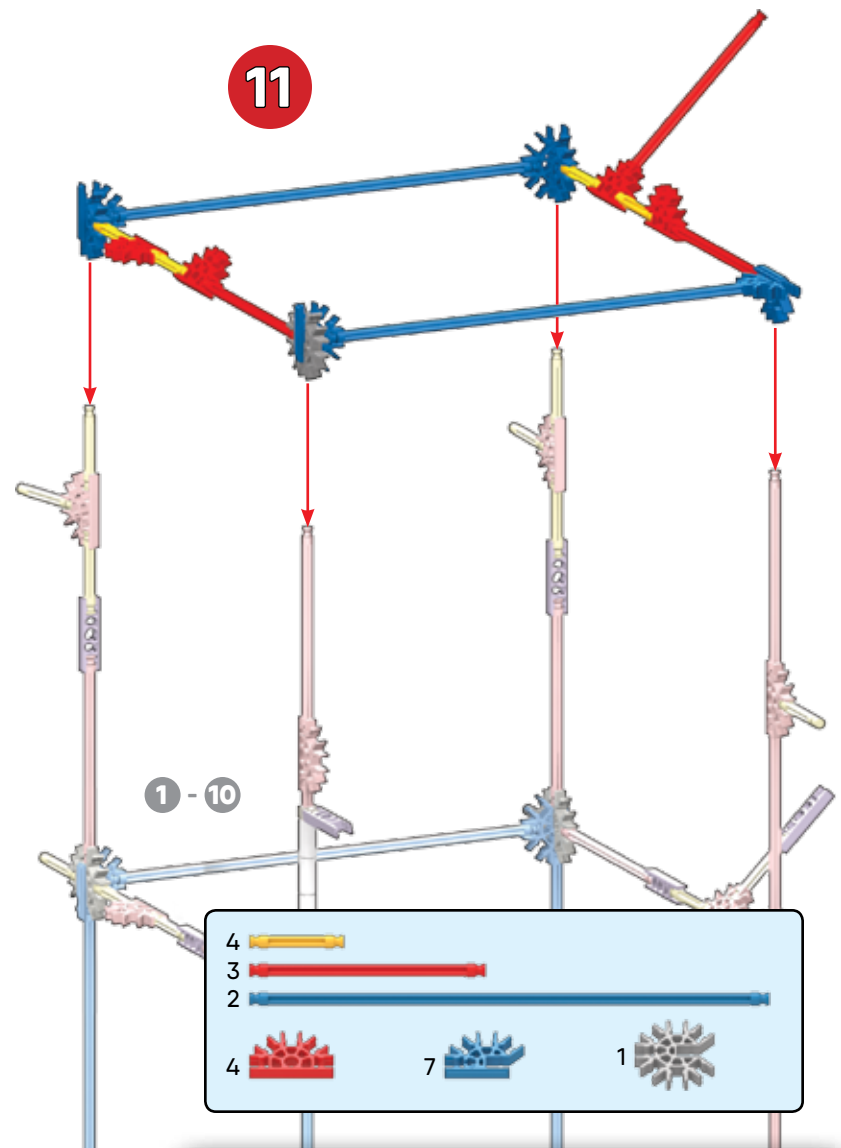

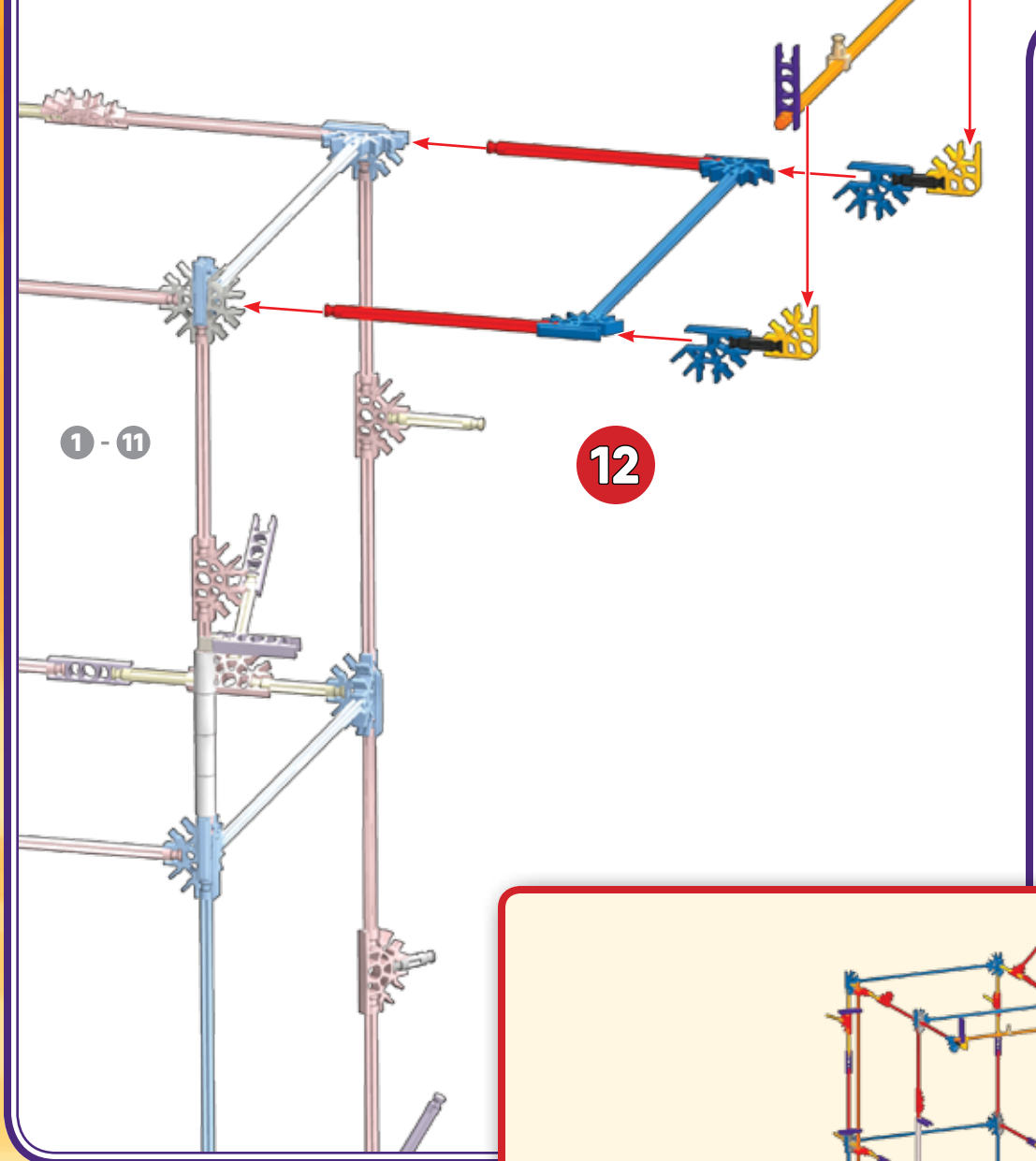
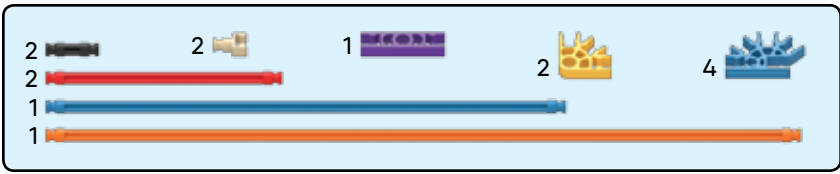

13

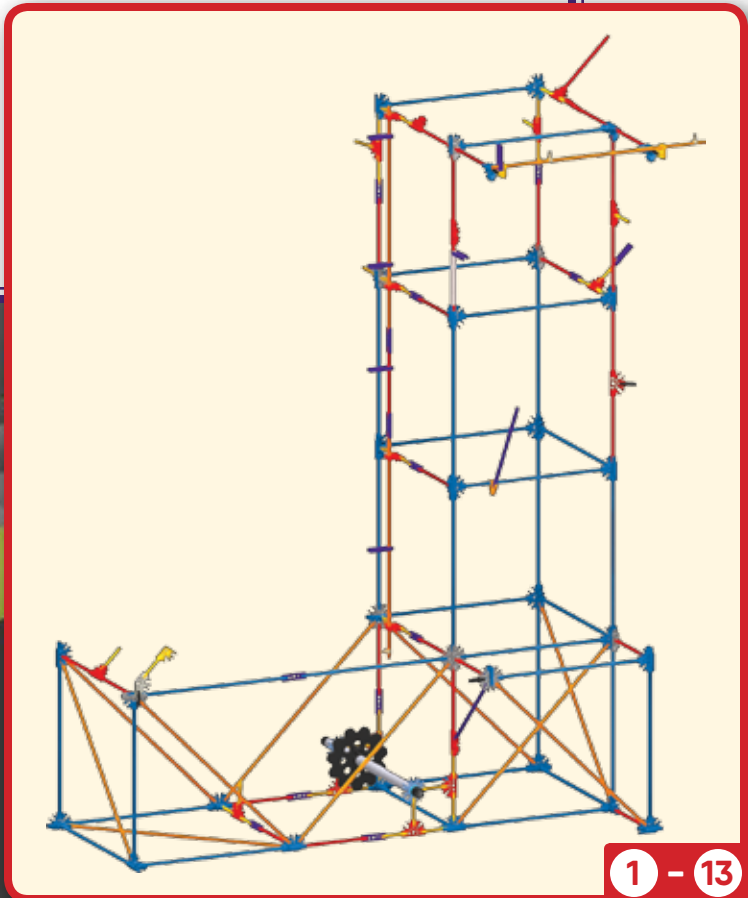
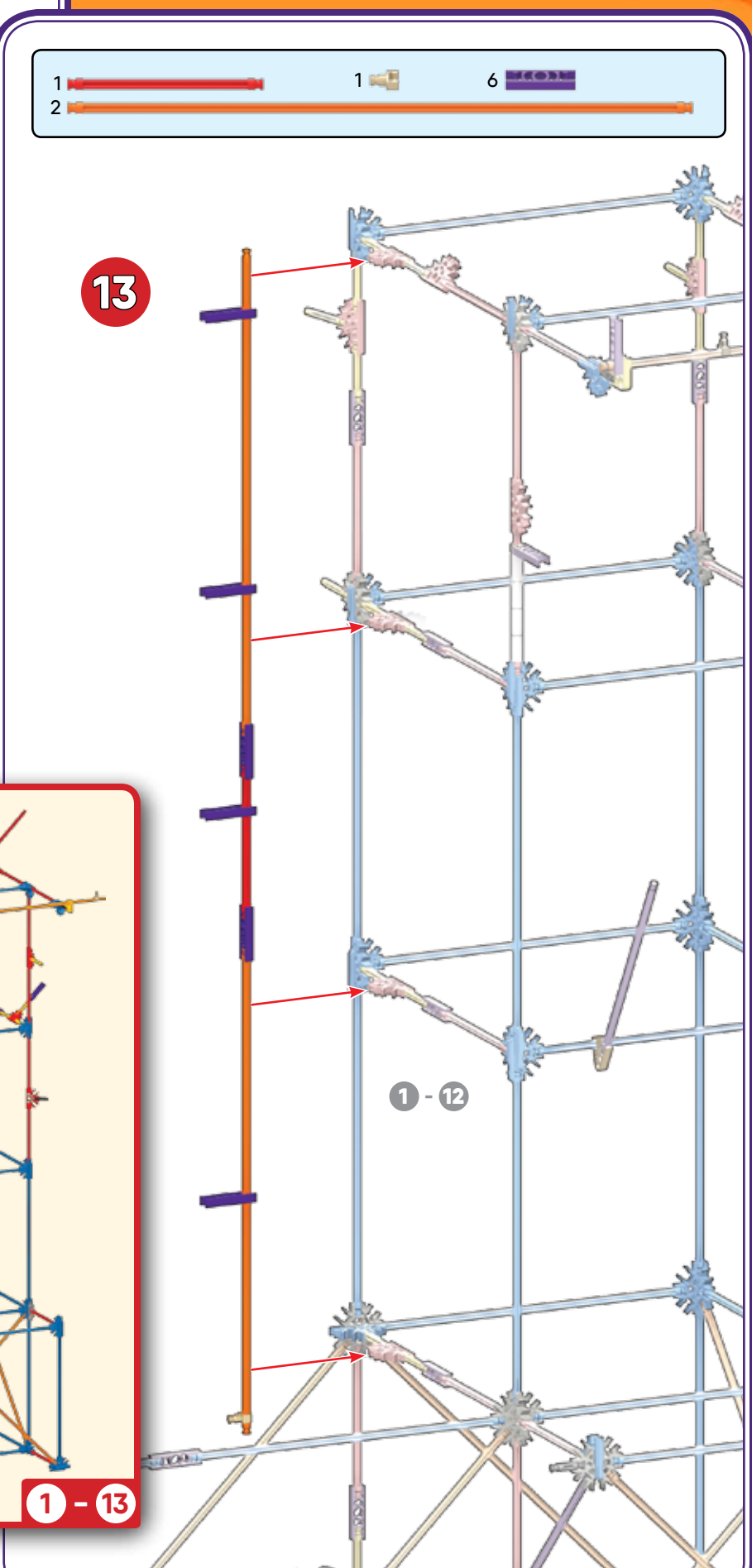

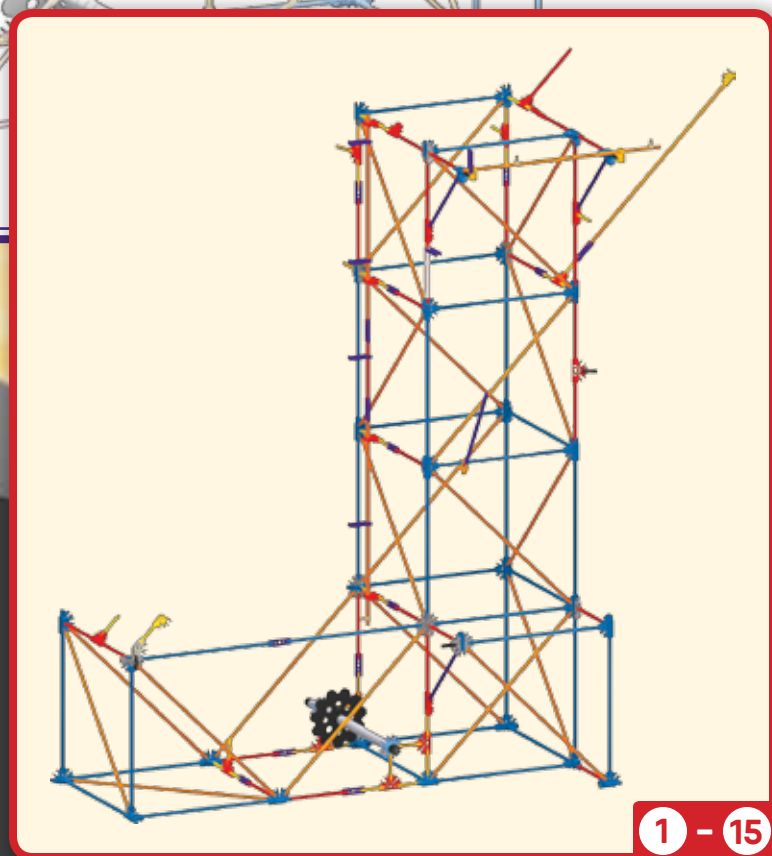
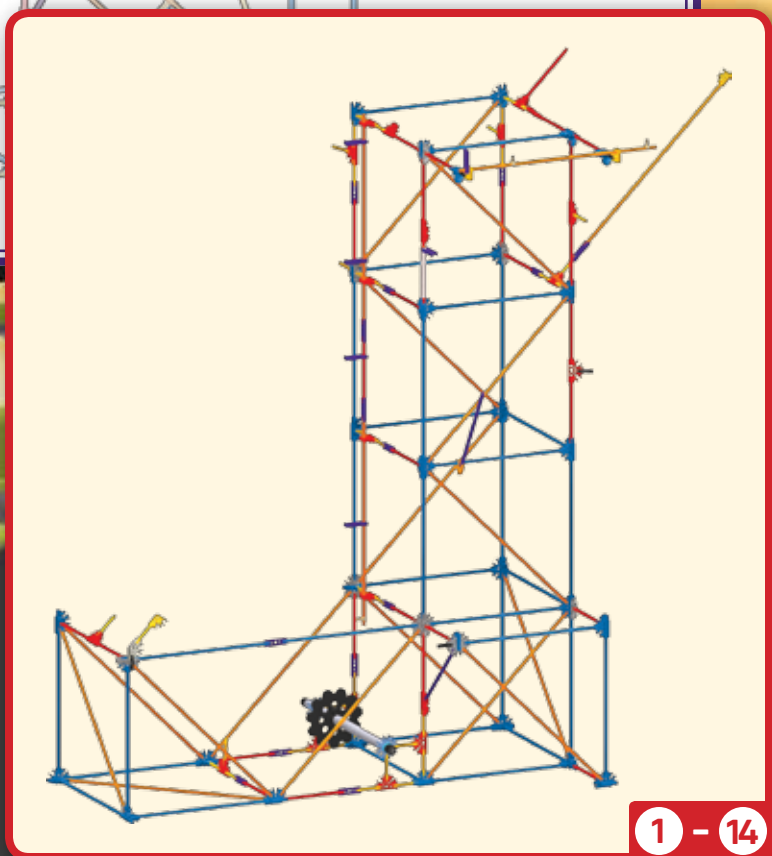
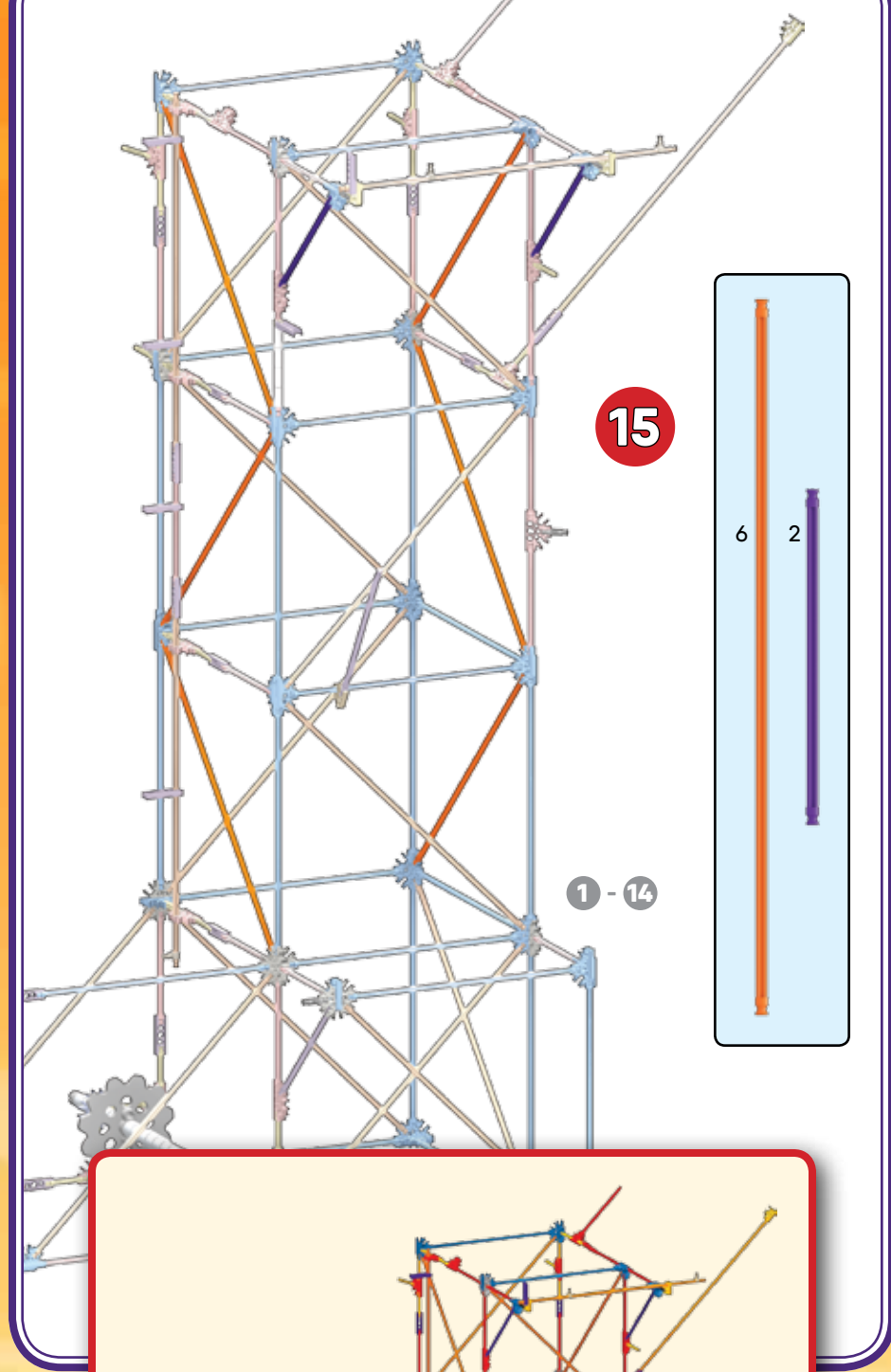
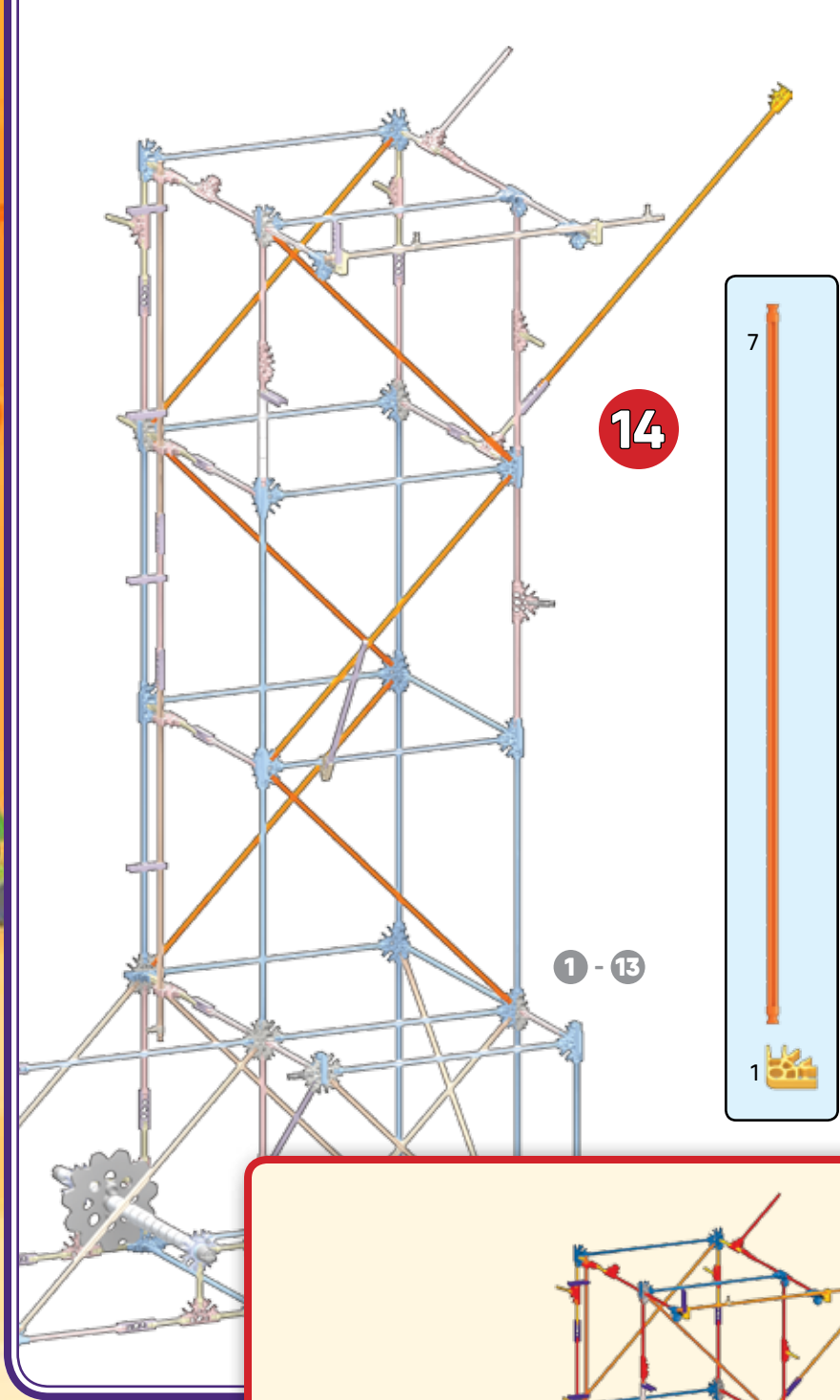

16

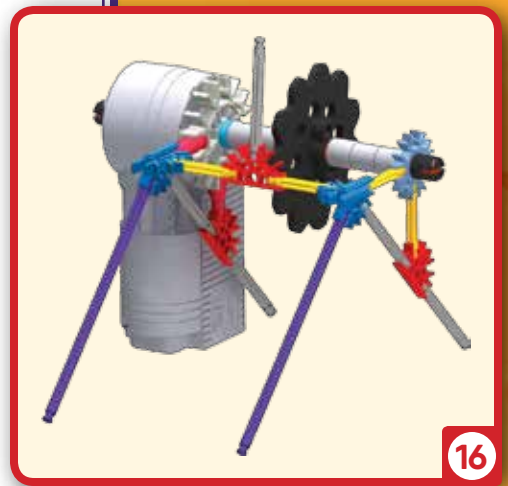
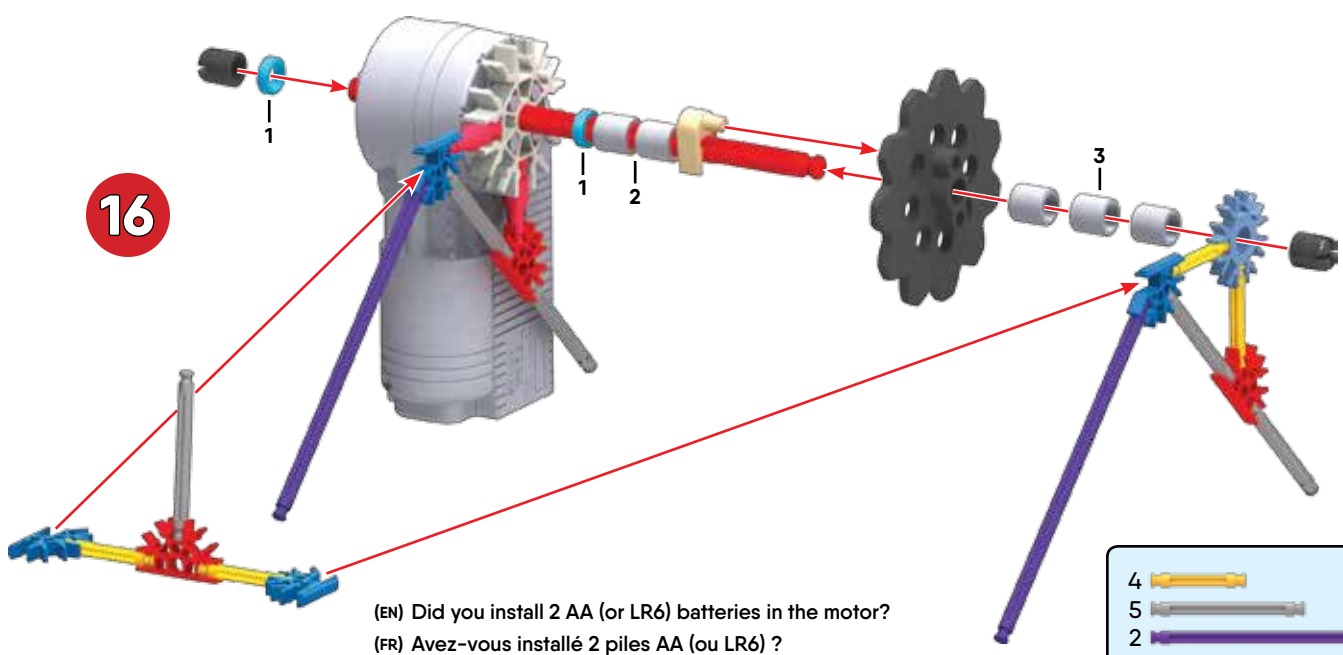

16

(EN) Did you install 2 AA (or LR6) batteries in the motor?  
 (FR) Avez-vous installé 2 piles AA (ou LR6) ?  
 (ES) ¿Instalaste 2 pilas AA (o LR6) en el motor?  
 (DE) Hast du 2 AA (oder LR6) Batterien in den Motor eingelegt?  
 (IT) Hai installato 2 batterie AA (o LR6) nel motore?  
 (PT) Foram instaladas as pilhas 2 AA (ou LR6) no motor?  
 (NL) Heb je 2 AA (of LR6)-batterijen in de motor geplaatst?

4		3		4		1	
5							
2		1					
1		2		2		5	
						1	

1

1

16

17

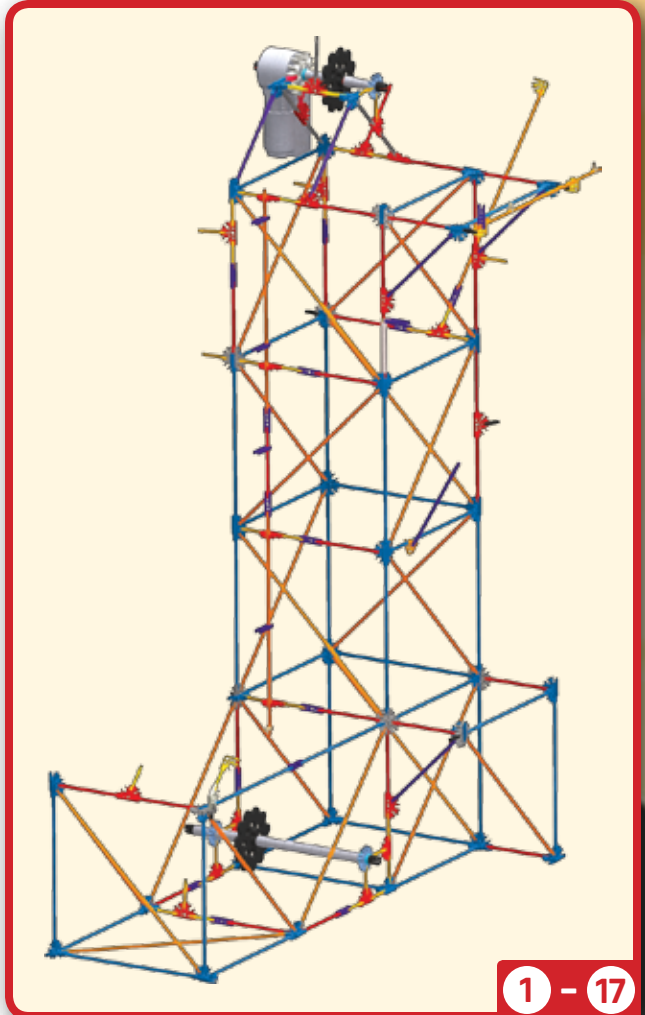
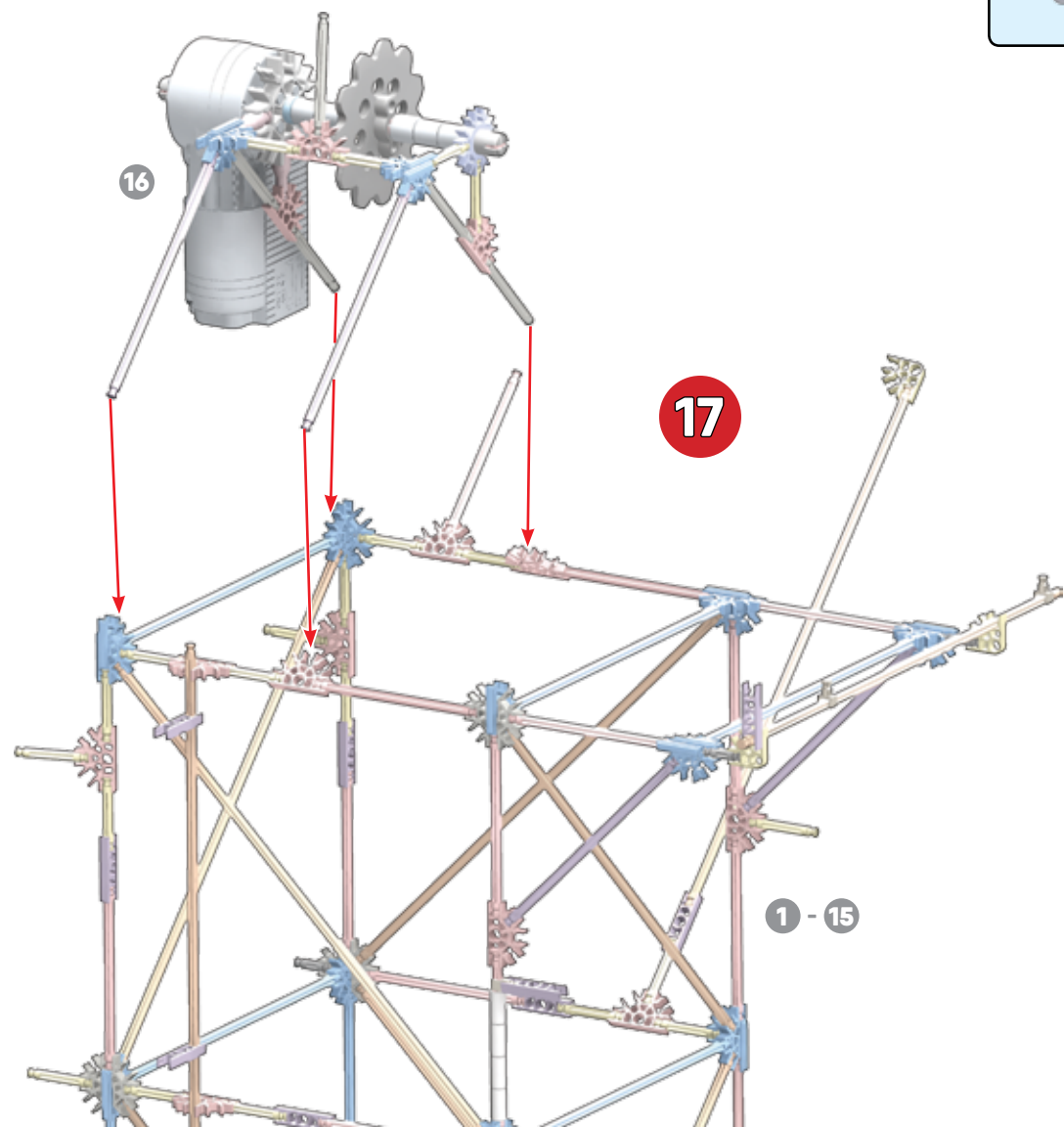

1 - 17



18



Be sure to push the connectors on firmly until they "click".

Pousse bien les connecteurs jusqu'à ce qu'ils « cliquent ».

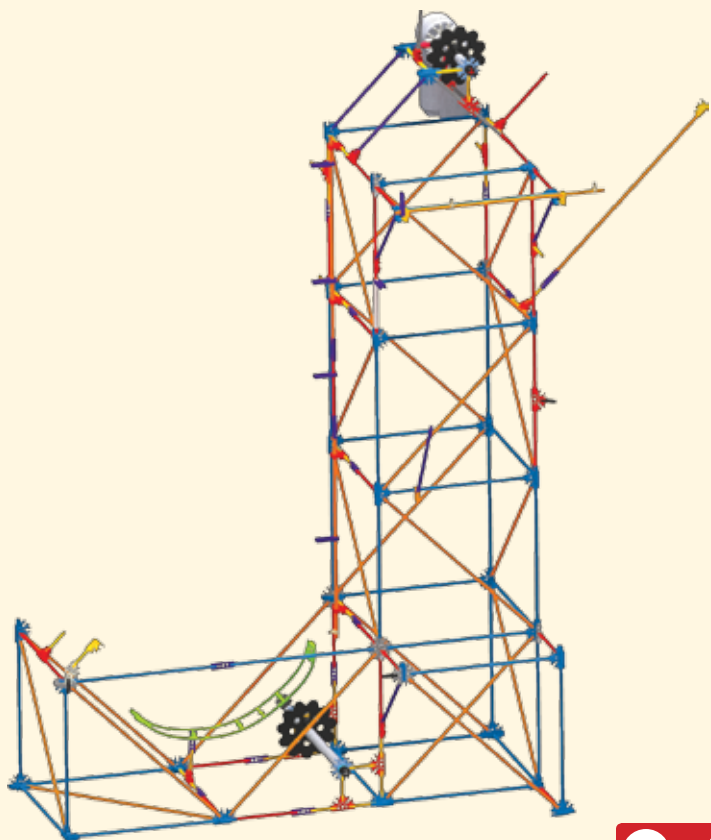

1 - 19

19

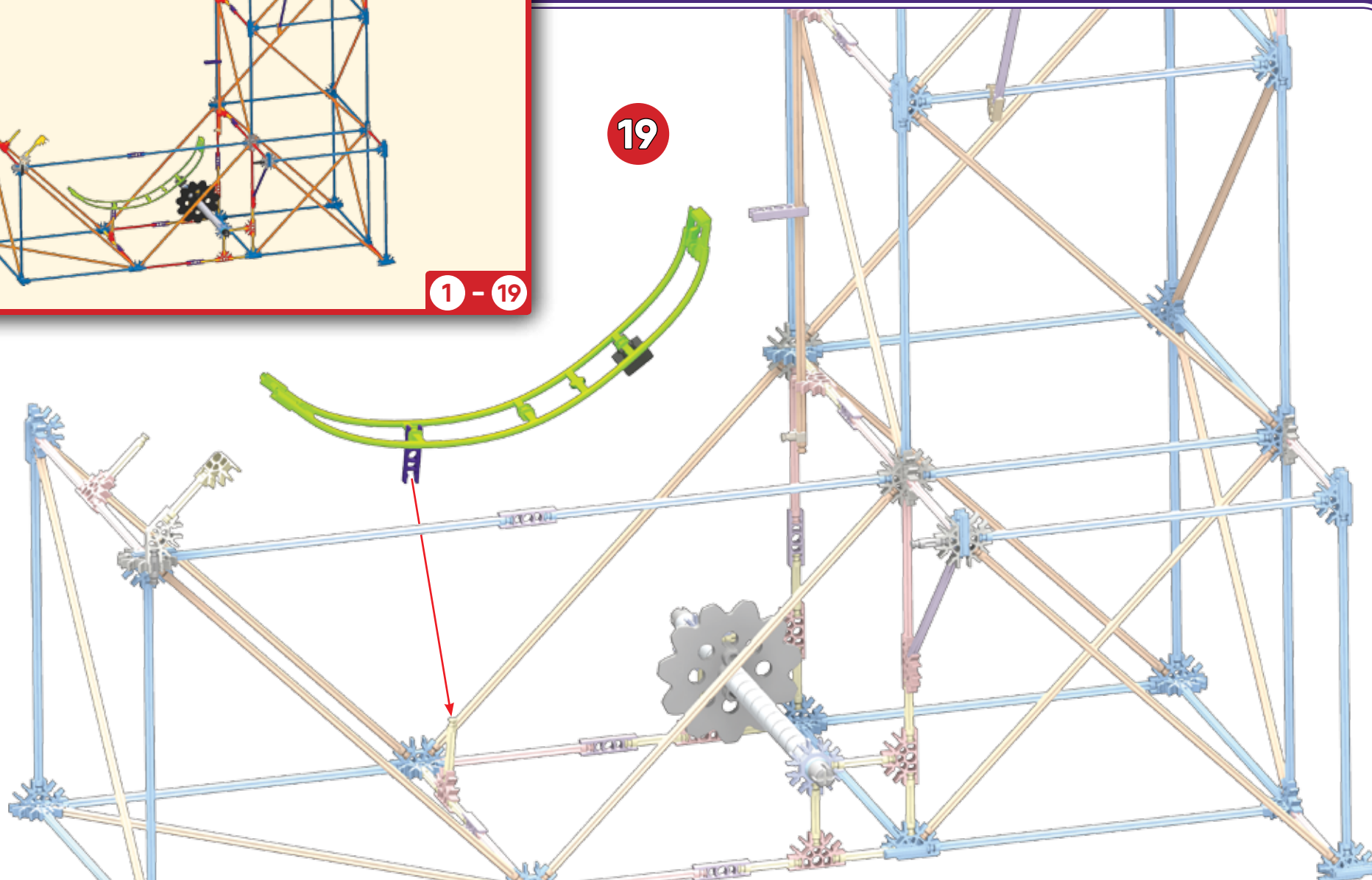

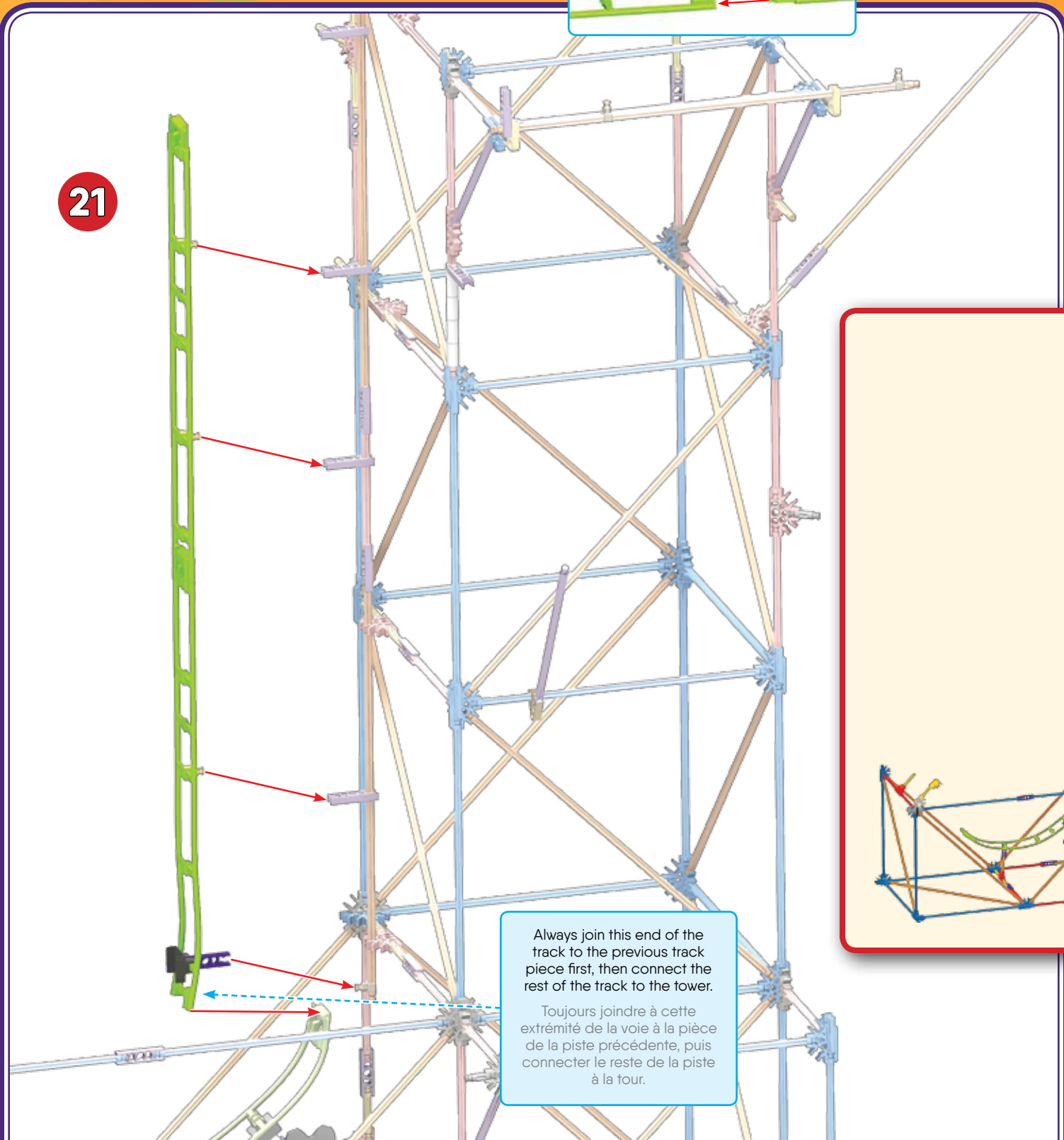
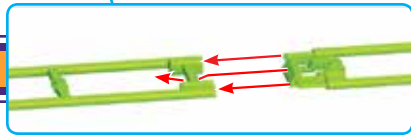
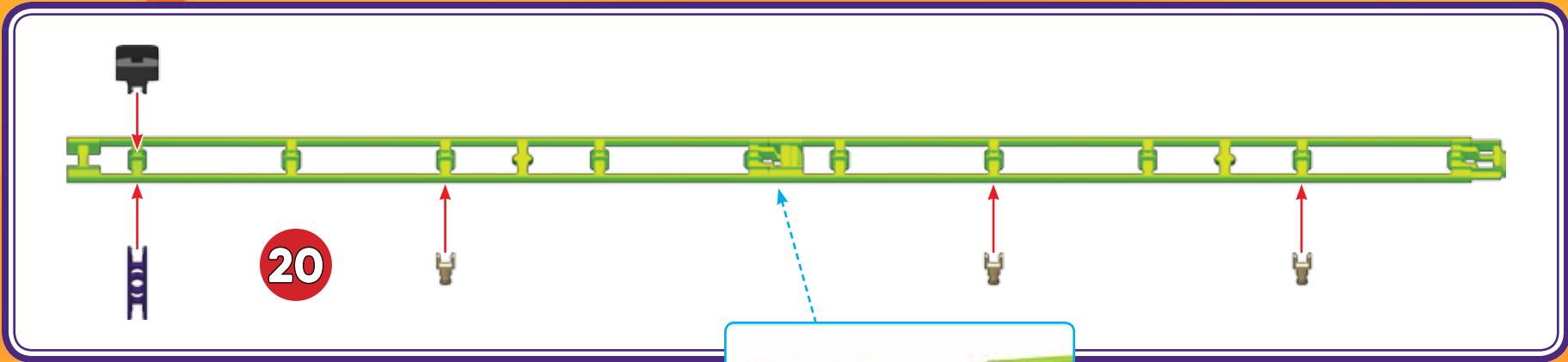

Always join this end of the track to the previous track piece first, then connect the rest of the track to the tower.

Toujours joindre à cette extrémité de la voie à la pièce de la piste précédente, puis connecter le reste de la piste à la tour.

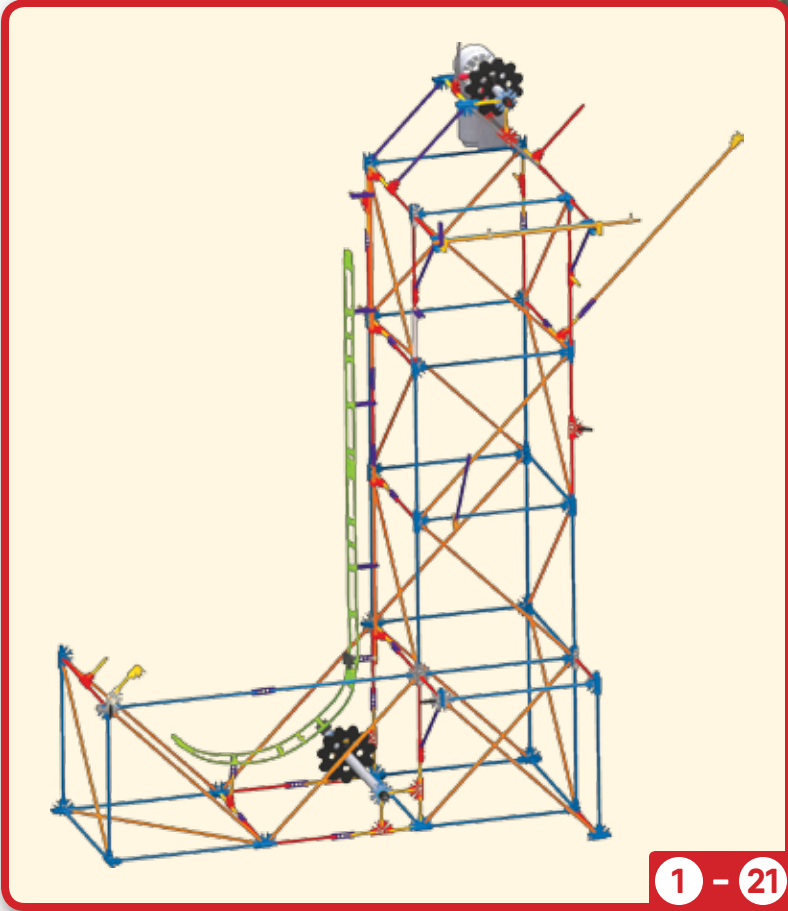

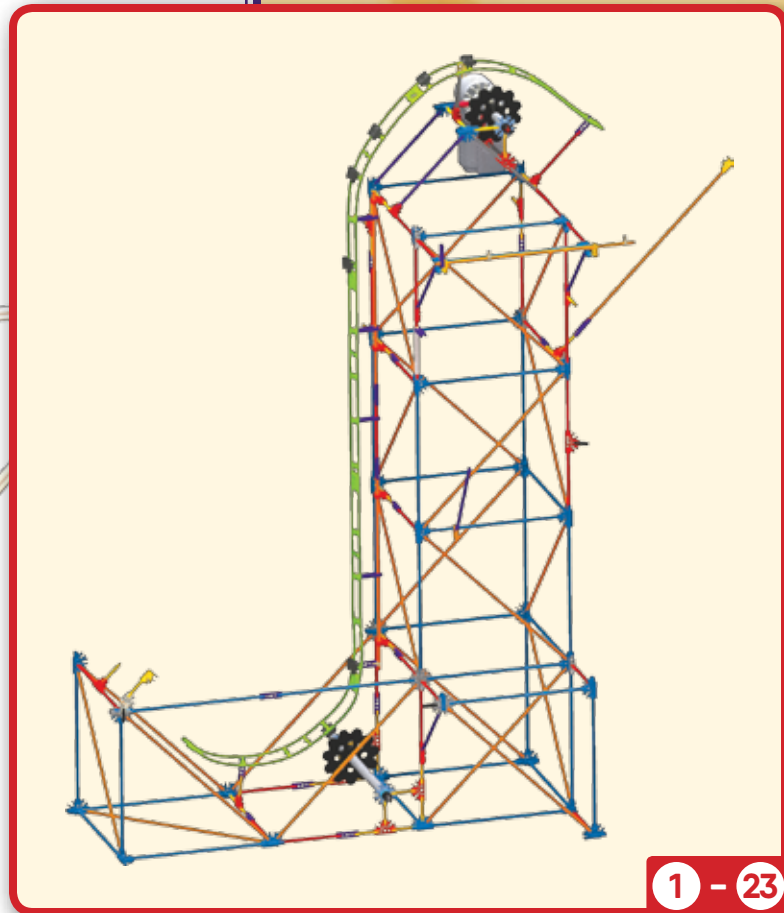
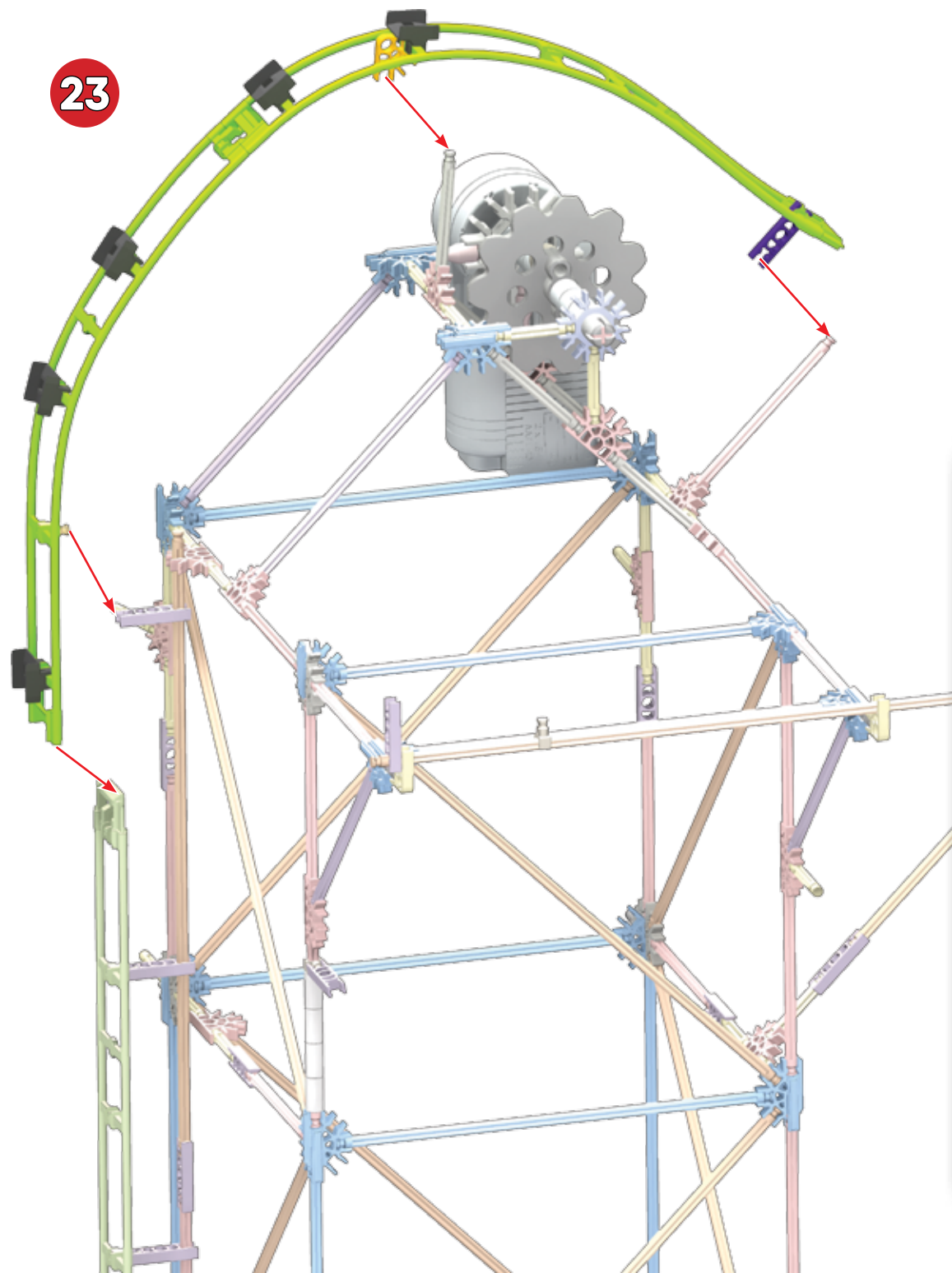
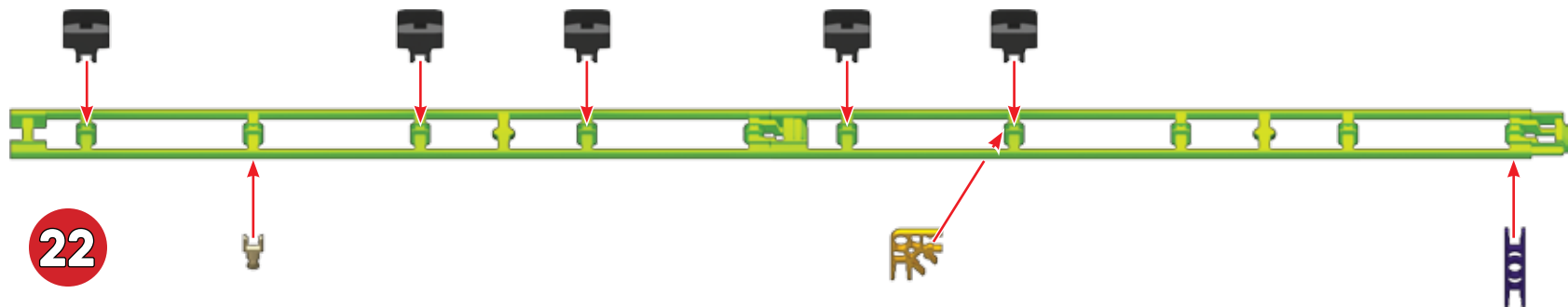

24

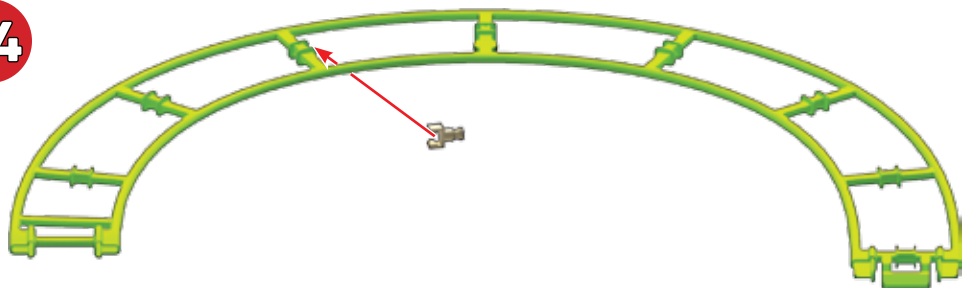

25

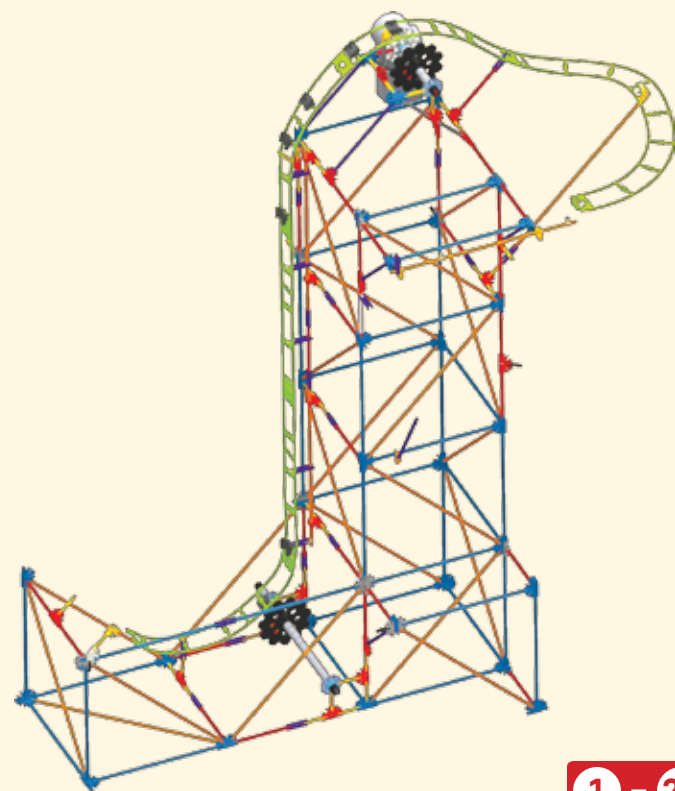
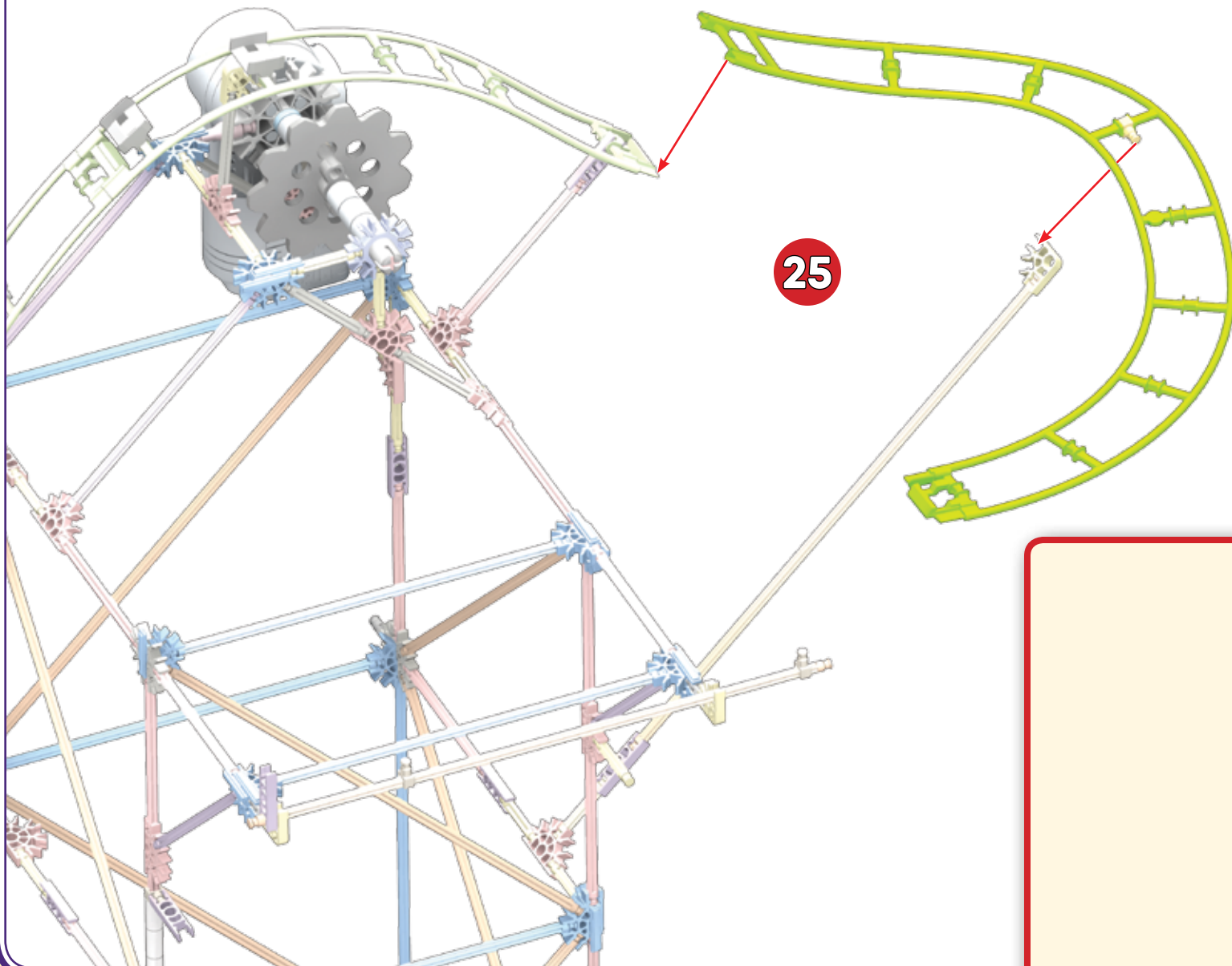

1 - 25

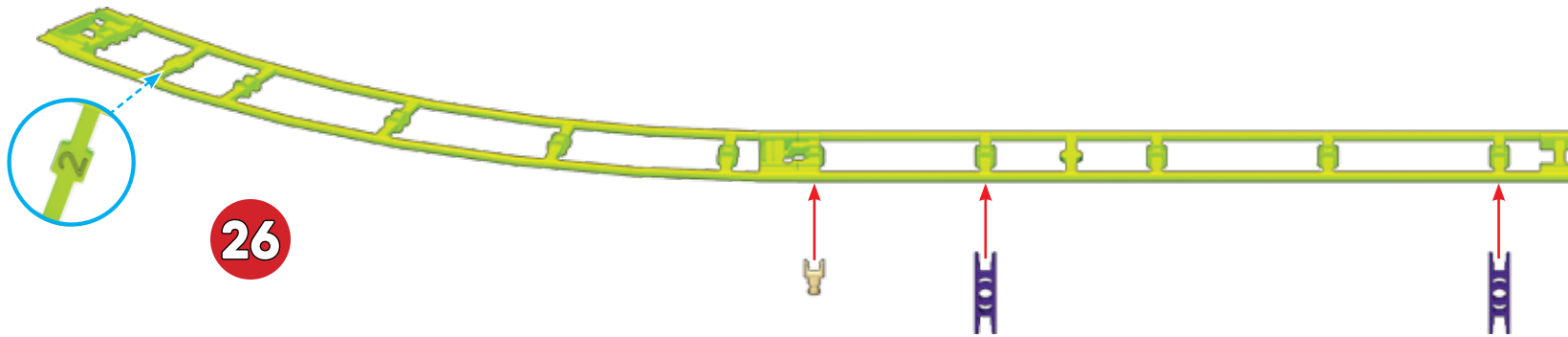

26

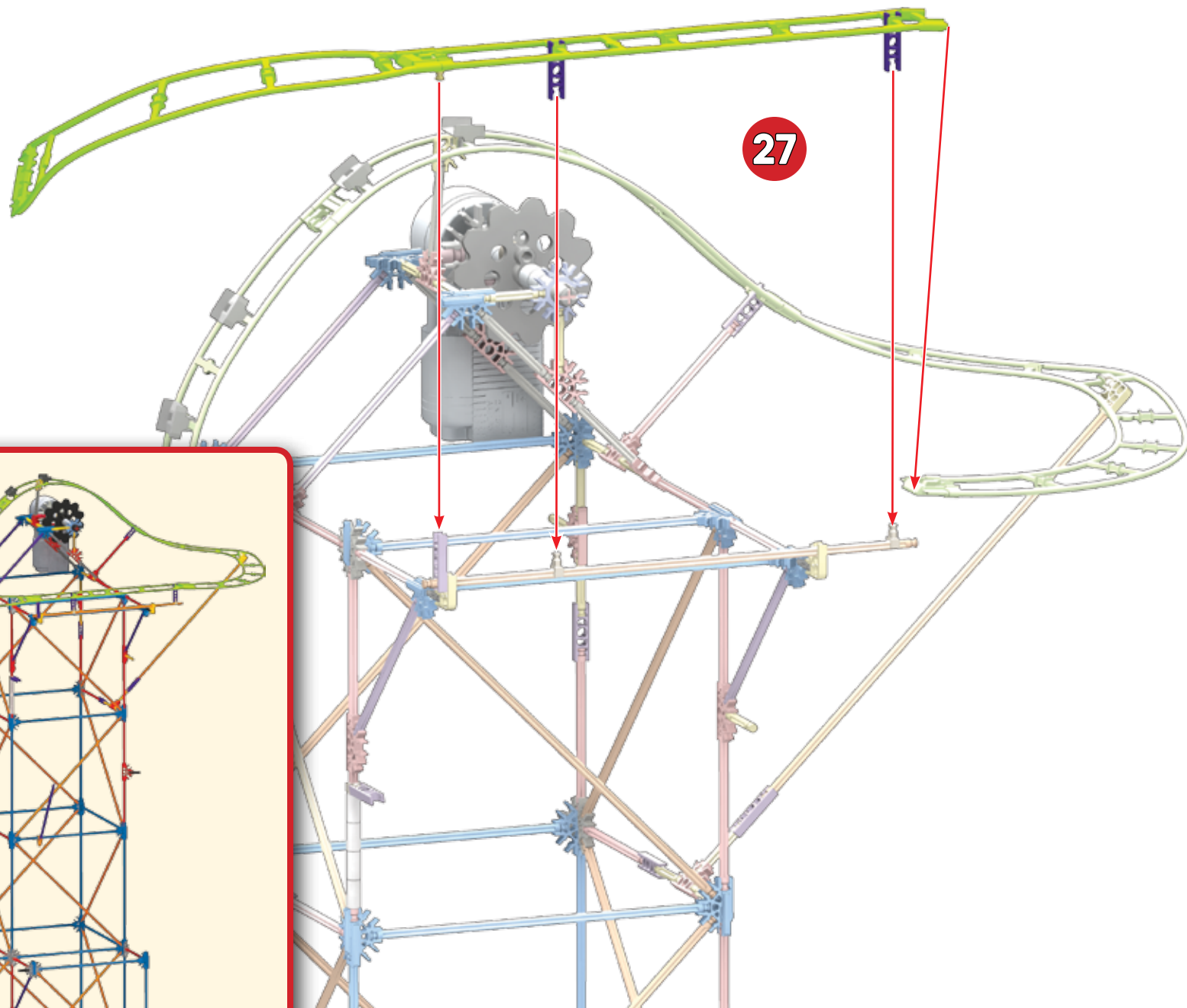

27

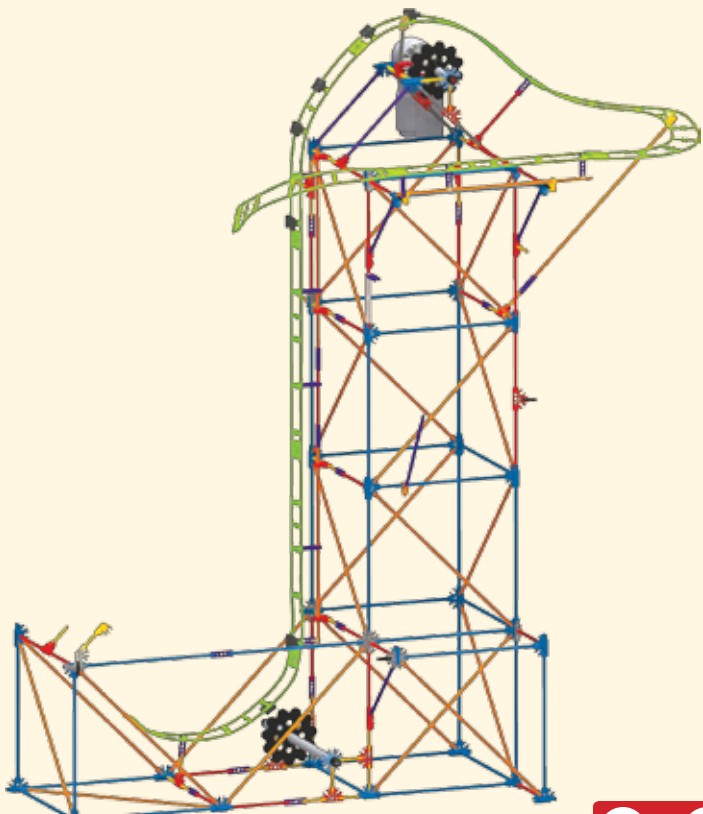

1 - 27

28

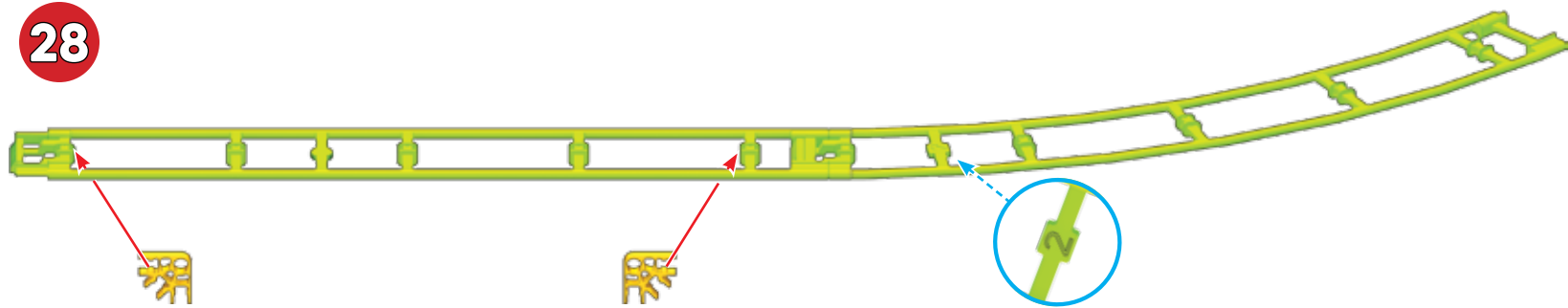

29

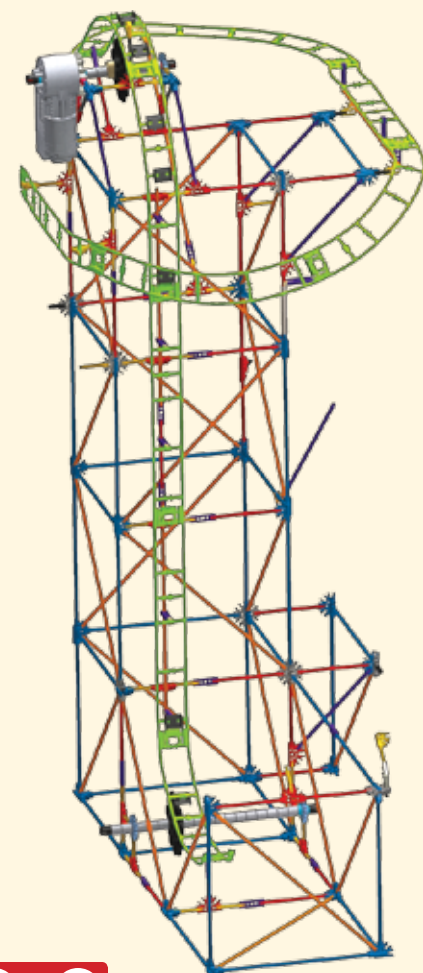
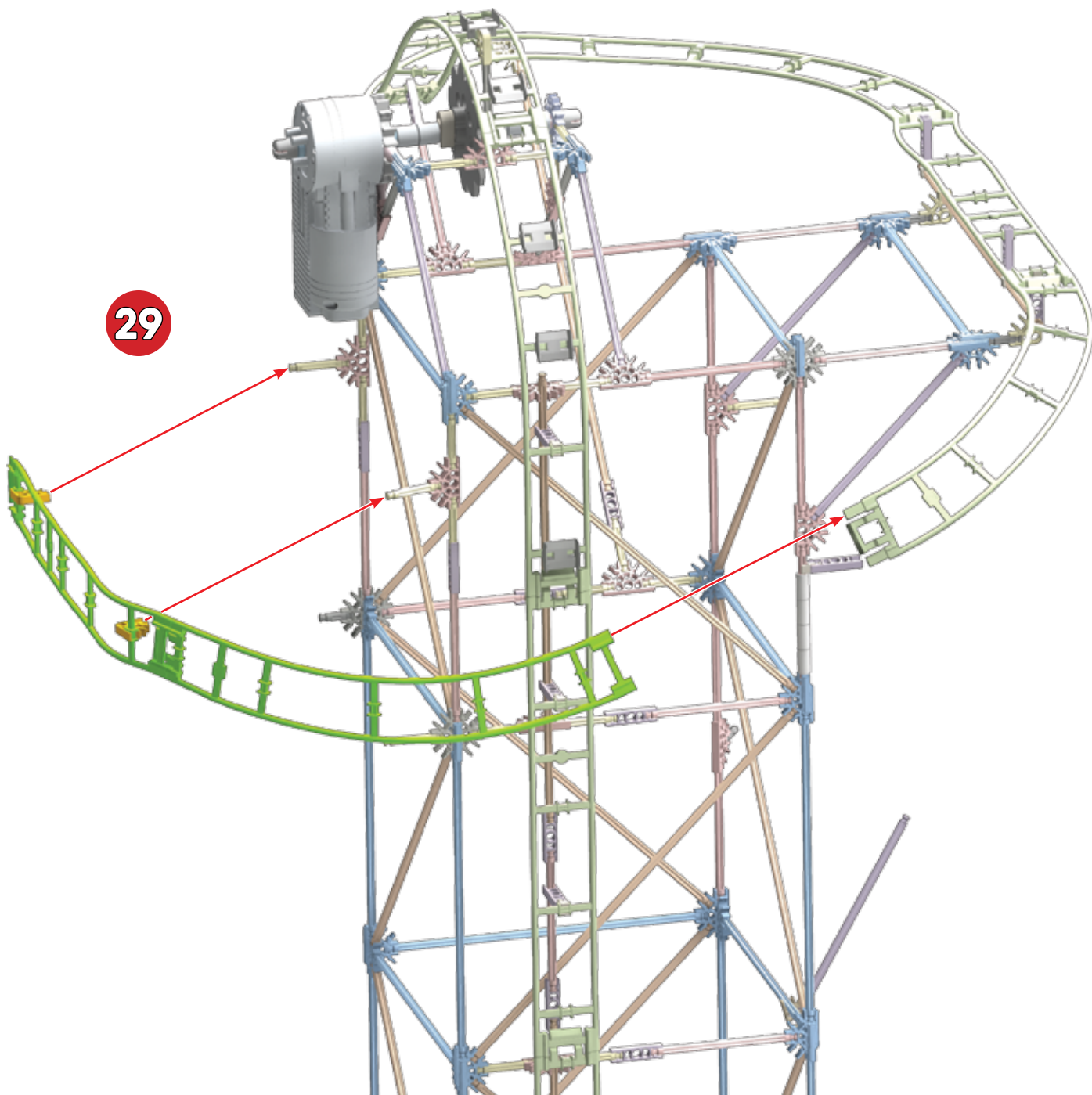

1 - 29



30

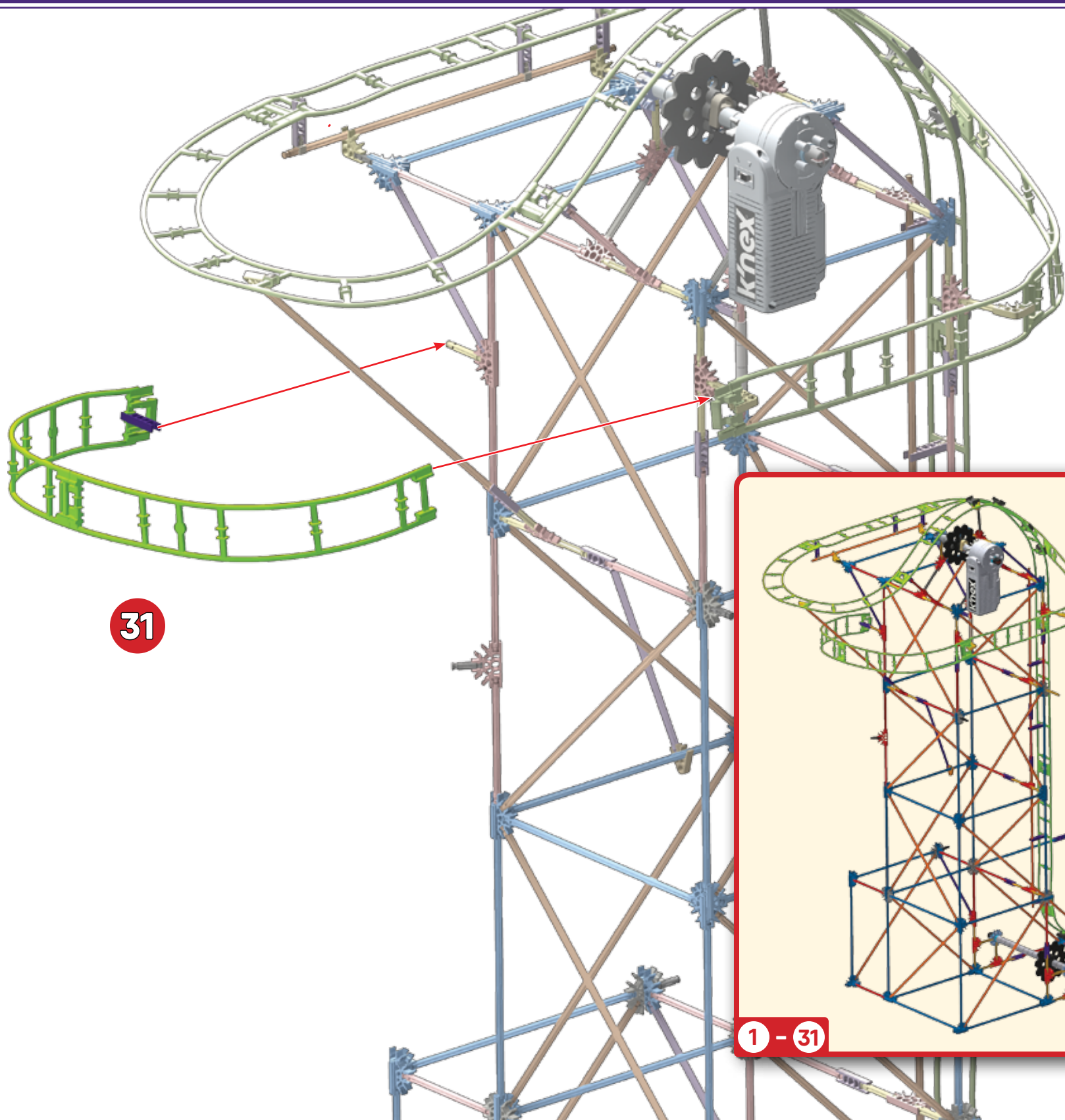

31

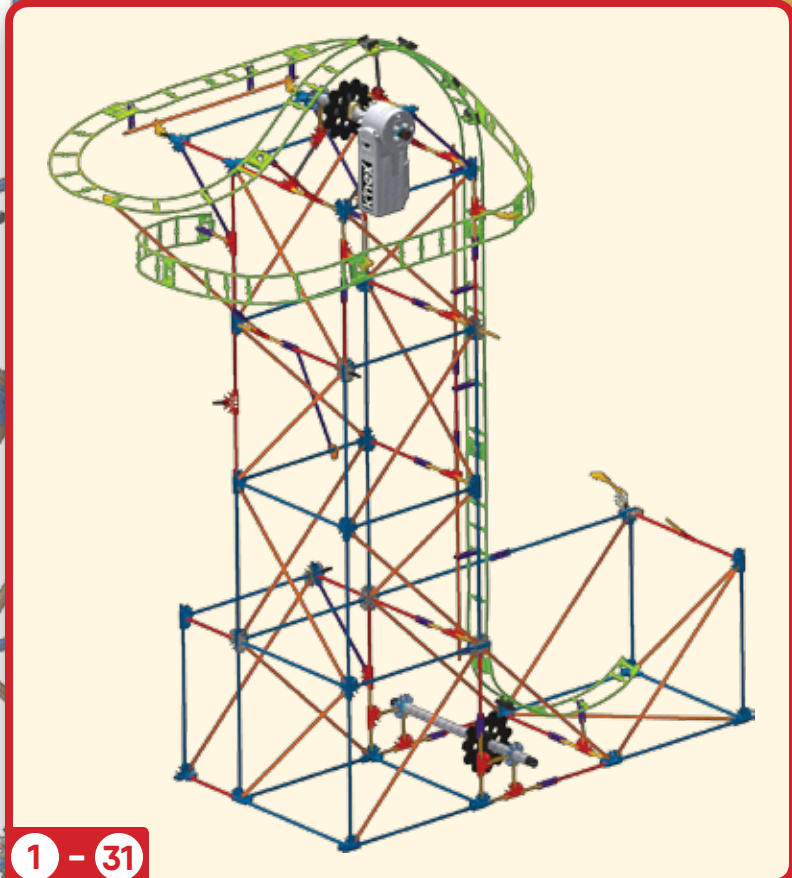

1 - 31

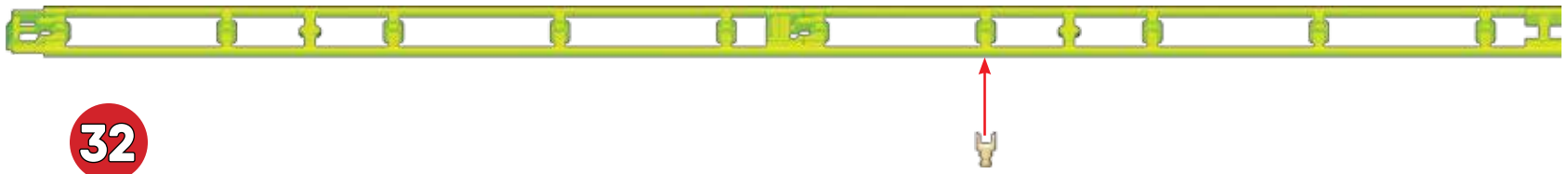

32

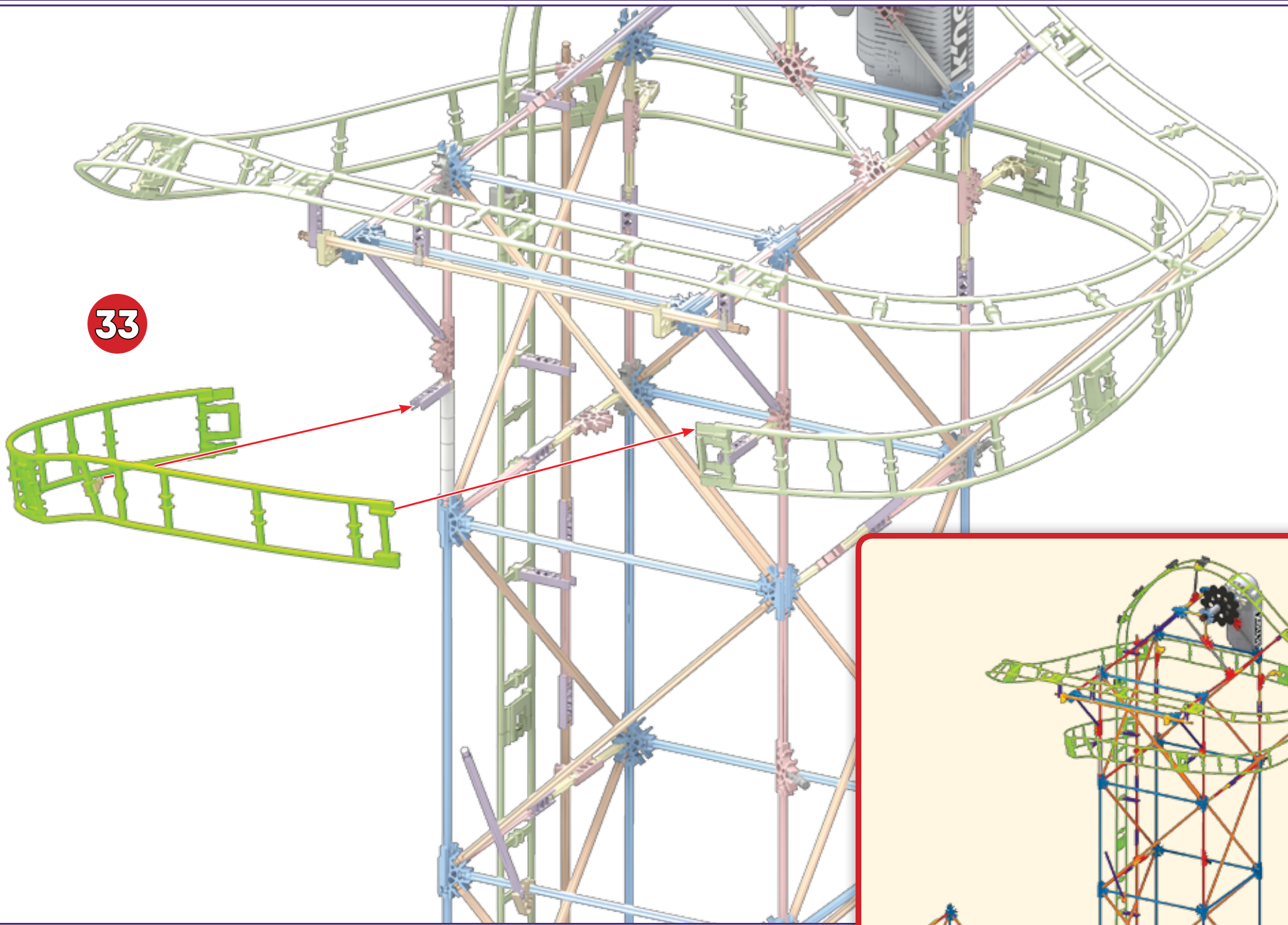

33

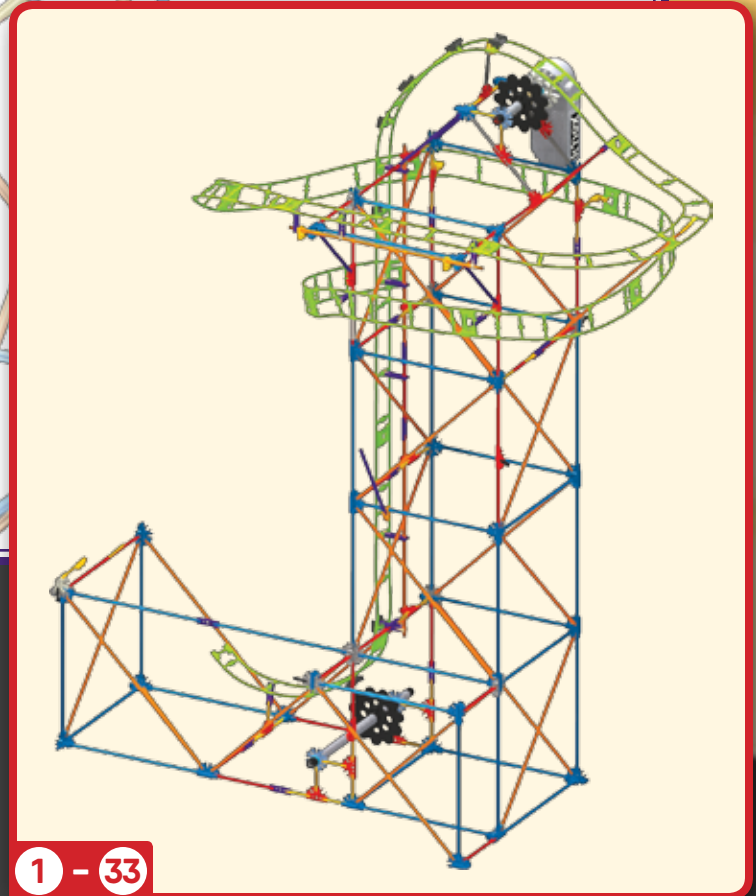

1 - 33



34

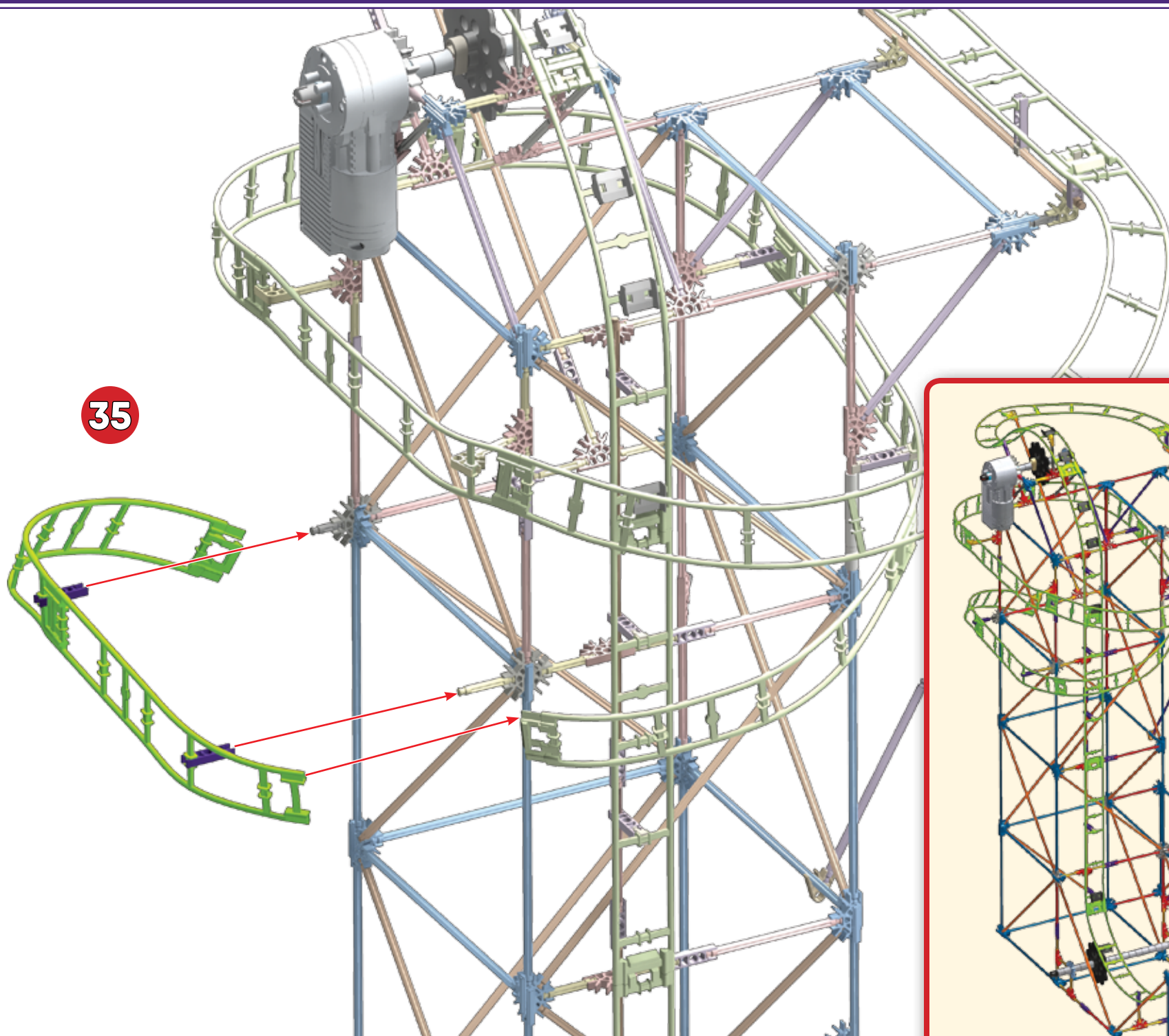

35

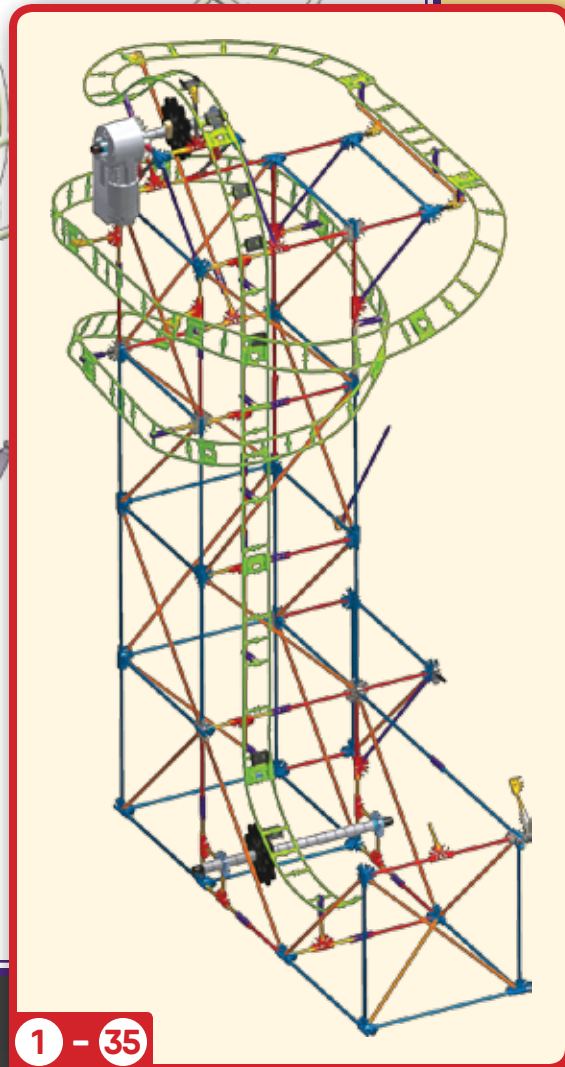

1 - 35

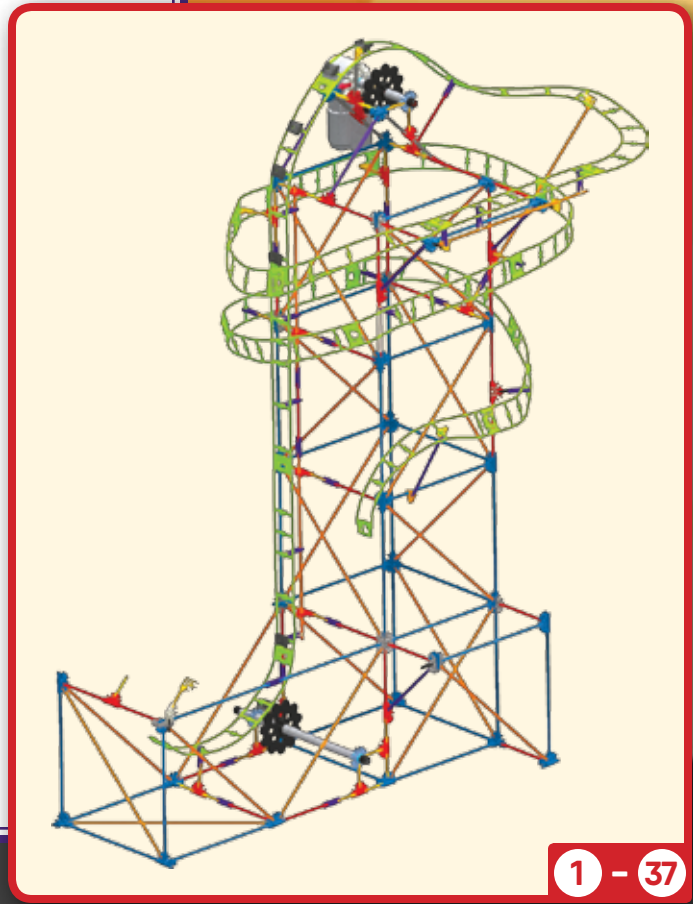
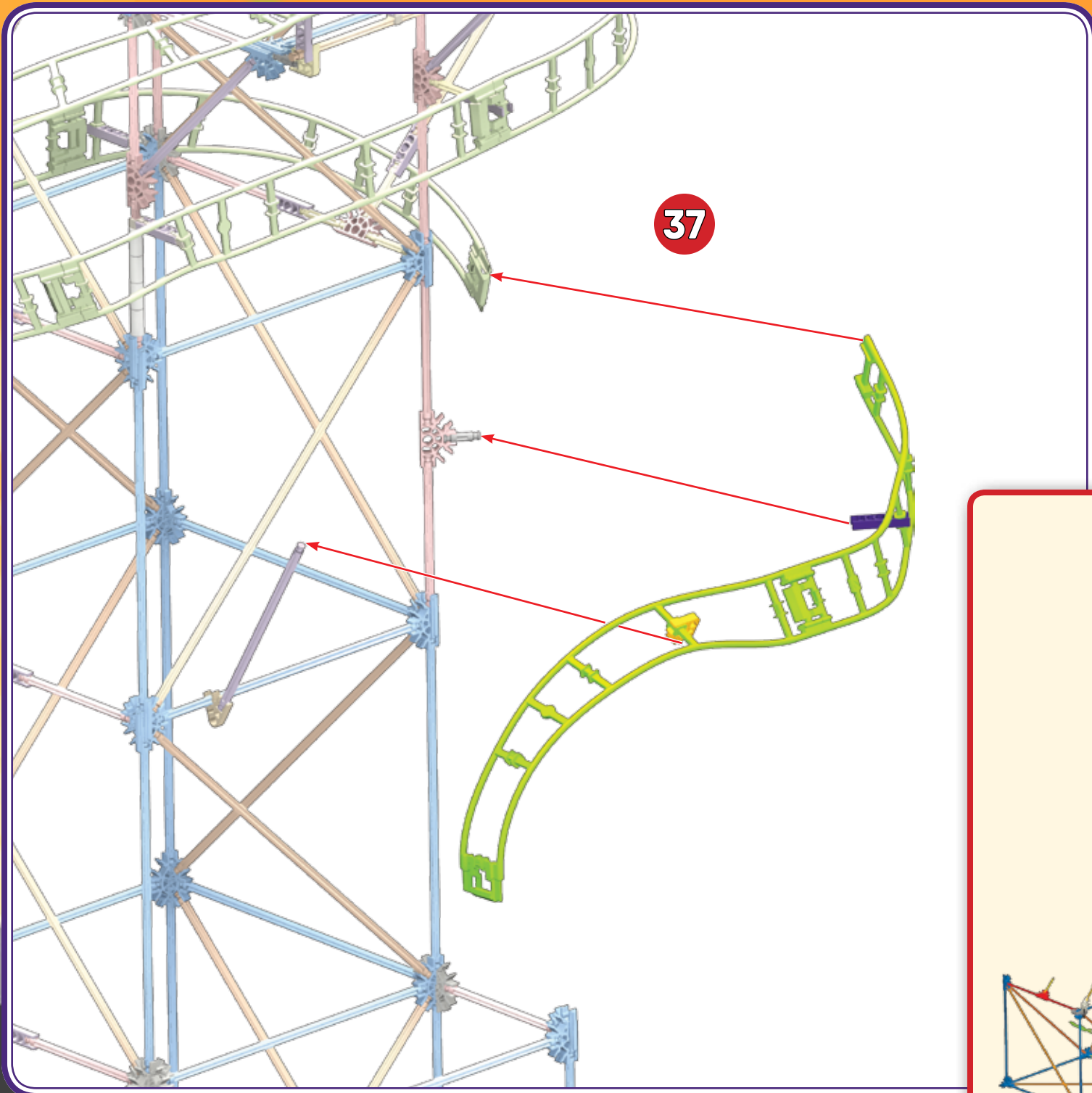
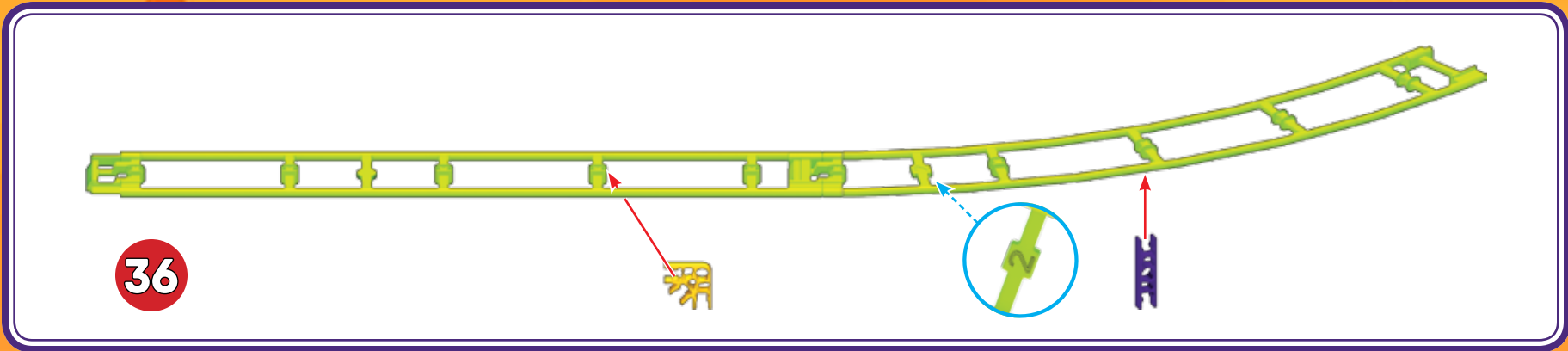



38

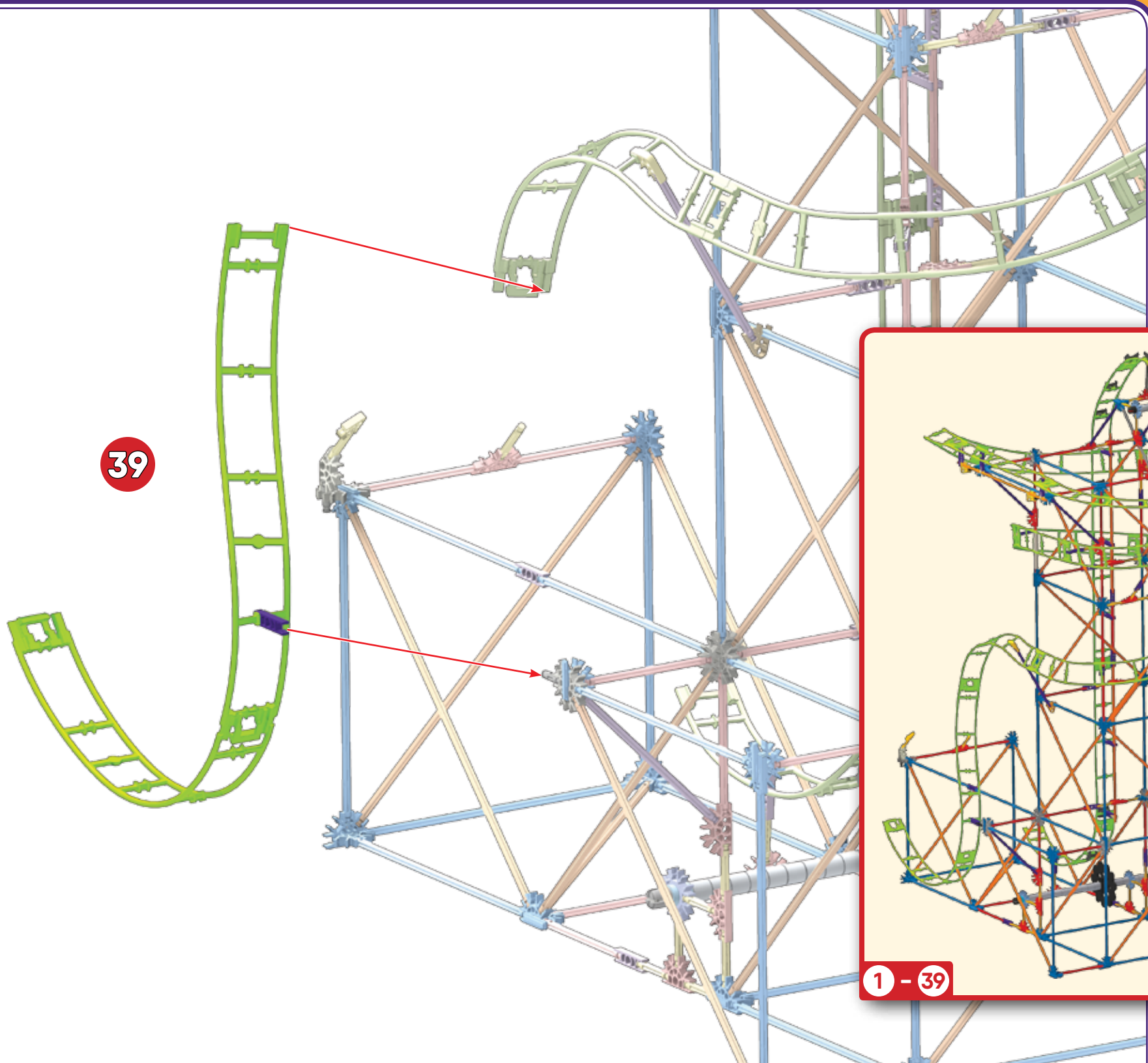

39

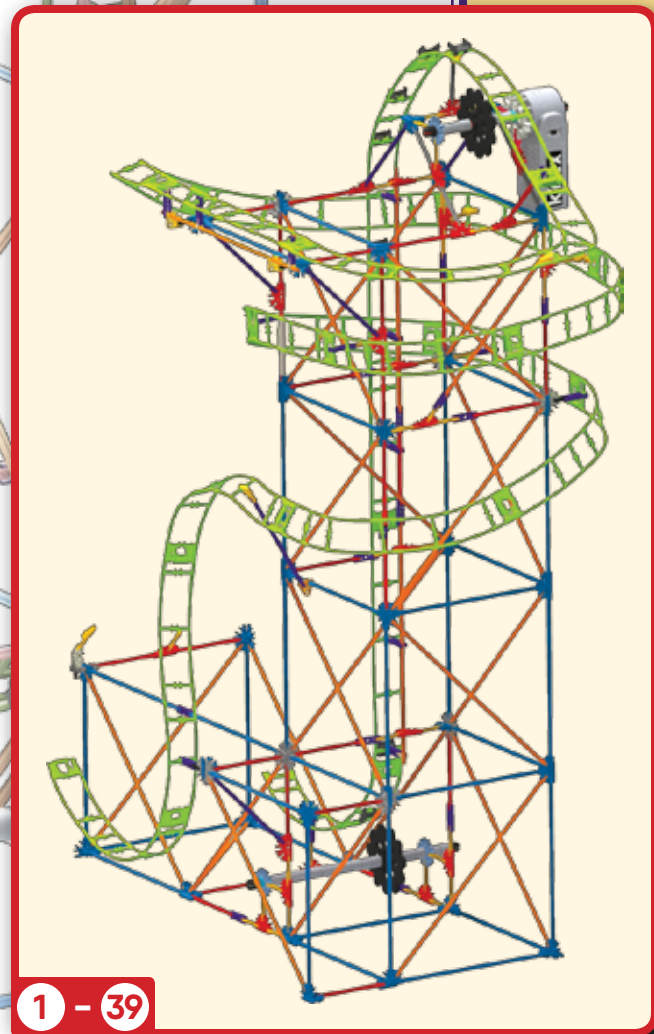

1 - 39

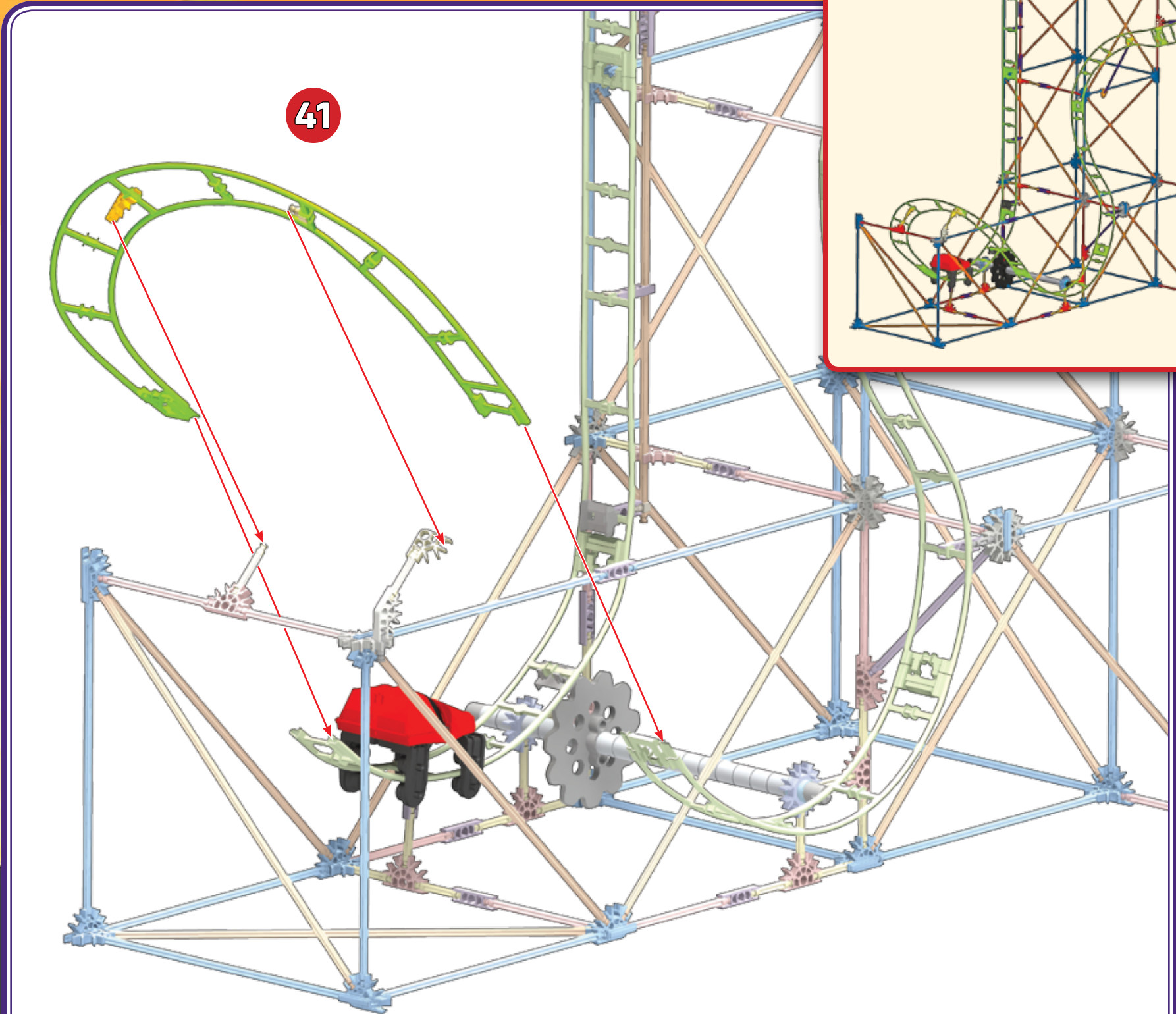
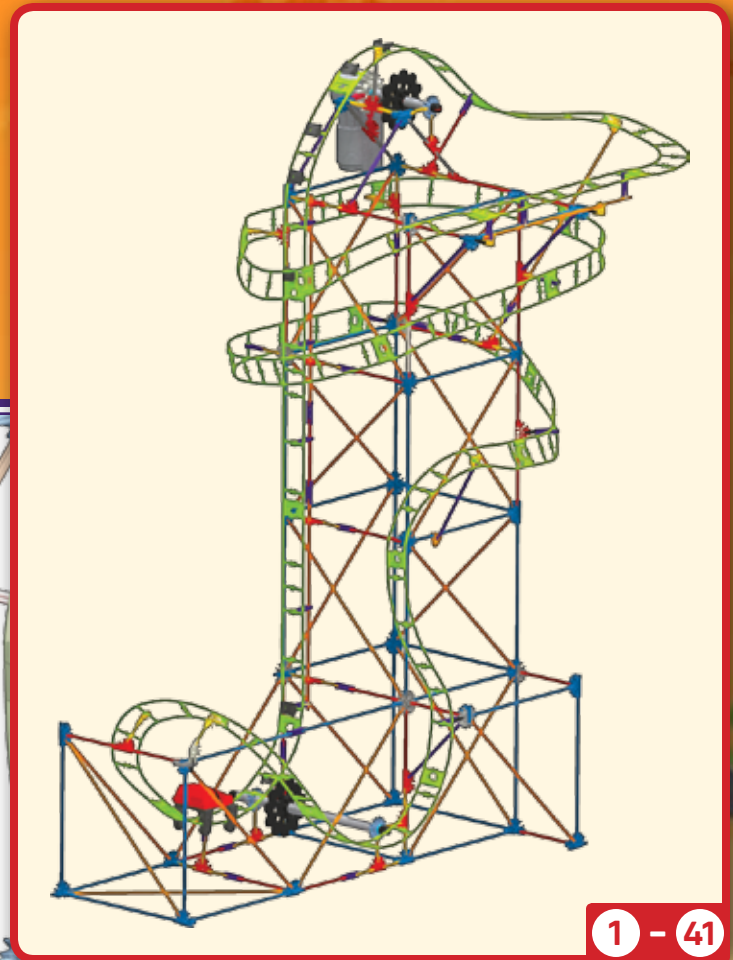
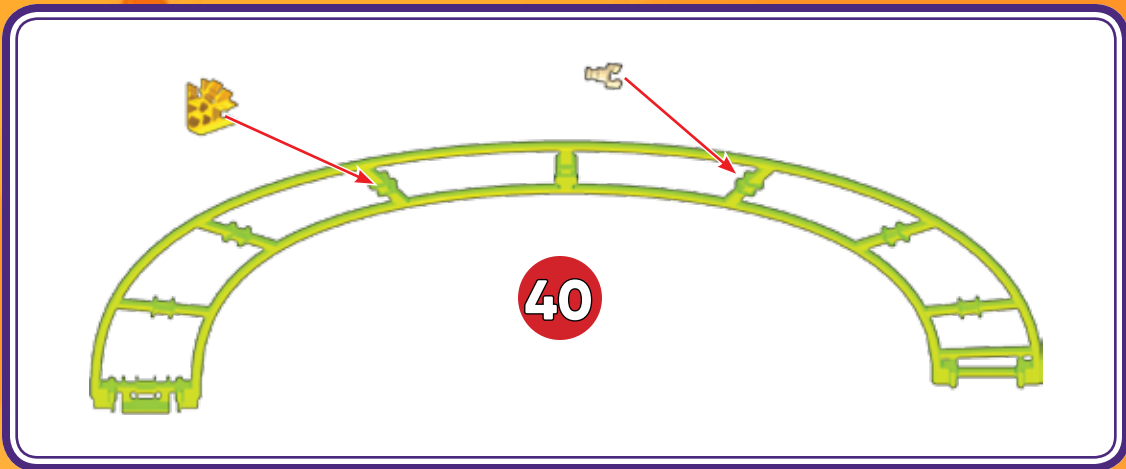

**IMPORTANT:** Attach all the chain links in the same direction.

**IMPORTANT :** Assure-toi de fixer tous les maillons de la chaîne dans le même sens.



42



x11

x1

43



x10

x10

44

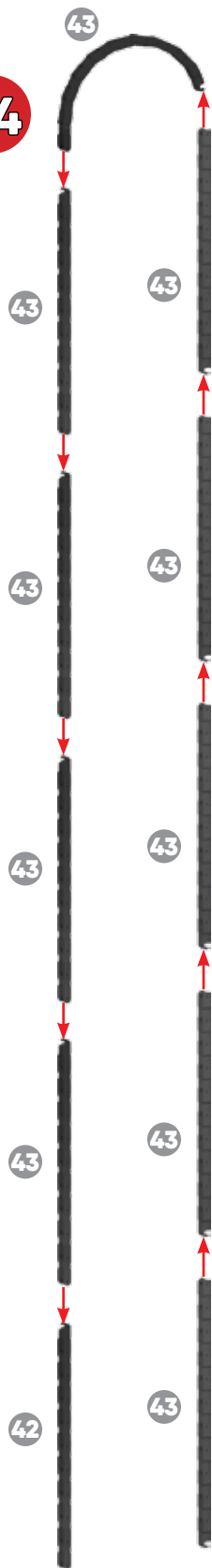

45

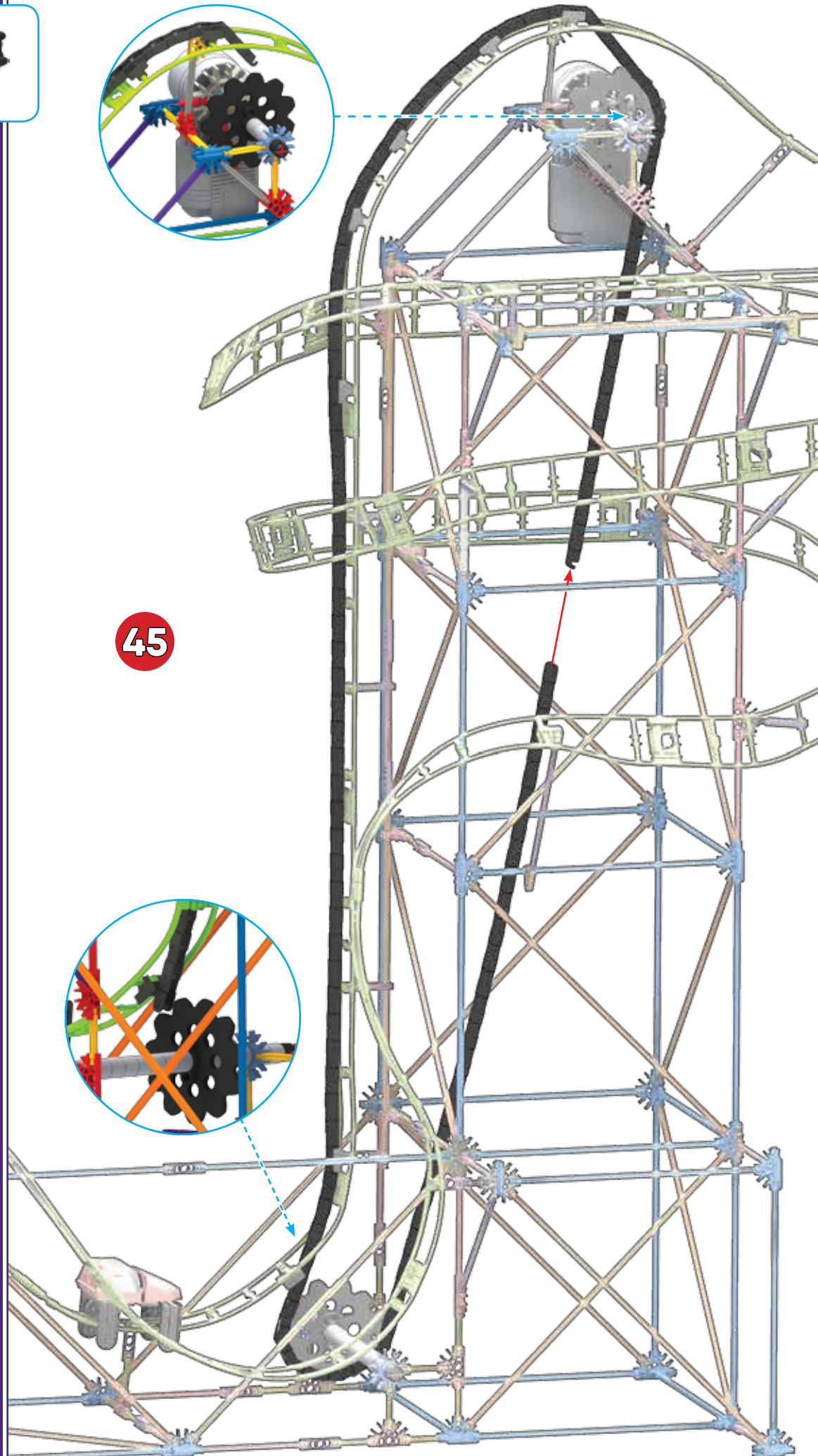
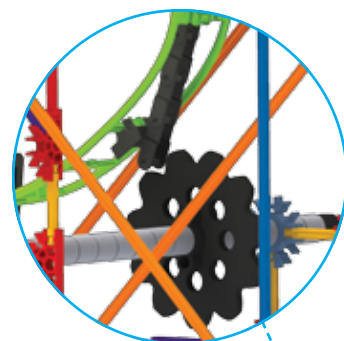

**k'nex**

**T-REX FURY**  
**FUREUR**  
**DU T-REX**



1 - 46

46

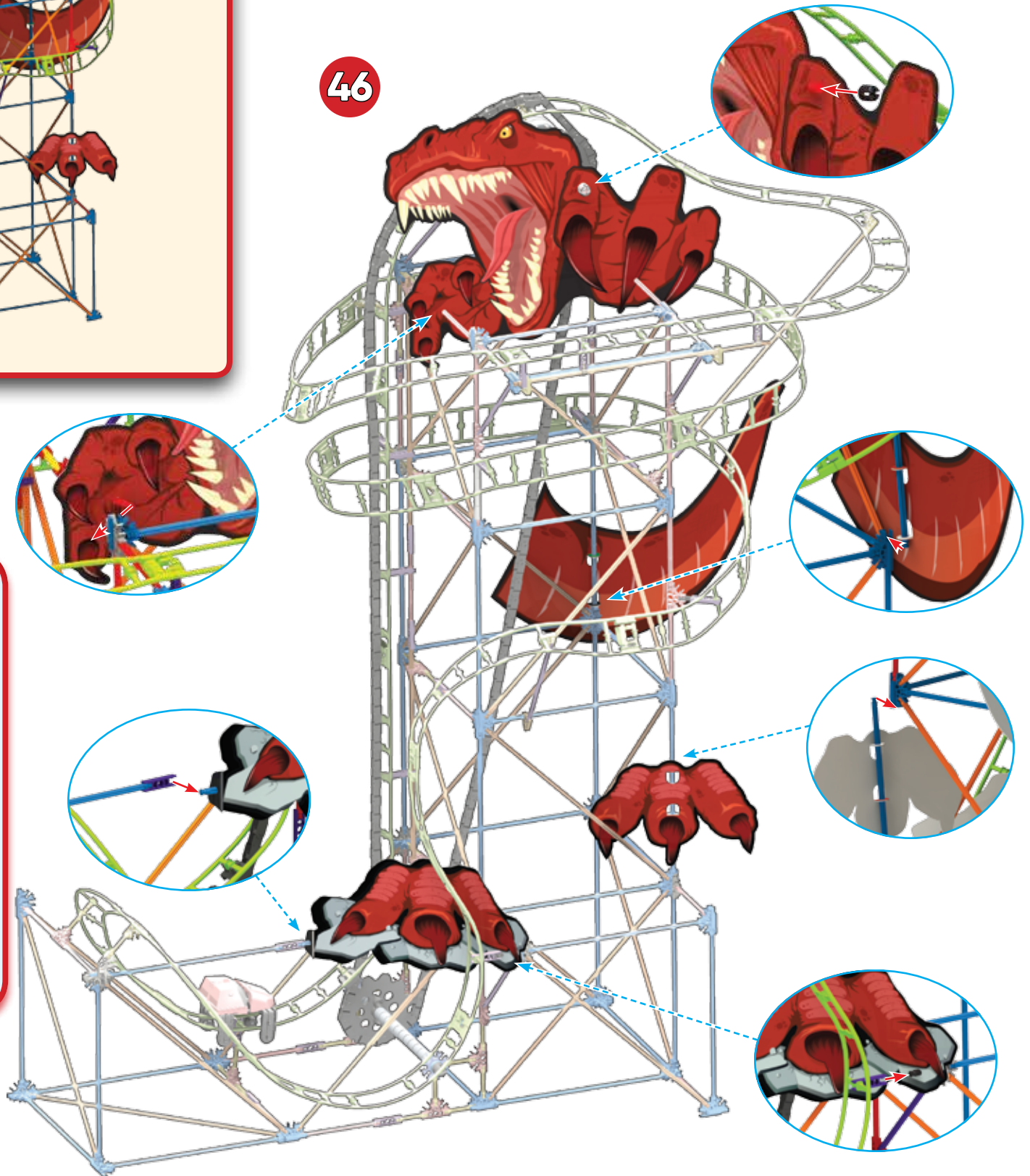

**k'nex**  
**RIDE IT!**

**NOW GRAB YOUR  
VIEWER AND DEVICE,  
OPEN THE APP AND  
RIDE IT!**

**MAINTENANT, PRENEZ  
VOTRE APPAREIL ET  
VISIONNEUSE, OUVREZ  
L'APPLICATION ET  
MONTEZ !**



**k'nex**  
where creativity clicks®

**T-REX FURY**  
Roller Coaster Building Set

**FUREUR DU T-REX**  
Montagnes Russes Jeu de construction

**knex.com**

@knex

facebook.com/knex

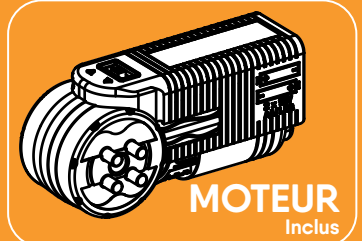

AA (LR6) AA (LR6)  
Non Inclus

**RIPPING RAPTOR**  
Building Set  
**RAPTOR DÉCHIRANT**  
Jeu de Construction



Sold separately  
Vendus séparément

**DINOSAUR DROP**  
Roller Coaster Building Set  
**CHUTE DE DINOSAURE**  
Montagnes Russes Jeu de Construction

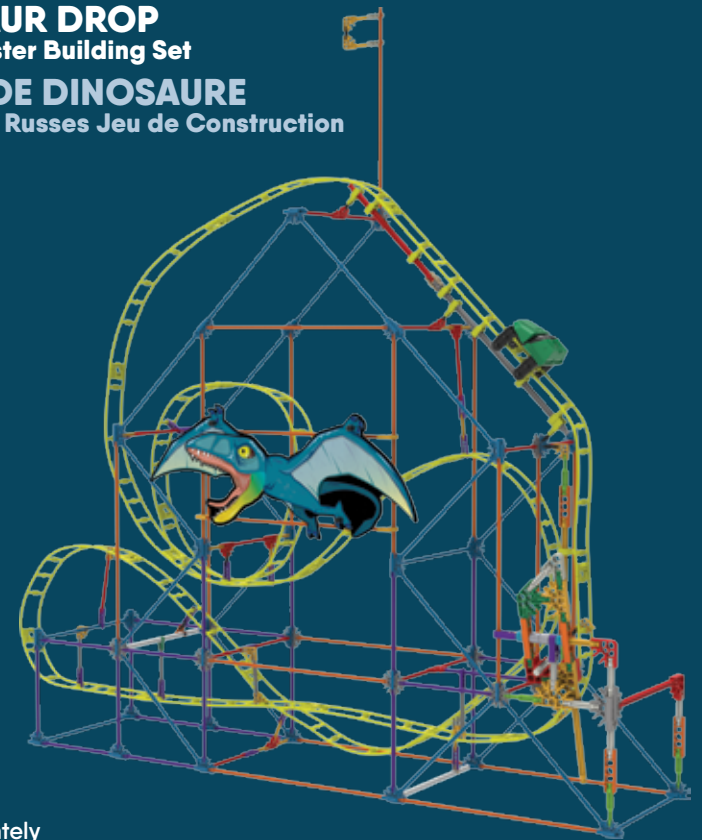

Sold separately  
Vendus séparément

**k'nex RIDE IT!** **k'nex 3D** Download Our Apps  
Téléchargez notre applications

(EN) Product & colors may vary. Most models can be built one at a time.  
(FR) Le produit et ses couleurs peuvent varier. Les différents modèles ne peuvent être construits qu'un par un.  
(ES) El producto y los colores pueden variar. La mayoría de los modelos se pueden construir uno a la vez.  
(DE) Produkte und Farben können abweichen. Die meisten Modelle können immer nur einzeln gebaut werden.  
(IT) Prodotti e colori possono differire. La maggior parte dei modelli si può costruire autonomamente. Istruzioni accluse.  
(PT) O produto e as cores podem variar. A maioria dos modelos pode ser montado um de cada vez.  
(NL) Product en kleuren kunnen variëren. De meeste modellen kunnen uitsluitend een voor een worden gebouwd.

**k'nex**  
**RIDE IT!**

**CONSTRUIRE ET  
ROULER APPLICATION  
+ VISIONNEUSE INCLUS**

©2018 K'NEX, a Division of Basic Fun, Inc., P.O. Box 700, Hatfield, PA 19440-0700; 1-800-KID-KNEX (USA/Canada/États-Unis/EE.UU.); email@knex.com; knex.com. K'NEX UK Ltd, 200 Brook Drive, Green Park, Reading, RG6 2UB England; K'NEX France, 24 rue du Quatre Septembre, 75002 Paris, France. For customers outside the USA/Canada please contact your local distributor at [www.knex.com/distributors](http://www.knex.com/distributors).

(FR) Pour les clients en dehors du Canada et des États-Unis, veuillez contacter votre distributeur local que vous pouvez trouver sur [www.knex.com/distributors](http://www.knex.com/distributors).

(ES) El cliente que no vive en EE.UU./Canadá se pone en contacto con el distribuidor local. Encuentre la información para el distribuidor local en [www.knex.com/distributors](http://www.knex.com/distributors).

(EN) K'NEX and Where Creativity Clicks are registered trademarks and Thrill Rides is a trademark of Basic Fun, Inc.

(FR) K'NEX et Where Creativity Clicks sont des marques déposées et Thrill Rides est une marque de commerce de Basic Fun, Inc.