

SONIC BOOM

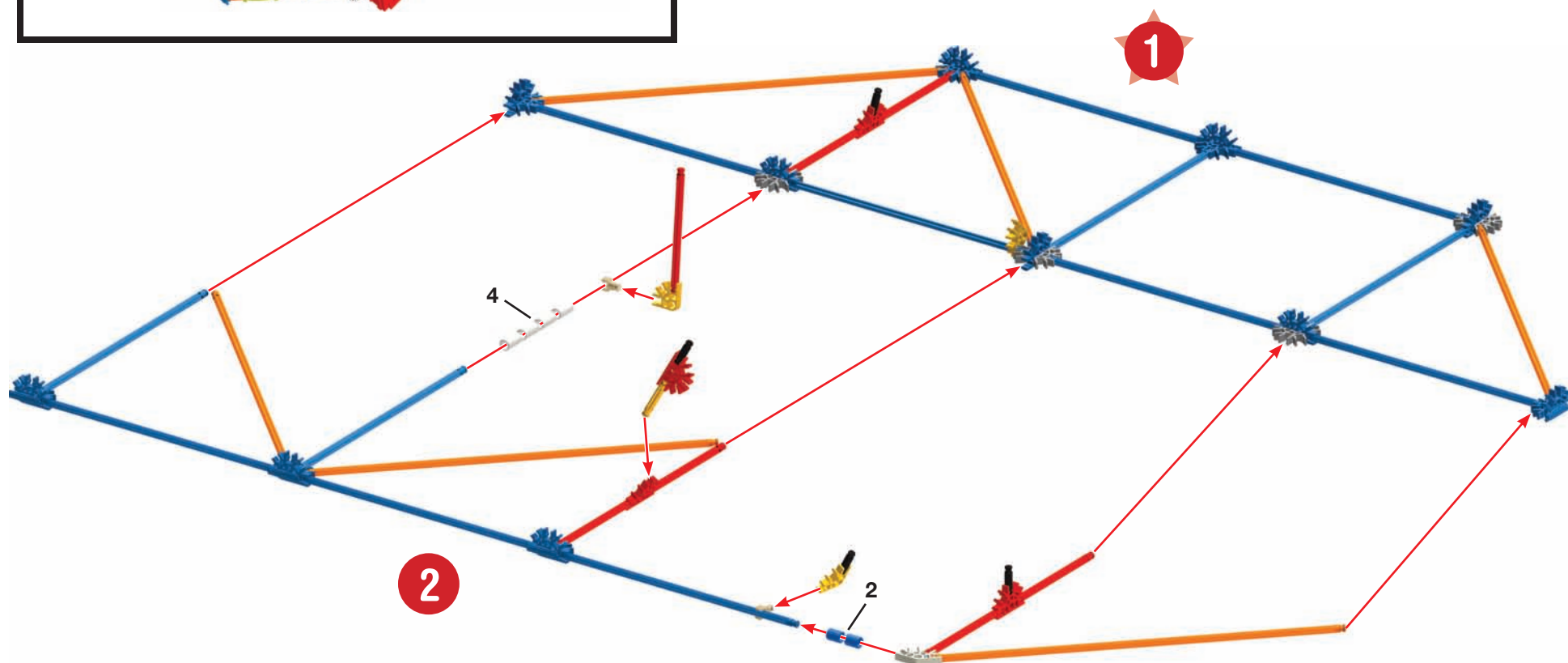

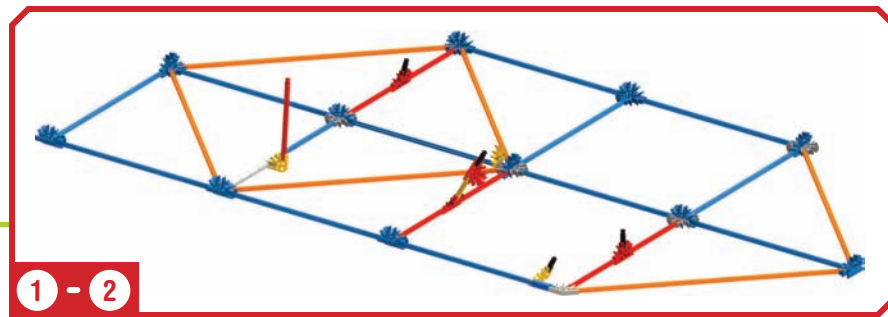
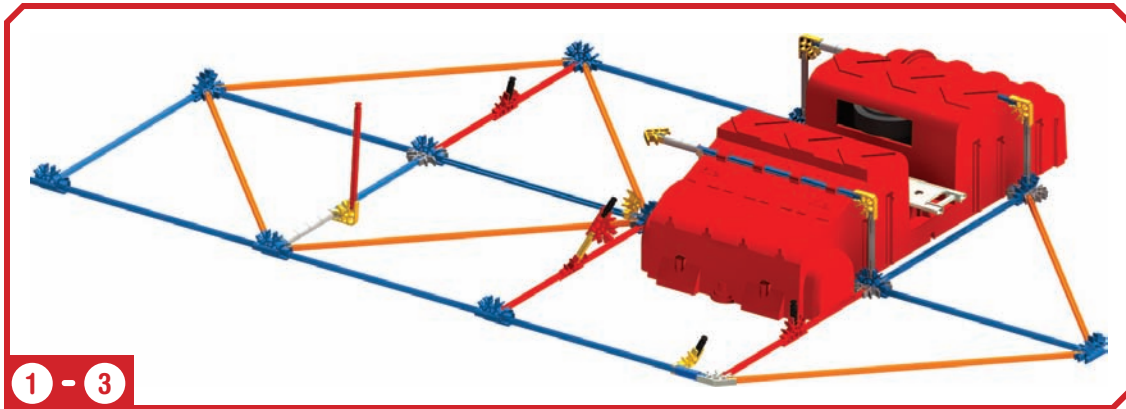

1 - 3

Did you install 3 C (or LR14) batteries in the motor?

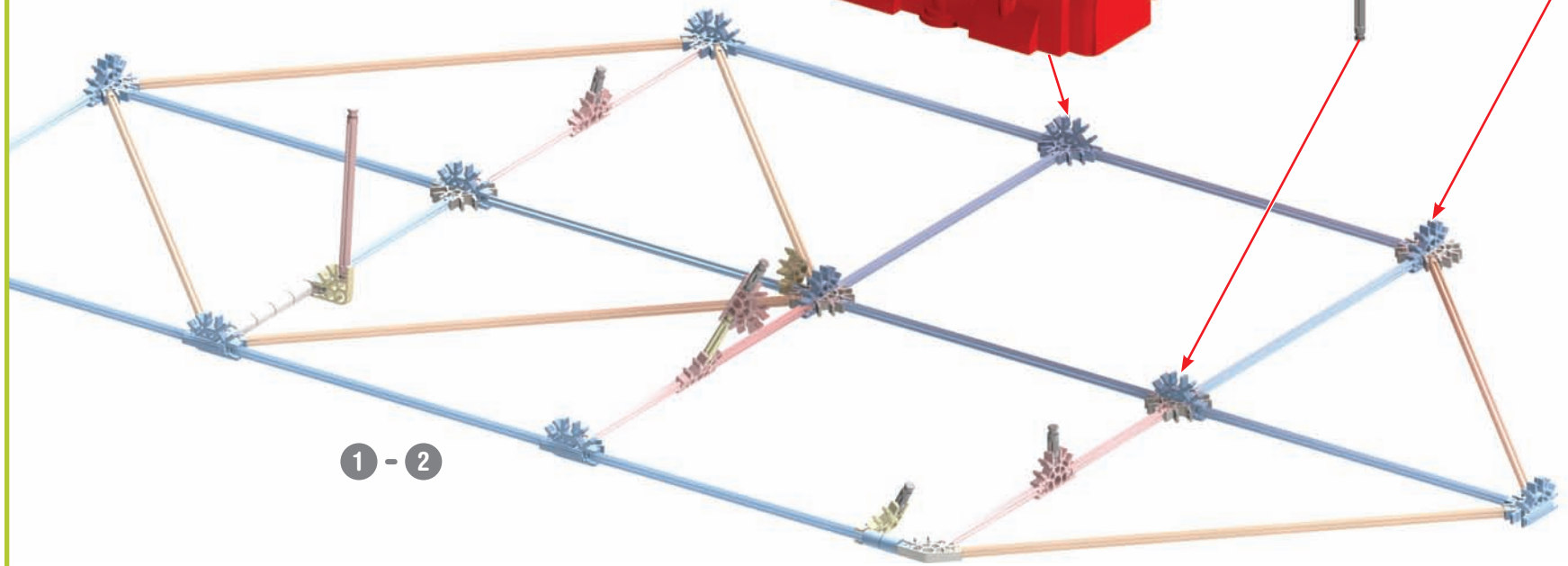
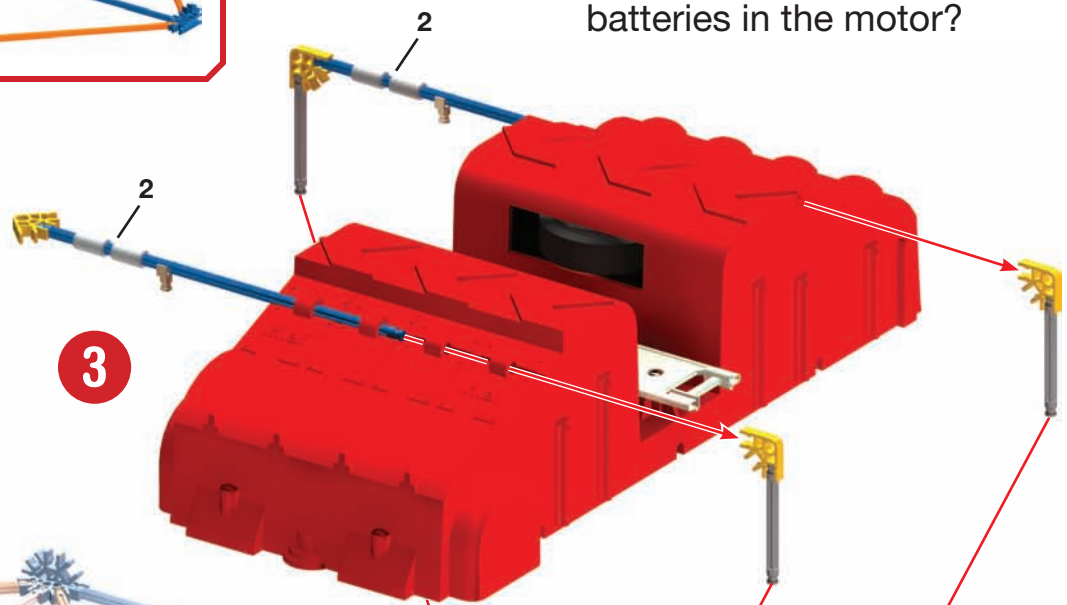

1 - 2

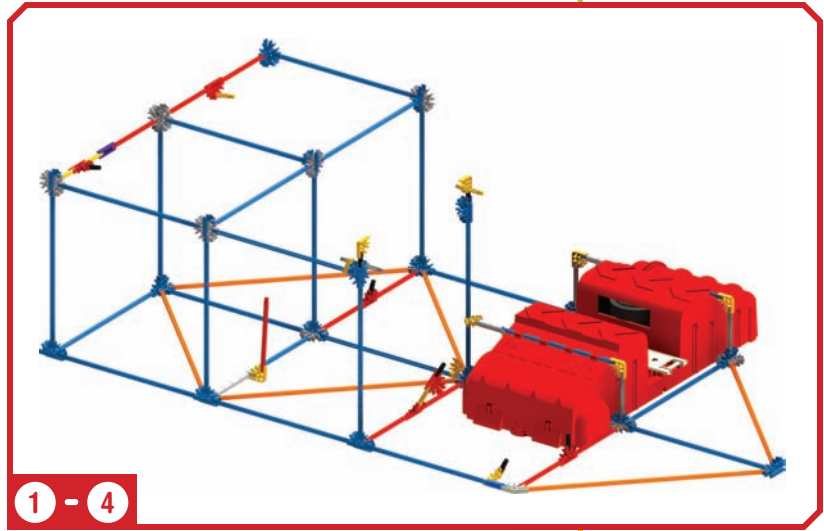
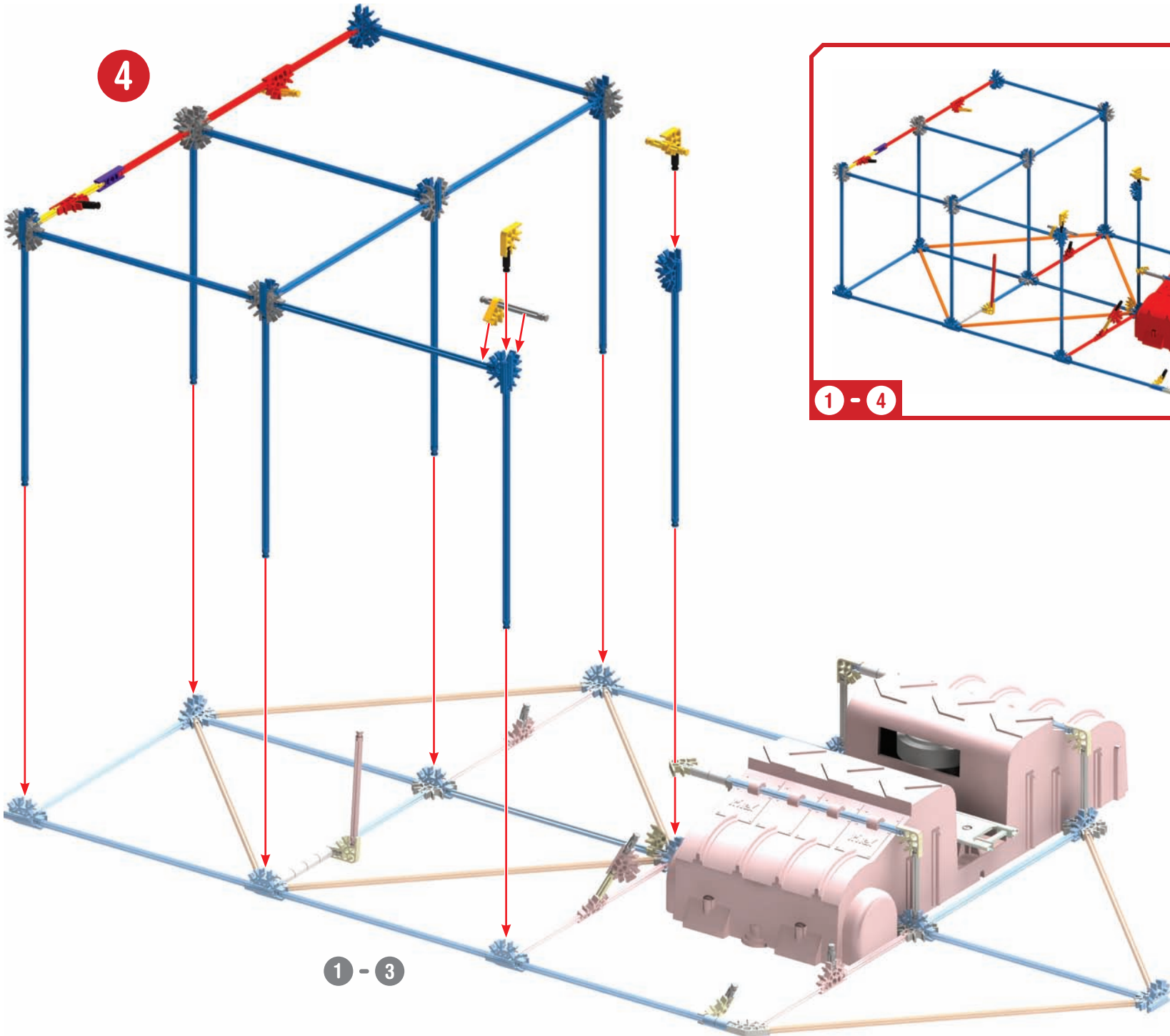

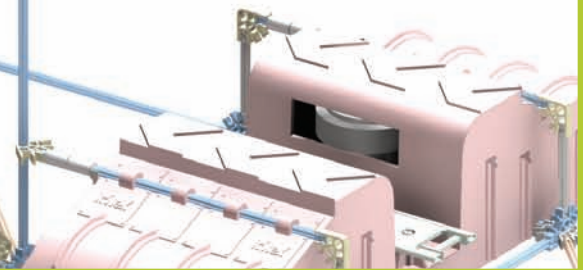
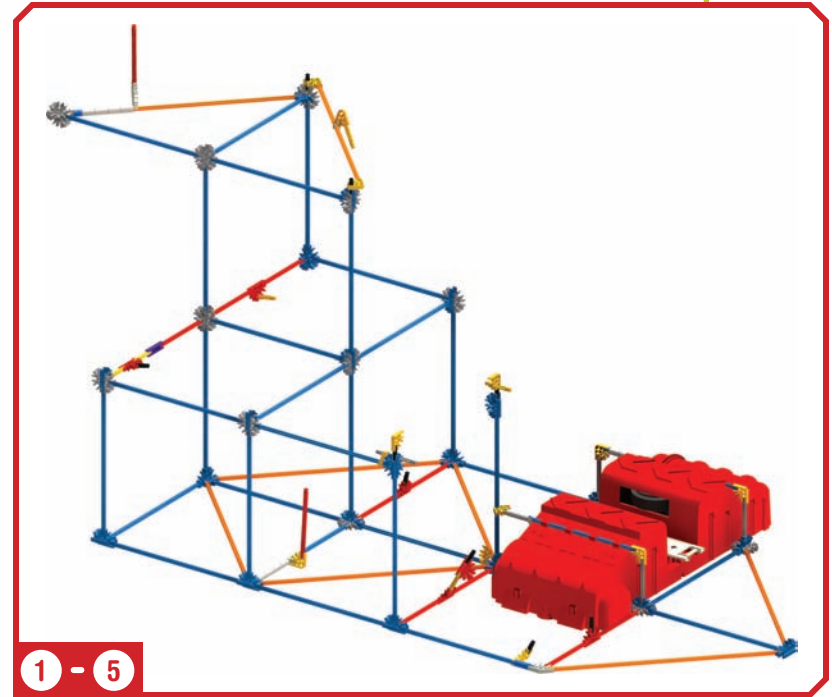
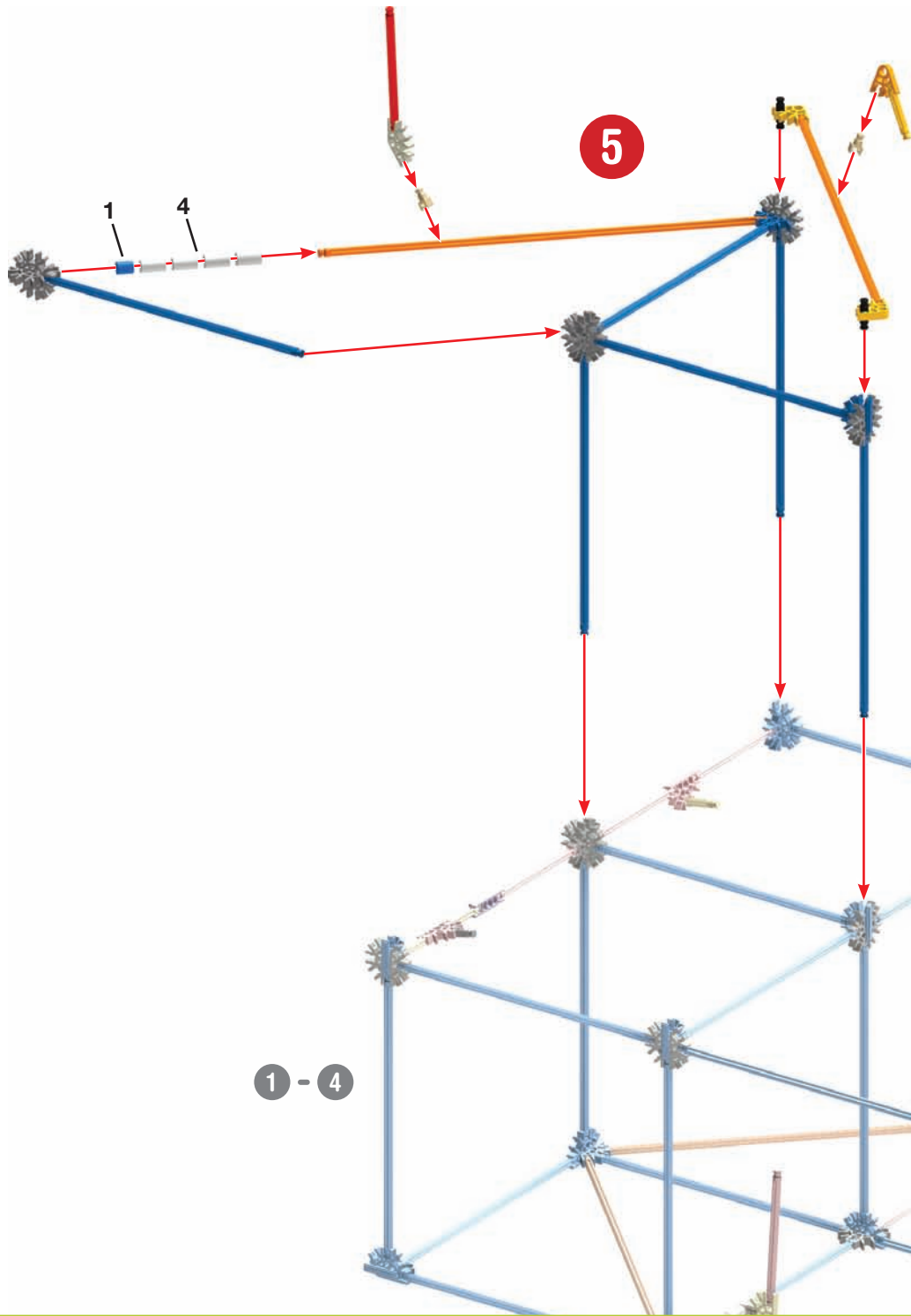

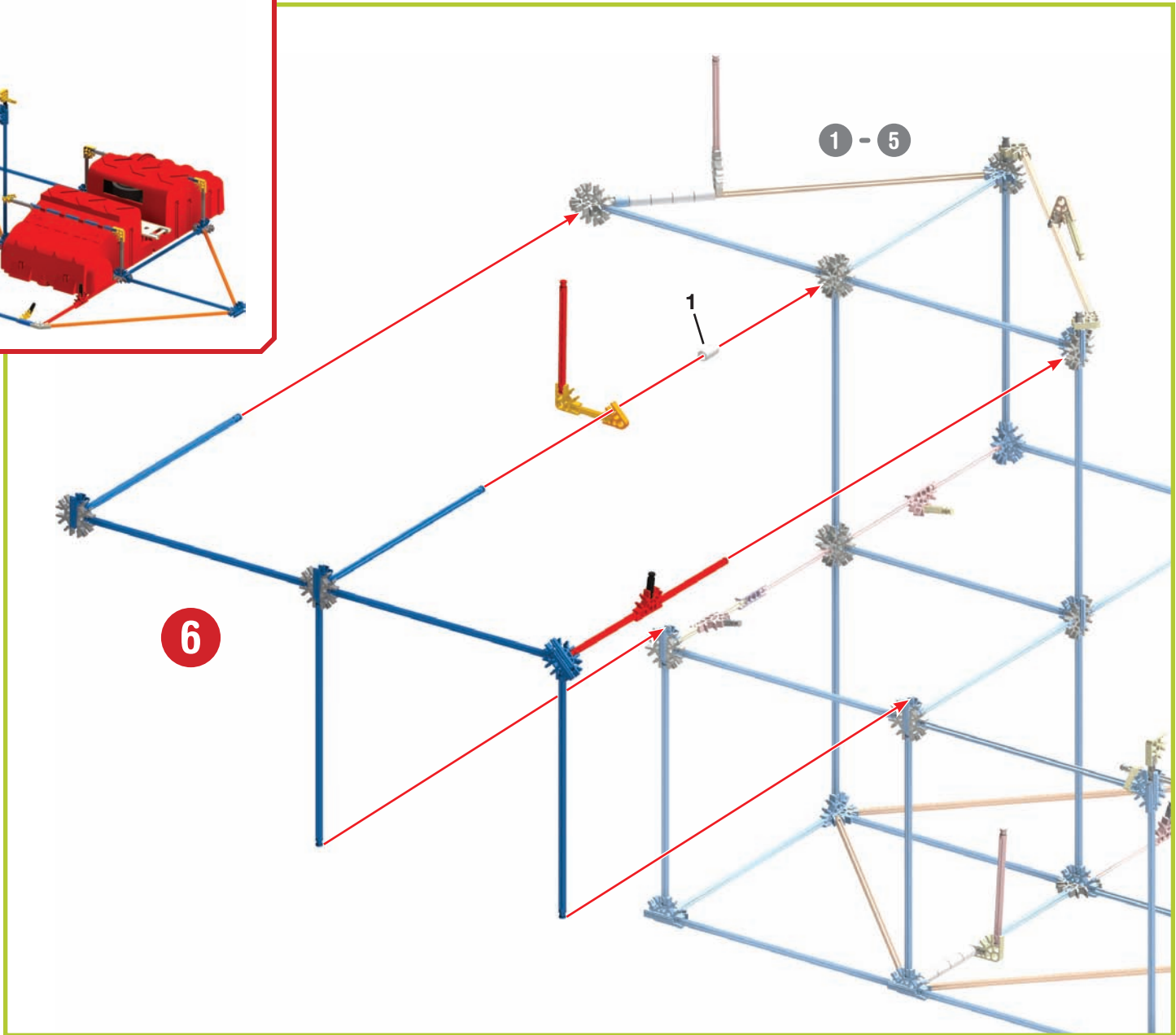
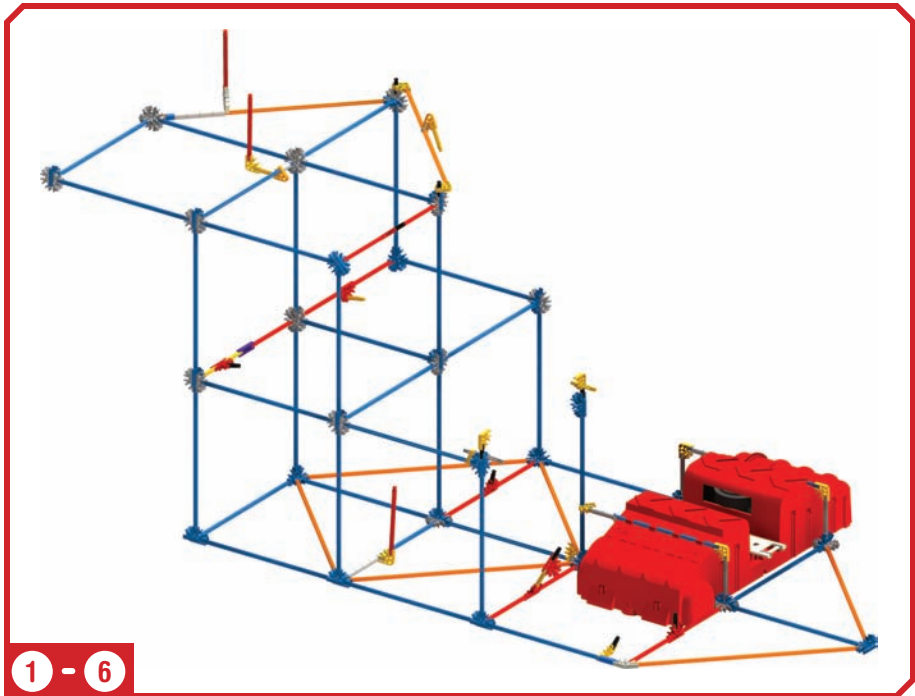

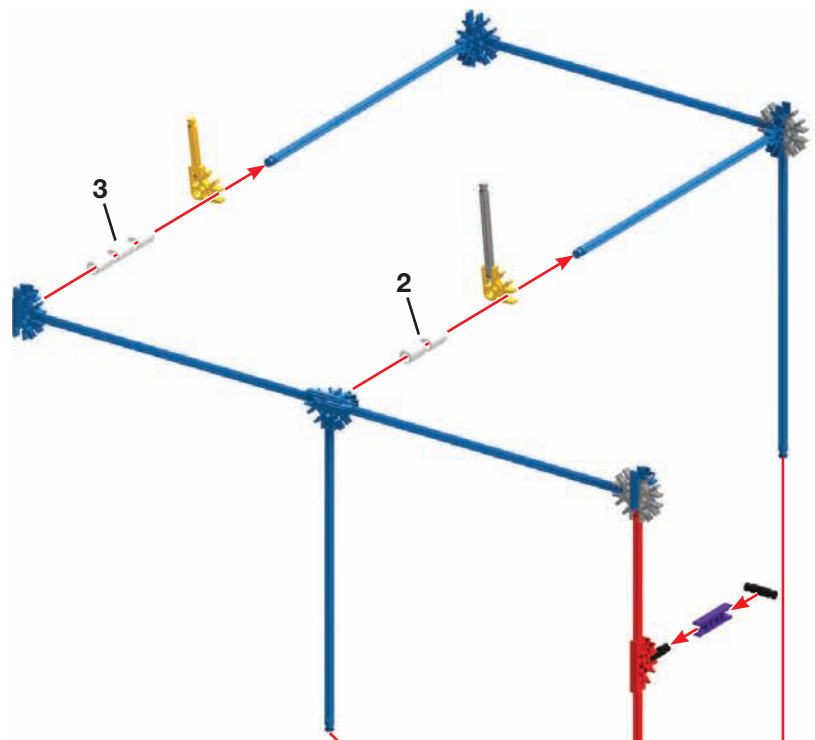

7

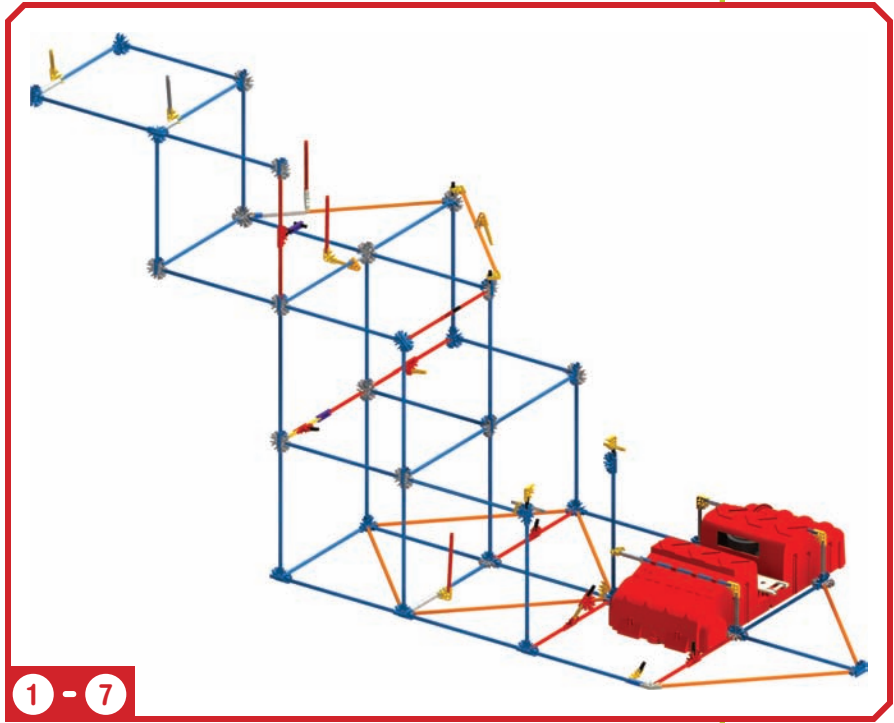

1 - 6

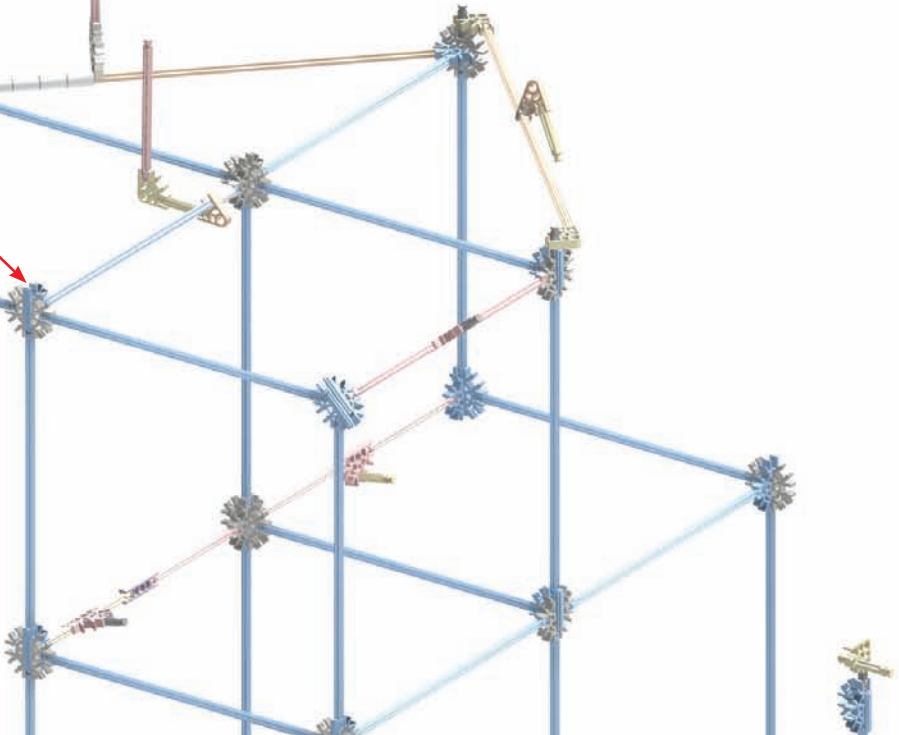

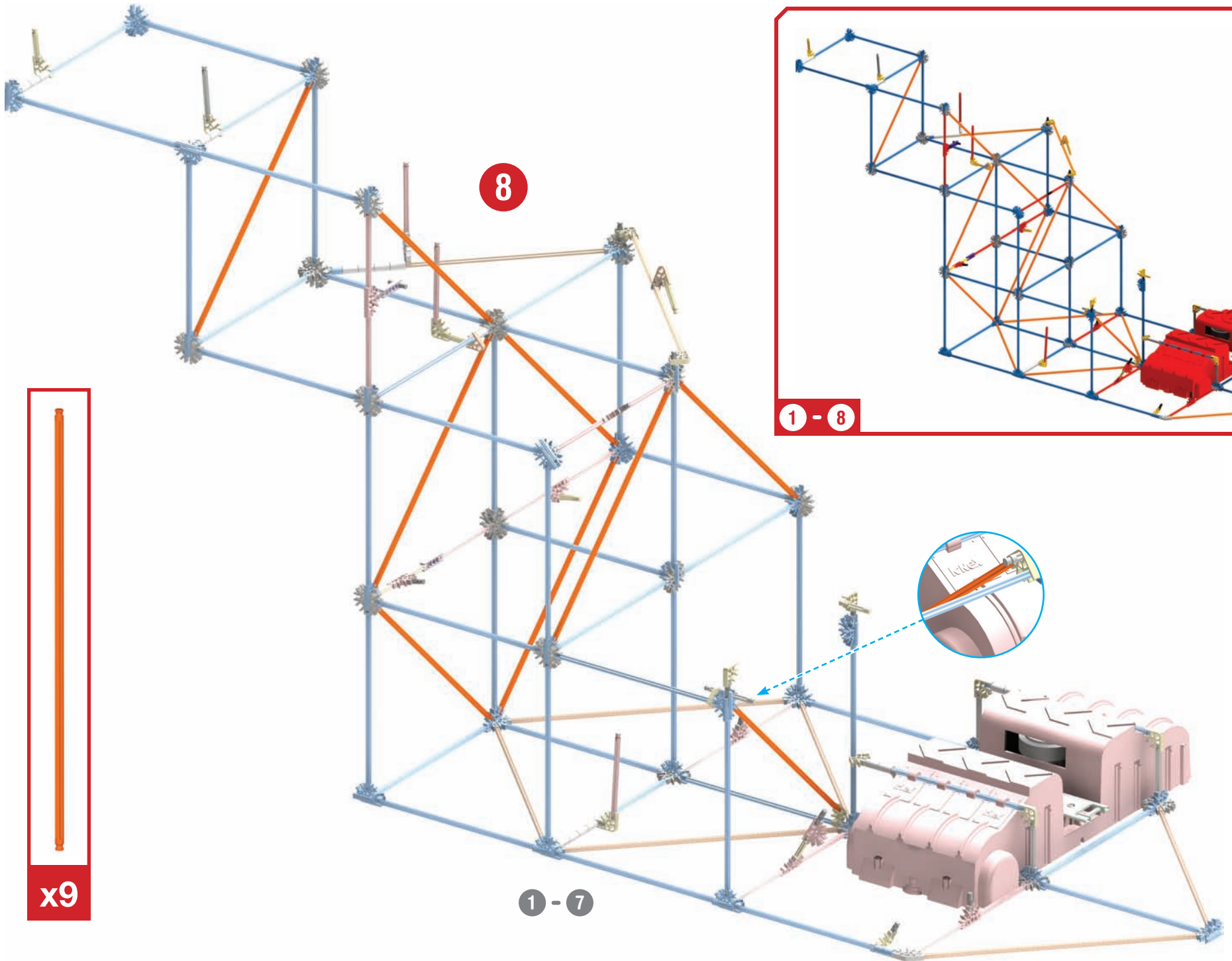

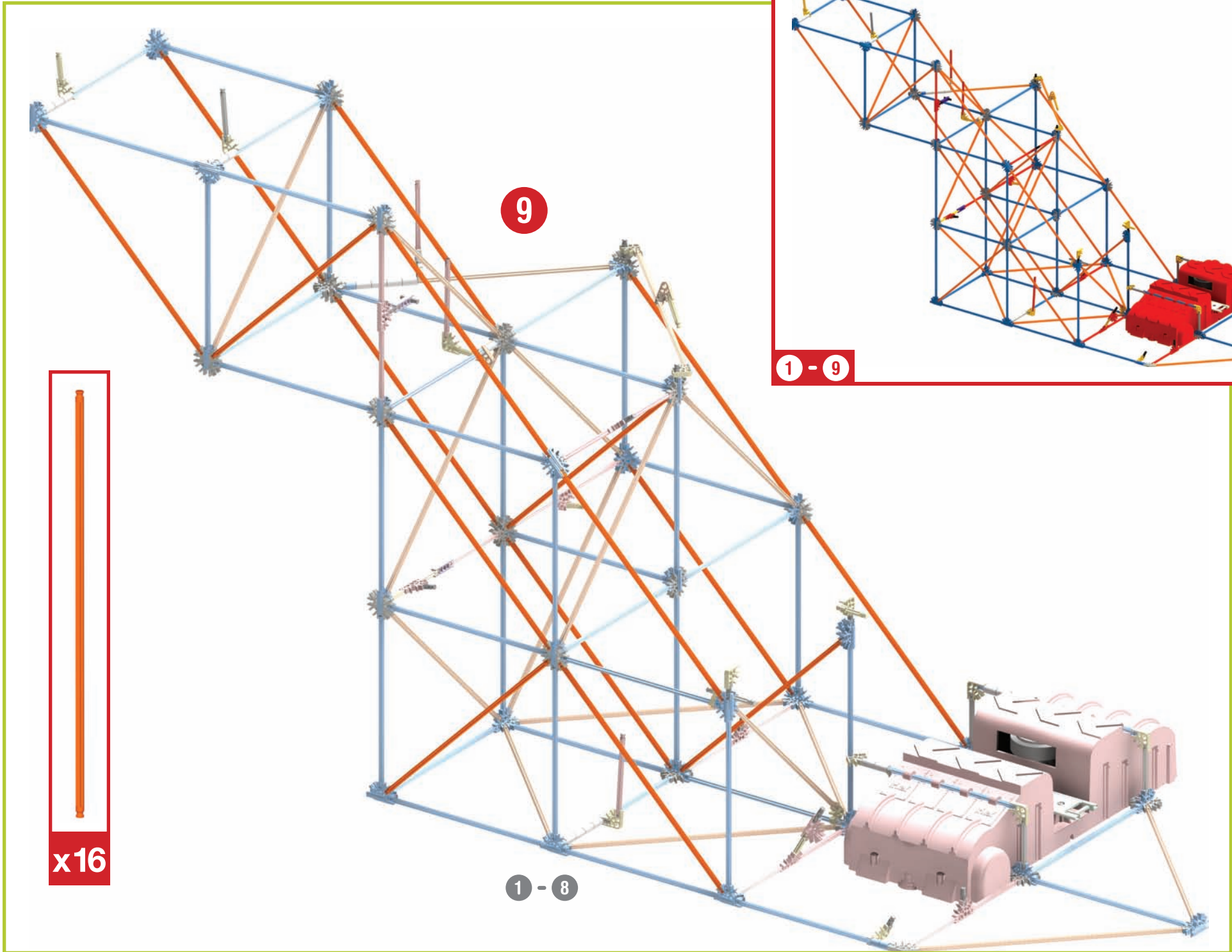

9

1 - 9



x16

1 - 8

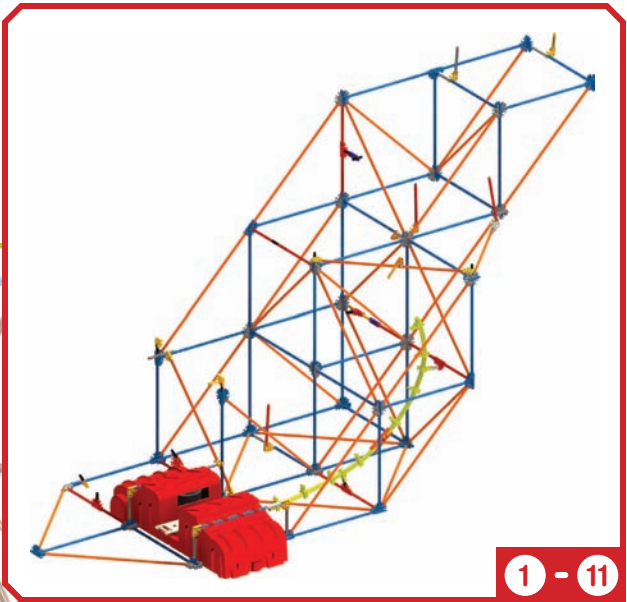
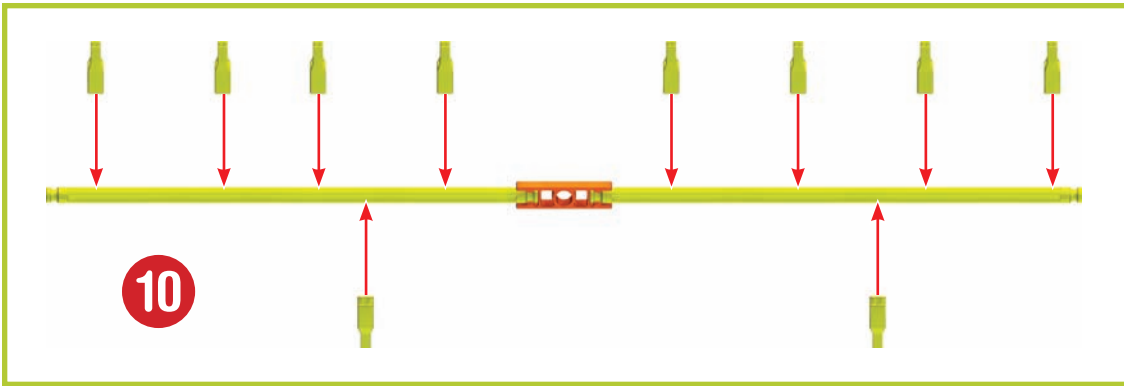

Flexi-rod

A Flexi-rod is a rod that you bend to make curves. It will be easier to attach to your model if you bend it back and forth first.

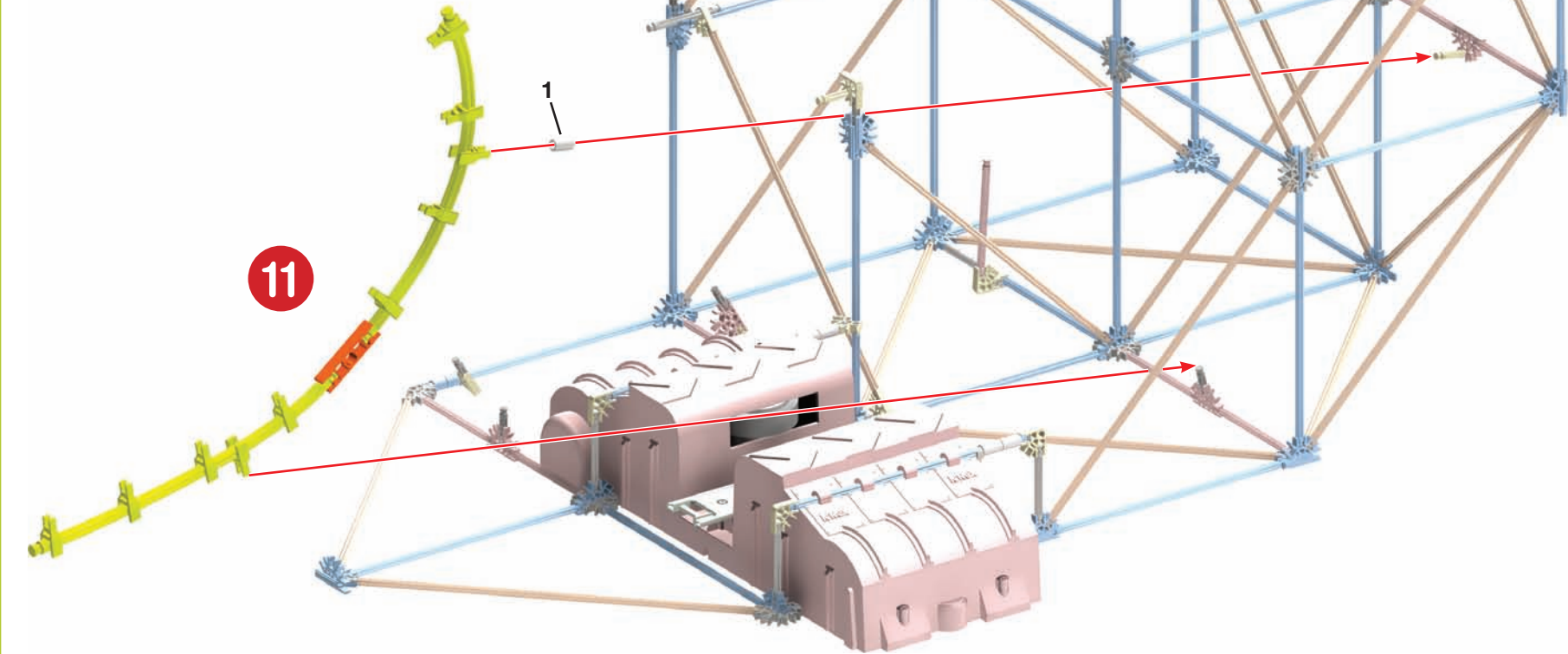

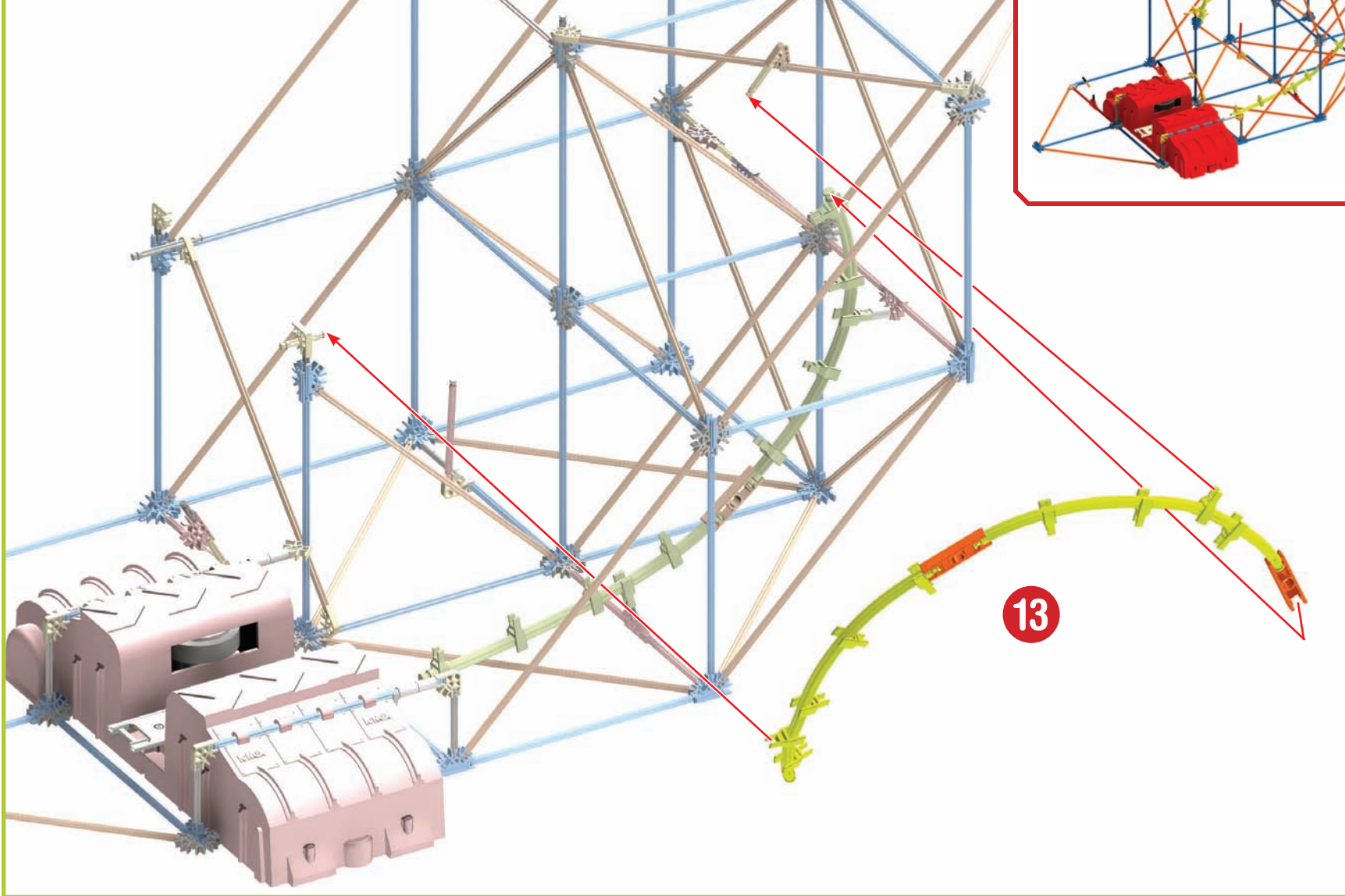
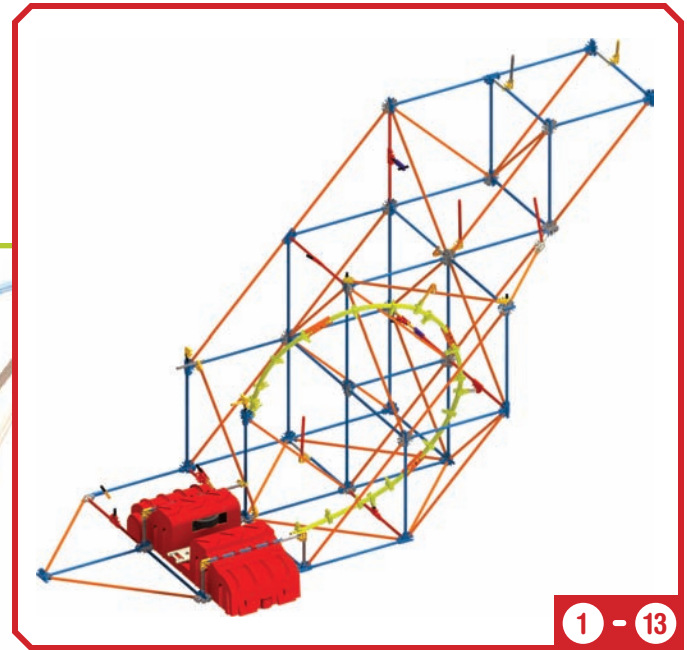
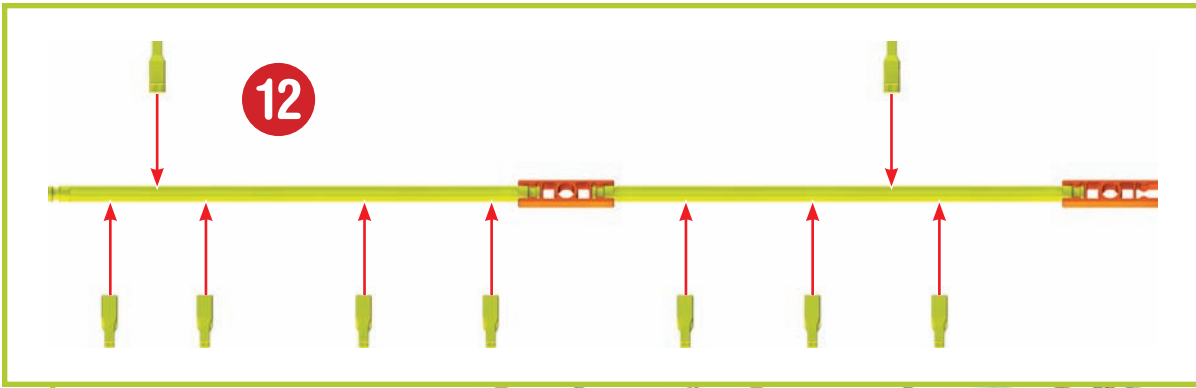

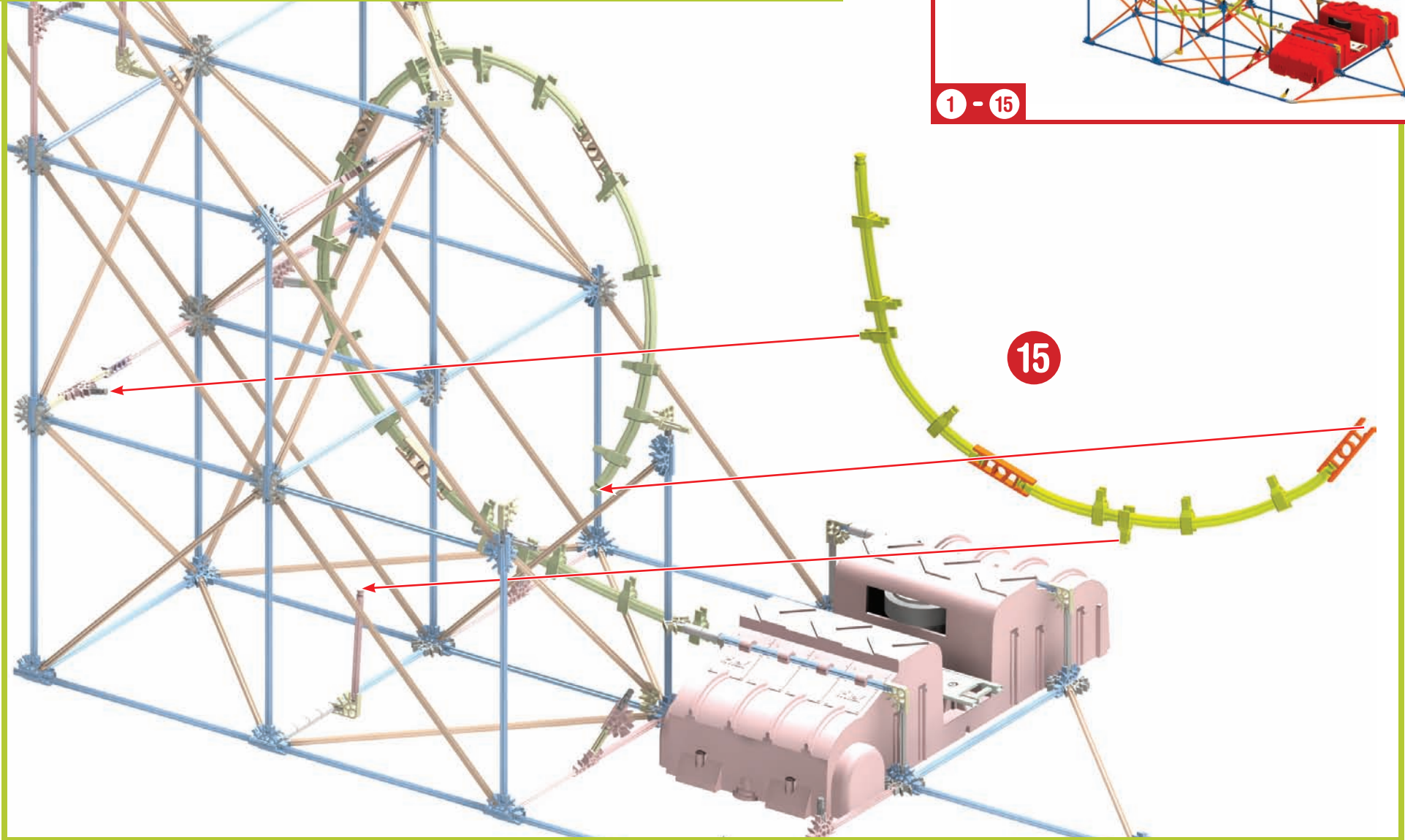
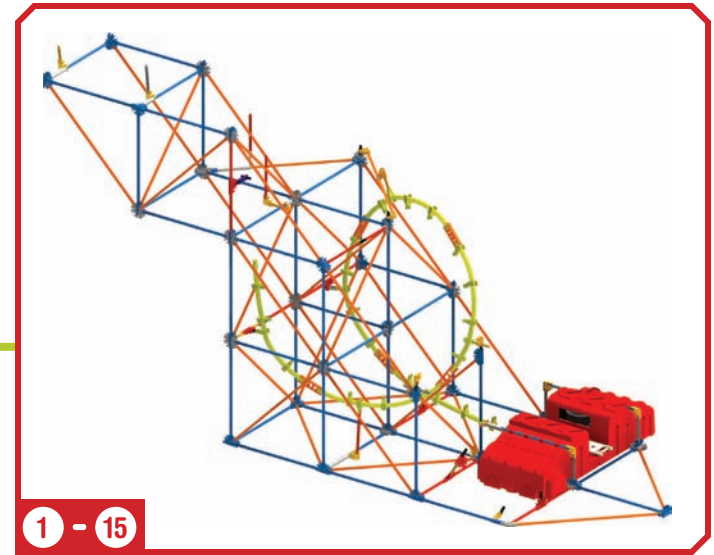
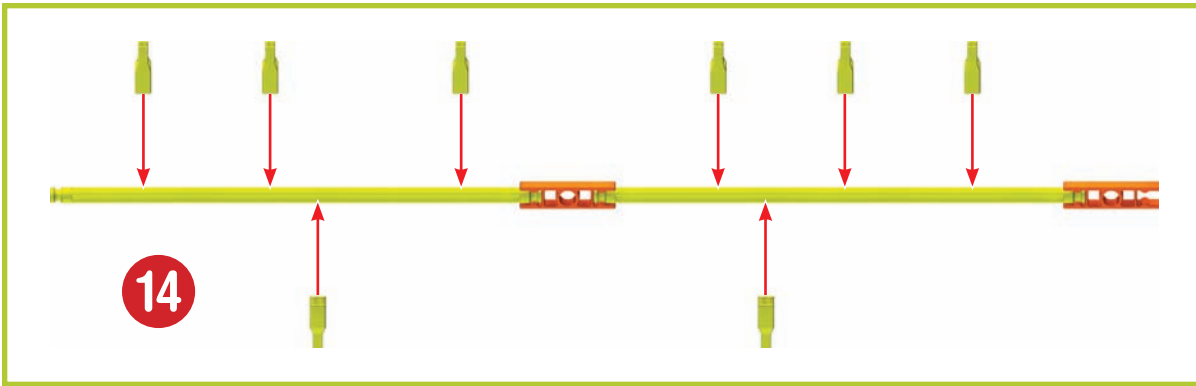

17

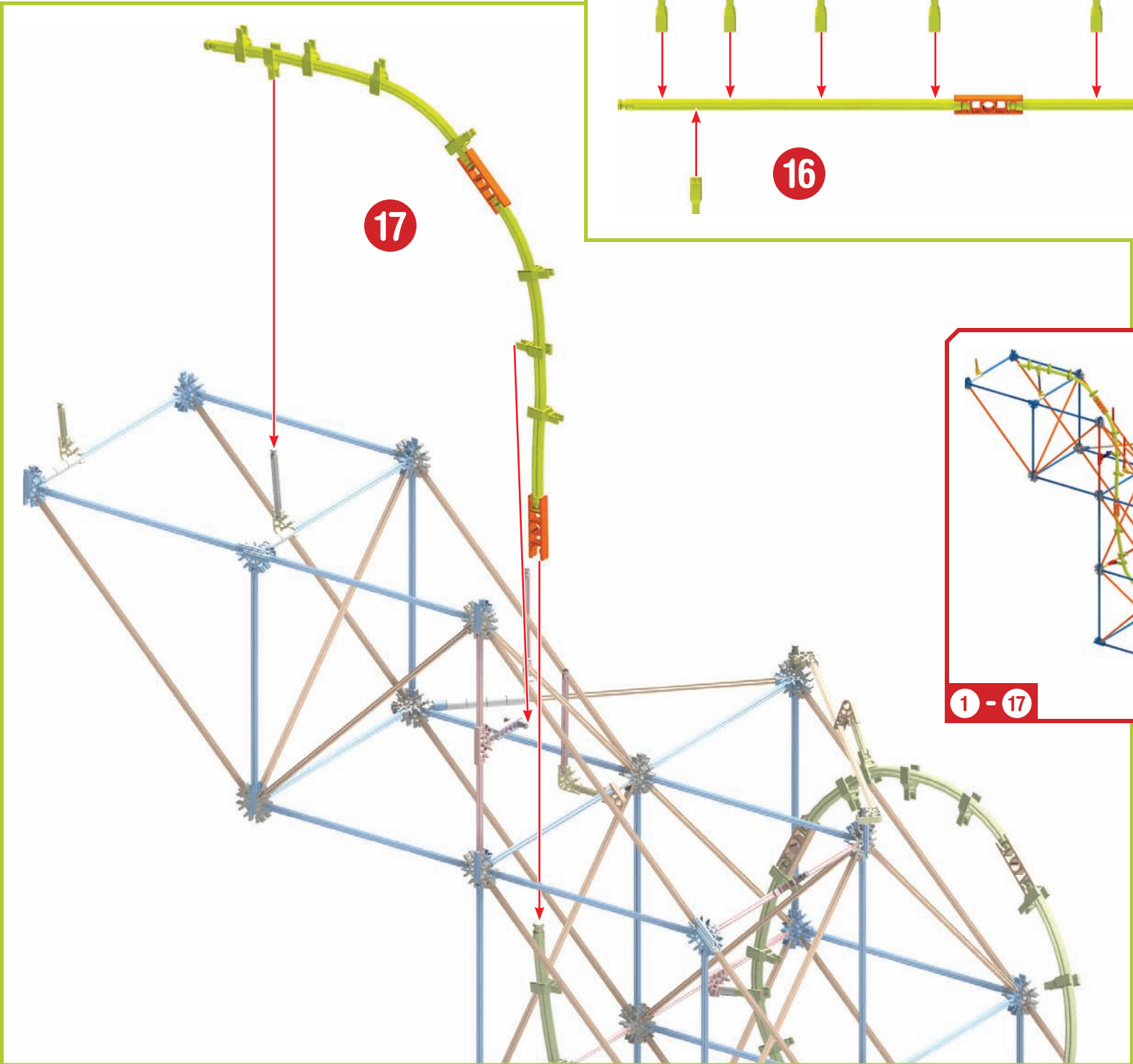
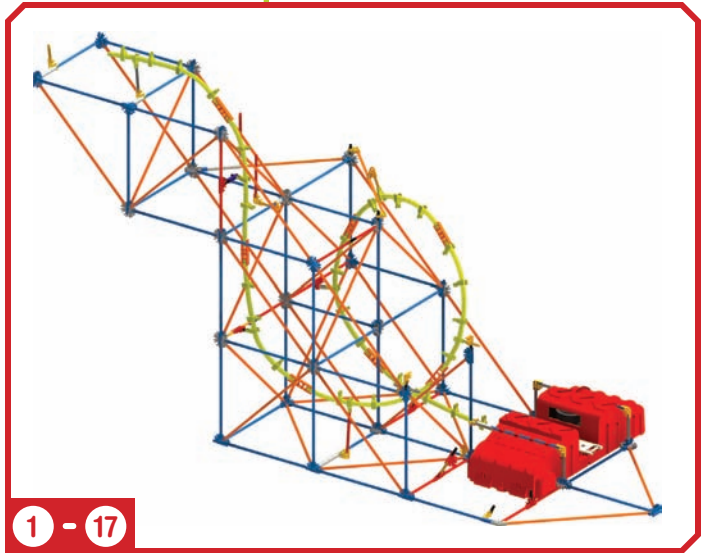
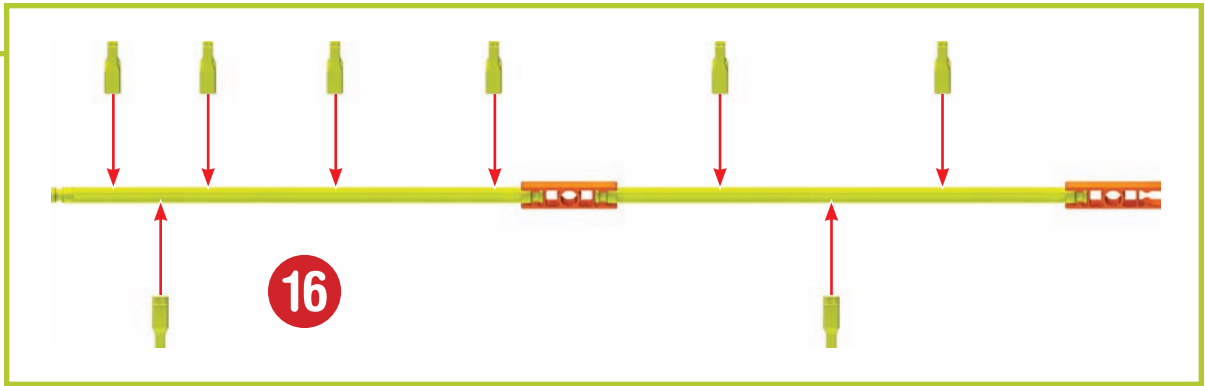

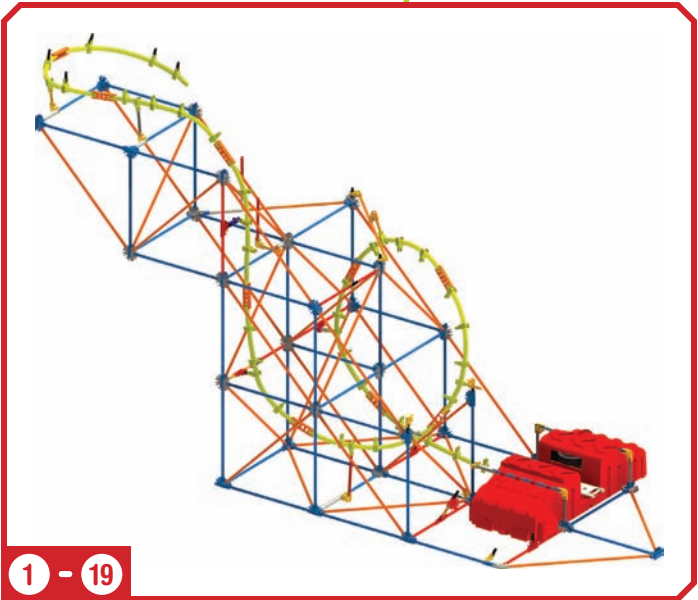
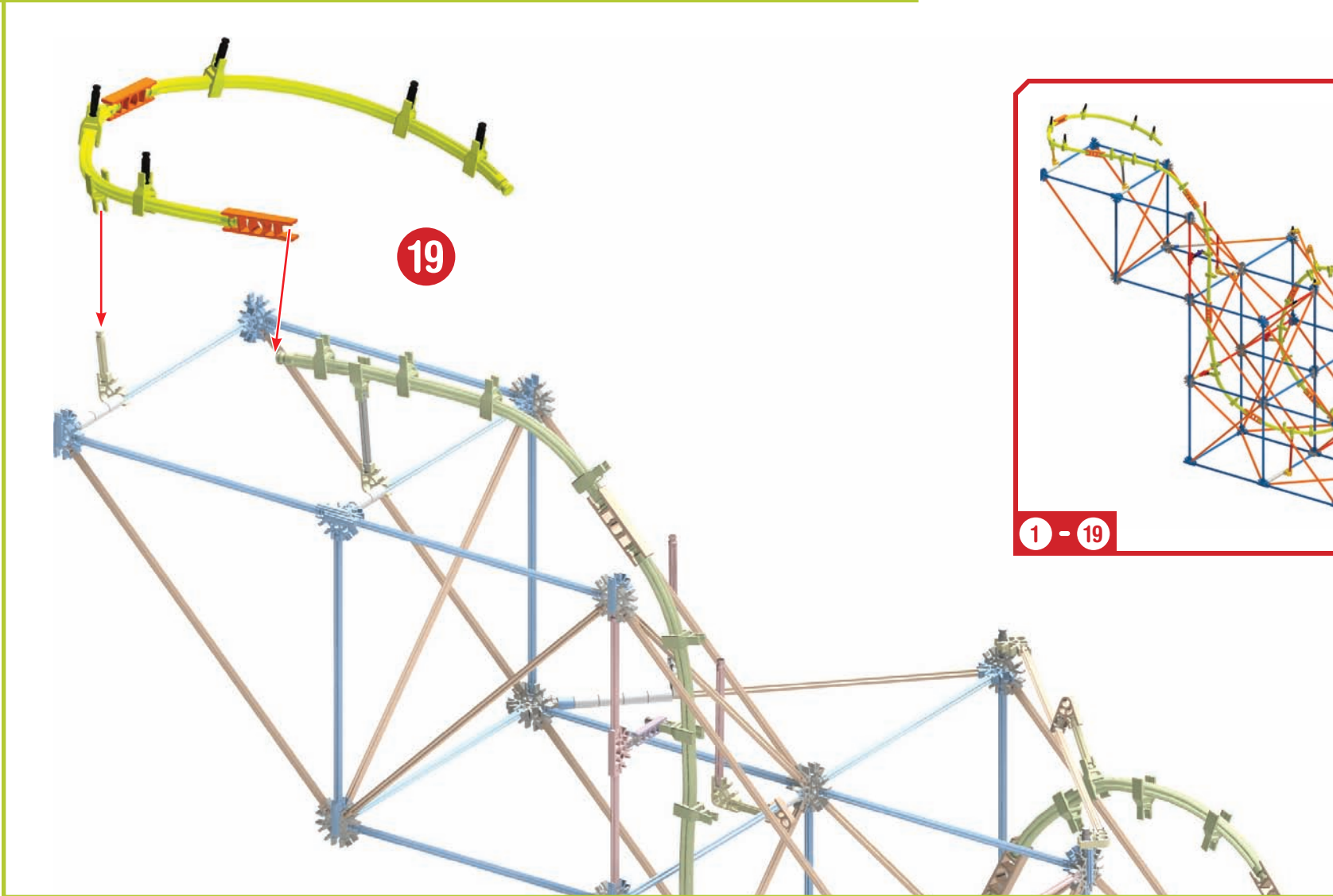
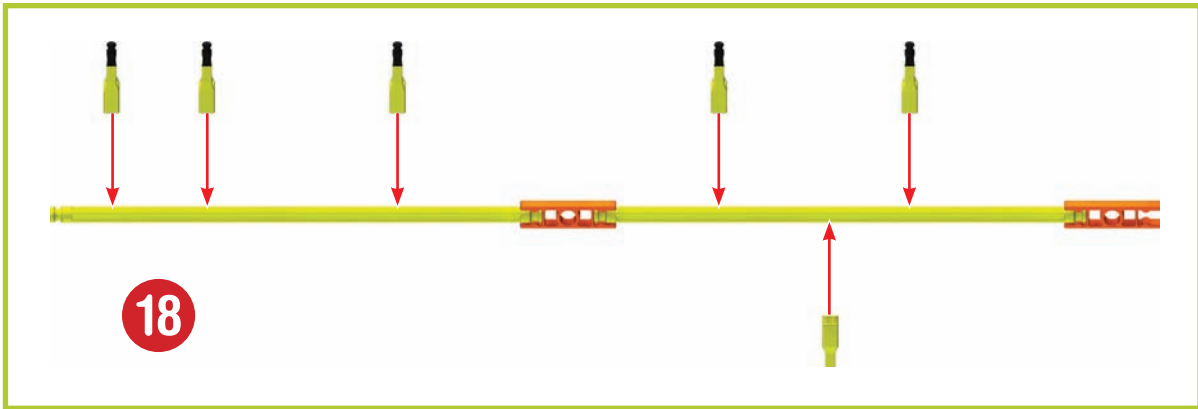

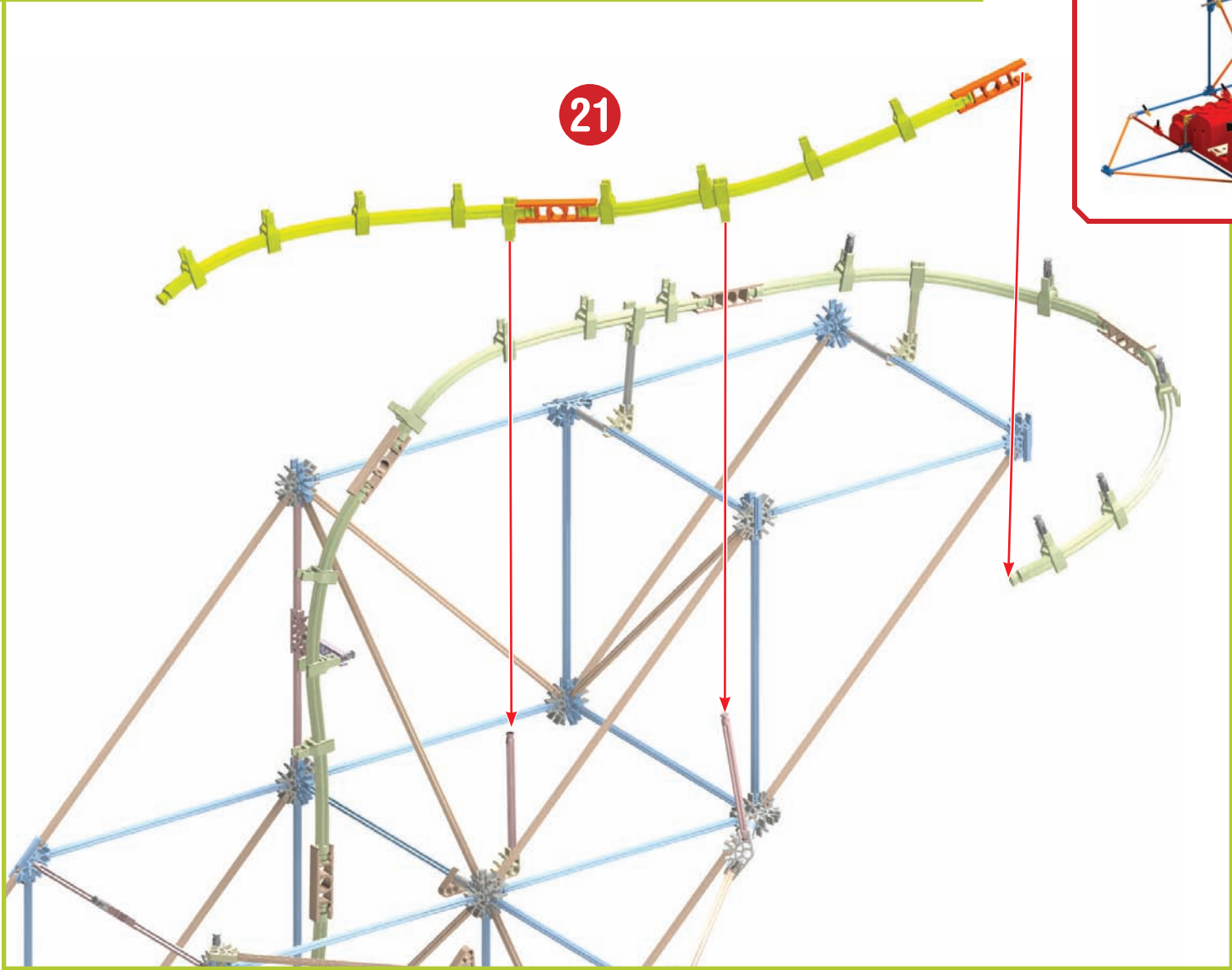
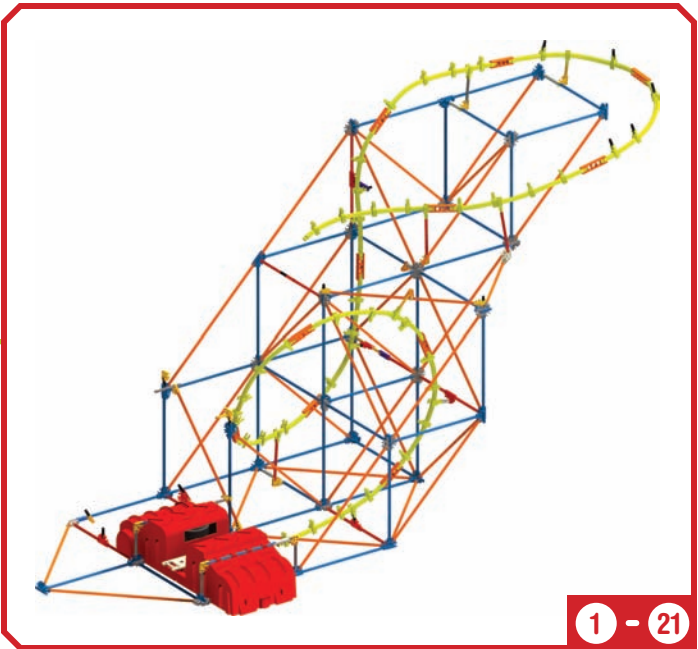
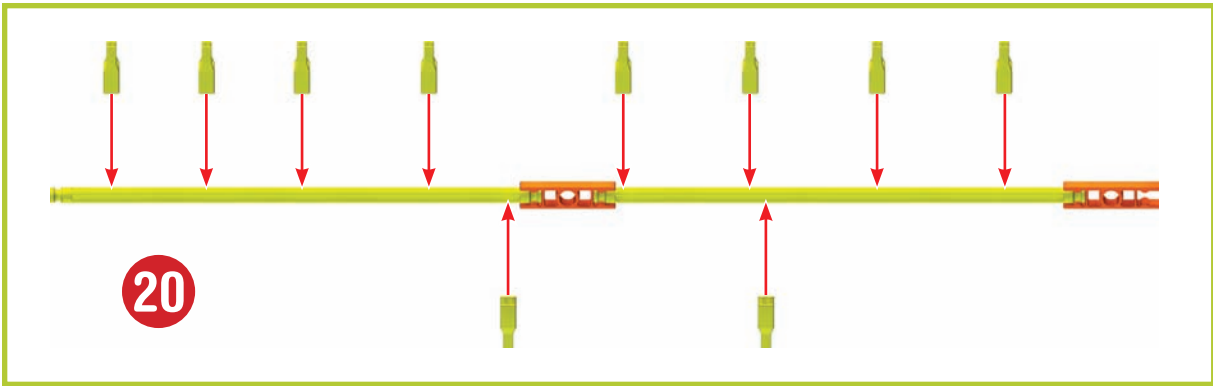

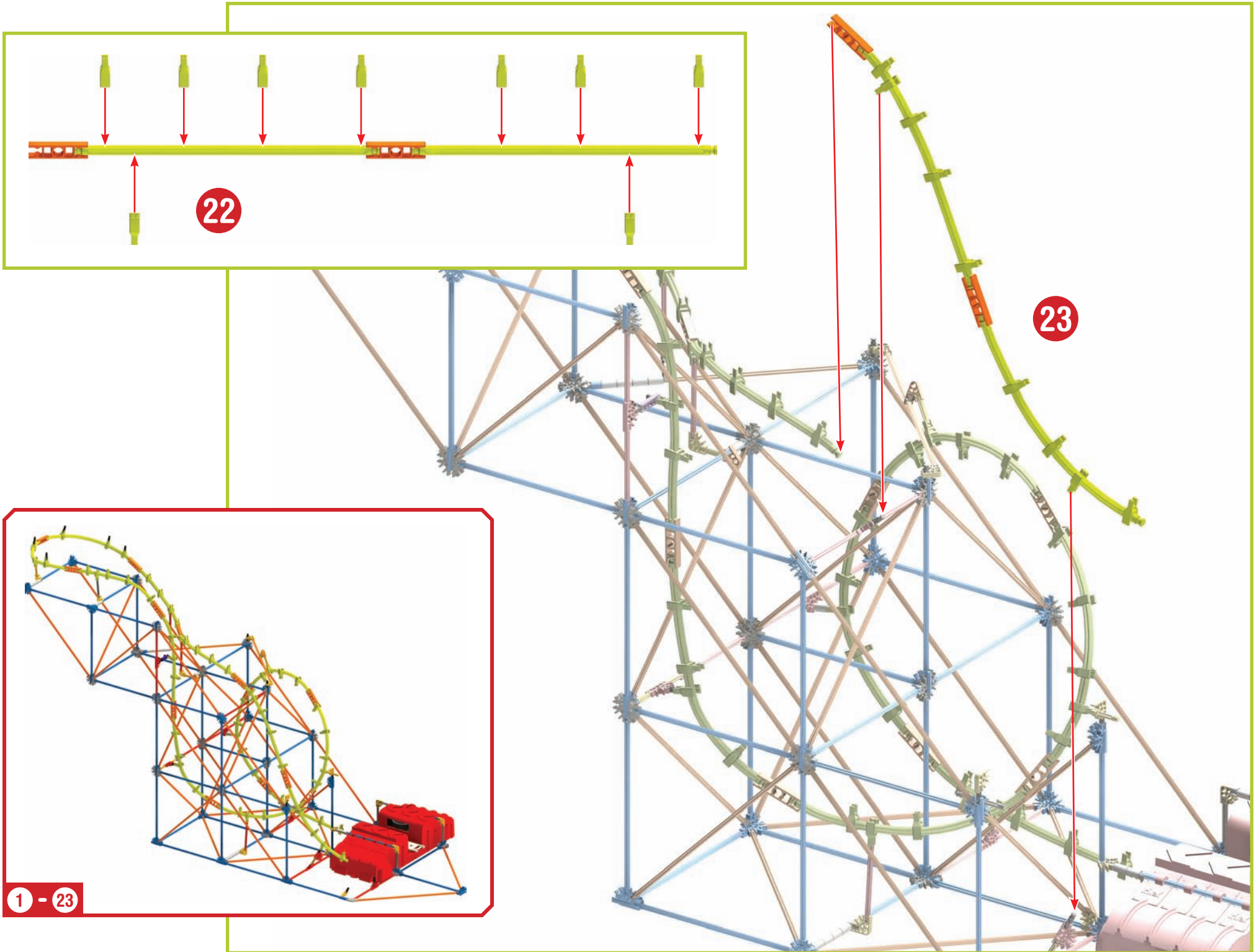

22

23

1 - 23

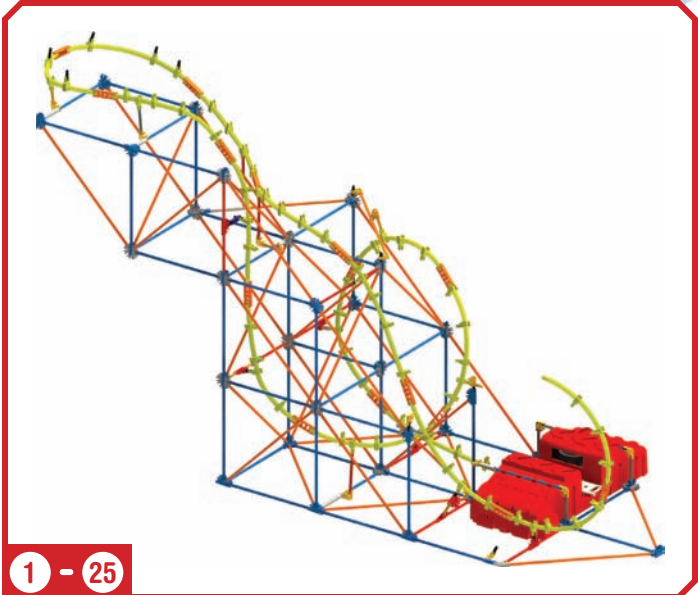
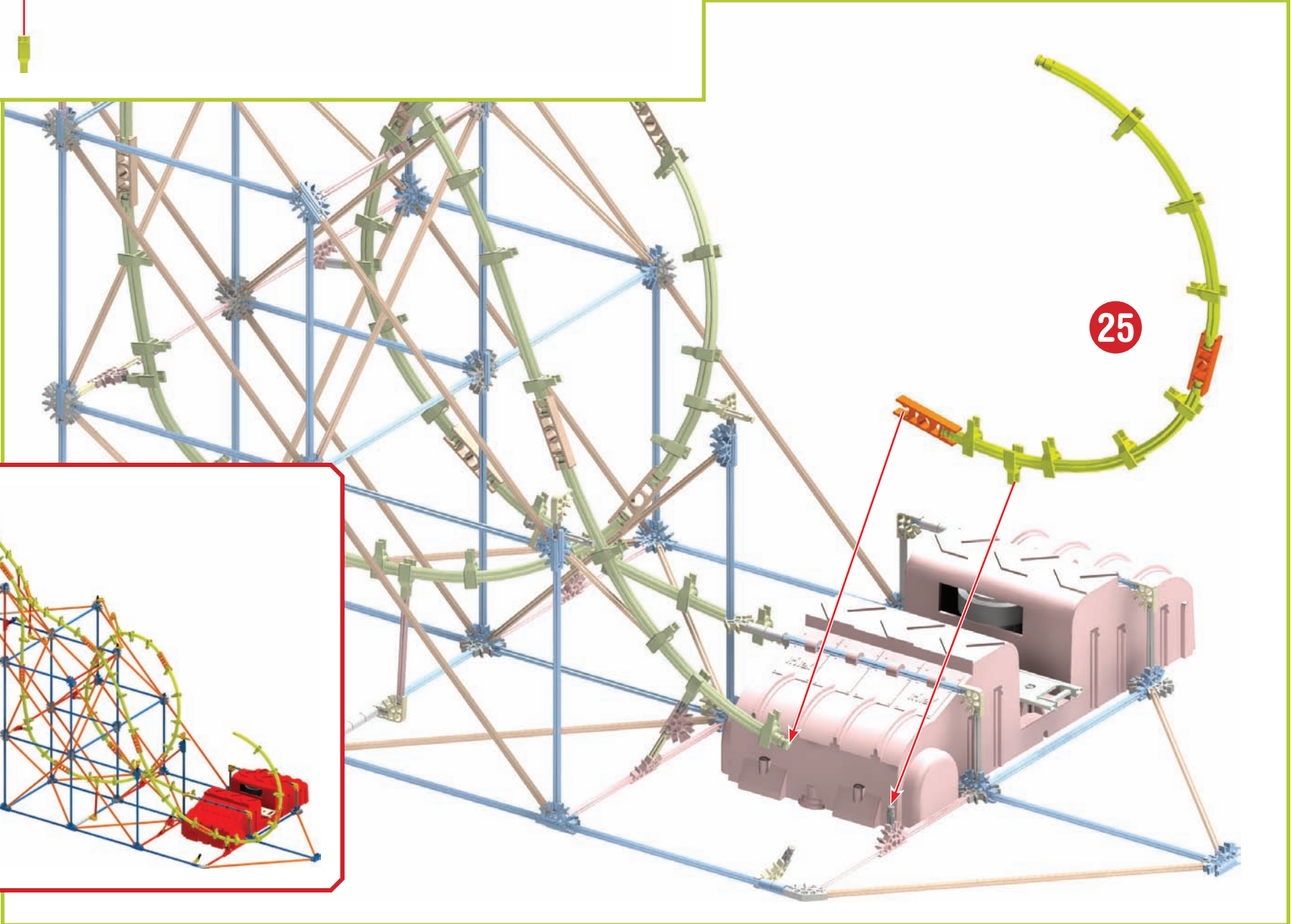
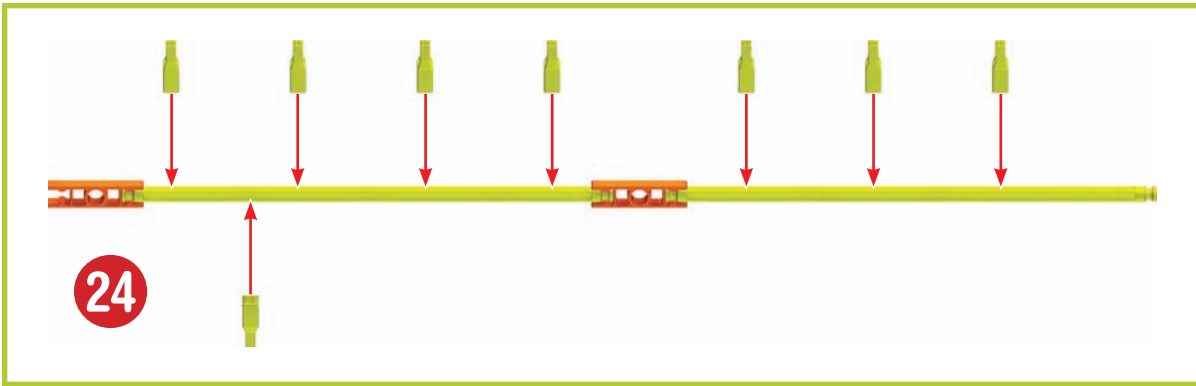

26

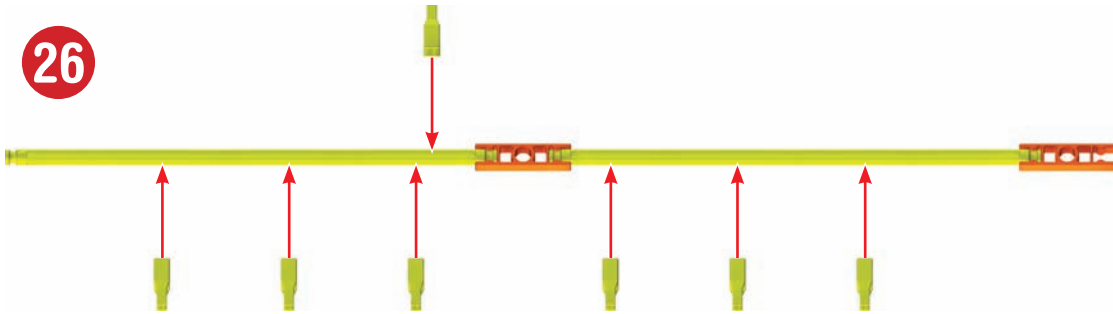

27

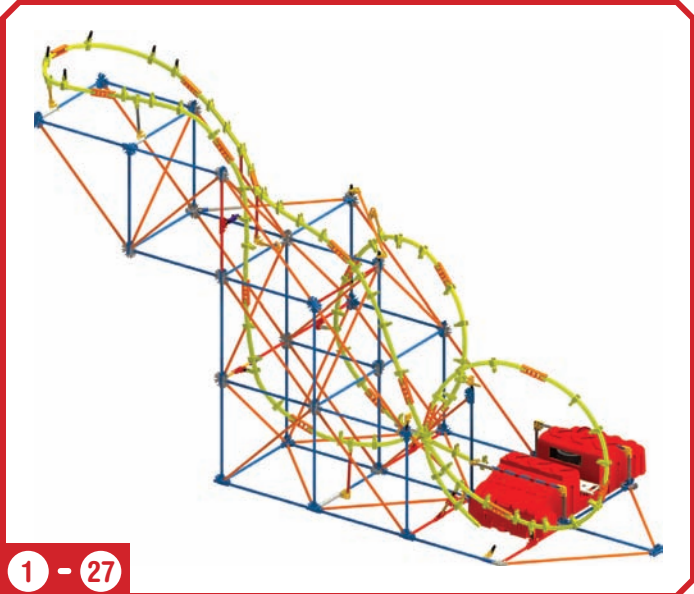
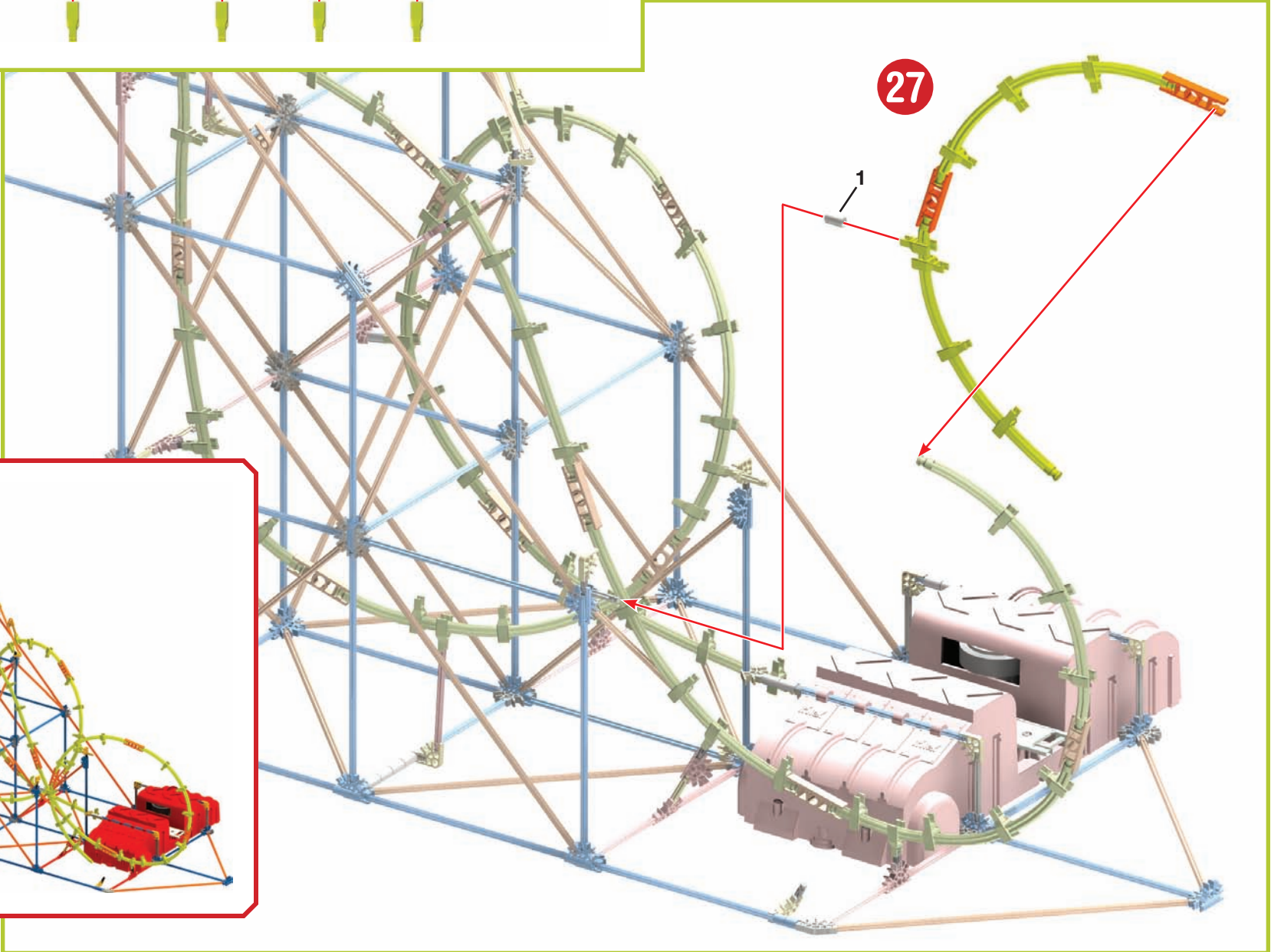

1 - 27

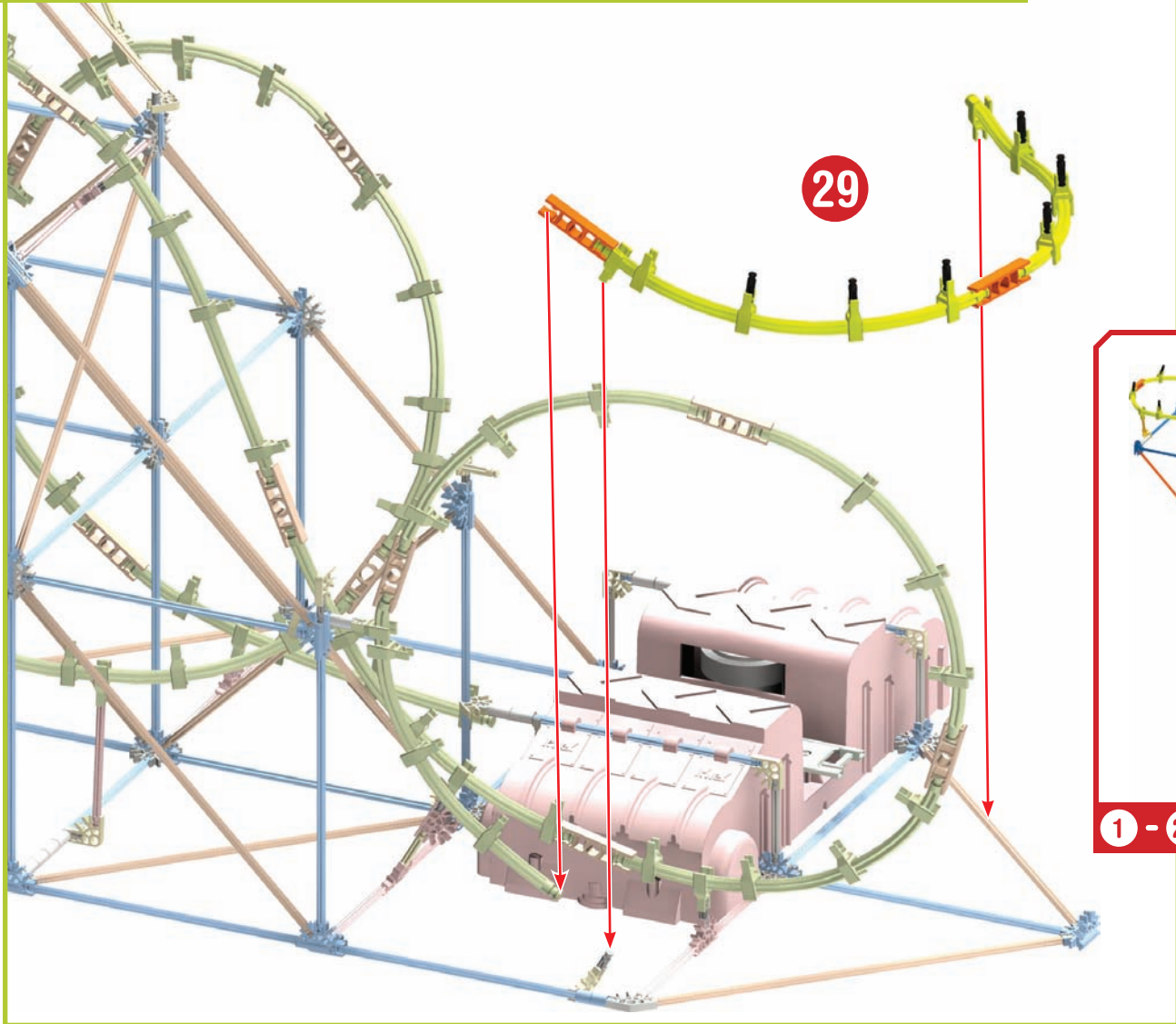
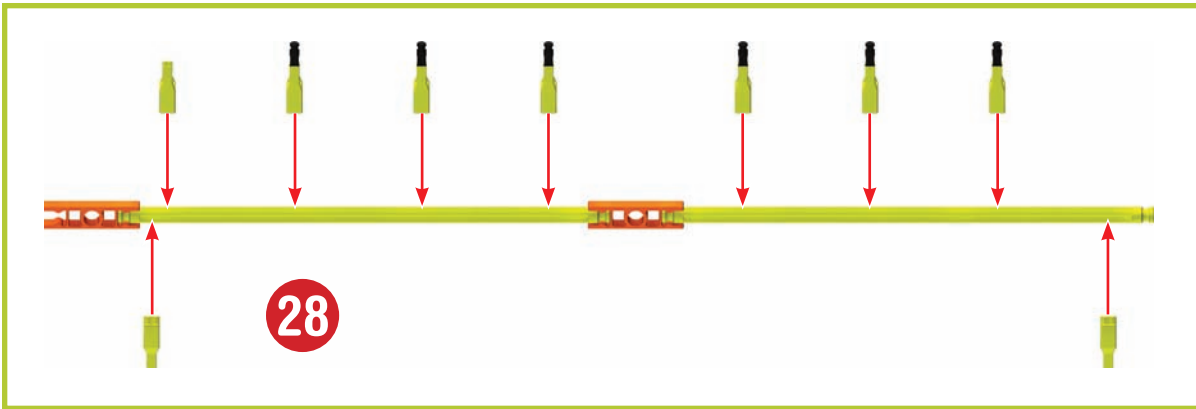

30

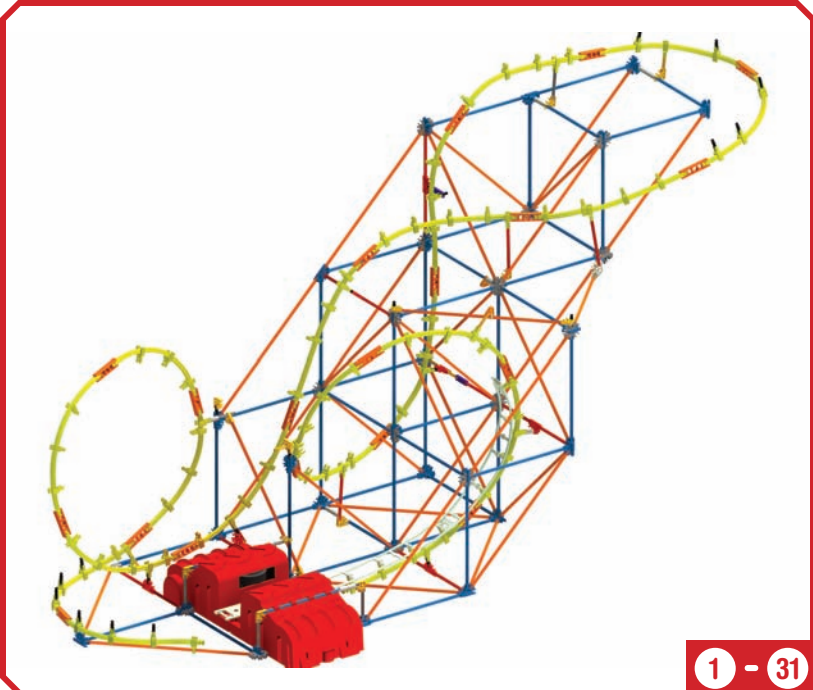
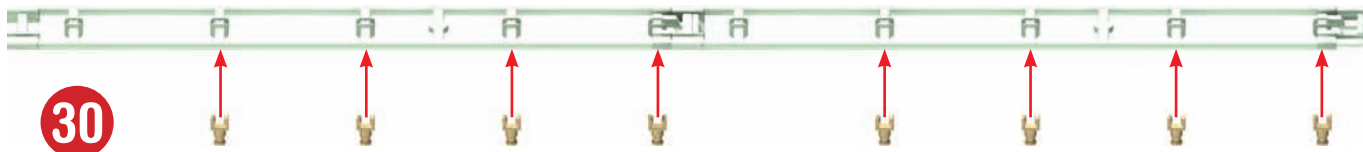

1 - 31

31

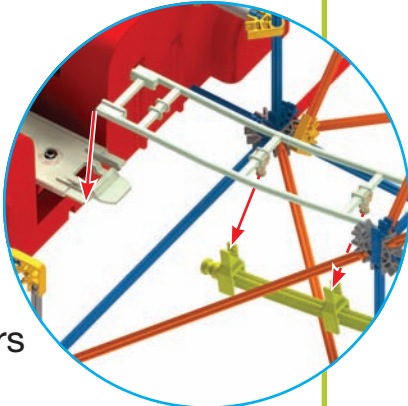
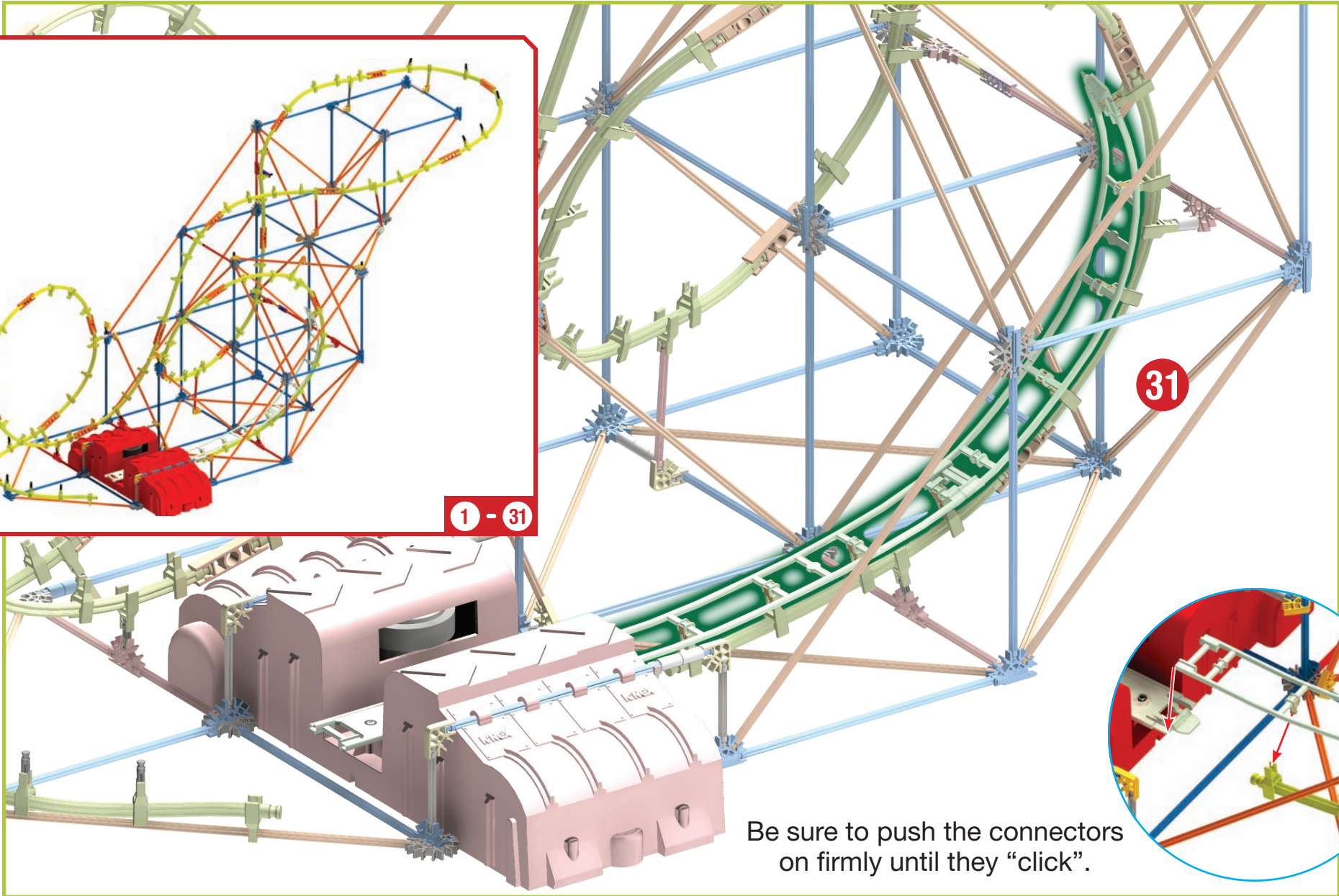

Be sure to push the connectors on firmly until they "click".

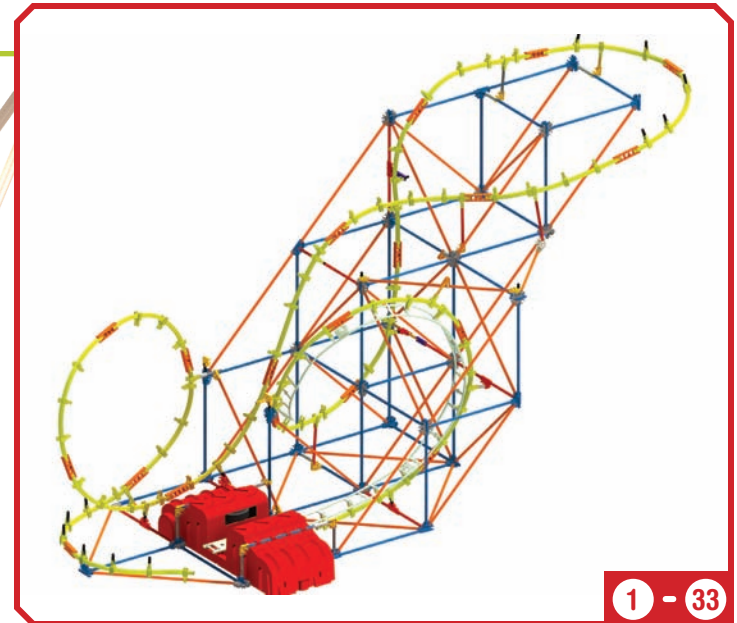
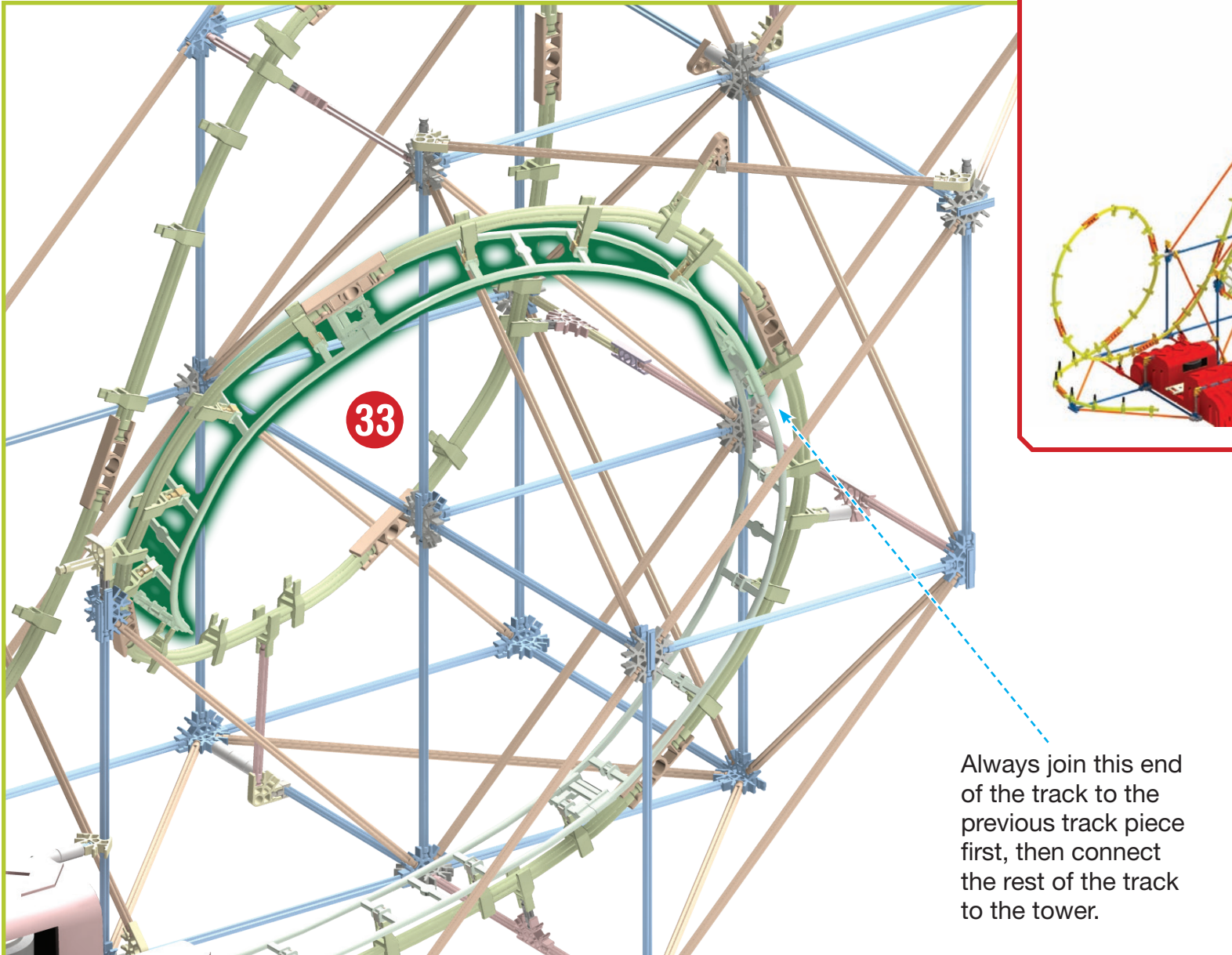
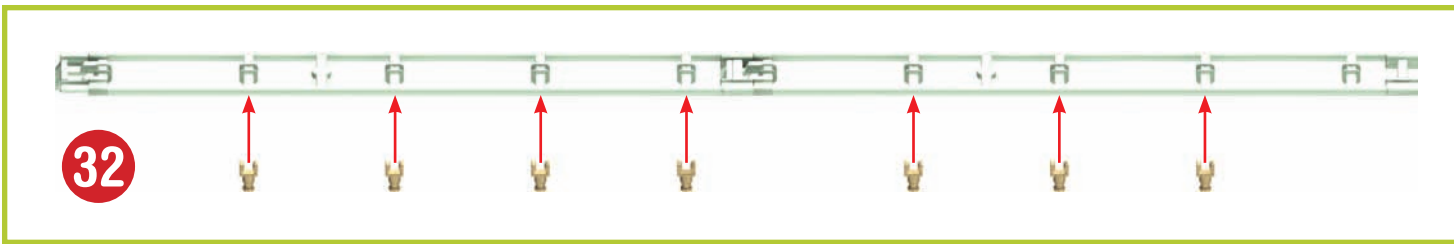

Always join this end of the track to the previous track piece first, then connect the rest of the track to the tower.

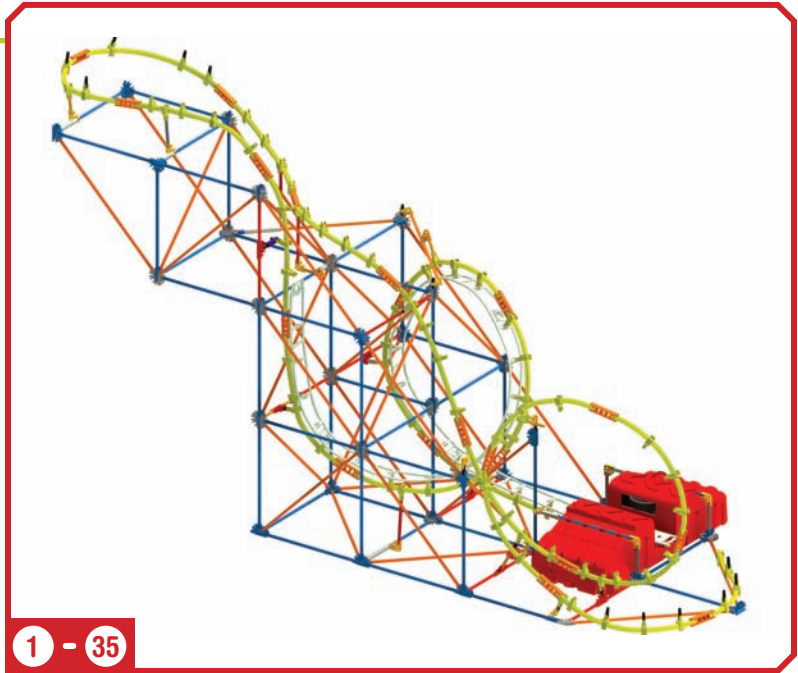
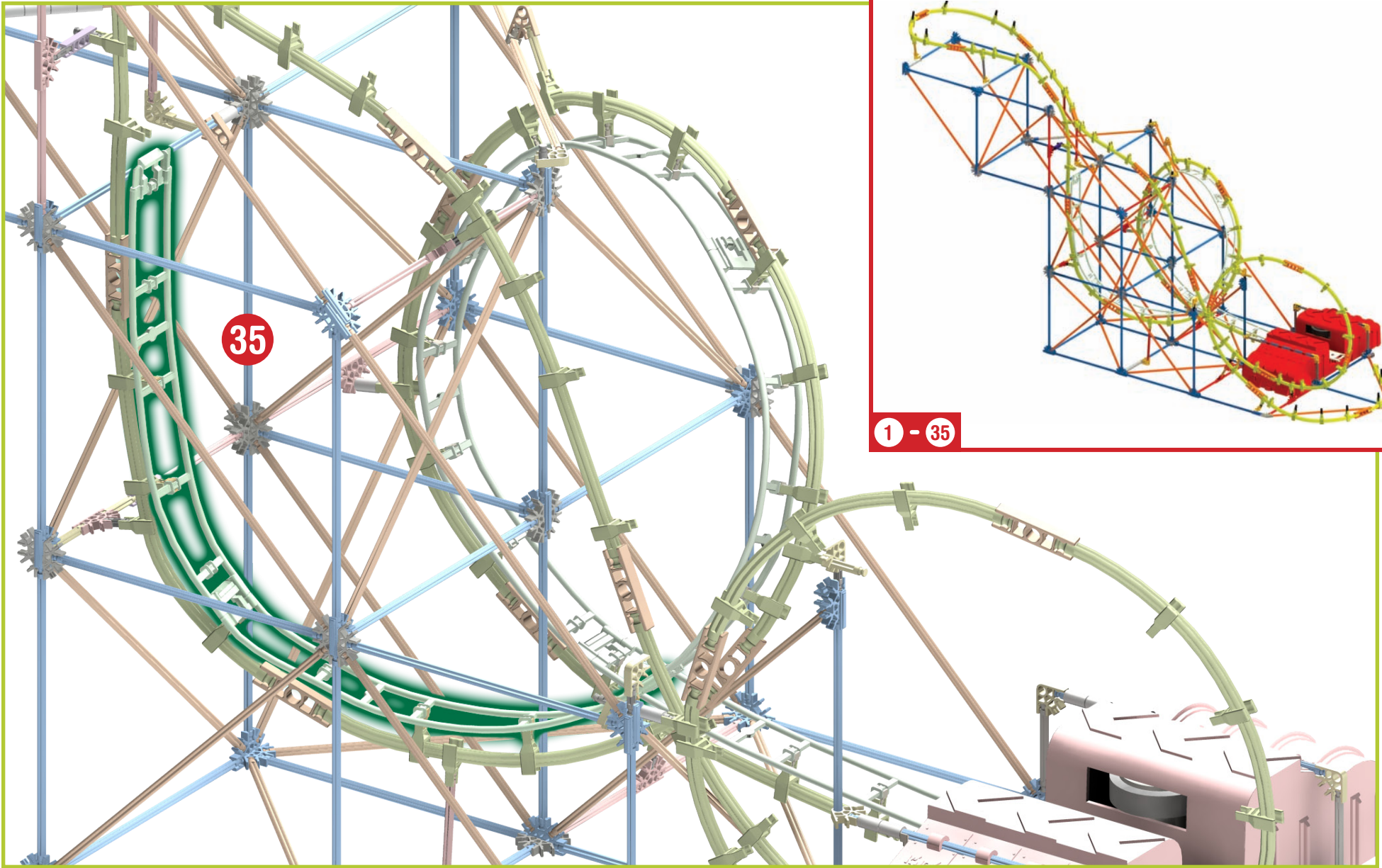
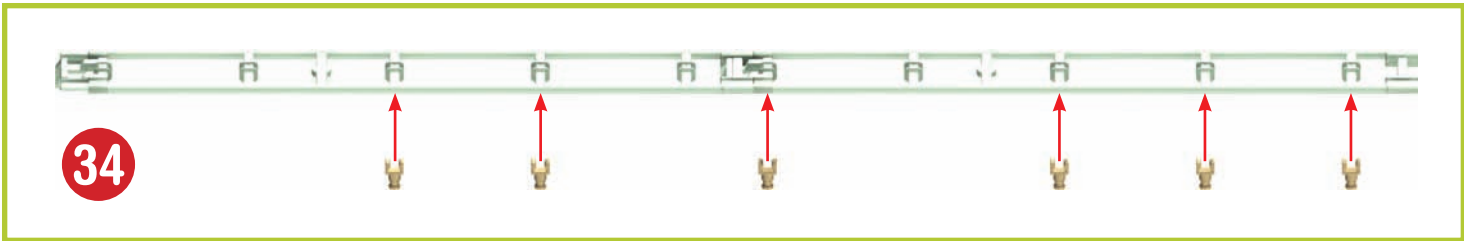

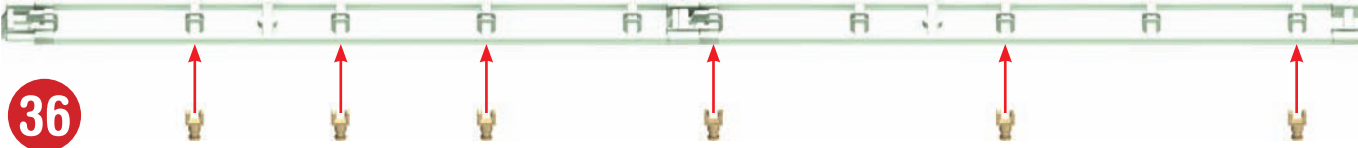

36

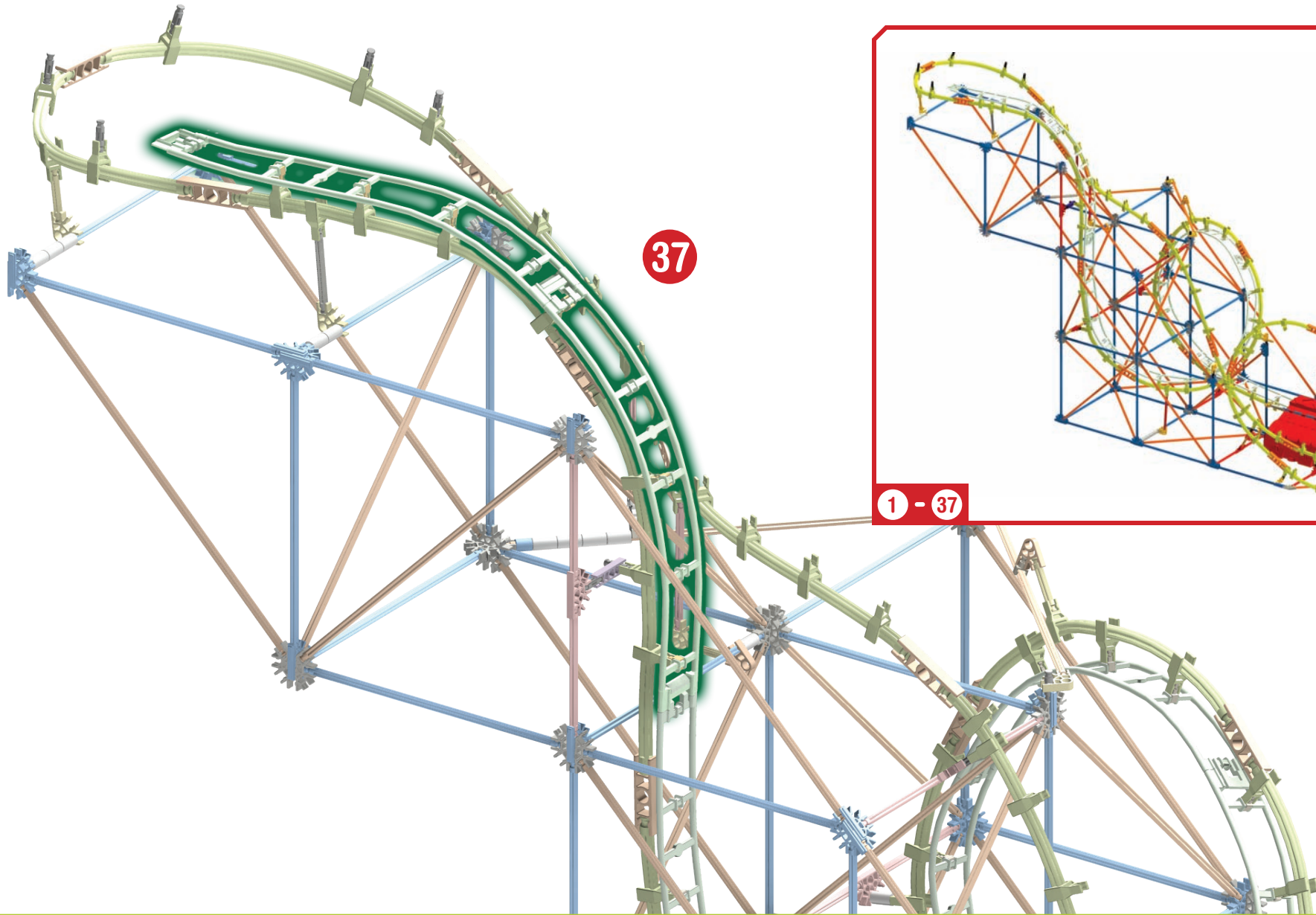

37

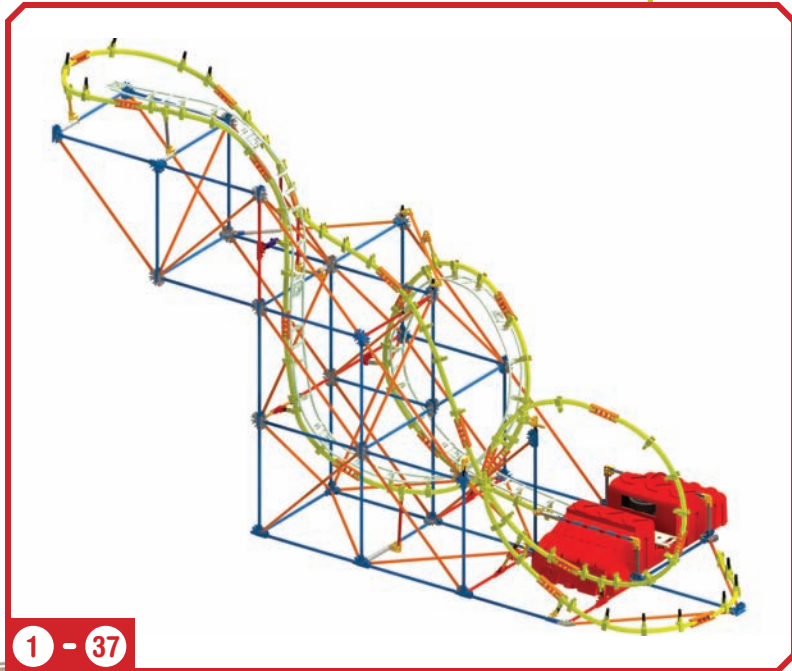

1 - 37

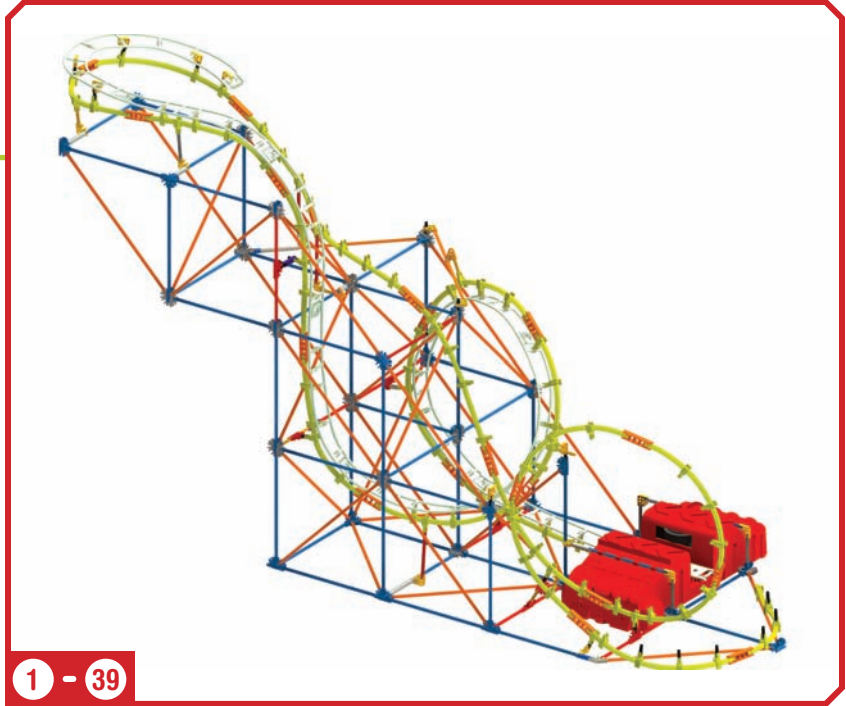
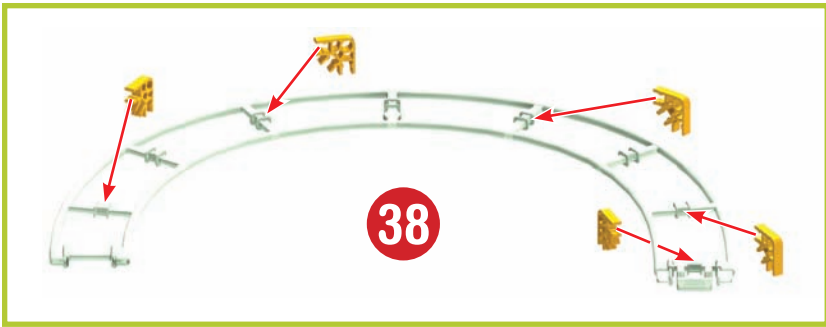

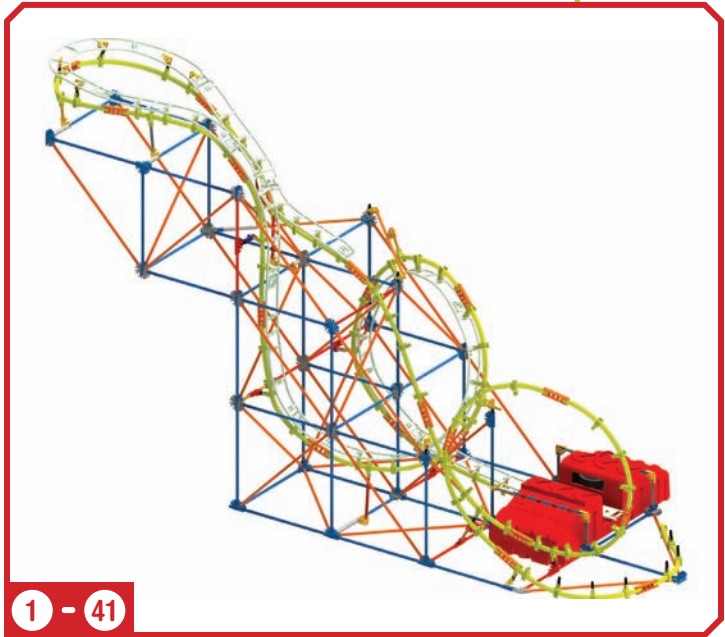
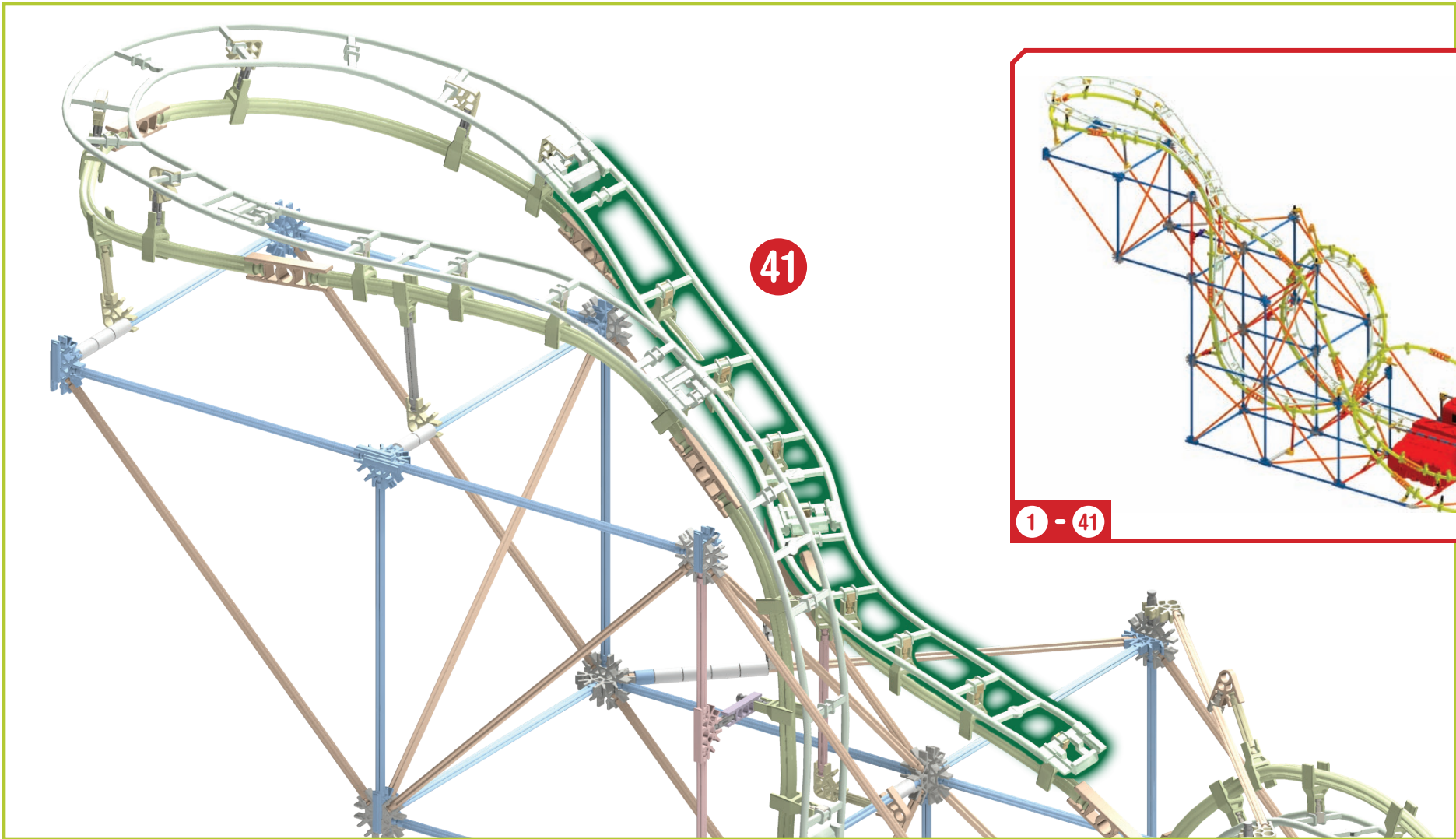
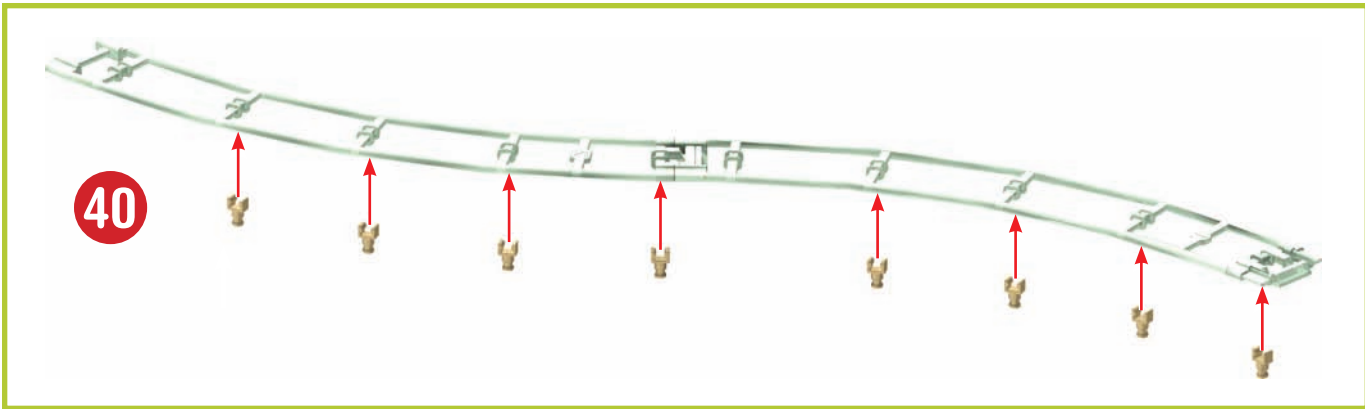

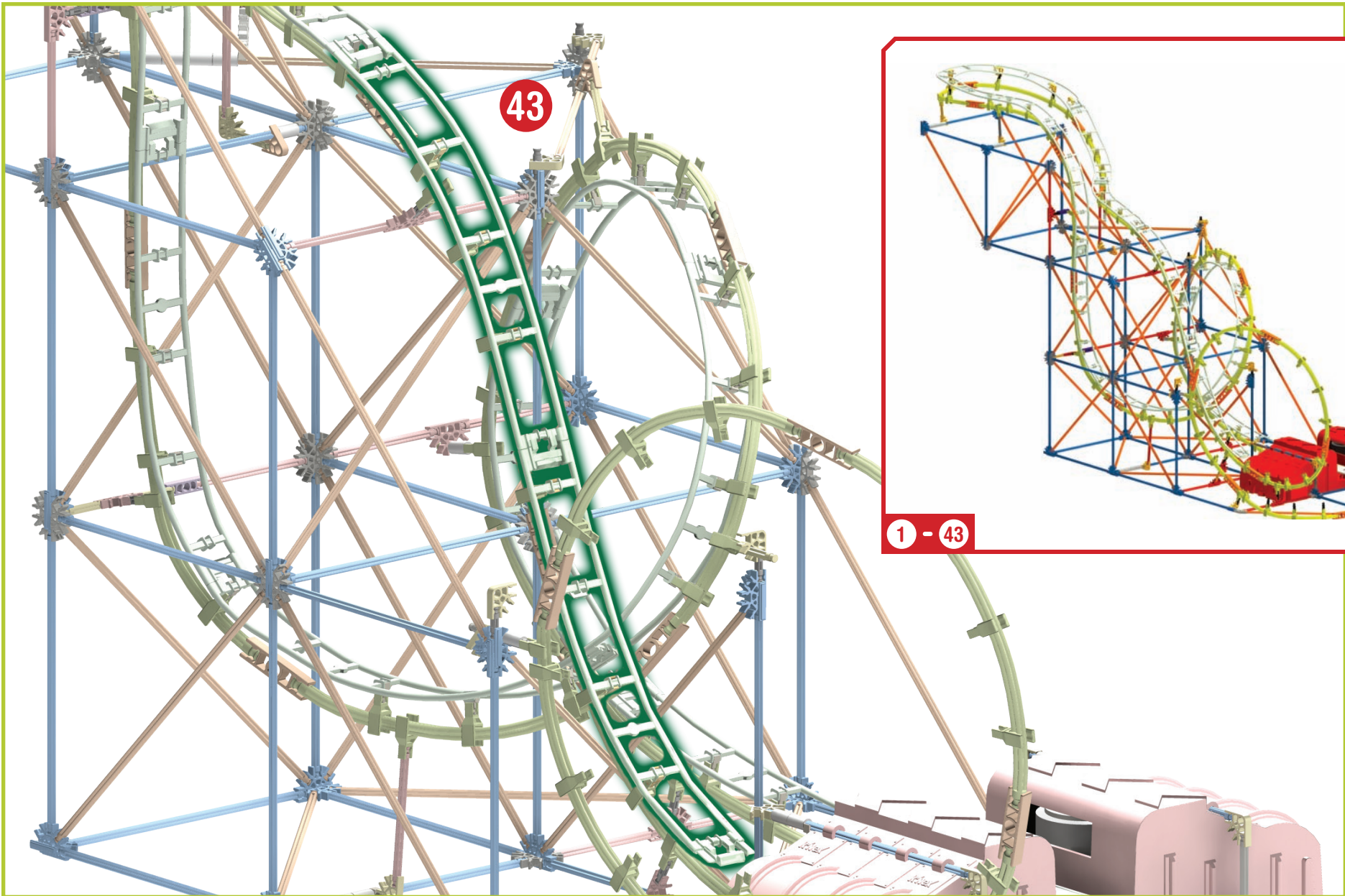
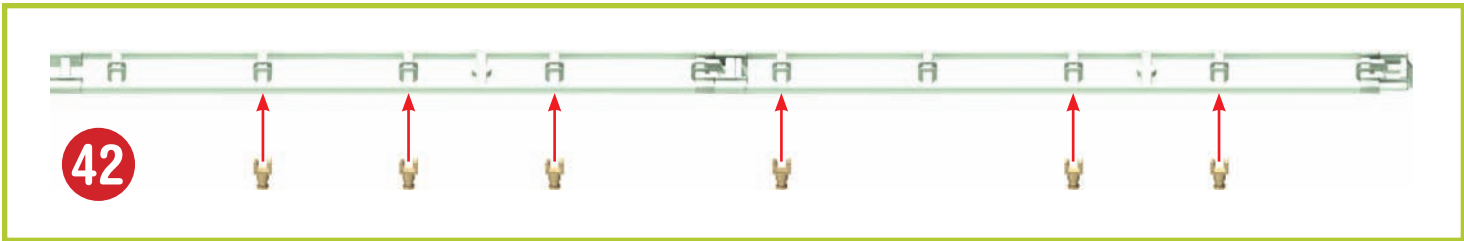

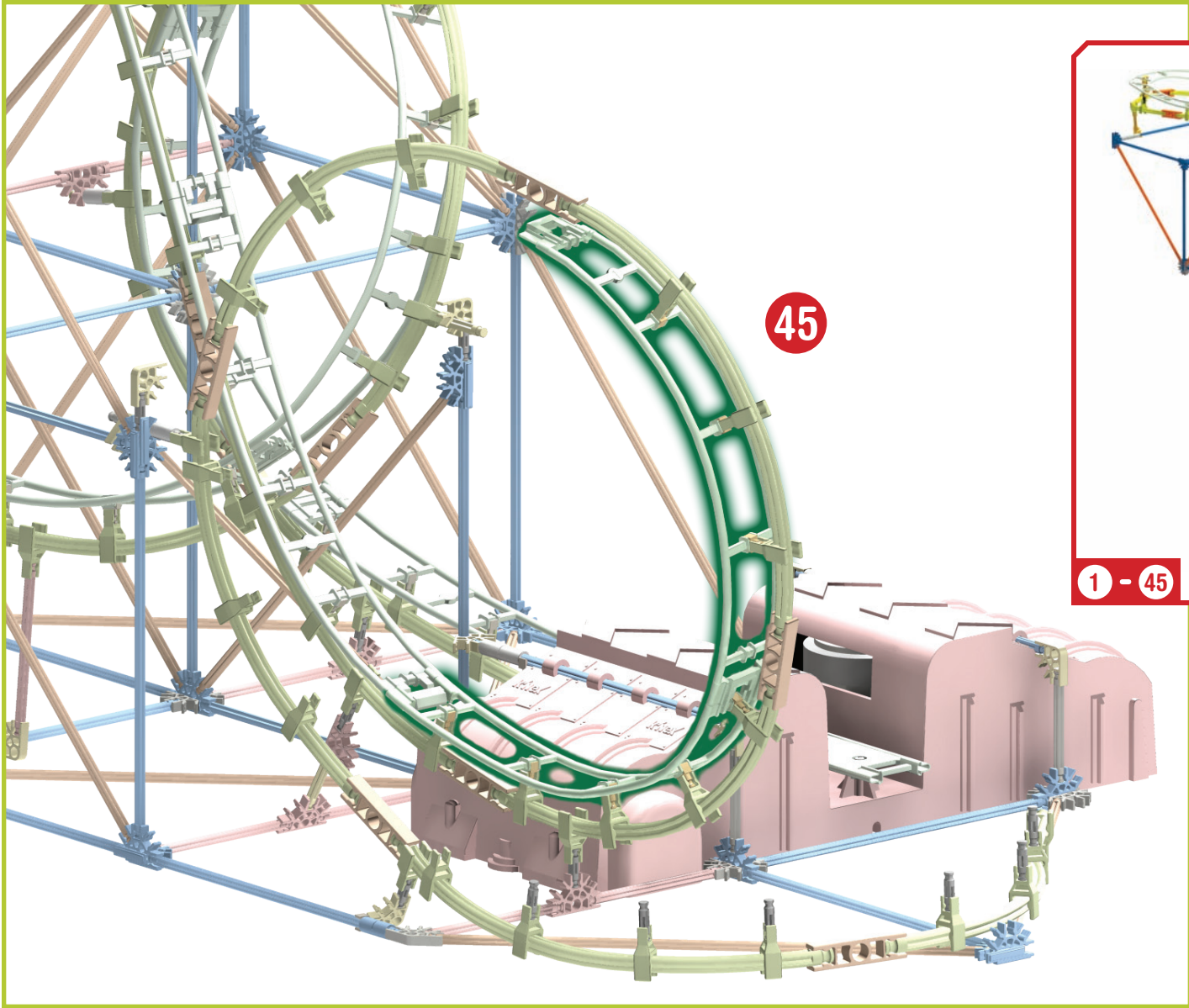
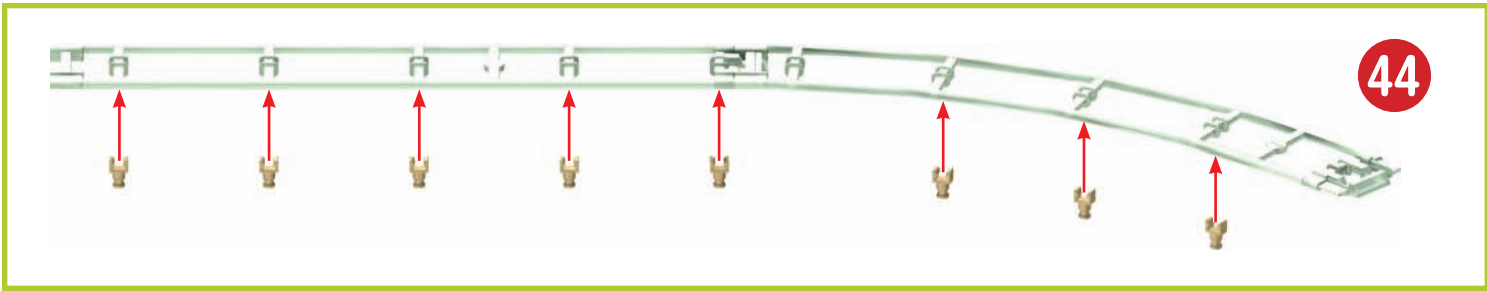

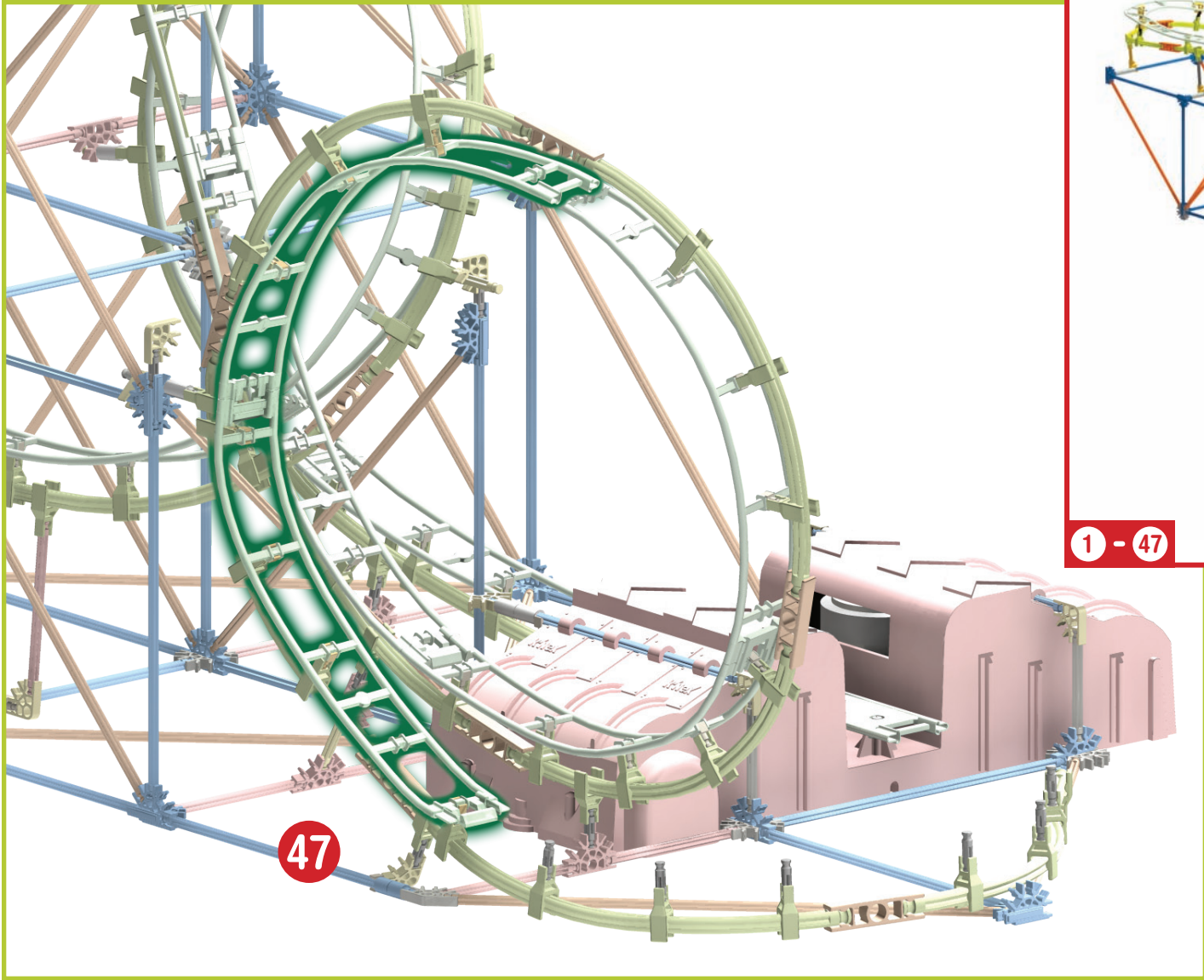
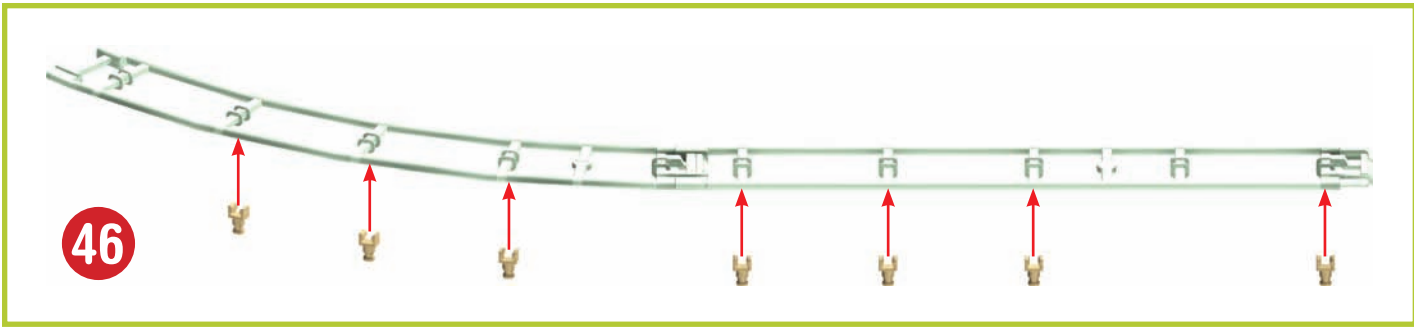

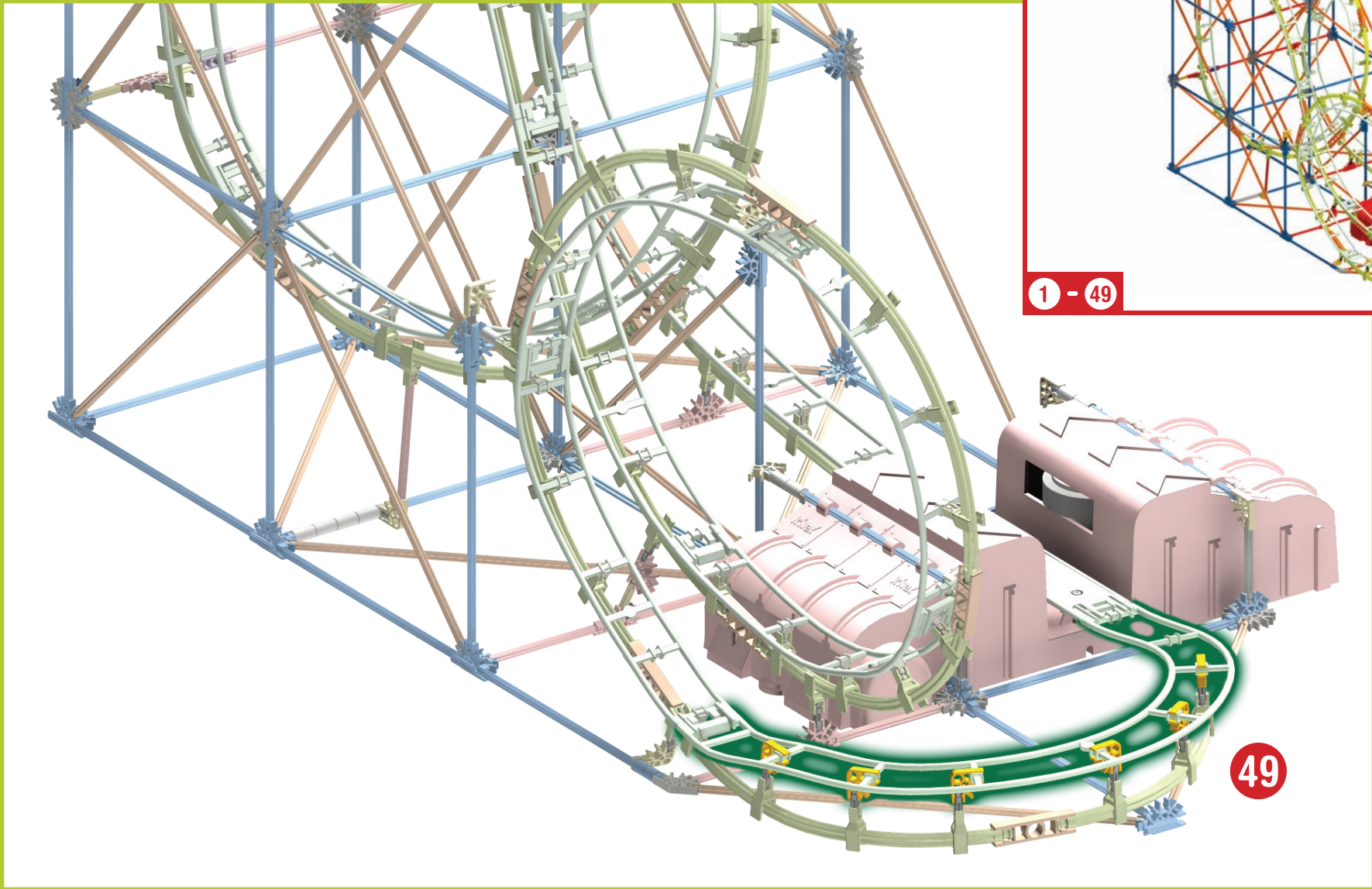
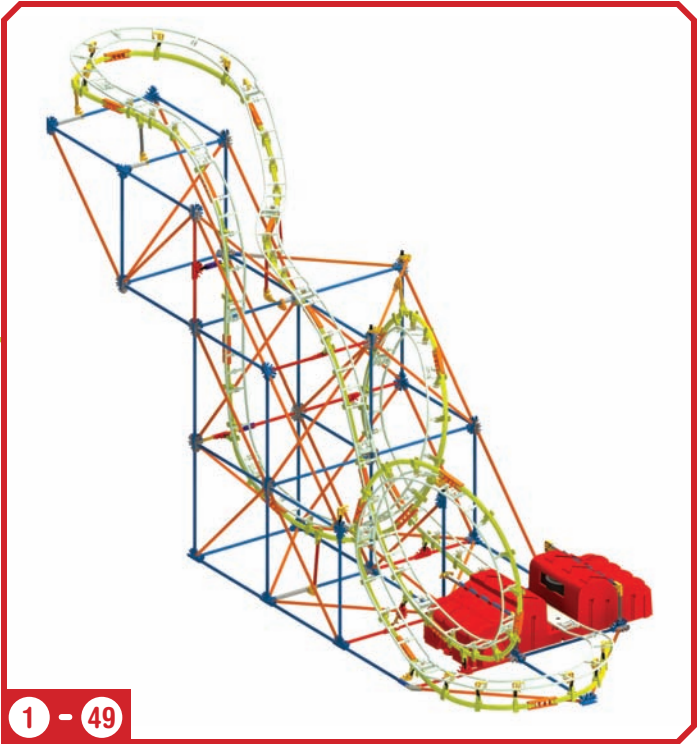
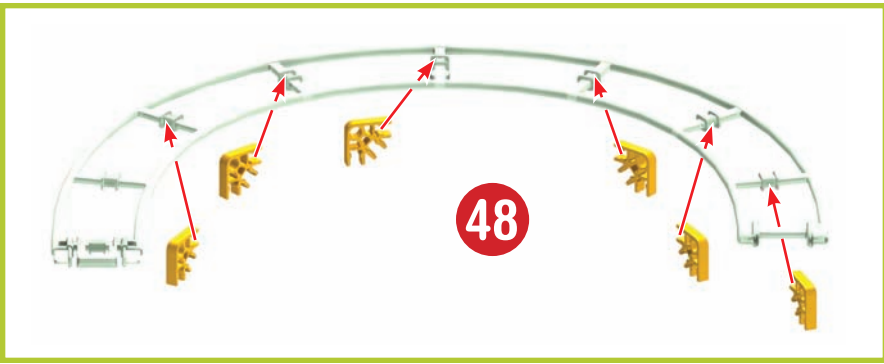

50

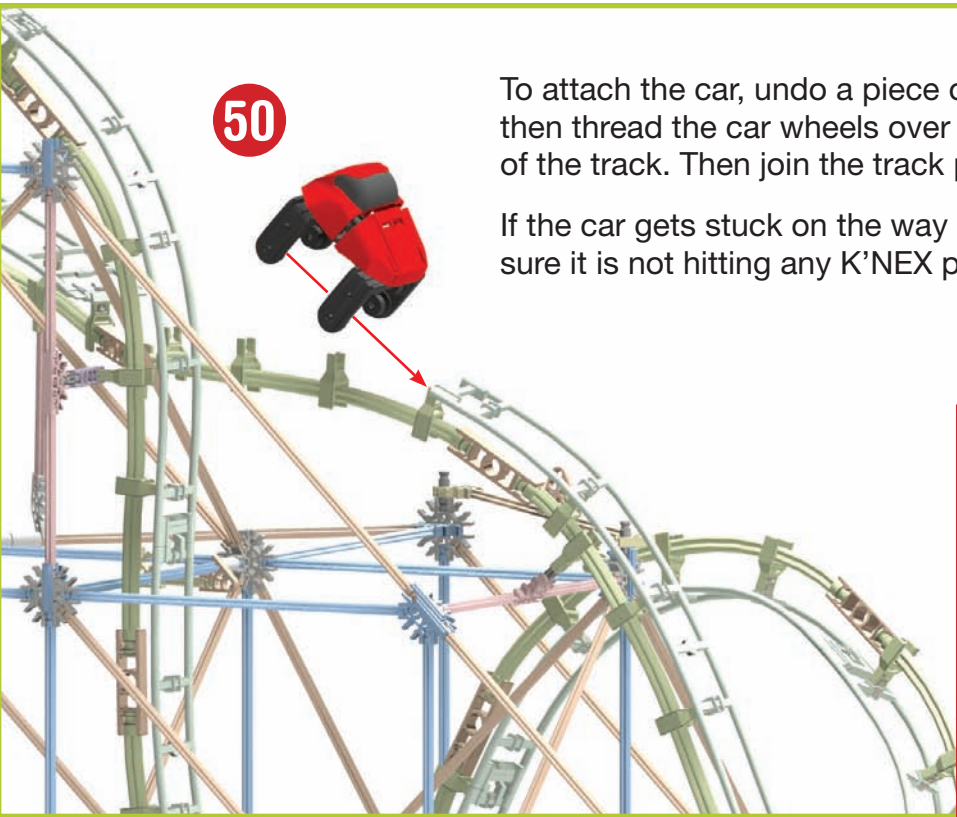

To attach the car, undo a piece of track and then thread the car wheels over the top side of the track. Then join the track pieces together.

If the car gets stuck on the way down, make sure it is not hitting any K'NEX parts.

SONIC BOOM

