

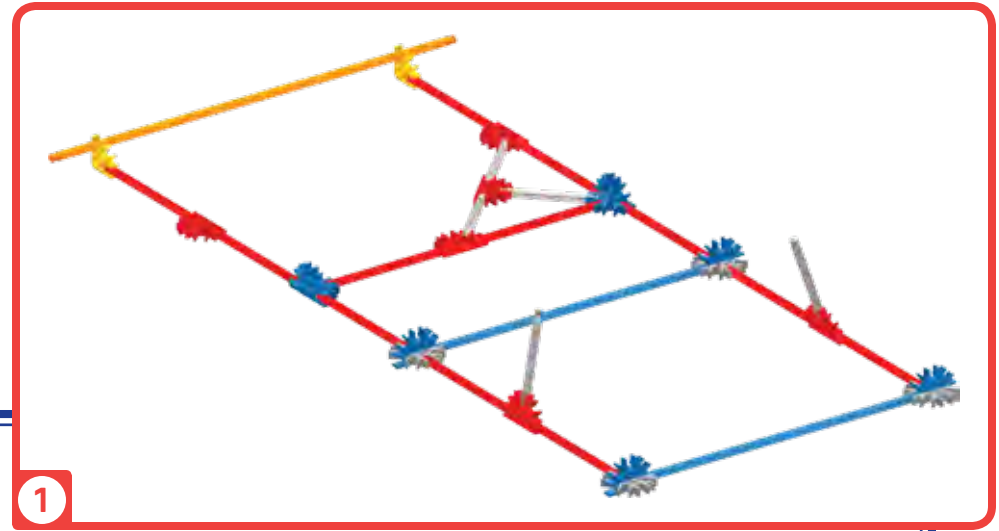

**k'nex**

# SUPER CYBORG

Additional Build



1

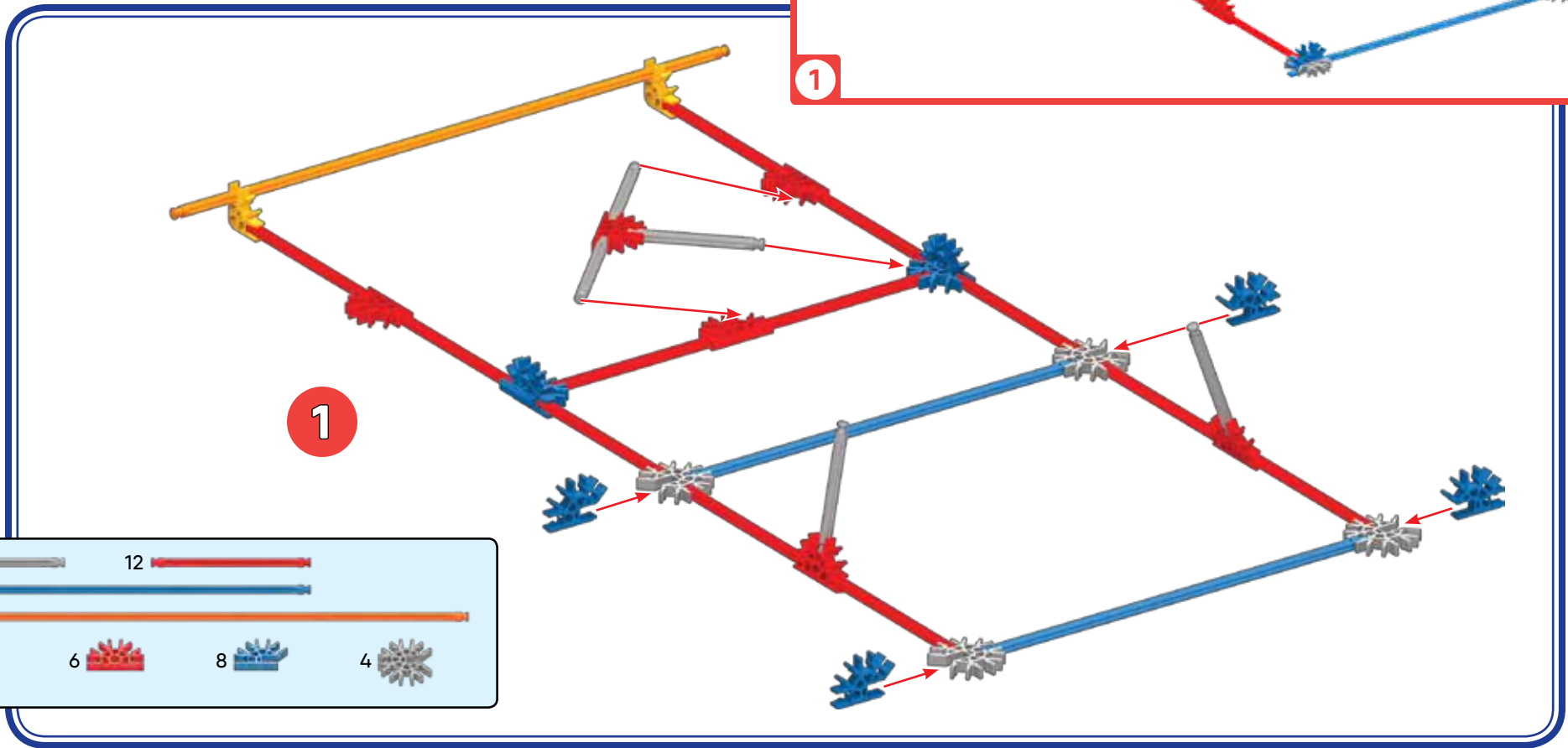

1

5		12	
2			
1			
2		6	
		8	
		4	

- |   |  |   |  |
|---|--|---|--|
| 1 |  | 1 |  |
| 3 |  | 6 |  |
| 3 |  | 7 |  |
|   |  | 1 |  |
|   |  | 2 |  |
|   |  | 3 |  |

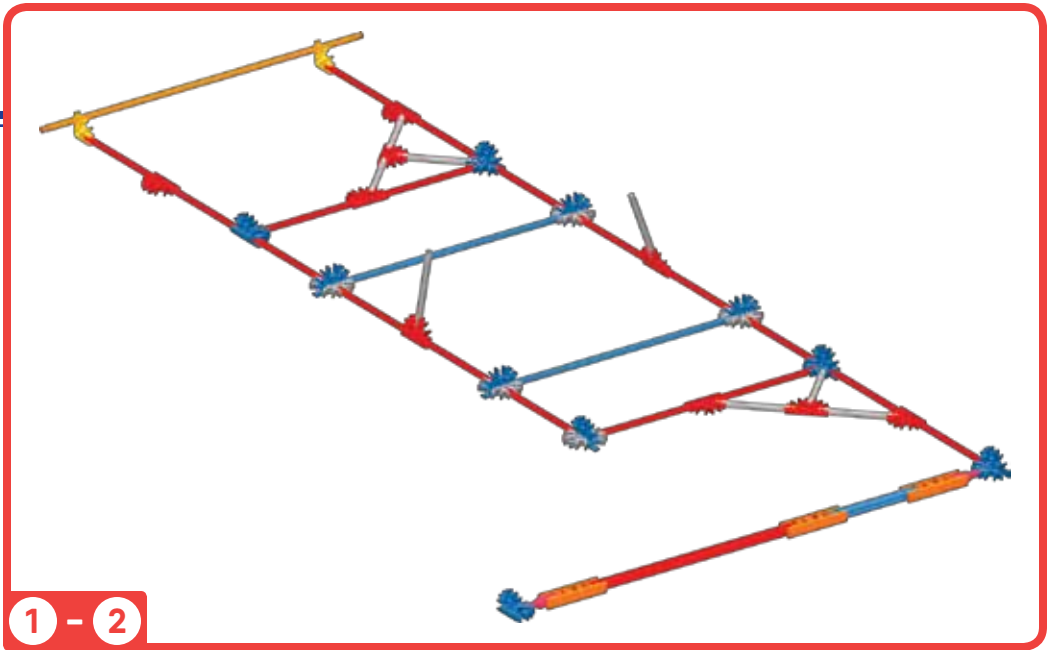
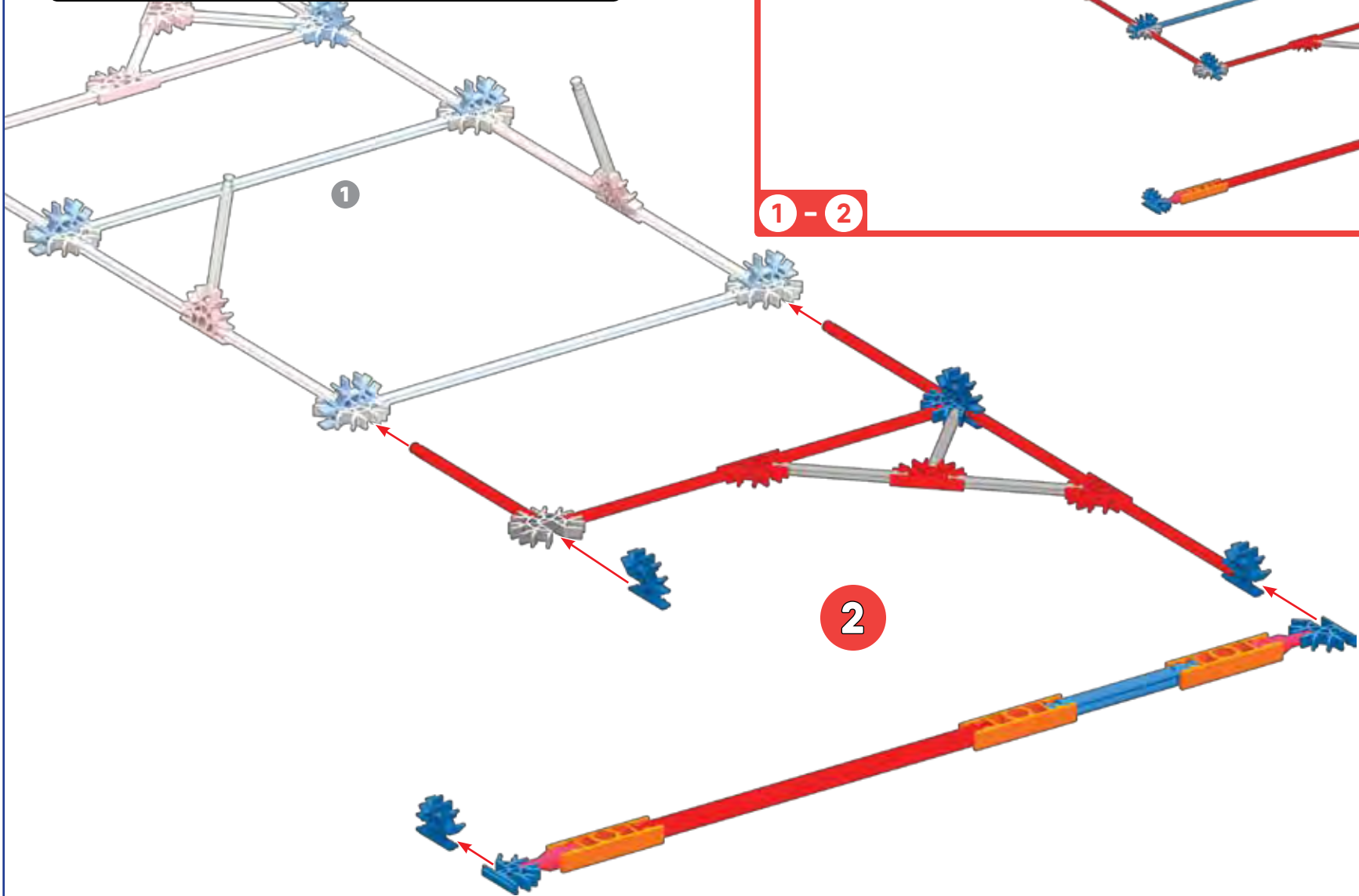

3

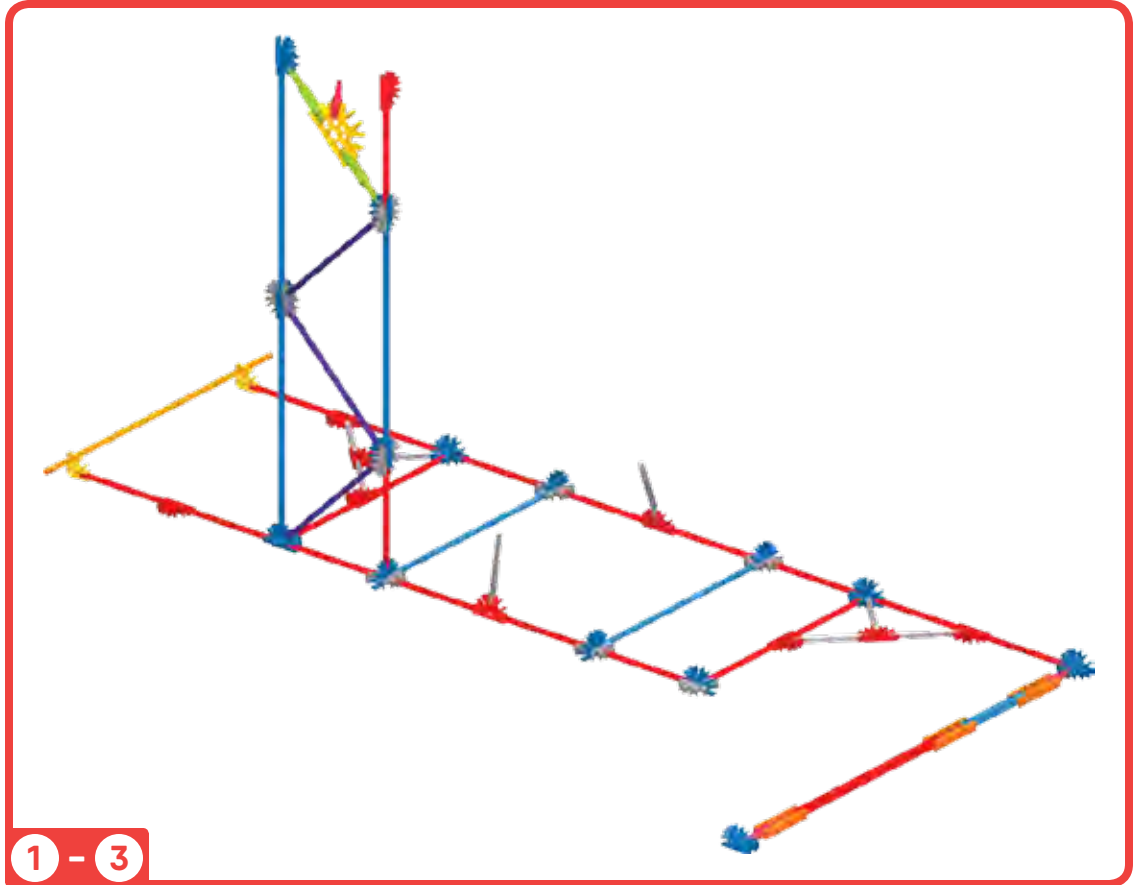

1 - 3

1 - 2

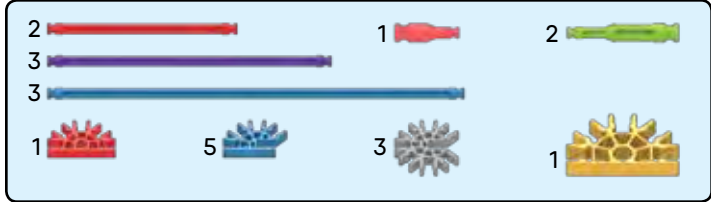
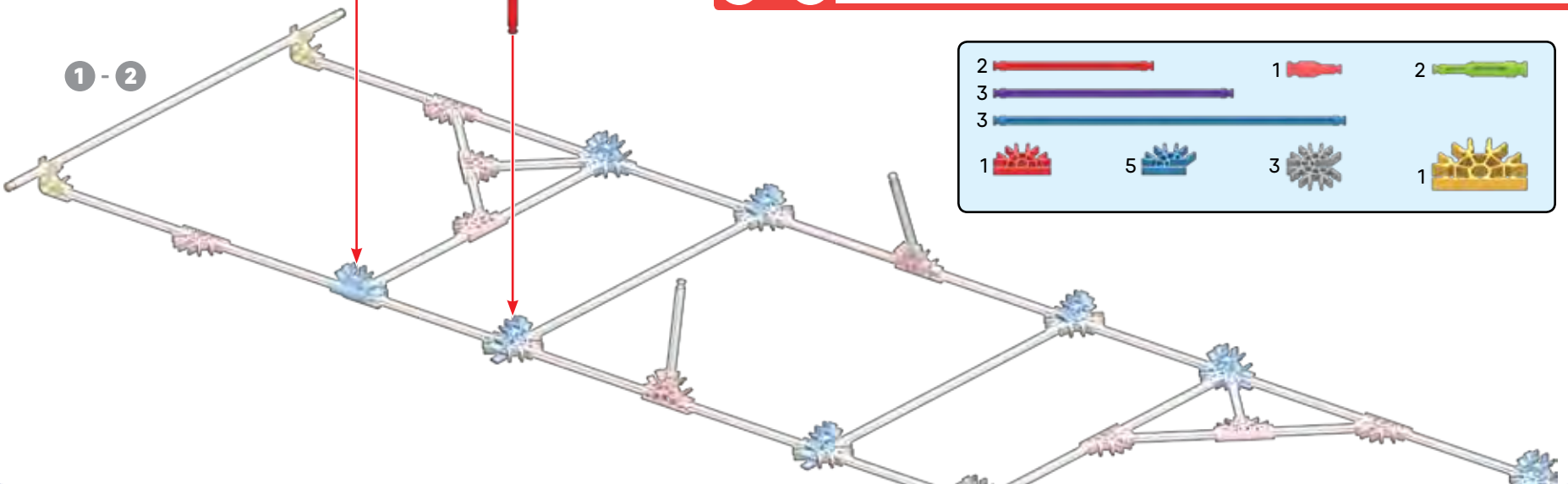

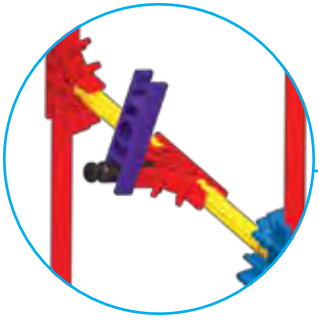

4

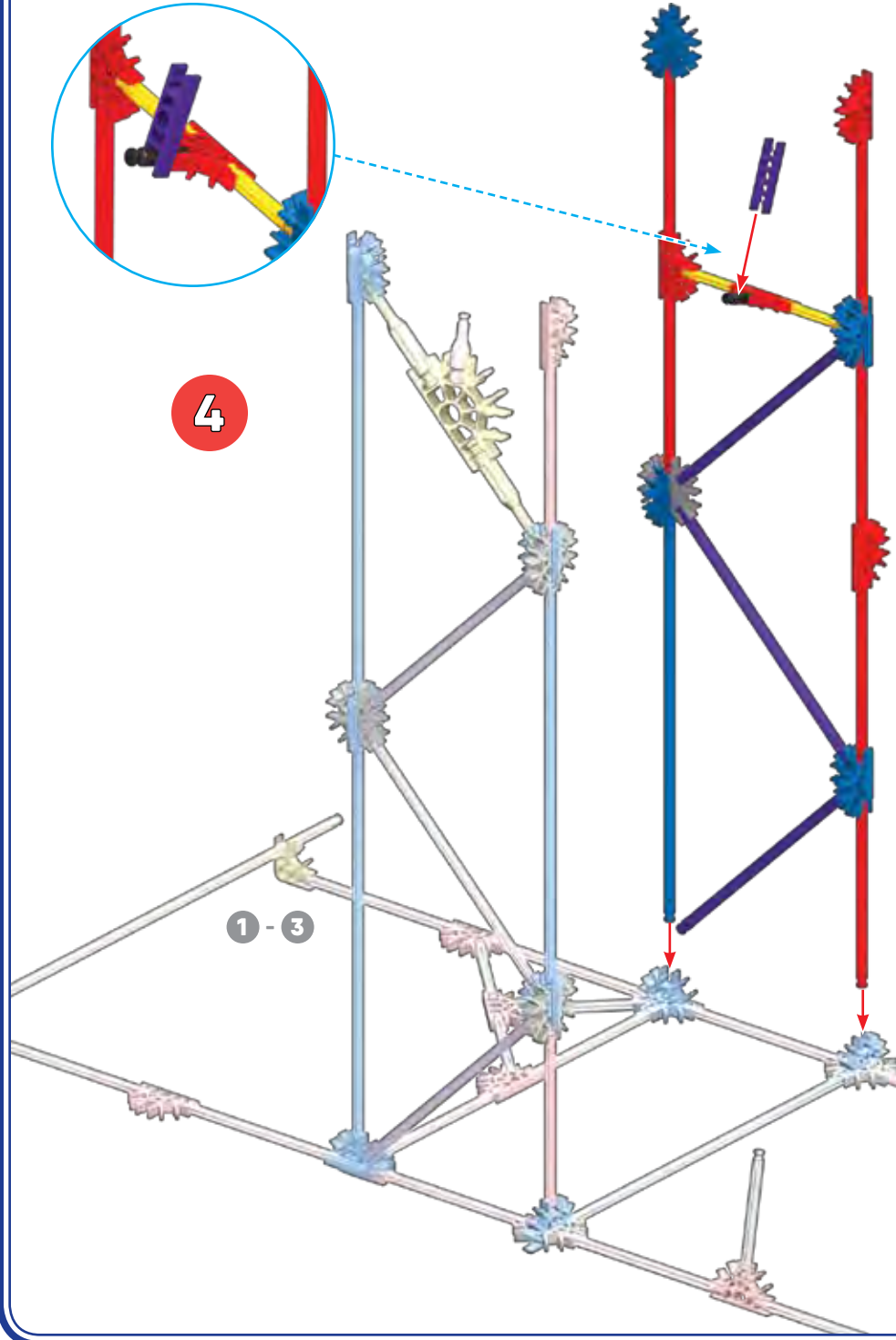

1 - 3

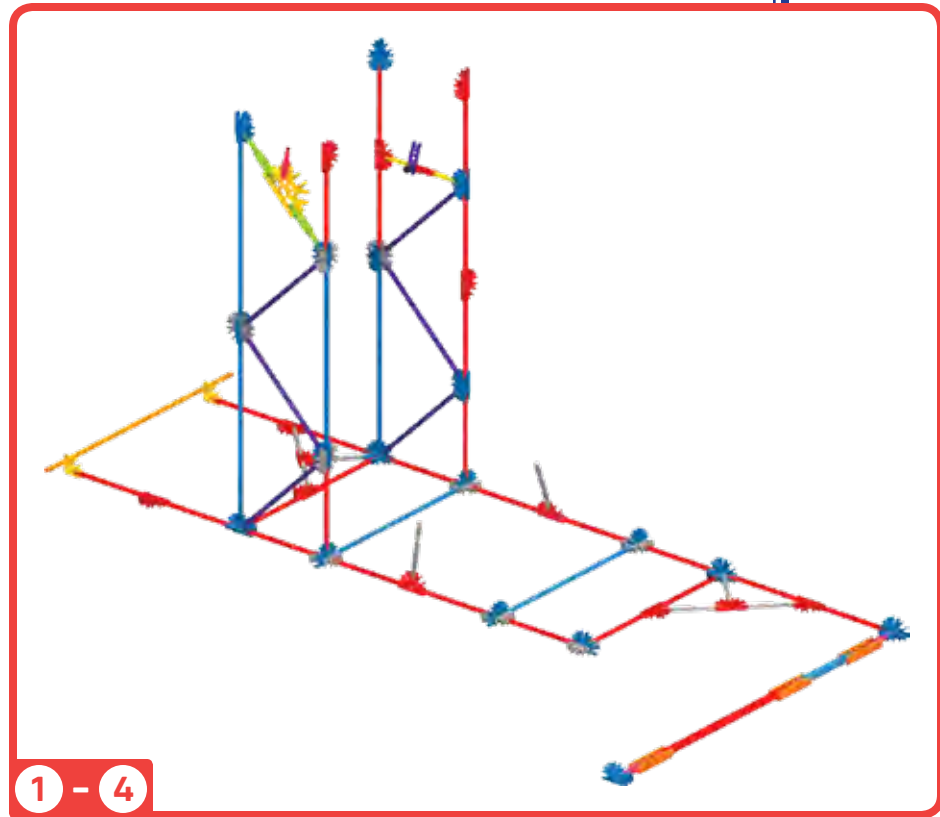

1 - 4

- |   |   |   |   |
|---|---|---|---|
| 1 | 2 | 1 | 7 |
| 6 |   | 4 | 1 |
| 3 |   |   |   |
| 1 |   |   |   |

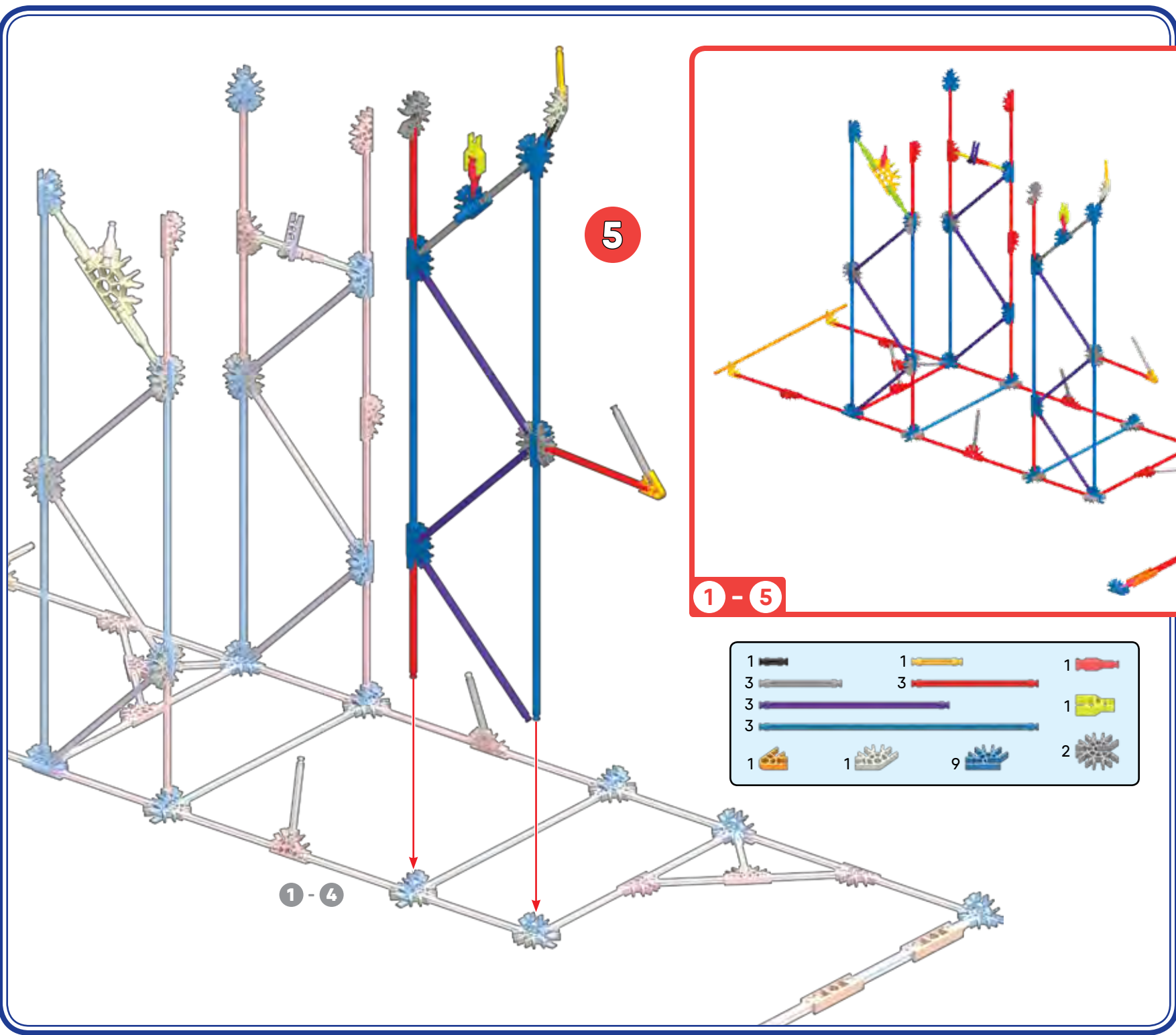

5

1 - 4

1 - 5

- |   |   |   |
|---|---|---|
| 1 | 1 | 1 |
| 3 | 3 |   |
| 3 |   | 1 |
| 3 |   | 1 |
| 1 | 1 | 9 |
|   |   | 2 |

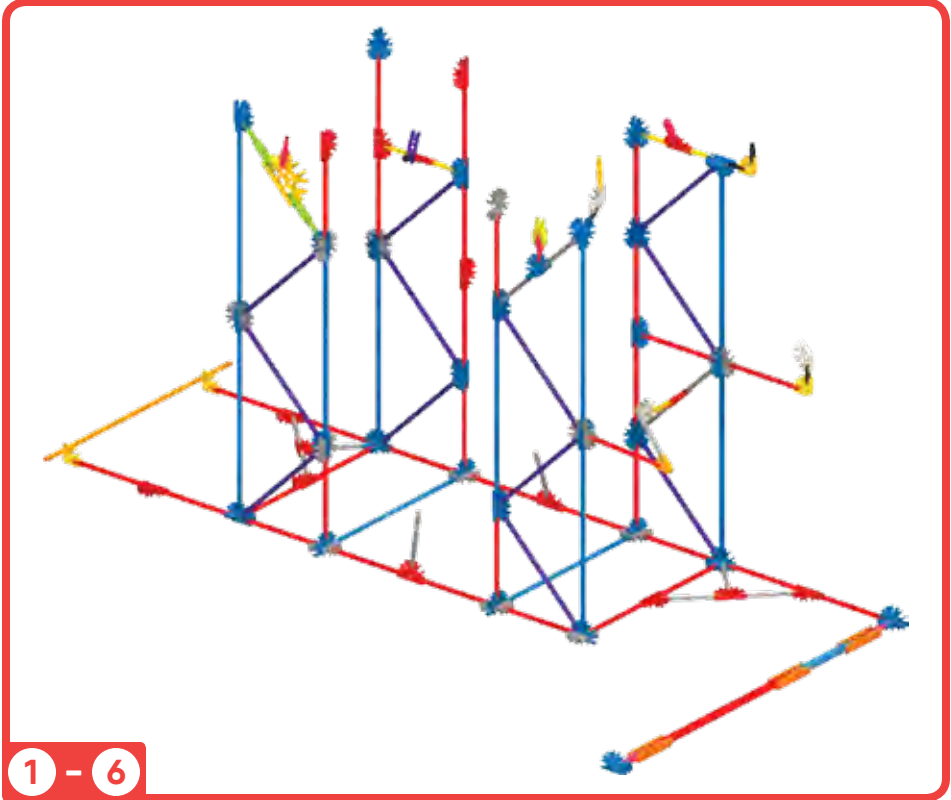
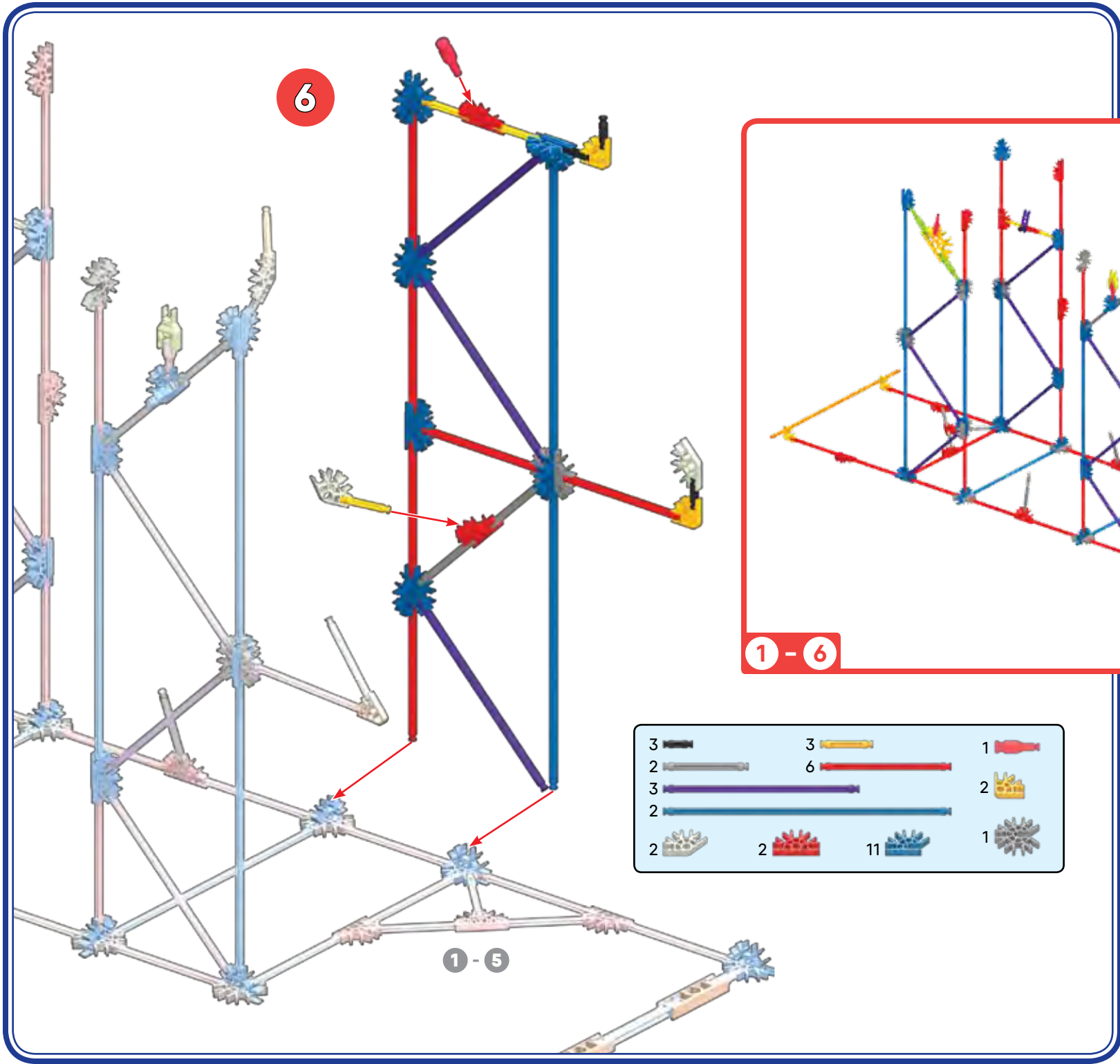

8

7

1 - 6

1 - 7

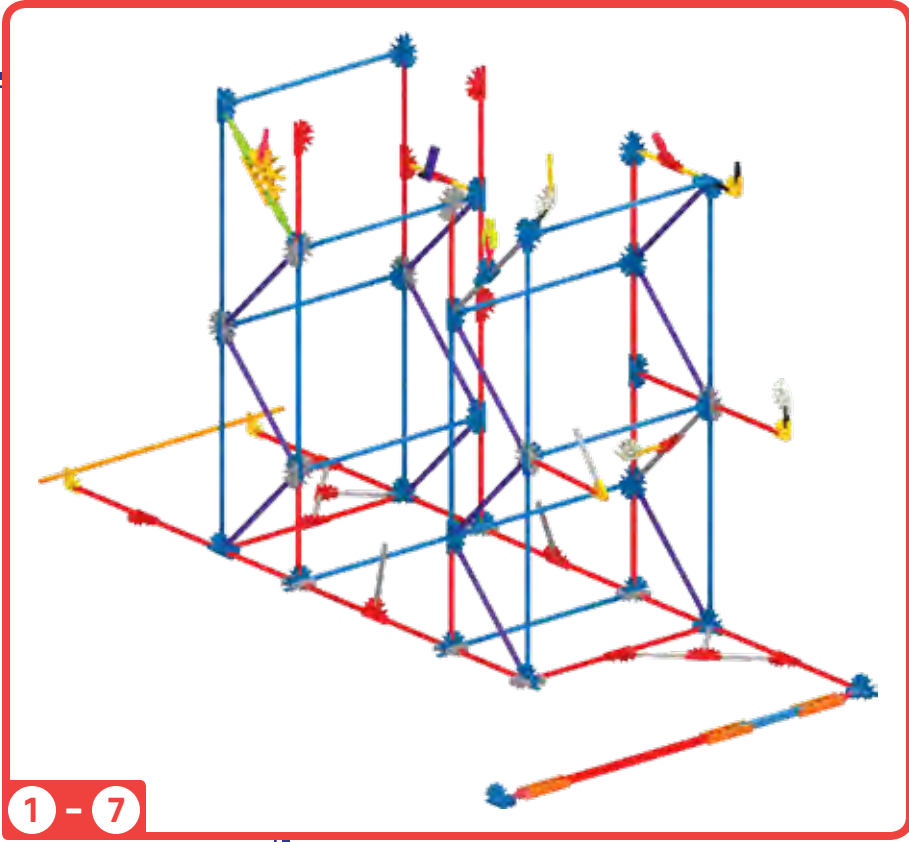
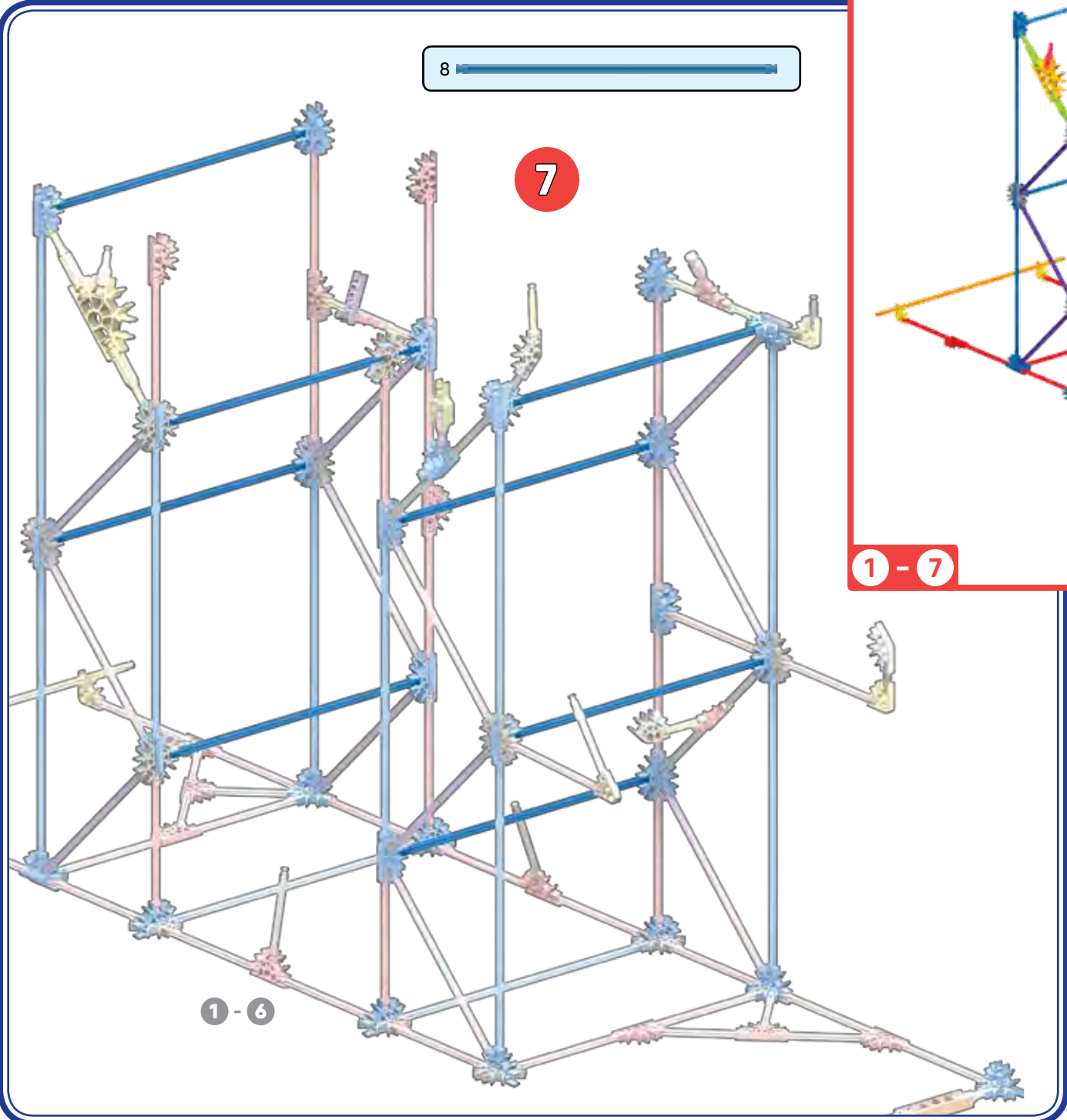

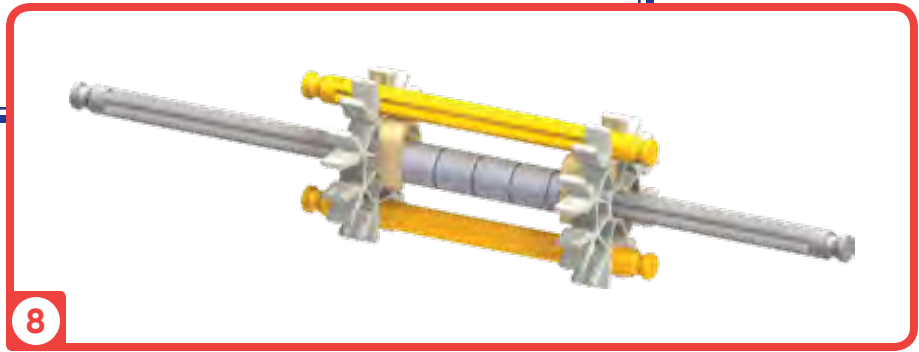
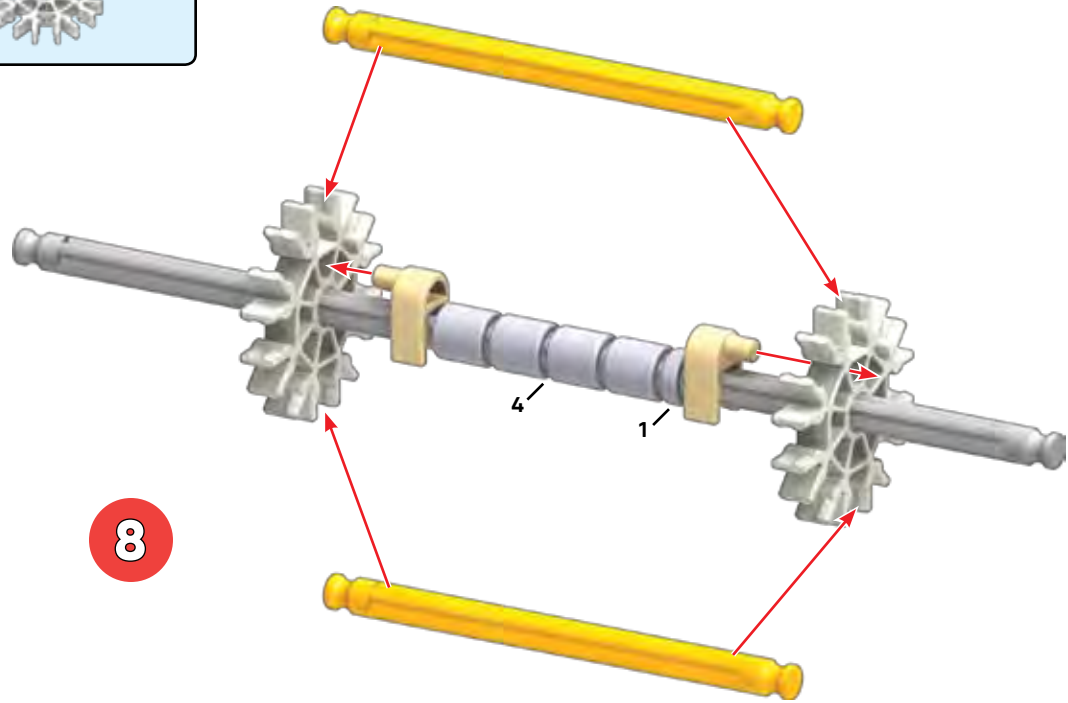
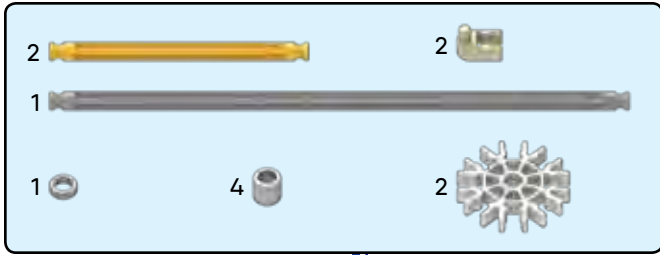

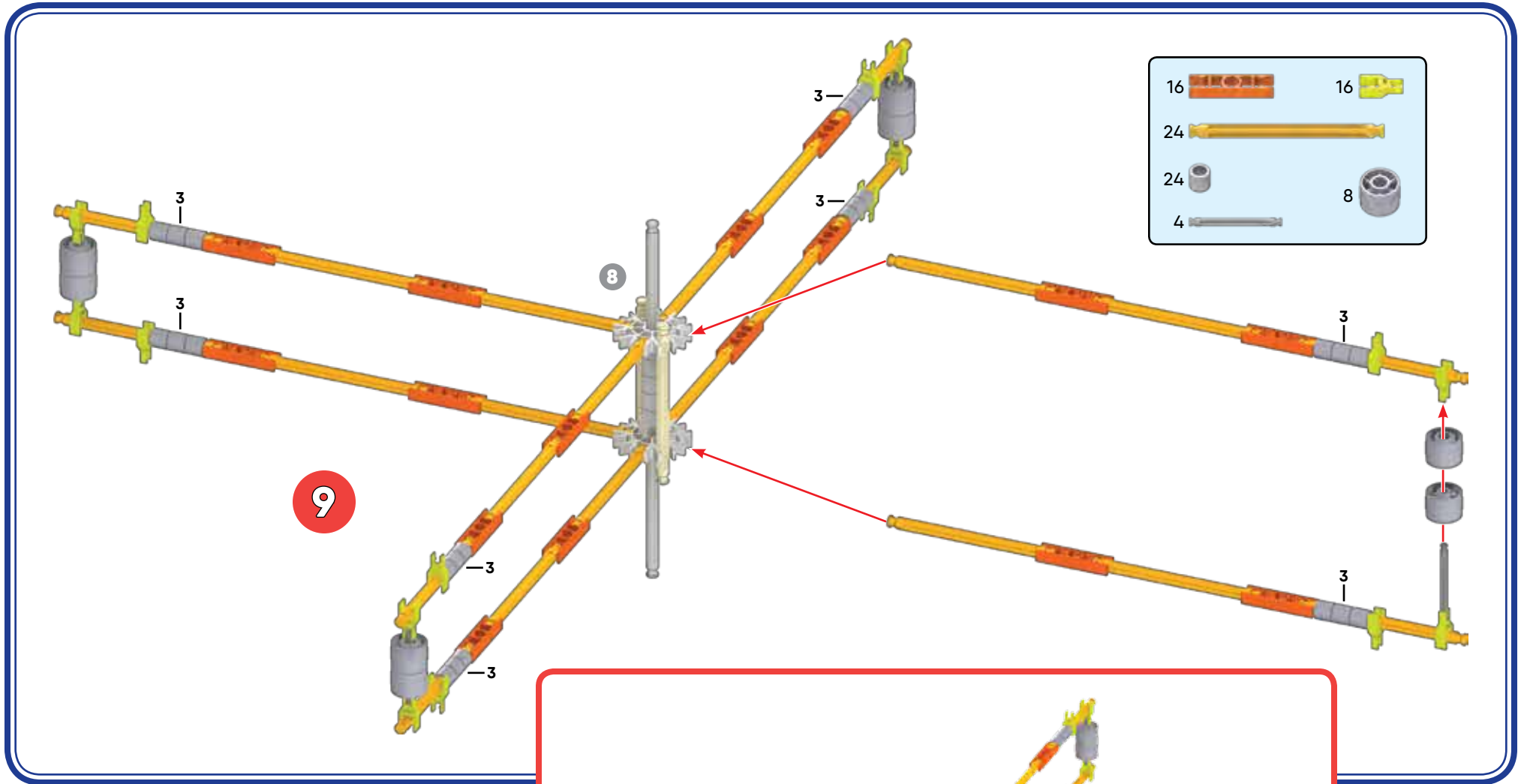

- |    |  |    |  |
|----|--|----|--|
| 16 |  | 16 |  |
| 24 |  |    |  |
| 24 |  | 8  |  |
| 4  |  |    |  |

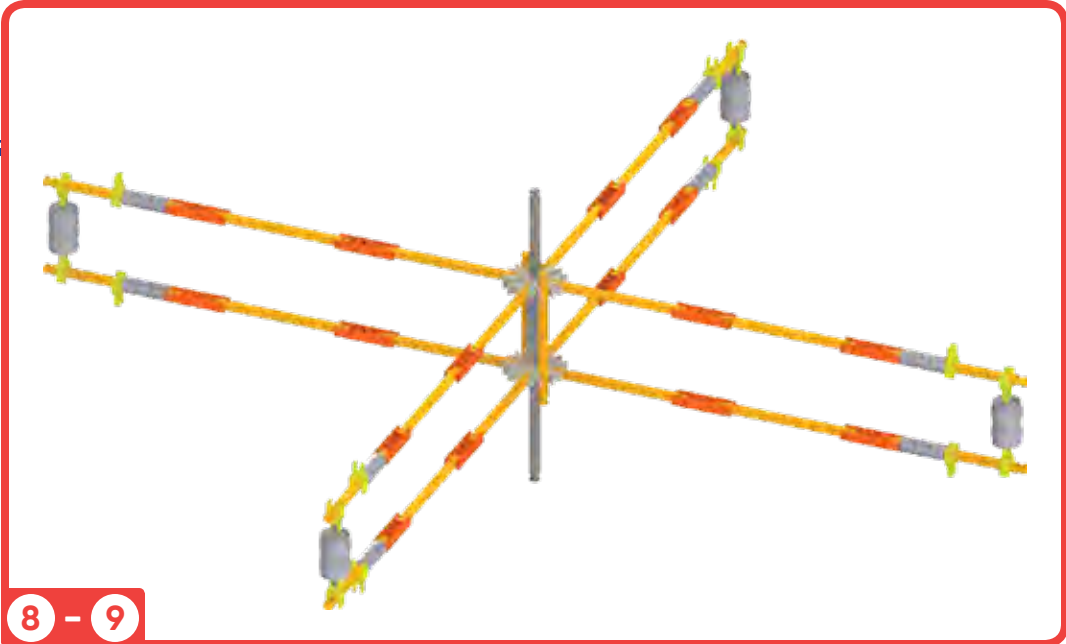

8 - 9

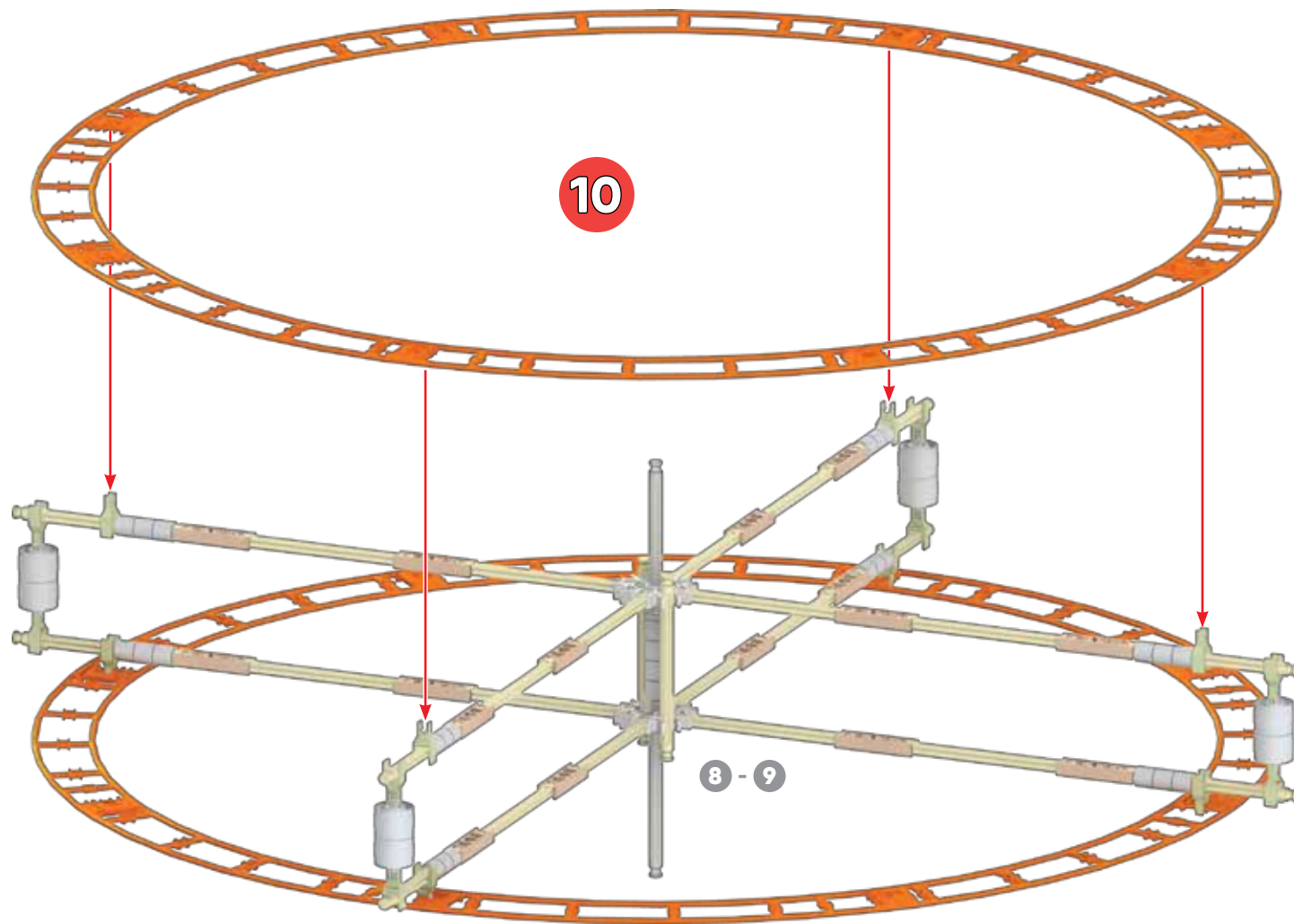
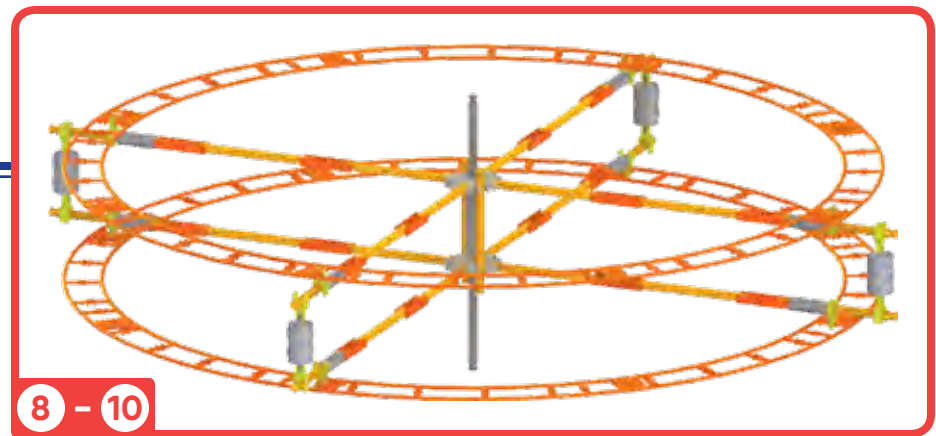
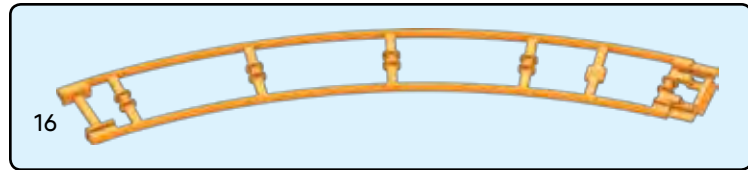

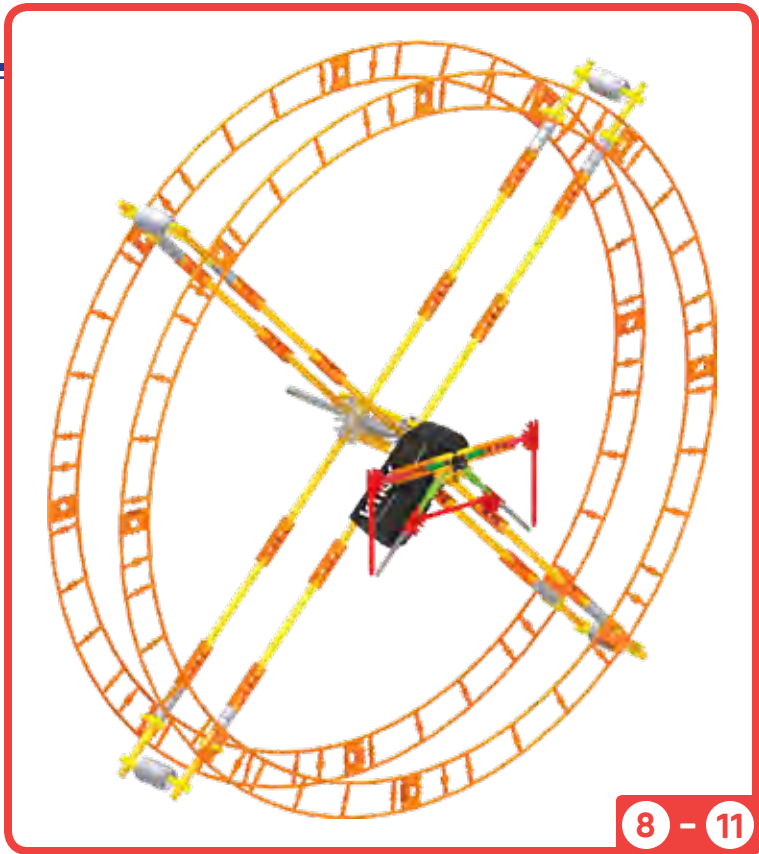
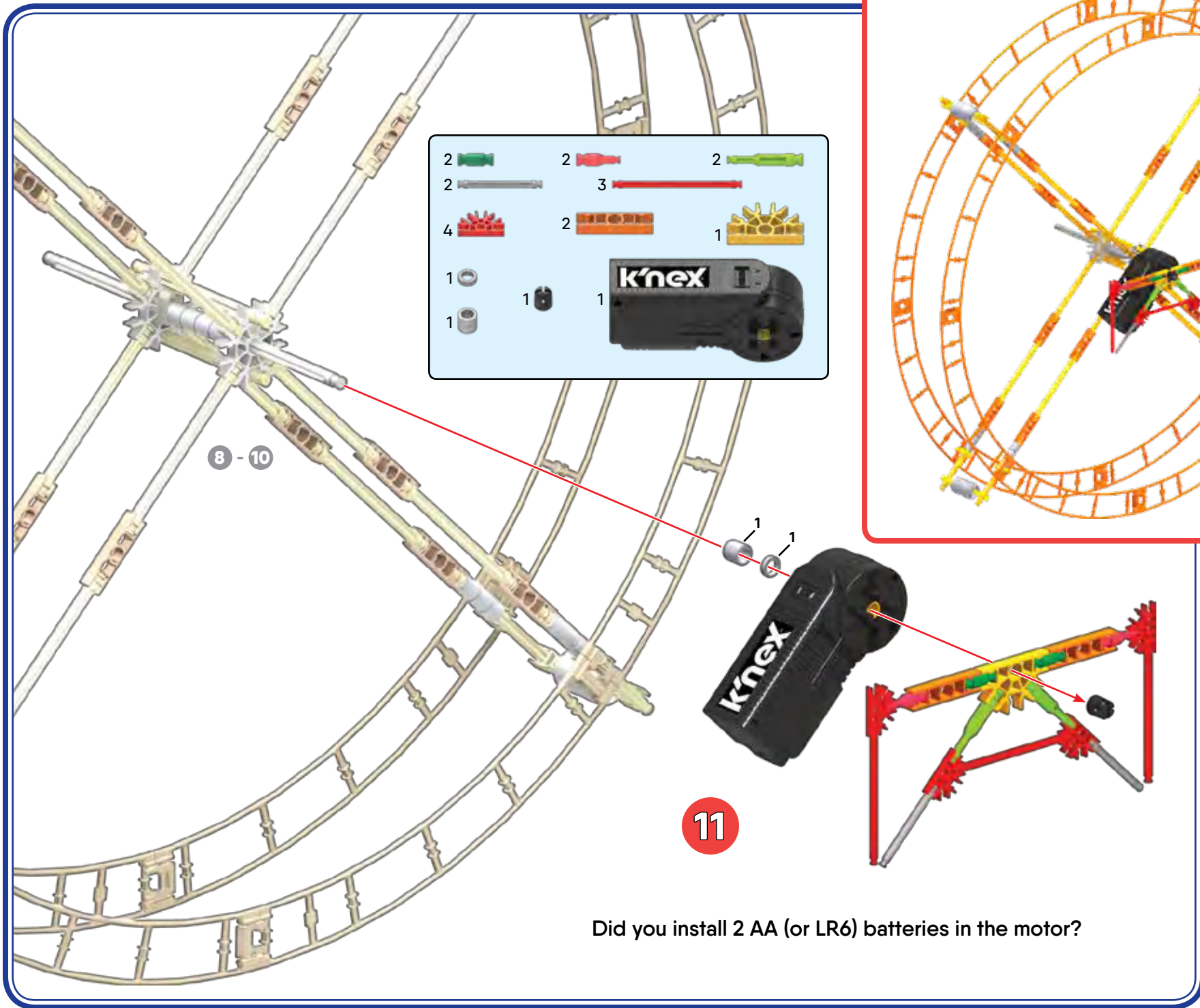

Did you install 2 AA (or LR6) batteries in the motor?

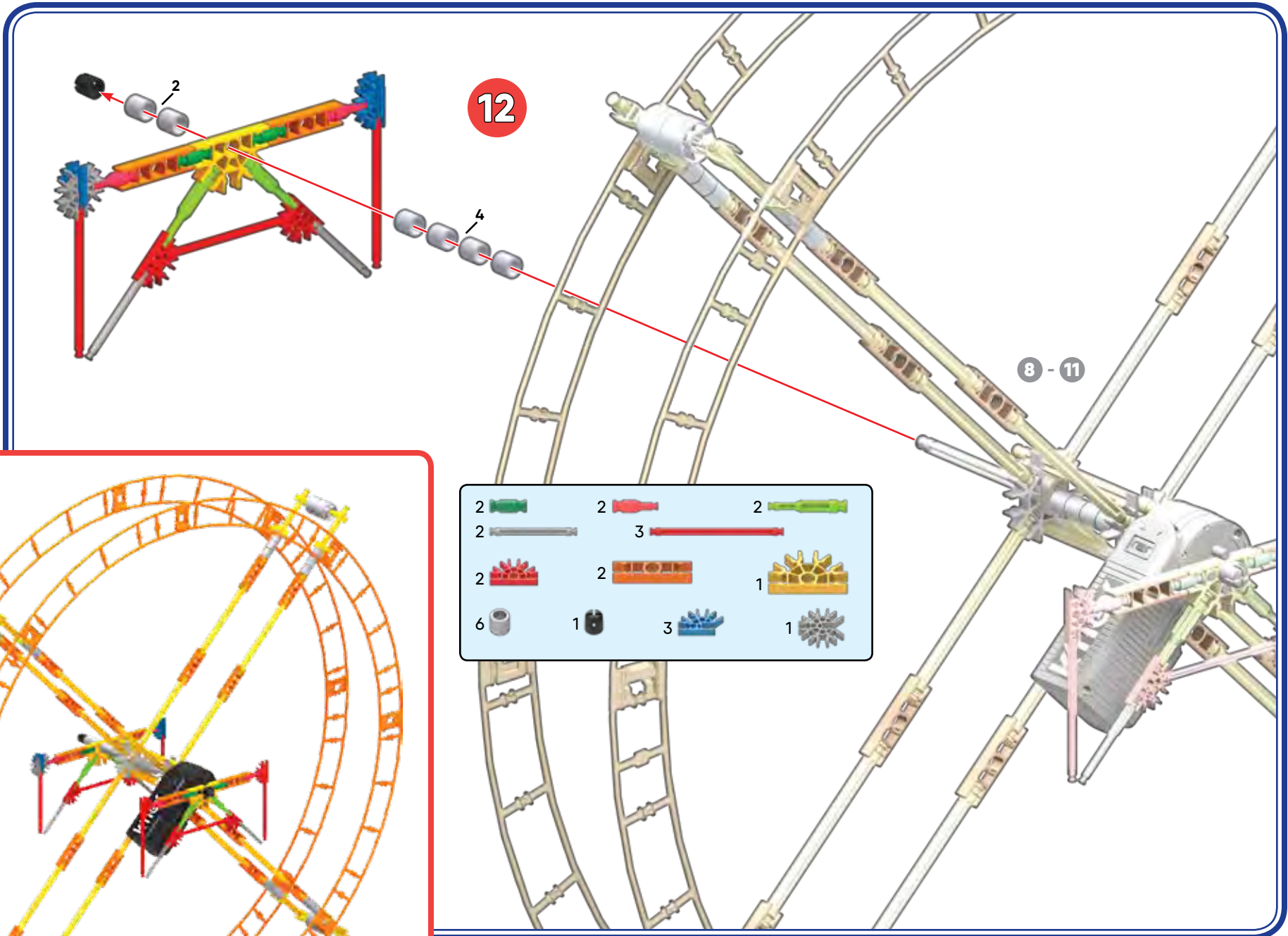

12

8 - 11

- |   |   |   |
|---|---|---|
| 2 | 2 | 2 |
| 2 | 3 | 2 |
| 2 | 2 | 1 |
| 6 | 1 | 3 |
|   |   | 1 |

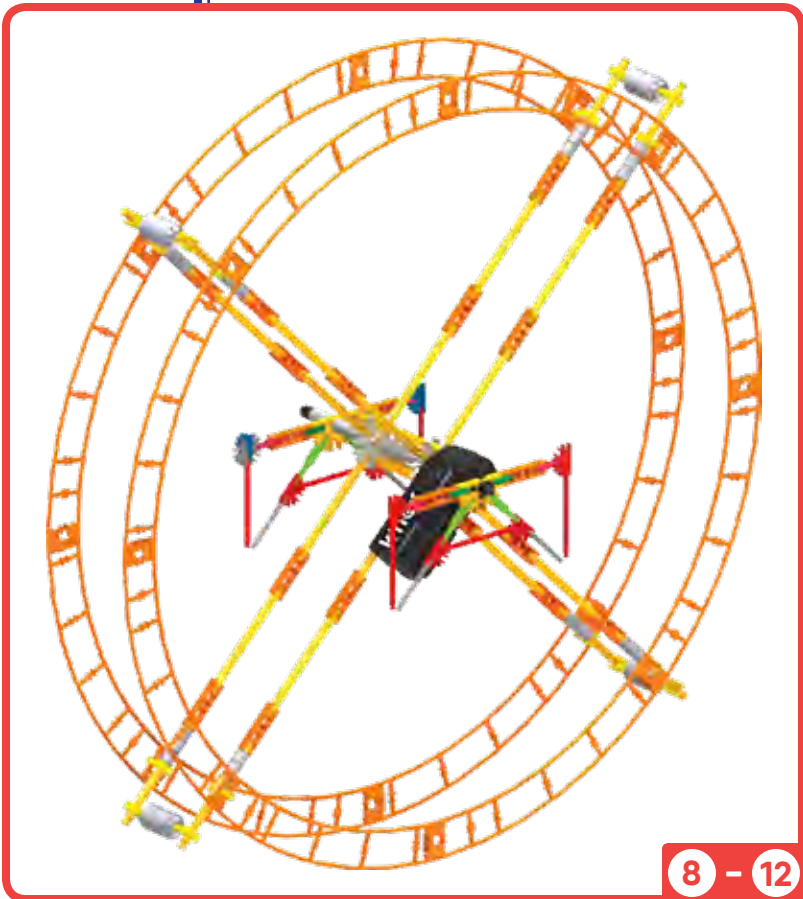

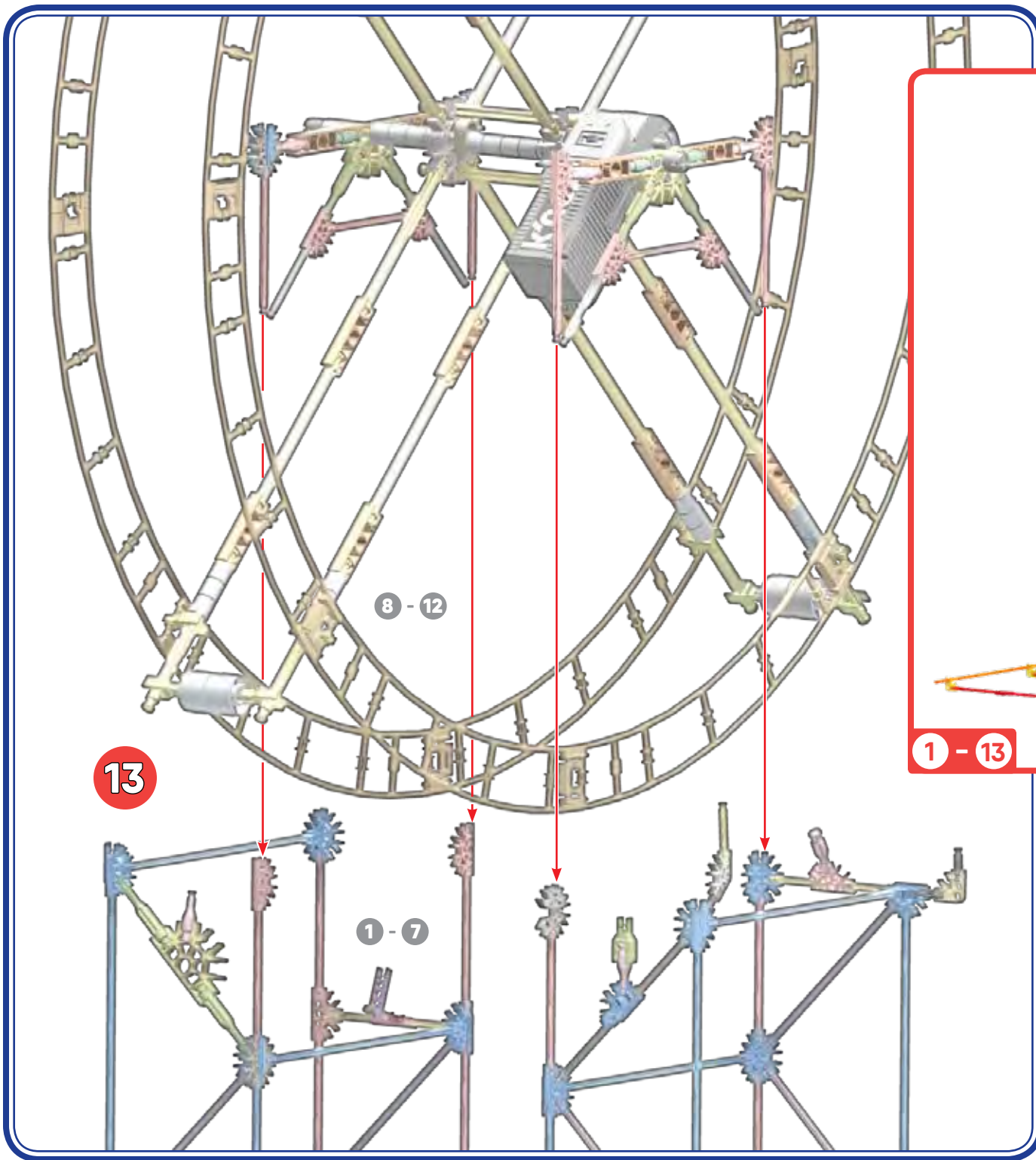

8 - 12

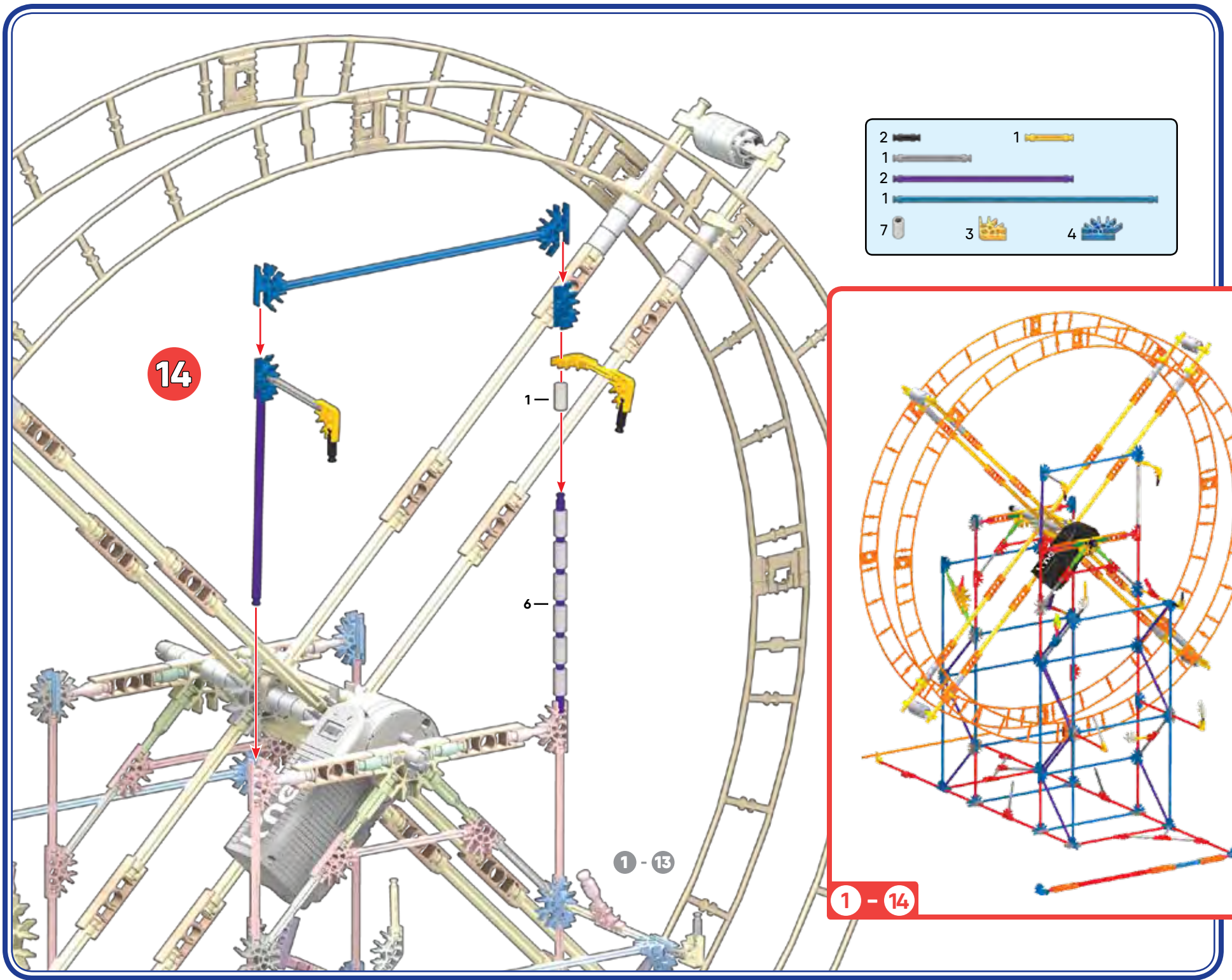

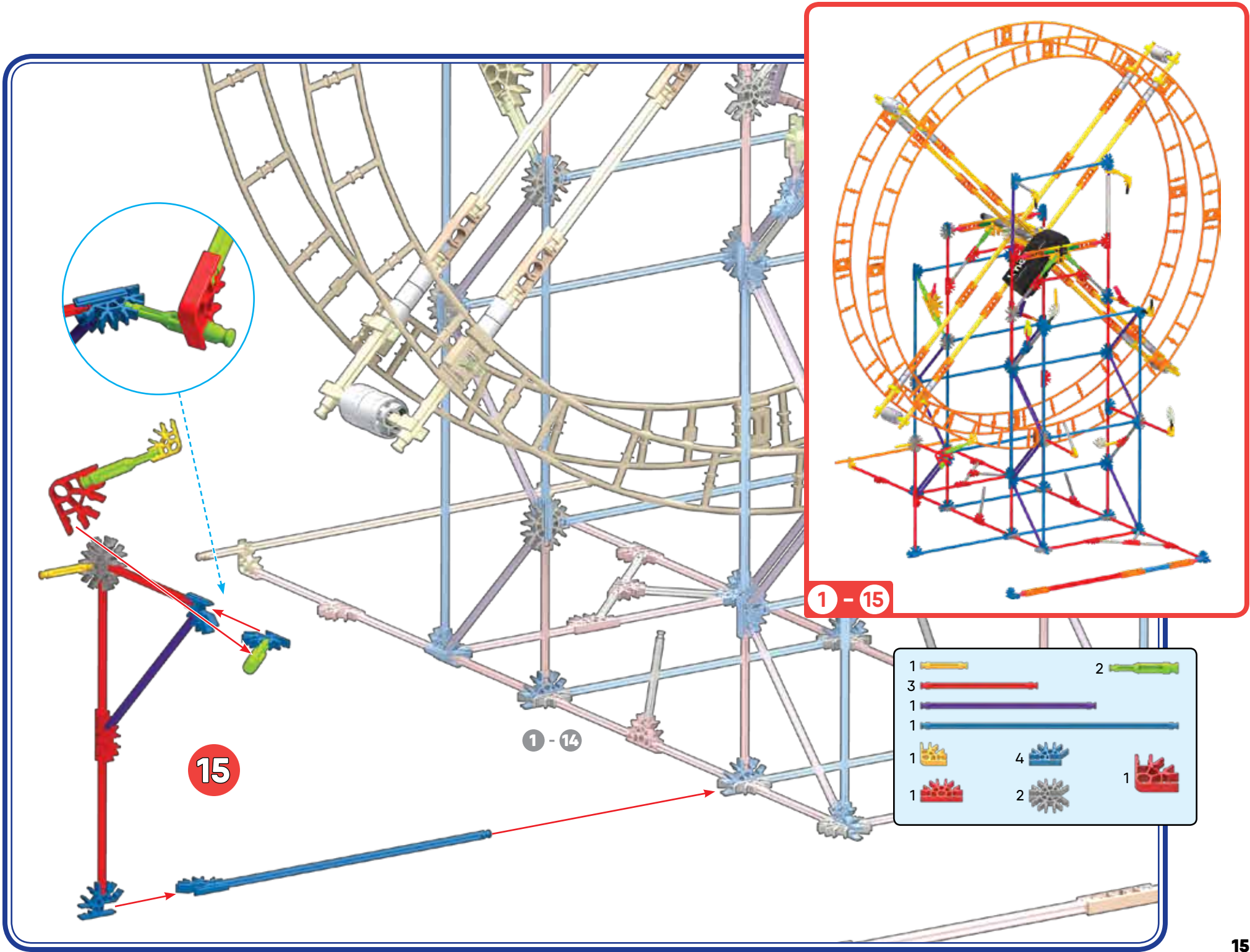

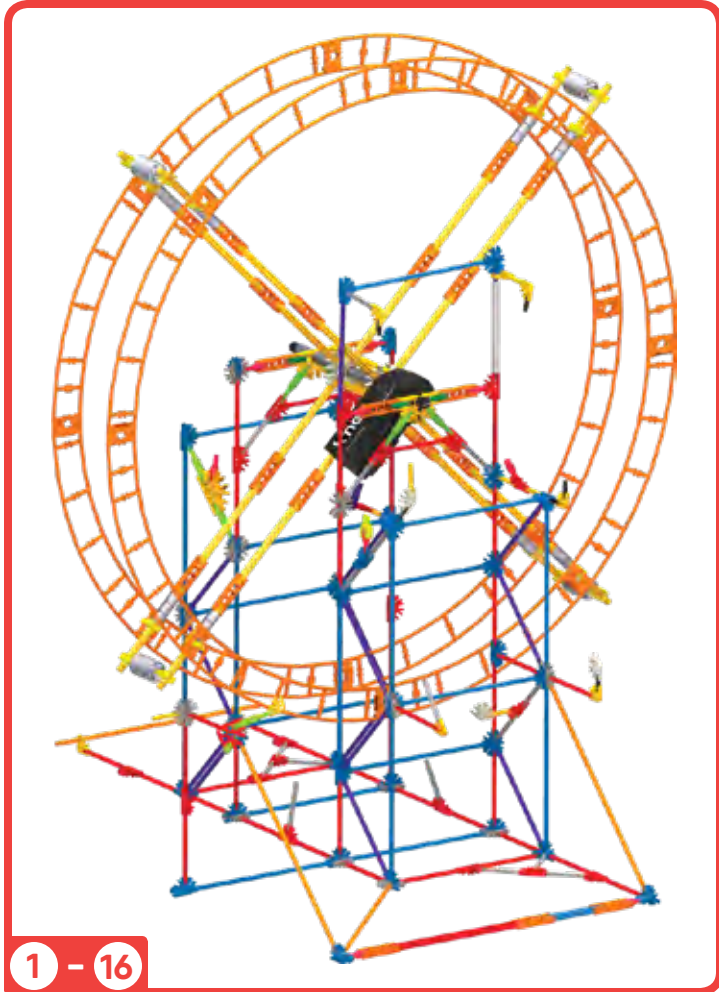
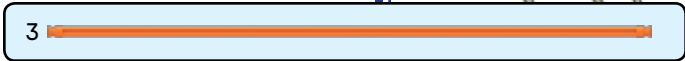
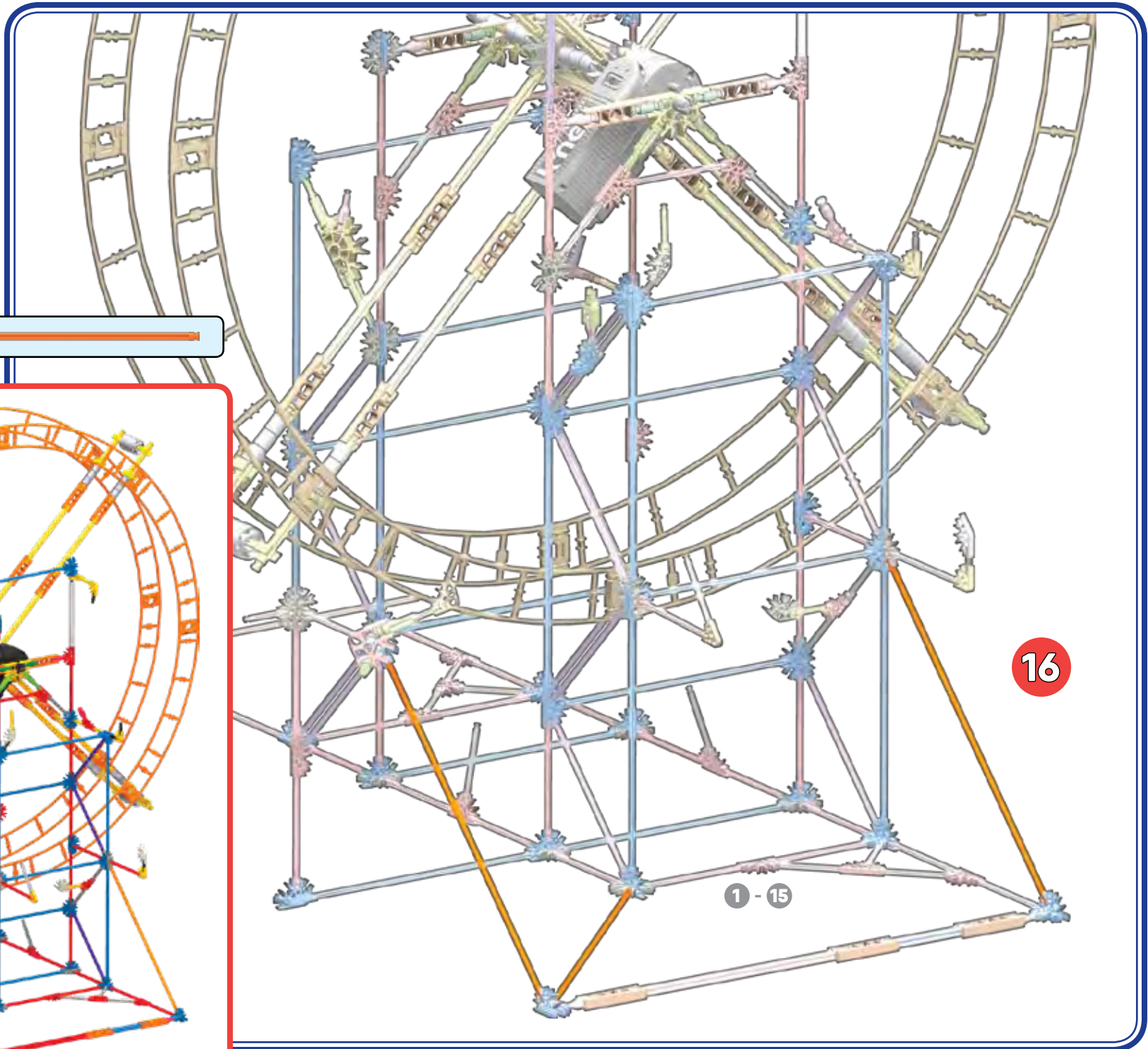



1		4		1	
5					

17

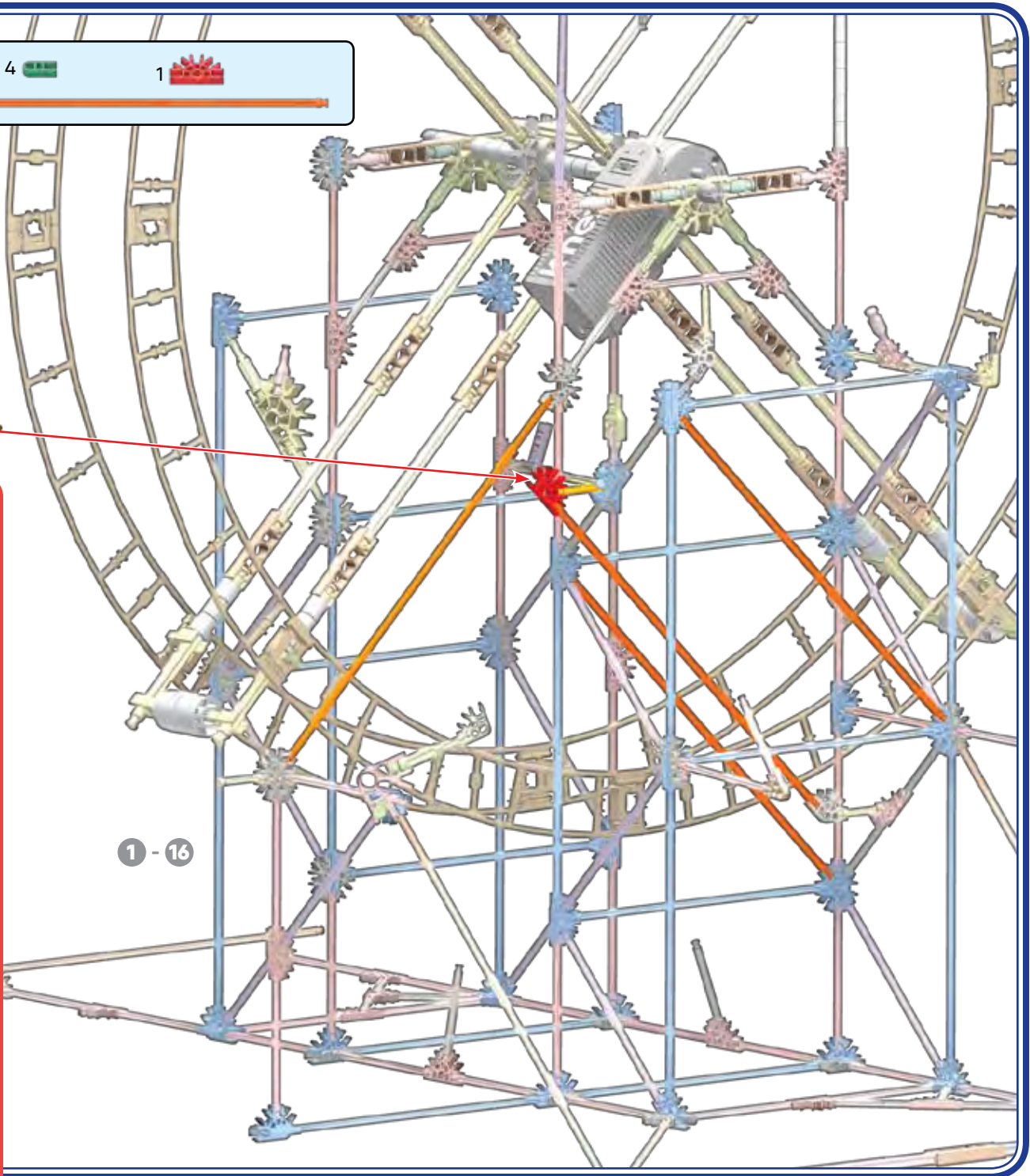

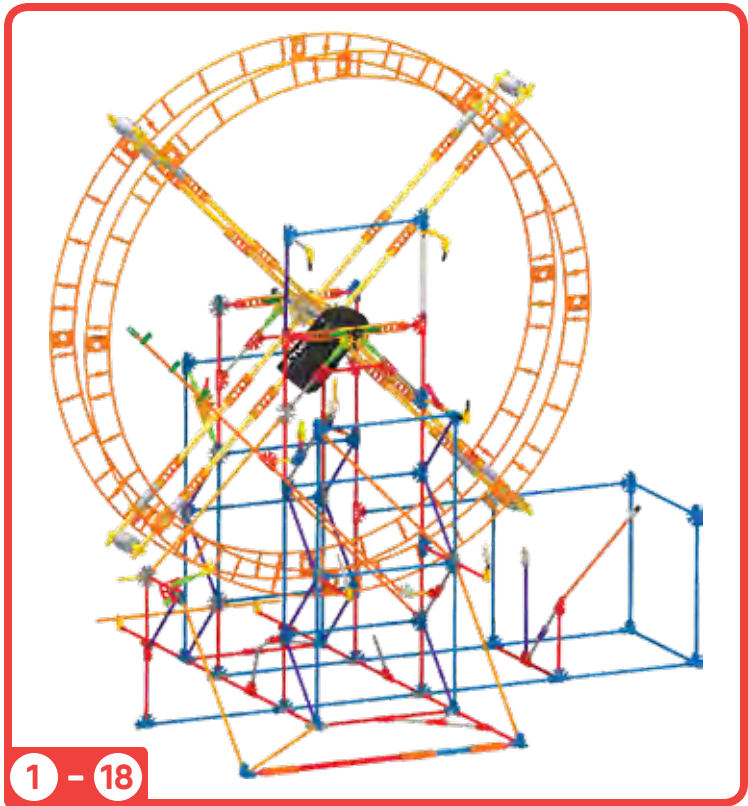

1 - 18

- |    |  |   |  |    |  |   |  |
|----|--|---|--|----|--|---|--|
| 2  |  | 3 |  | 1  |  | 1 |  |
| 1  |  |   |  | 1  |  | 1 |  |
| 11 |  |   |  |    |  |   |  |
| 1  |  |   |  |    |  |   |  |
| 1  |  | 2 |  | 12 |  | 1 |  |

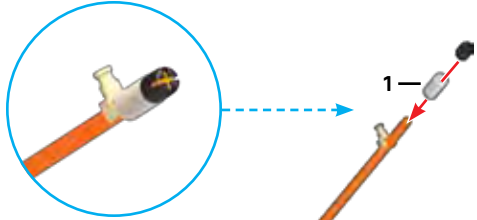

18

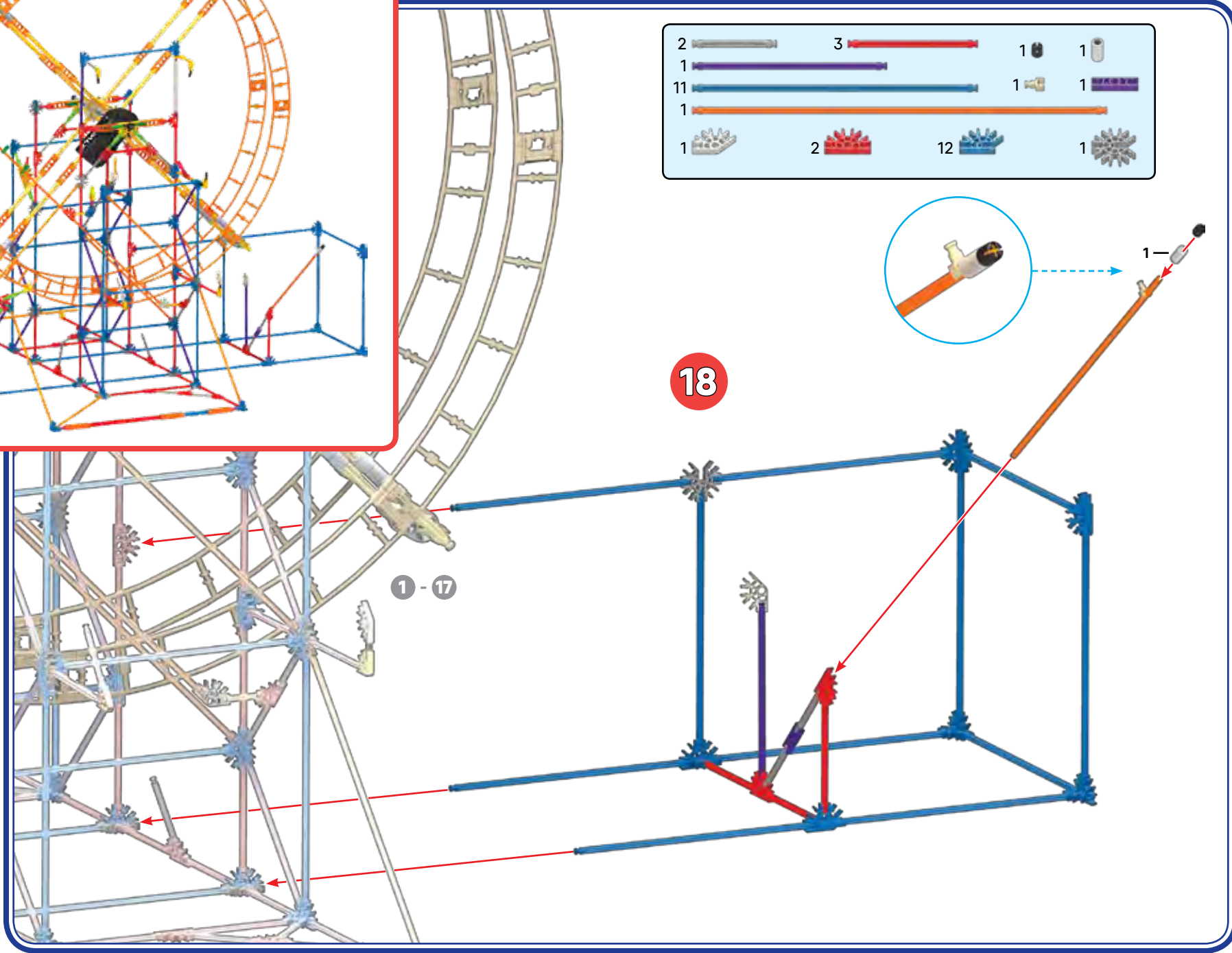

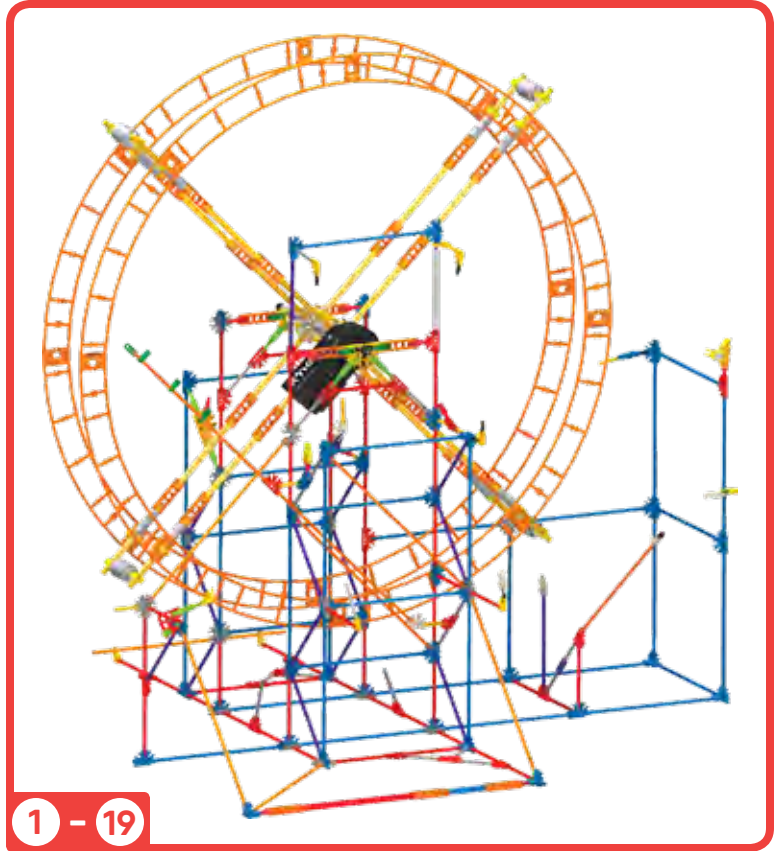
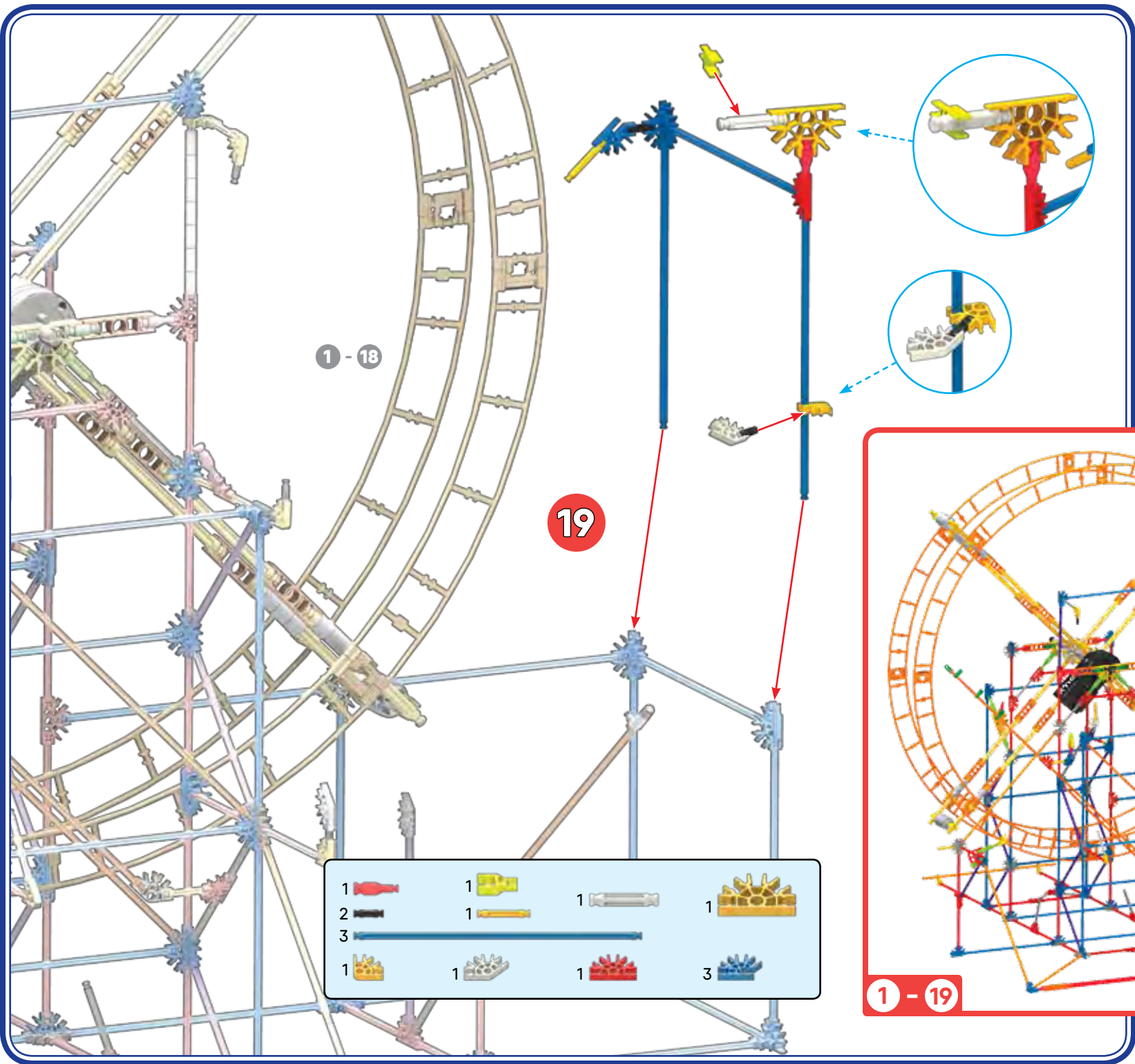

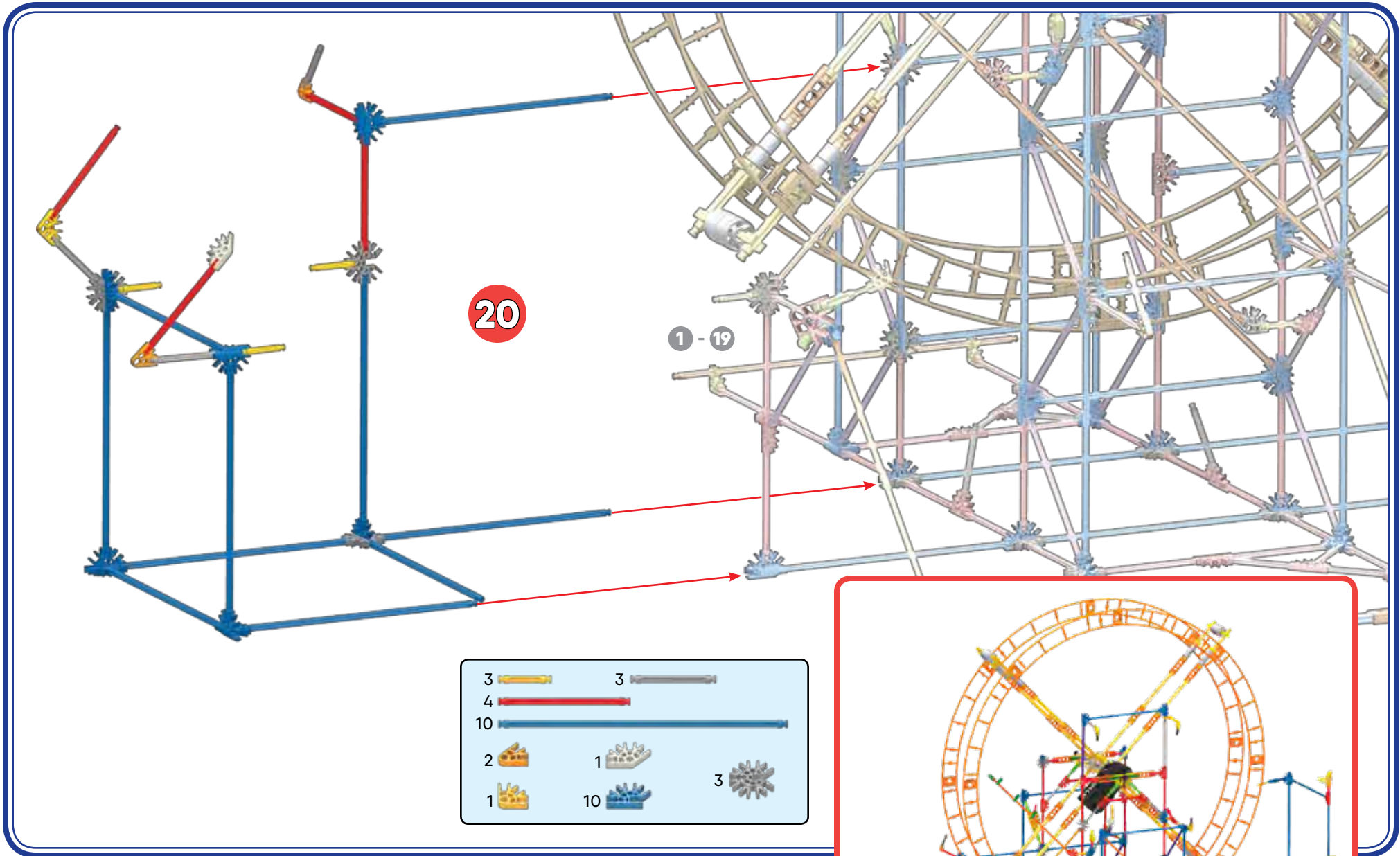

20

1 - 19

- |    |  |    |  |
|----|--|----|--|
| 3  |  | 3  |  |
| 4  |  |    |  |
| 10 |  |    |  |
| 2  |  | 1  |  |
| 1  |  | 10 |  |
|    |  | 3  |  |

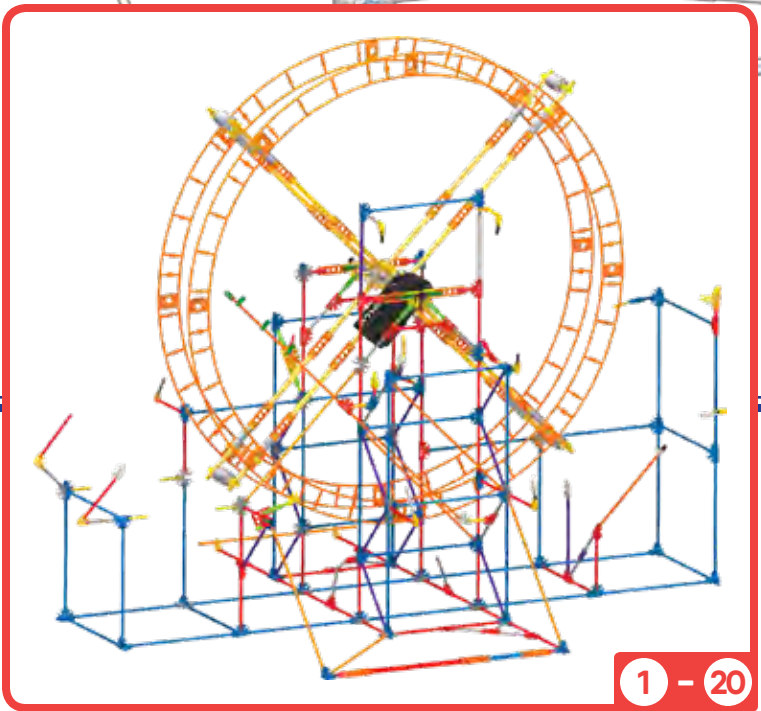

1 - 20

21

- |   |   |   |  |   |  |
|---|---|---|--|---|--|
| 1 |  | 2 |   | 2 |  |
| 6 |  | 2 |  |   |  |
| 1 |  | 6 |   |   |  |

1 - 20

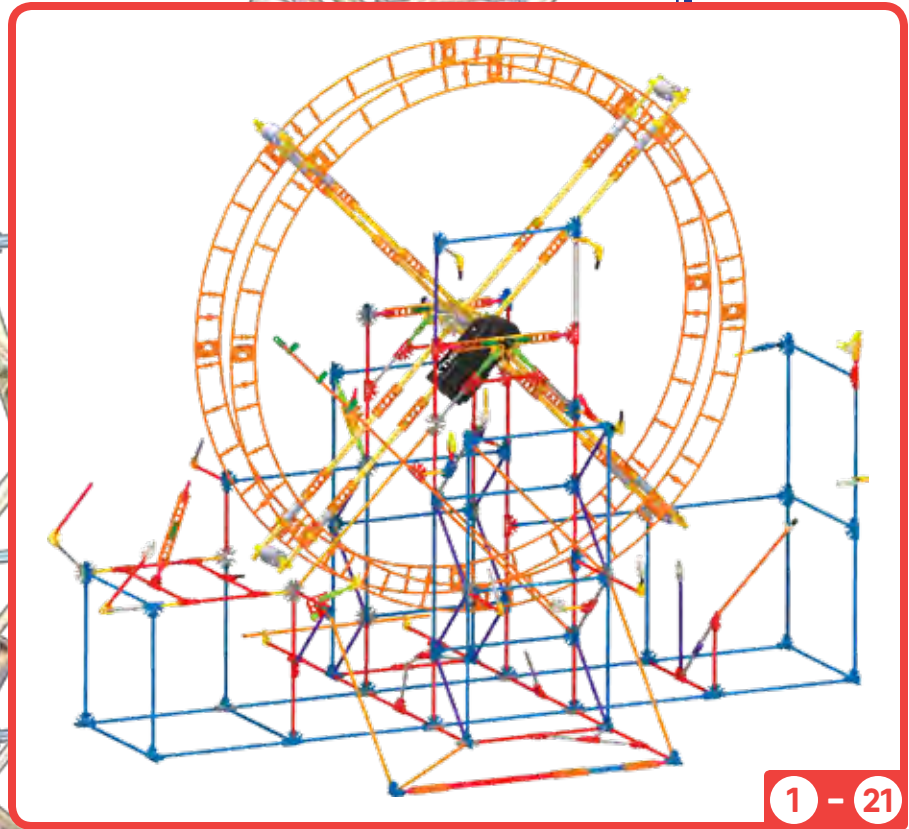

rotate model

22

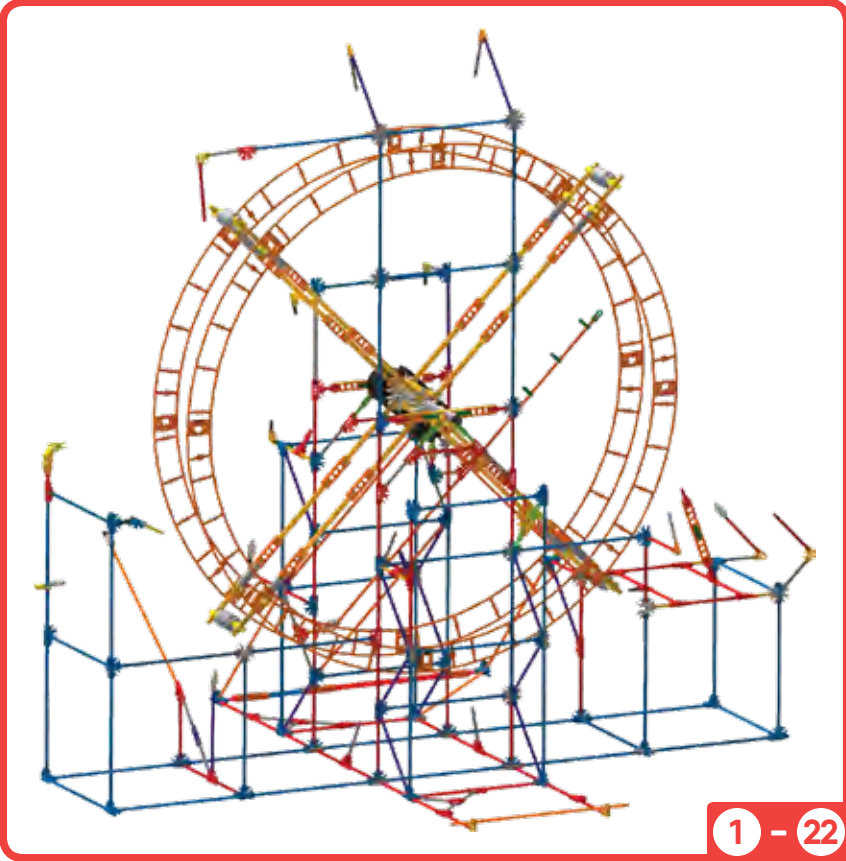
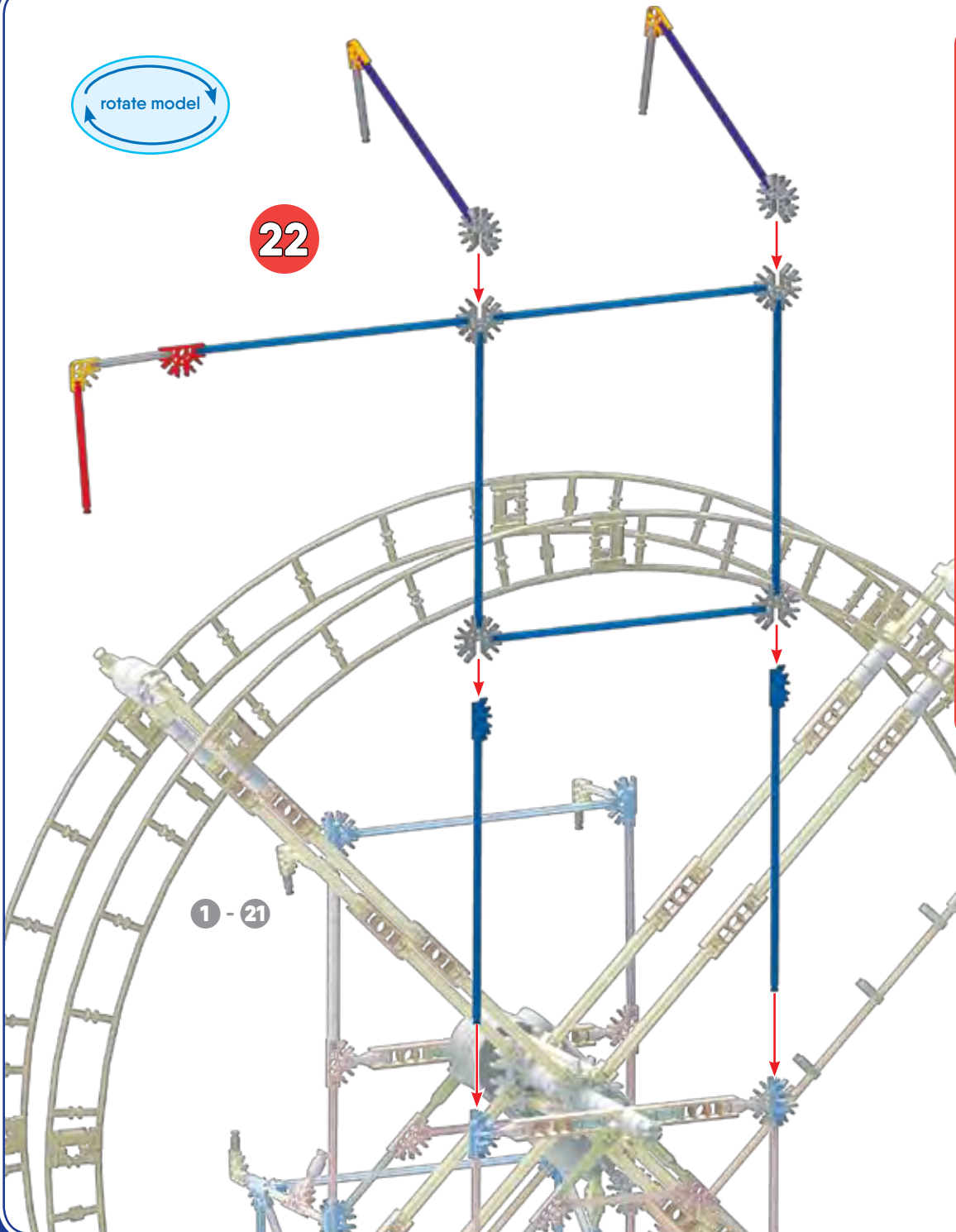

1 - 22

1 - 21

- |   |  |   |  |
|---|--|---|--|
| 3 |  | 1 |  |
| 2 |  |   |  |
| 7 |  |   |  |
| 2 |  | 1 |  |
| 1 |  | 2 |  |
|   |  | 6 |  |

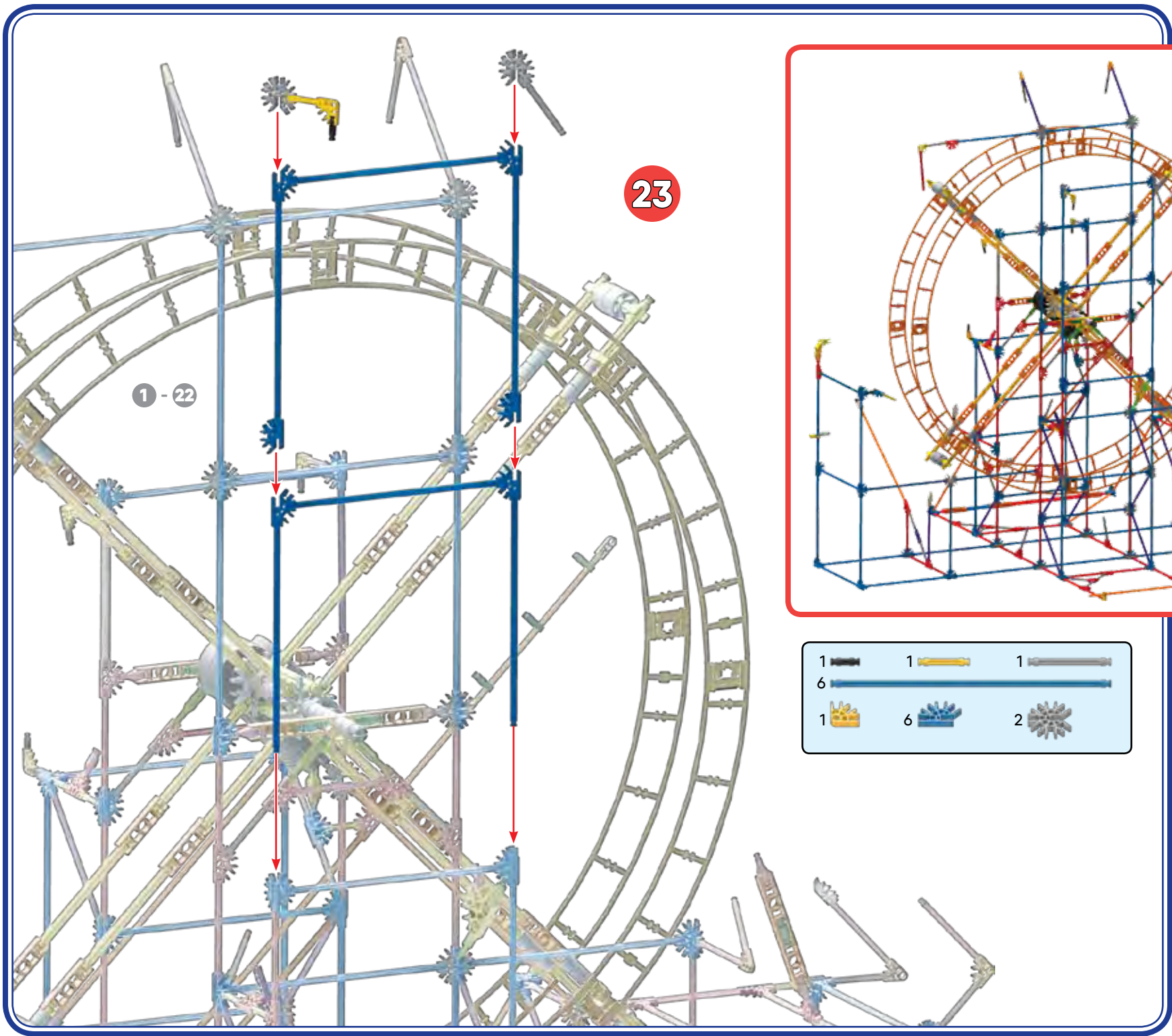

23

1 - 22

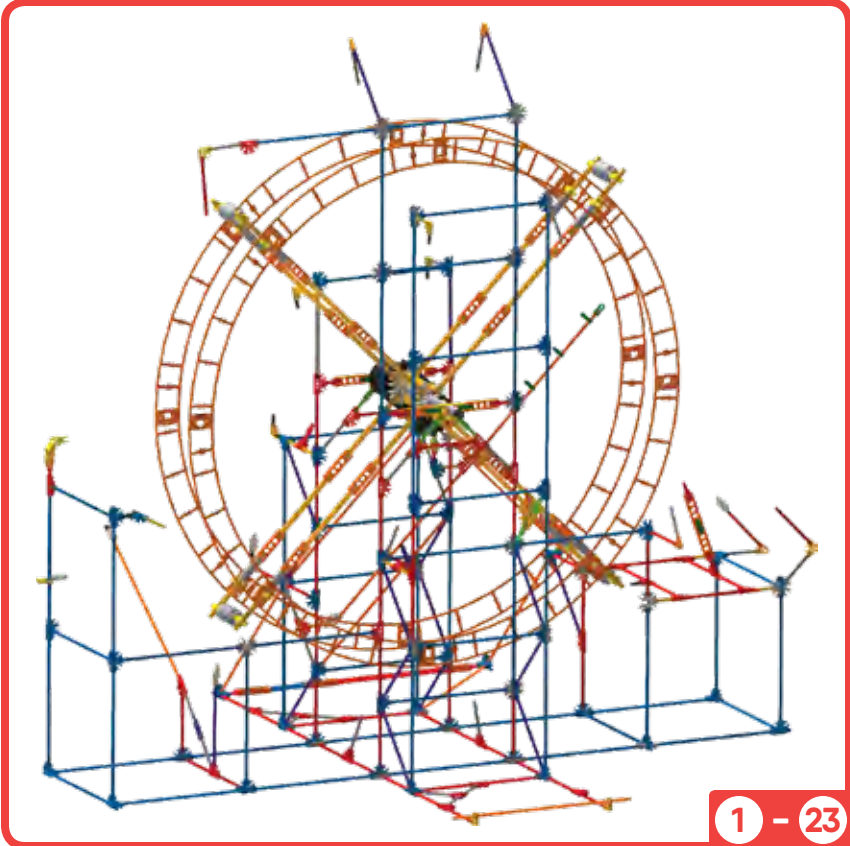

1 - 23

1	1	1
6		
1	6	2

24



1 - 23

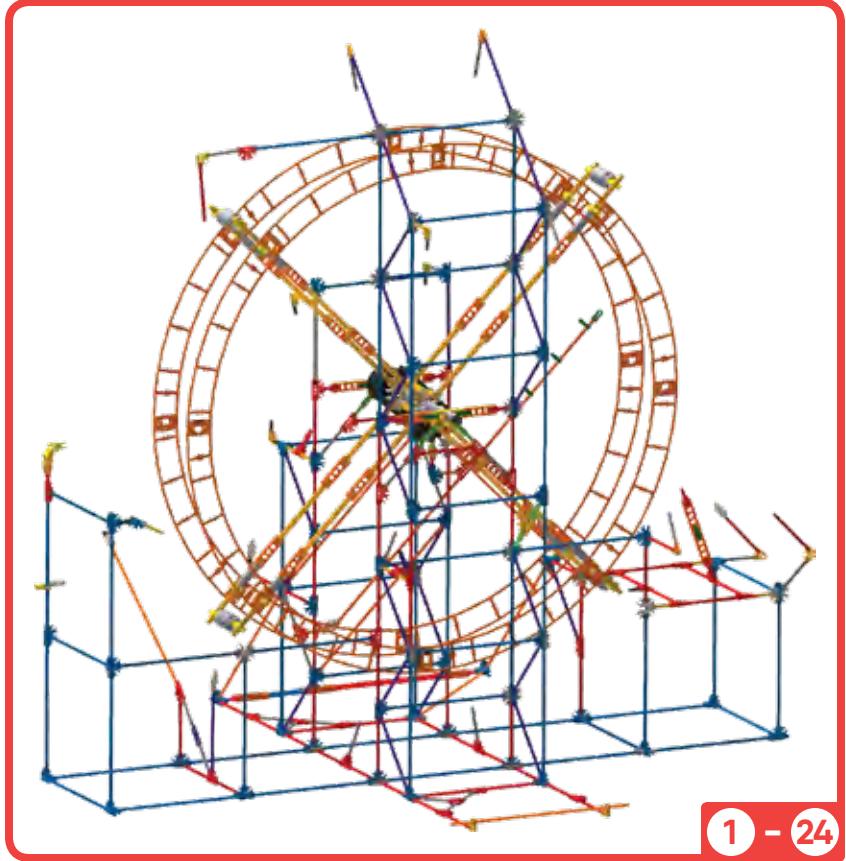
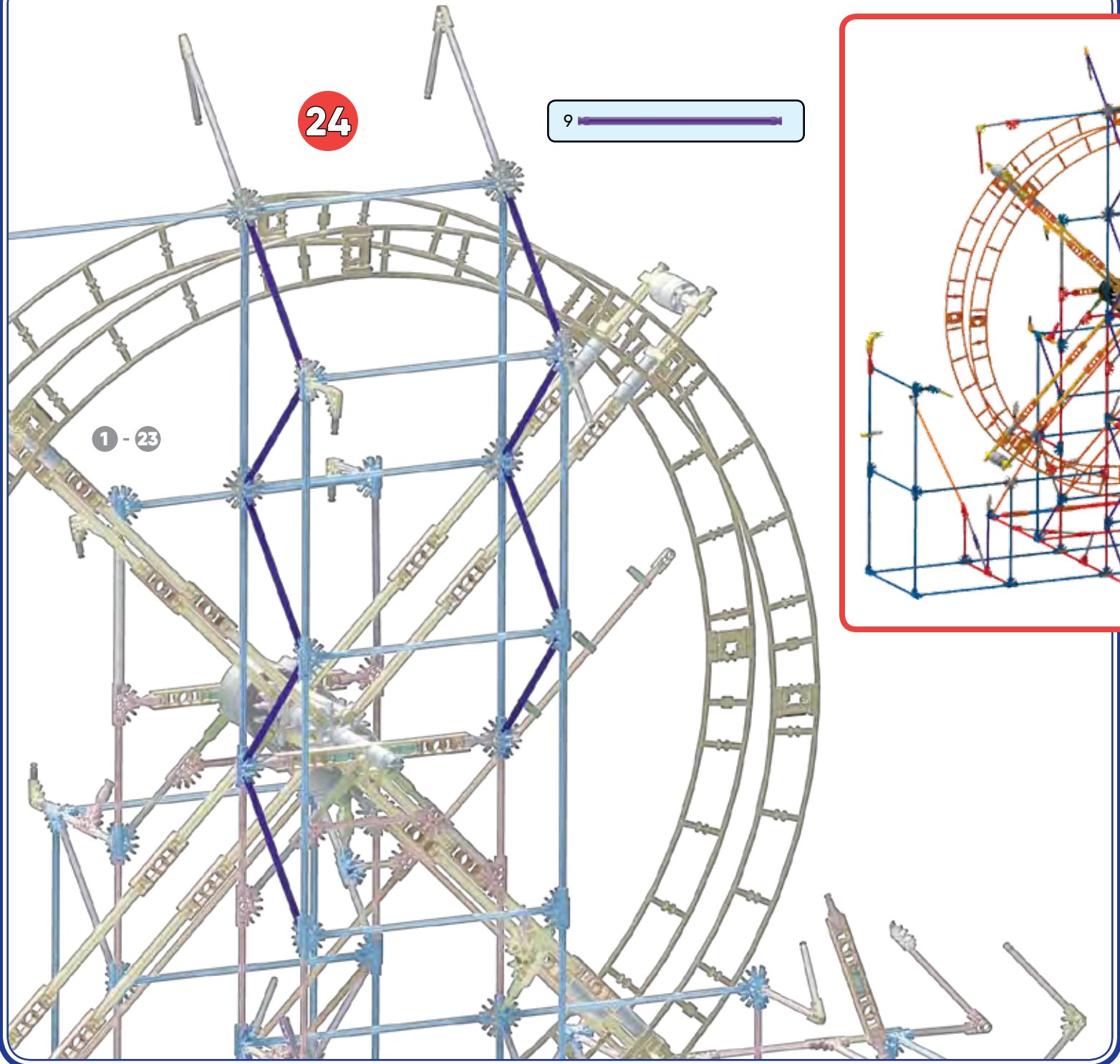

1 - 24

- |   |  |   |  |   |   |  |
|---|--|---|--|---|---|--|
| 1 |  | 2 |  |   | 1 |  |
| 1 |  | 2 |  |   |   |  |
| 4 |  |   |  |   |   |  |
| 1 |  |   |  | 2 |   |  |

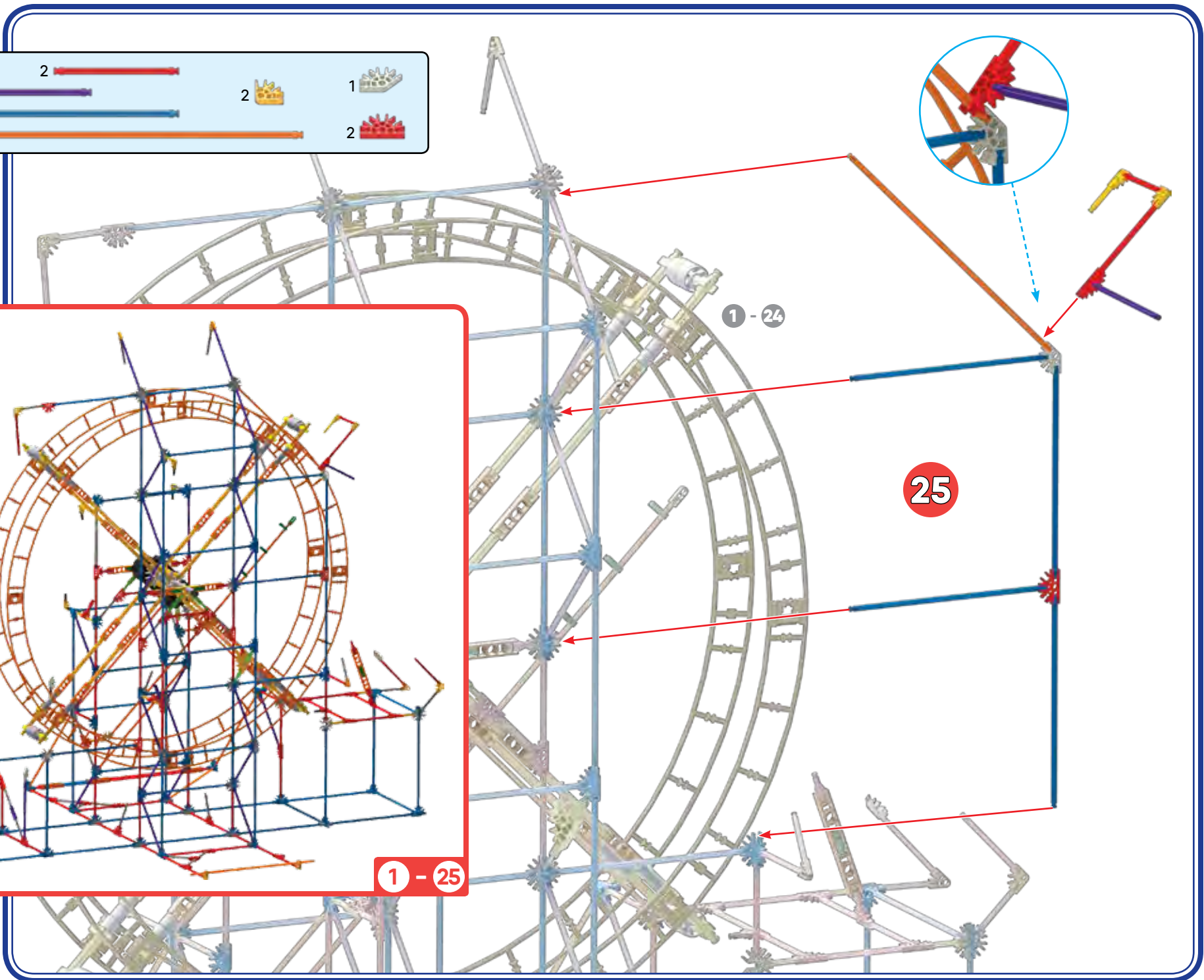
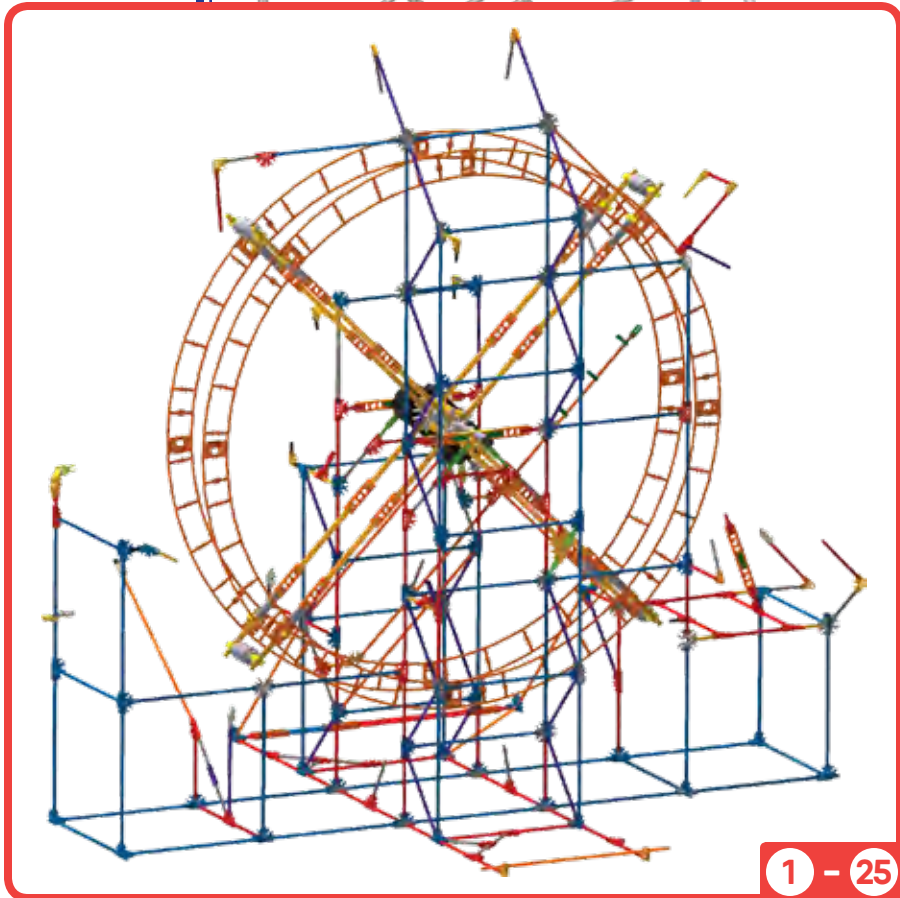

12

26

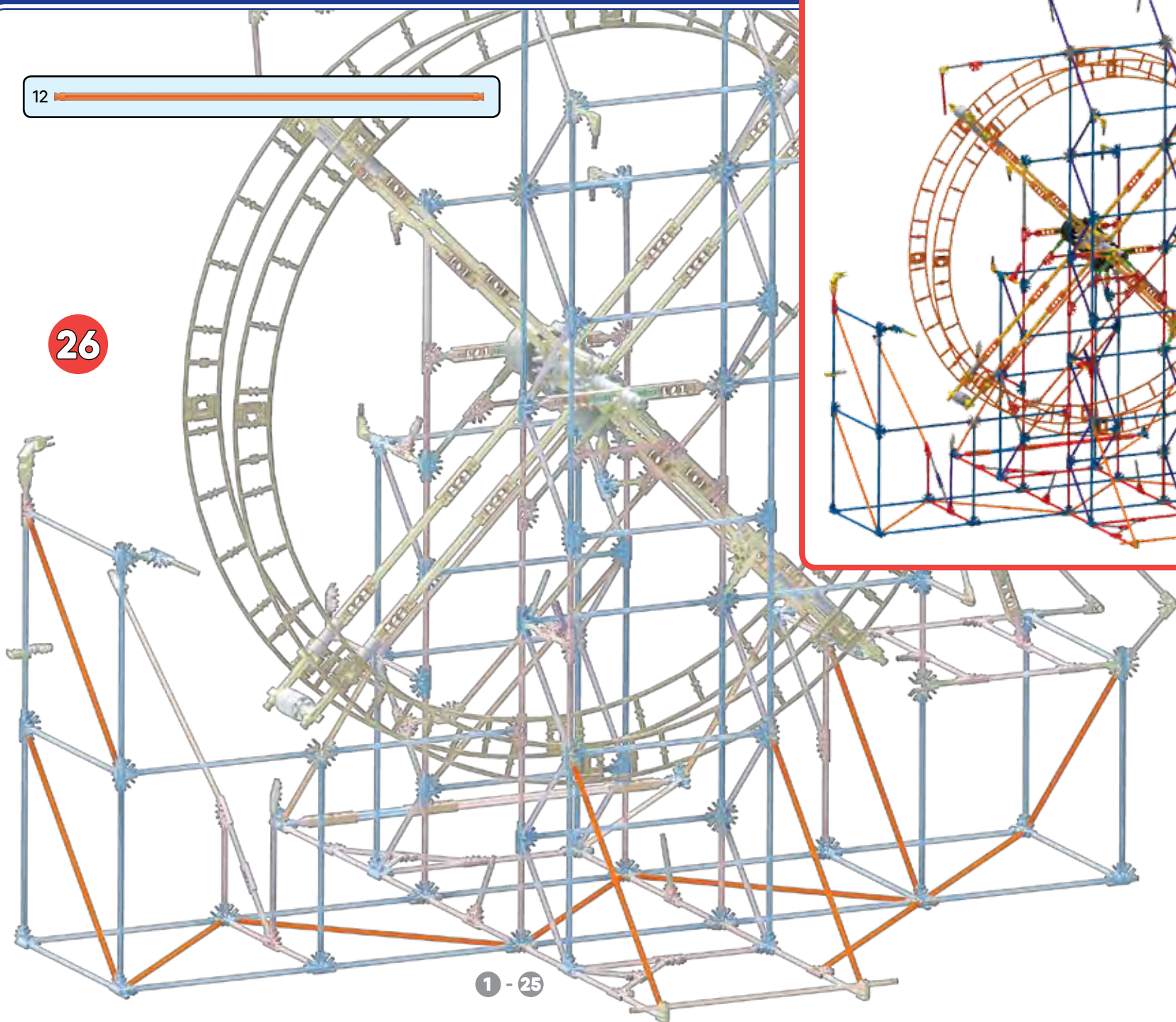

1 - 25

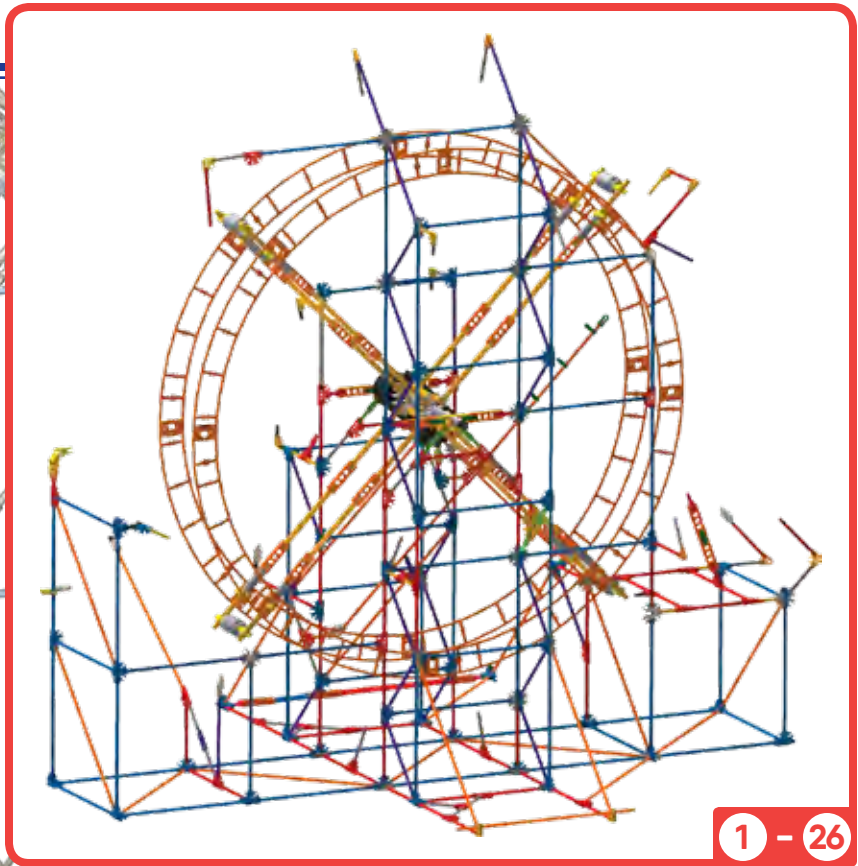

1 - 26

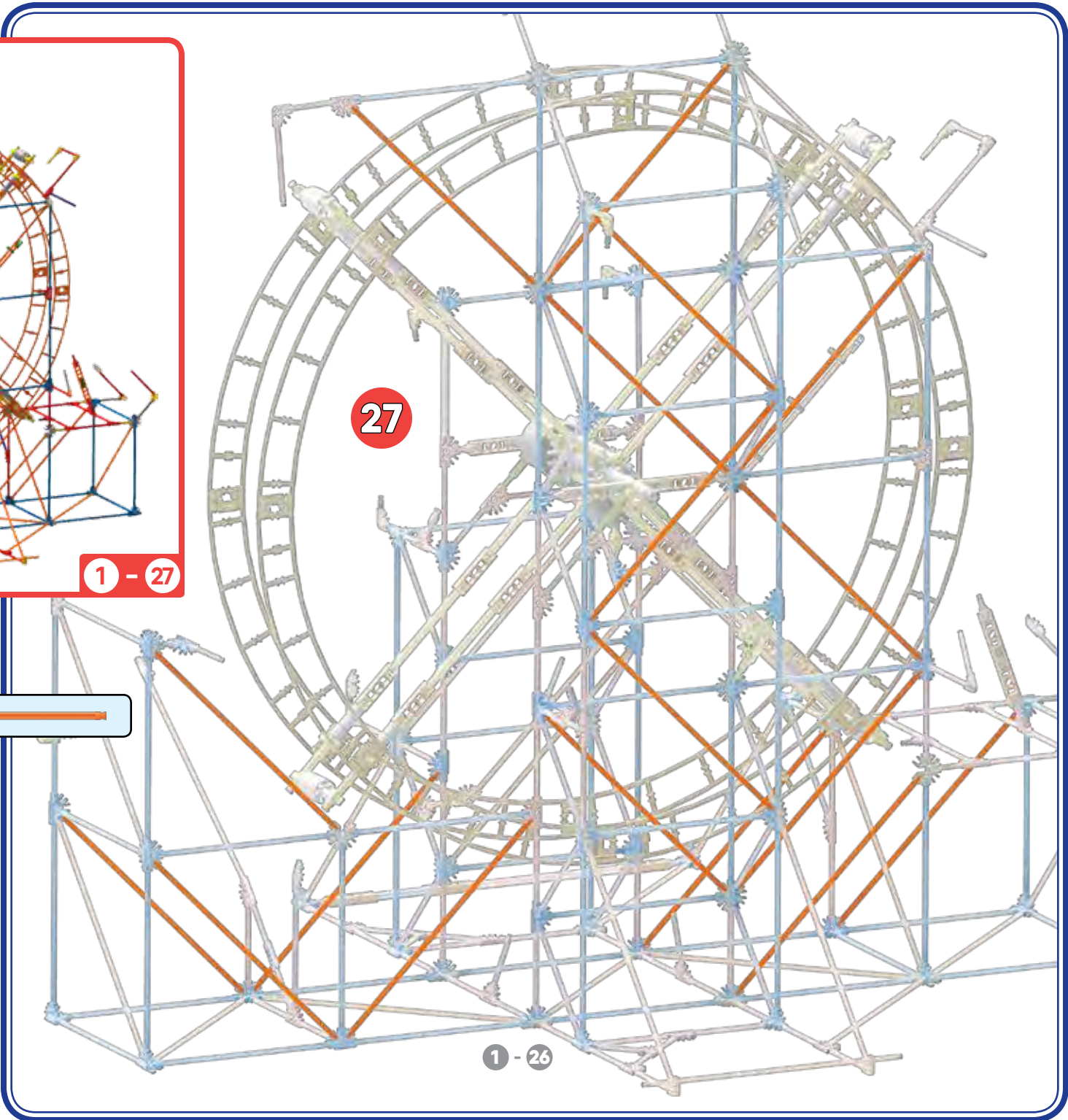
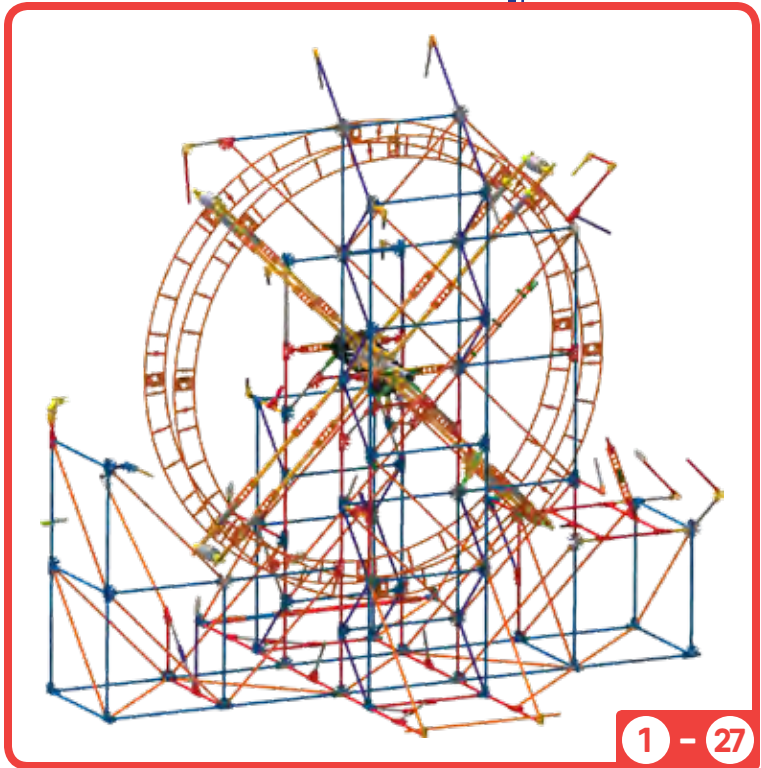

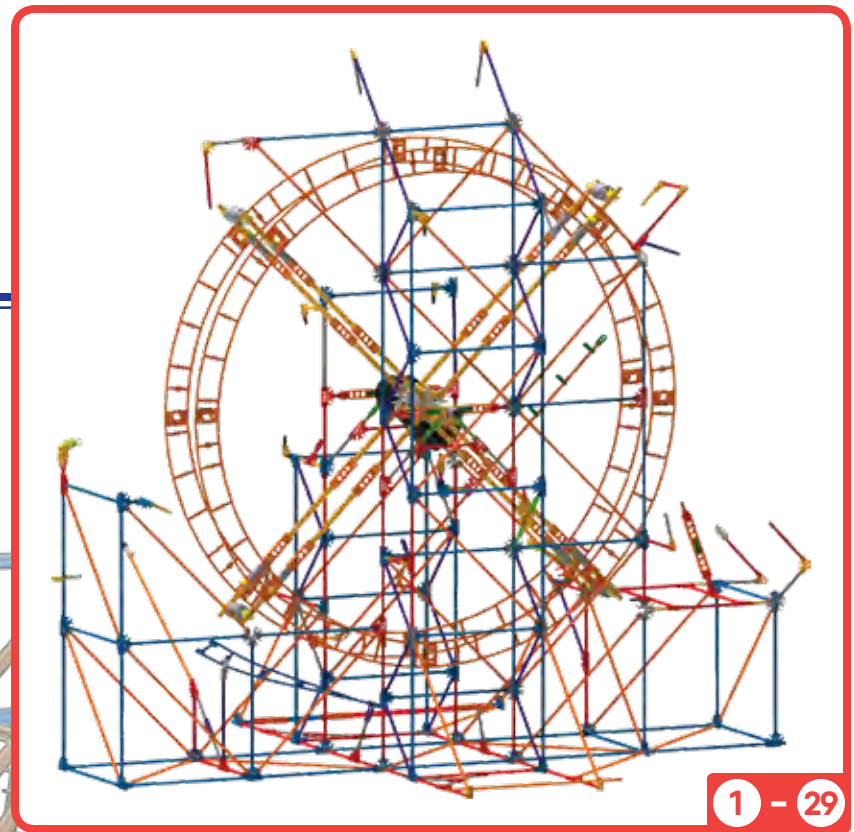
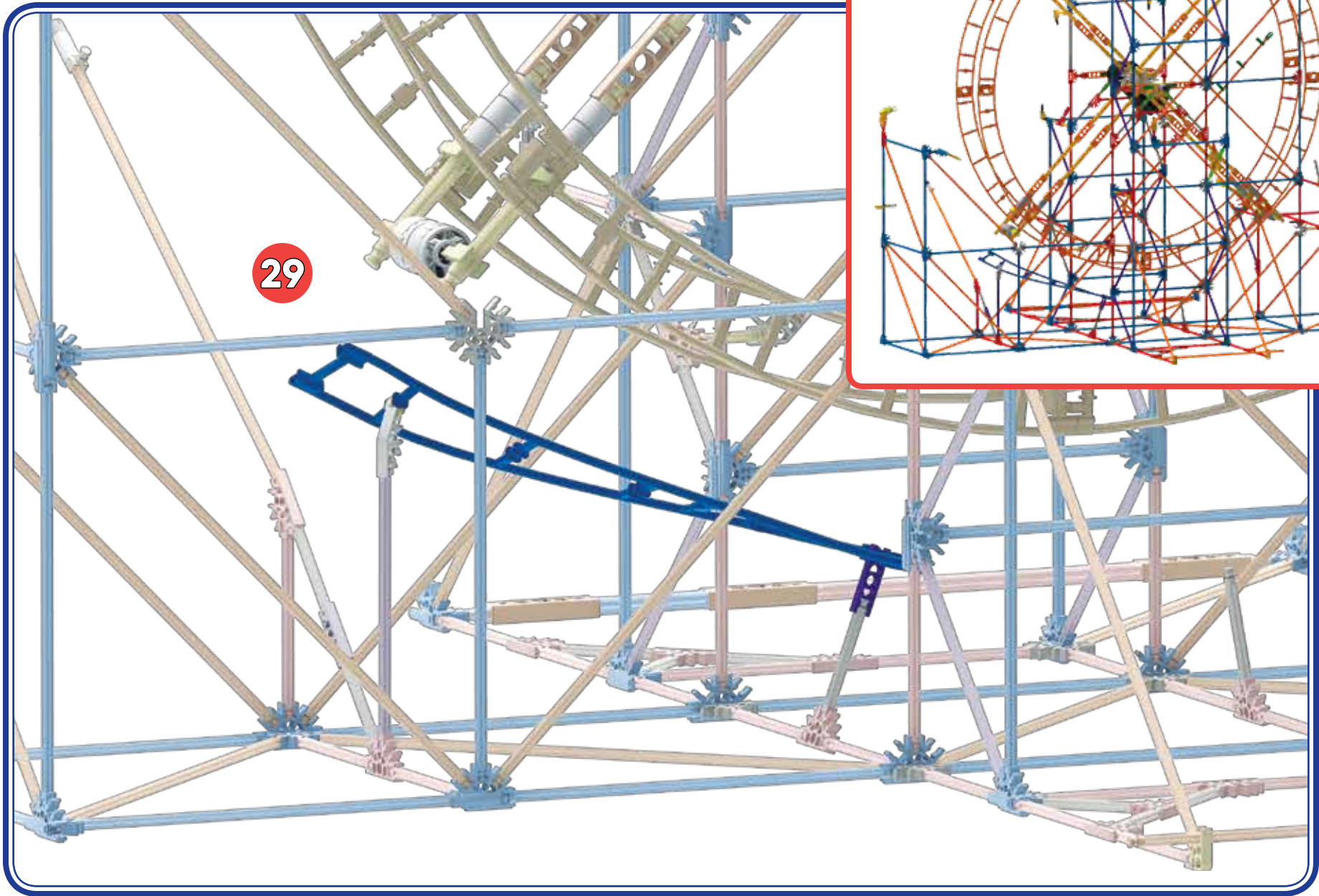
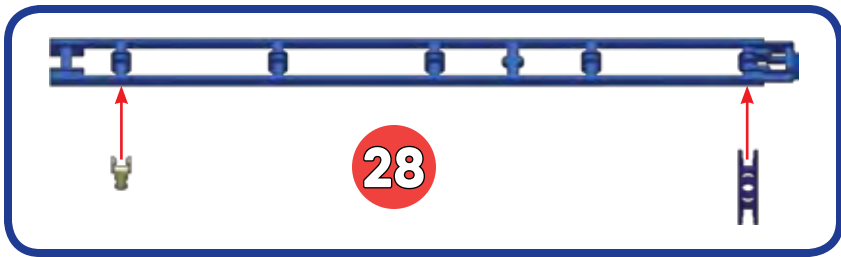

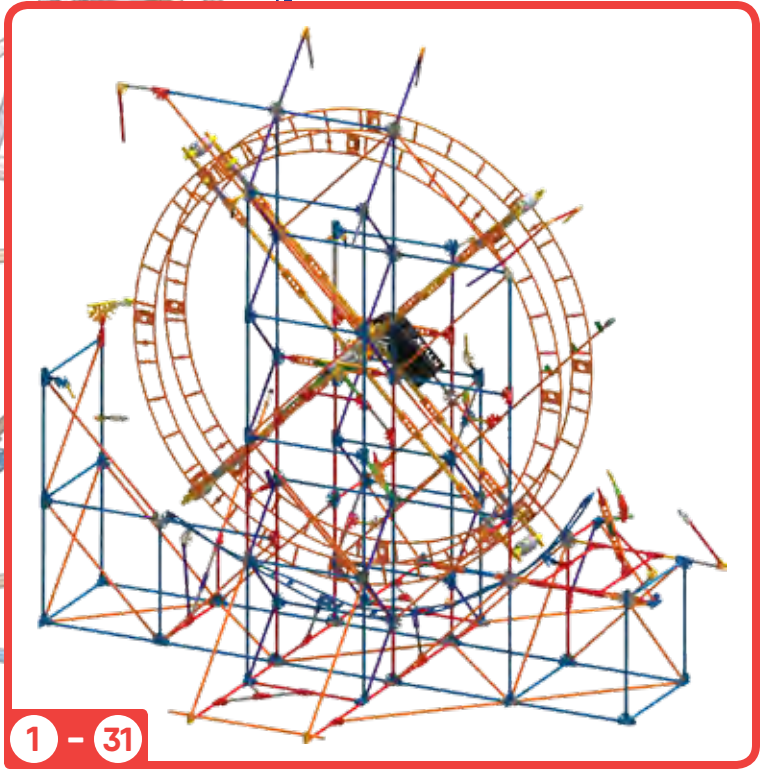
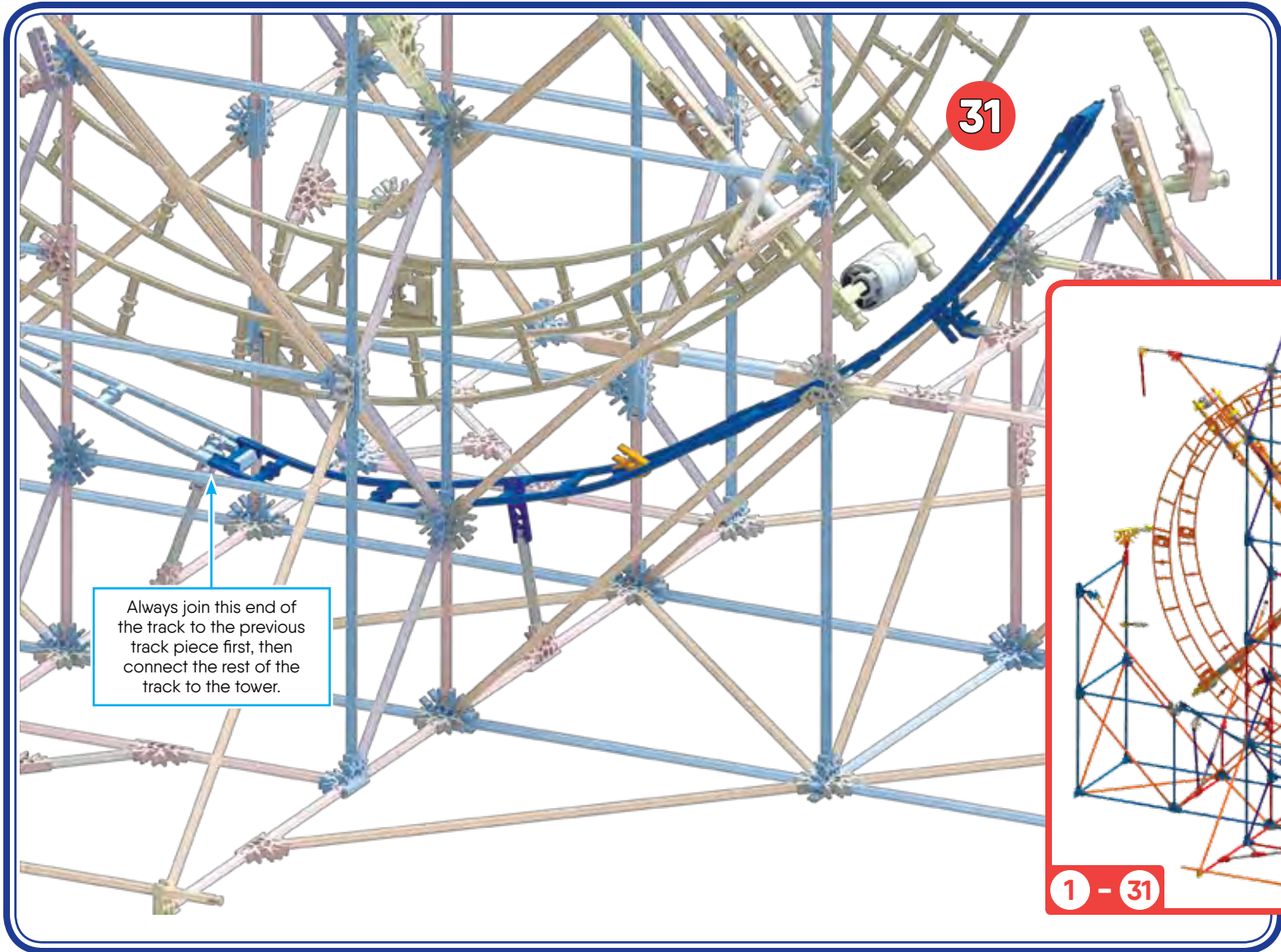
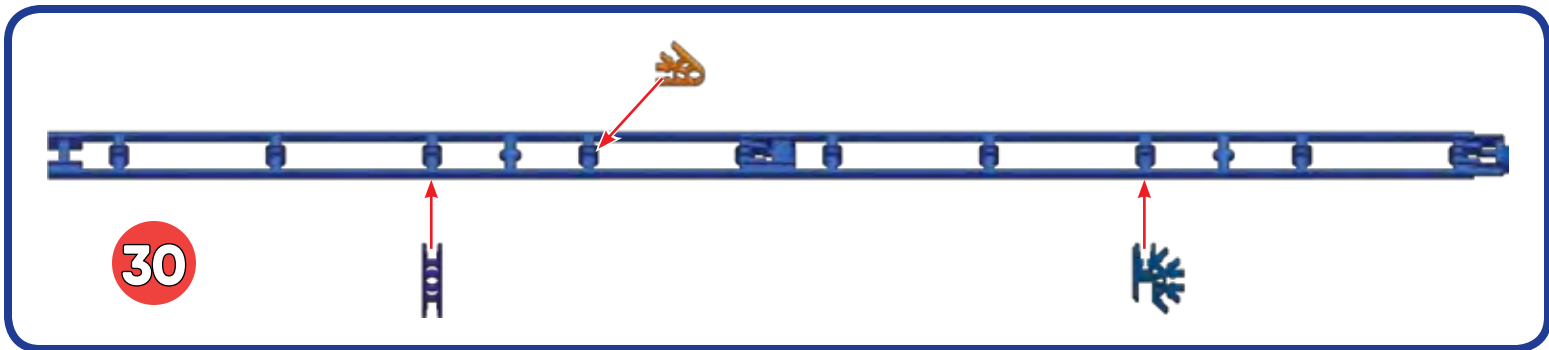

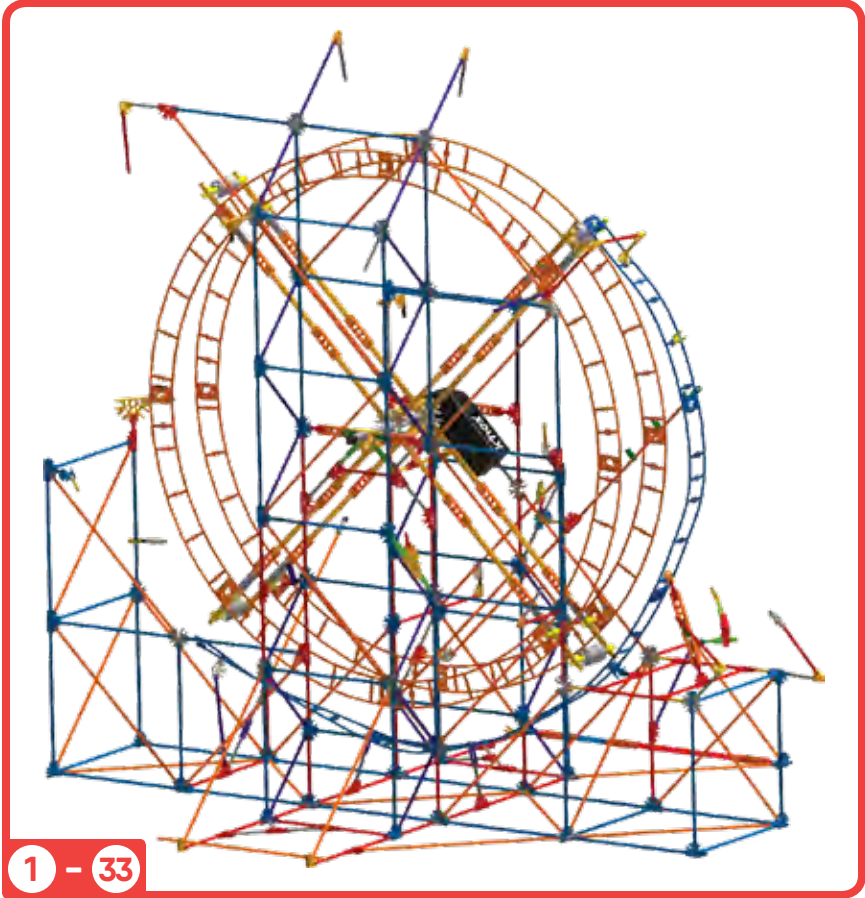
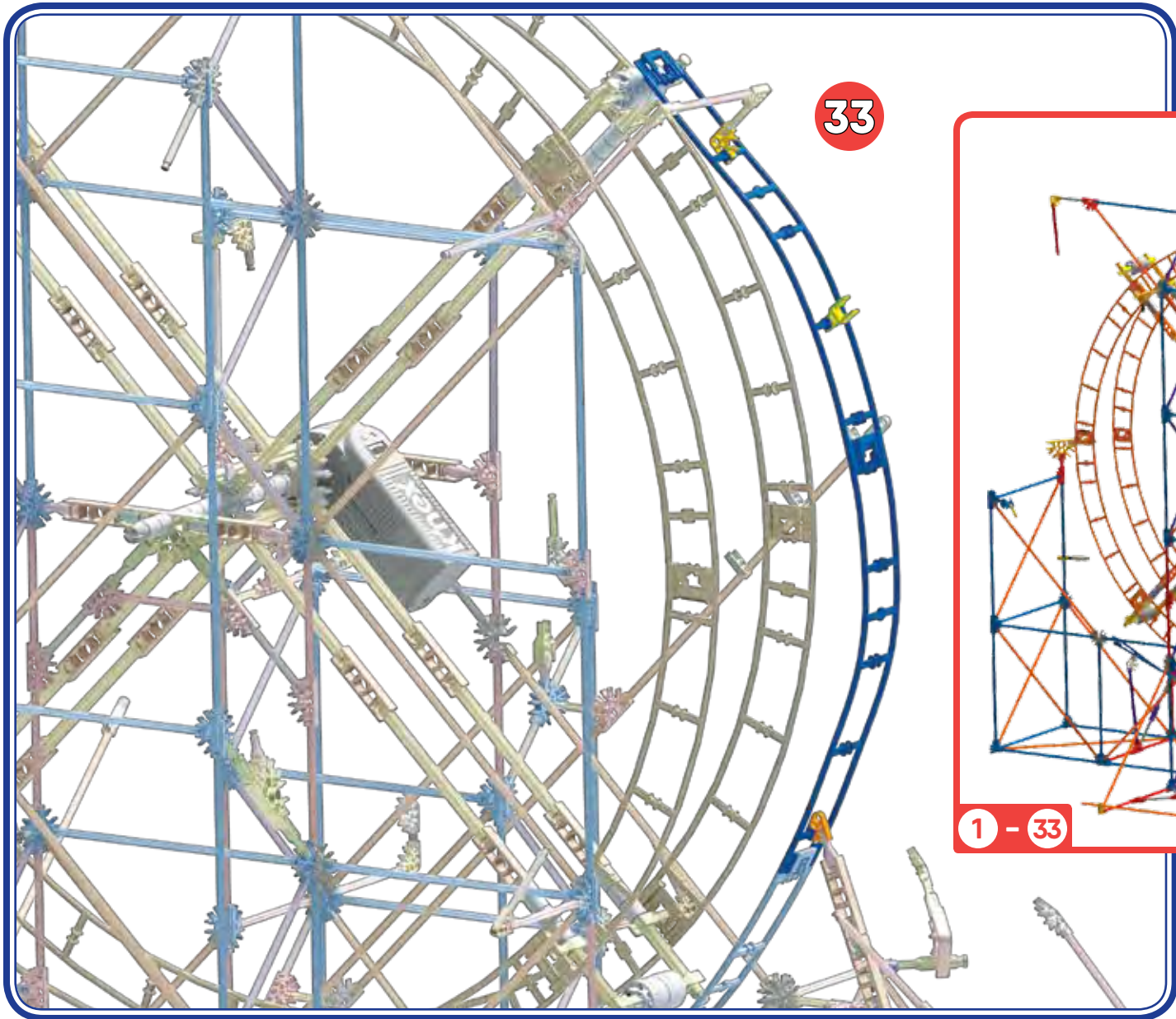

34

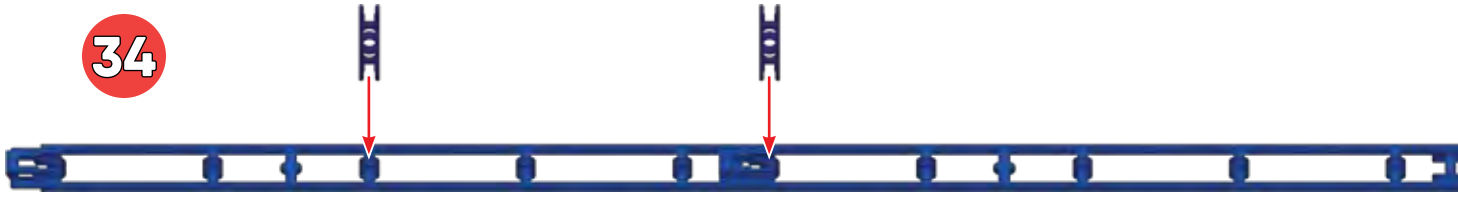

35

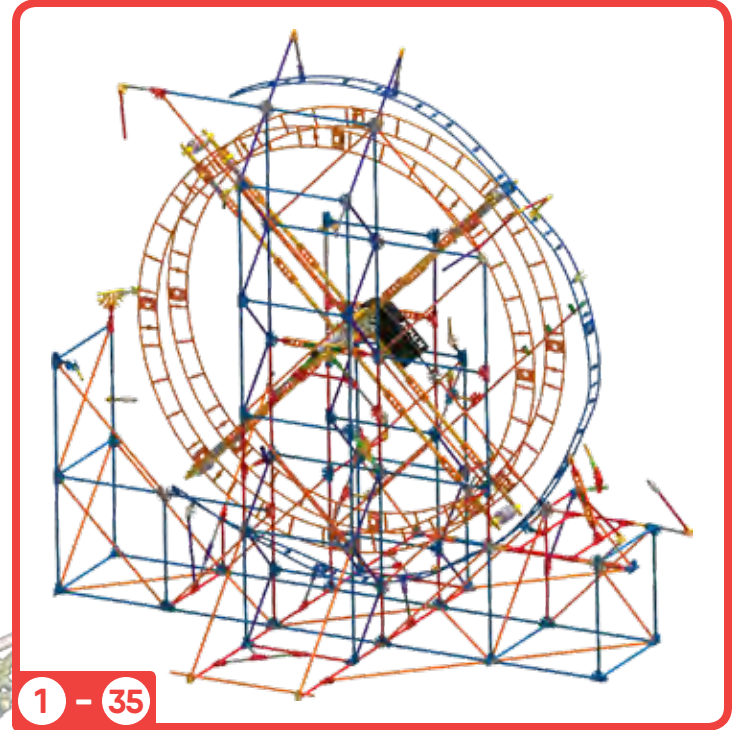

1 - 35

36

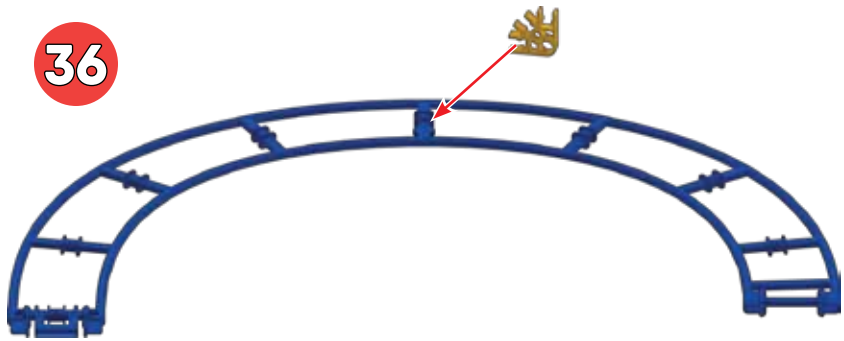

37



1 - 37

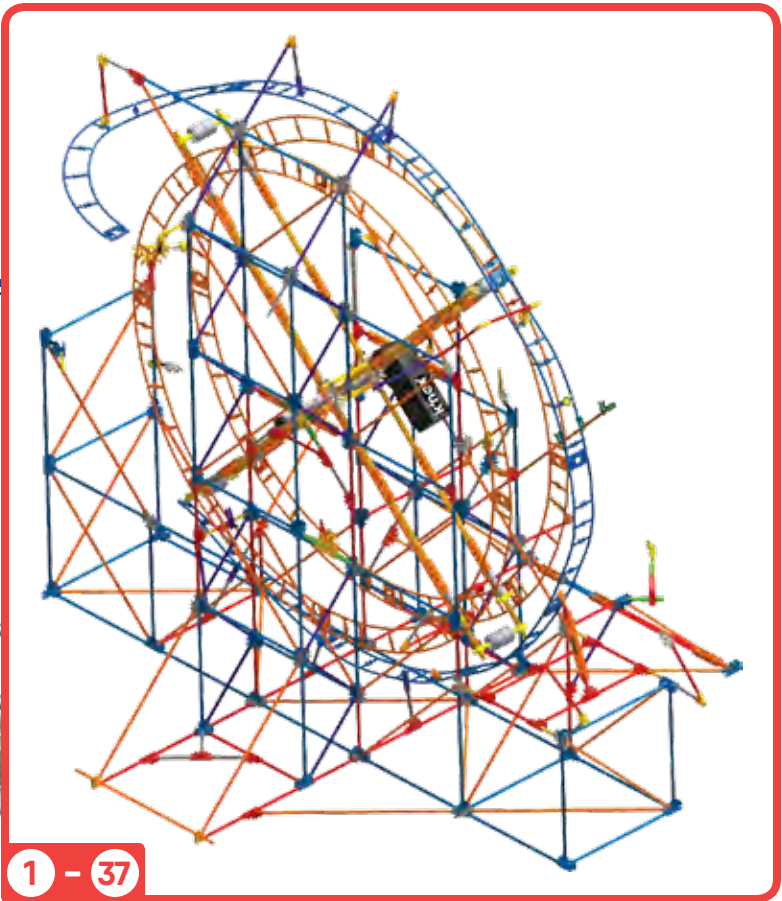

38

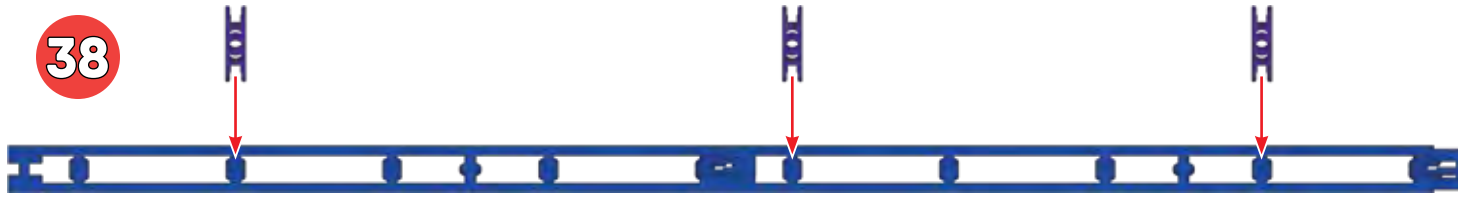

39

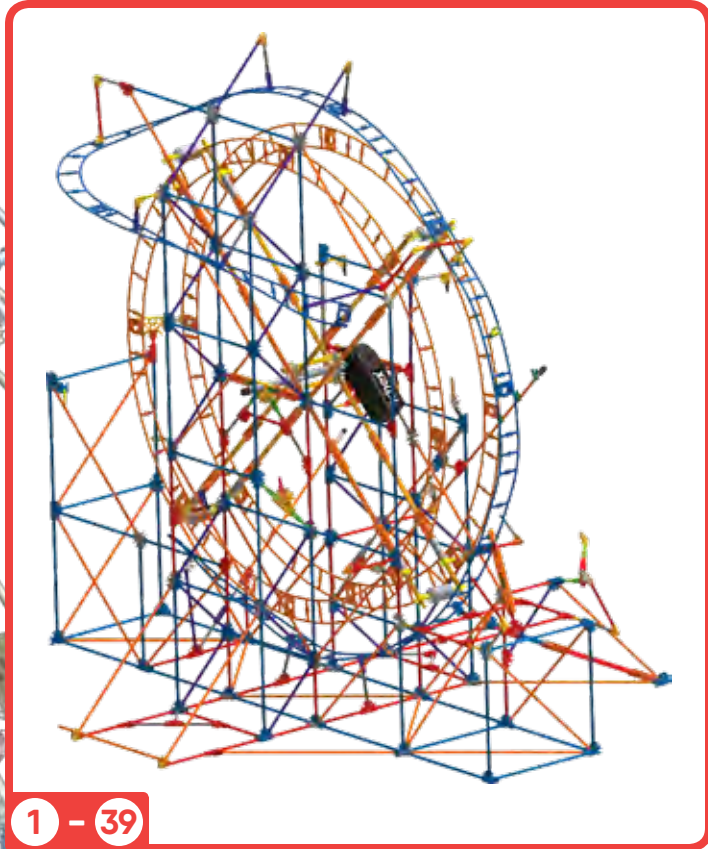
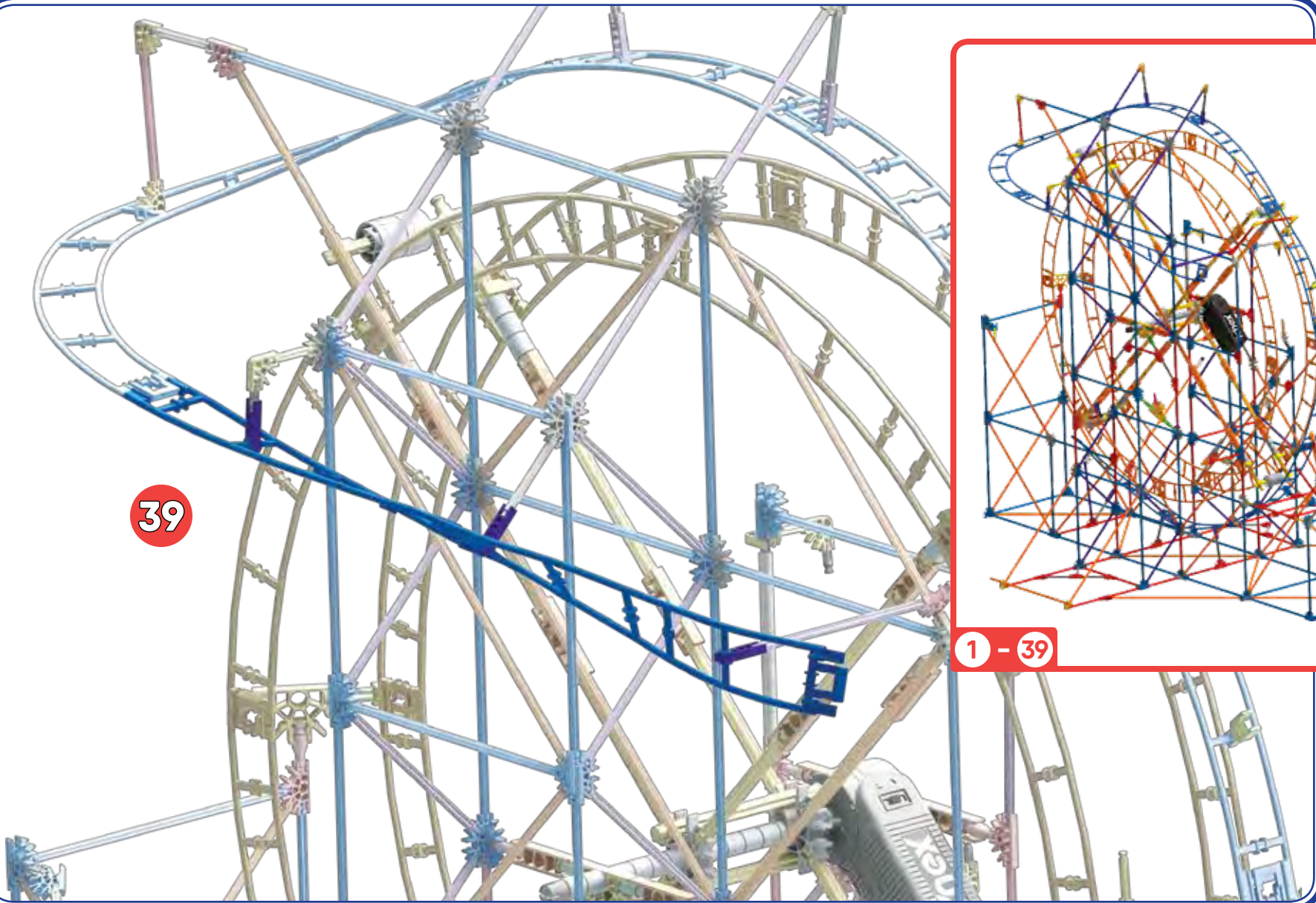

1 - 39

40

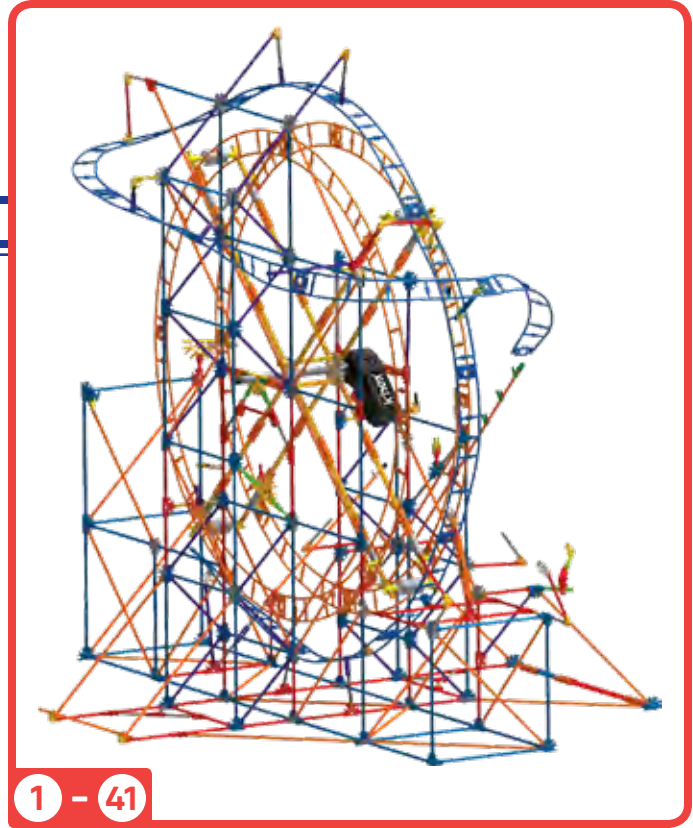

1 - 41

41



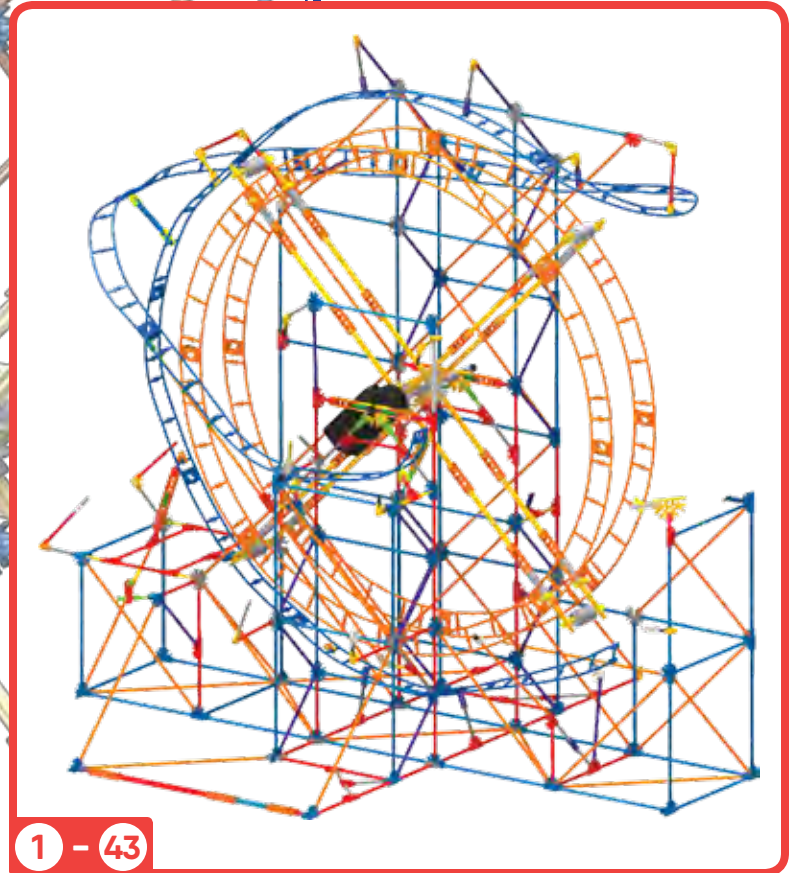
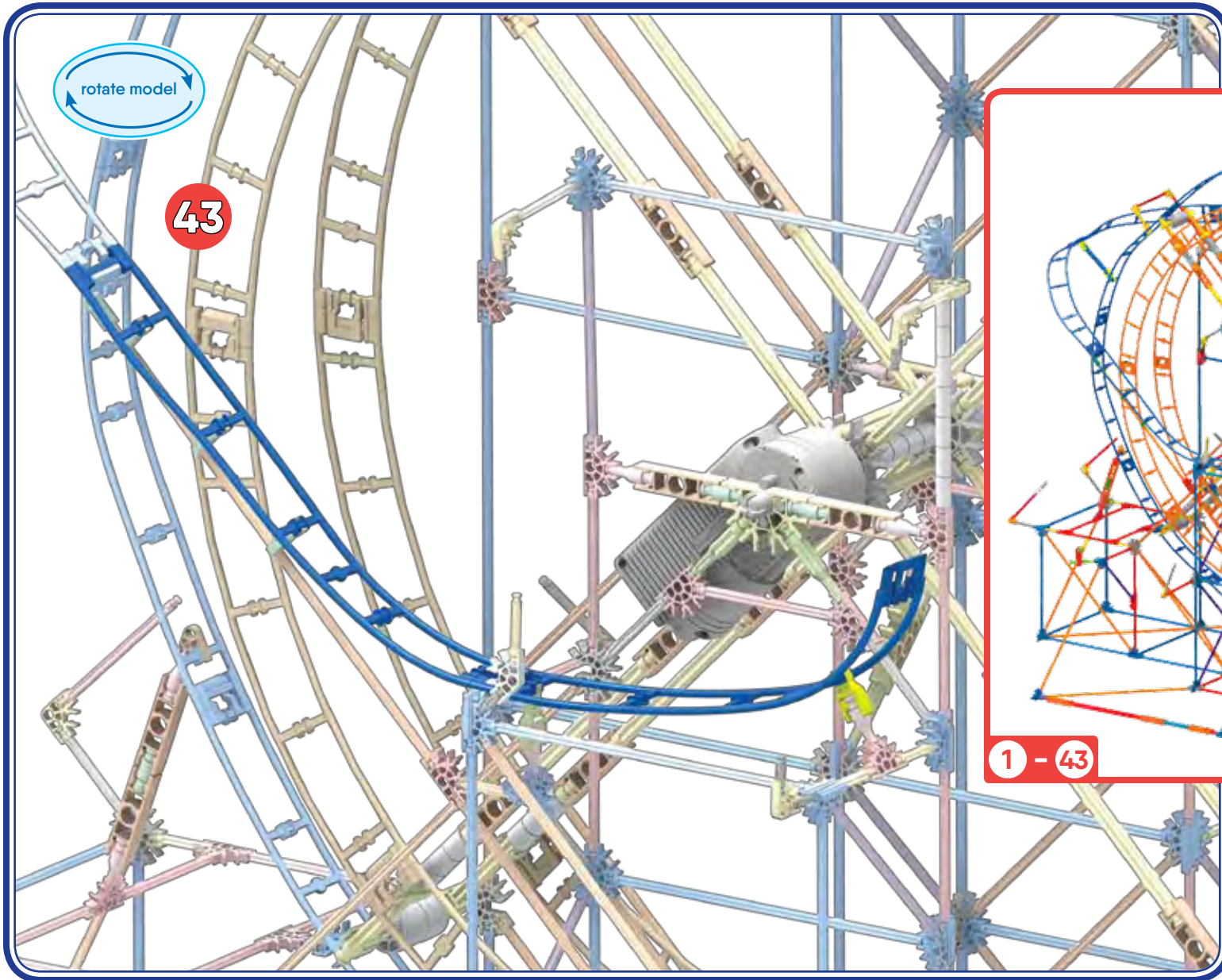
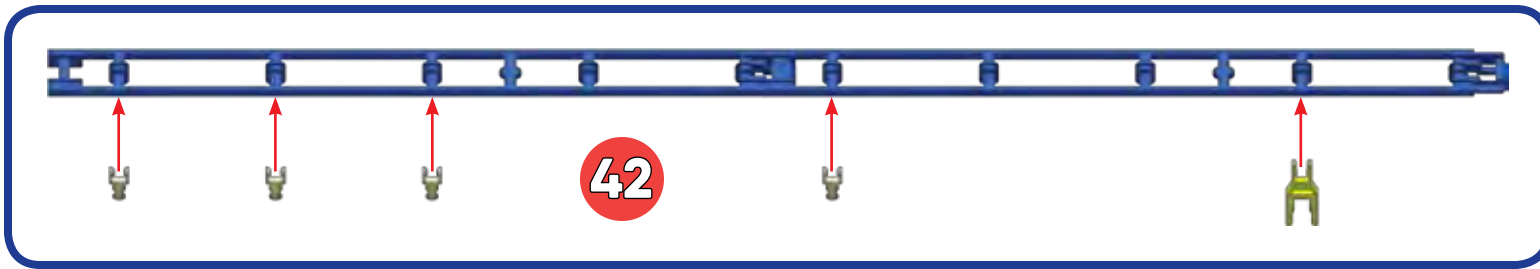

44

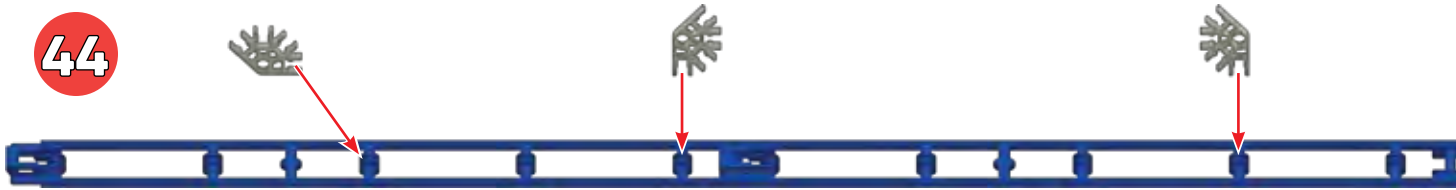

45

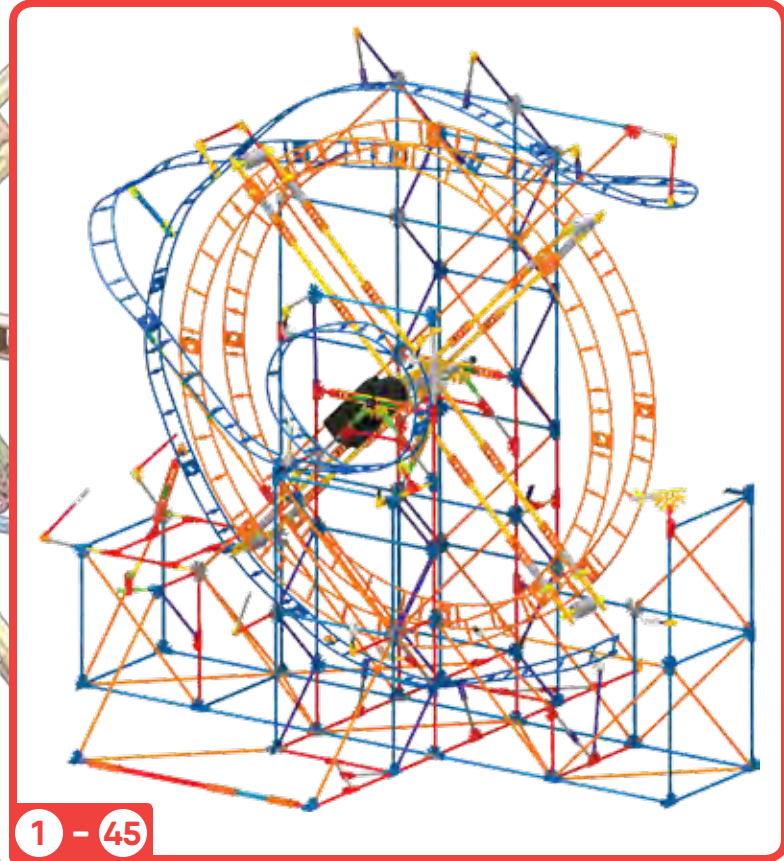
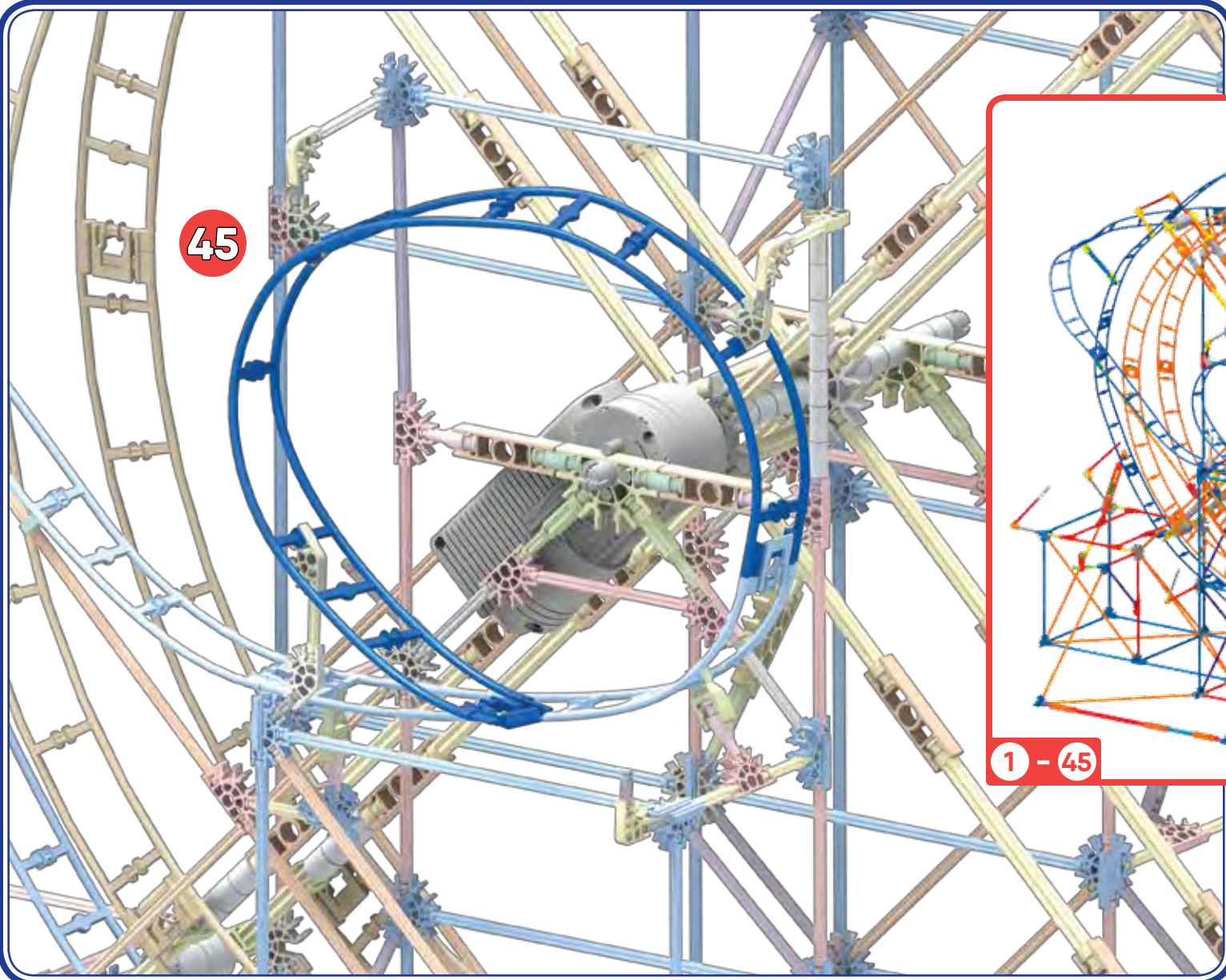

1 - 45

46

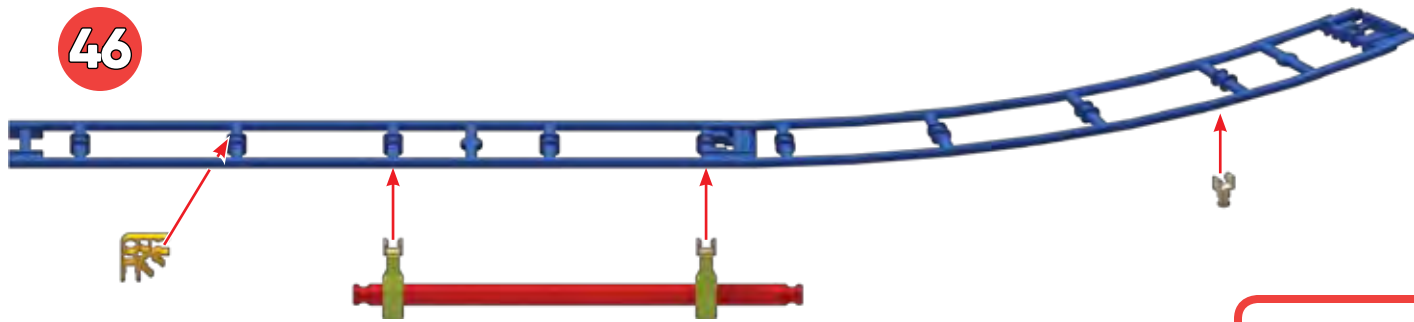

47

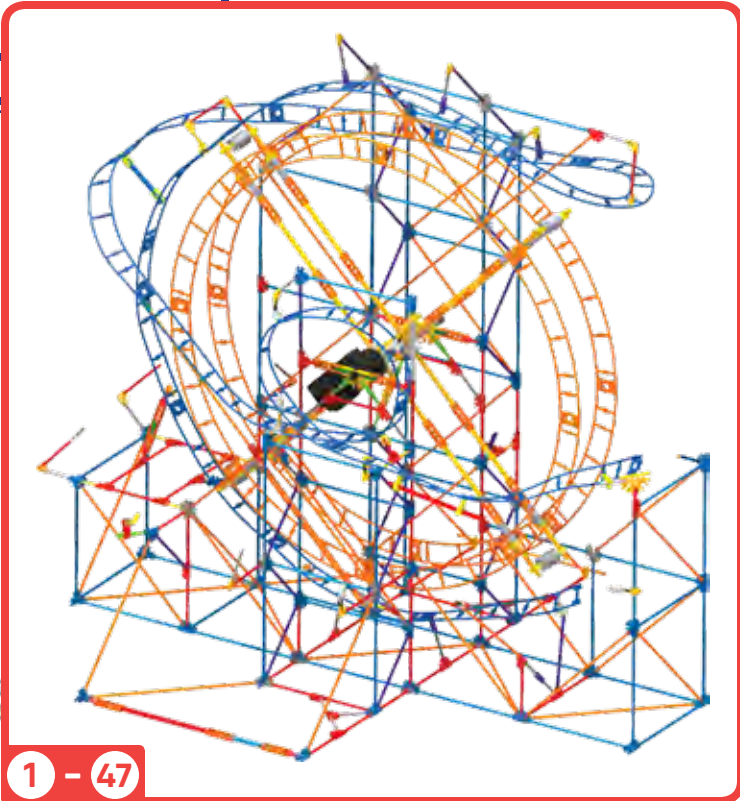
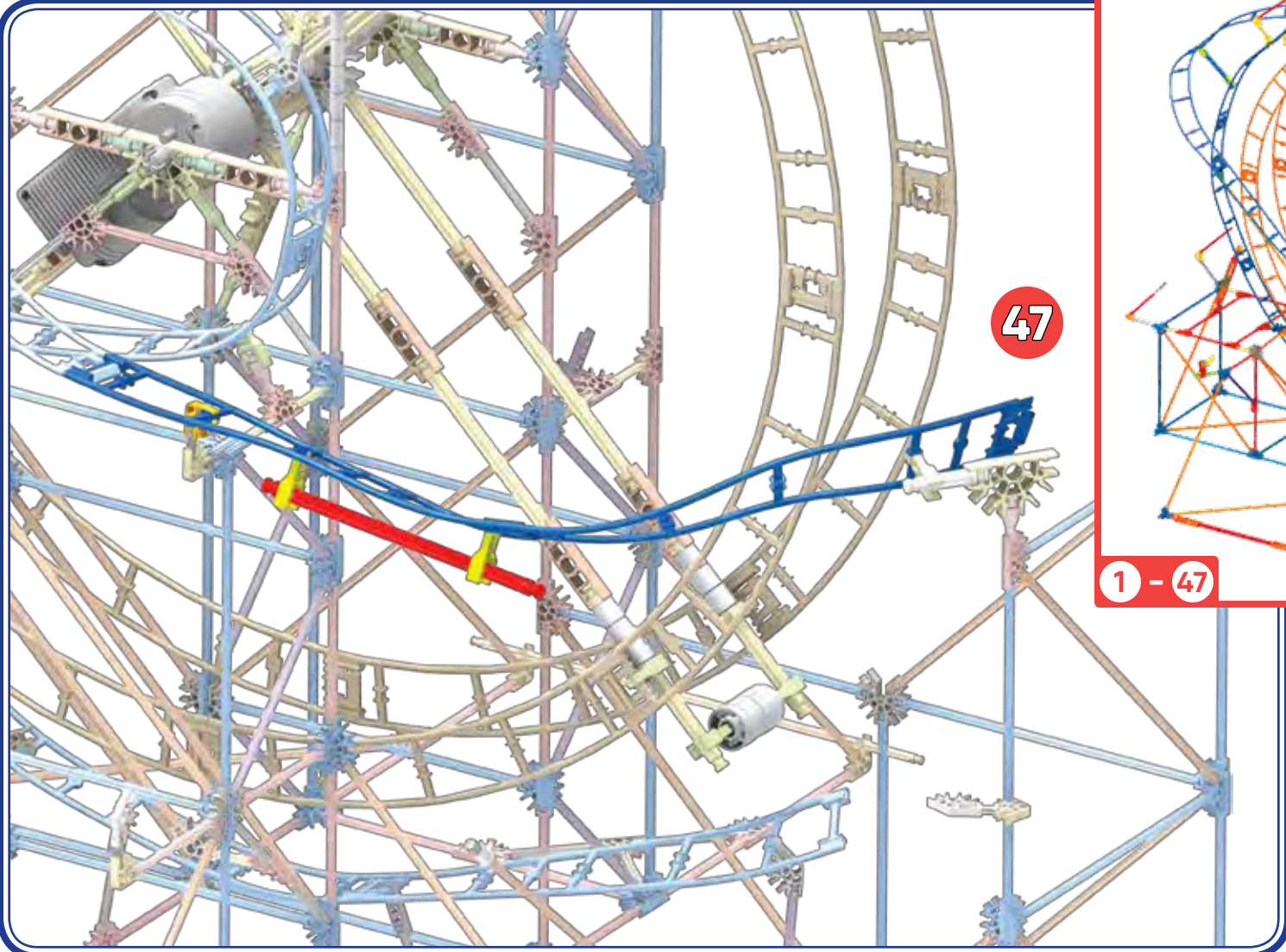

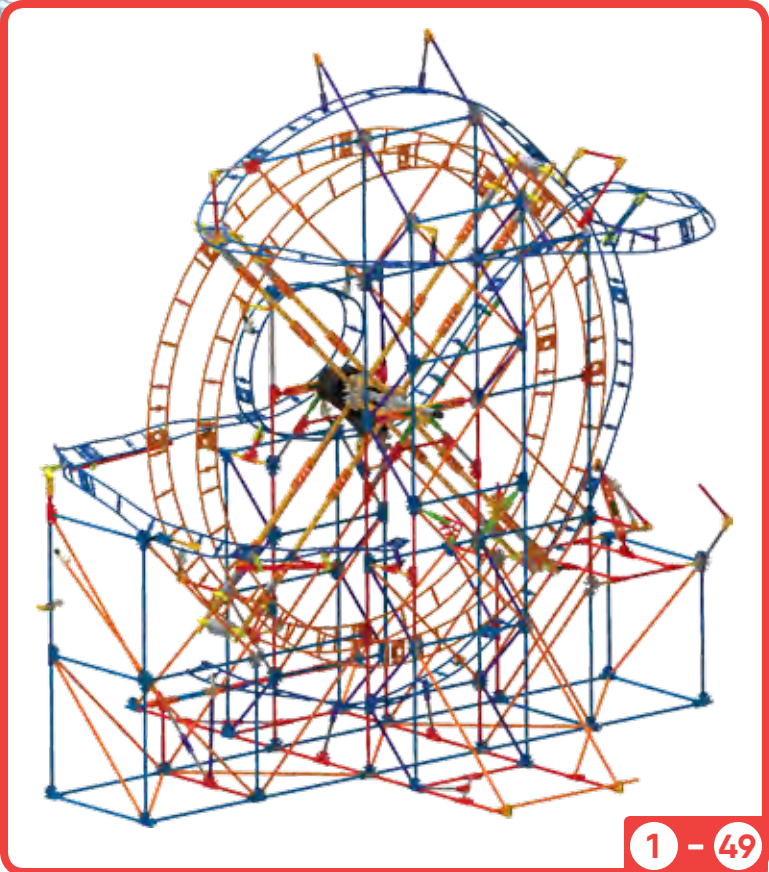
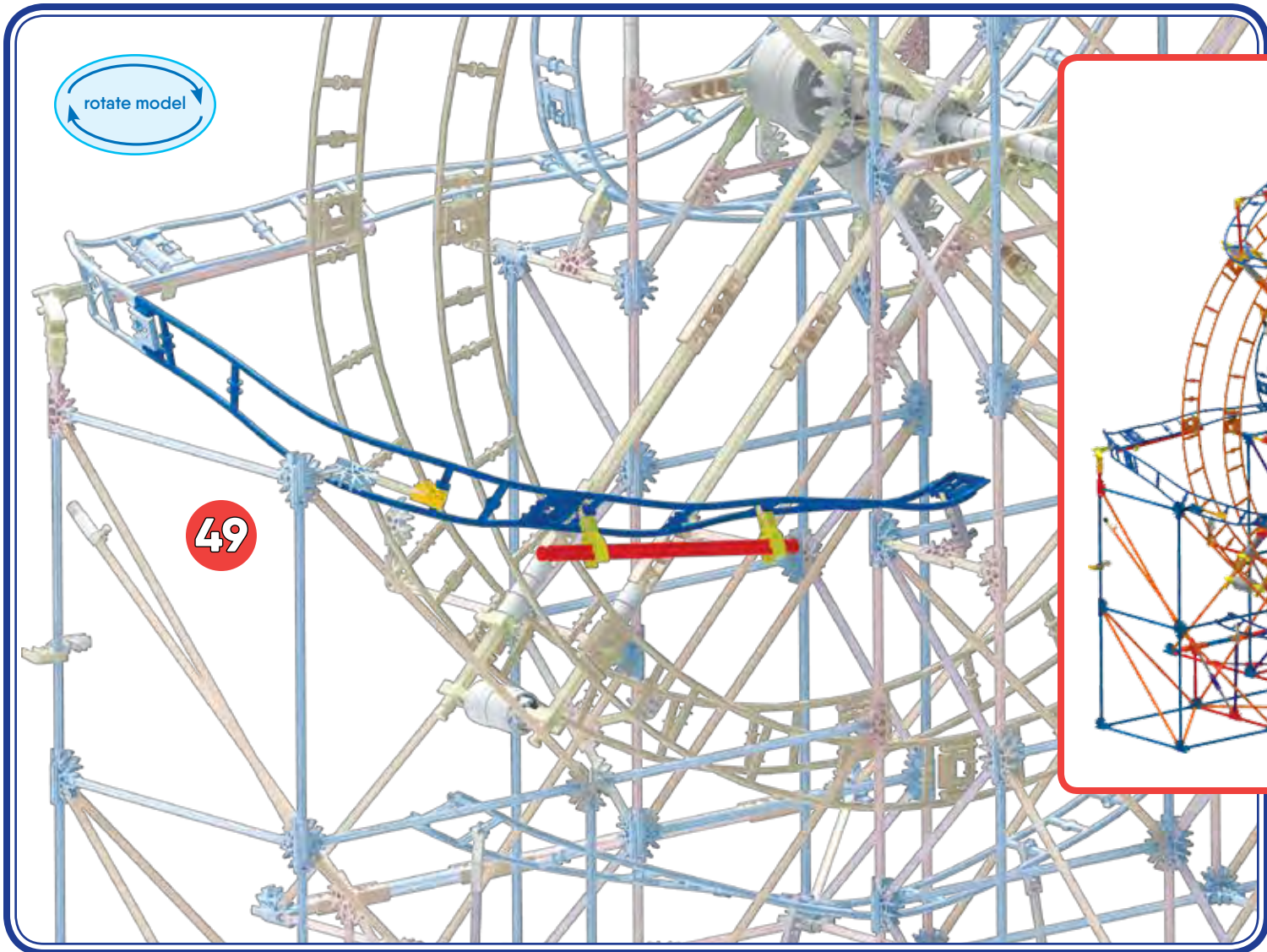
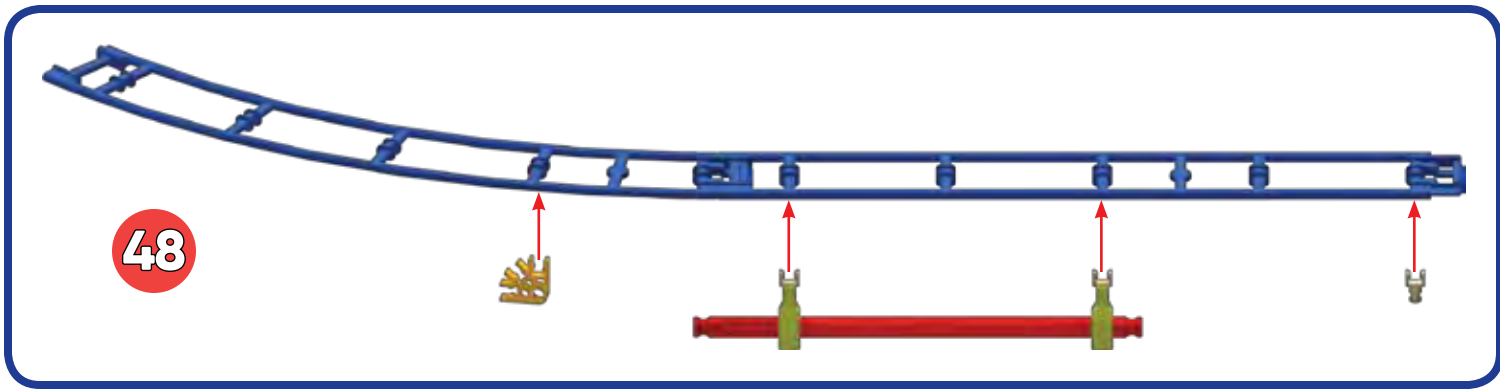

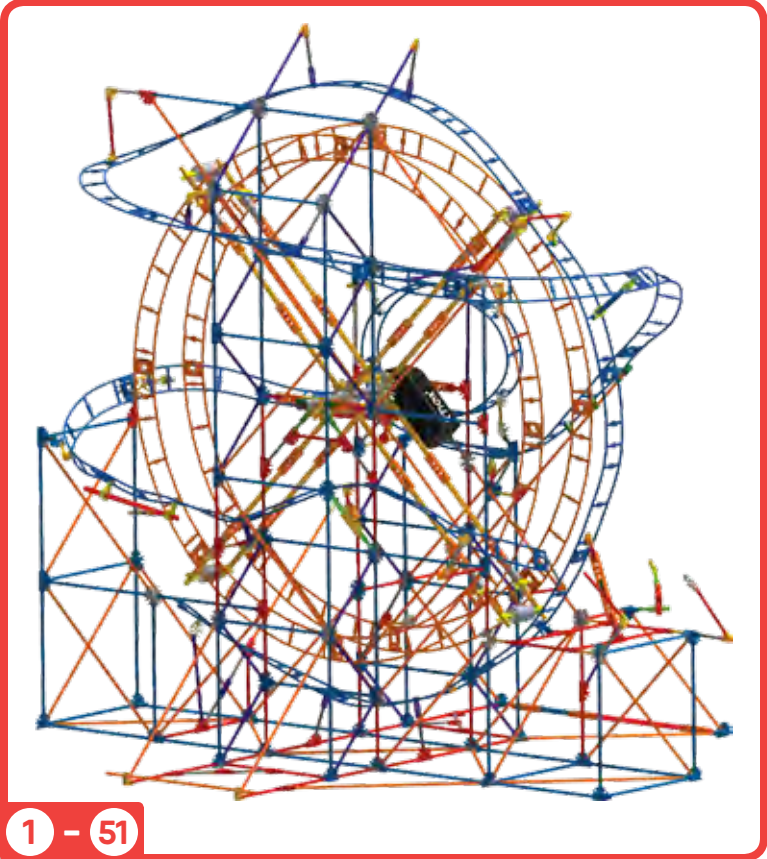
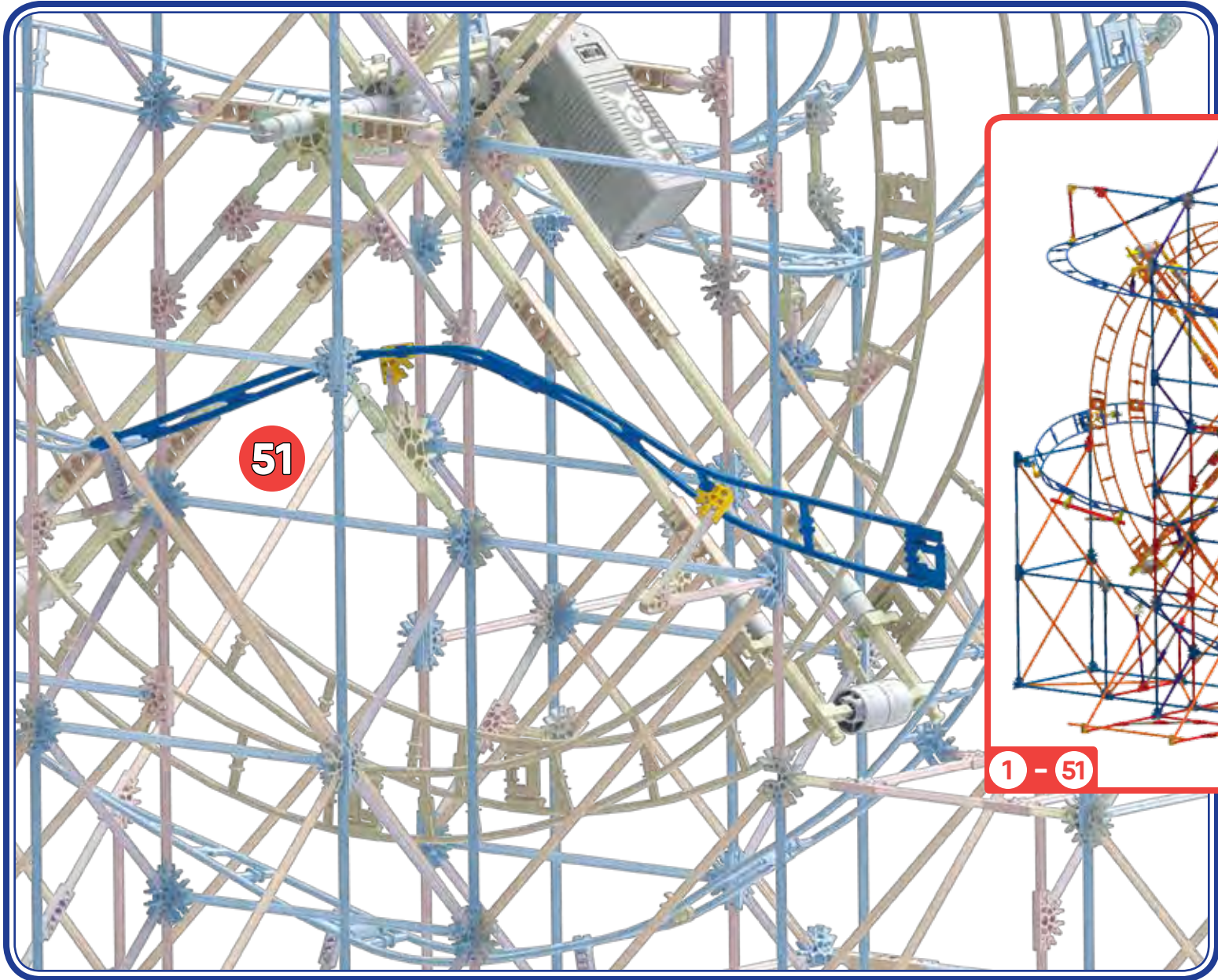

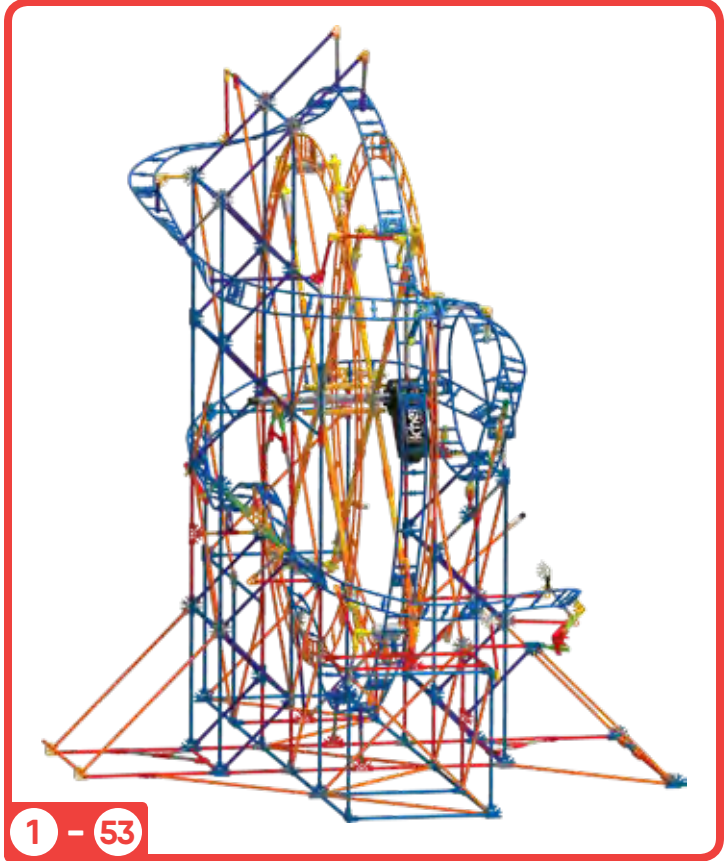
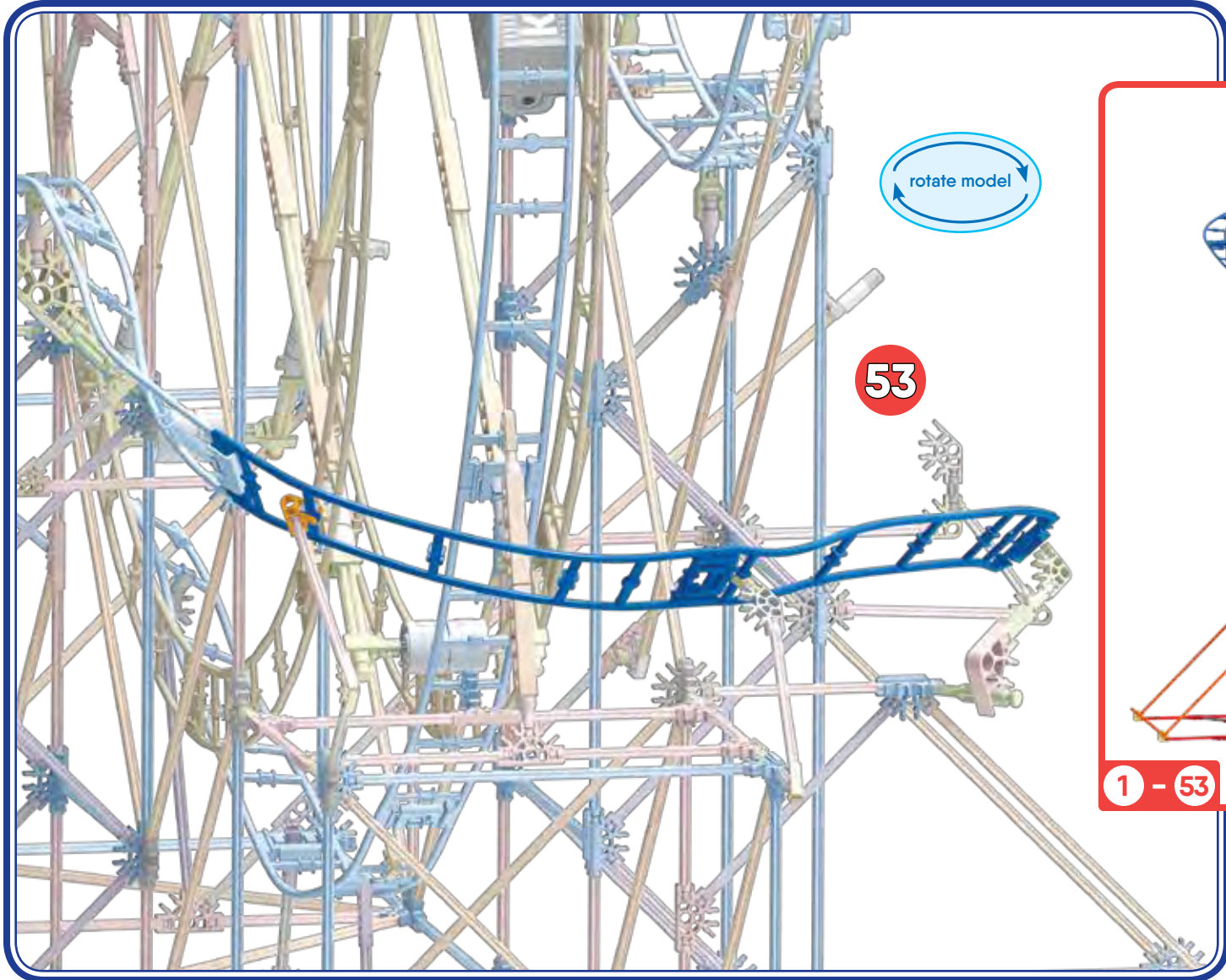
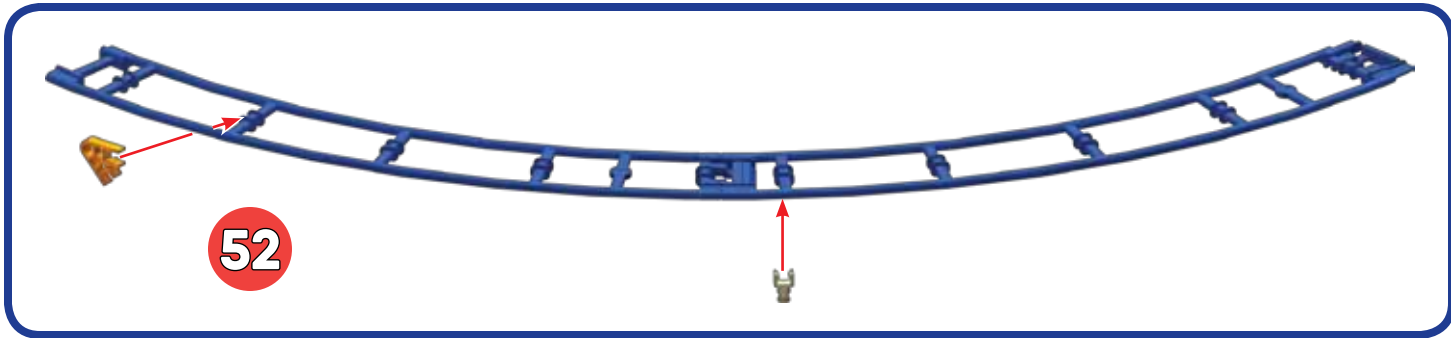

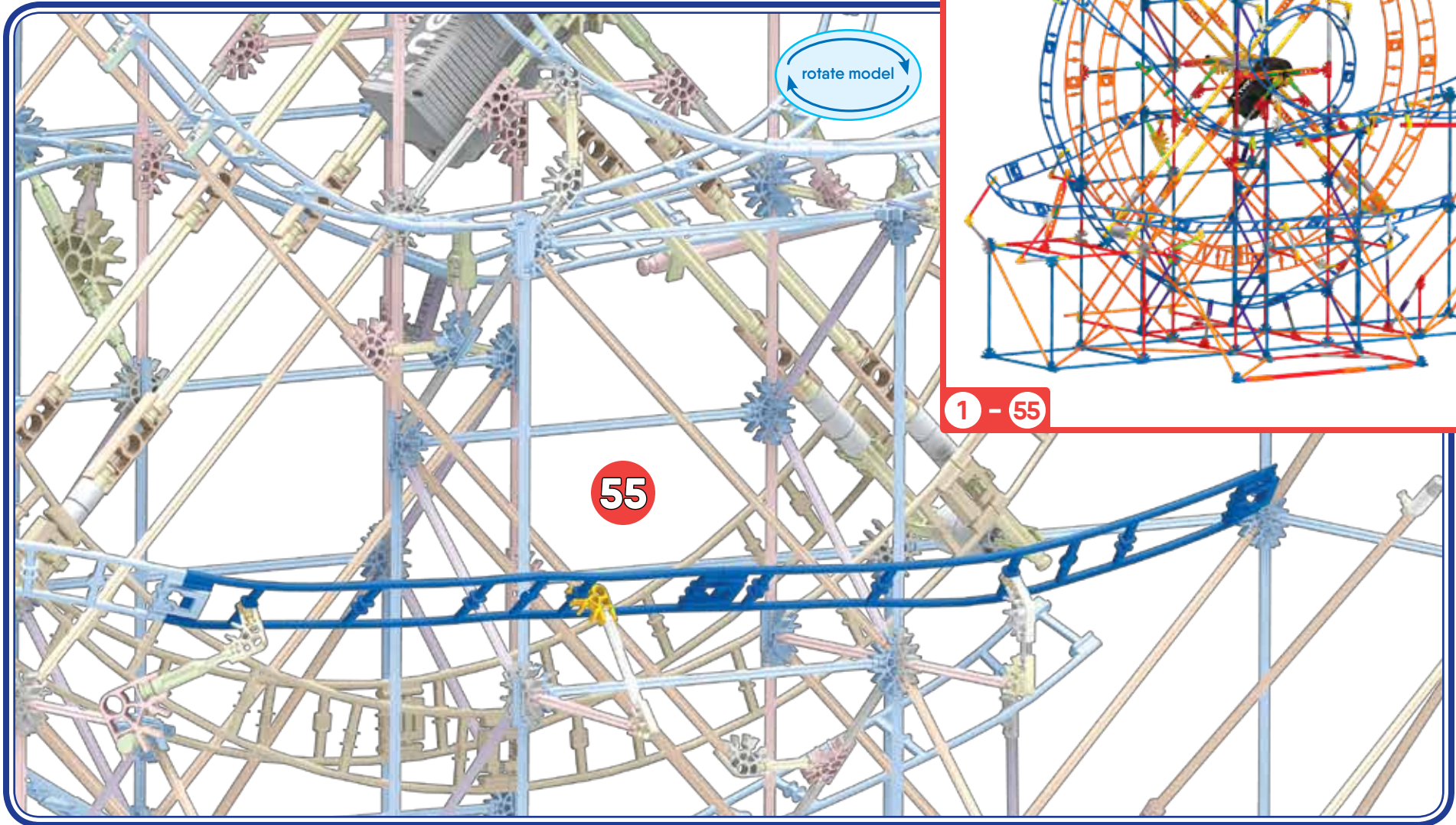
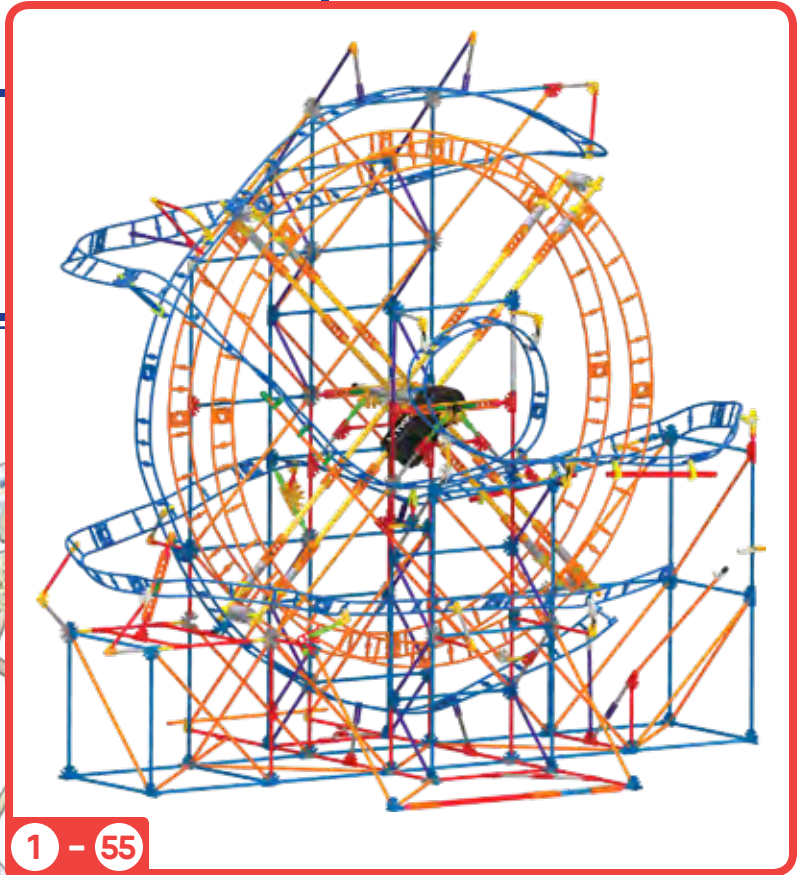
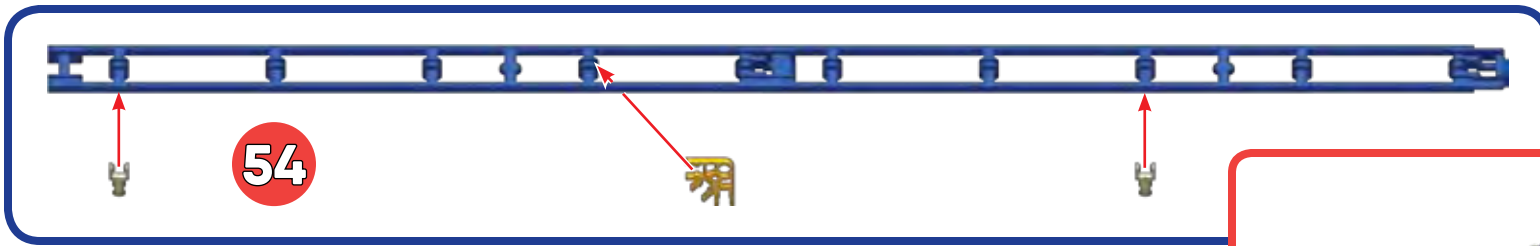

56



57

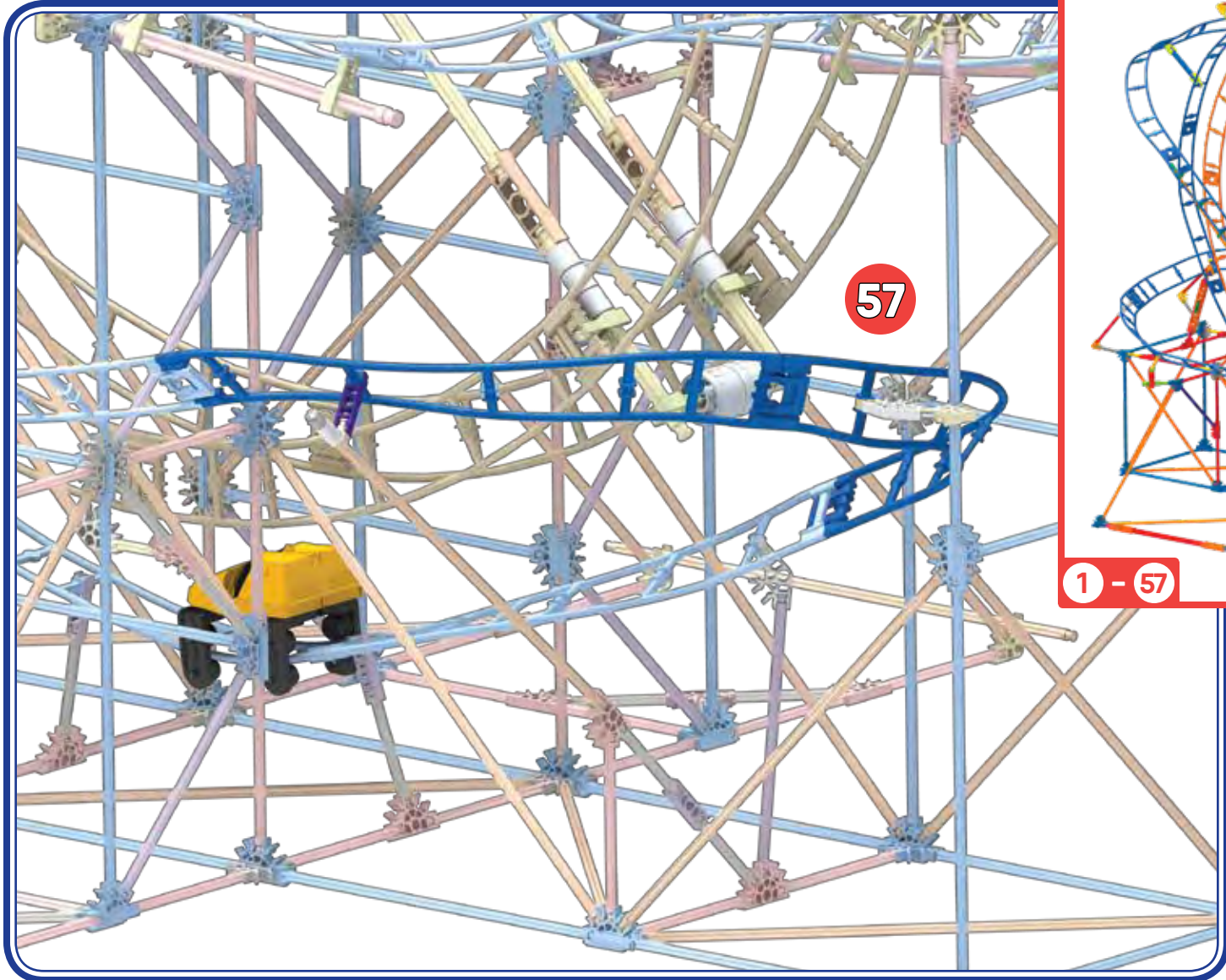

1 - 57

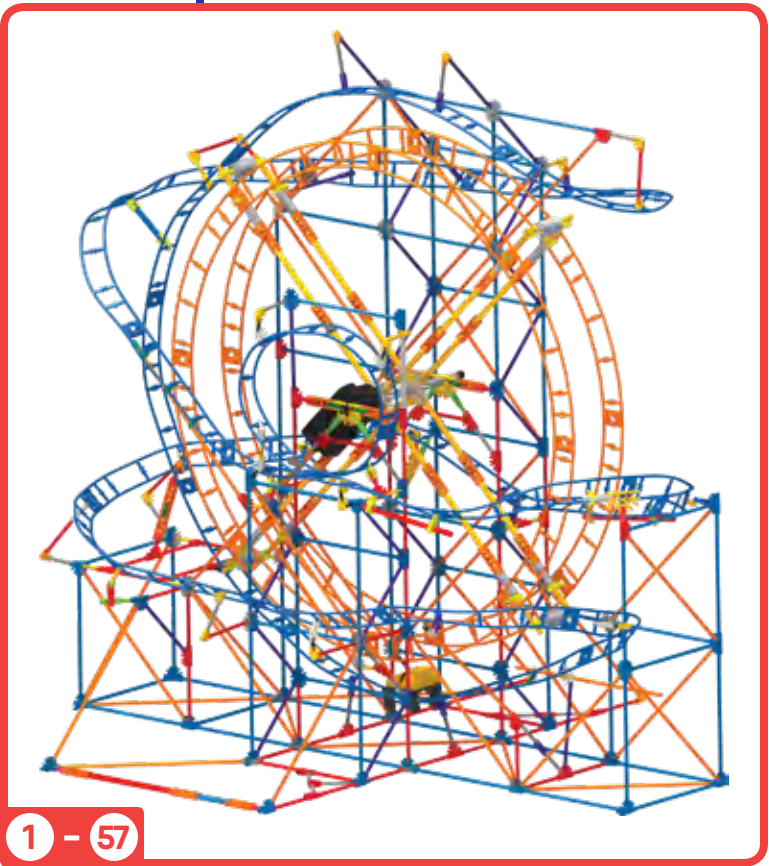

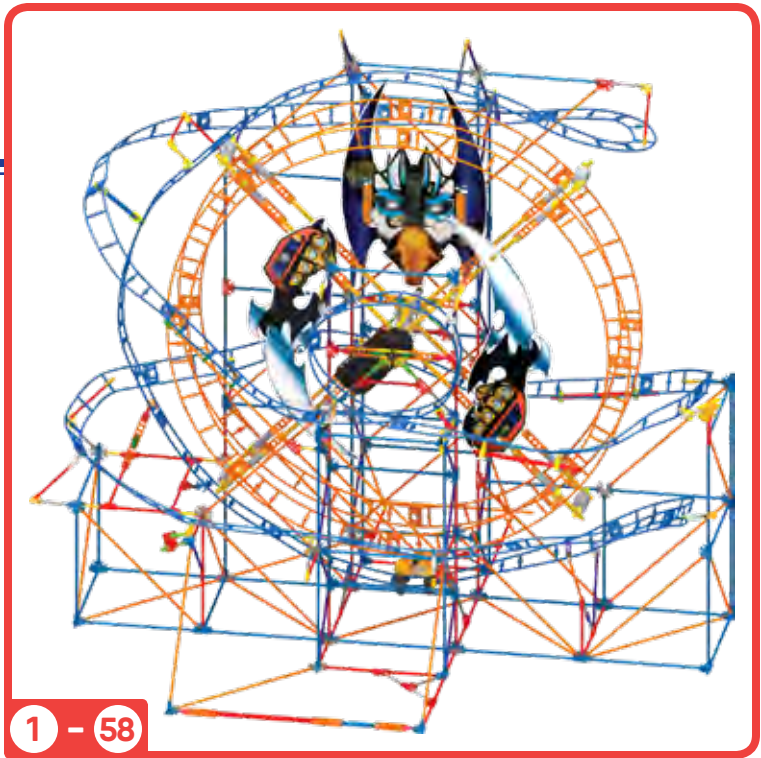
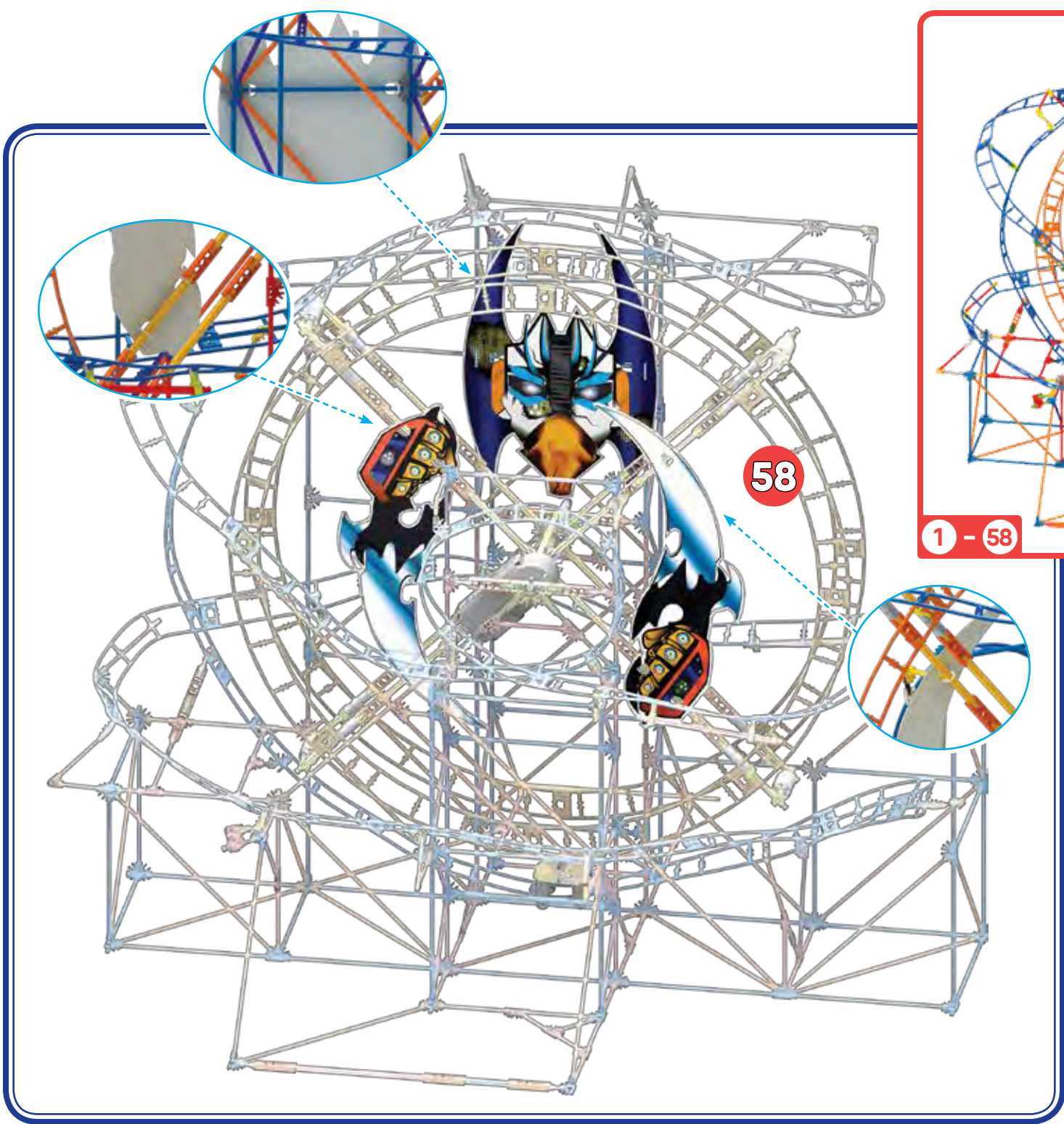

**k'nex**  
**SUPER CYBORG**  
Additional Build