

BIO RACER

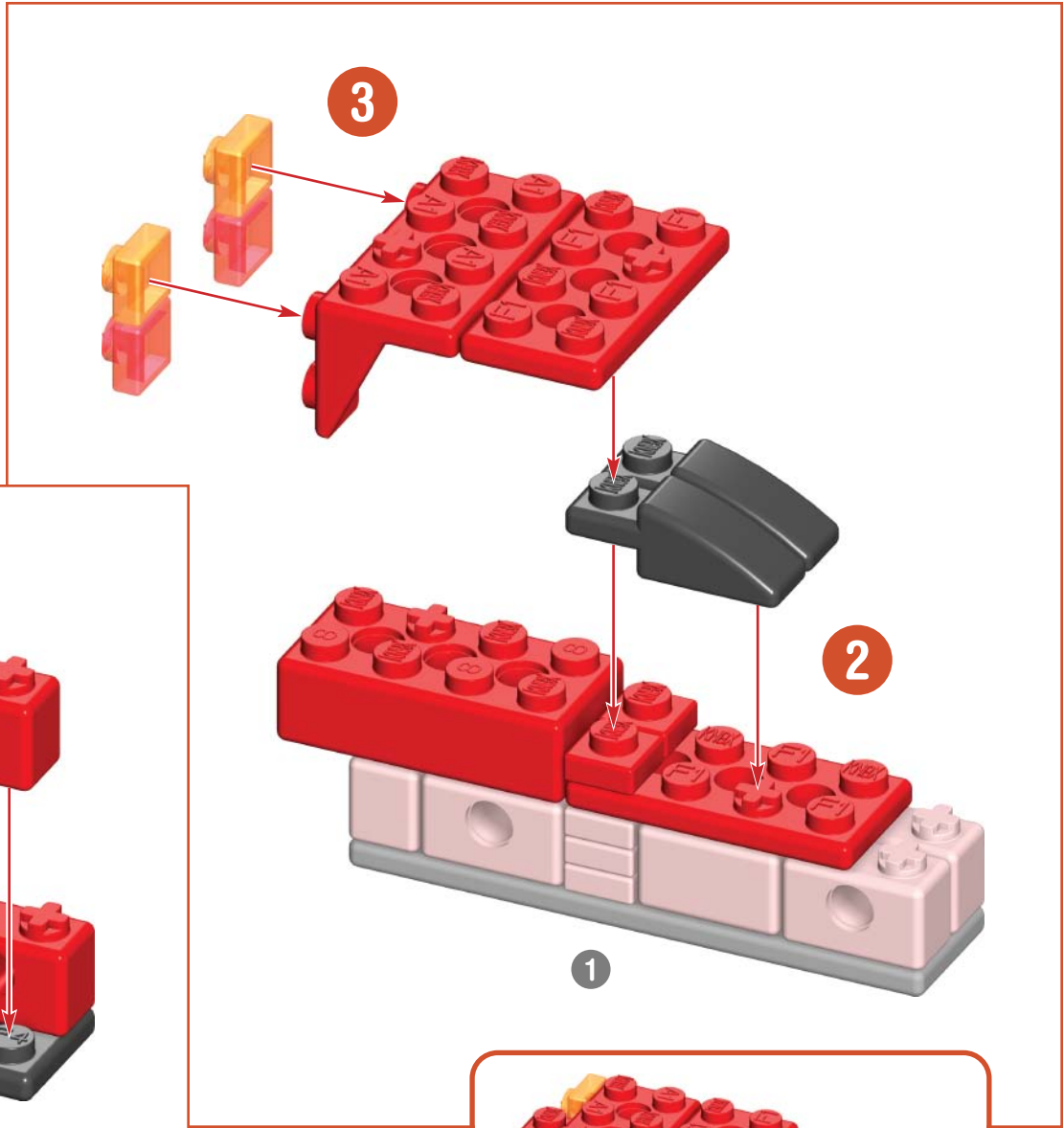

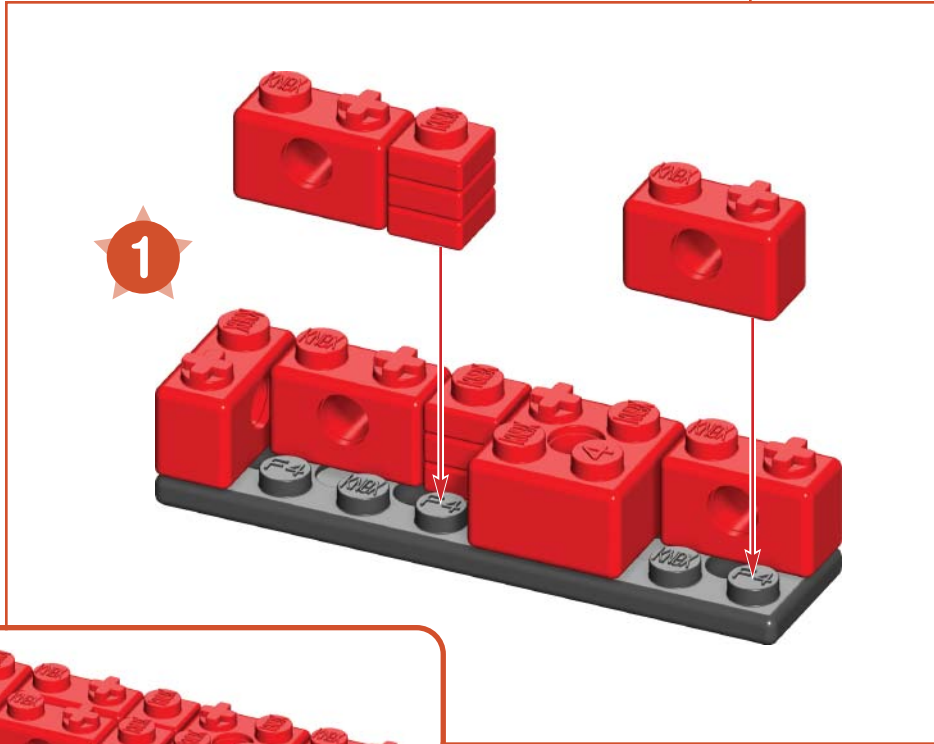

INDY STREETER

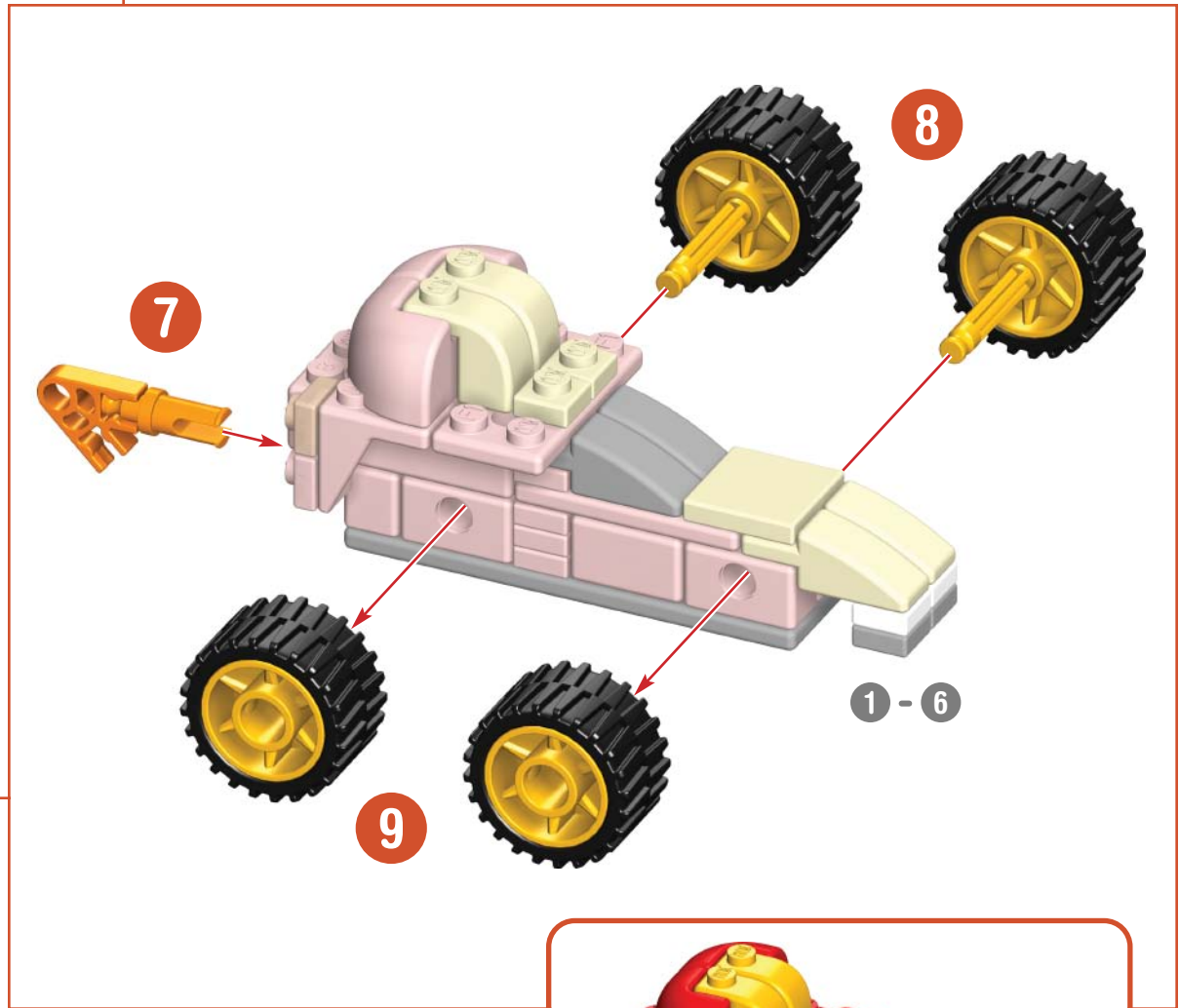
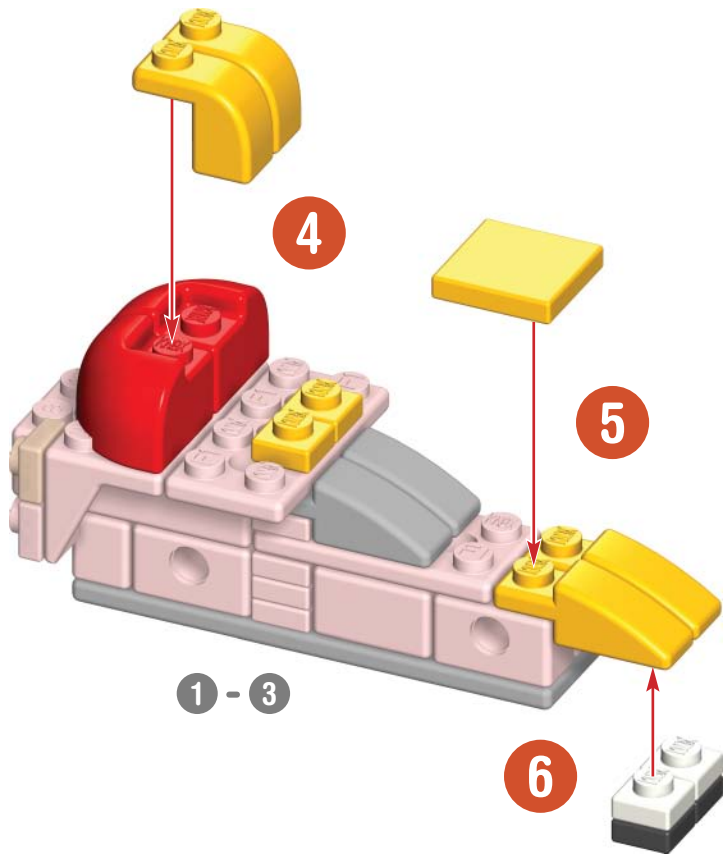
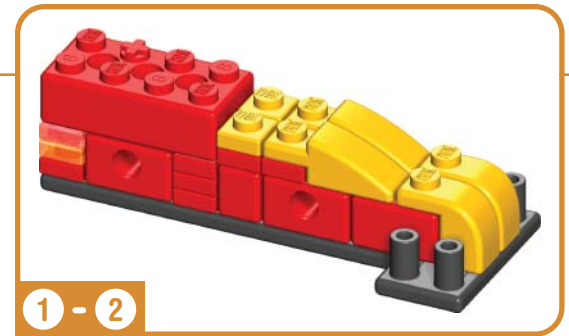
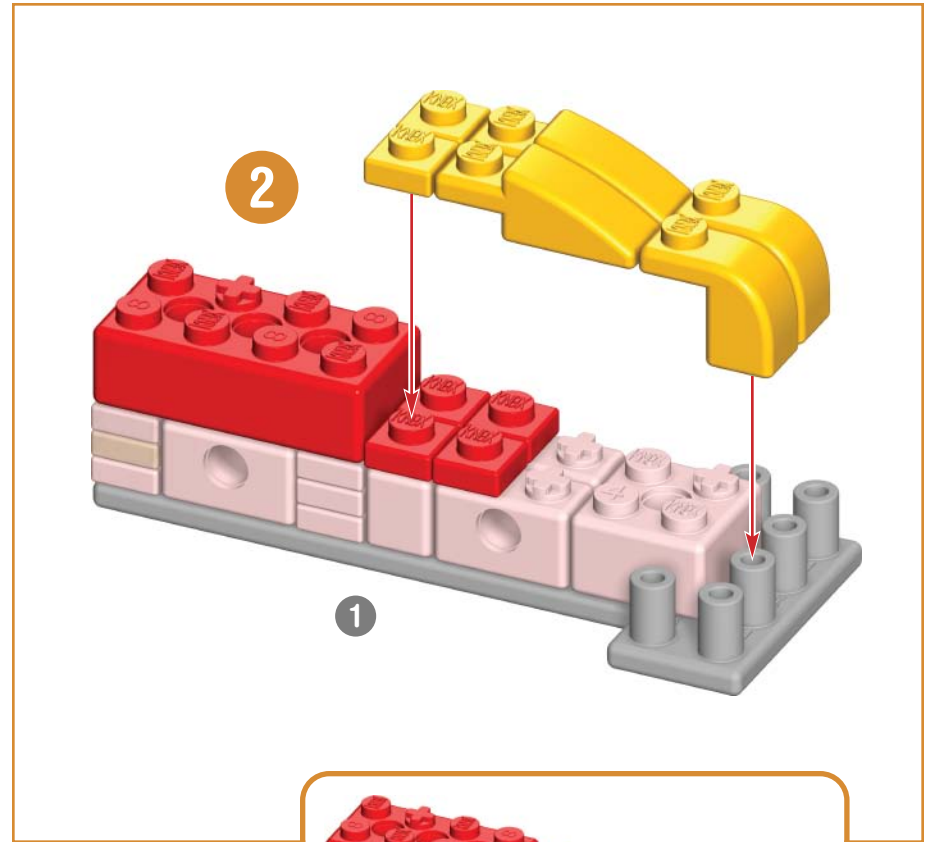
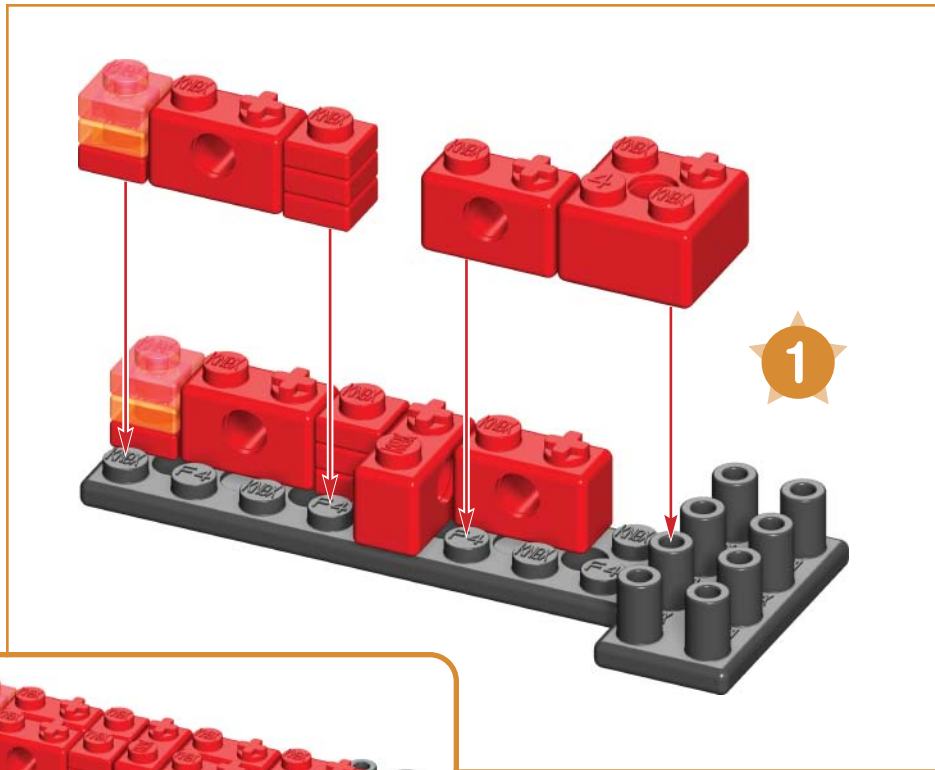

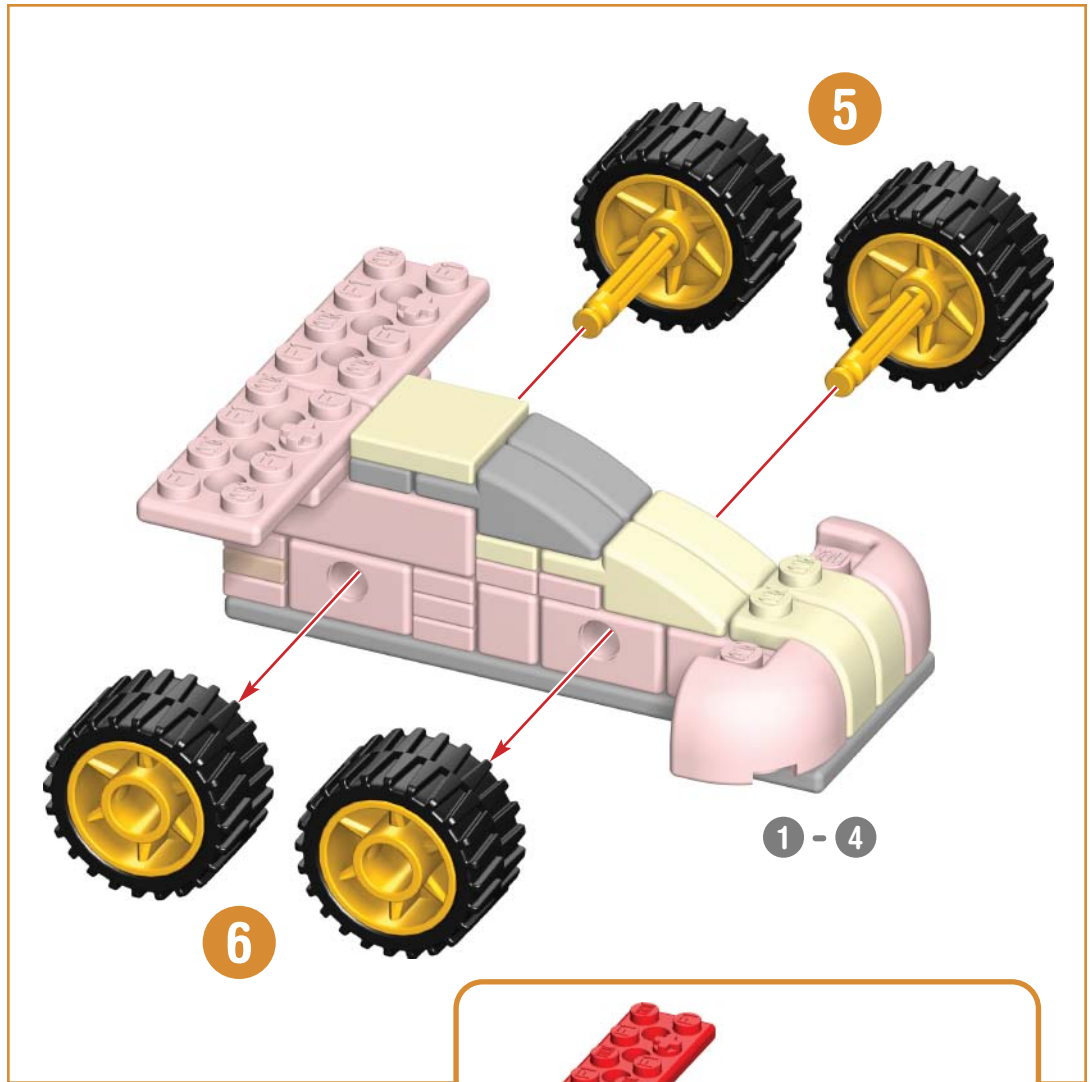
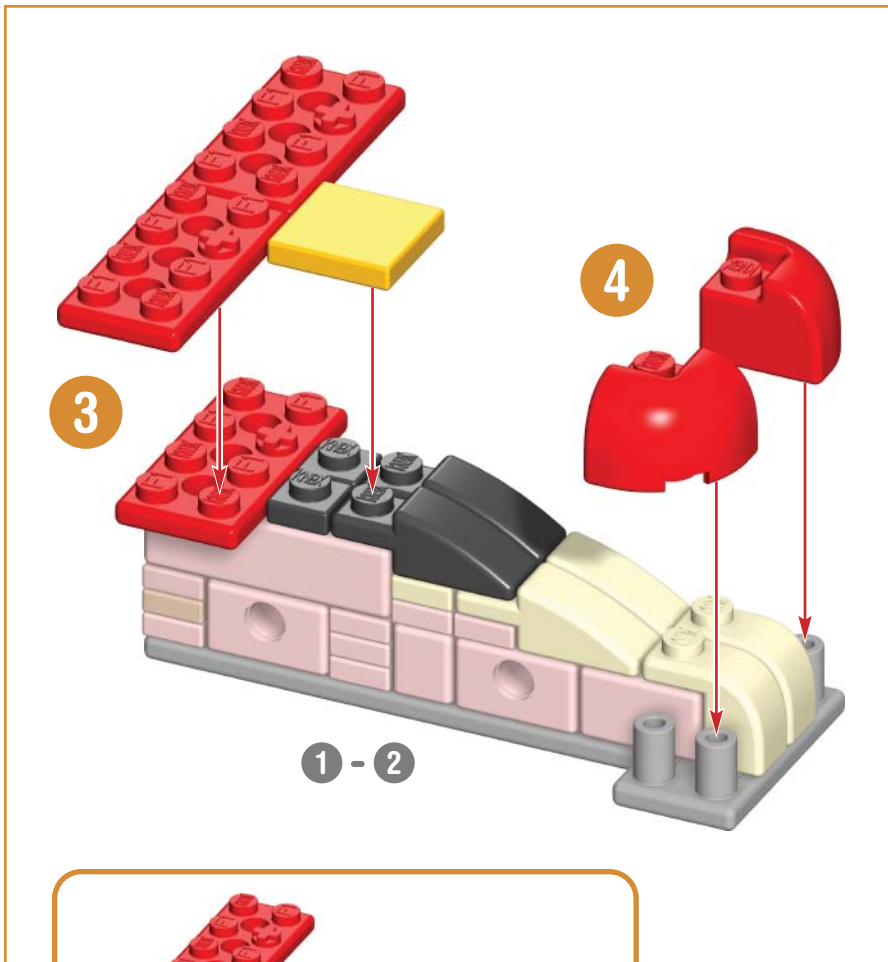

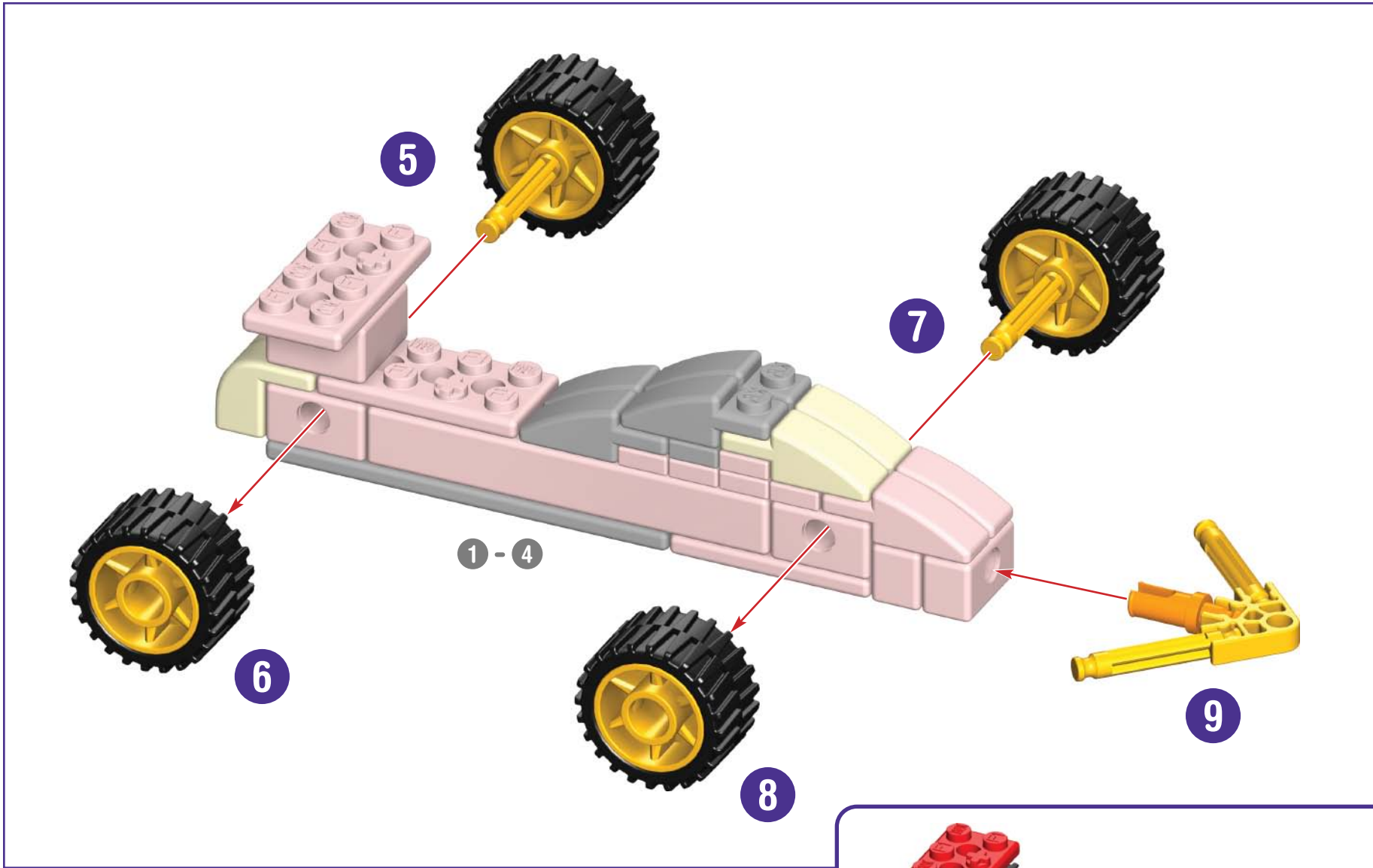

MX-3

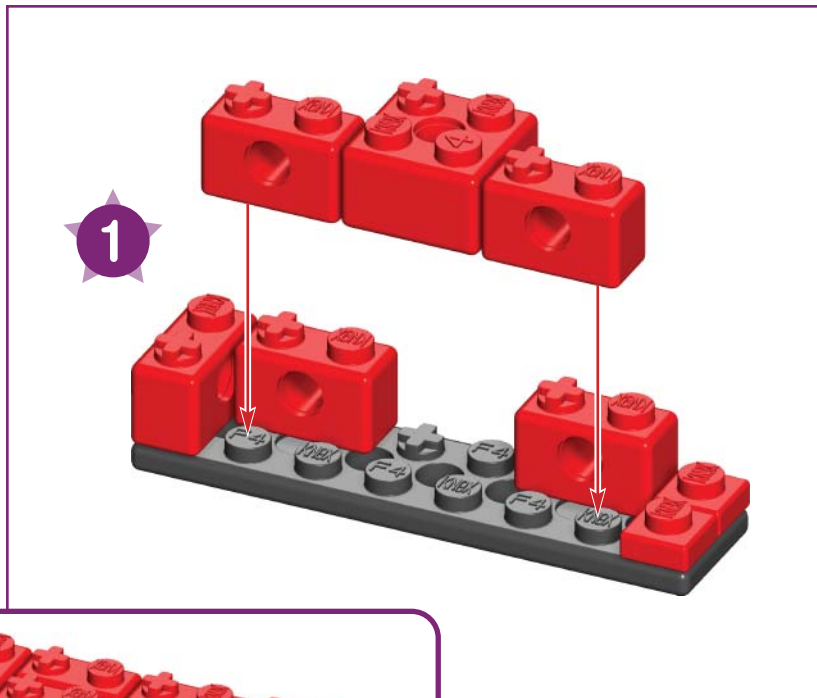

1

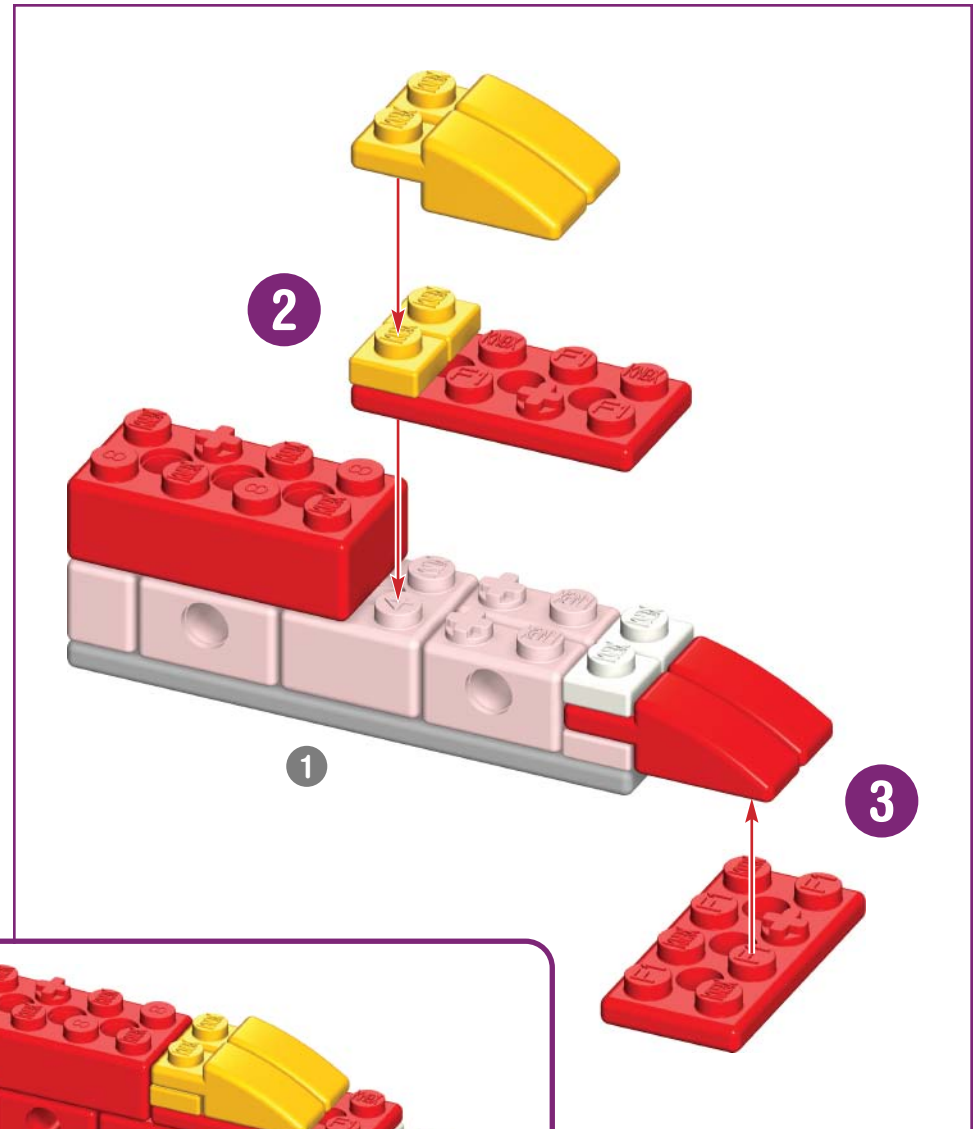

1 - 3

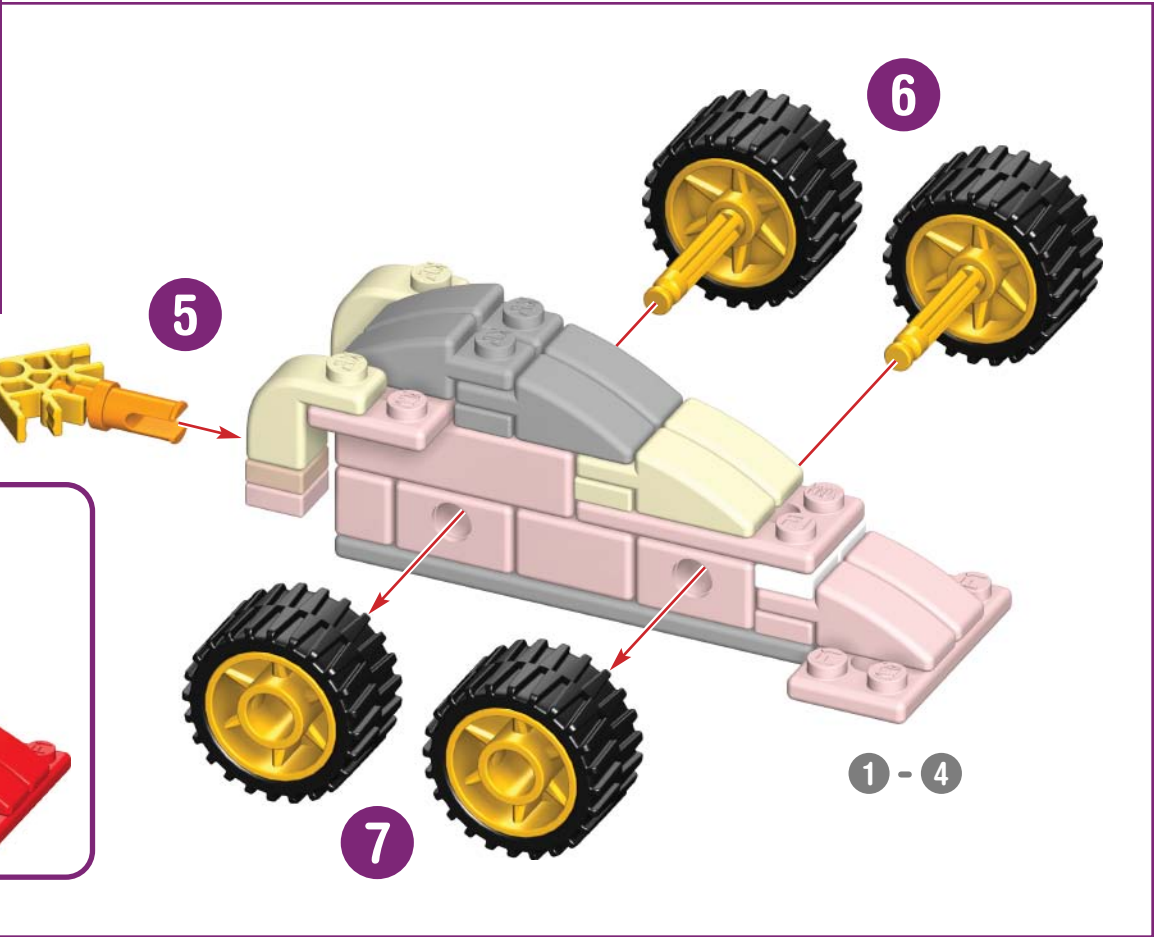
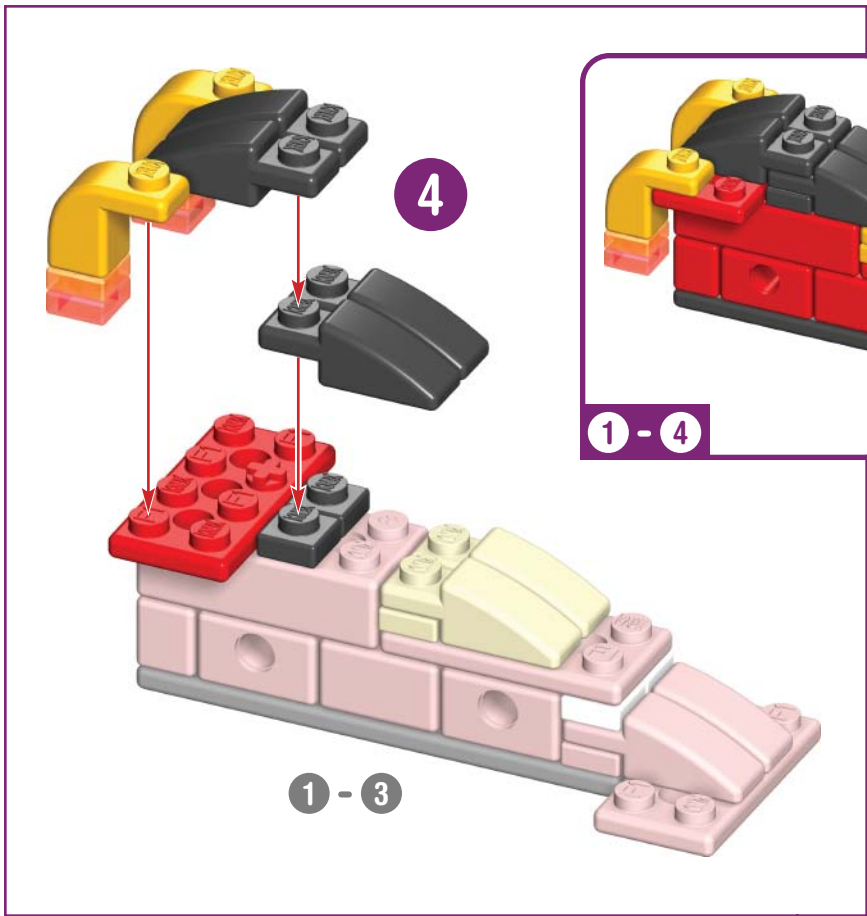

NITRO SPRINTER

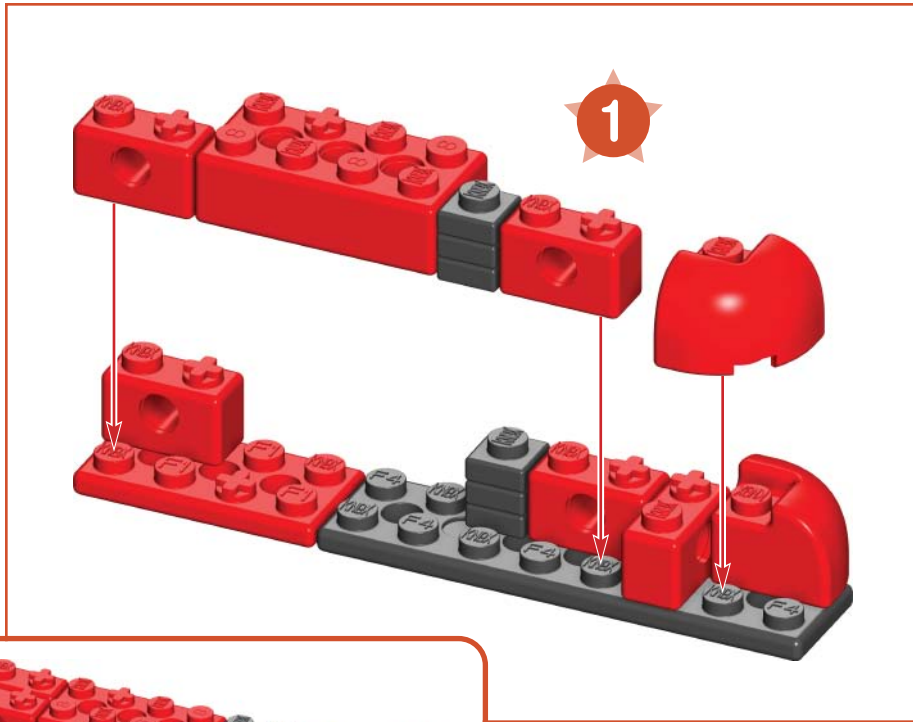
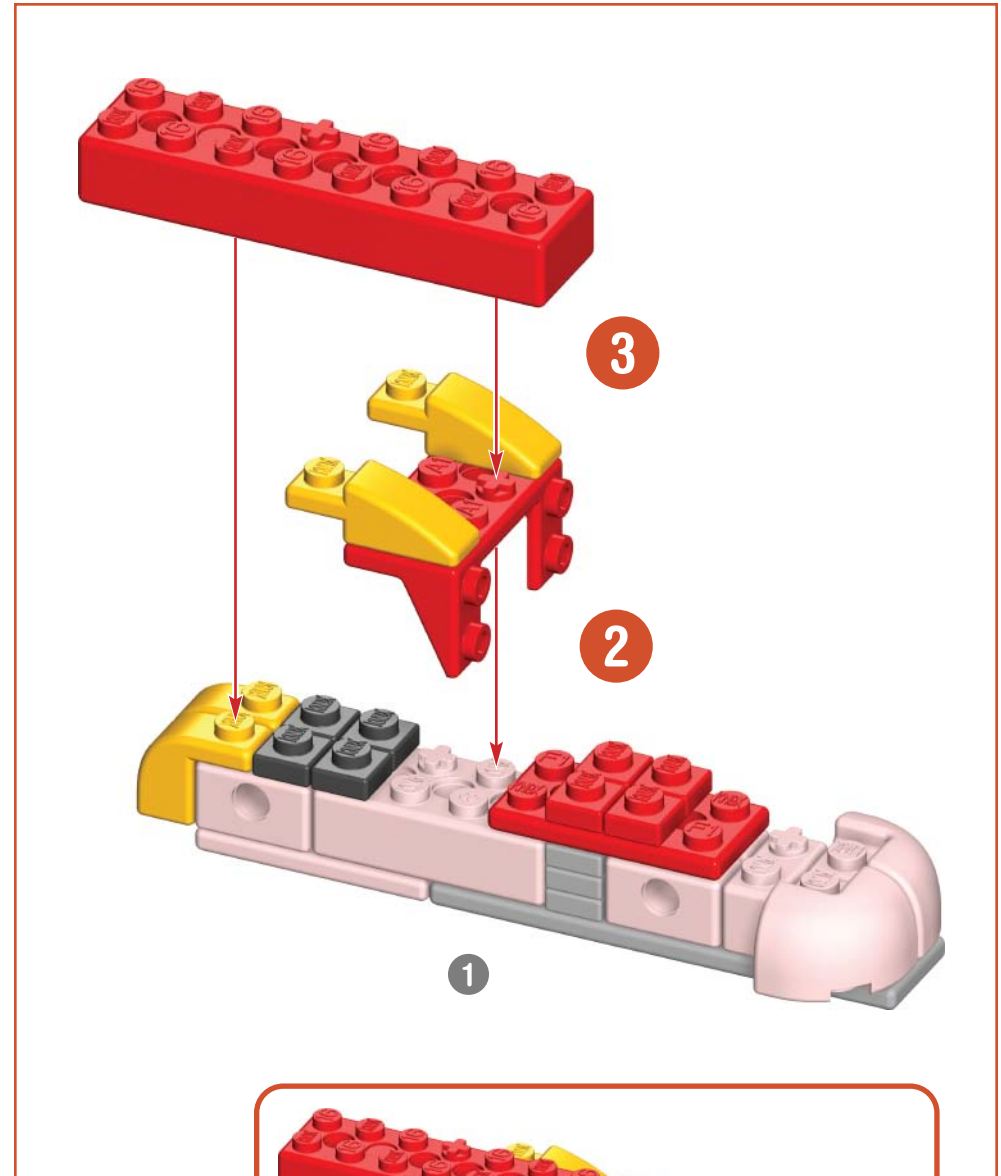

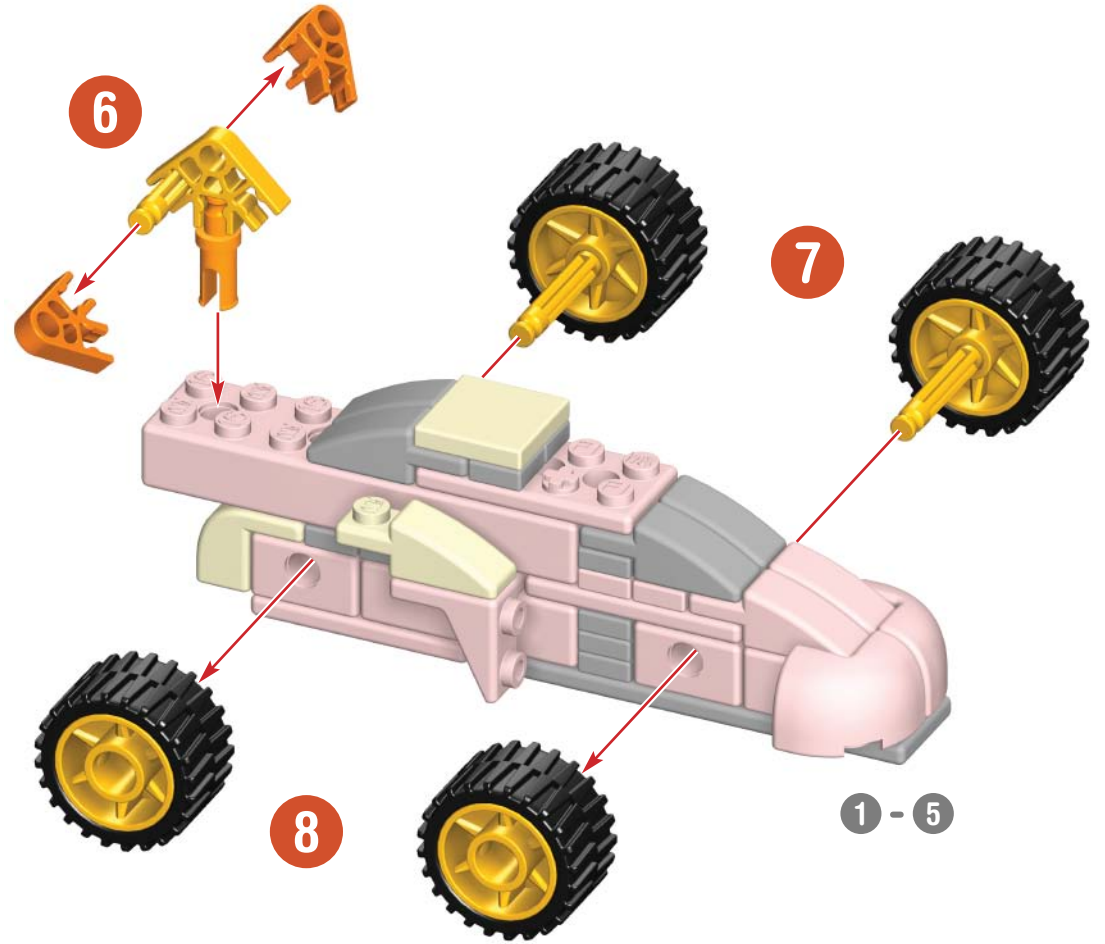
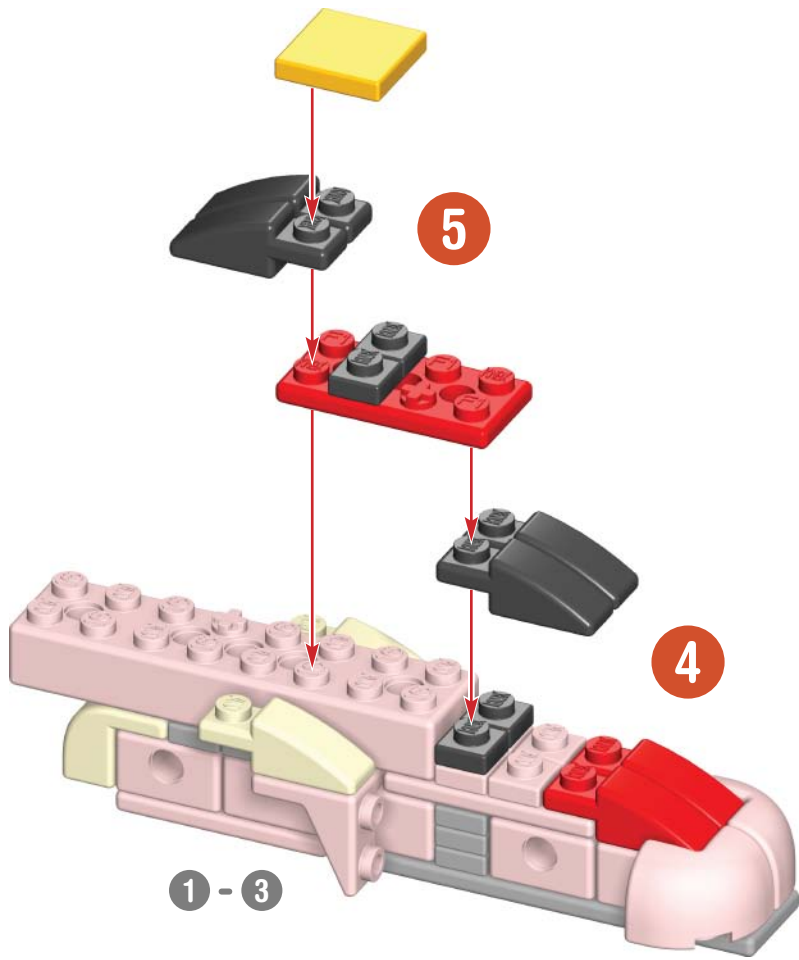



RALLY X

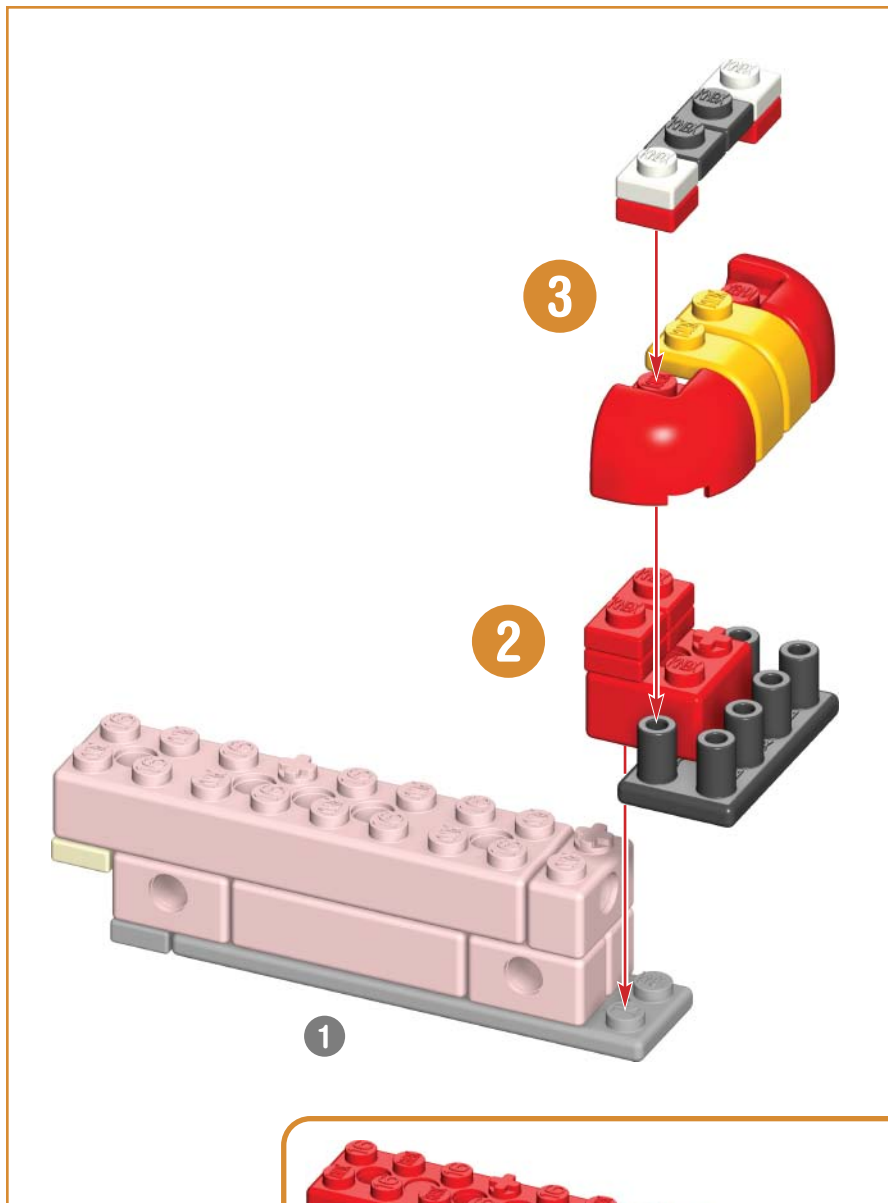
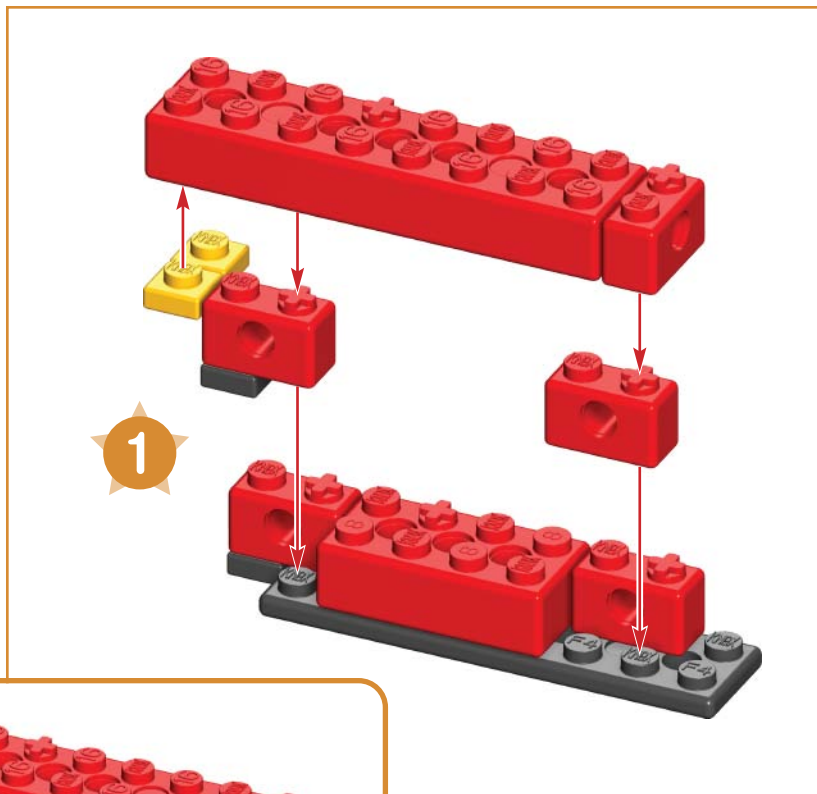

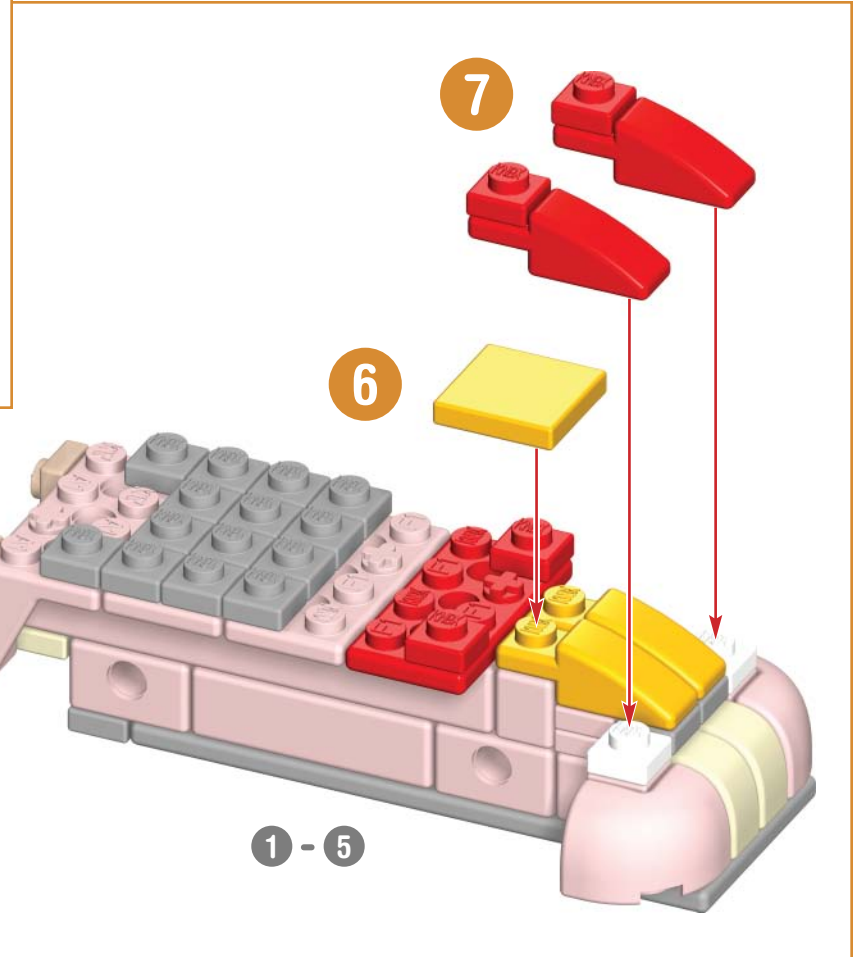
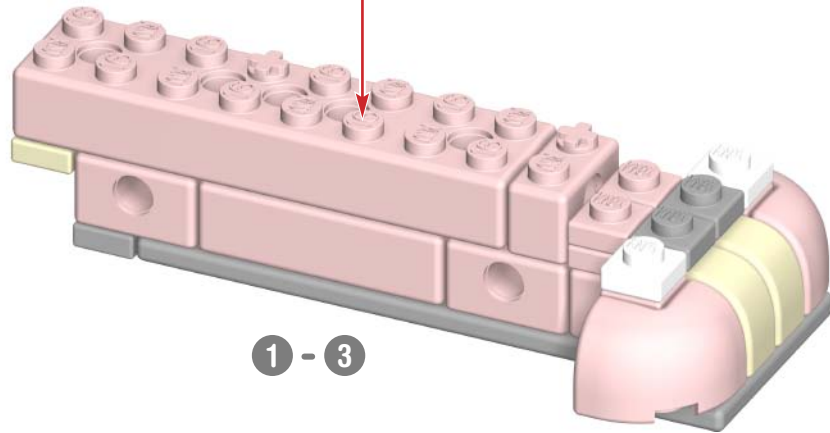
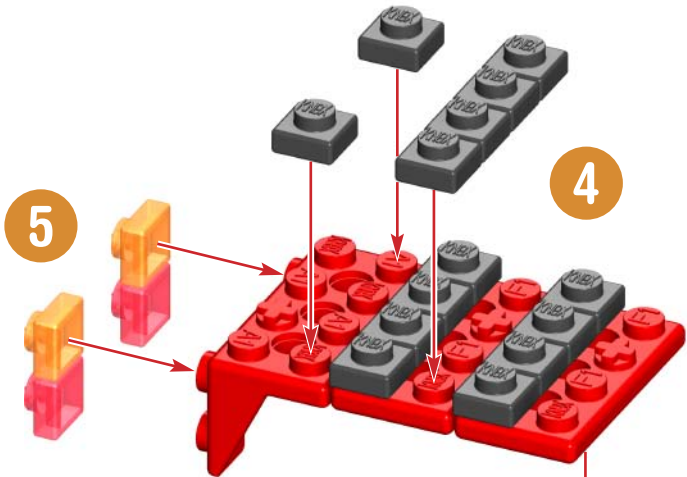

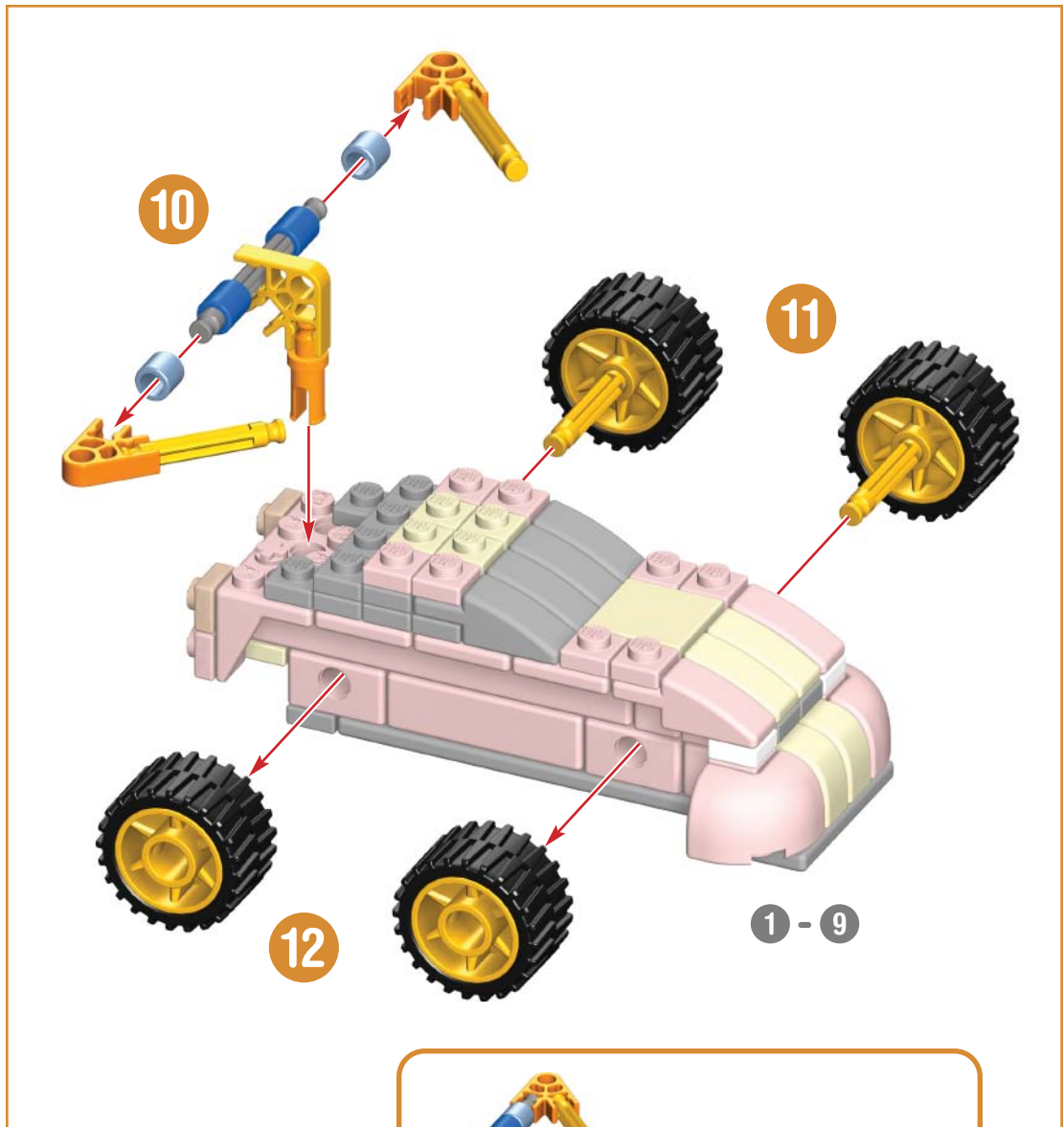
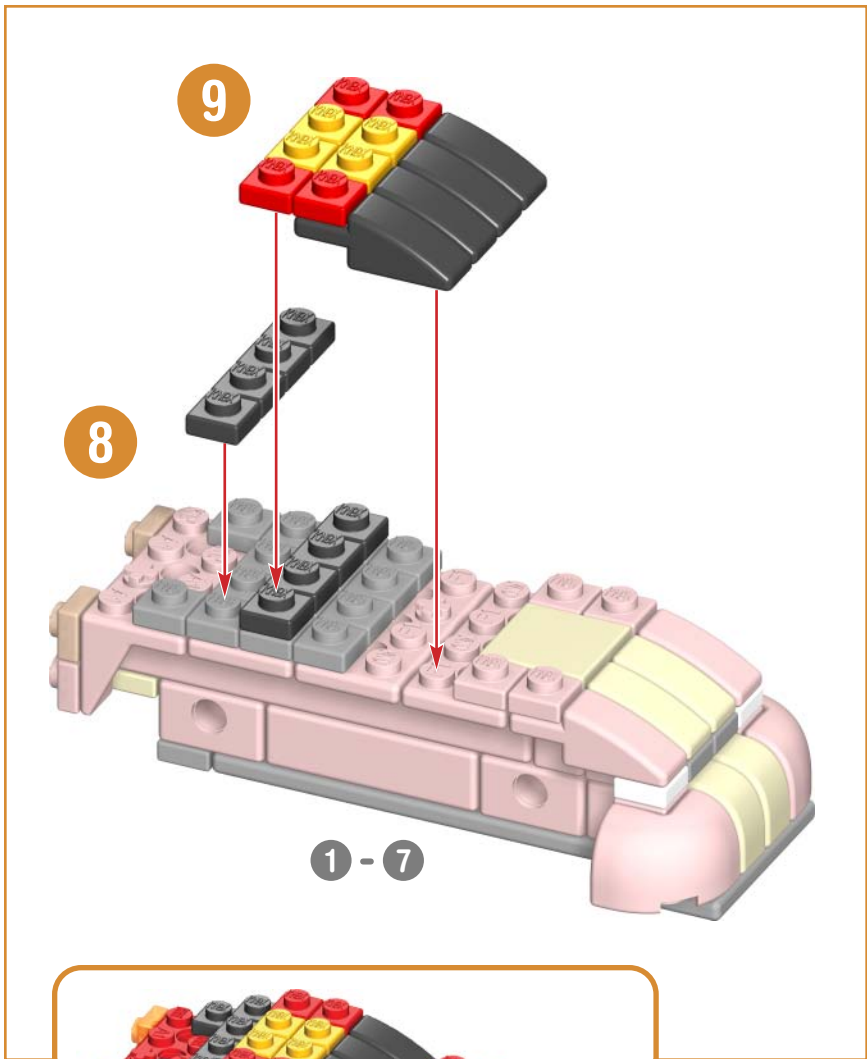

STREET DRIFTER

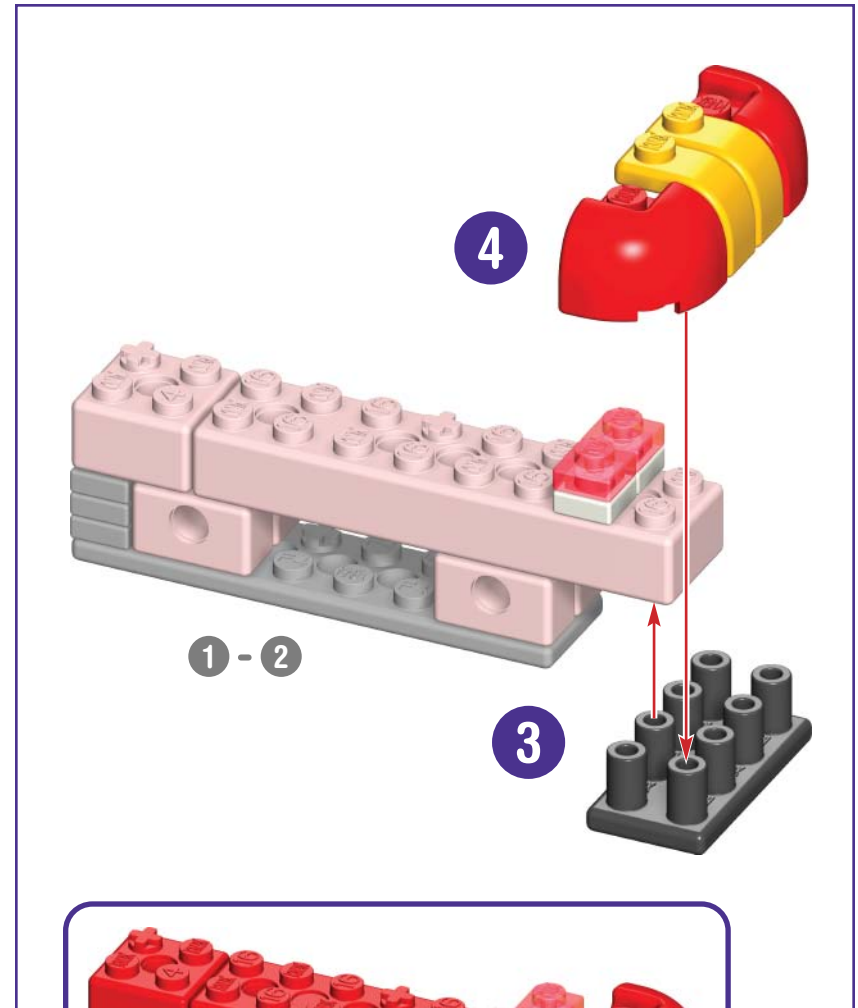
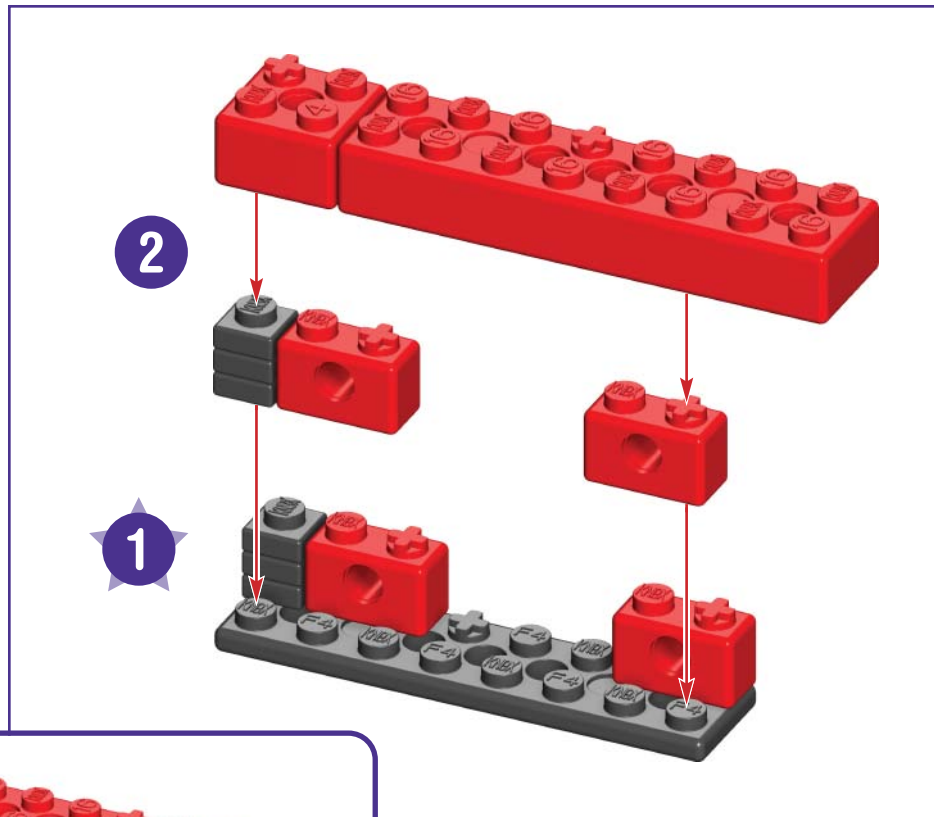

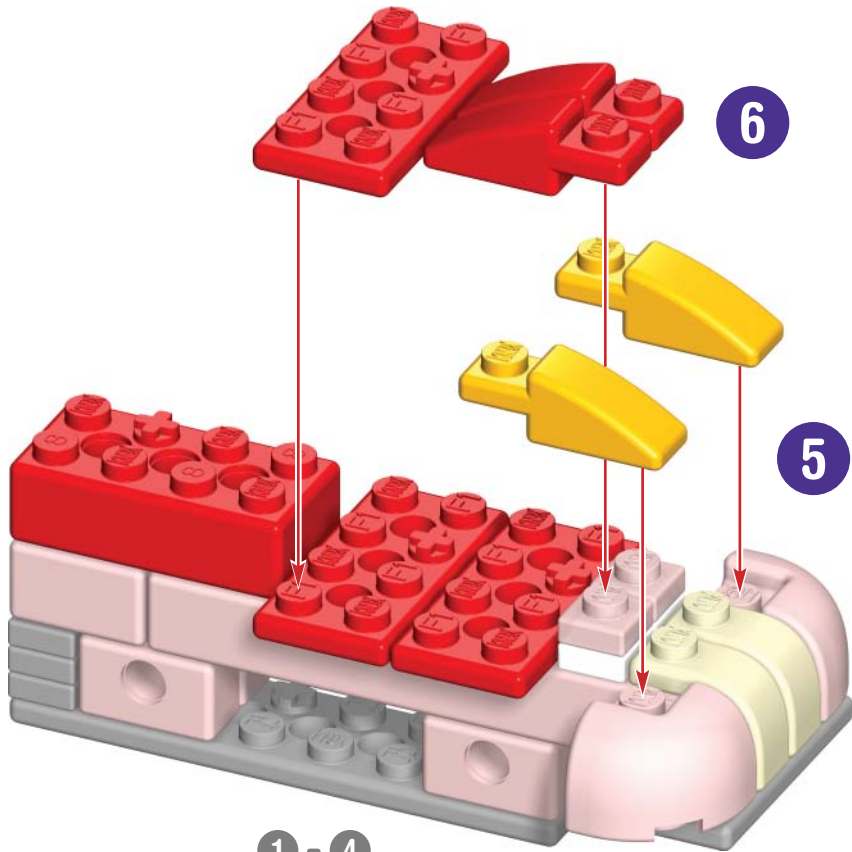

1 - 4

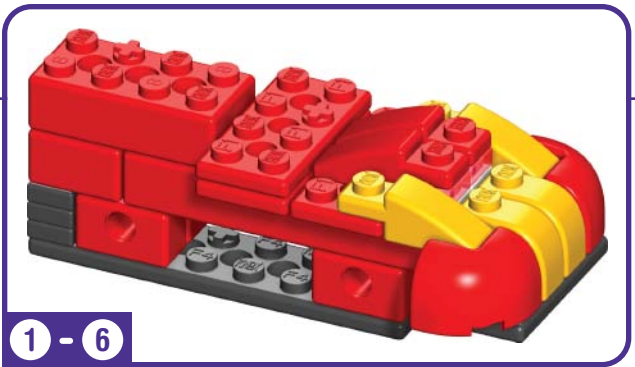

1 - 6

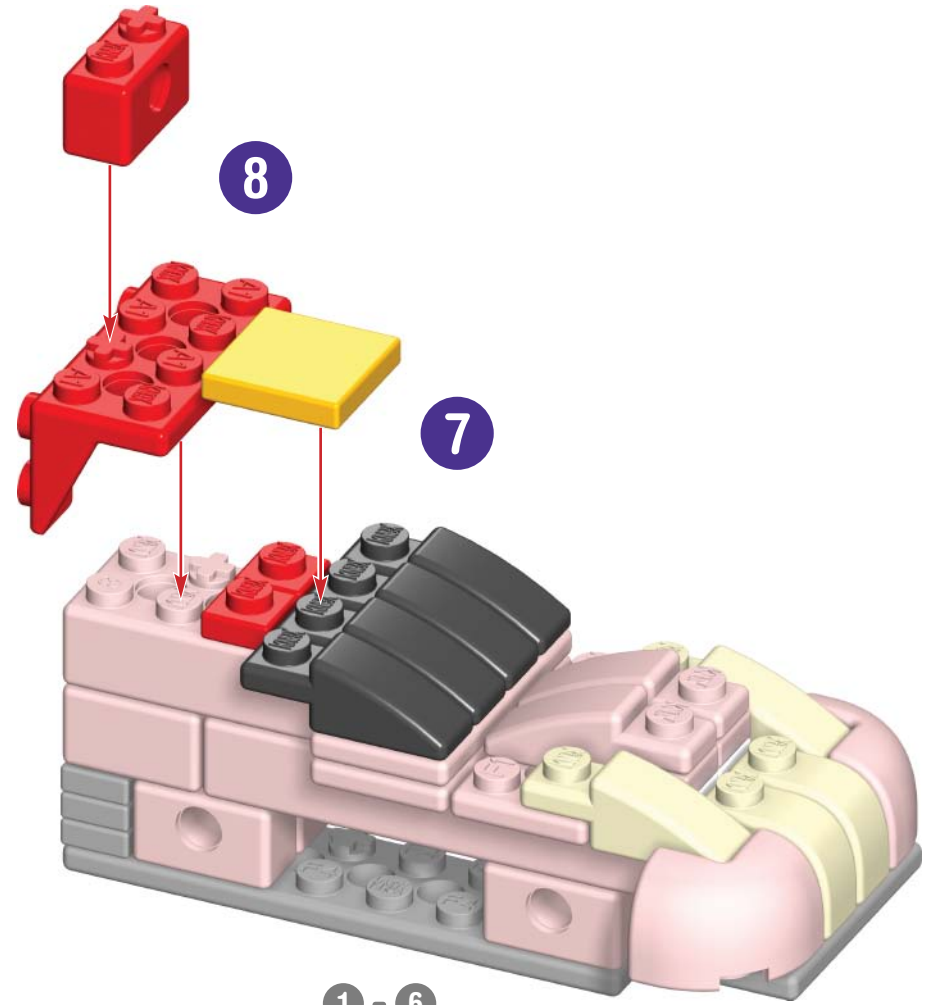

1 - 6



1 - 8

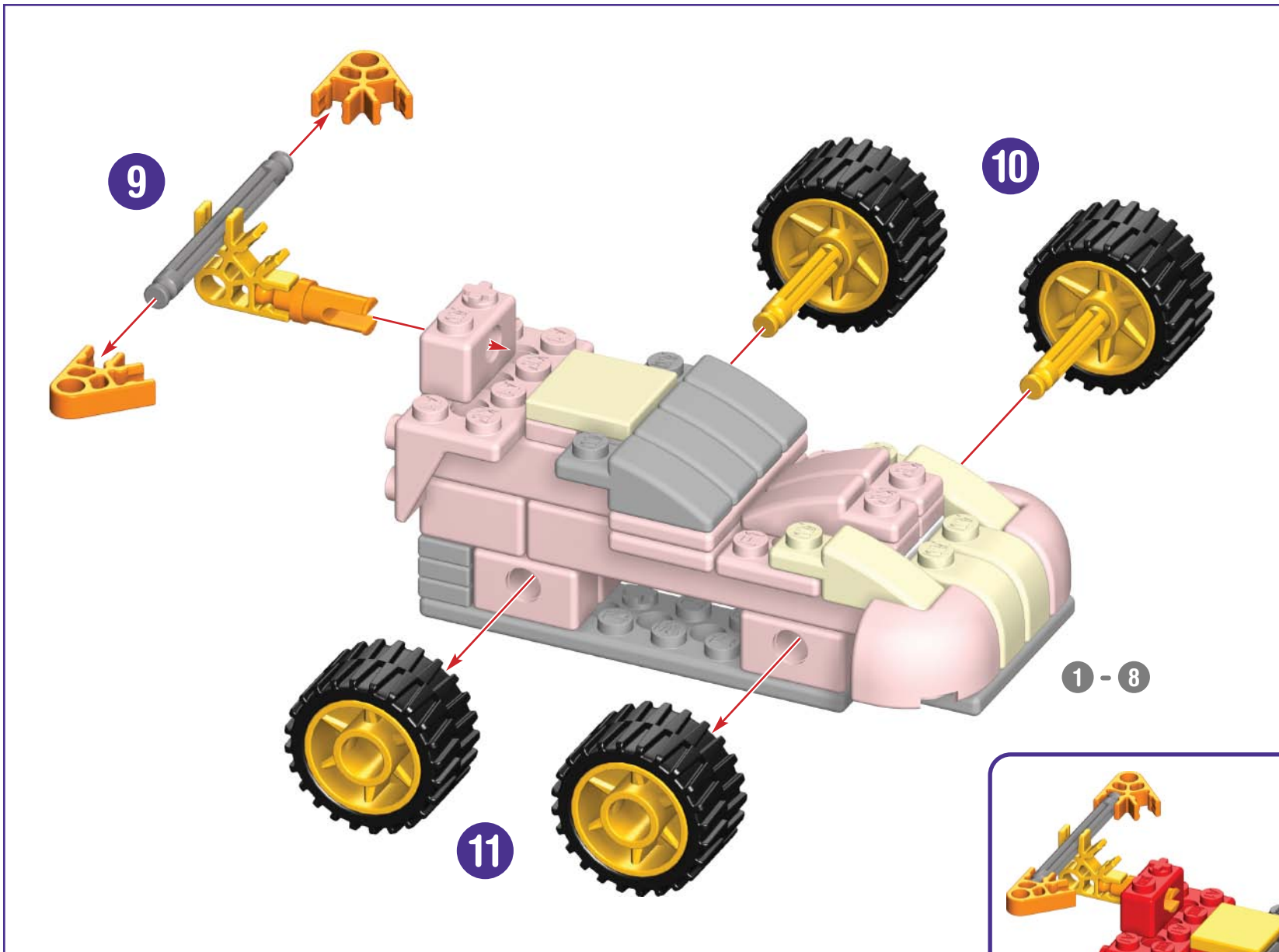

STREET RACER

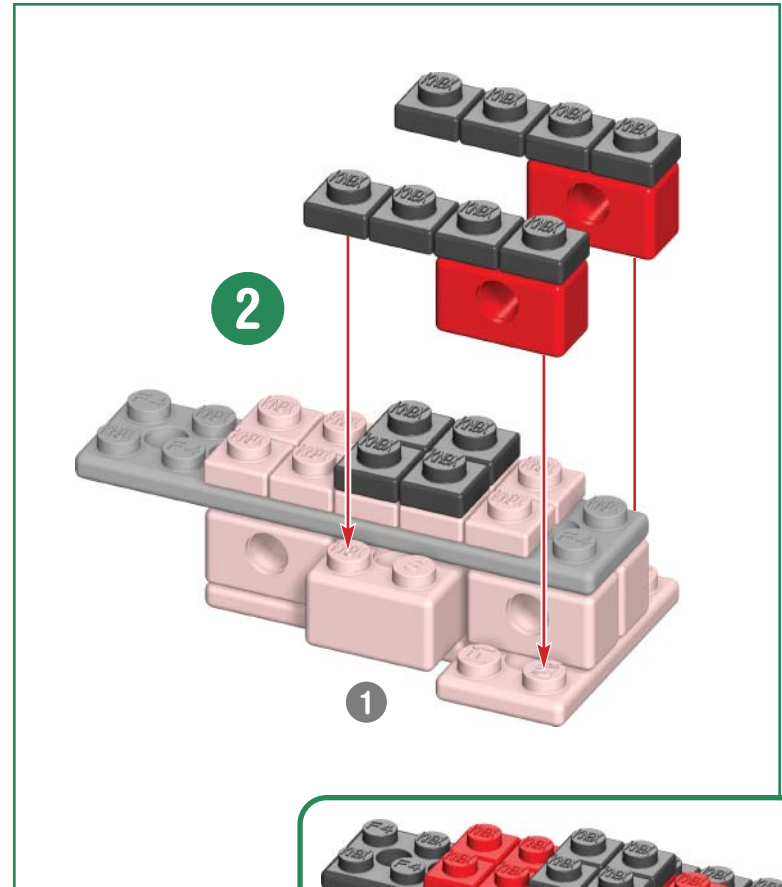
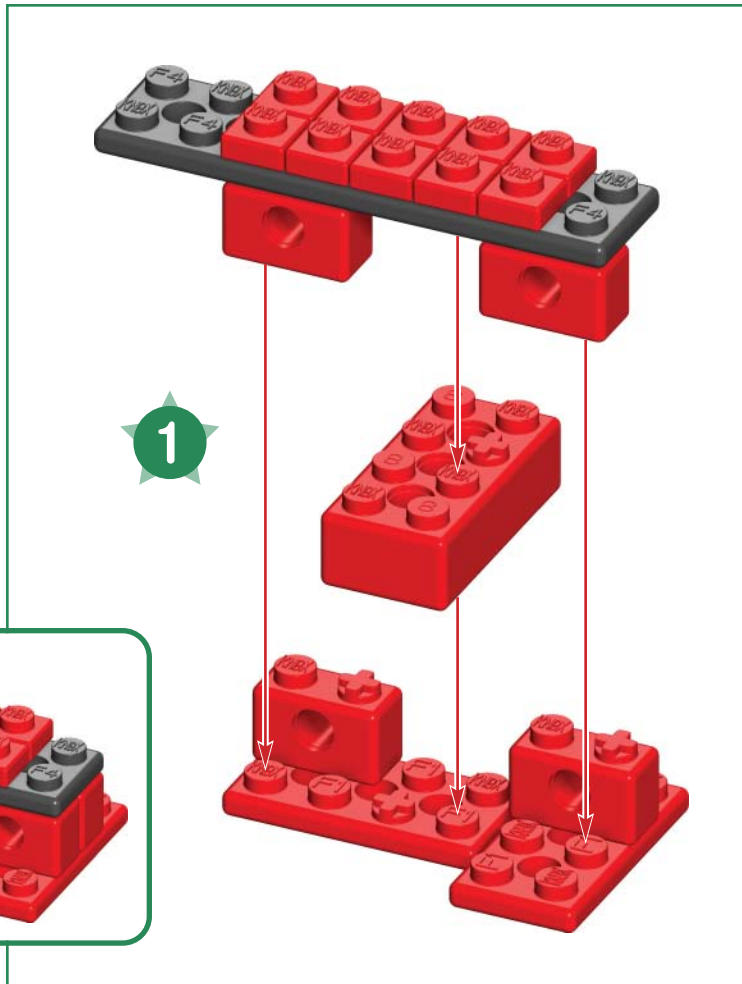
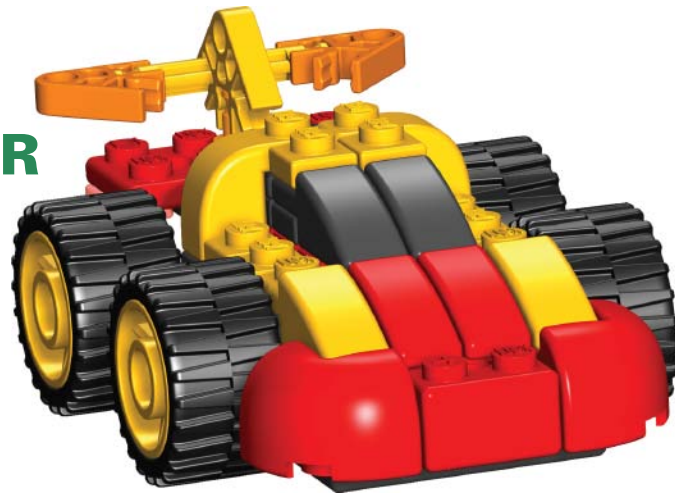

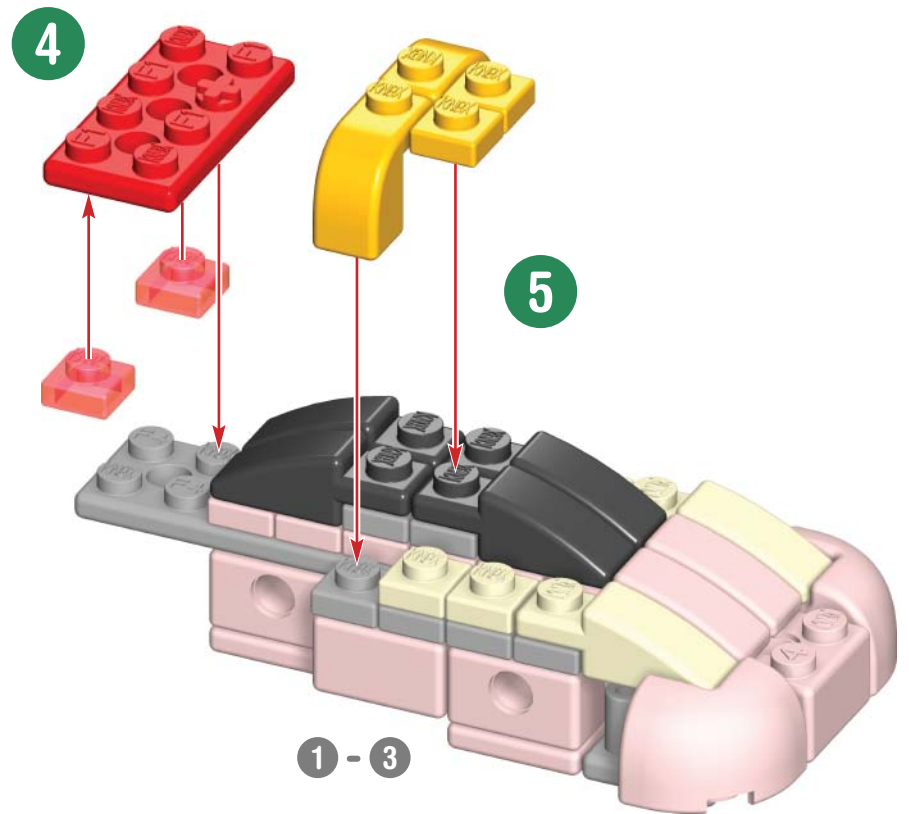
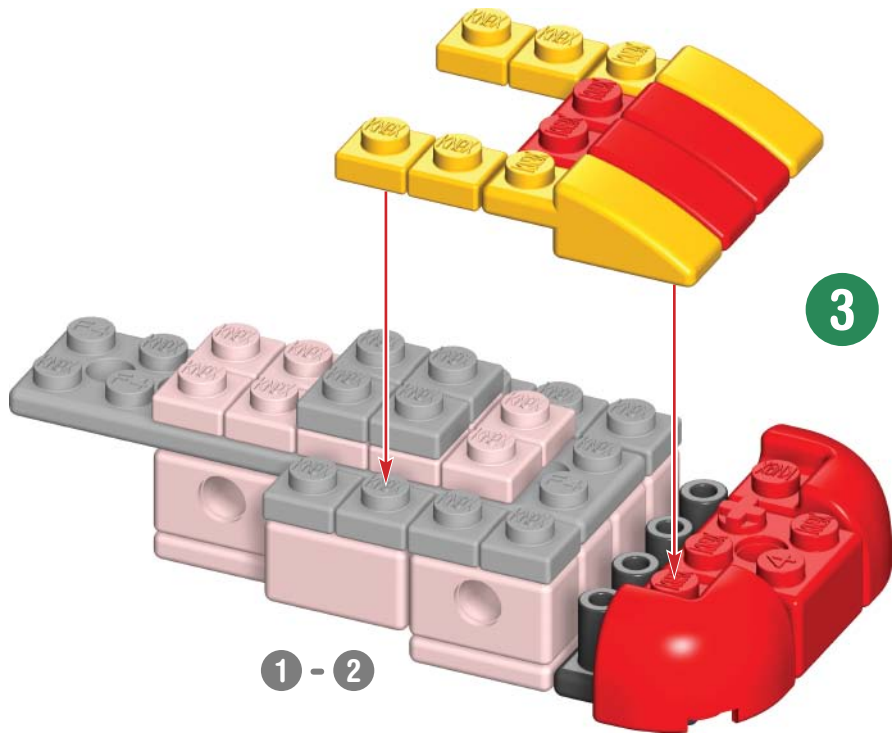

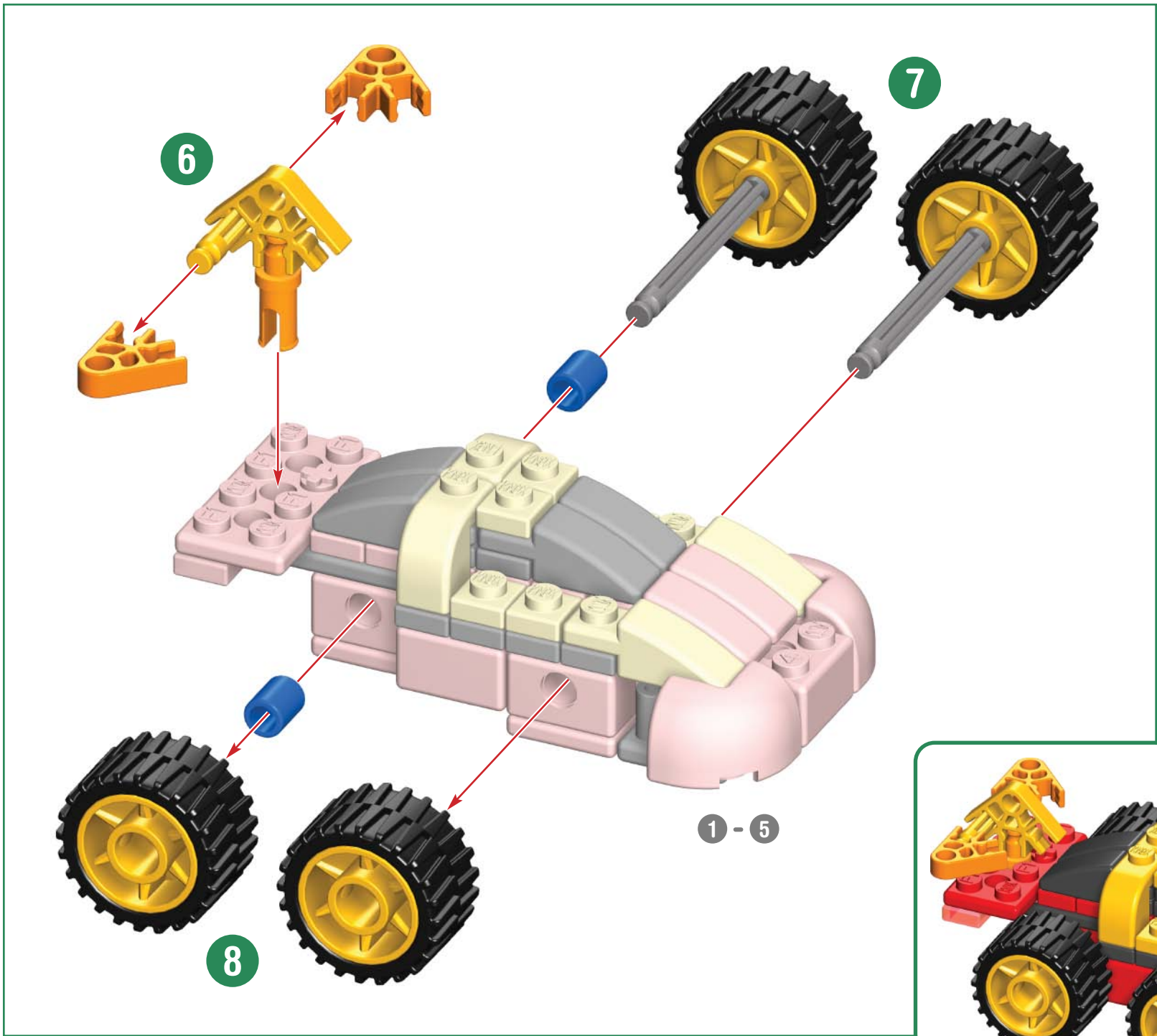

STREET RODDER

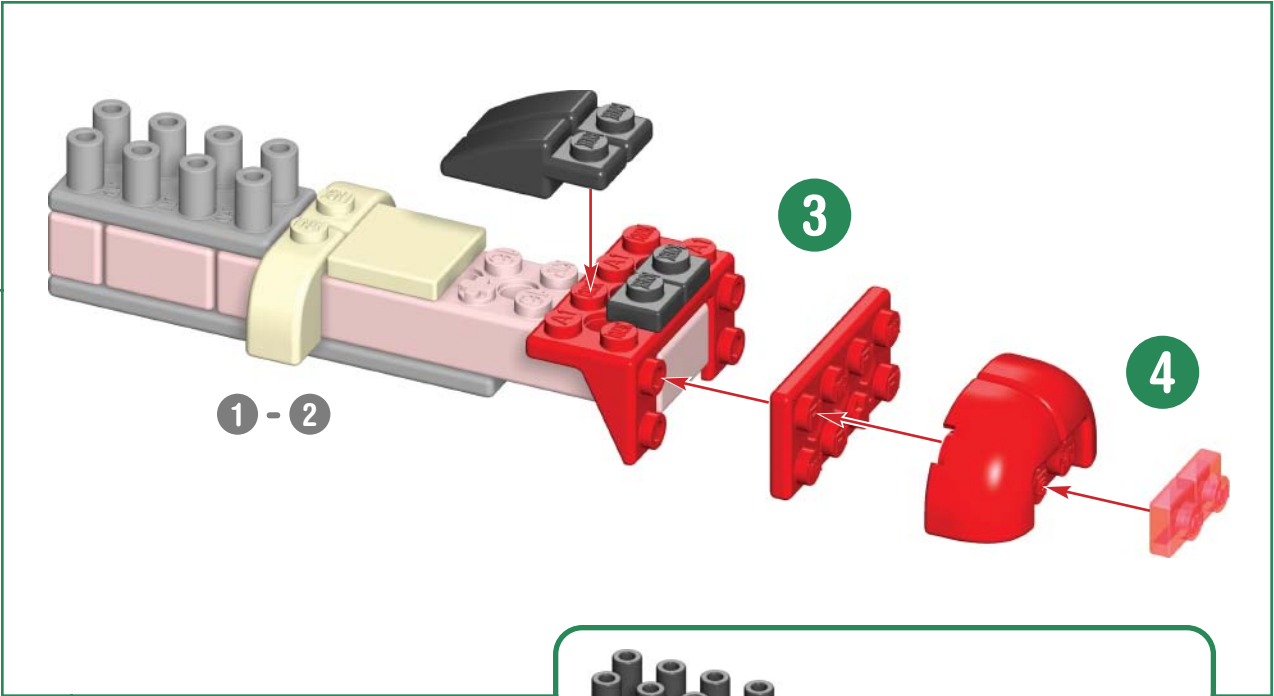
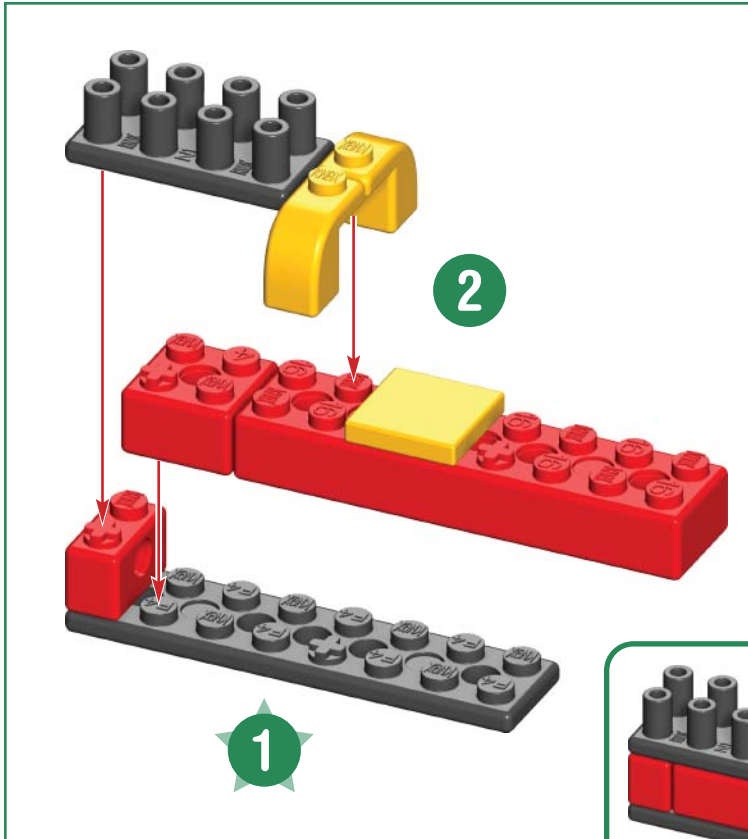

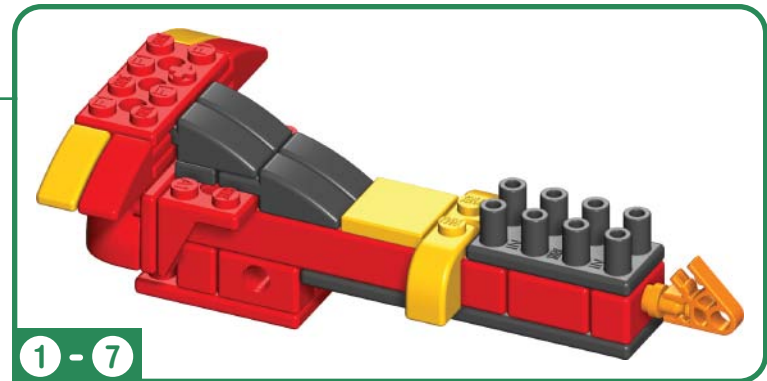
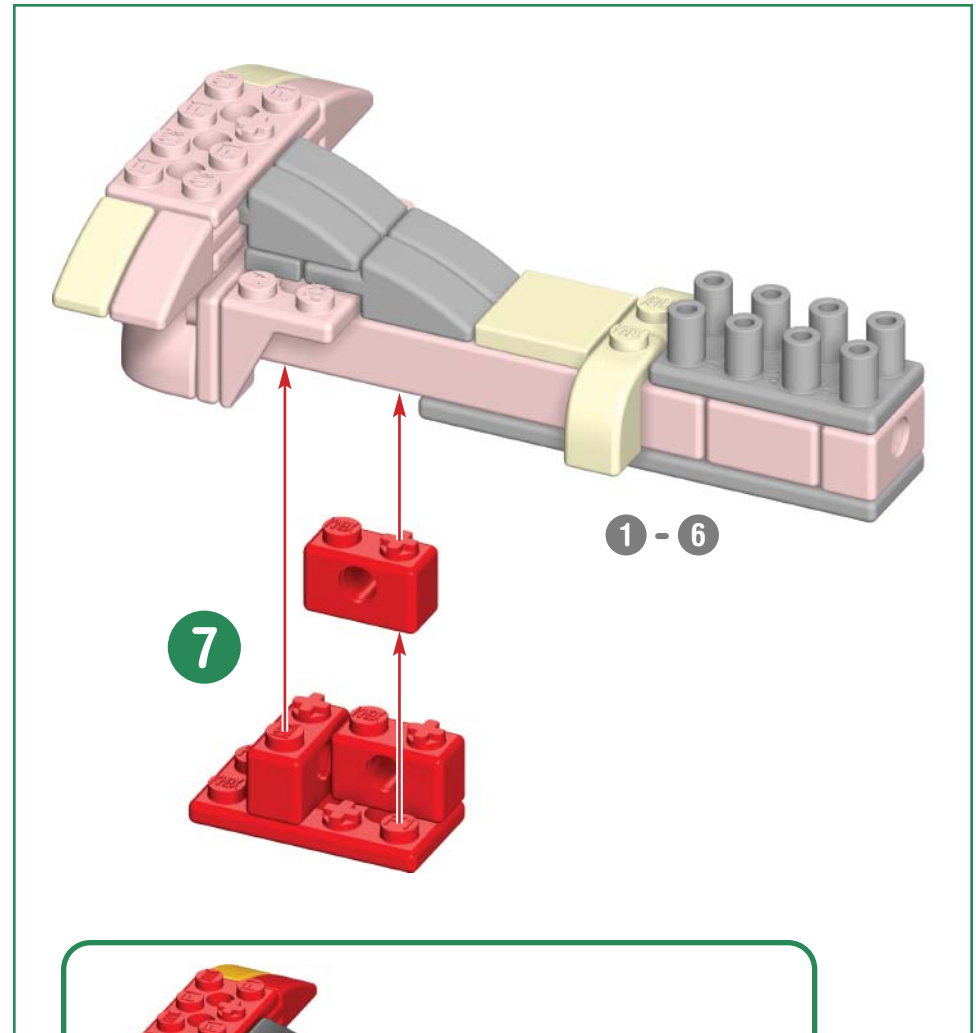
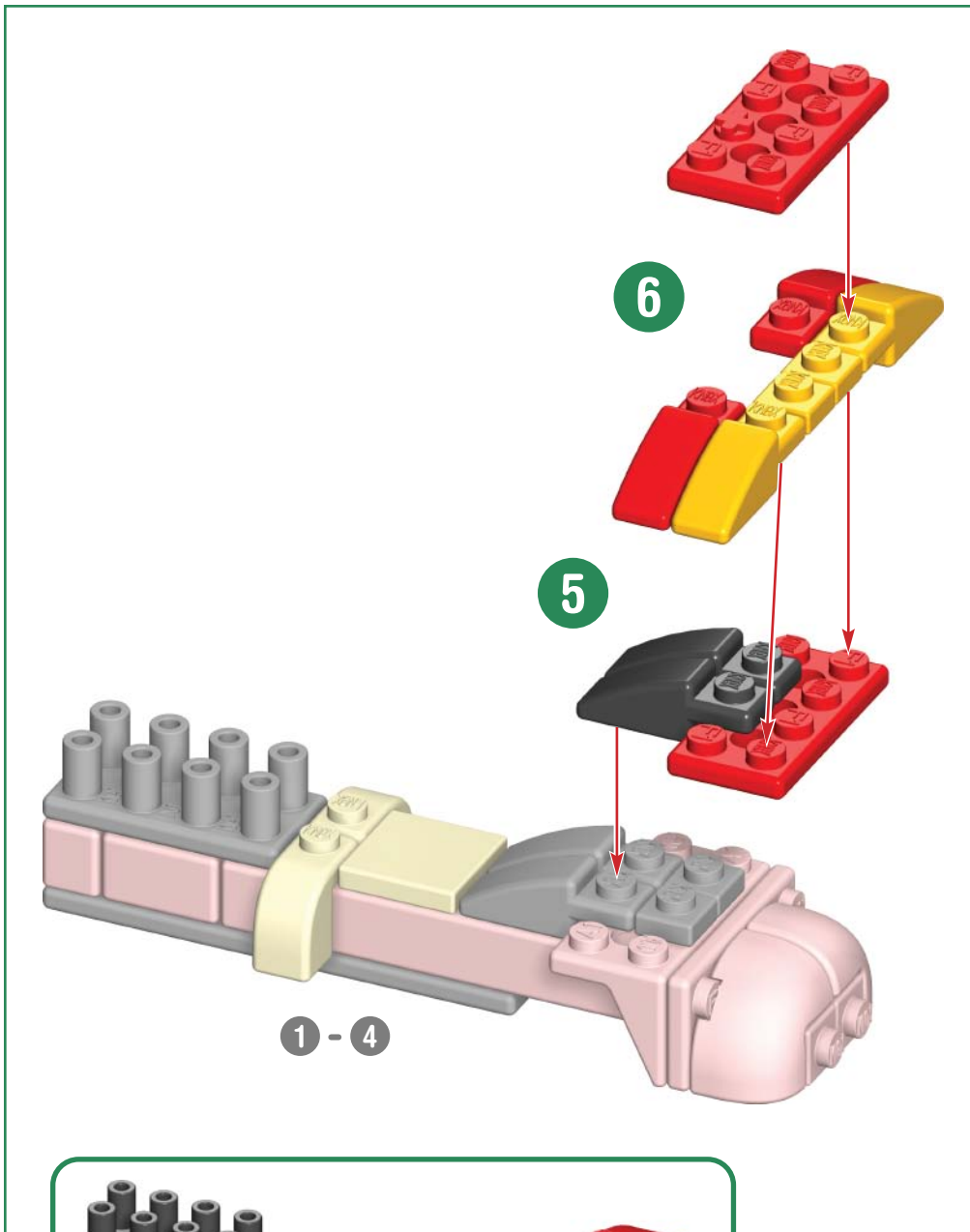

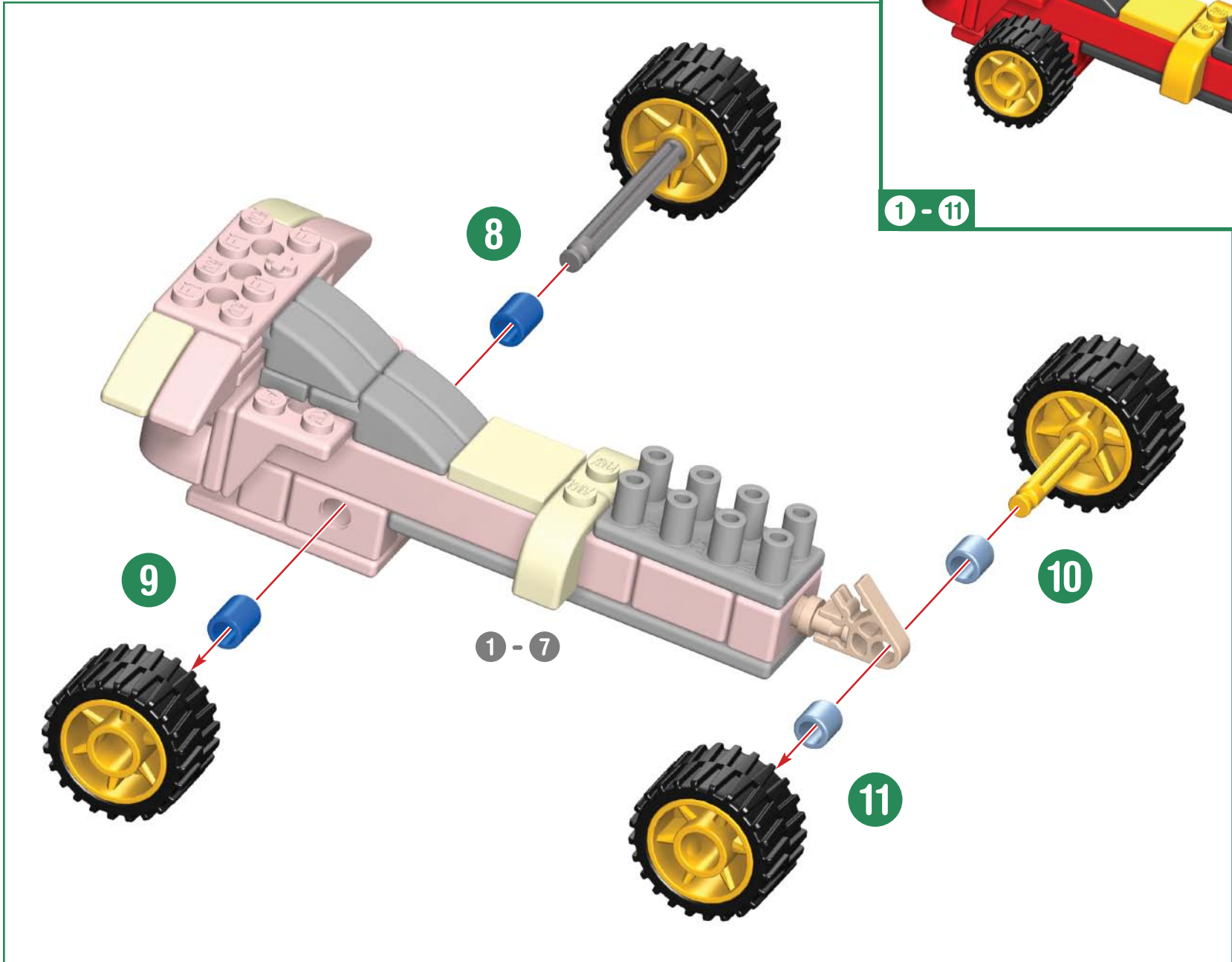

1 - 11



TOP FUEL DRAGSTER

