

K'NEX
BUILDING SYSTEM

50041/69927
50043/69928

**STREET
MODS
AMP**

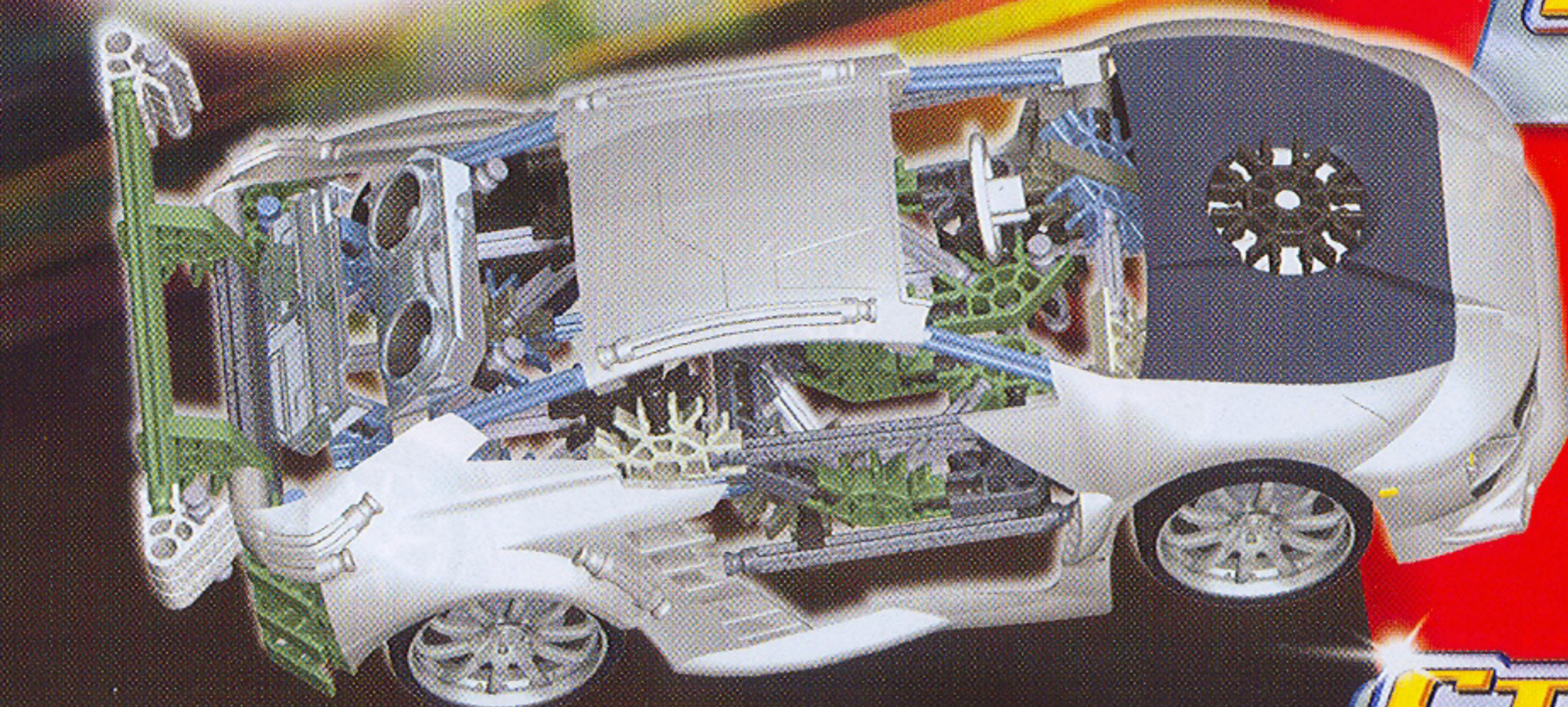

**STREET
MODS
TUNES**

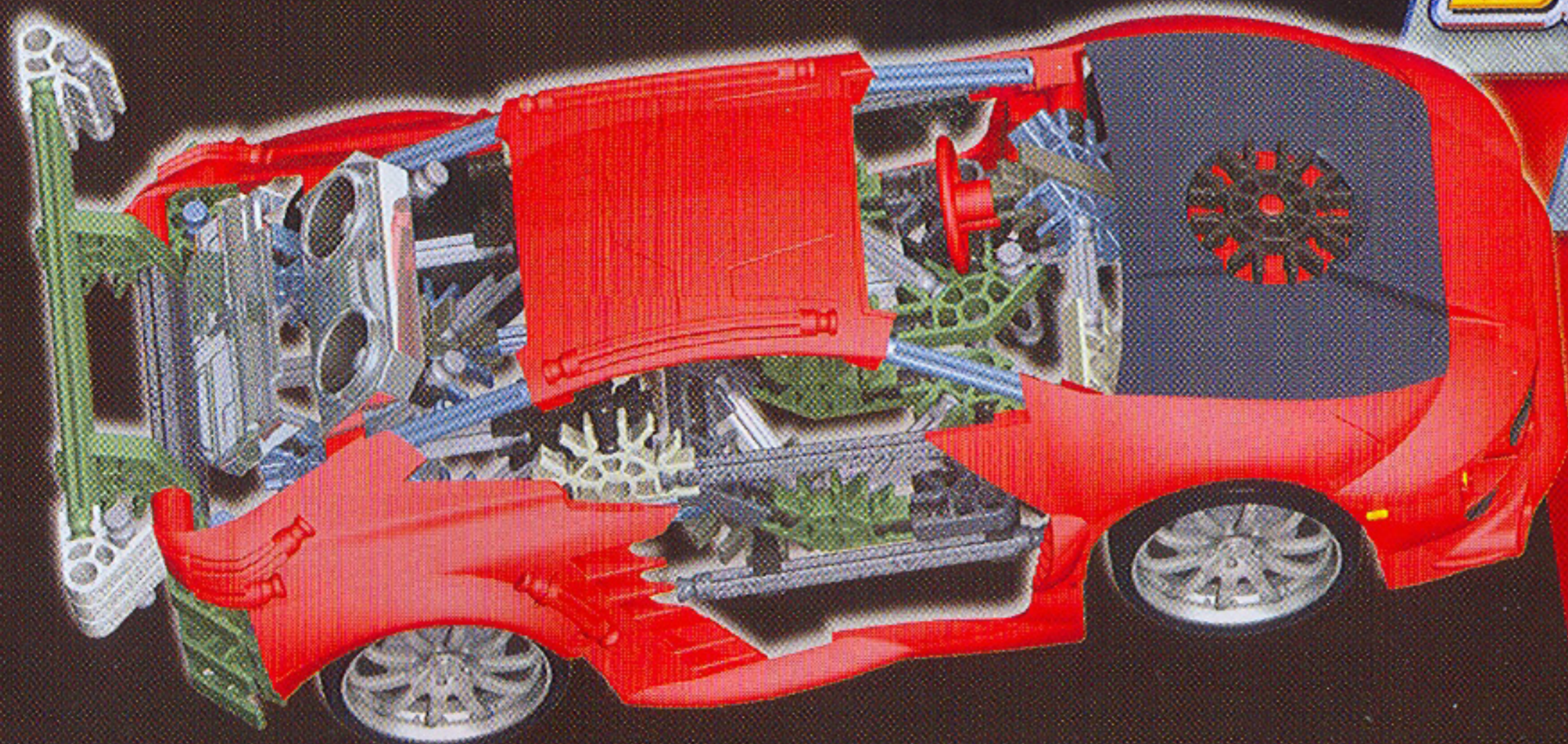

**Cars sold separately.
Vendu séparément.
Se vende por separado.**



WARNING:

CHOKING HAZARD - Small parts.
Not for children under 3 years.



AVERTISSEMENT:

DANGER D'ÉTOUFFEMENT - Pièces de petite taille.
Ne pas donner aux enfants de moins de 3 ans.

8+

161 PCS/ST



Now you can build and modify your own STREET MODS™ with the AMP™ or TUNES™ building set, from K'NEX!

BUILDING PLANS

STAGE 1:

Build the Chassis . . . 4

STAGE 2:

Create the Body 10

STAGE 3:

Finish Detailing 12

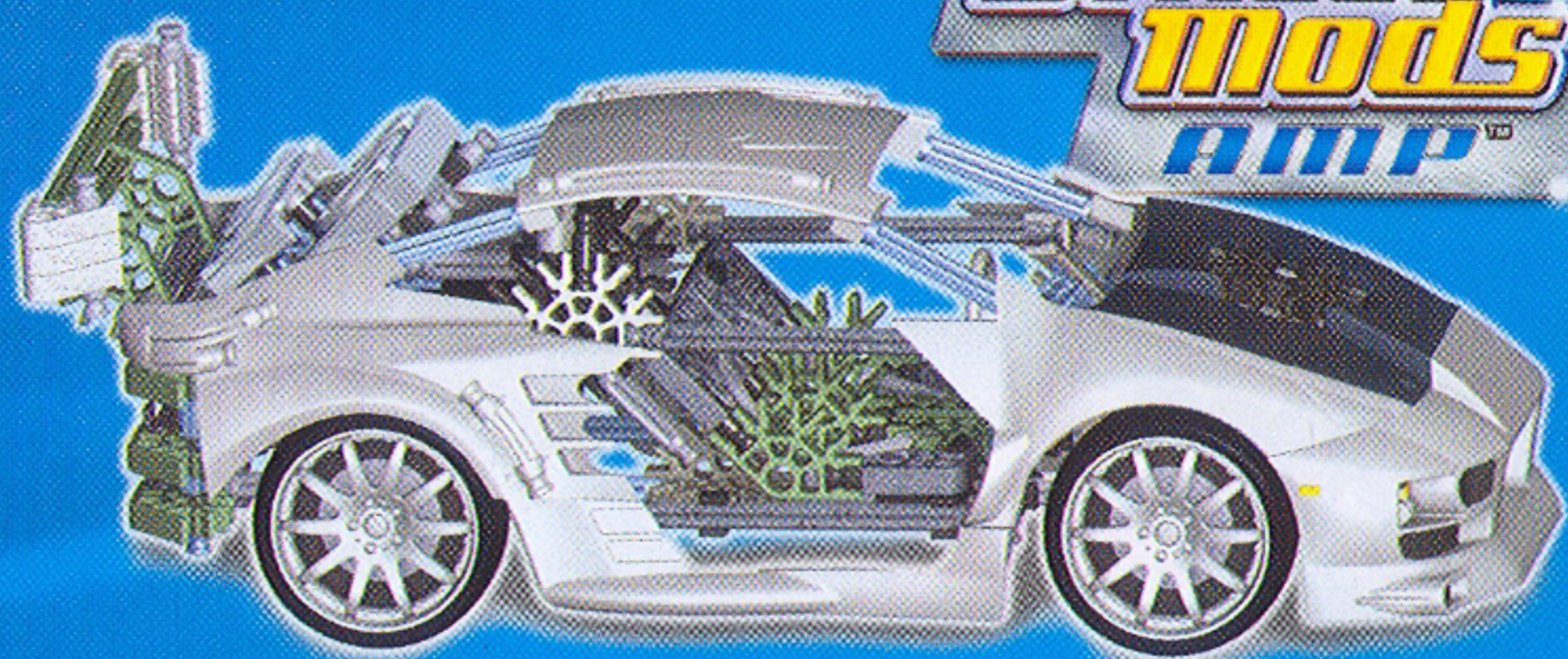

Build the chassis out of K'NEX, create the body and bolt on racing rims inspired by Axis Sport Tuning™!

K'NEX BUILDING BASICS

Ready, Set, Build

To begin your model, find the  and follow the numbers. Each piece has its own shape and color. Just look at the picture, find the pieces in your set that match what you see, and snap them together.

Try to hold your model in the same direction as in the picture so you'll attach your pieces to the right place.

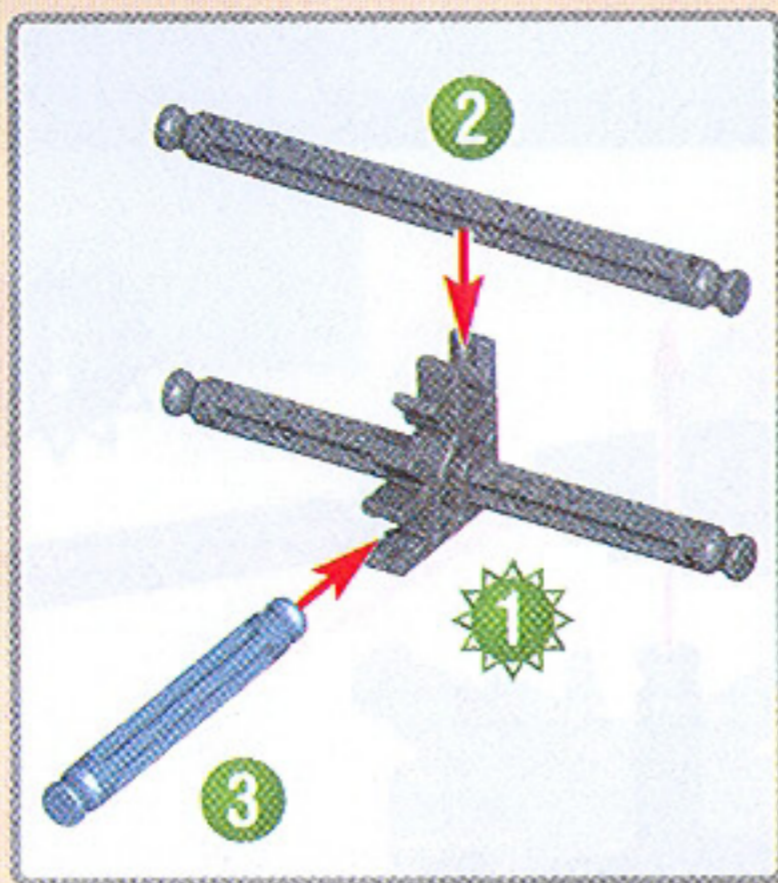

Movin' On

The faded colors tell you this section is already built. You'll want to connect the new section to the place where the arrows are pointing. These pieces will be in full color.

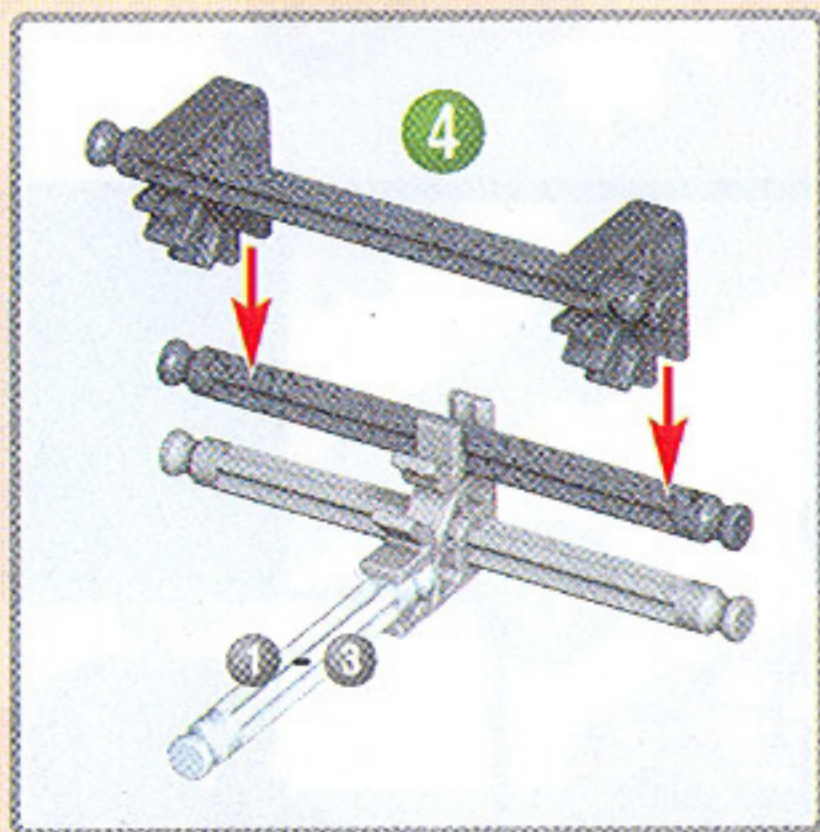

Cross-snap

When a Connector snaps on across a Rod, it is referred to as a "cross-snap". Cross-snaps sometimes require a strong push and you might want to ask an adult for help.

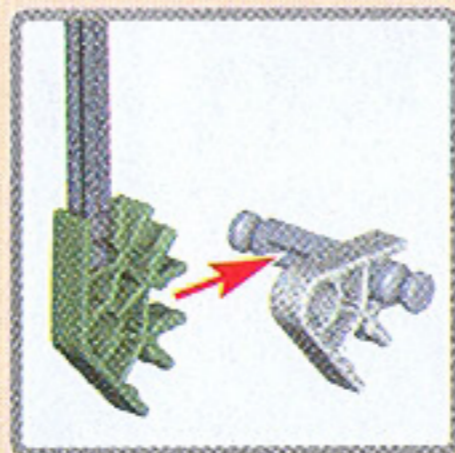

Connectors

There are blue and silver Connectors with special long slots. They slide together as you see in the pictures. Push these parts together until you hear a "click".

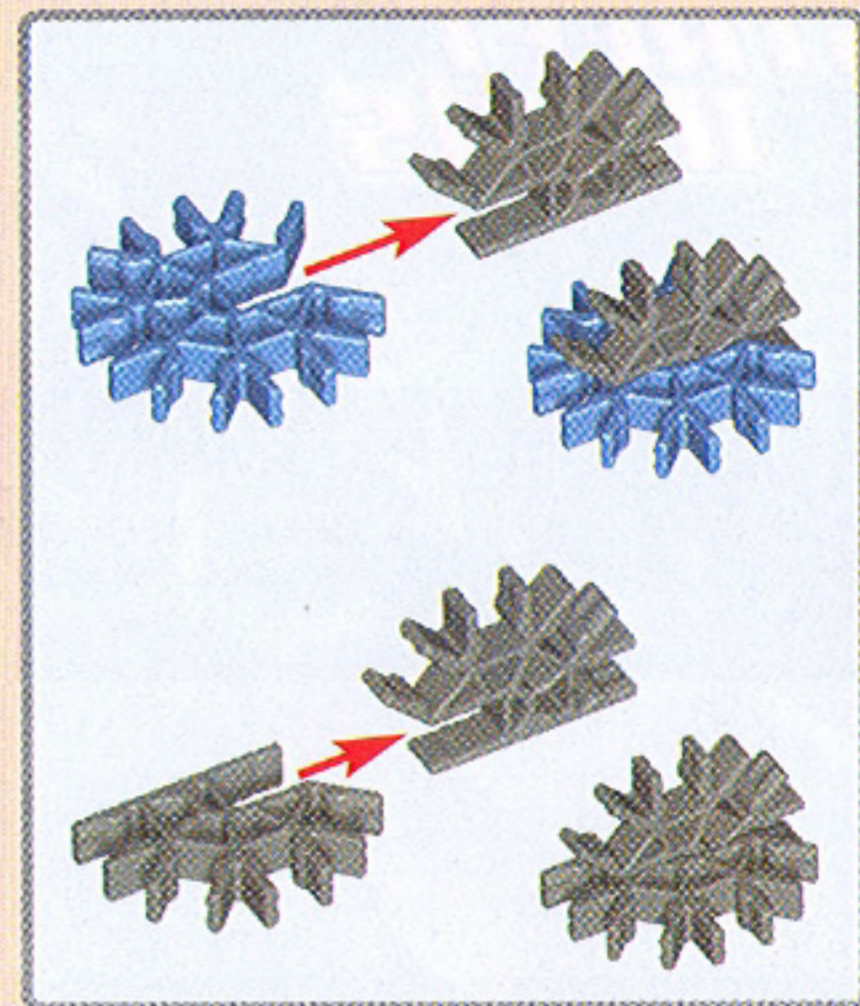

Parts Checklist

Before you start building, be sure to compare the parts in your set with the parts listed here. If anything is missing, check out the back cover of this instructions booklet for how to contact us. We're here to help!

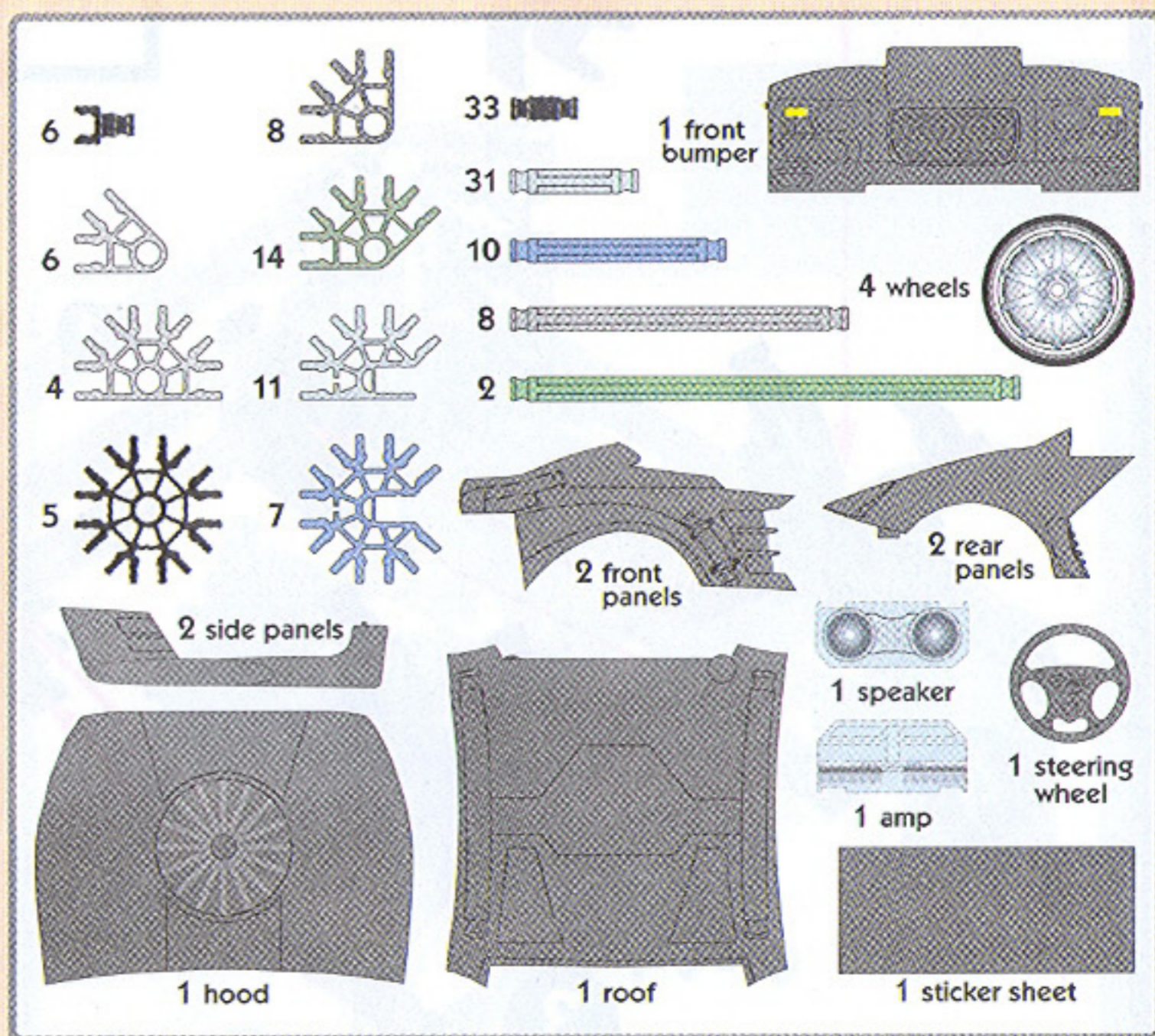

STAGE 1: Build the Chassis

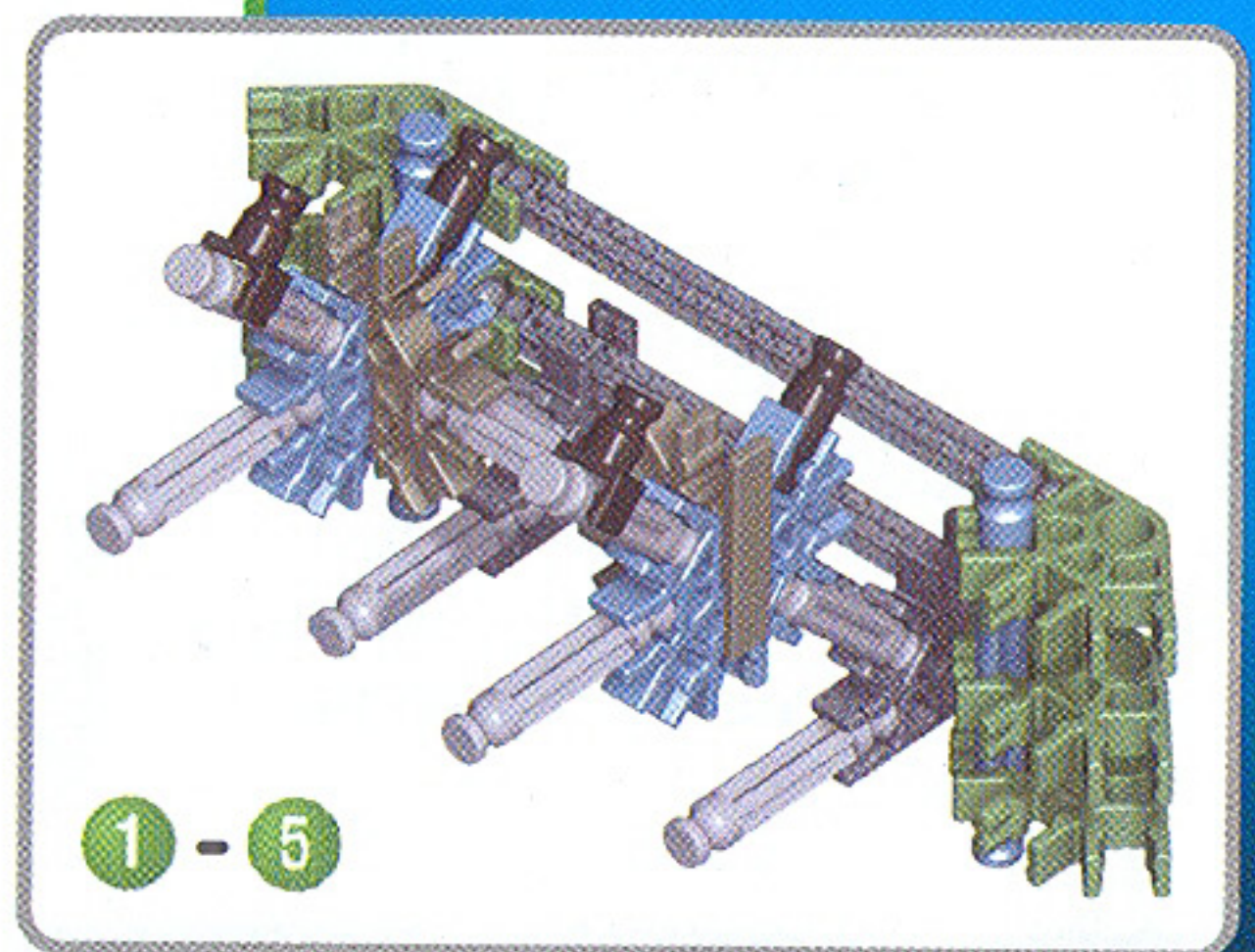
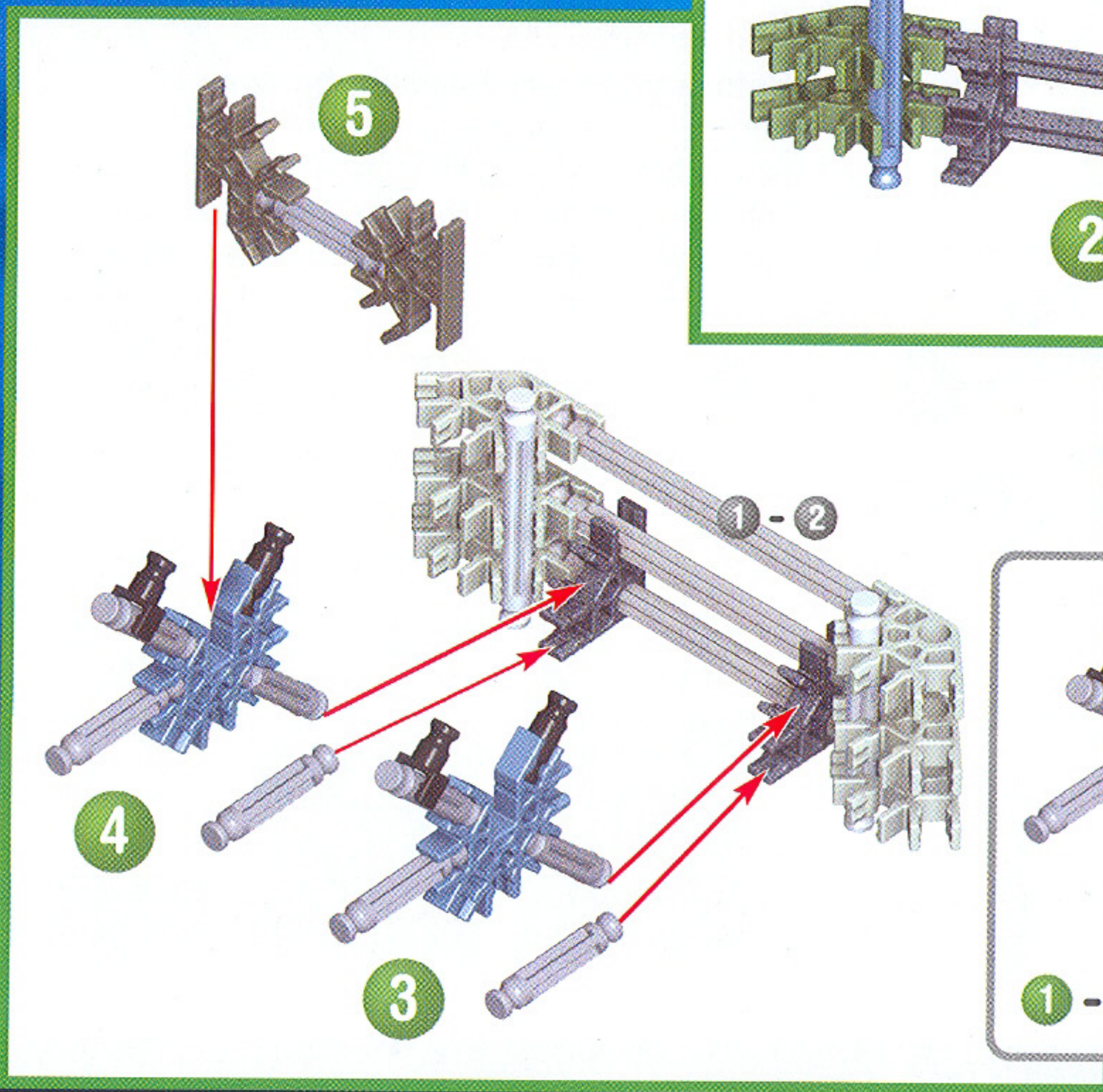
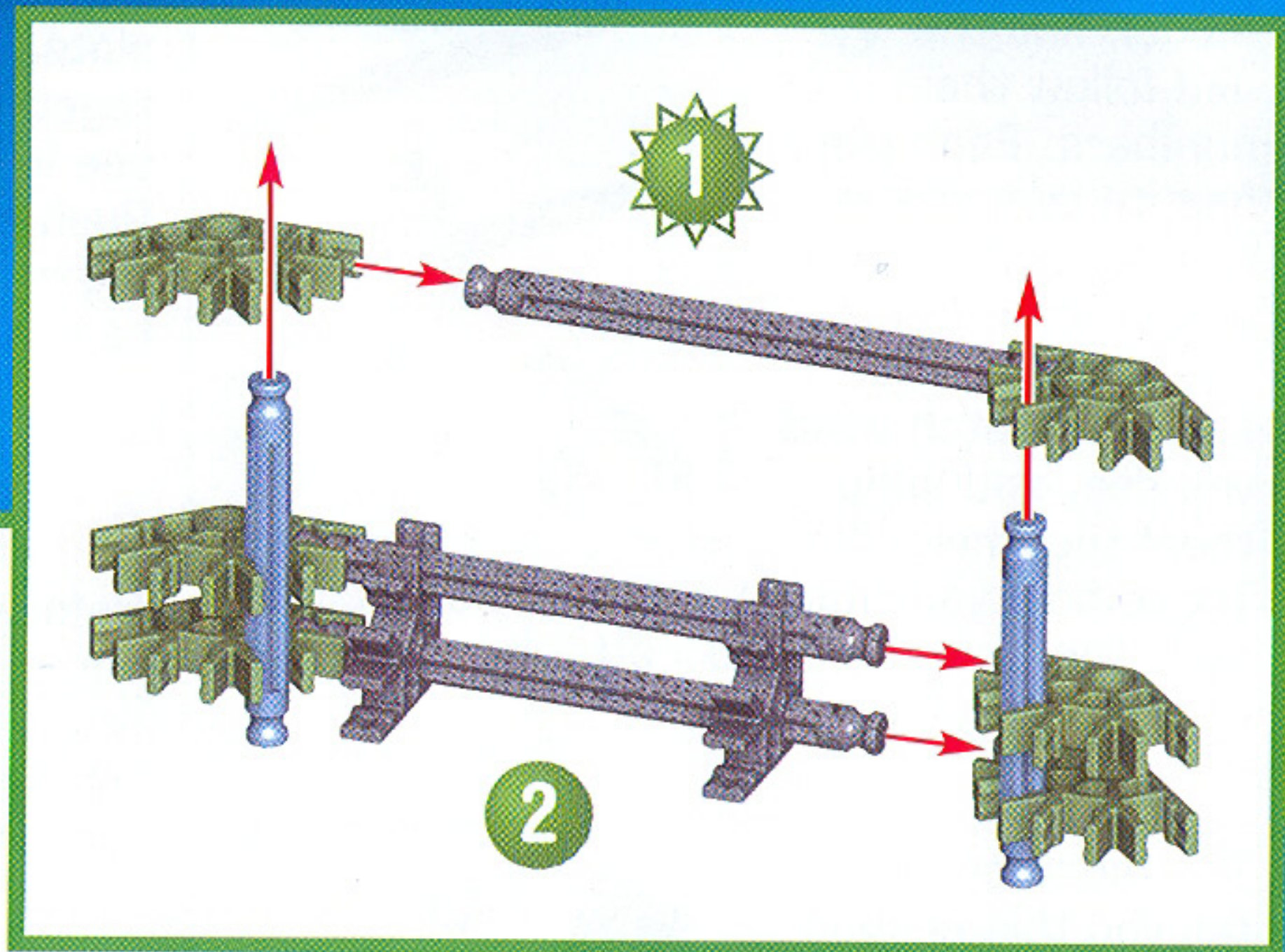

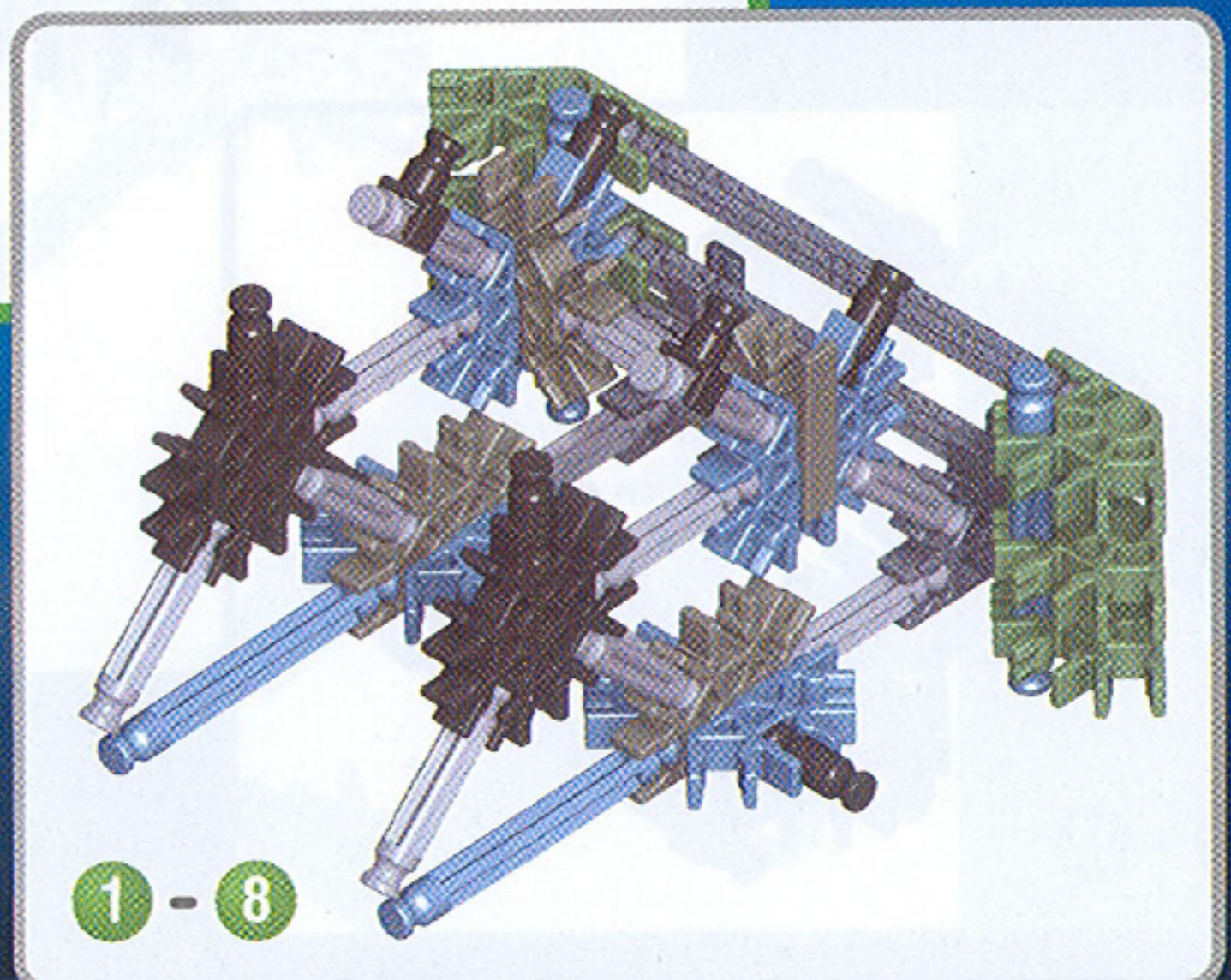
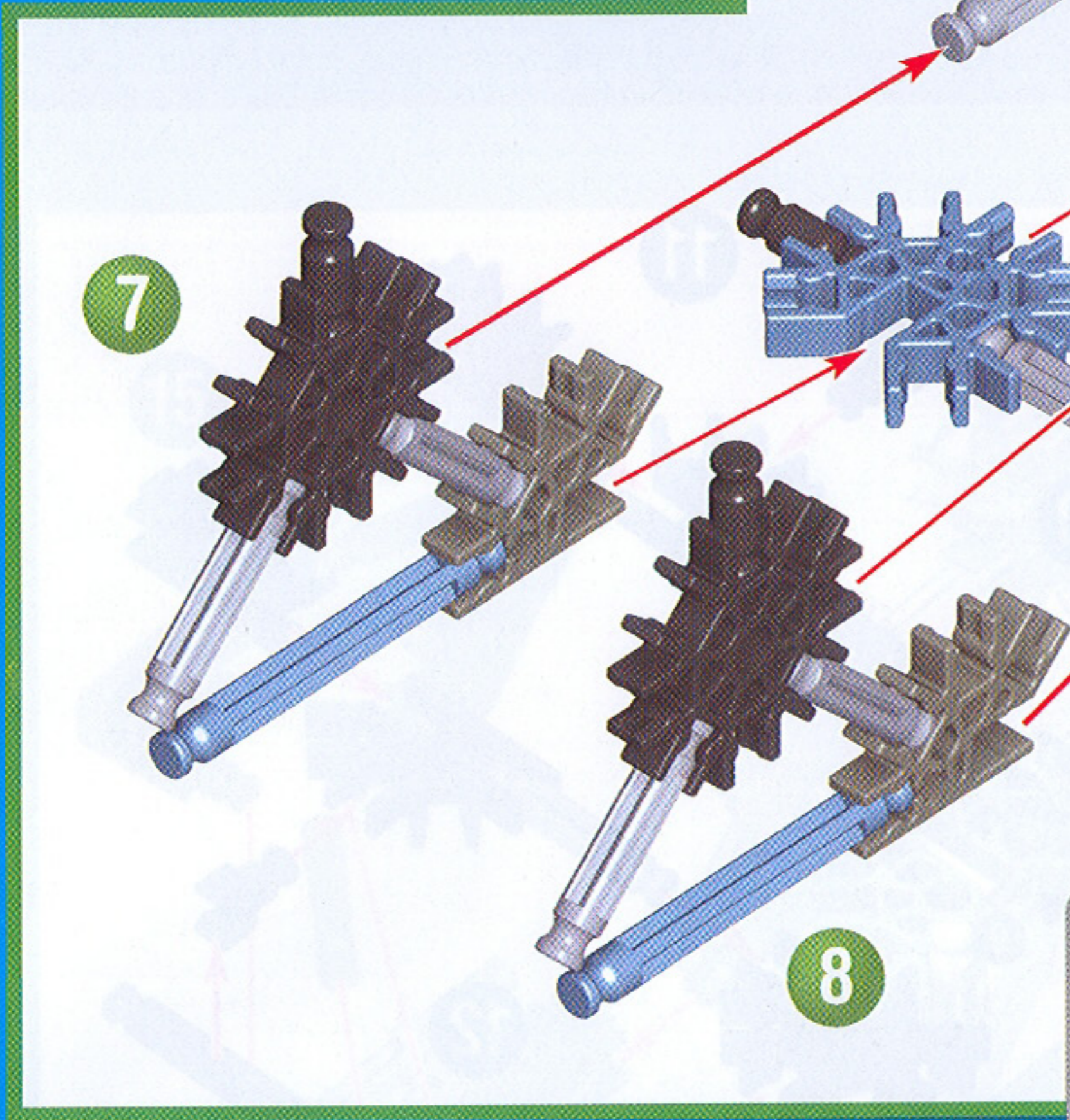
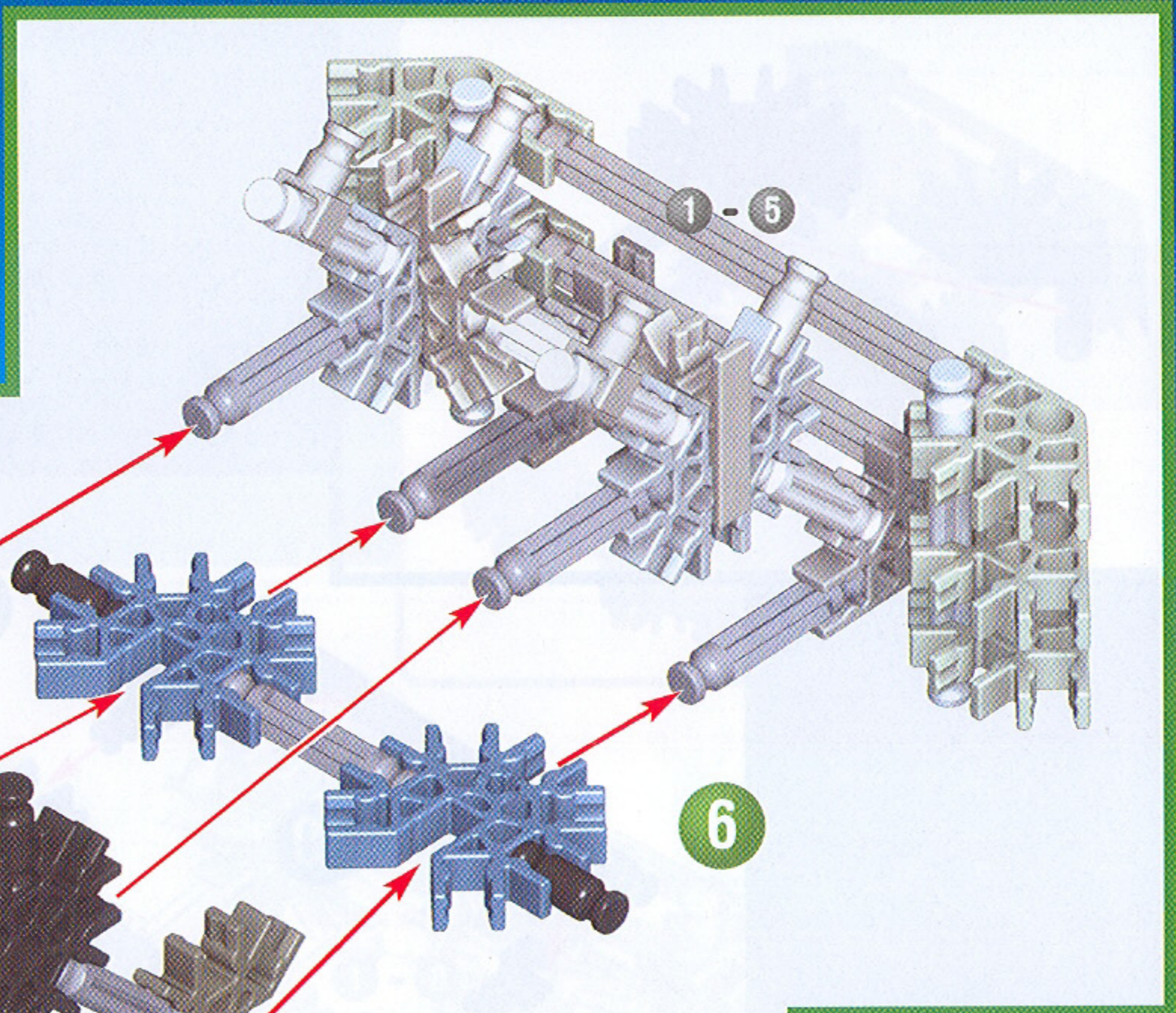

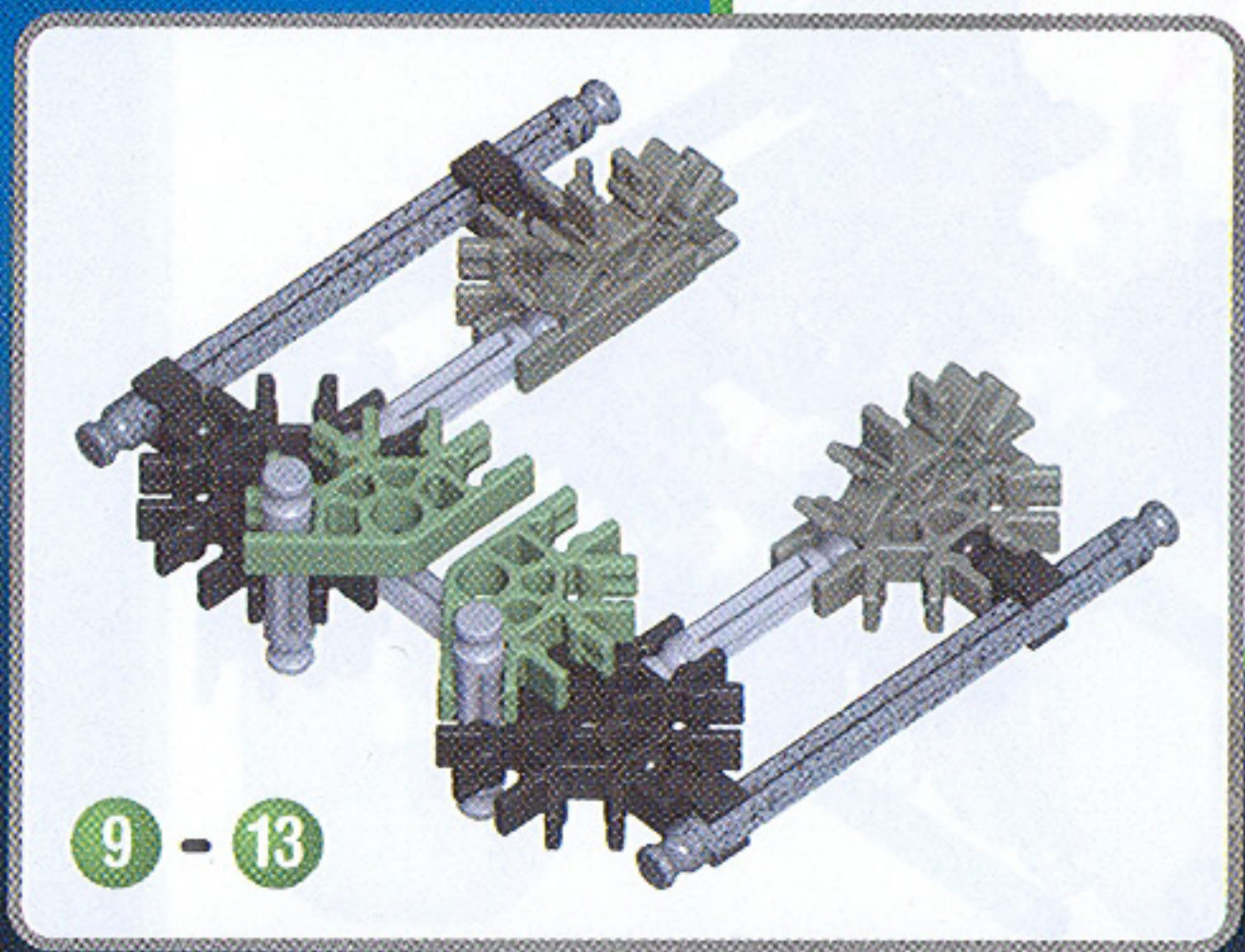
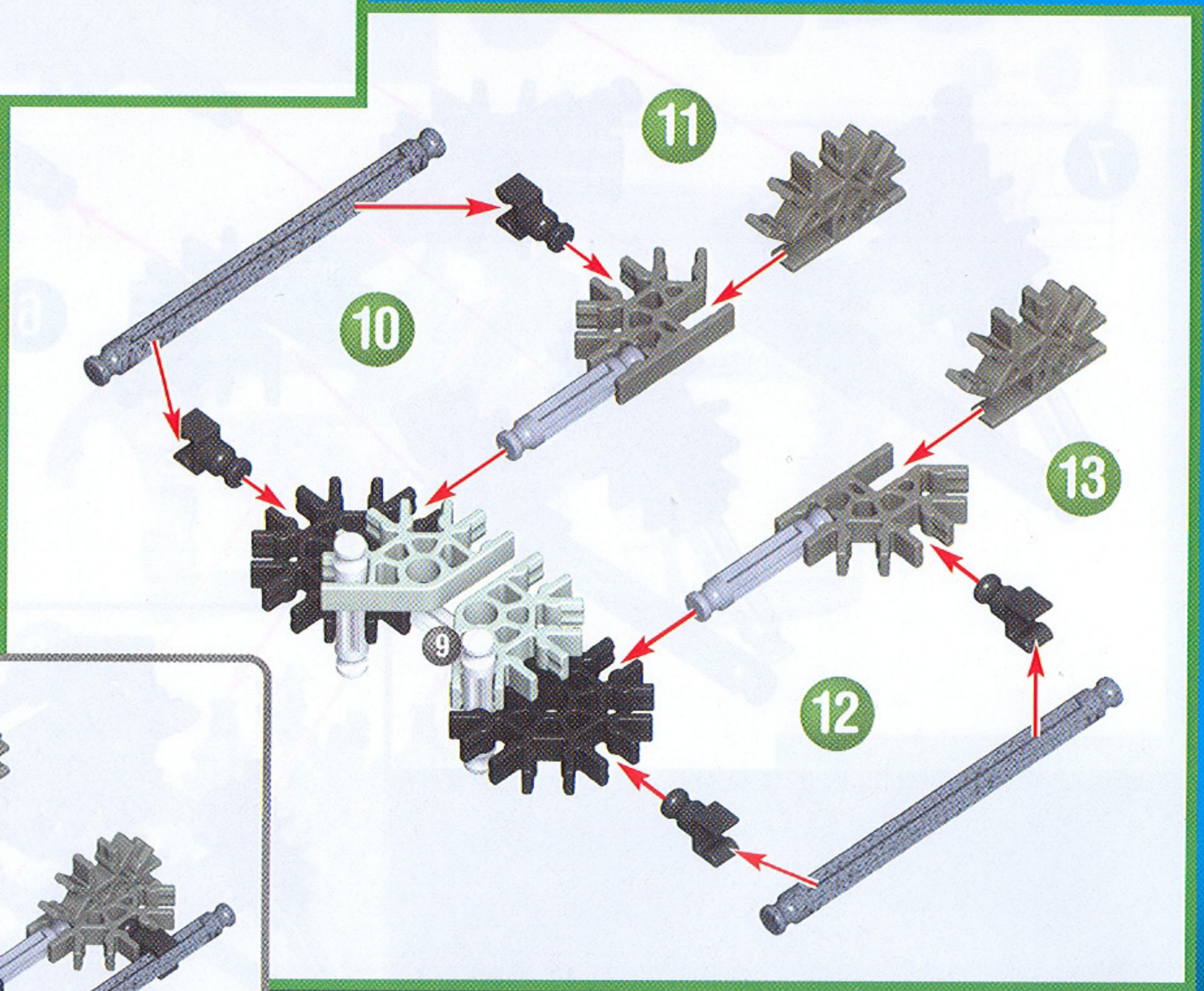
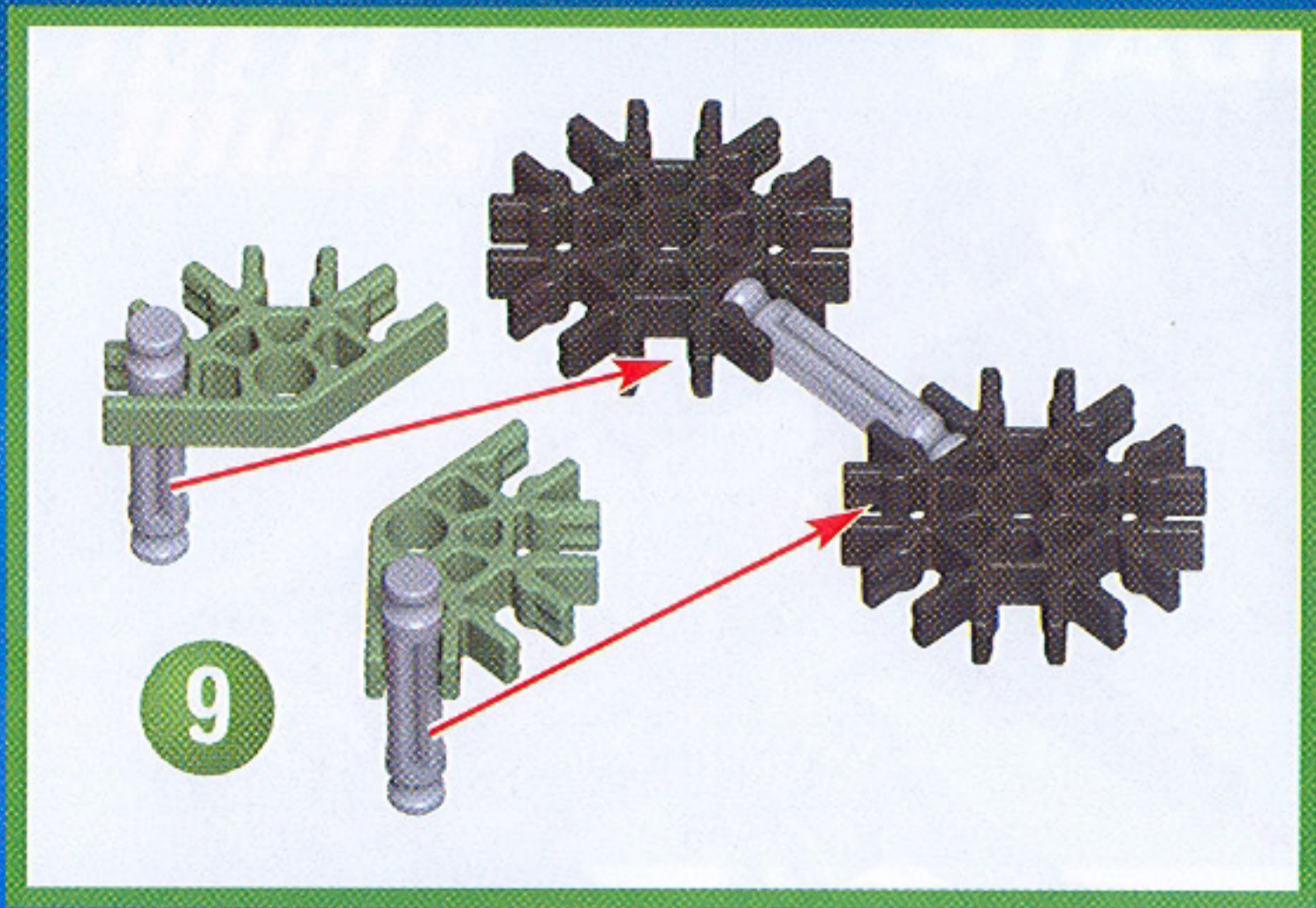

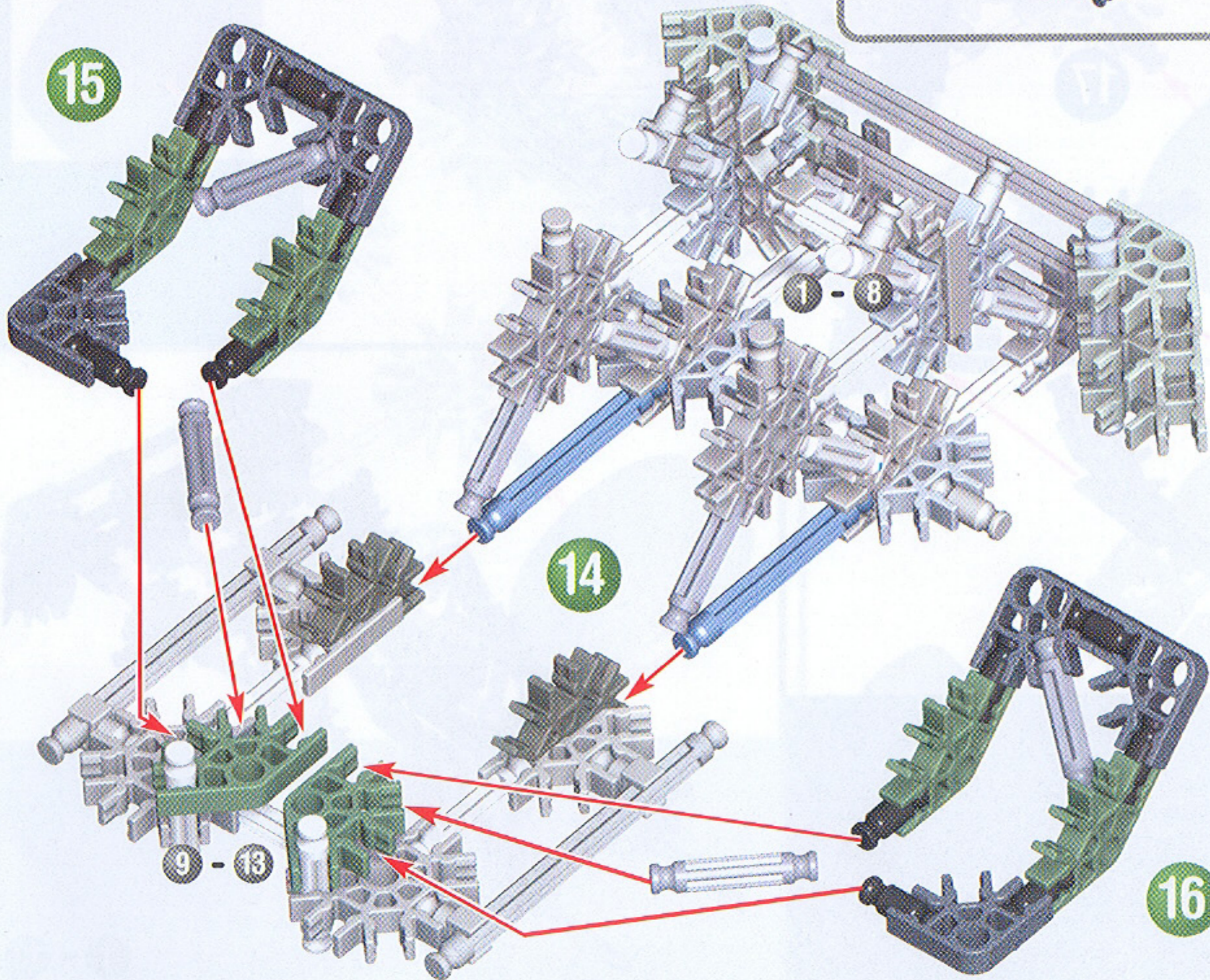

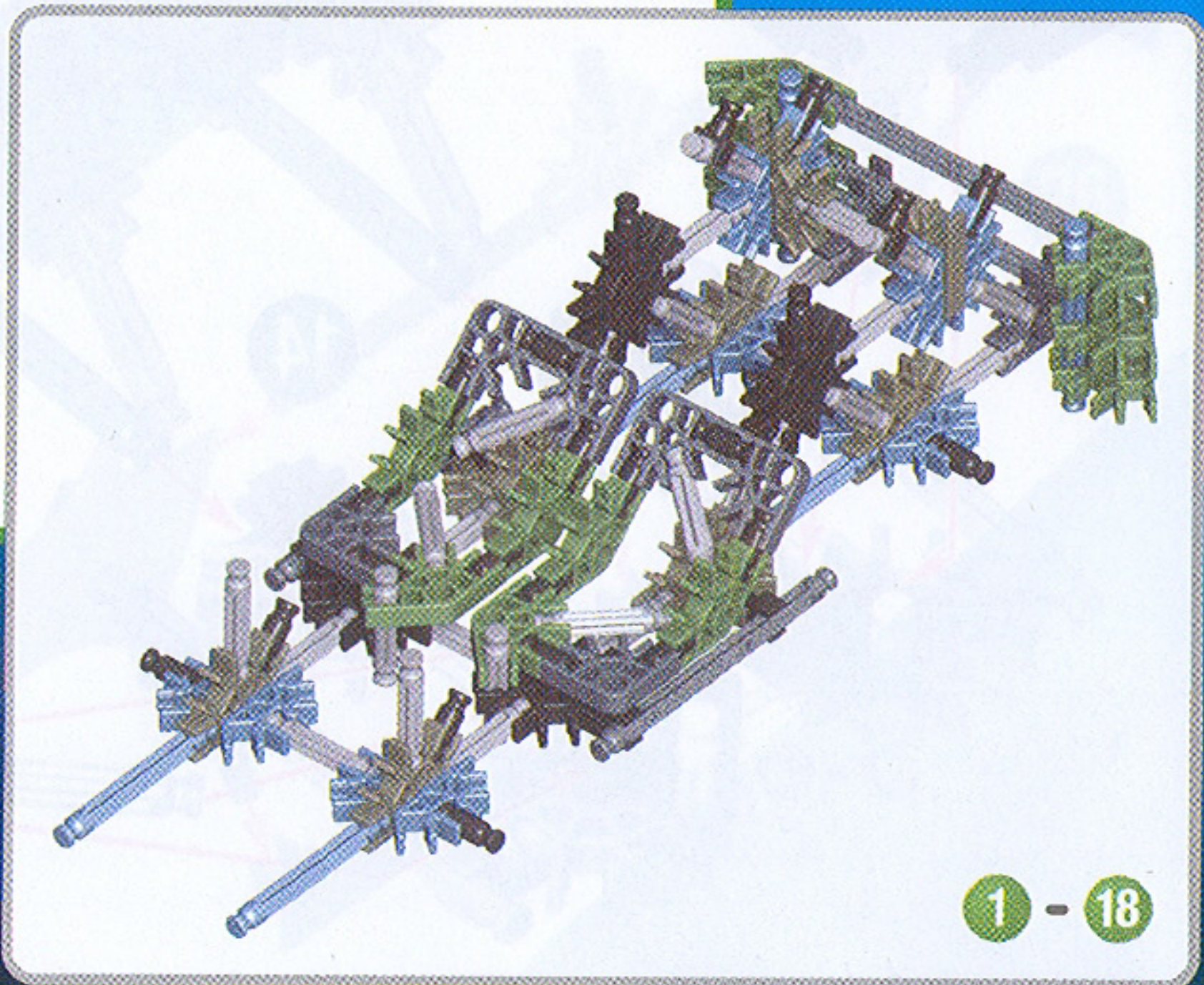
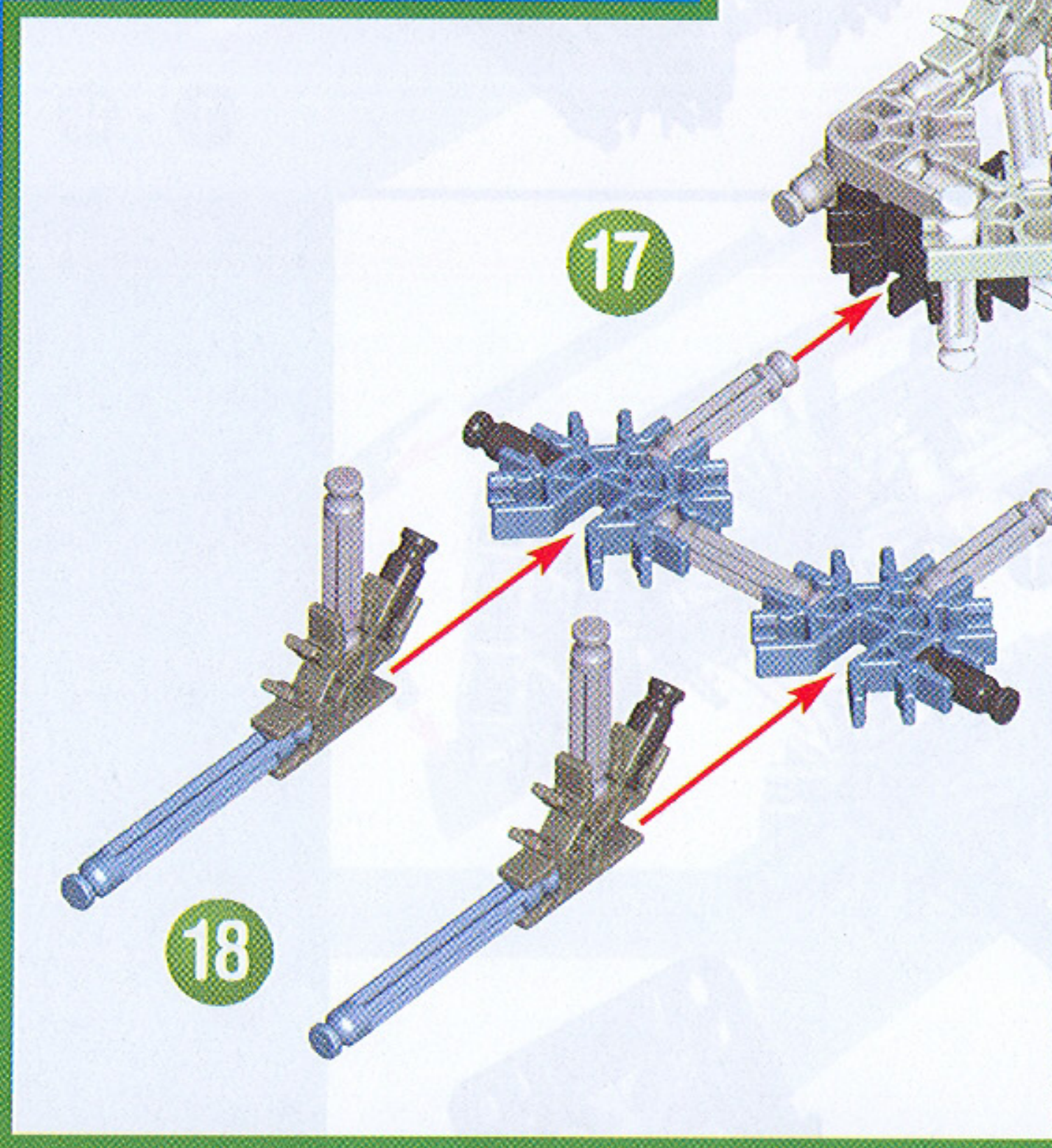
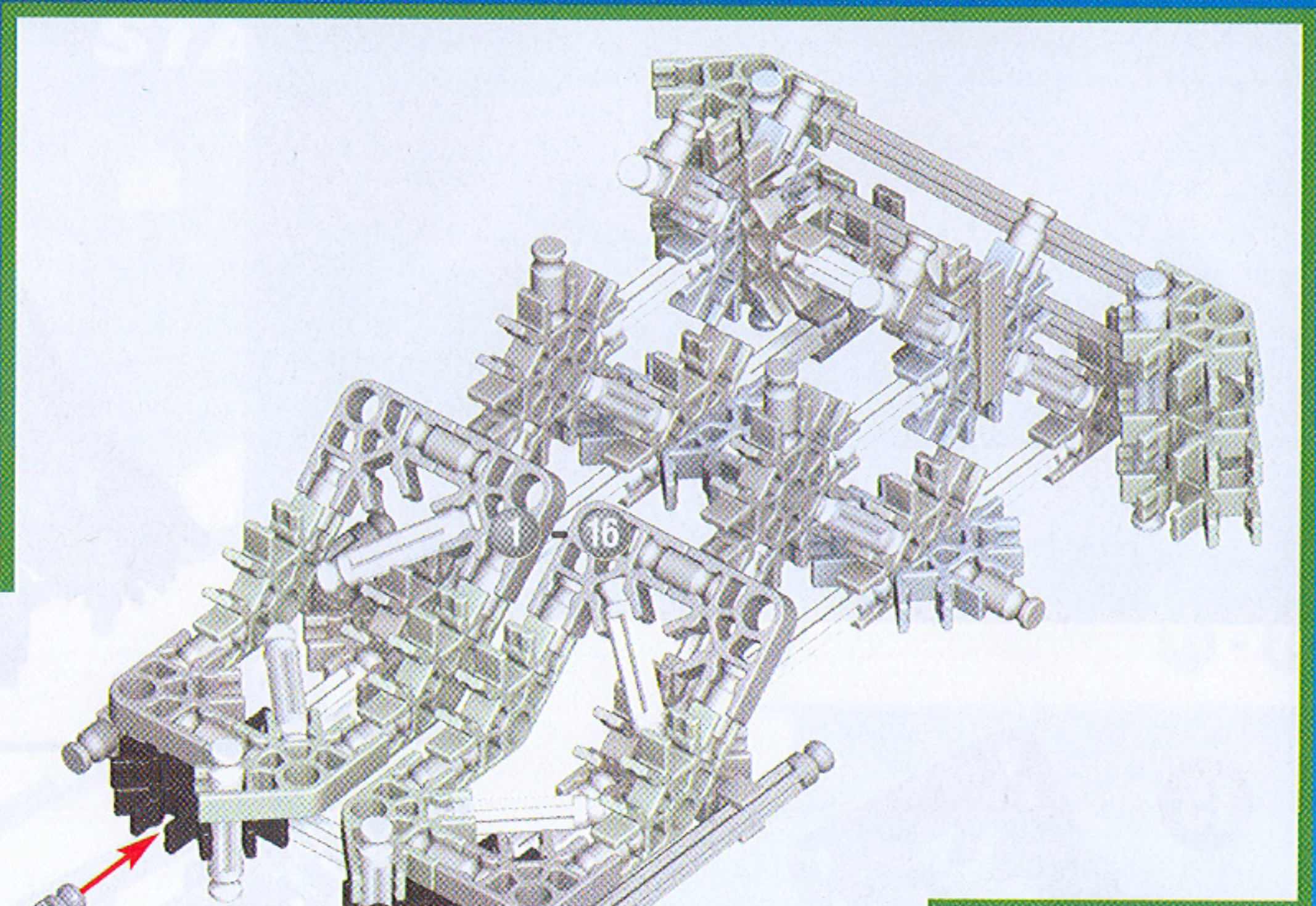

1 - 18

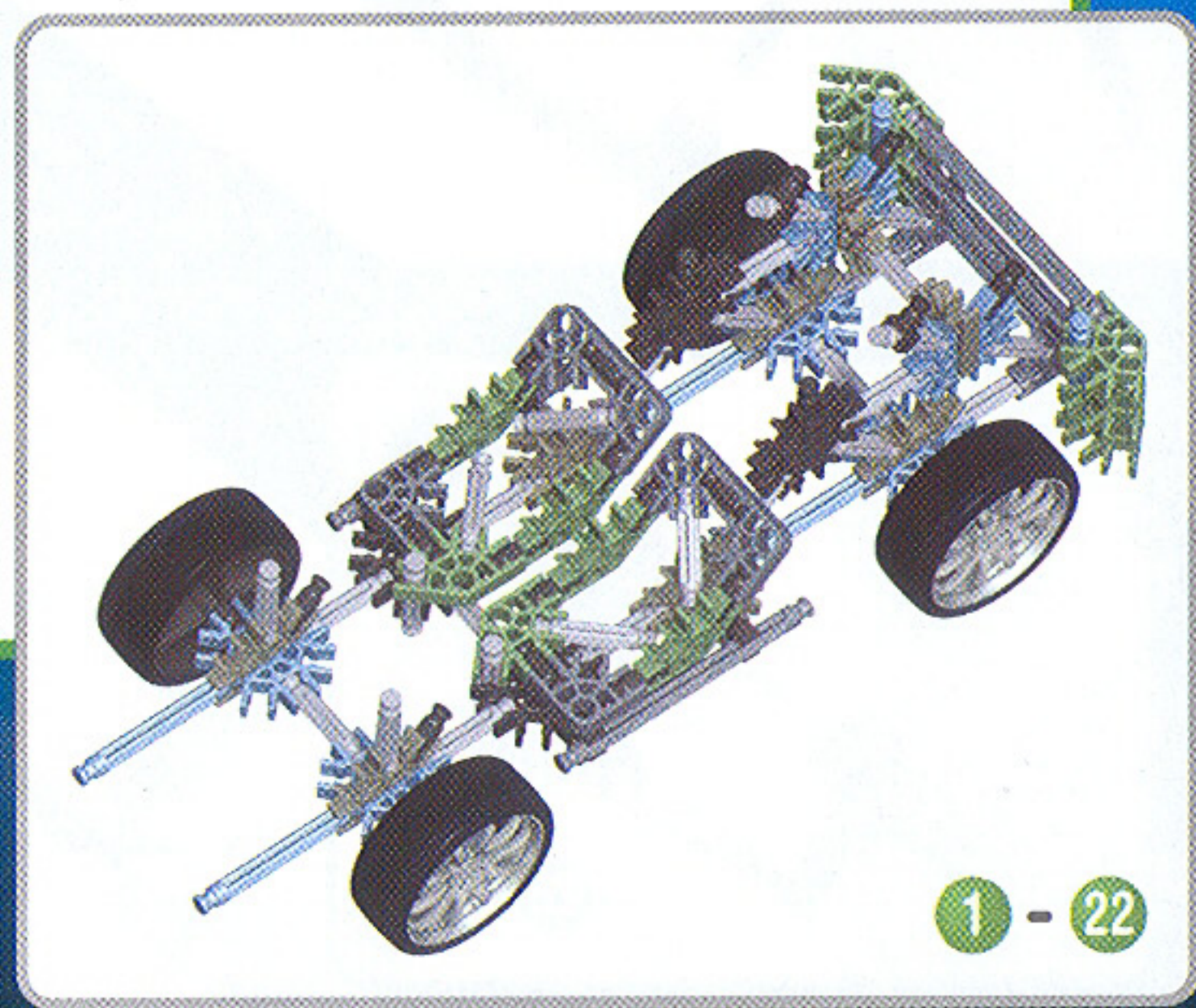
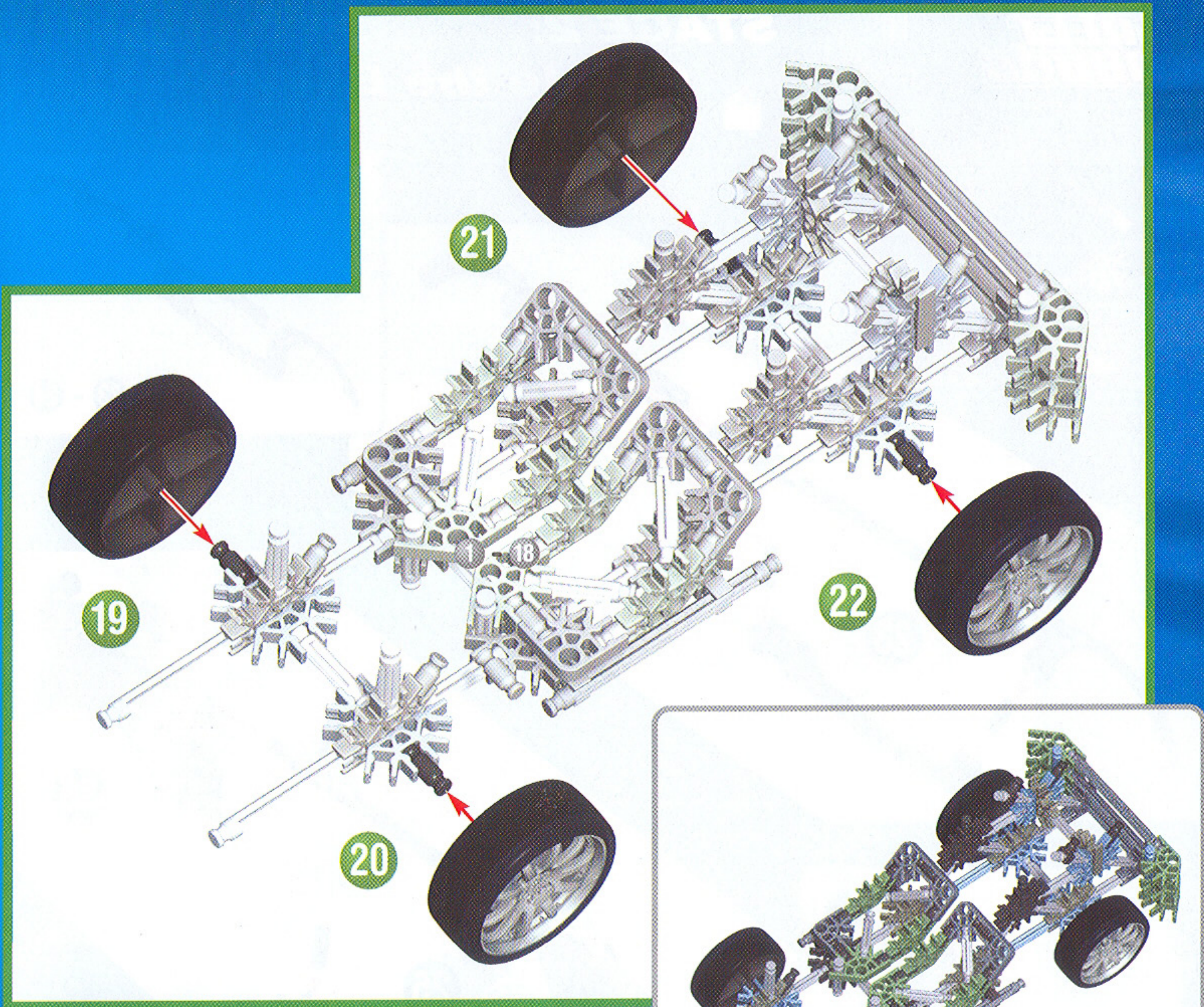

**STAGE 2:
Create the Body**



24

23 - 24



23



25 - 26

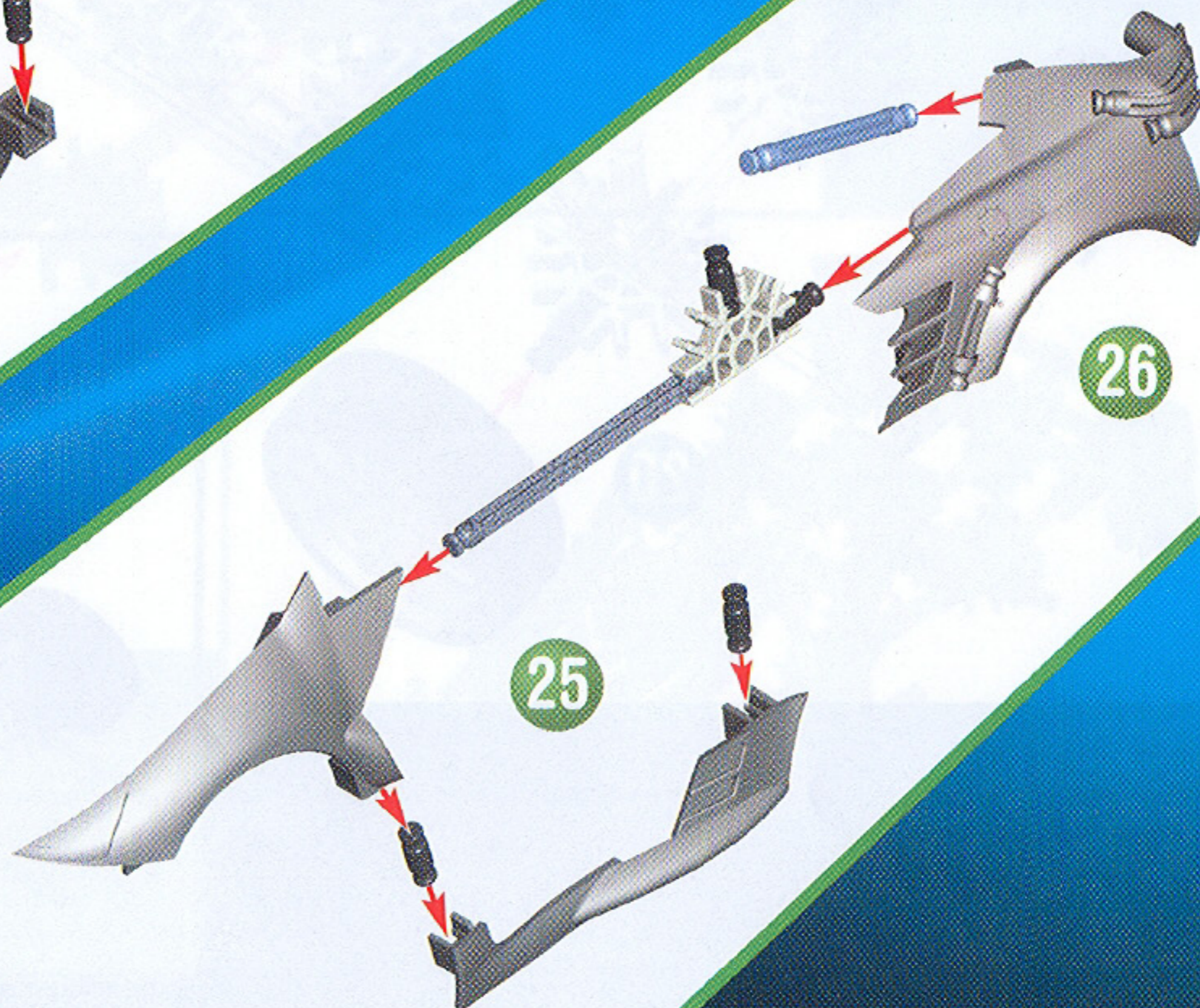

25

26

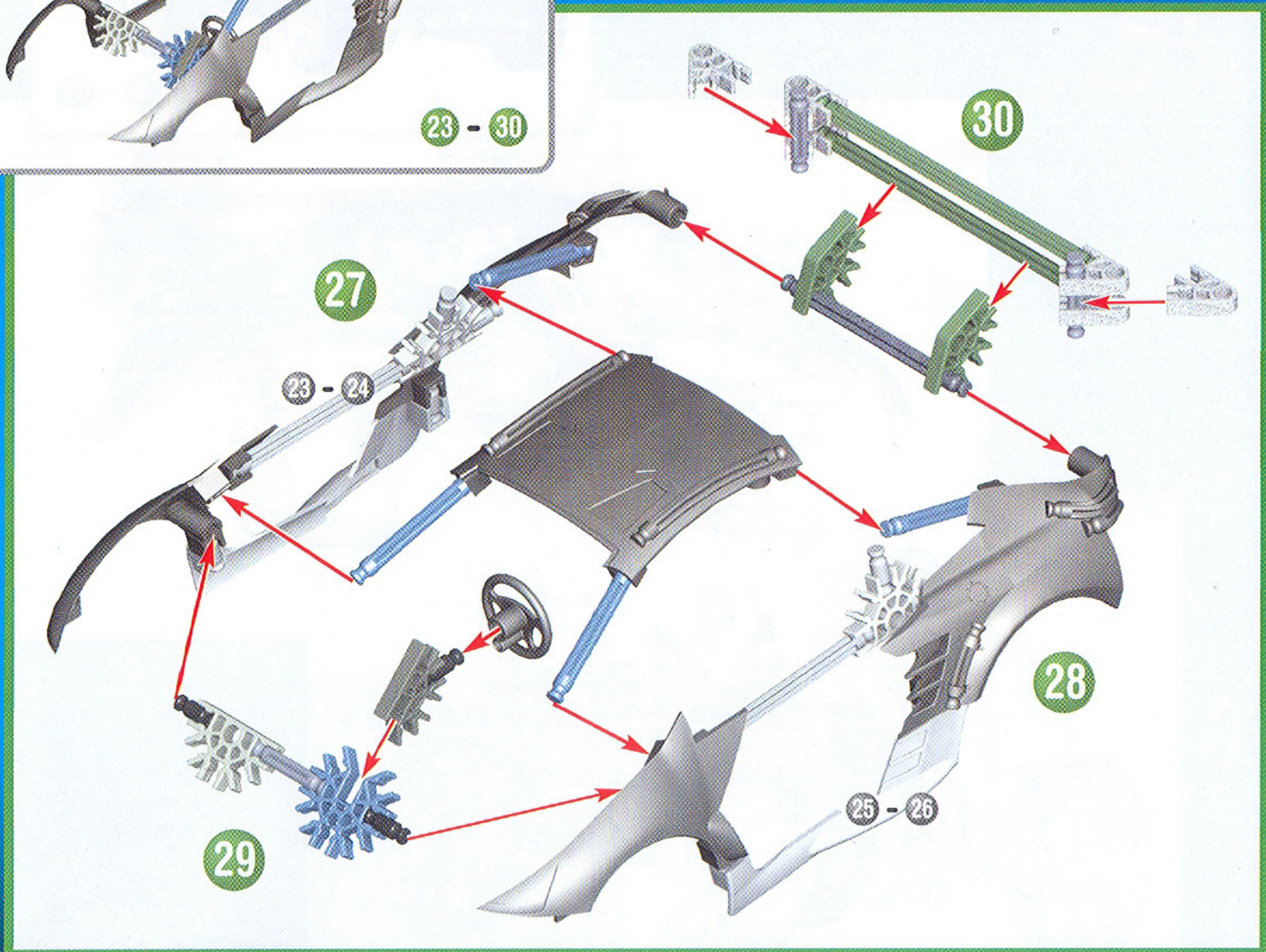
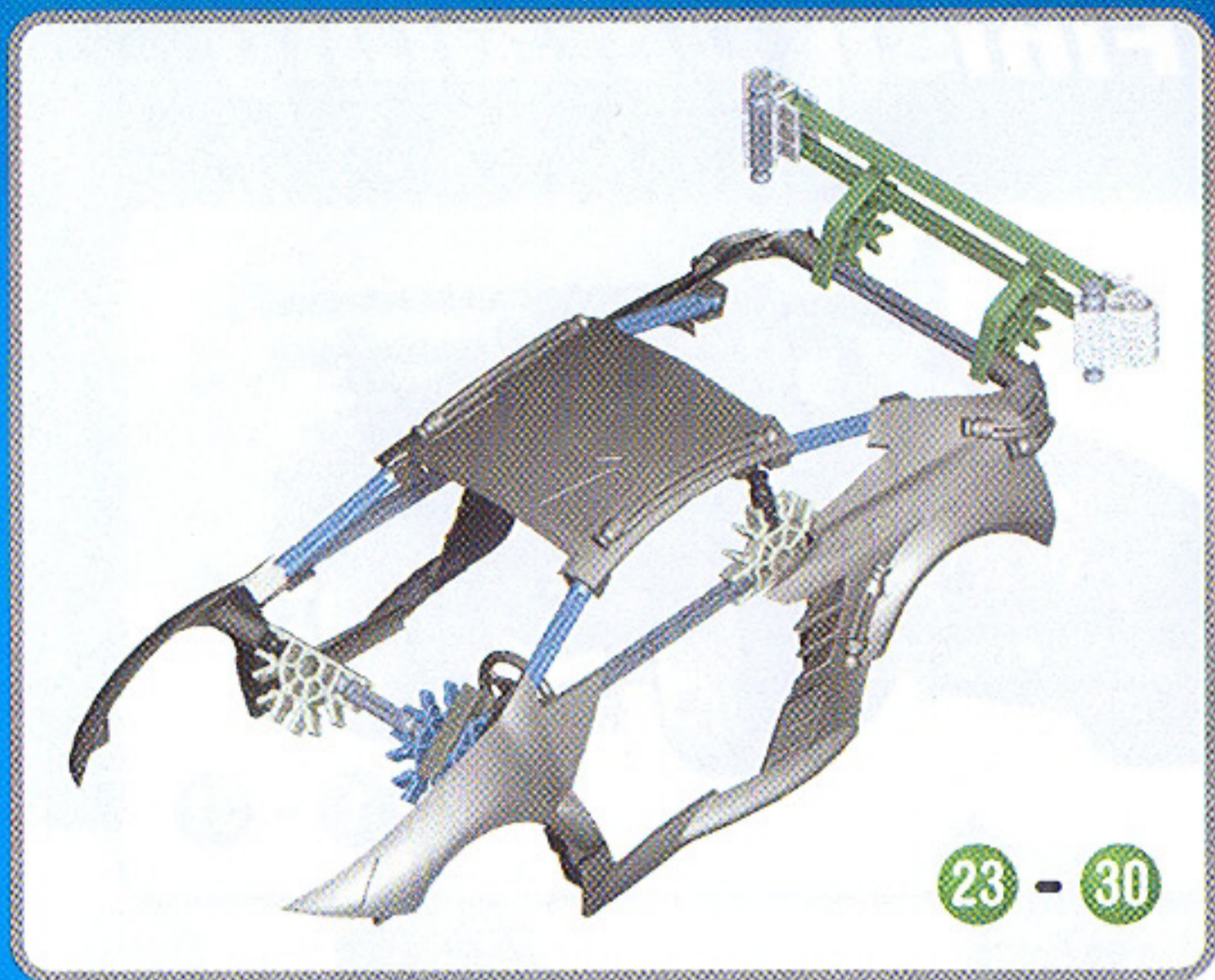

STAGE 3: Finish Detailing

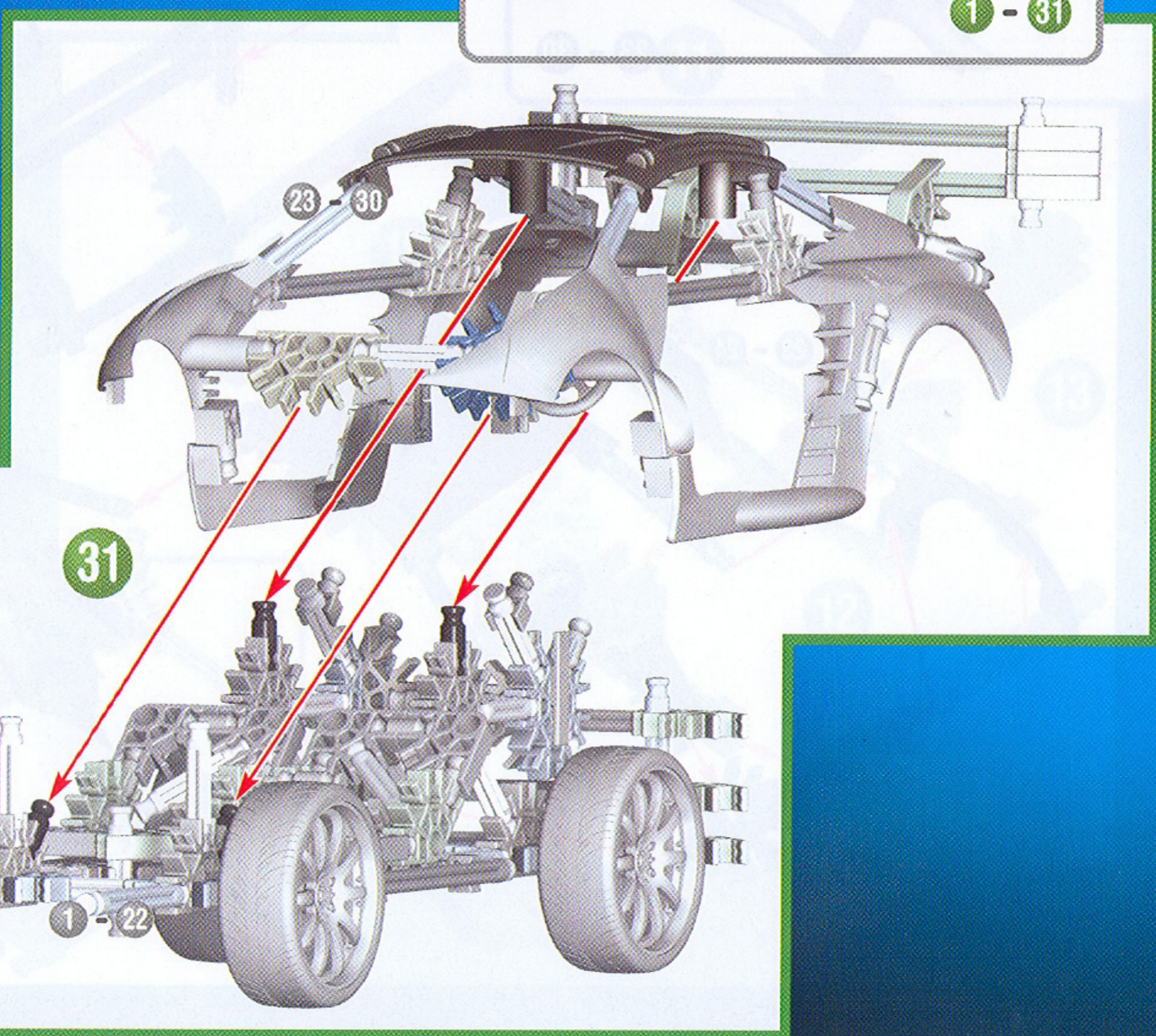
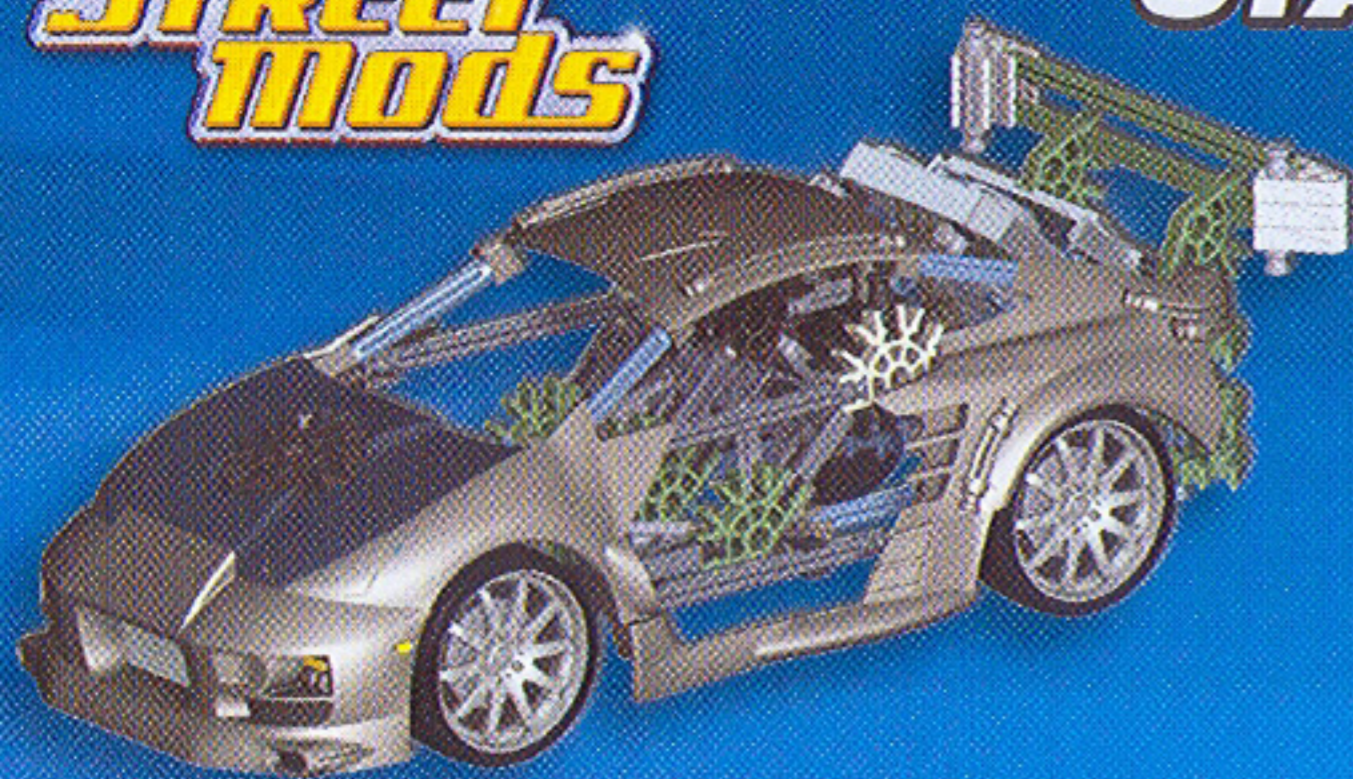

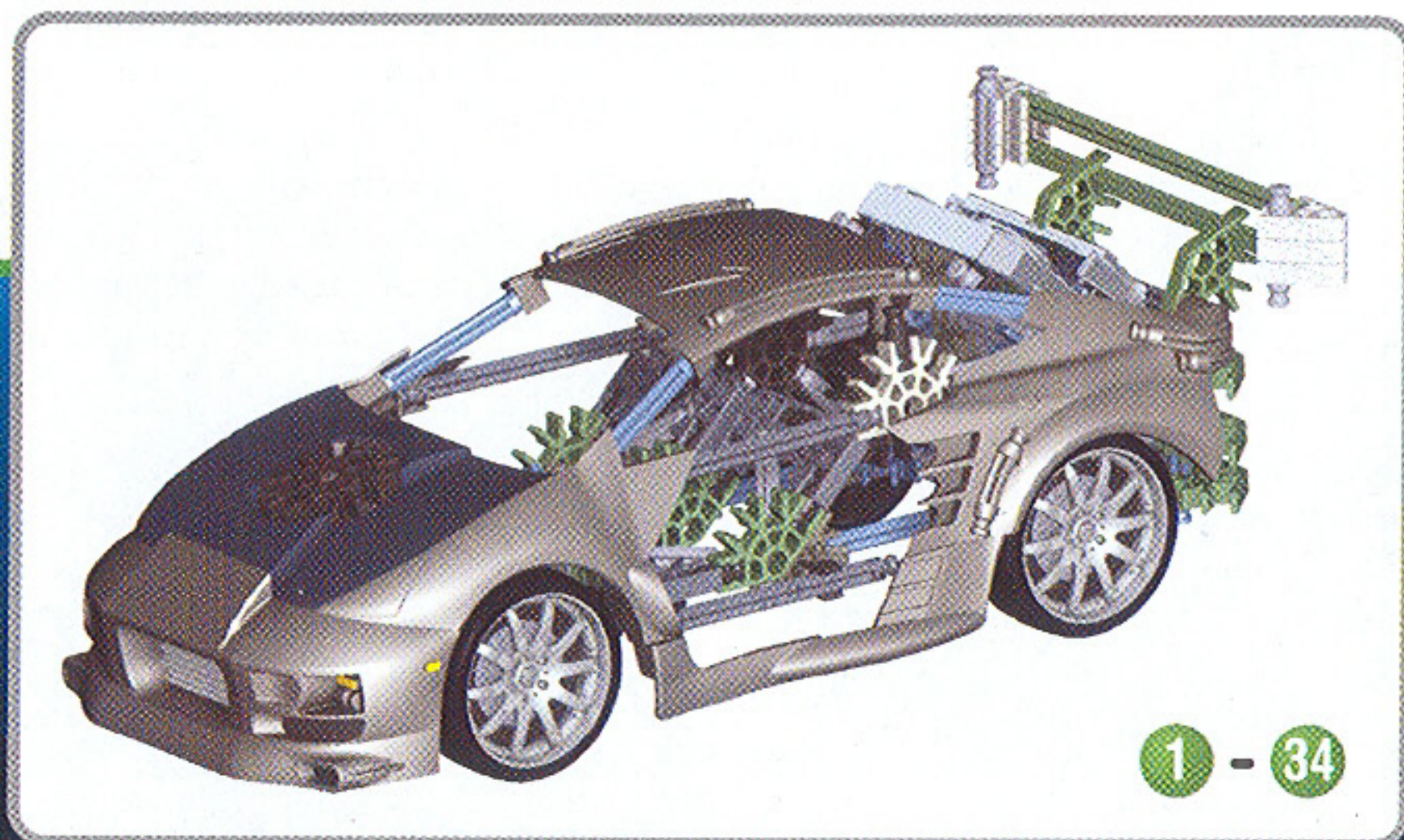
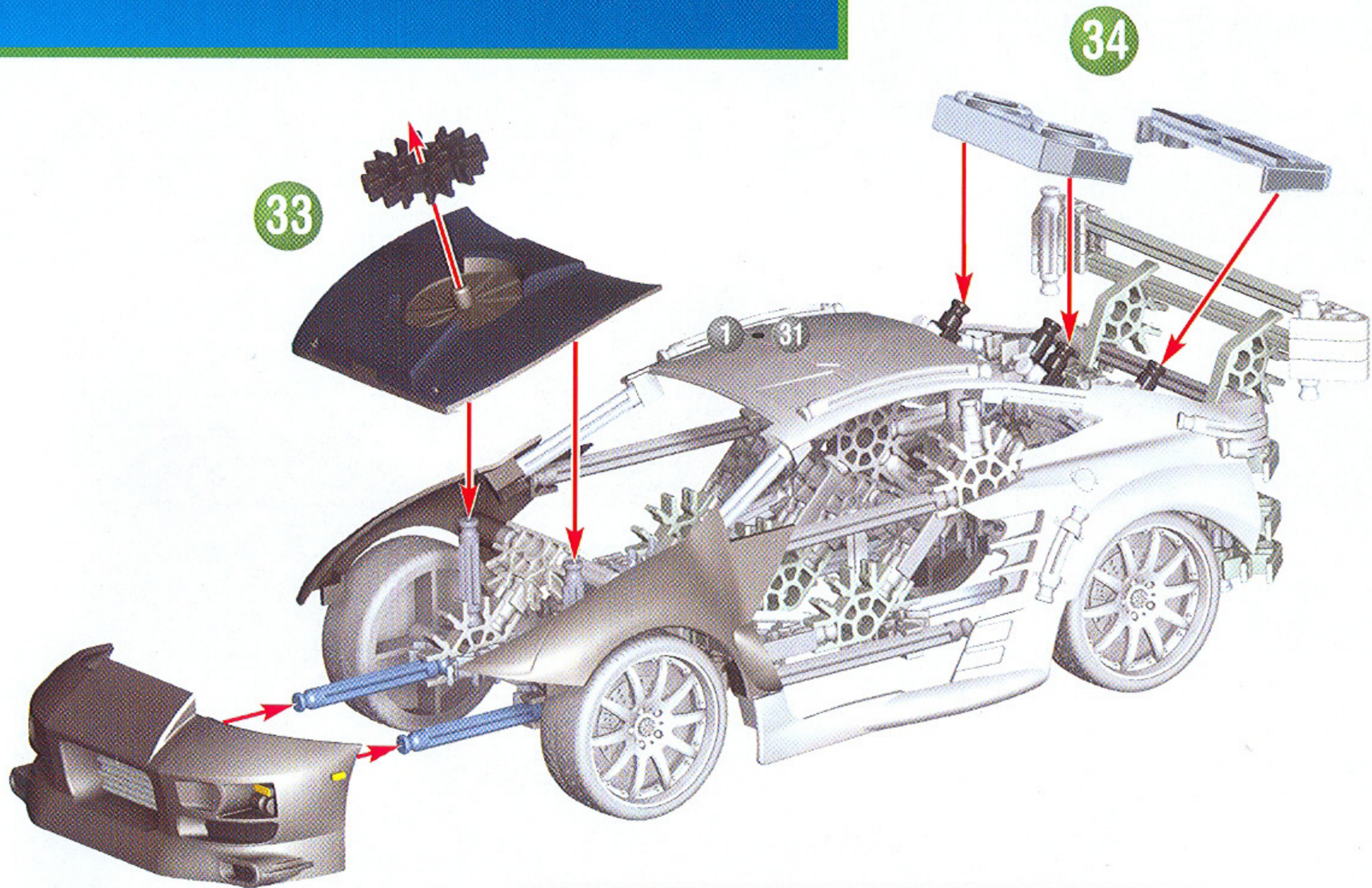

**STREET
MODS**

**BUILDING
IDEA**



**Cars sold separately.
Vendu séparément.
Se vende por separado.**

F Prêt à Monter

Pour commencer ton modèle, trouve le **1** et suis les chiffres. Chaque pièce a sa propre forme et sa propre couleur. Il suffit de regarder les illustrations pour retrouver les pièces correspondantes dans le jeu et de les connecter ensemble. Essaie de situer ton modèle dans le même sens que les instructions durant le montage.

Suite...

Les couleurs dégradées indiquent que cette section est déjà montée. Tu dois connecter la section suivante à l'endroit indiqué par les flèches. Les nouvelles pièces ajoutées auront une couleur vive.

Encastrement en travers

Lorsqu'un connecteur s'encastre en travers d'une tige, on parle de « encastrement en travers ». Il faut parfois pousser vraiment fort pour encastrer ces éléments en travers et tu devras alors peut-être demander à un adulte de t'aider.

Connecteurs

Il y a des connecteurs bleus et argentés comportant de longues fentes. Ils s'ajustent l'un dans l'autre comme l'indique l'illustration. Pousse ces pièces ensemble jusqu'à ce que tu entendes un "clic".

E O Todo Listo, Comienza a Construir

Para comenzar tu modelo, busca el **1** y sigue los números. Cada pieza tiene su propia forma y color. Simplemente mira los dibujos, busca las piezas correspondientes en tu juego y después conéctalas. Mientras construyes, trata de colocar tu modelo en la misma dirección que se muestra en las instrucciones.

Continúa

Los colores desteñidos muestran que esta sección ya está construida. Conecta las nuevas secciones en los lugares señalados por las flechas. Las nuevas piezas que agregues estarán en colores vivos.

Abrochado cruzado

Cuando un conector se abrocha desde un lado al otro de una varilla, lo llamamos un "abrochado cruzado". Los abrochados cruzados algunas veces requieren un empuje fuerte y quizás tú quieras pedir la ayuda de un adulto.

Conectores

Hay conectores azules y plateados con ranuras largas especiales. Se enganchan deslizándose como ves en los dibujos. Conecta estas piezas empujándolas hasta que oigas "clic".

D Auf Die Plätze, Fertig, Los! Das Bauen Beginnt

Um mit dem Bauen deines Modells zu beginnen, suche die Nummer **1** und folge den laufenden Nummern. Jedes Teil hat seine eigene Form und Farbe. Schau dir einfach die Abbildungen an, such die Teile in deinem Bausatz, die so aussehen wie das, was du auf der Abbildung siehst und steck sie ineinander. Versuche, dein Modell beim Zusammenbauen so zu orientieren, dass es in die gleiche Richtung weist, wie es in den Anleitungen beschrieben und gezeigt wird.

Und Weiter Geht's

Blasse Farben weisen darauf hin, dass dieser Streckenabschnitt bereits zusammengebaut ist. Der neue Streckenabschnitt wird dort befestigt, worauf die Pfeile deuten. Die neuen Teile, die du anbaust, sind knallbunt angezeigt.

Überkreuz

Wenn ein Verbindungsstück quer über einem Stab einrastet, dann rastet es "überkreuz" ein. Für solche überkreuz einrastenden Teile braucht man mehr Kraft und vielleicht muss ein Erwachsener dabei helfen.

Steckanschlüsse

Blaue und silberfarbene Steckanschlüsse haben besonders lange Schlitzlöcher. Wie du auf der Abbildung sehen kannst, lassen sie sich ineinander schieben. Achte beim Aneinanderfügen dieser Teile darauf, dass du ein Klickgeräusch hörst. Erst dann sind die Teile fest miteinander verbunden.

NL Klaar om te Bouwen

Om met je model te beginnen, vind eerst het nummer **1** en volg de nummers. Elk stuk heeft zijn eigen vorm en kleur. Kijk gewoonweg naar de afbeeldingen, vind de overeenstemmende stukken terug in je geheel en maak ze aan mekaar vast. Tracht je model in dezelfde richting te plaatsen als de aanwijzingen terwijl je bouwt en monteert.

Verder Nog ...

De vervaagde kleuren duiden aan dat dit deel reeds is opgebouwd. Gelieve het nieuwe deel vast te koppelen op de plaats aangeduid door de pijlen. De nieuwe delen die je toevoegt verschijnen in volle kleur.

Dwarsklikker

Wanneer een connector dwars over een staafje klikt, wordt het een "cross-snap" (dwarsklikker) genoemd. Daarvoor is een sterke duw nodig en moet je misschien aan een volwassene vragen om even te helpen.

Connecteurs

Er zijn blauwe en zilverkleurige koppelstukken met speciale lange gleuven. Ze schuiven in mekaar zoals je kunt zien op de afbeeldingen. Duw deze onderdelen in mekaar tot je een "klik" hoort.

I Pronti, Partenza, Via alla costruzione

Per iniziare il modello, cerca il numero **1** e segui i numeri. Ogni pezzo ha una sua forma e un suo colore. Guarda la figura, trova i pezzi corrispondenti nel set e mettili insieme. Cerca di tenere il modello nella stessa direzione della figura e in tal modo sarà più semplice attaccare i pezzi nei posti giusti.

Andiamo avanti

I colori spenti ti dicono che questa sezione è già stata costruita. Dovrai collegare la nuova sezione al punto indicato dalla punta della freccia. Questo pezzo avrà un colore brillante.

Scatto trasversale

Quando un connettore si blocca con uno scatto diagonalmente ad un'asta, lo si chiama collegamento a "scatto trasversale". I collegamenti con scatti trasversali talvolta richiedono una forte spinta, quindi potrebbe essere necessario l'aiuto di un adulto.

Connettori

È molto importante posizionare i connettori blu e argento in una specifica direzione. Presta molta attenzione alle istruzioni e posiziona i connettori orizzontalmente o verticalmente proprio come illustrato. Spingi con forza fino ad udire un clic.

P Estás pronto? Começa pois a construir

Para começar o teu modelo, procura o **1** e segue os números. Cada peça tem a sua própria forma definida e cor. Basta simplesmente olhares para a ilustração, procurar as peças do teu jogo correspondentes às que estás a ver e, em seguida, conectar umas nas outras. Enquanto estás a montar as peças, tenta manter o teu modelo na mesma direcção, conforme mostrado na ilustração, para assim ligares as peças correctamente.

Continuando

As cores desbotadas indicam que esta secção já está montada. Passarás então a fazer a conexão da nova secção no local indicado pelas setas. Esta peça terá uma cor viva.

Encaixe transversal

Quando um Conector se encaixa através de uma Biela, tal é referido como "encaixe transversal". Os encaixes transversais por vezes necessitam uma pressão intensa pelo que poderás querer pedir a ajuda de um adulto.

Conectores

É muito importante que posicione os conectores azuis e cor de prateados numa direcção específica. Presta muita atenção às instruções e coloca estes conectores horizontal ou verticalmente, exactamente conforme se mostra nas ilustrações. Junta as partes simultaneamente e com firmeza até ouvires um "estalido".



**Customer Service outside the USA, CAN, GBR
please contact local distributor.
Distributor information can be found at:
<http://www.knex.com/contact/international.php>**

**Le Service clients hors d'USA et CAN, s'il vous plaît
contacter le distributeur local. L'information de
distributeur peut être trouvée à
<http://www.knex.com/contact/international.php>**



1-800-KID-KNEX USA/Canada only (English only)



email@knex.com



**Consumer Services
K'NEX Industries, Inc.
P.O. Box 700
Hatfield, PA 19440-0700**



Product and colors may vary.
Models can be built one at a time.

Le produit et les couleurs peuvent varier.
La plupart des modèles ne peuvent être construits
que un à un.

El producto y los colores podrán variar.
La mayoría de los modelos se puede construir uno a la vez.

Conforms to the Requirements of ASTM Standard
Consumer Safety Specification on Toy Safety, F963-03.

Conforme aux spécifications de sécurité du consommateur
sur la sécurité des jouets de la norme ASTM F963-03.

Cumple con los requisitos de la Norma F963-03,
[Especificación para consumidores sobre la
seguridad de juguetes], de la ASTM.

Manufactured under U.S. Patents/
Fabriqué sous brevets américains

5,061,219; 5,137,486; 5,199,919; 5,346,420; 5,350,331;
5,368,514; 5,421,762; 5,423,707; 5,427,559; D383,509;
D388,475; D389,203; D391,843; D392,555; D403,722;
5,913,706; 6,089,941.

Other U.S. and foreign patents pending.
Autres brevets américains et étrangers en instance.

©2006 Axis logo, wheel design and photography
used with Permission of Axis Sport Tuning.

©2006 Le logo Axis, la conception de roue et
la photographie a utilisé.

©2006 Logo de eje, el diseño de la rueda y la
fotografía con el permiso de Eje
la Axis Sport Tuning.

www.axiswheels.com



©2006 K'NEX Industries, Inc.
P.O. Box 700
Hatfield, PA 19440-0700

406460.11/406461.11-V1-12/05