

K'NEX®

12024

speed-zone

JACK KNIFE

BIG RIG RACE TRANSPORT

Chrome-Look
EXHAUST PIPES!



Over 2 Feet Long!



WARNING:

CHOKING HAZARD – Small Parts.
Not for children under 3 years.



AVERTISSEMENT:

DANGER D'ÉTOUFFEMENT – Pièces de petite taille.
Ne pas donner aux enfants de moins de 3 ans.

CONTENTS

SPEED ZONE 2

Parts Check List 3

Building with K'NEX 3

**Building
Instructions:**

**JACK KNIFE
TRAILER** 5
10

LUG NUT 14

RACEWAY 18

TIRE RACK 22

JACK 25

Sticker Application 26

French Language 27

WELCOME

...to **SPEED ZONE** racing! You're in the driver's seat with models that are full of racing excitement! All **SPEED ZONE** sets feature cool stickers, realistic race styling, and special parts to give your model a custom look! Collect them all to build a world of racing fun!

The **JACK KNIFE** set lets you build a big rig race transport with a giant trailer you can use to carry the other **SPEED ZONE** racecars. It also includes special chrome-like exhaust pipes you can only get in this set! Just follow these easy building instructions, add the special pieces and stickers, and you're ready to head to the race!

The term "Jack Knife" is used to describe how a big rig truck wipes out...usually in the rain. More specifically, the cab and the trailer bend and make a "V" shape. Because a trailer is heavier than a cab, the trailer drags the cab backwards until the two come to a stop!

PARTS CHECK LIST

Before you start building, be sure to compare the parts in your case with the parts listed below. If anything is missing, call our Kid K'NEX hotline: 1-800-KID-KNEX (US and Canada only) from 8:30 am to 5:00 pm EST, Monday through Friday. Call us, we're here to help!

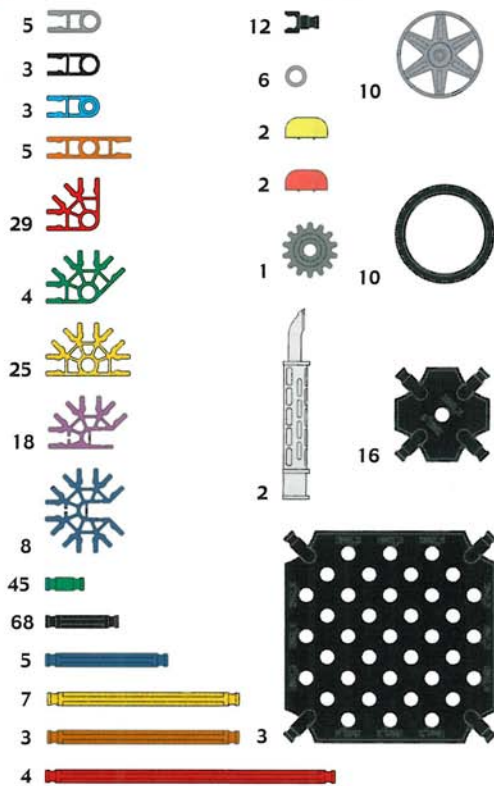

BUILDING WITH K'NEX



Hi! I'm your K'NEX mechanic. When you see me in the instructions, you'll want to pay close attention to the details being pointed out.

Ready, Set, Build

To begin your model, find the **1** and follow the numbers. Each piece

has its own shape and color. Just look at the picture, find the pieces in your set that match what you see, and snap them together.

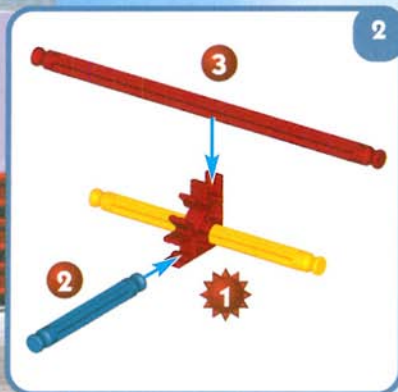

Try to hold your model in the same direction as in the picture so you'll attach your pieces to the right place.

JACK KNIFE

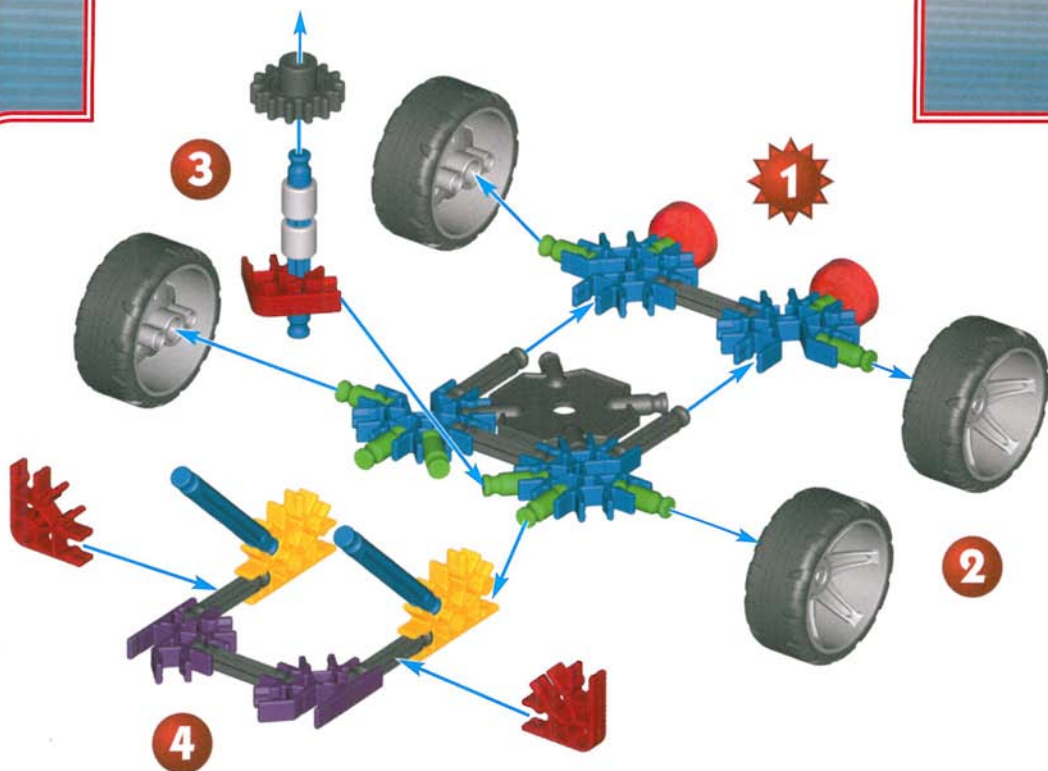
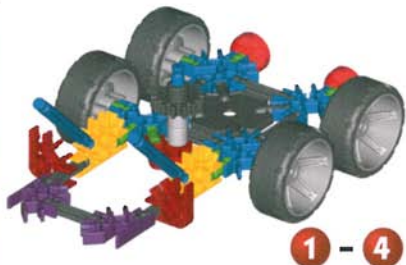

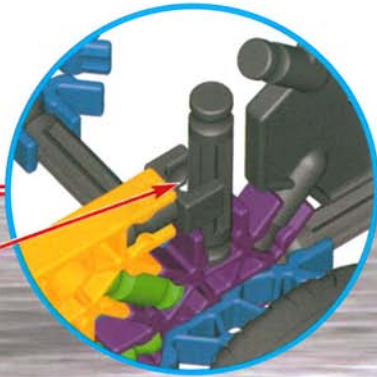
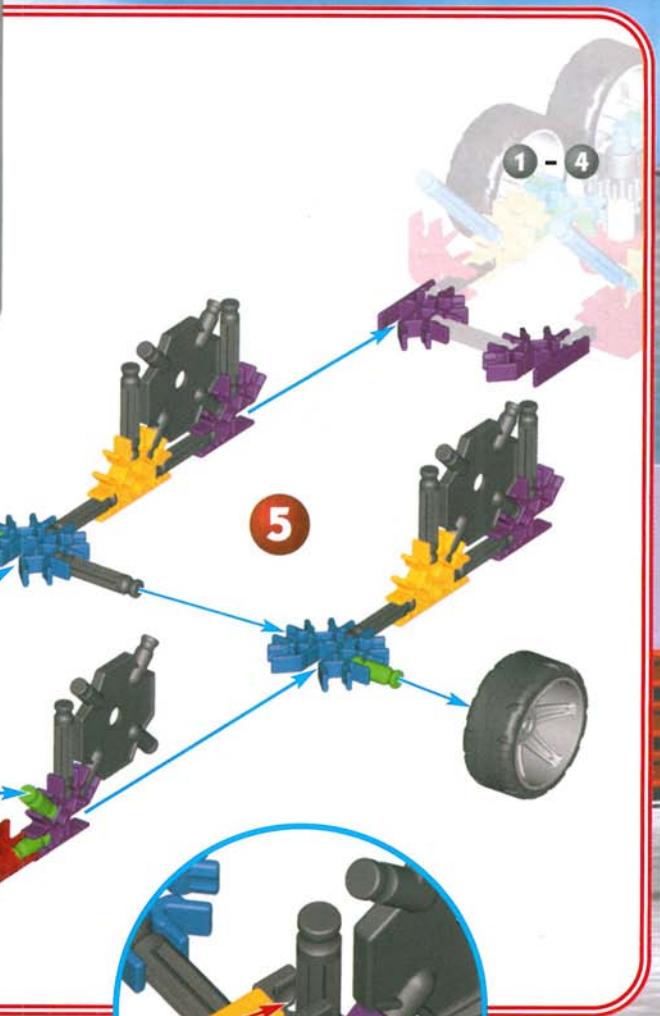

7

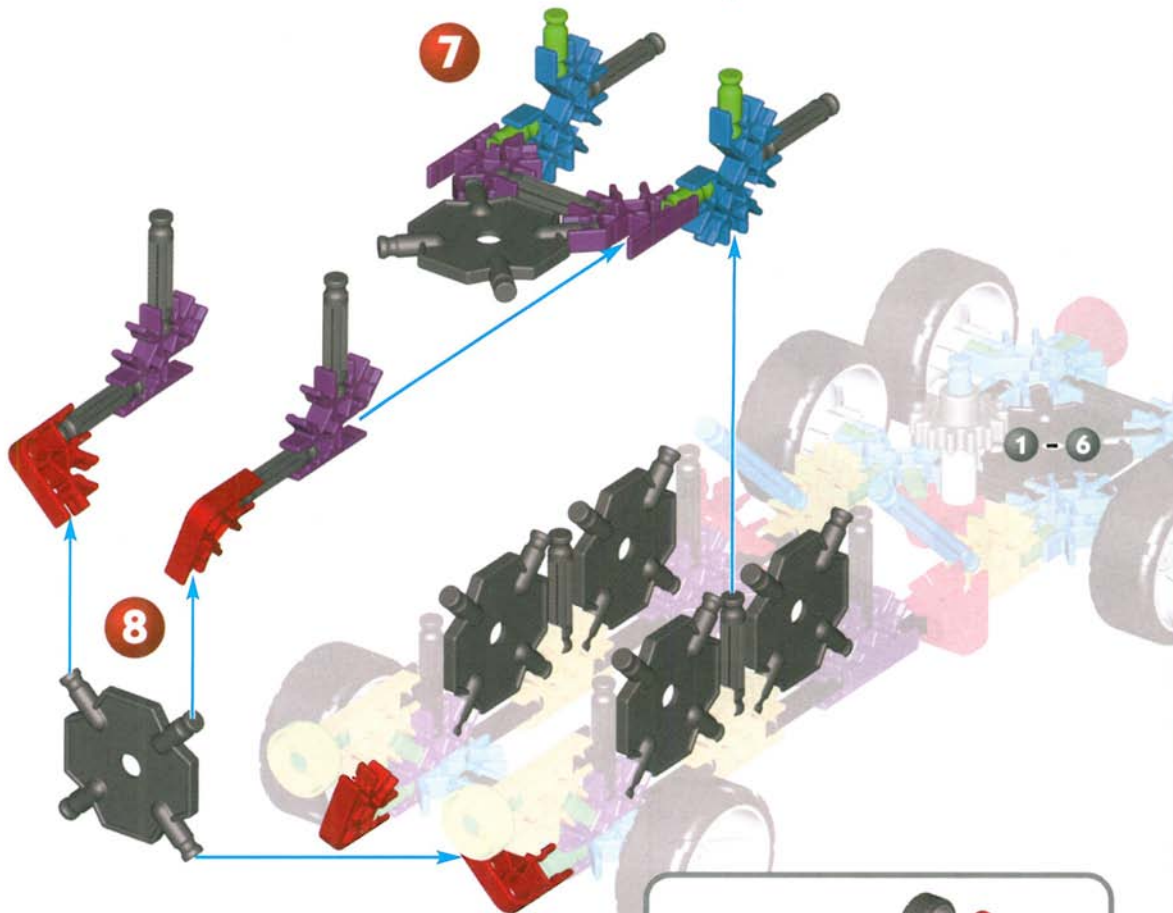

8

1 - 6

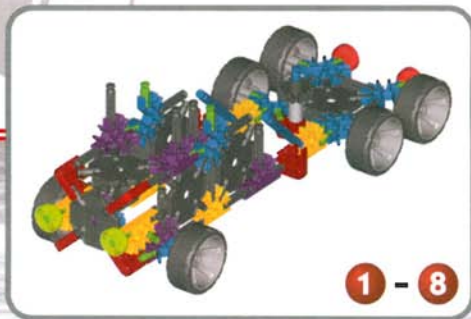

1 - 8

7

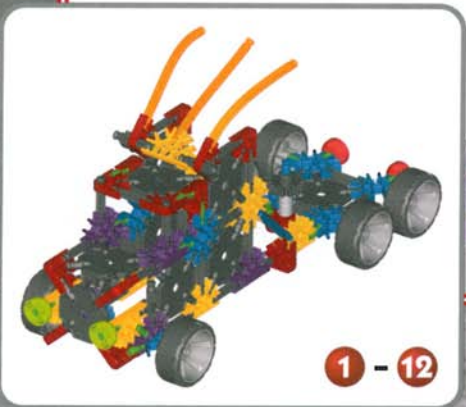
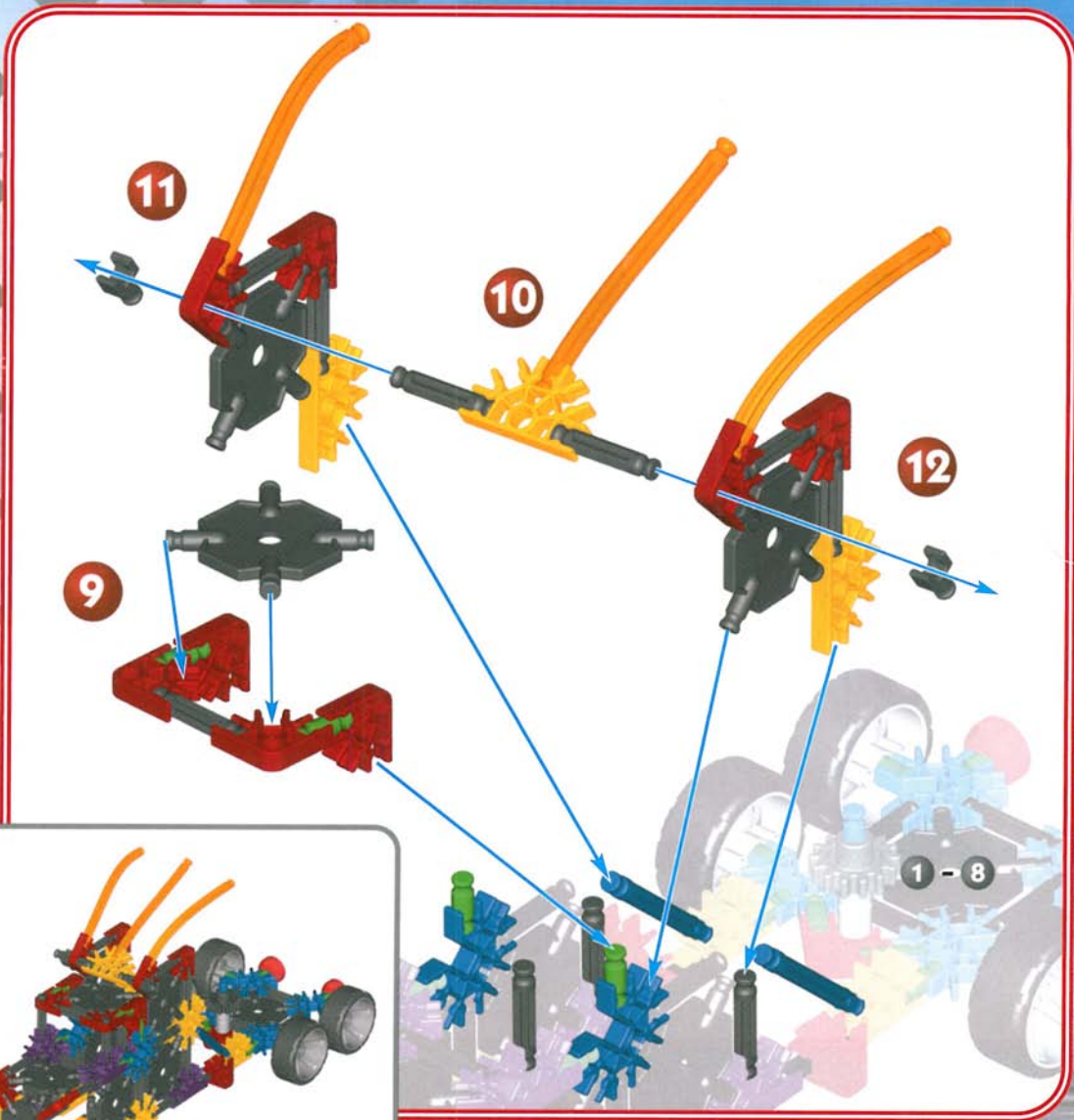

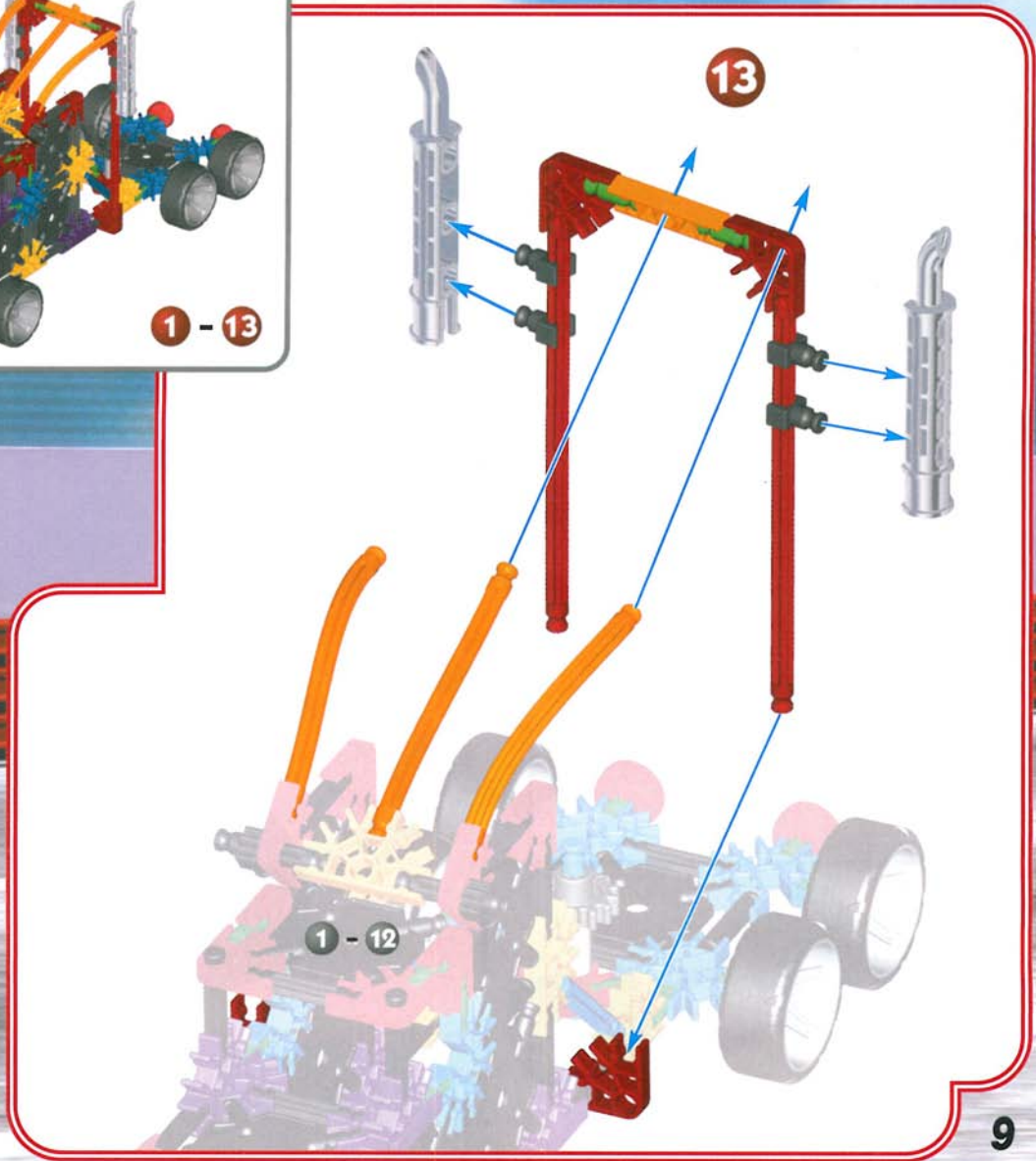

TRAILER

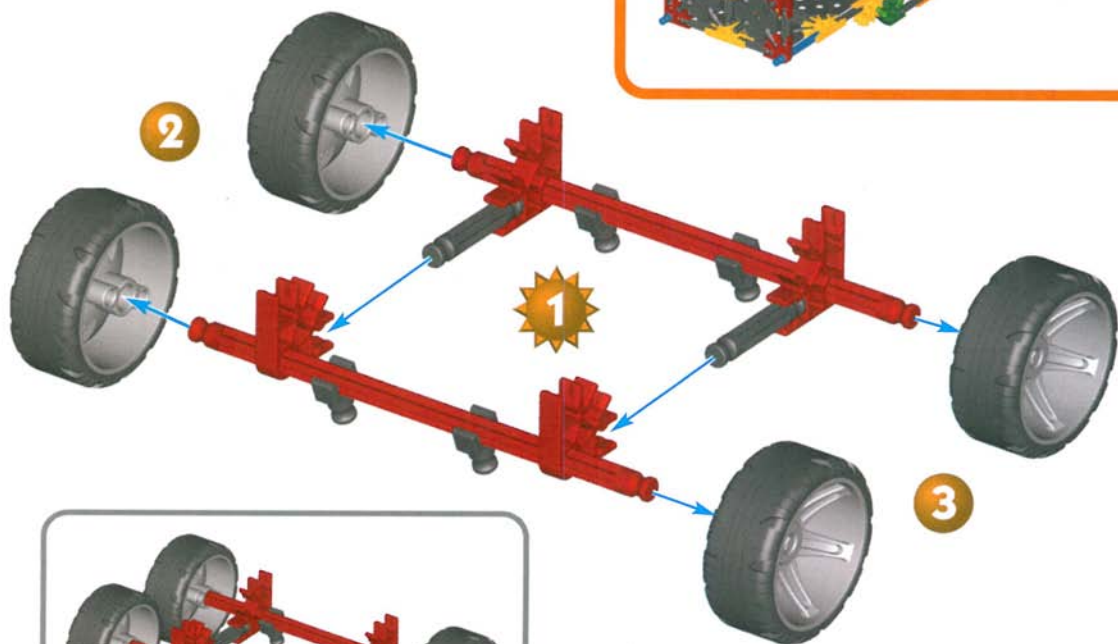
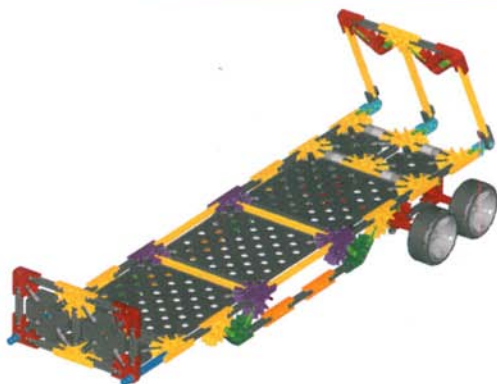

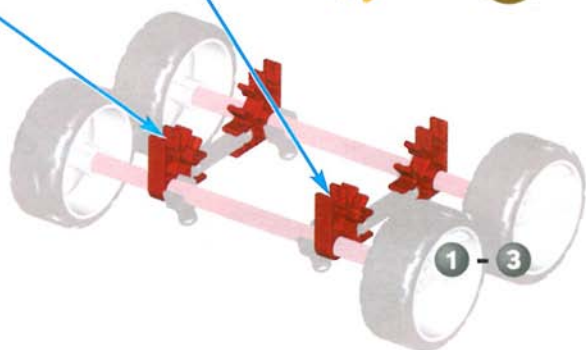
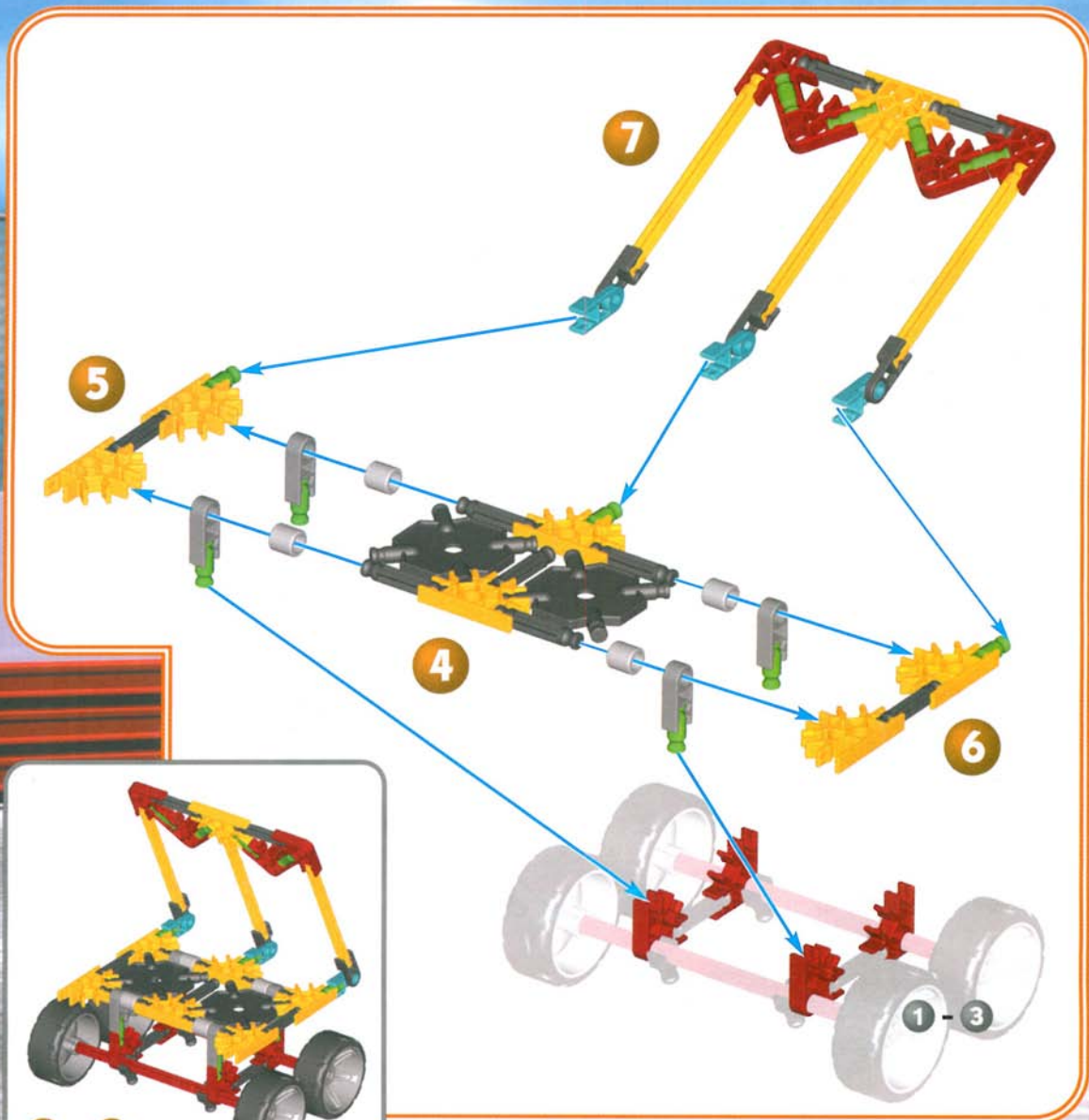

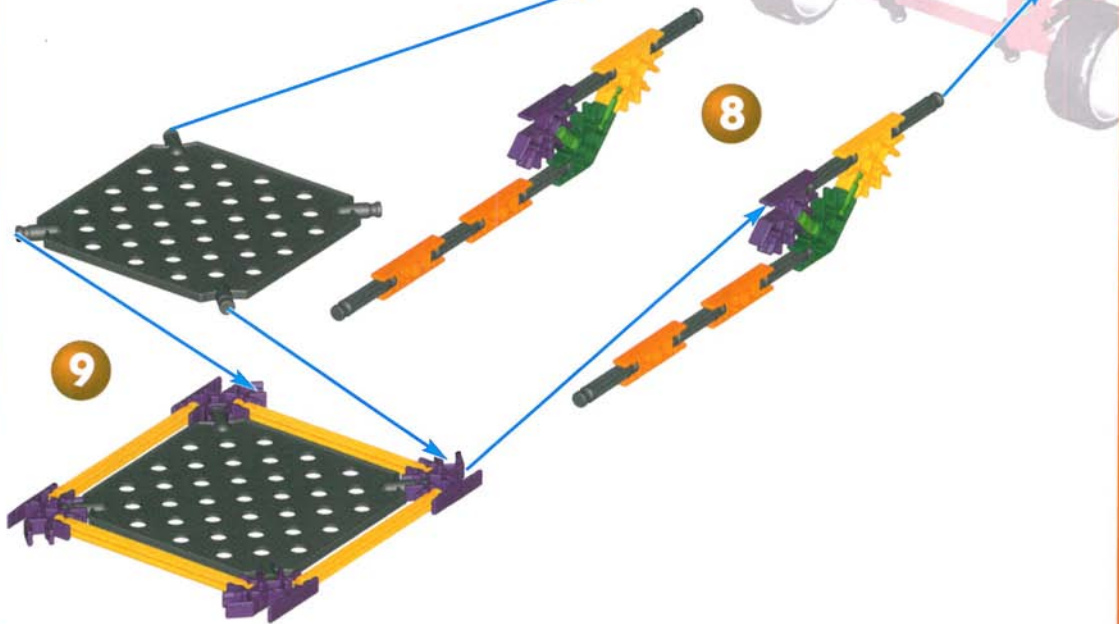
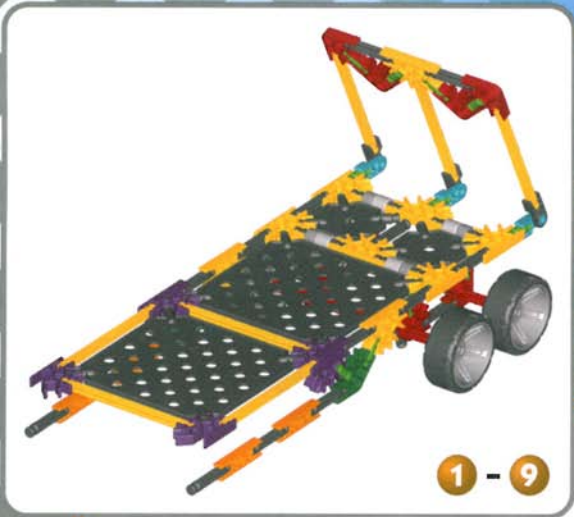

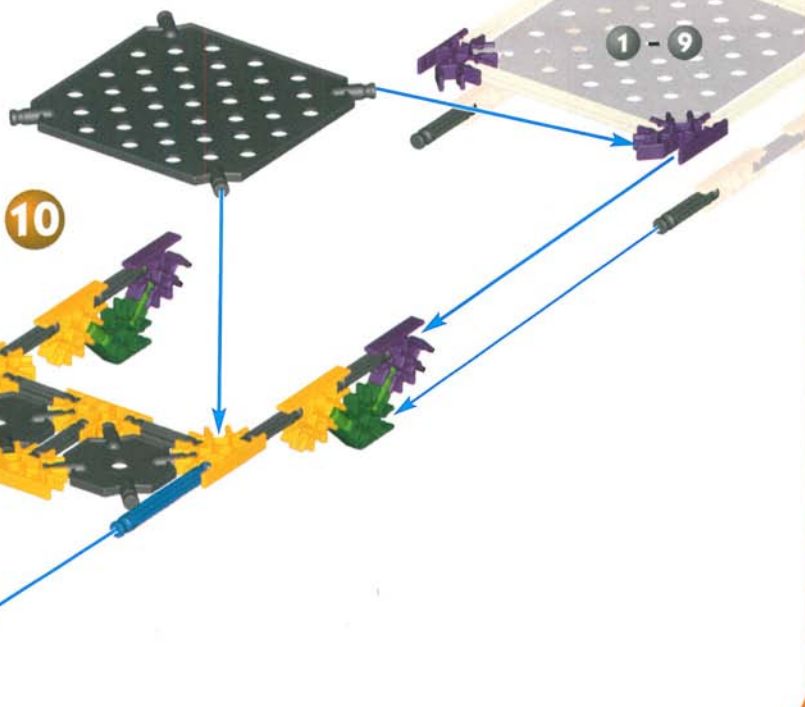
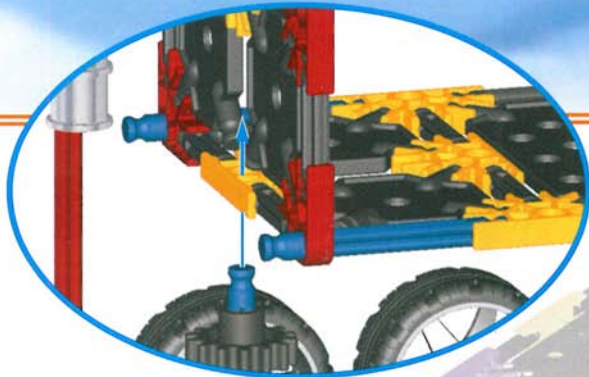
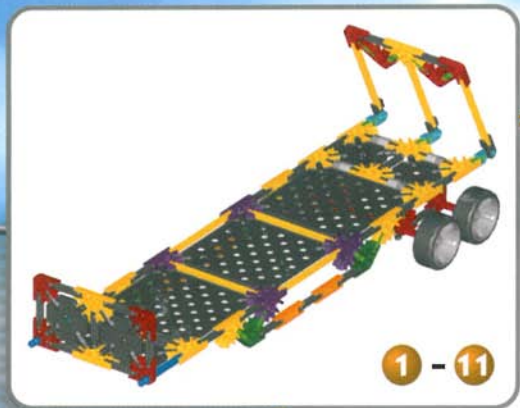

LUG NUT

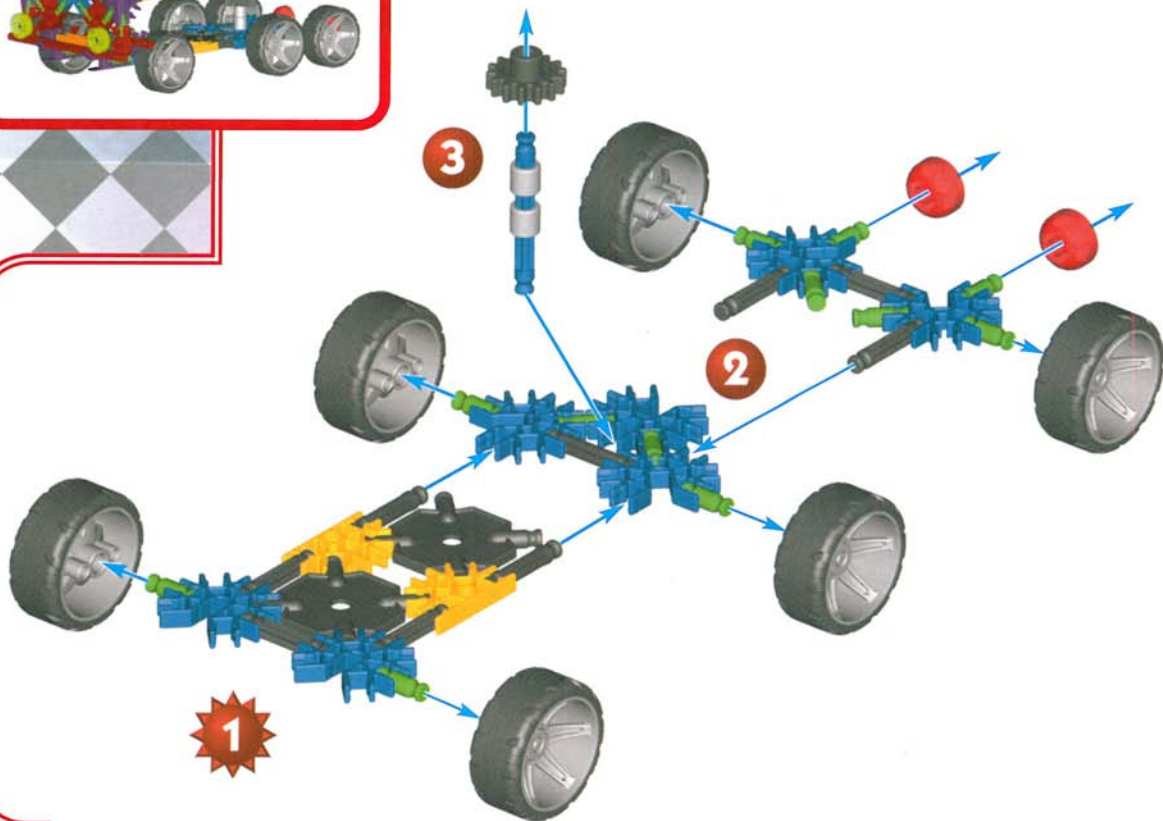
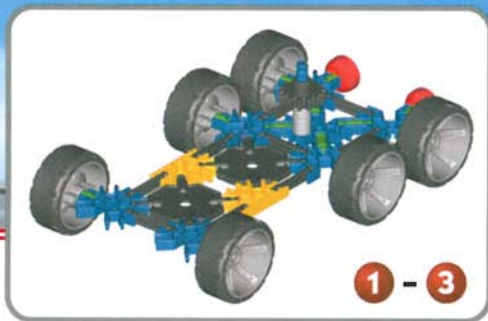

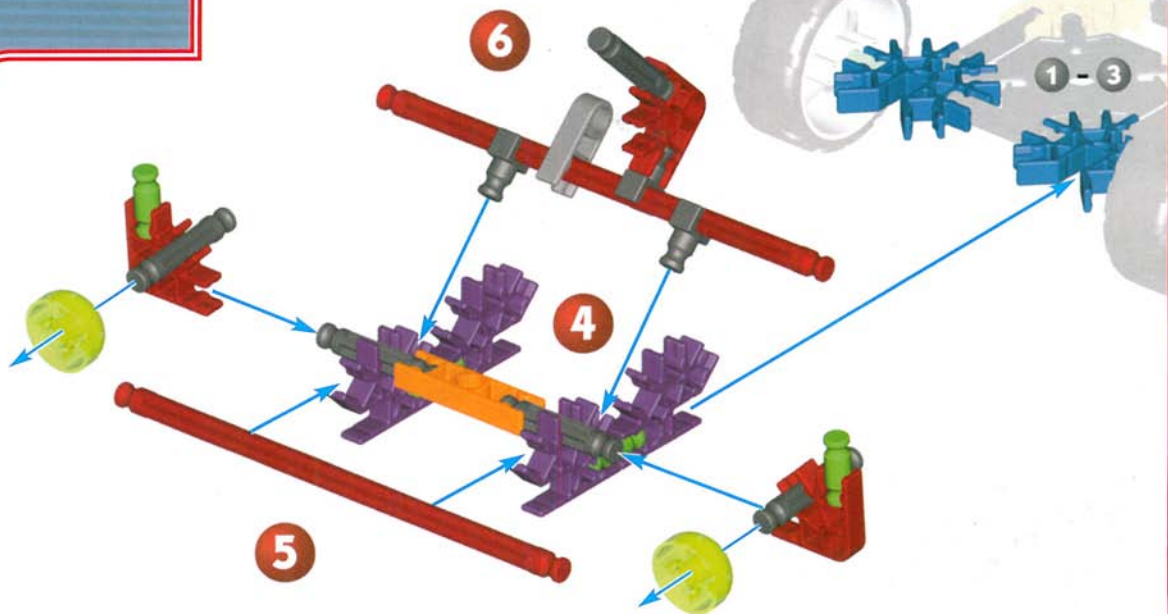
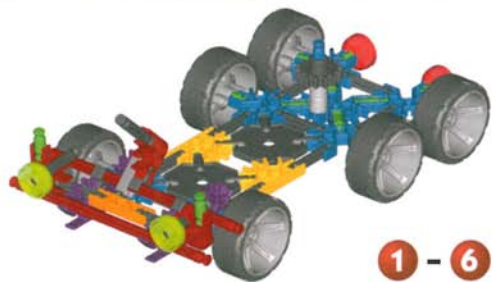

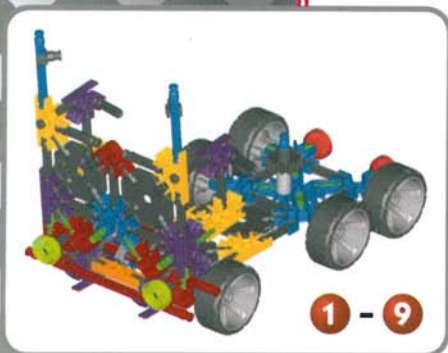
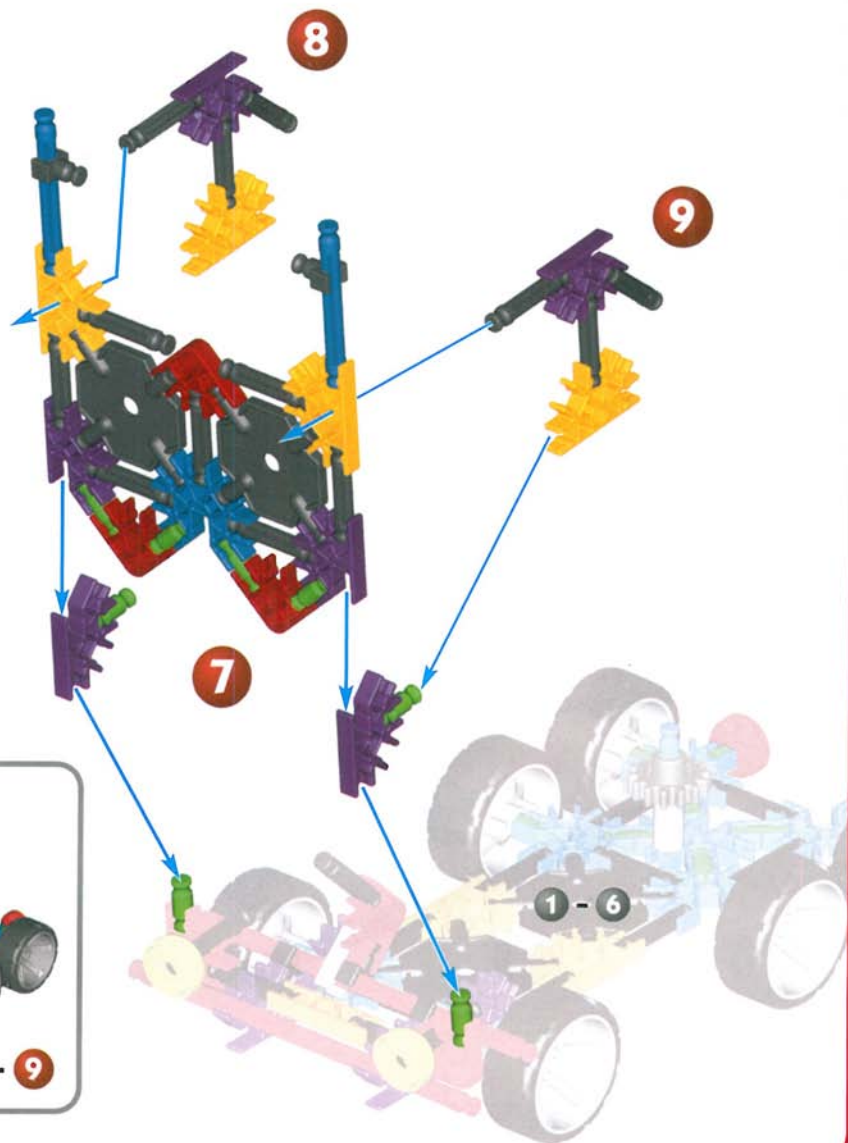

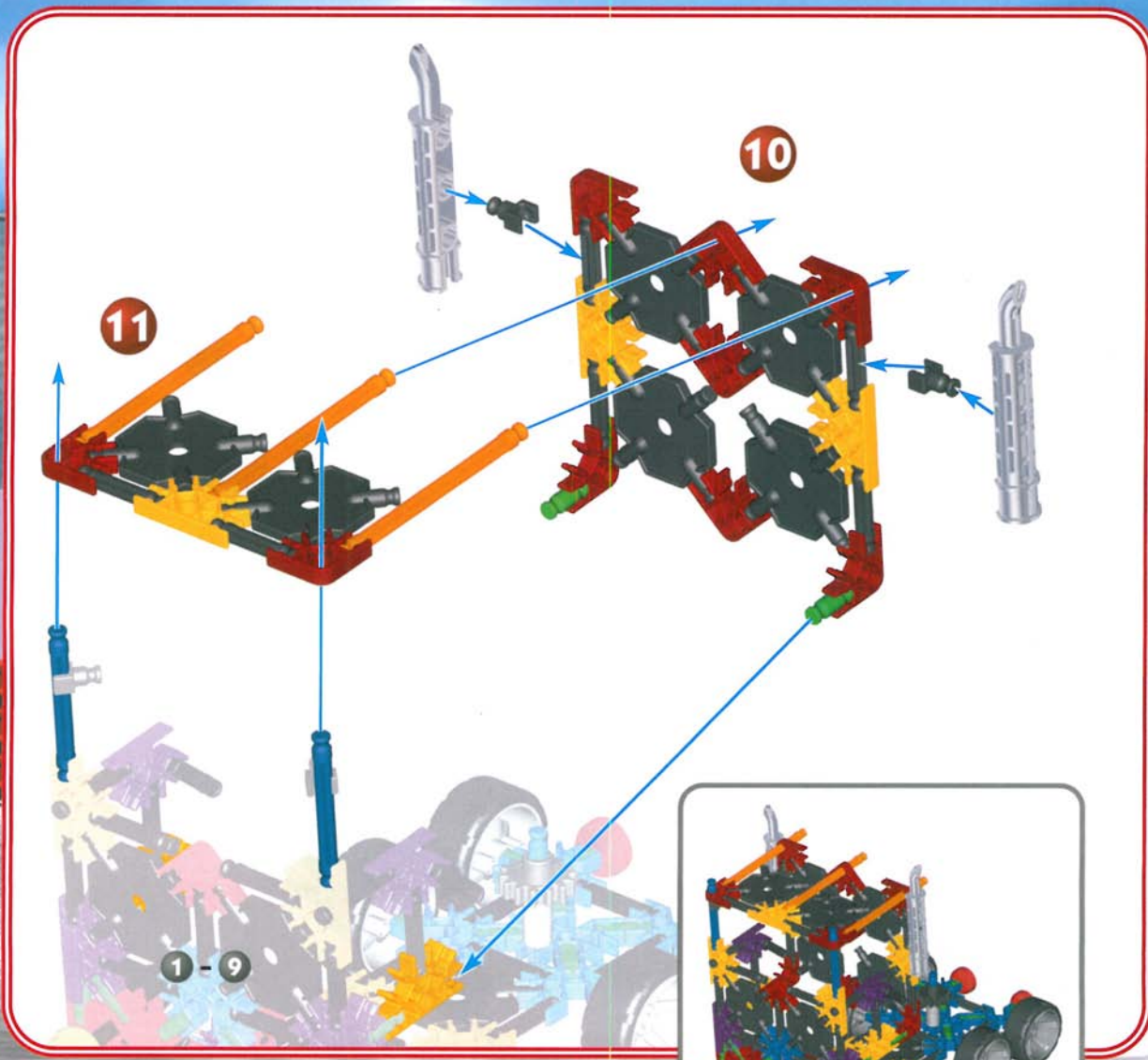

1 - 11

RACEWAY

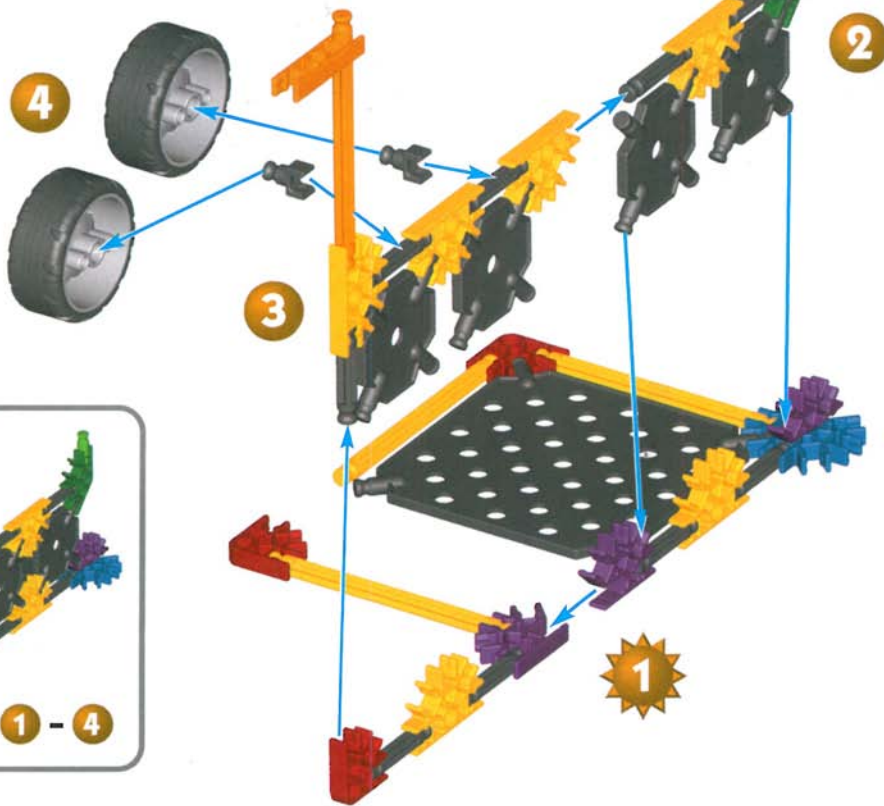

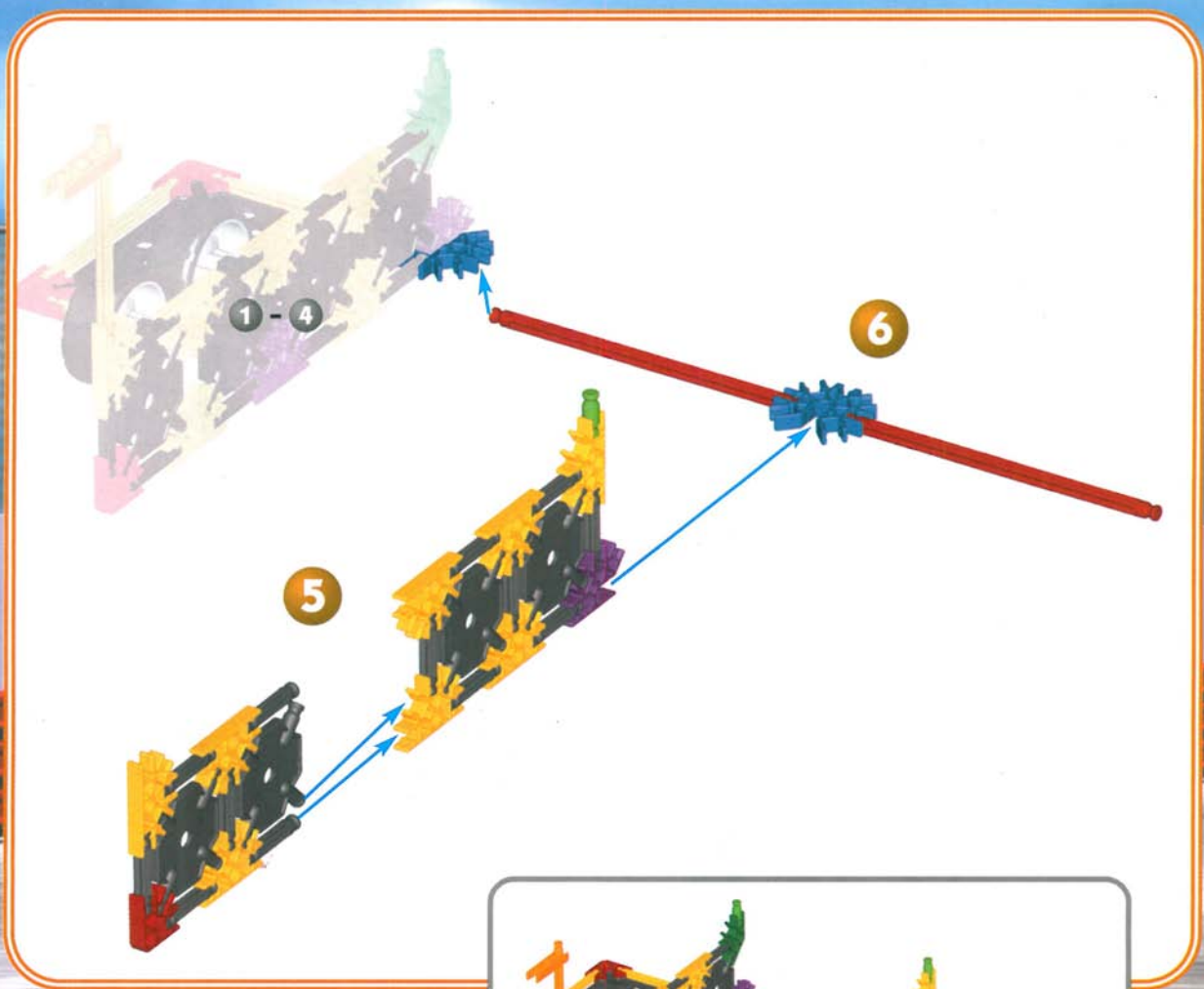

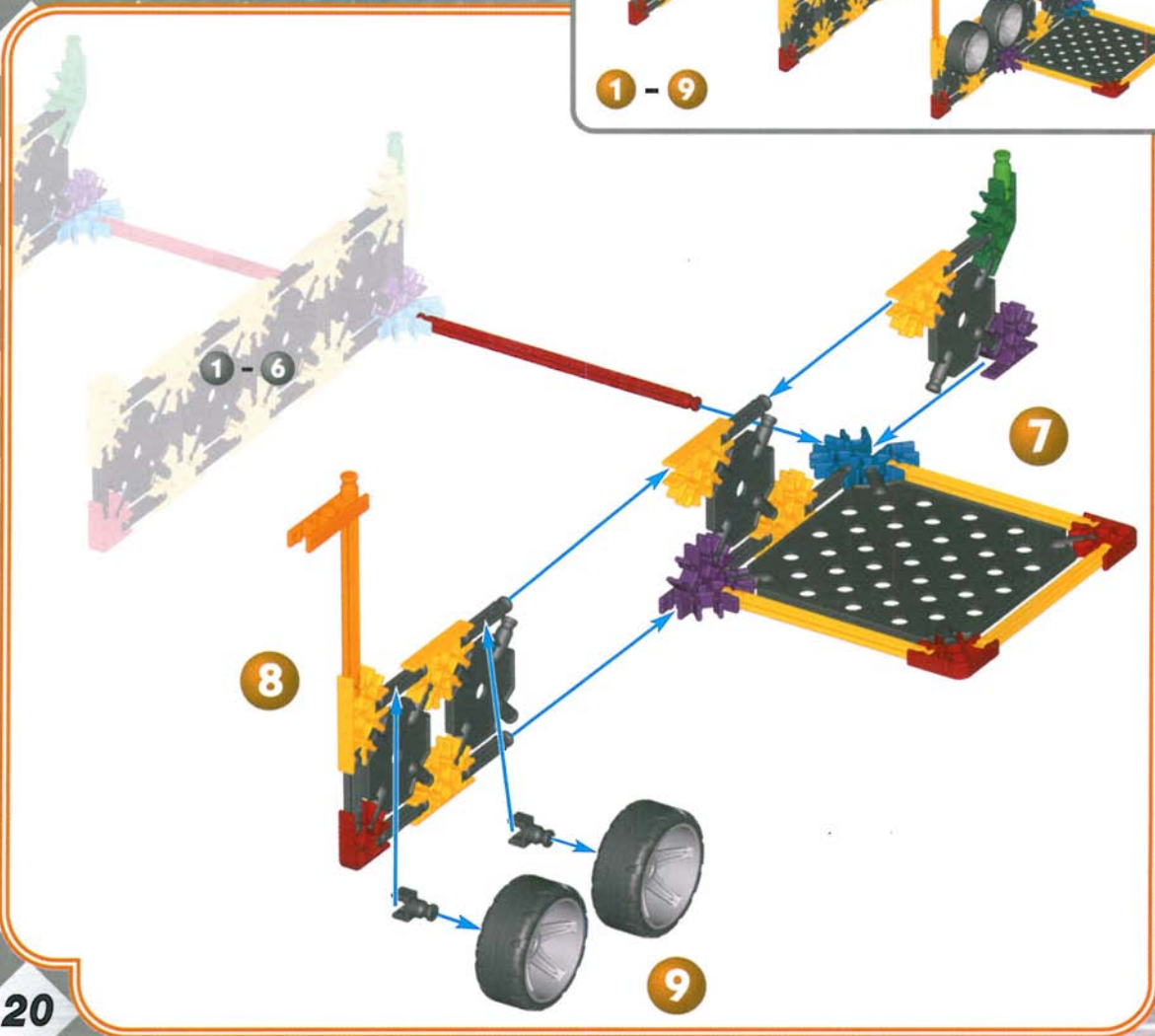
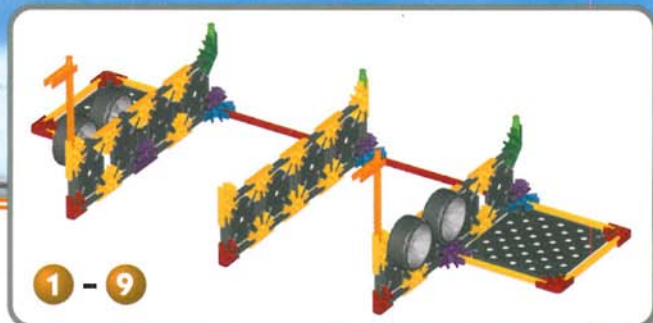

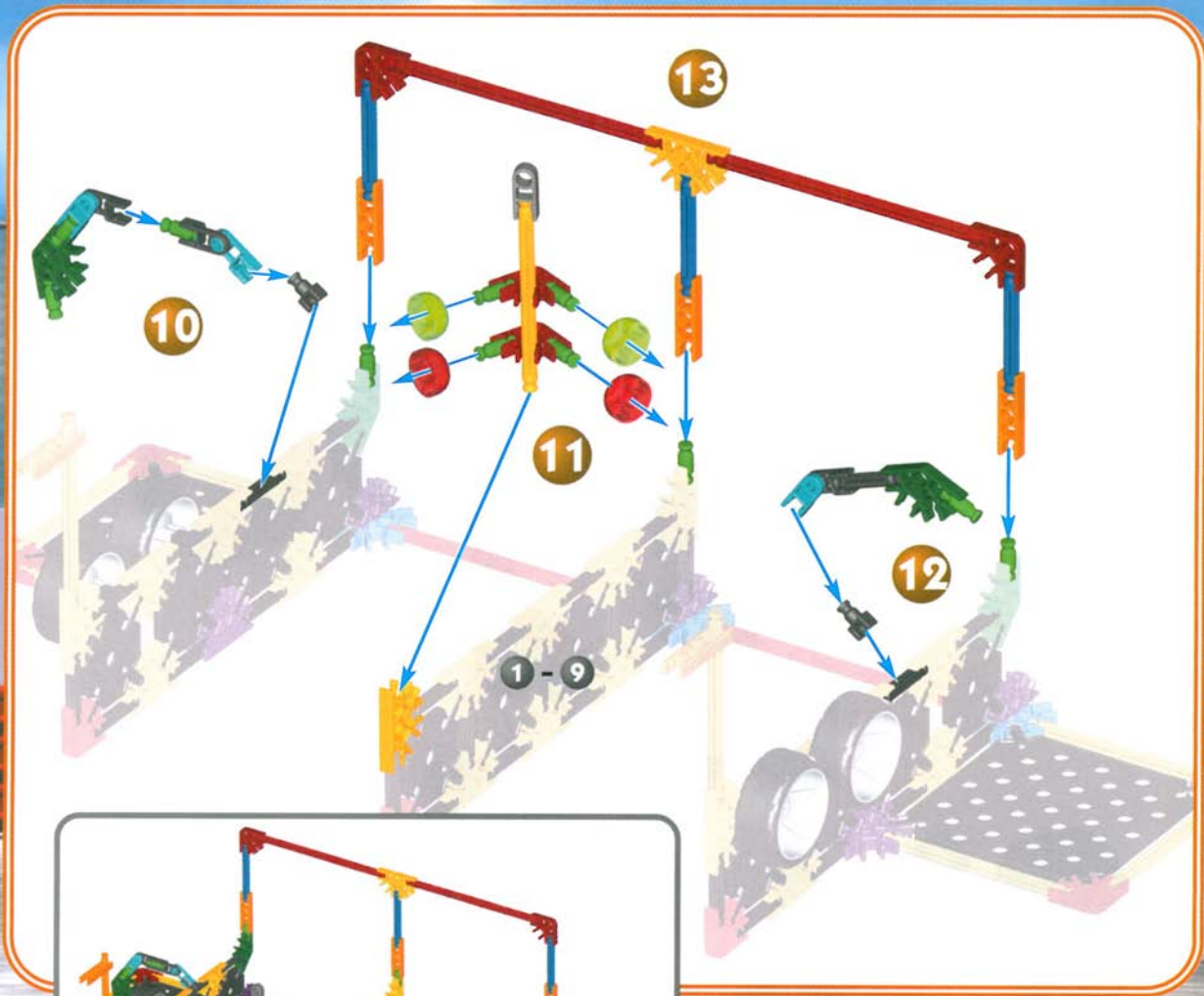

TIRE RACK

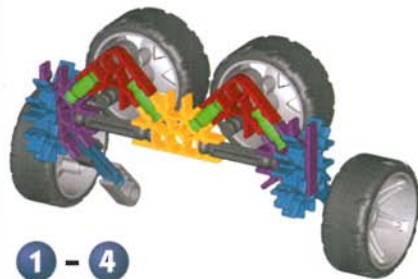

1 - 4

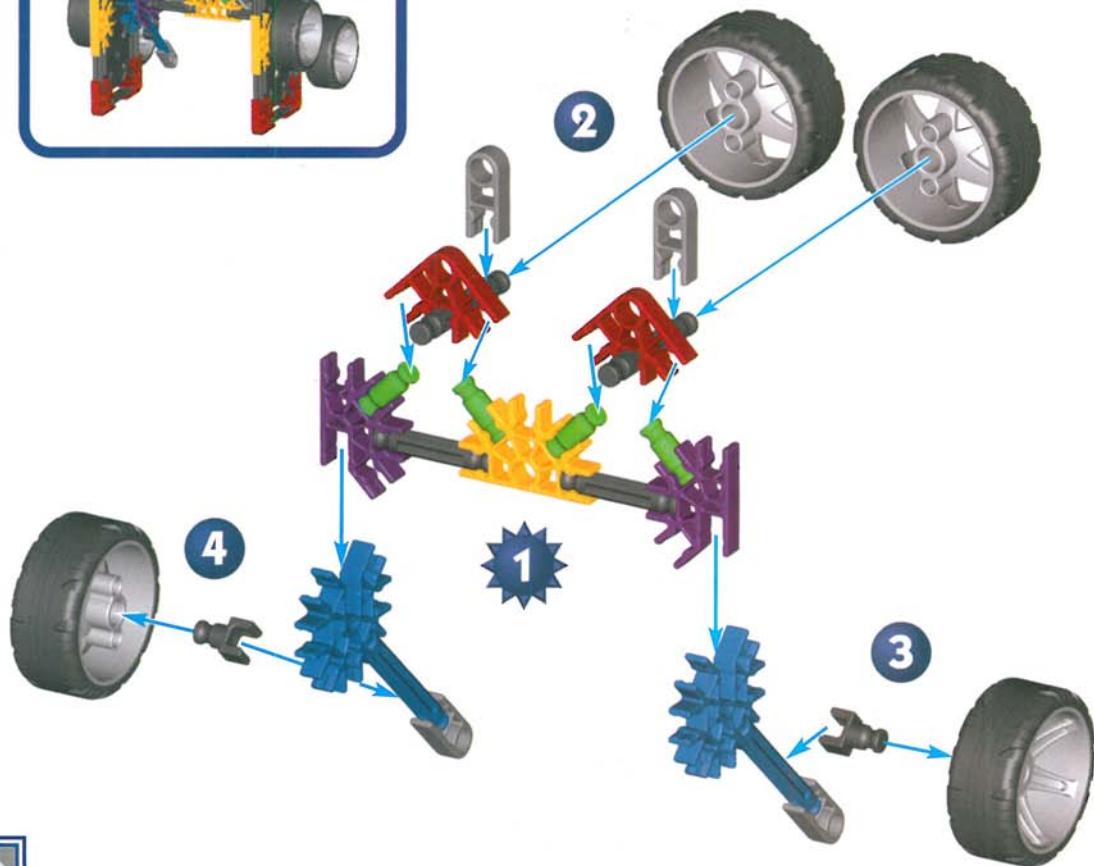

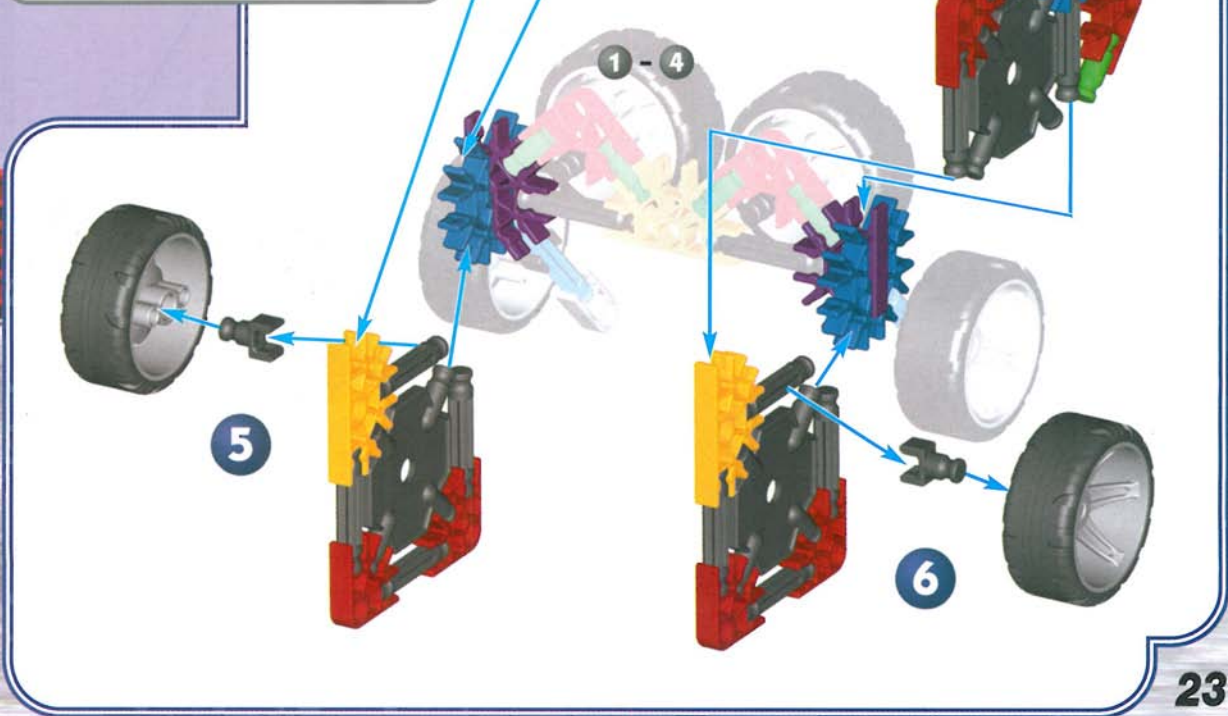
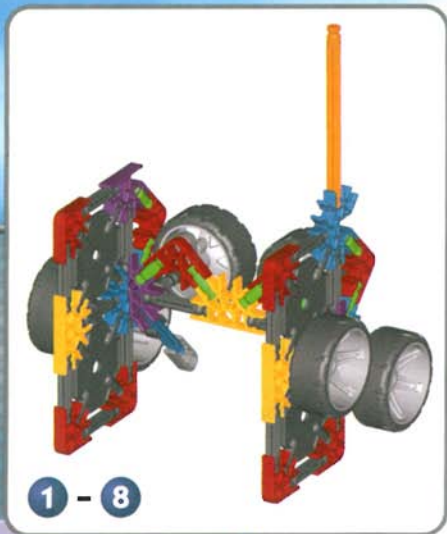

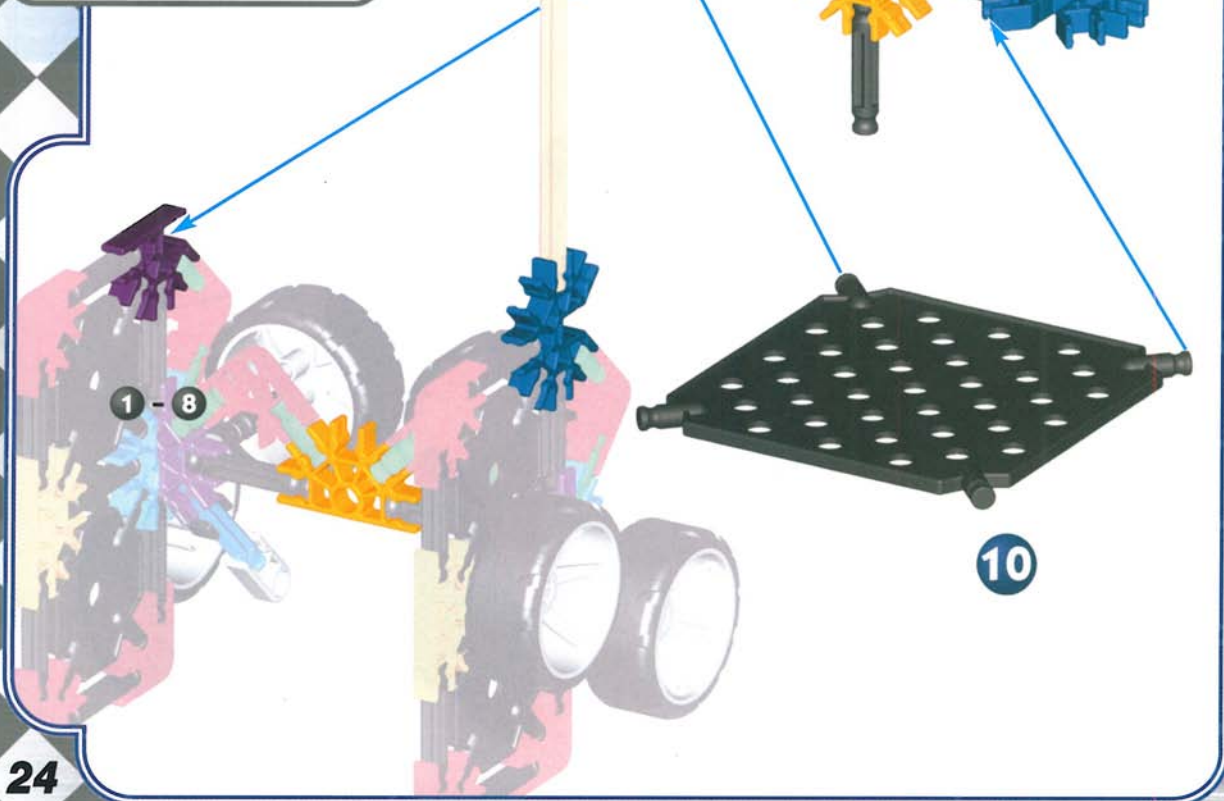

JACK

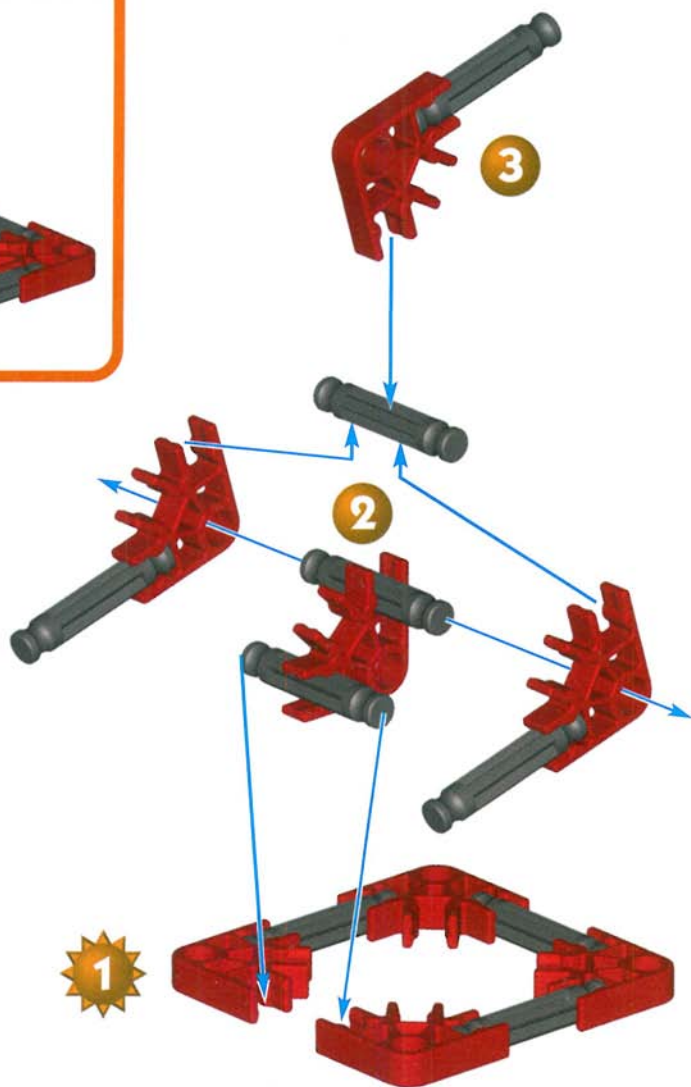

STICKER APPLICATION

Apply stickers as shown.

Appliquez les autocollants comme illustré.



CONTENU

Liste des pièces	3
Construire avec K'NEX	3
Instructions pour construire:	
JACK KNIFE	5
TRAILER	10
LUG NUT	14
RACEWAY	18
TIRE RACK	22
JACK	25

BIENVENUE

Tu occupes le siège de commande avec des modèles bourrés d'excitation de course ! Tous les ensembles **SPEED ZONE** offrent un style de course réaliste et des pièces et étiquettes spéciales pour donner à tes modèles un aspect fait sur mesure. Fais la collection de tous et construis un monde de course divertissant !

L'ensemble **JACK KNIFE** te permet de construire un transport de course énorme avec une remorque géante que tu peux utiliser pour transporter tes autres voitures de course **SPEED ZONE**. Il inclut également des tuyaux d'échappement spéciaux du type quasi-chromé disponibles uniquement avec cet ensemble. Il suffit de suivre les instructions de montage faciles; d'y ajouter les pièces et étiquettes spéciales et te voilà prêt à participer à la course !

Construire avec K'NEX



1. Bonjour! Je suis ton mécanicien K'NEX. Quand tu me vois dans les instructions, fais très attention aux détails indiqués.

2. Prêt, sur tes marques, construis
Pour commencer ton modèle, trouve le **1** et suis les sections numérotées en séquence. Chaque pièce a sa propre forme et couleur. Il suffit de regarder l'illustration, de trouver les pièces dans l'ensemble qui correspondent à ce que tu vois et de les enclencher. Essaie de tenir le modèle dans le même sens que dans l'illustration; ainsi tu monteras les pièces correctement.

3. Continuation

Les couleurs affaiblies indiquent que cette partie est déjà montée. Tu dois raccorder la nouvelle partie à l'endroit indiqué par les flèches. Ces pièces seront en pleine couleur.

4. Pièces d'écartement

Il y a des endroits dans ton modèle où tu dois ajouter des pièces d'écartement bleues et argentées. Assure-toi d'utiliser la couleur exacte et de compter les pièces avec soin.

5. Connecteurs

Tu trouveras des connecteurs bleus et violets comportant des fentes extra-longues. Ils se glissent l'un dans l'autre tel qu'illustré. Pousse les pièces ensemble jusqu'à ce que tu entendes un "déclat".

6. Tiges flexibles

Une tige flexible est une tige orange ou violette que tu peux courber. Elle s'attachera plus facilement à ton modèle si tu la courbes d'abord plusieurs fois avant son installation.

K'NEX®

SPEED ZONE

JACK KNIFE BIG RIG RACE TRANSPORT

RACE WAY

LUG NUT

Questions? Call us
at 1-800-KID-KNEX
(USA/Canada only)
www.knex.com

©2000 K'NEX Industries, Inc.
P.O. Box 700
Hatfield, PA 19440-0700

Racecars shown here not included.
Product and colors may vary.
Models can be built one at a time.

Le produit et les couleurs peuvent varier.
La plupart des modèles peuvent être construits un à la fois.

Look for these other **SPEED ZONE** sets
to build a complete world of racing!



K'NEX is a registered
trademark of K'NEX Industries, Inc.

K'NEX est une marque
déposée de K'NEX Industries, Inc.

Manufactured under U.S. Patents/Fabriquée sous brevets
américains 5,061,219; 5,137,486; 5,199,919; 5,238,438;
5,346,420; 5,350,331; 5,368,514; 5,421,762; 5,423,707;
5,427,559; 5,518,435; D383,509; D388,475; D389,203;
D391,843; D391,921; D392,555.

Other U.S. and foreign patents pending.
Conforms to the Requirements of ASTM
Standard Consumer Safety Specification
on Toy Safety, F963-96a.

Autres brevets américains et étrangers en
instance. Conforme aux spécifications de
sécurité du consommateur sur la sécurité
des jouets de la norme ASTM F963-96a.

Made in the U.S.A.
Fabriqué aux États-Unis.

93164-V1-10/00