

K'NEX®

Imagine • Build • Play®

9+

SPEED DEMON COASTER™

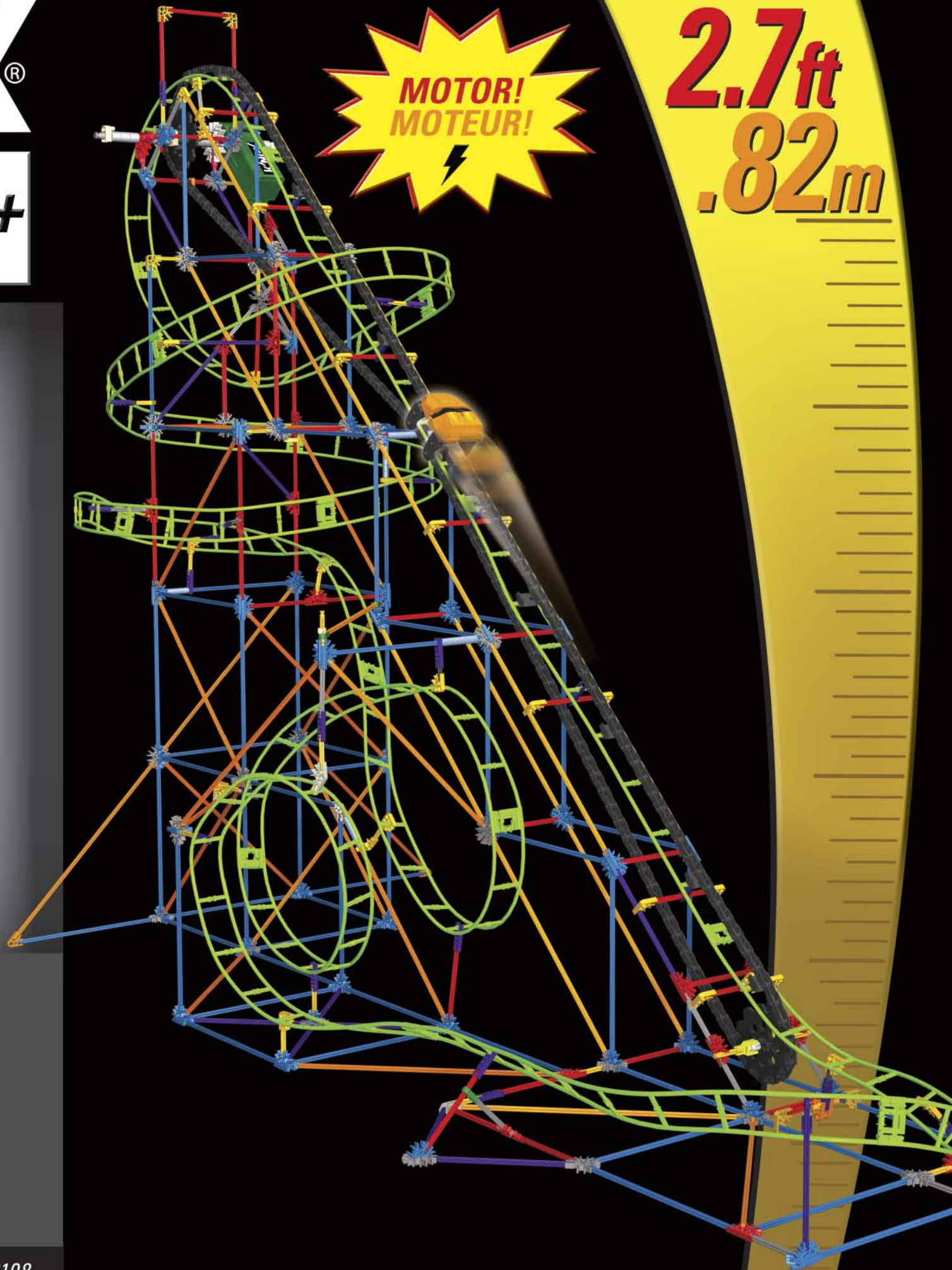
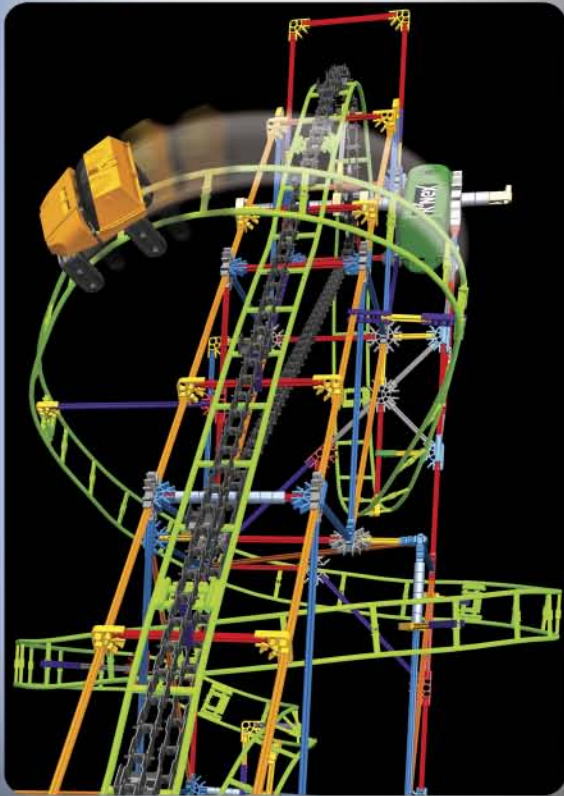

WARNING:

CHOKING HAZARD - Small parts.
Not for children under 3 years.



AVERTISSEMENT:

DANGER D'ÉTOUFFEMENT - Pièces de petite taille.
Ne pas donner aux enfants de moins de 3 ans.

58108

EN CONTENTS

SPEED DEMON COASTER™	4
Track Building Tips	26
Tips & Troubleshooting	44
BUILDING IDEA	44
Languages	45-47

FR CONTENUS

SPEED DEMON COASTER™	4
Conseils pour le circuit	26
Conseils & Dépannage	44
IDÉE DE CONSTRUCTION	44
Langues	45-47

IMPORTANT STUFF FOR PARENTS & KIDS

Keep these instructions in a handy location.
They contain important safety information.

Read all warnings and instructions before
you start to build and operate the model.

⚠ WARNING: CHOKING HAZARD - Small parts.
Not for children under 3 years.

CAUTION: Keep hands, face, hair and clothing away
from all moving parts.

CAUTION: Be careful not to tip the model over.
Model should be placed on a flat and hard surface.

- Share the K'NEX experience with your child and make building with K'NEX a family fun adventure.
- Take your time to enjoy the building process. Don't rush!
- While you're building make sure you face your model in the same direction as the pictures show in the instructions.
- Product and colors may vary.

Go to **KNEX.COM**
for *Instruction Updates*

Va à **KNEX.COM** pour des
misés à jour des instructions

BATTERY INFORMATION

CAUTION:

- Be sure to insert the batteries correctly and always follow the toy and battery manufacturers' instructions.
- Do not mix old and new batteries or alkaline, standard (carbon-zinc) or rechargeable (nickel-cadmium) batteries. Only batteries of the same or equivalent type recommended should be used.
- Always remove weak or dead batteries from the product; do not short-circuit supply terminals.
- Insert batteries with correct polarity (+/-) as shown.

Important Tips

- Alkaline batteries AA (LR6) are recommended.
- Rechargeable batteries are not recommended.
- Remove rechargeable batteries from toy before charging; they must be charged only under adult supervision.

- Non-rechargeable batteries must not be recharged.
- Keep components free of dust; do not immerse or use in water.
- Do not dispose of batteries in a fire; they could leak or explode and cause injury.
- Remove all batteries if the toy will not be used for a long period of time.
- Do not put rods smaller than 2 inches in any openings of the motor; they will damage the motor and cannot be removed.
- Help the environment by disposing of your product and packaging responsibly. The wheellie bin symbol indicates that the product and batteries must not be disposed of in the domestic waste as they contain substances which can be damaging to the environment and health. Please use designated collection points or recycling facilities when disposing of the item or batteries.

How to Insert and Remove Batteries

Use a small Phillips head screwdriver to loosen the screw.
Insert 2 fresh AA batteries (LR6) into the compartment
with the correct polarity (+/-) as shown here.

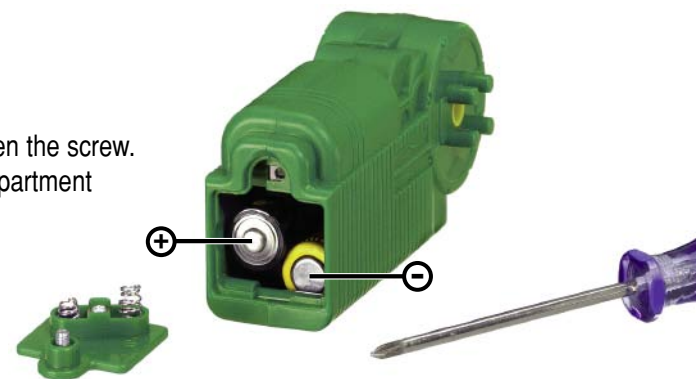

Start Building

To begin your model, find the **1** and follow the numbers. Each piece has its own shape and color. Just look at the pictures, find the pieces in your set that match and then connect them together. Try to face your model in the same direction as the instructions while you build. The arrows show you where the parts connect, but not all connections points have arrows. Faded colors show you this section is already built.

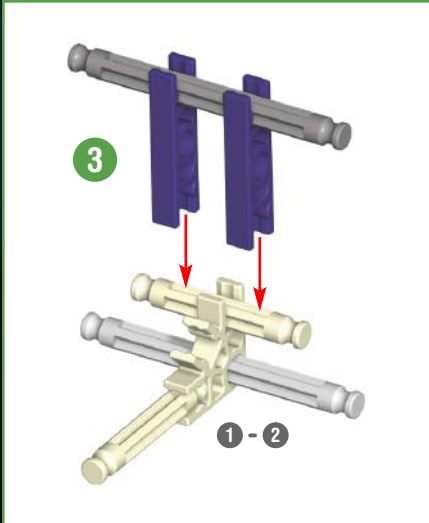
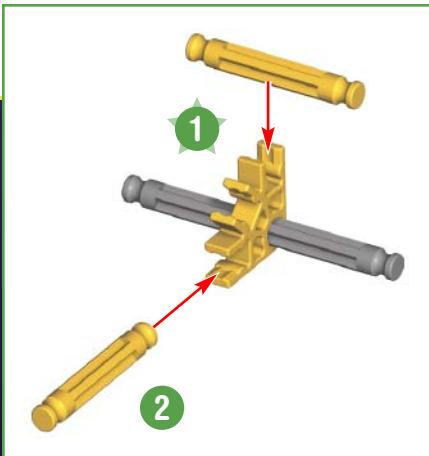

Parts Count

Before you start building, be sure to compare the parts in your set with the parts list here. If anything is missing, call or write to us using the information on the back cover. We are here to help you!

Spacers

There are places in your model where you need to add blue and silver spacers. Be sure to use the right color and count them carefully.



Chain

Be sure to attach all the chain links in the same direction.



Connectors

There are blue and gray connectors with special long slots. They slide together as you see in the pictures. Push these parts together until you hear a "click."

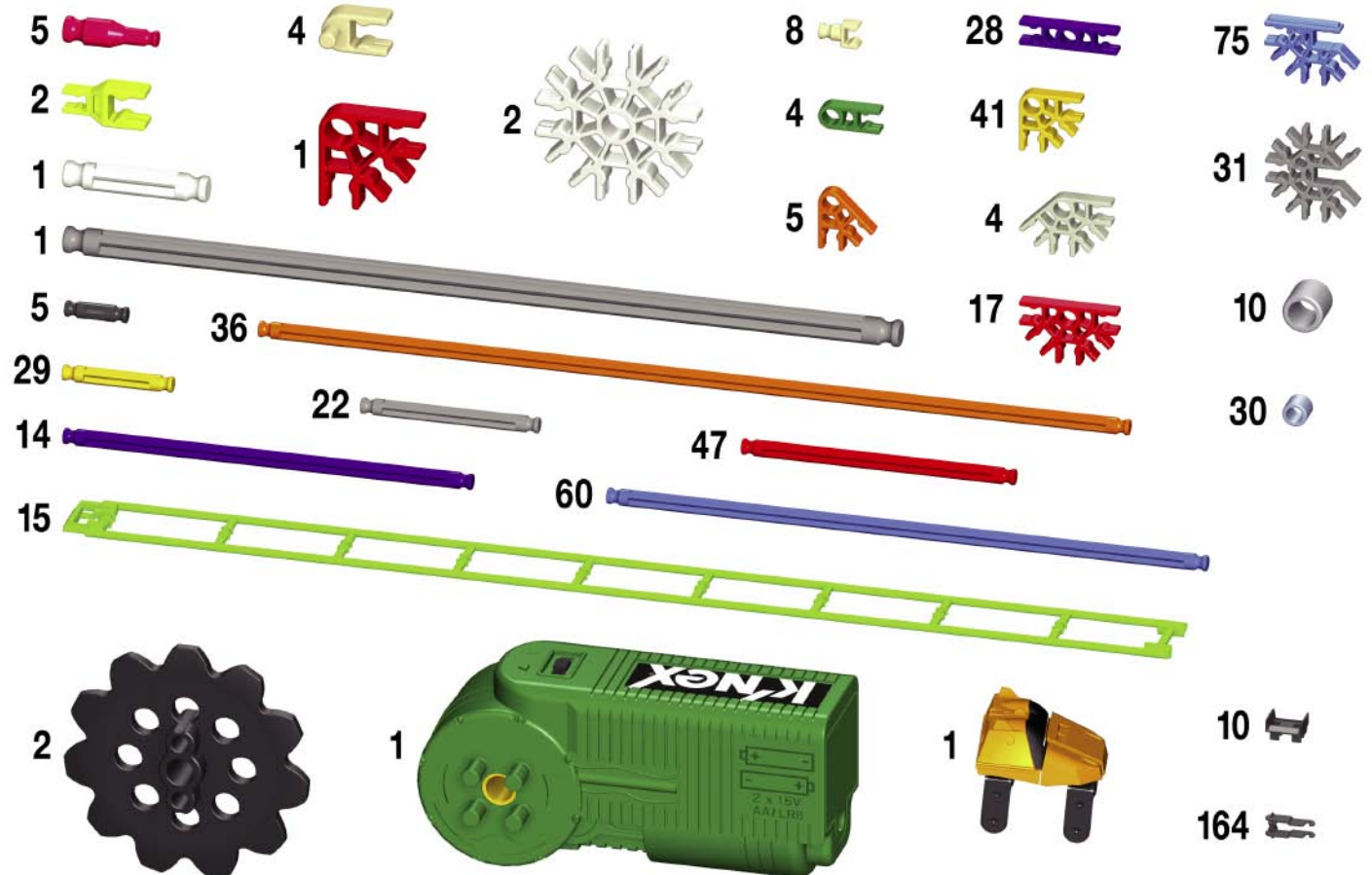
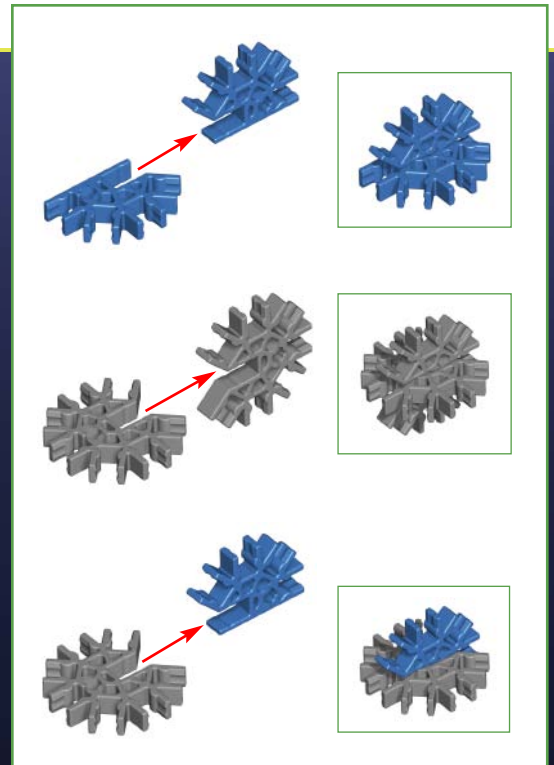

SPEED DEMON COASTER™

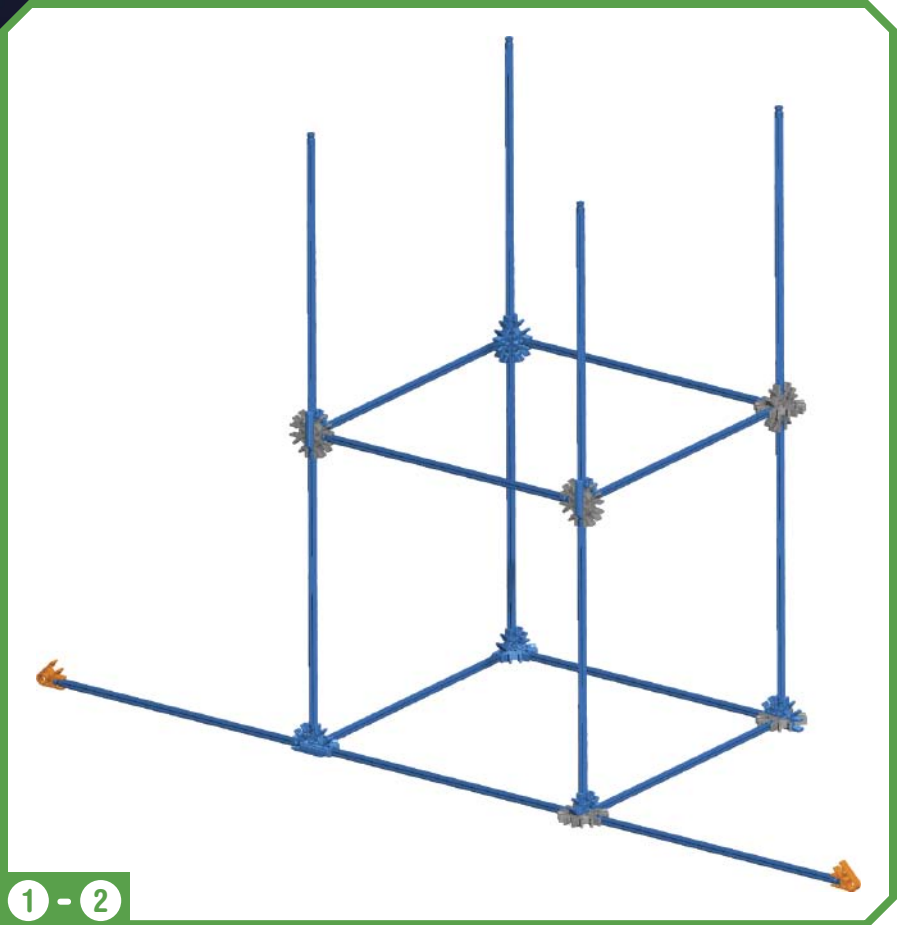
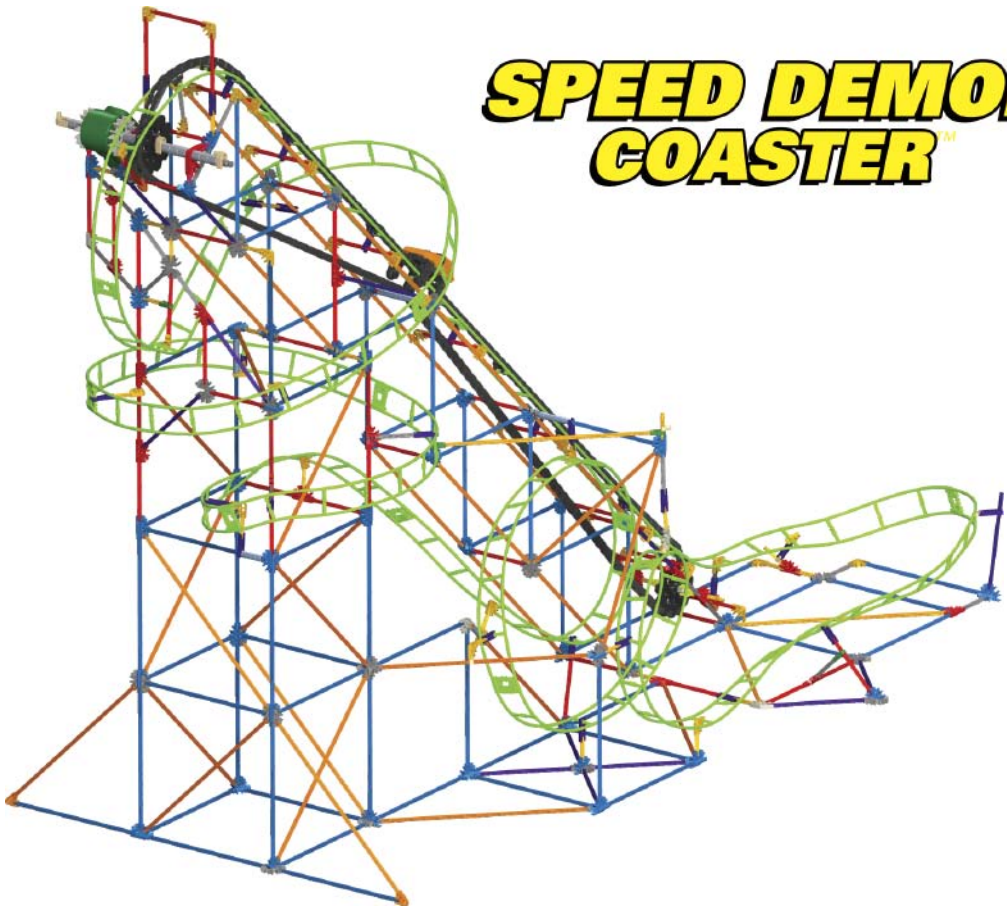

1 - 2

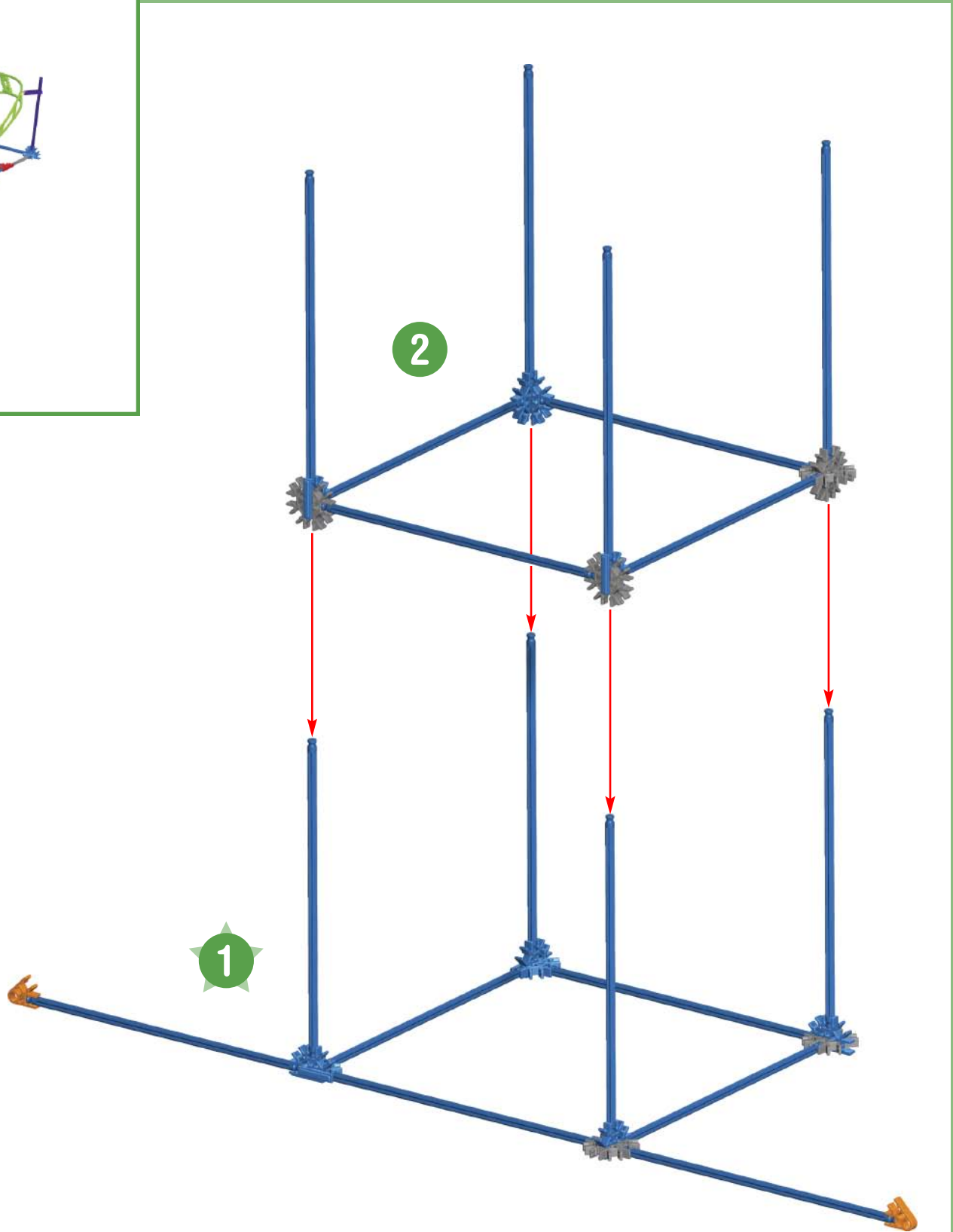

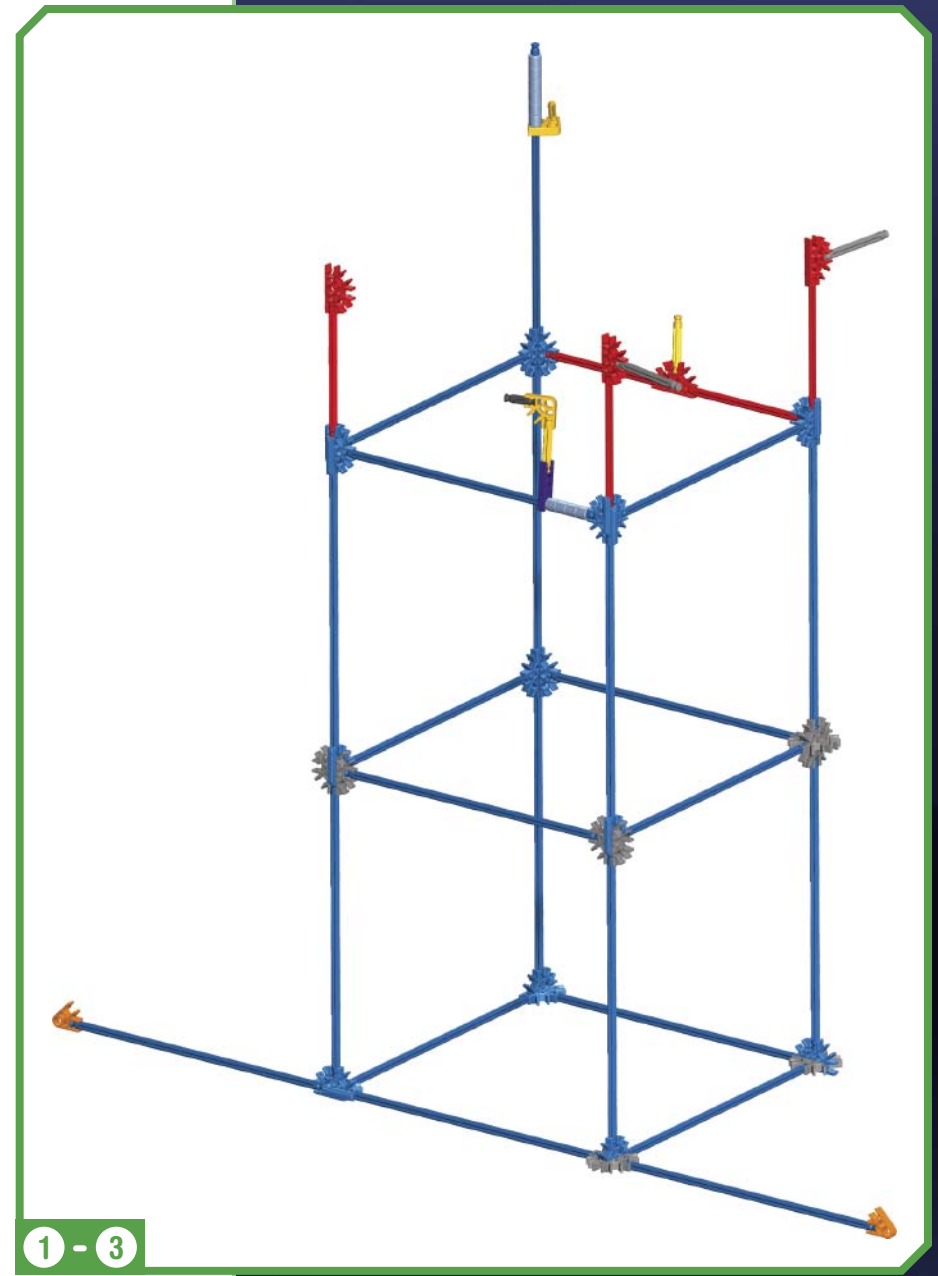
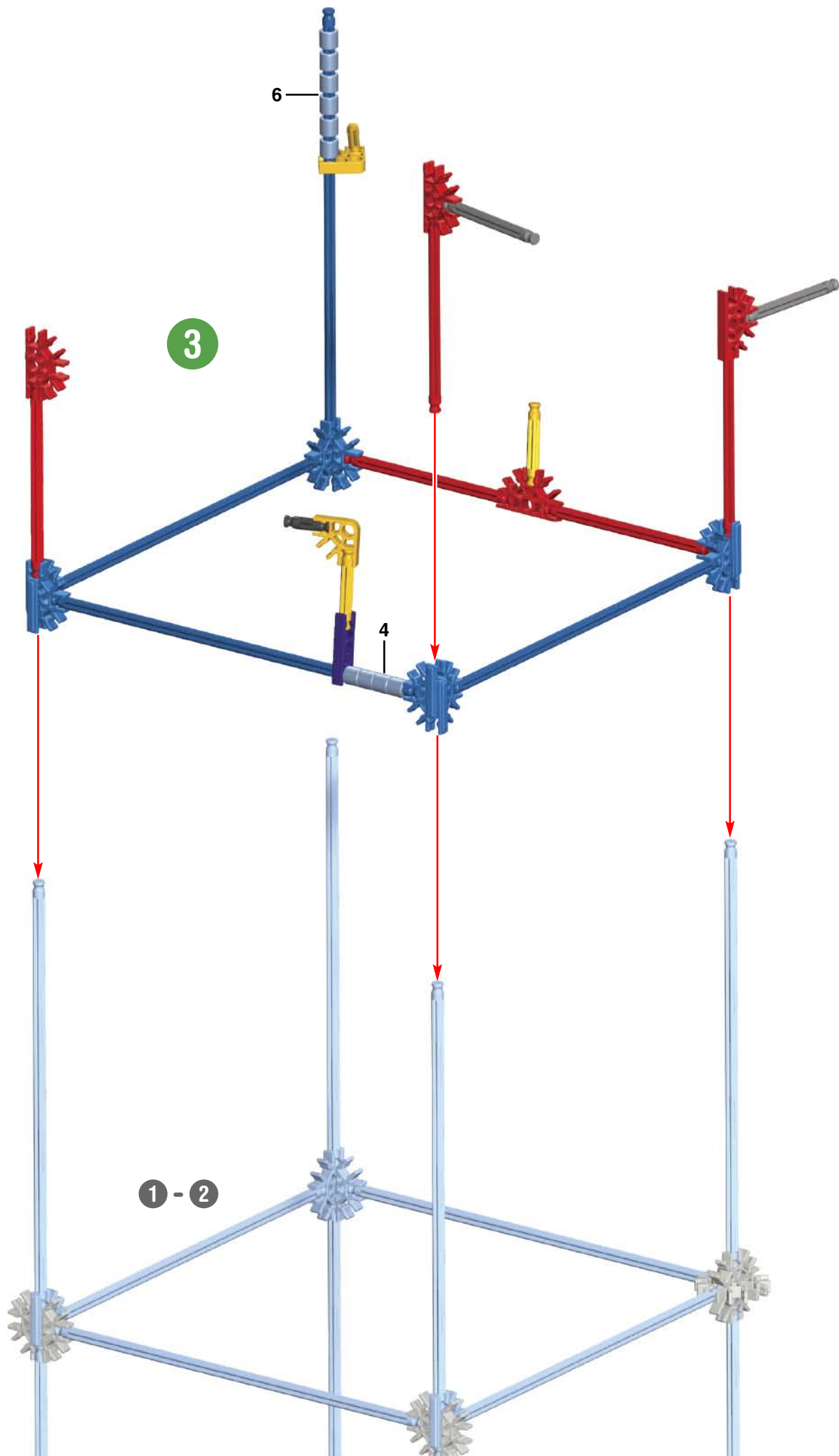

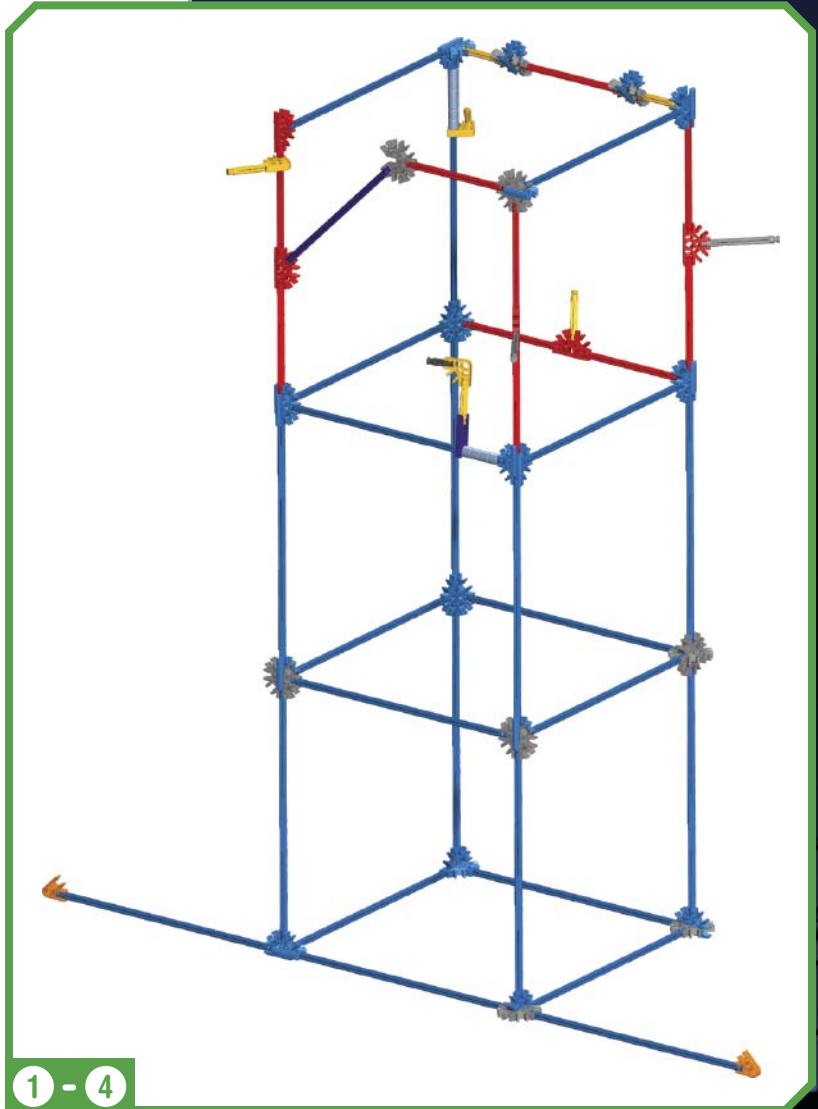
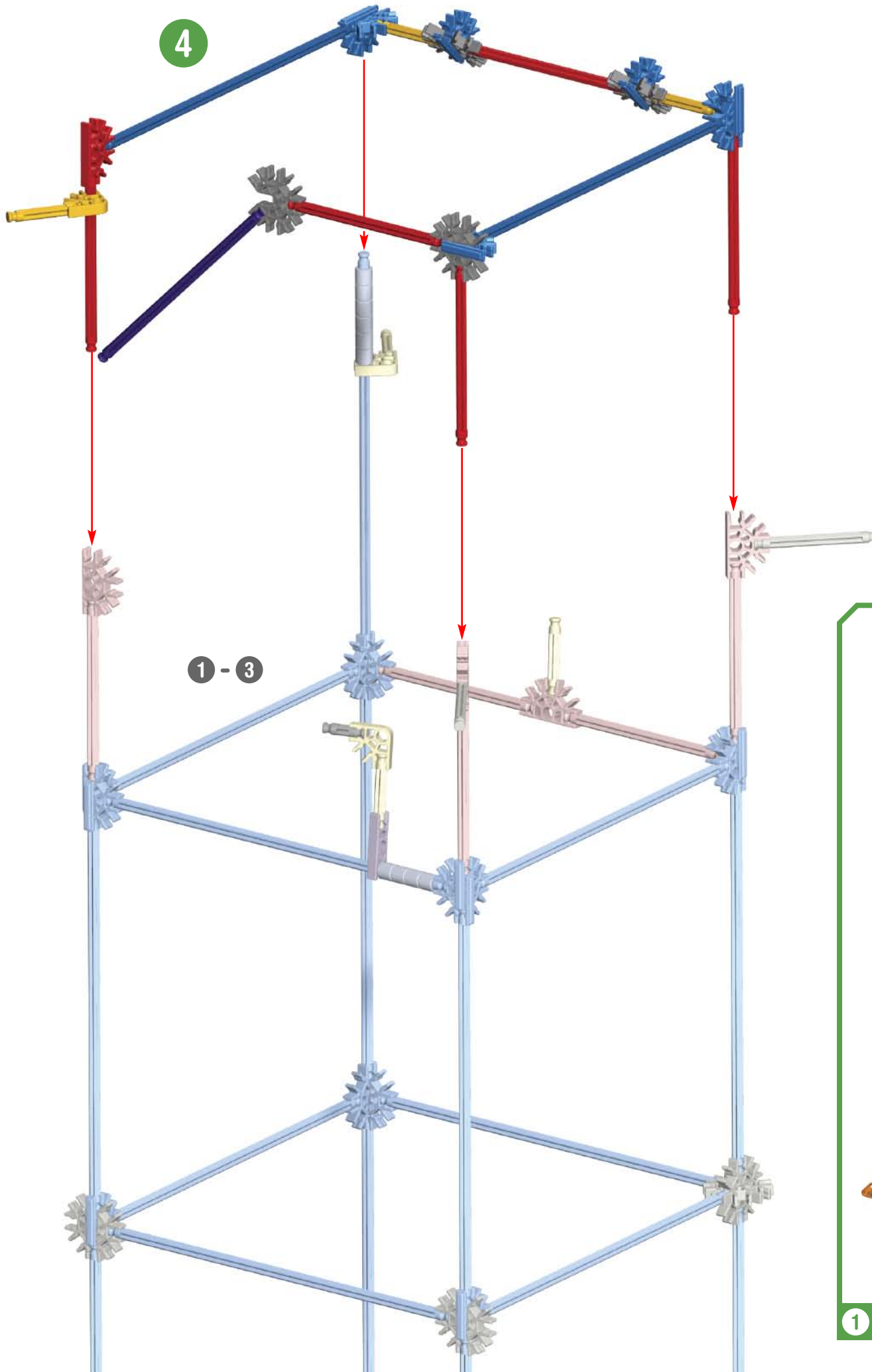

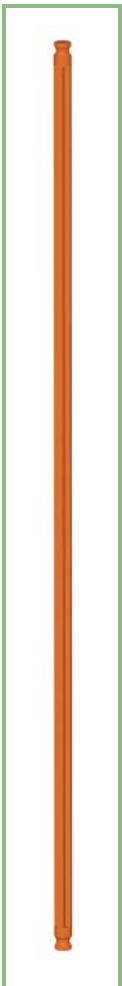

x6

5

1 - 4

1 - 5

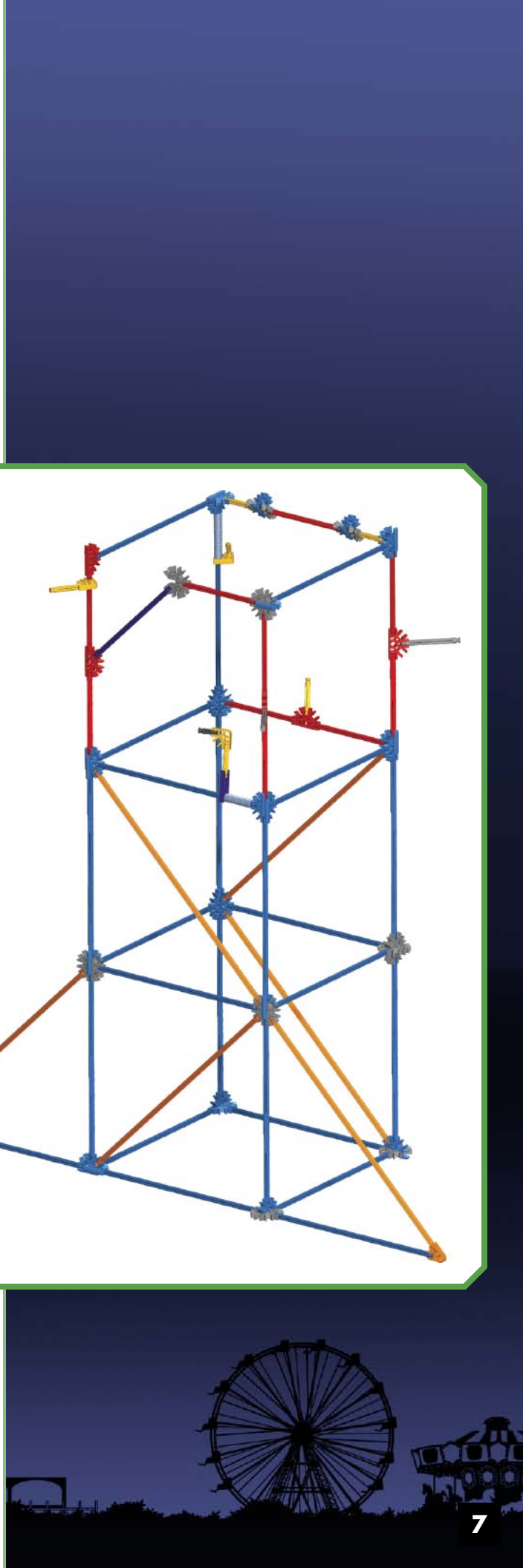

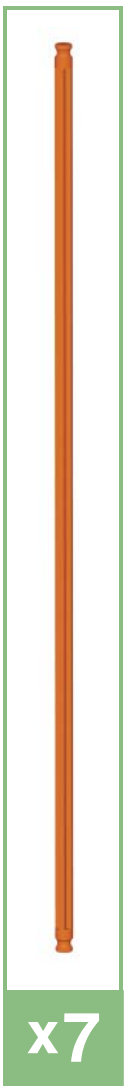

x7

6

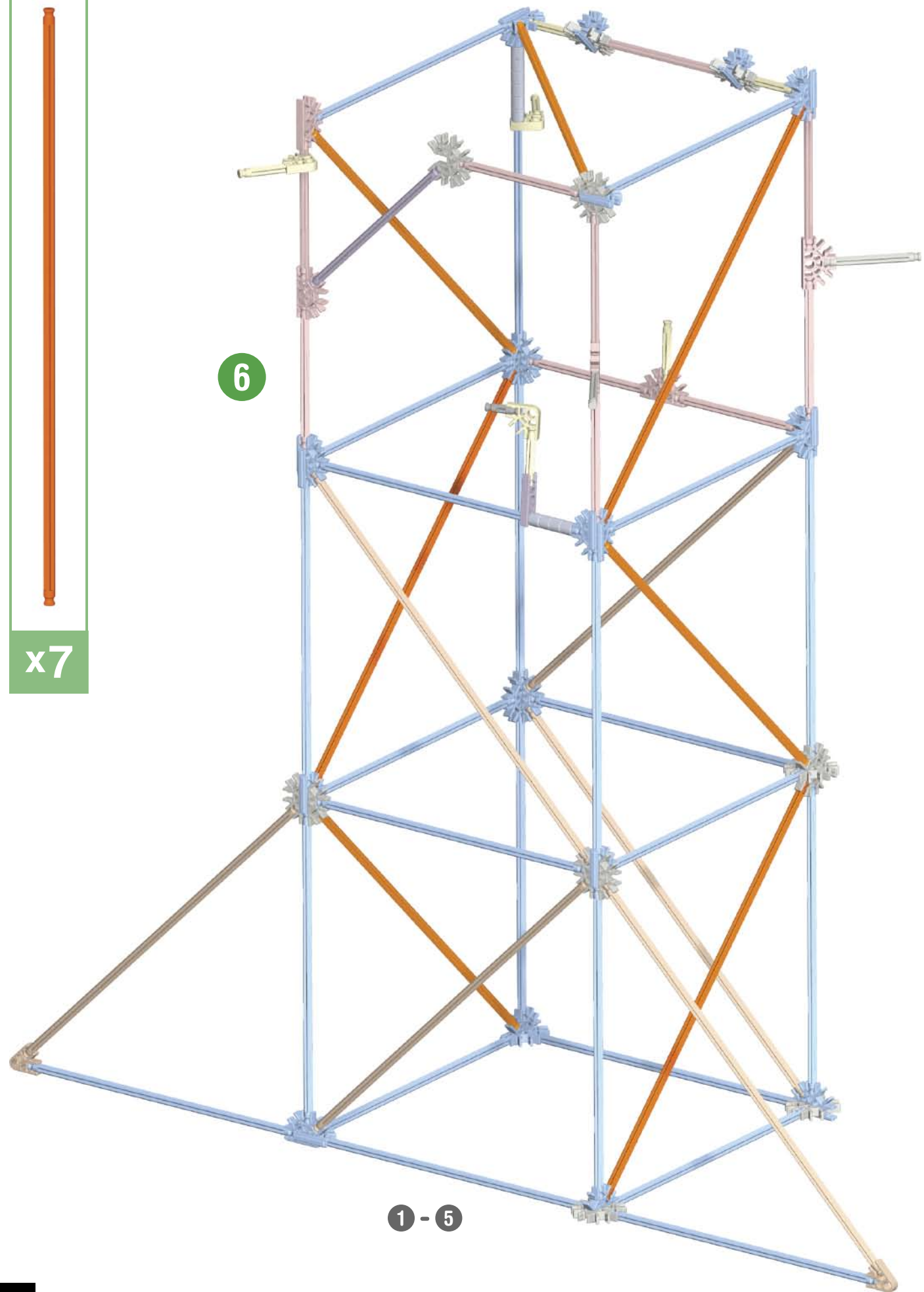

1 - 5

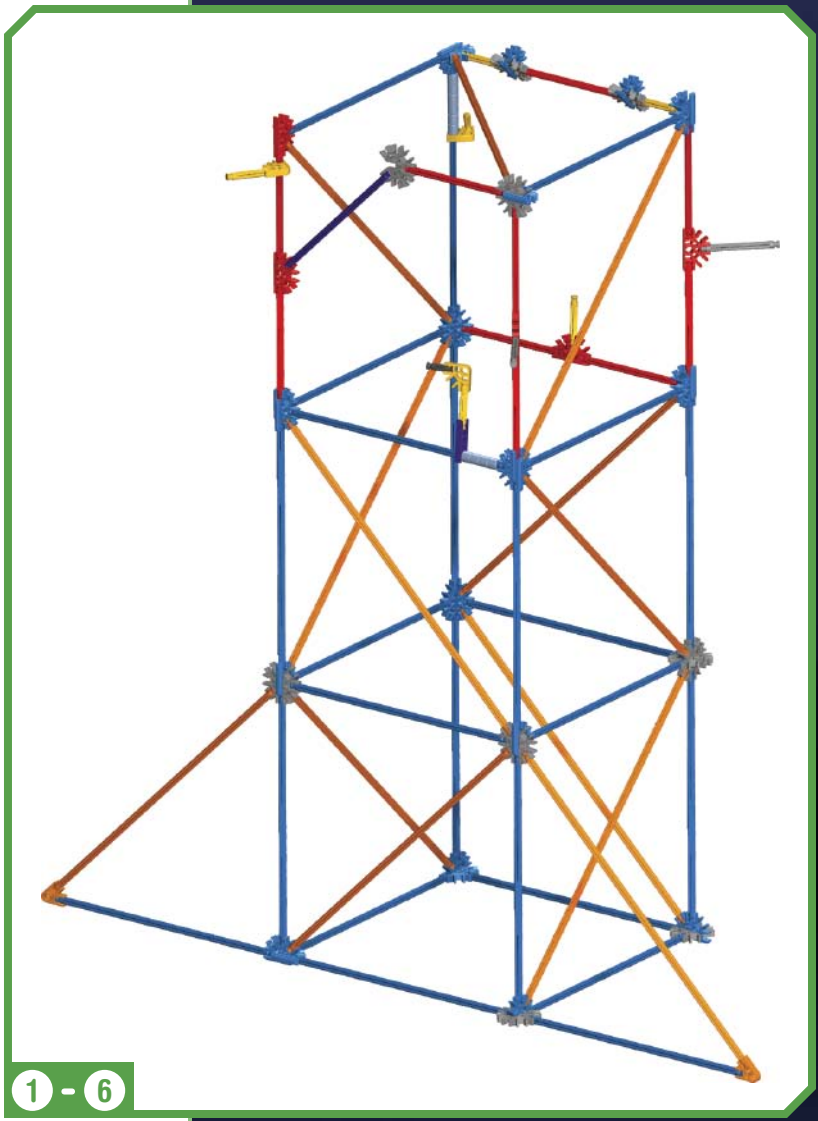

1 - 6



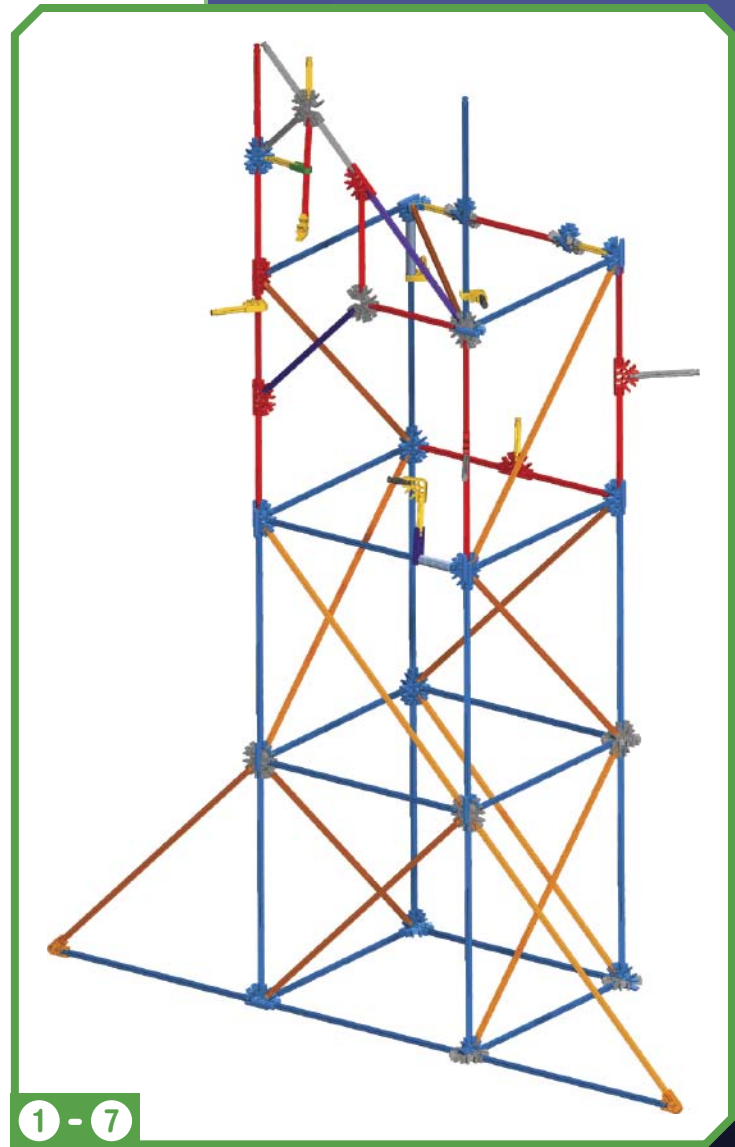
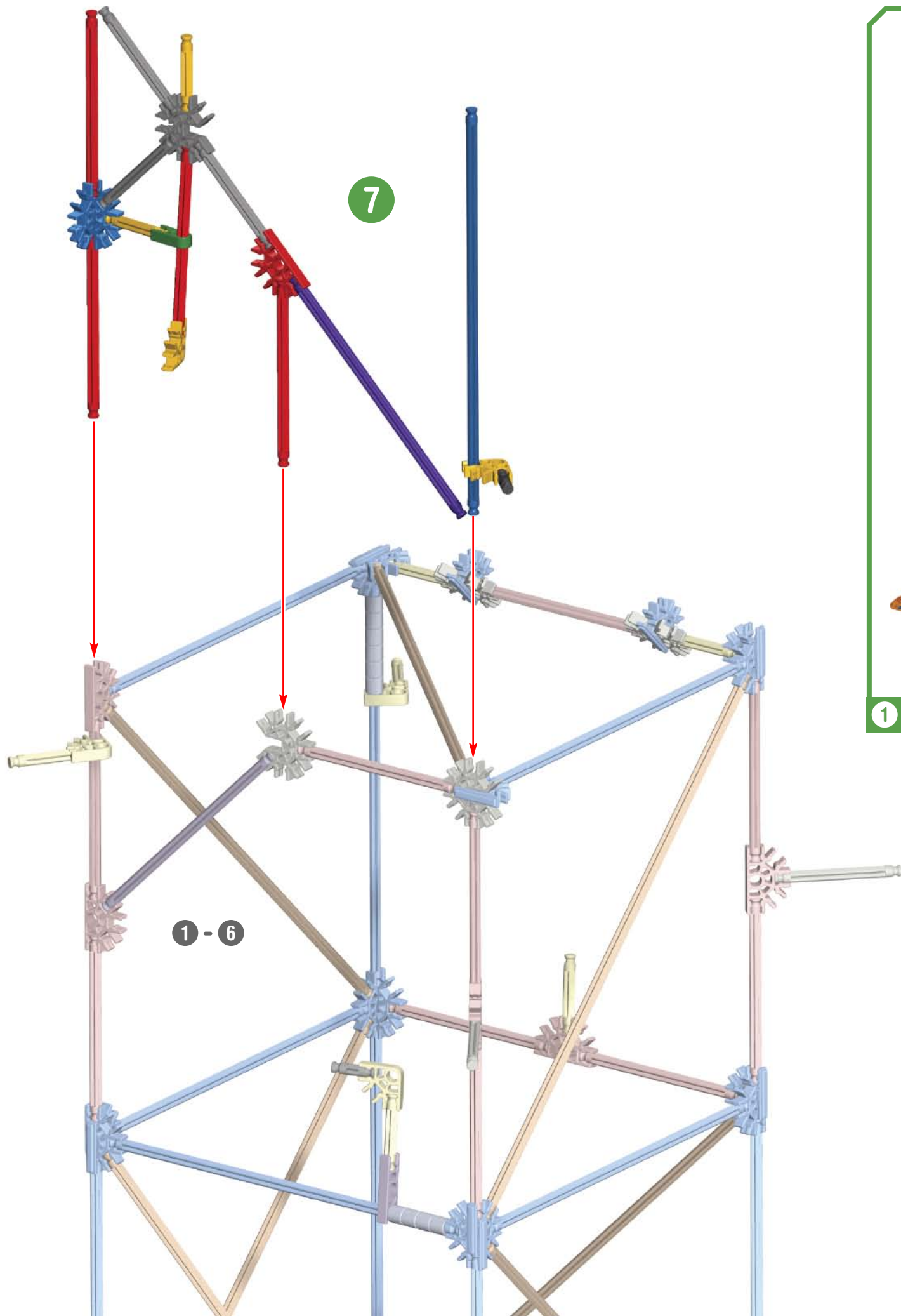

8

1 - 7

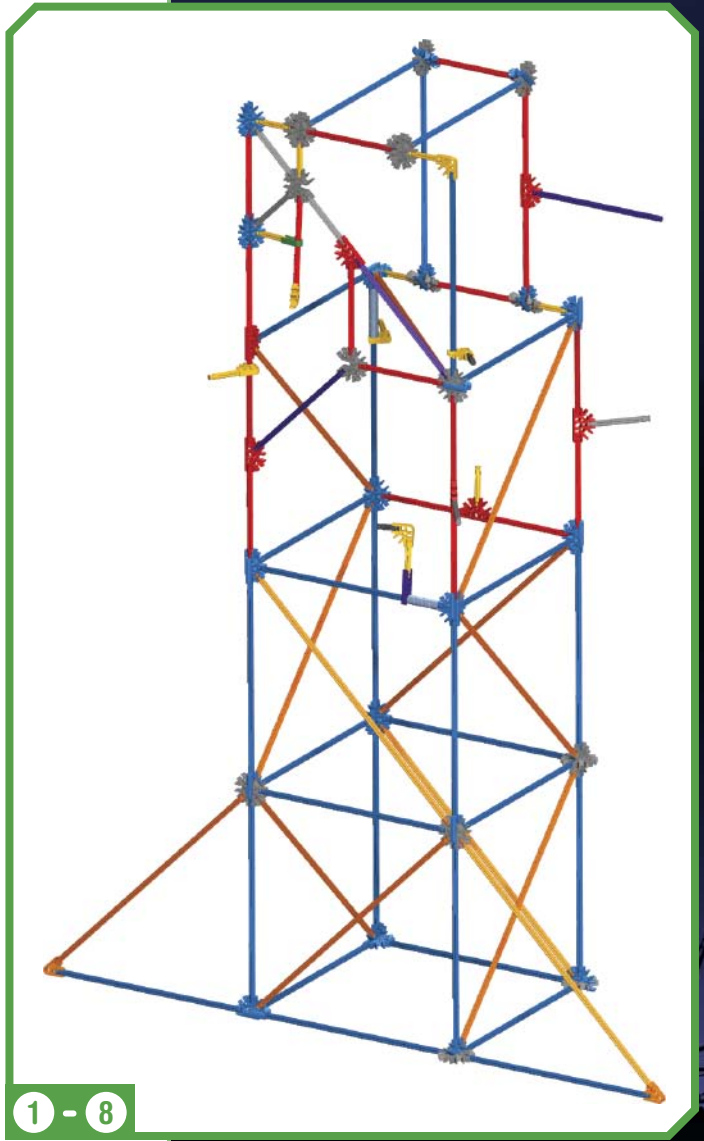
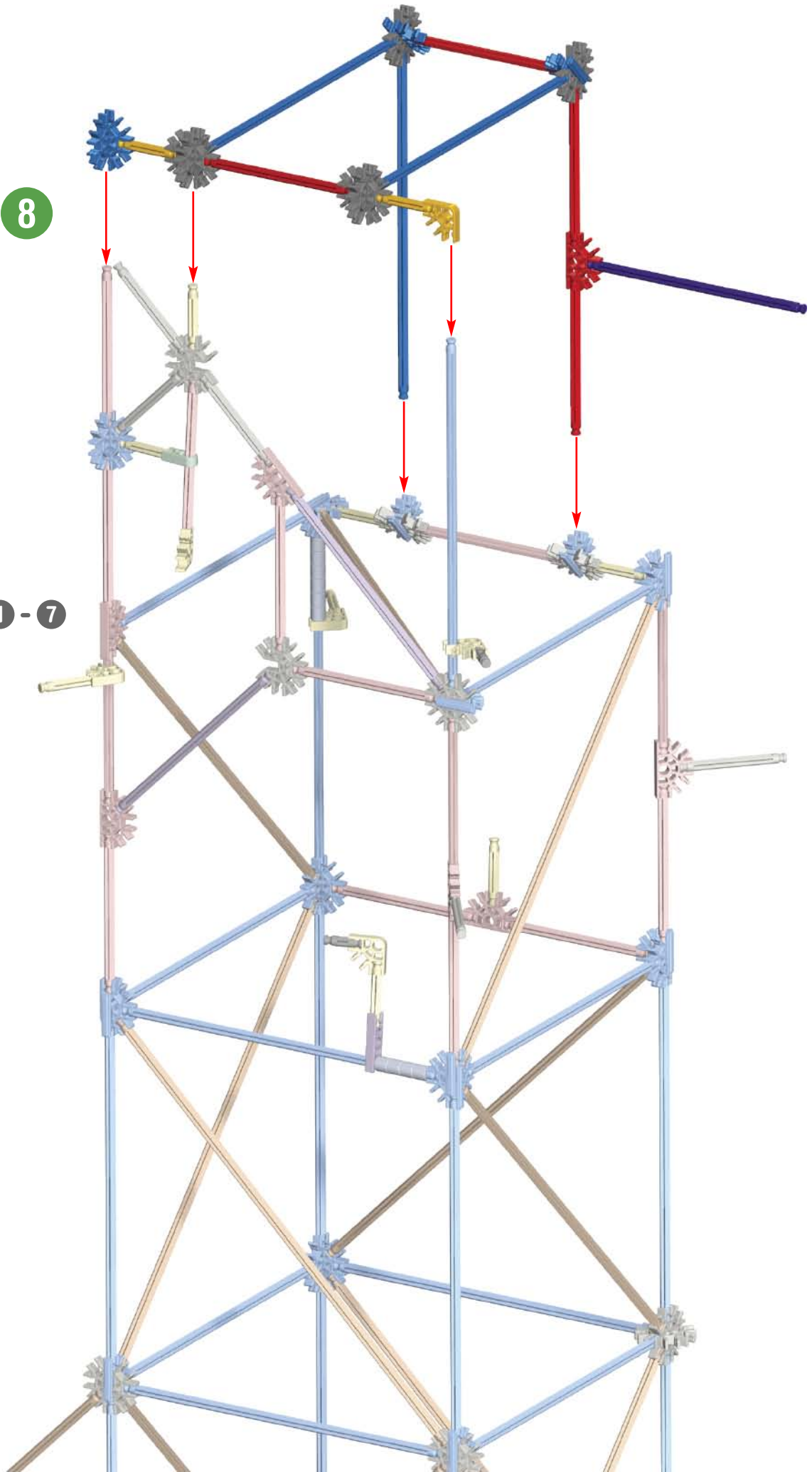

1 - 8

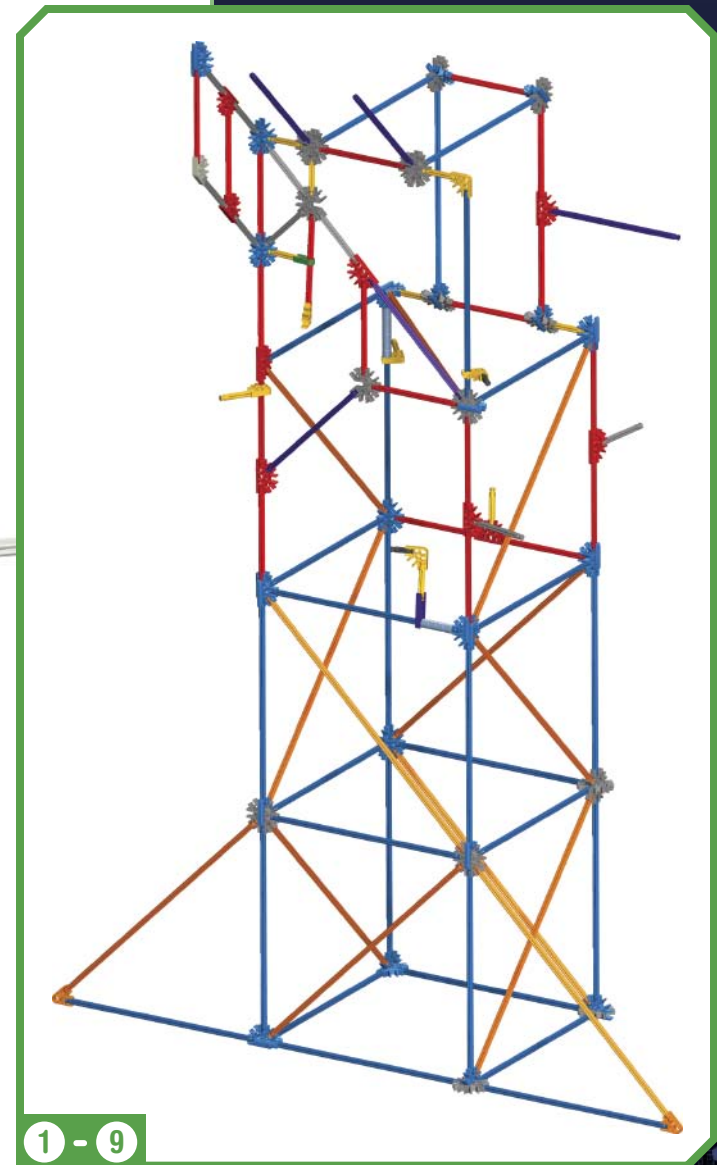
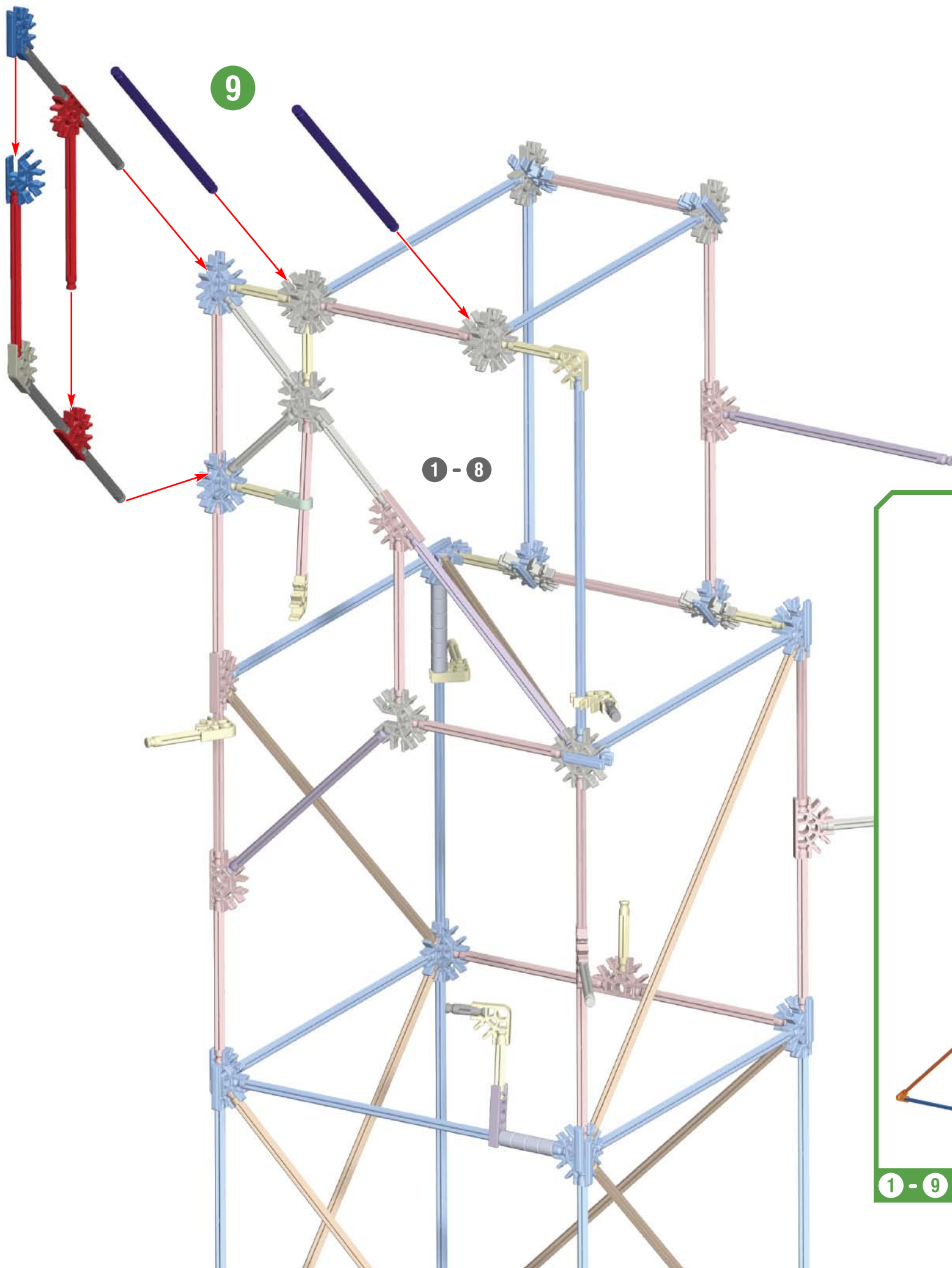

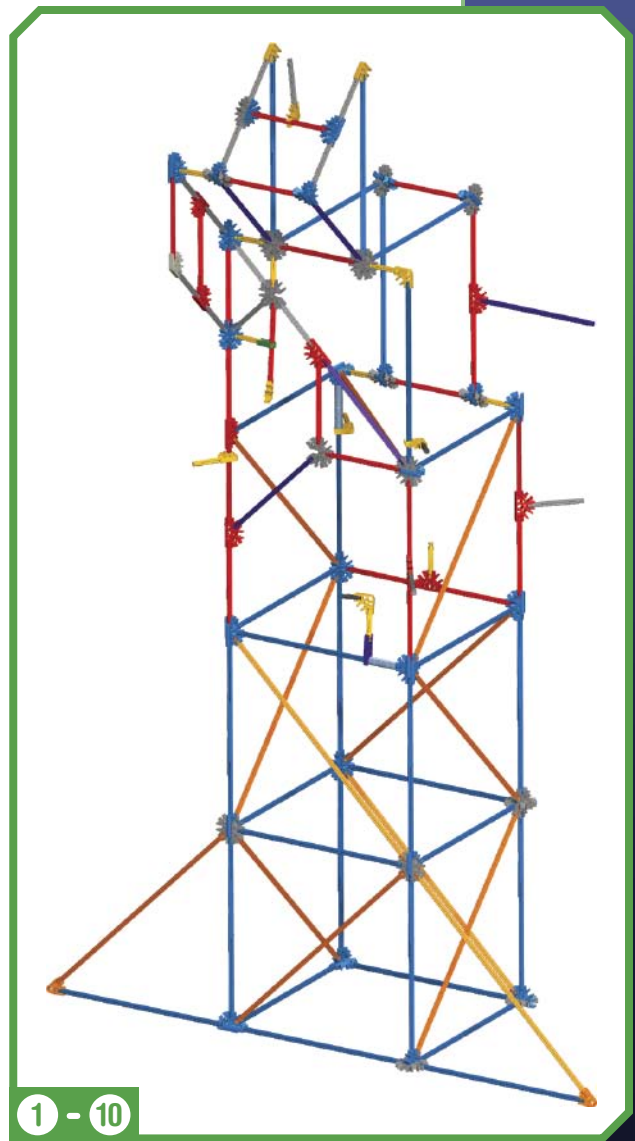
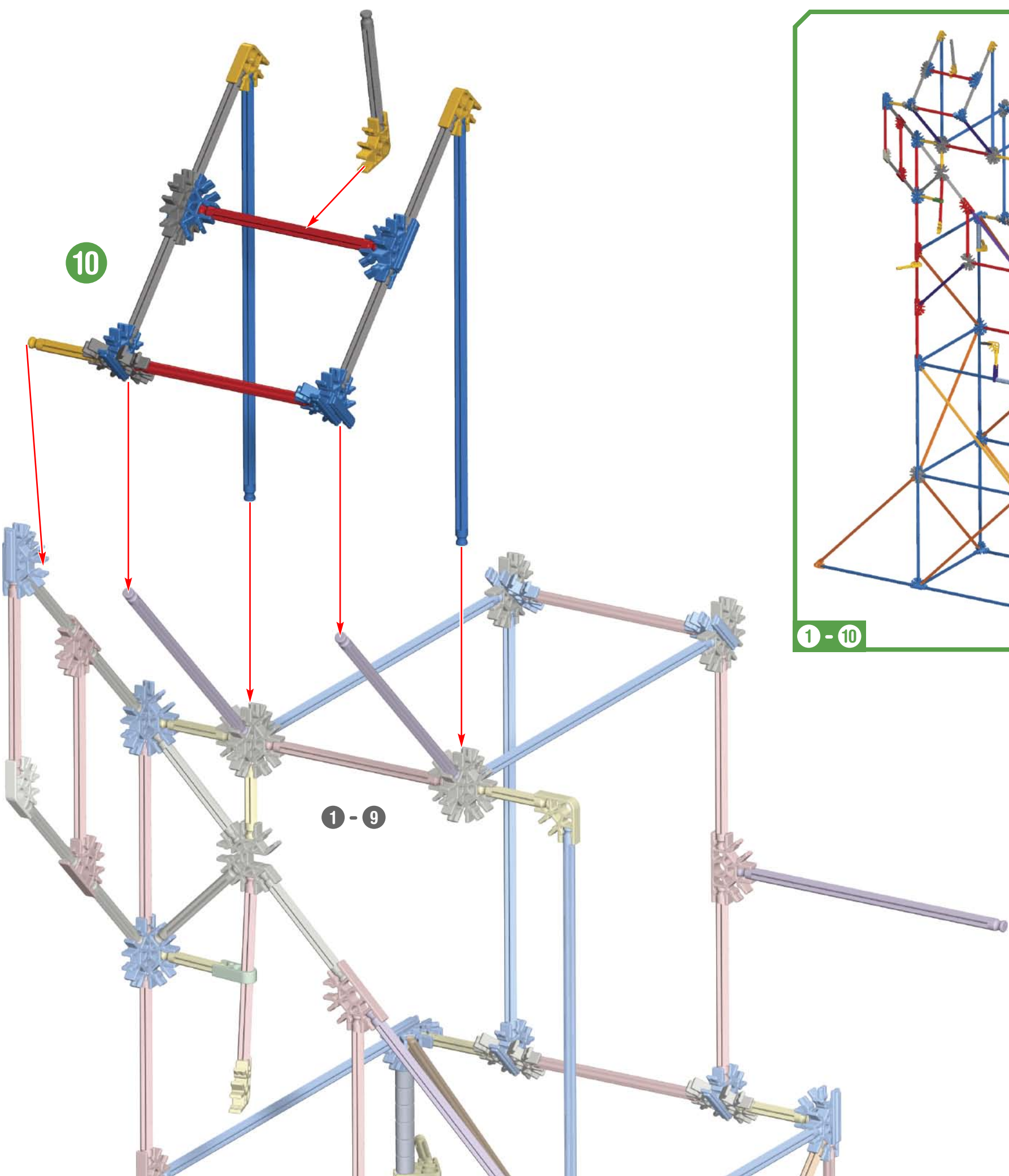

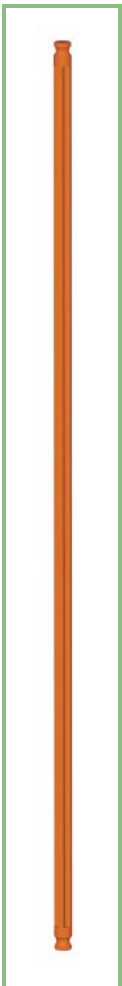

x4

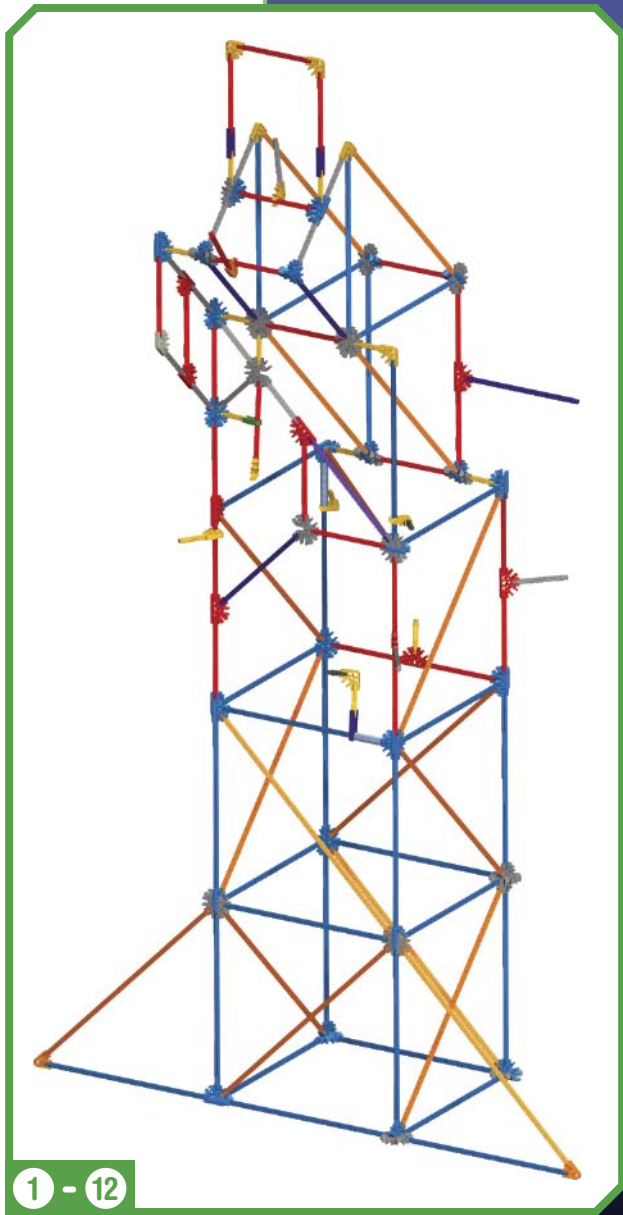
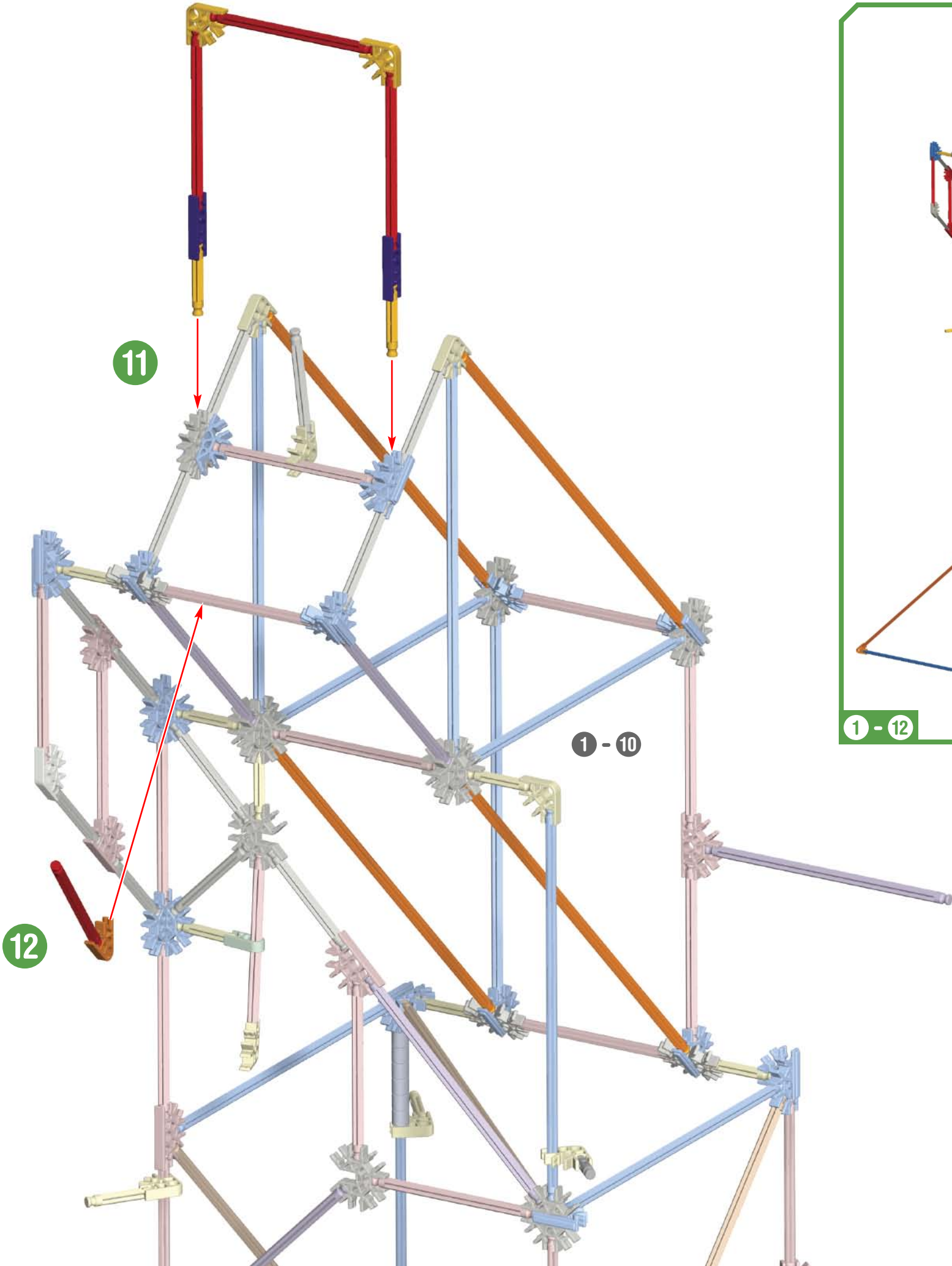

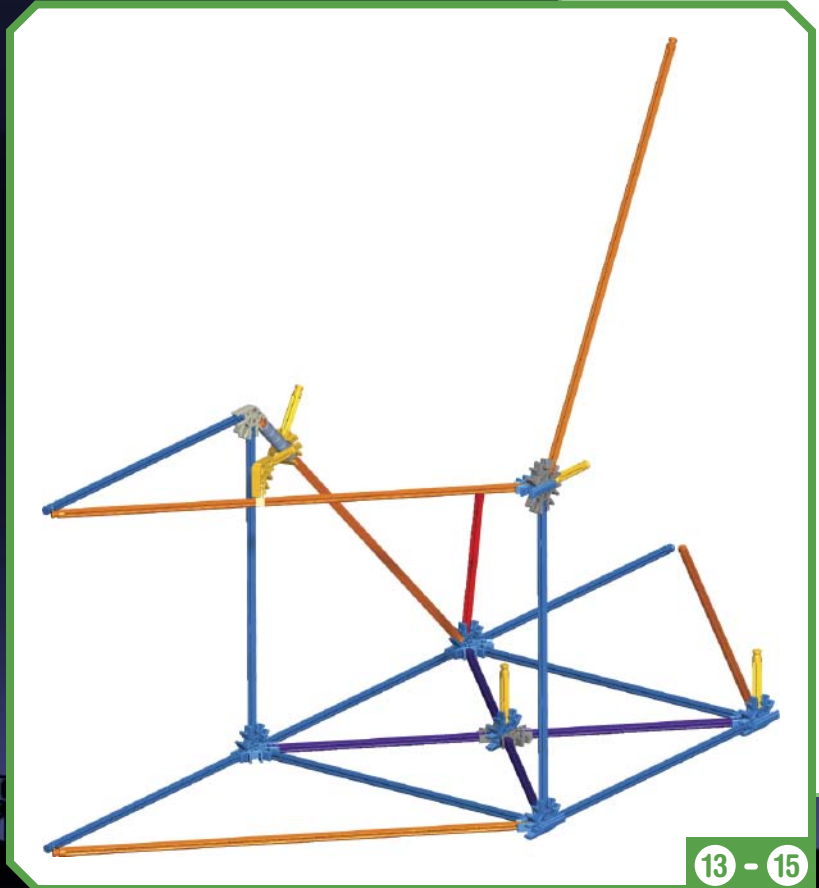
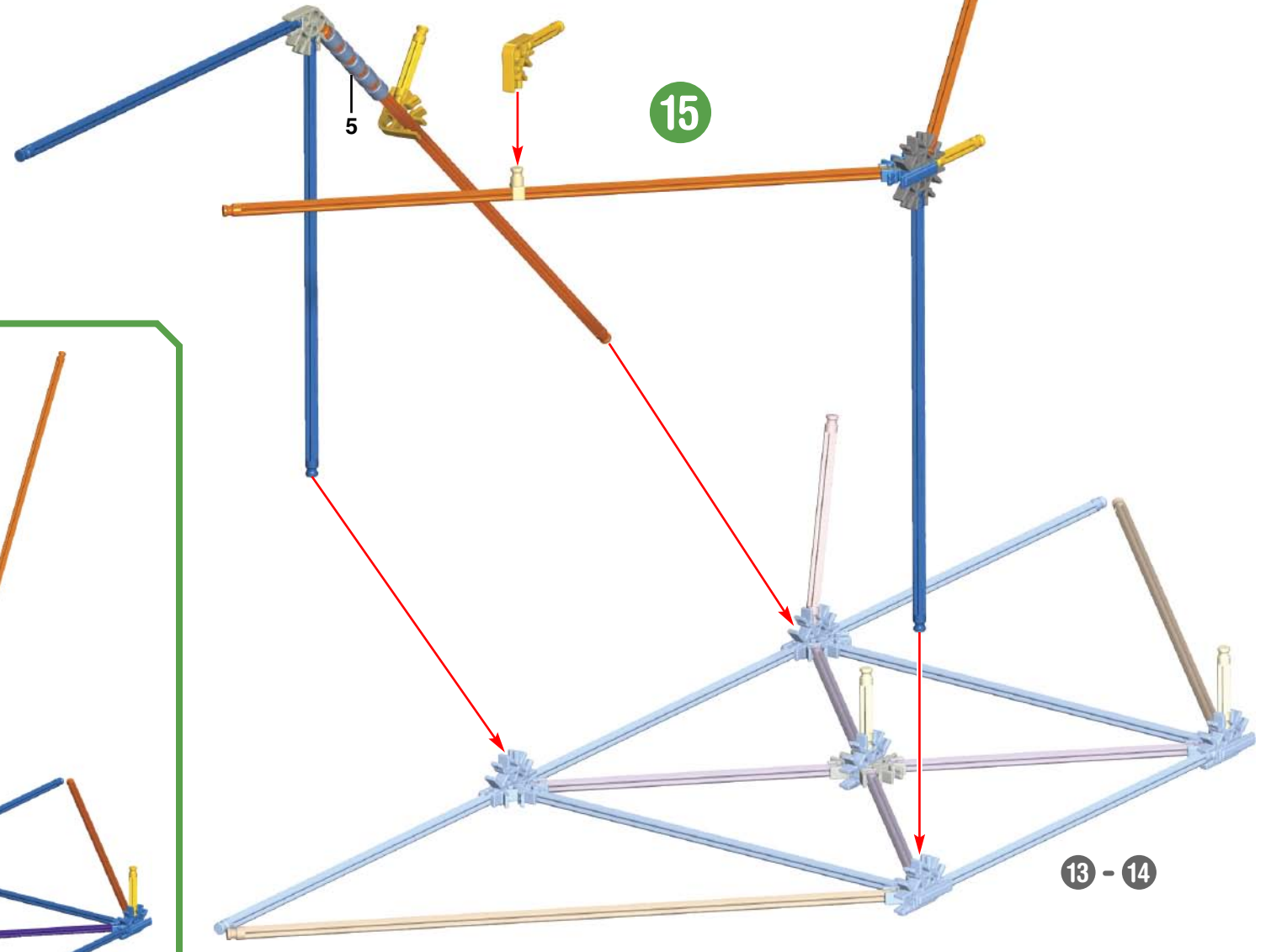
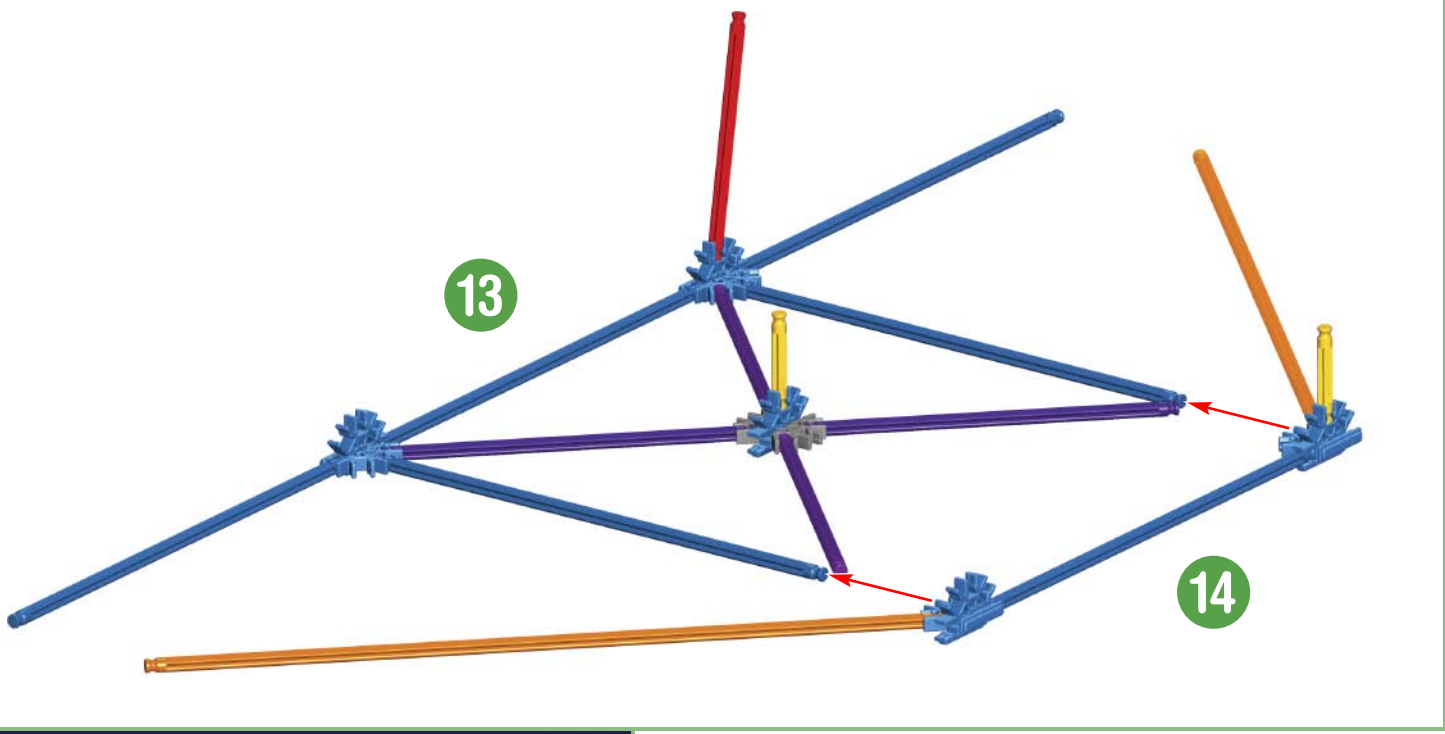

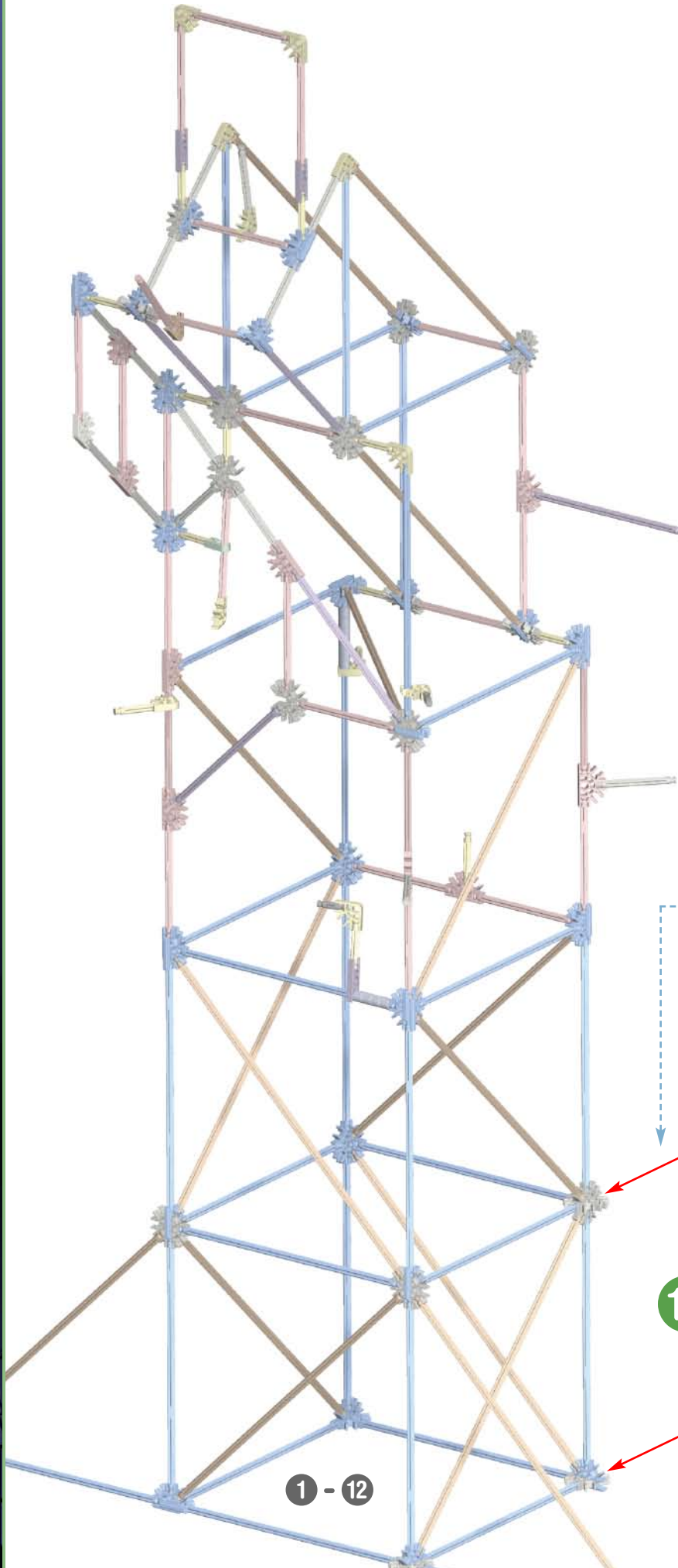

1 - 12

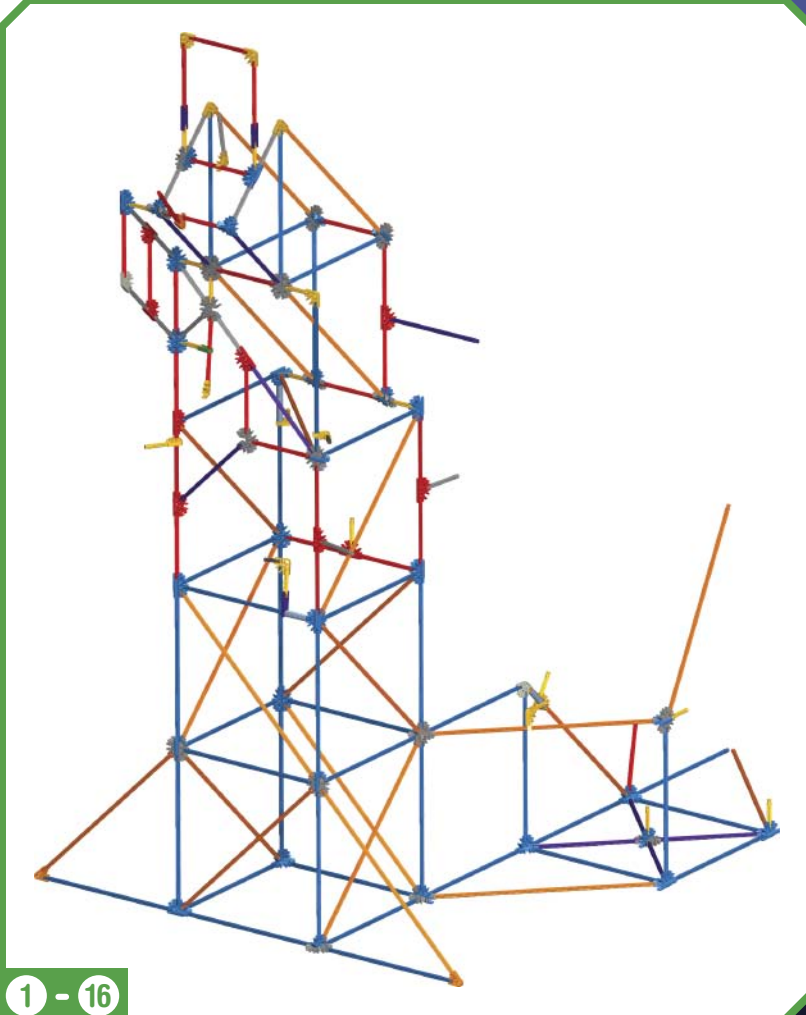
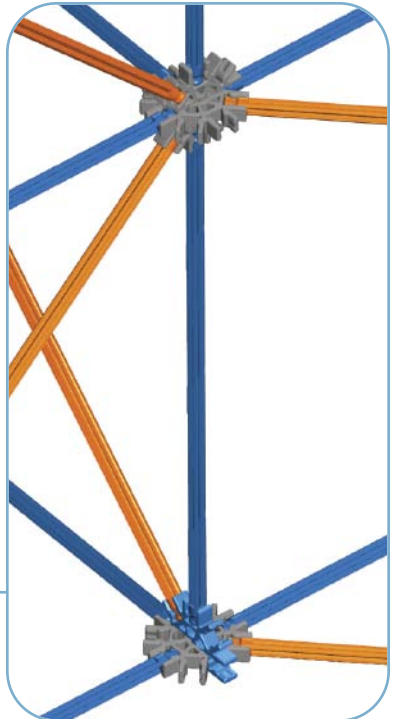

1 - 16

16

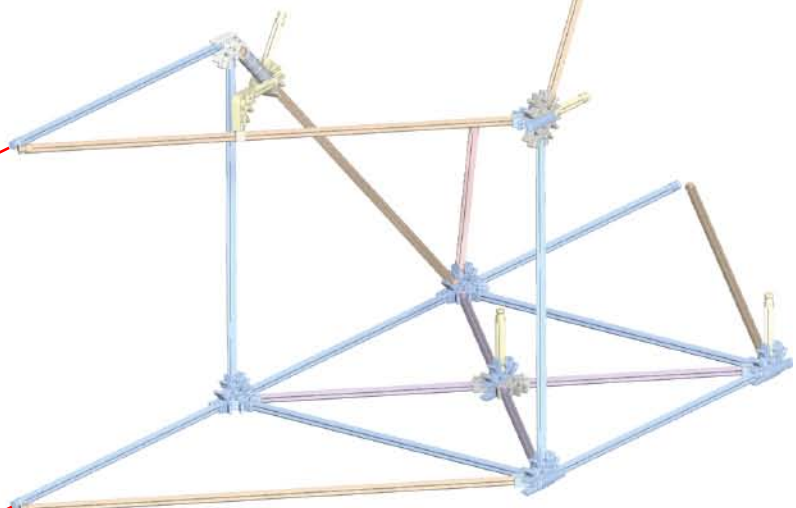

13 - 15



15

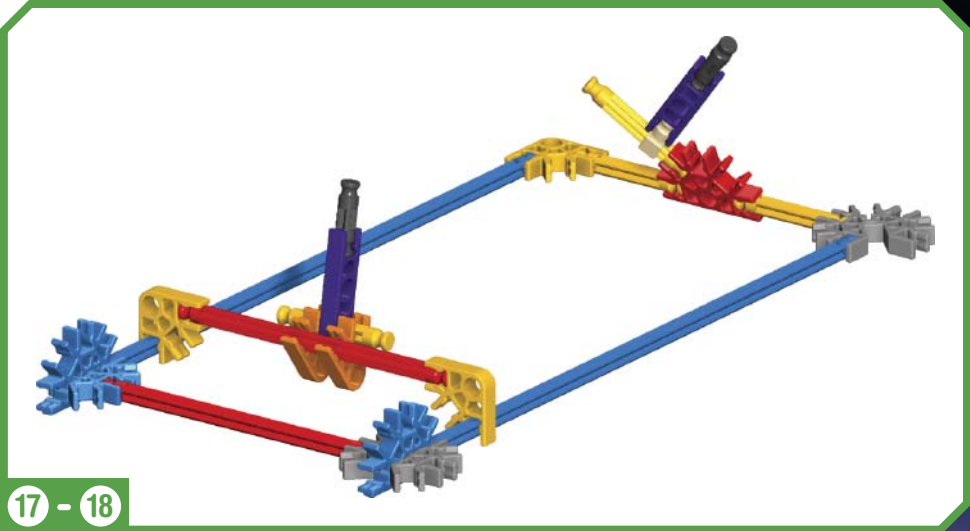
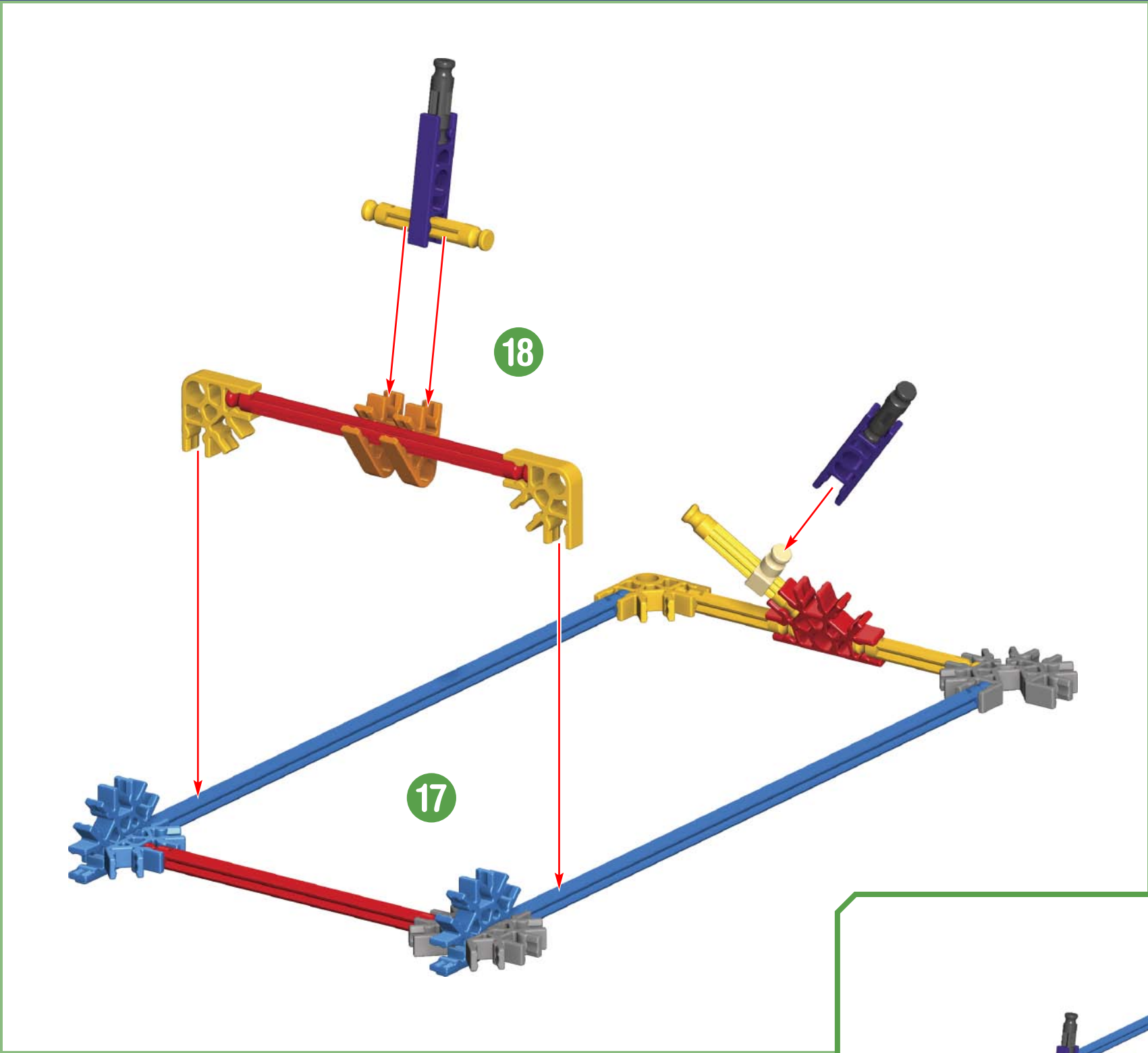

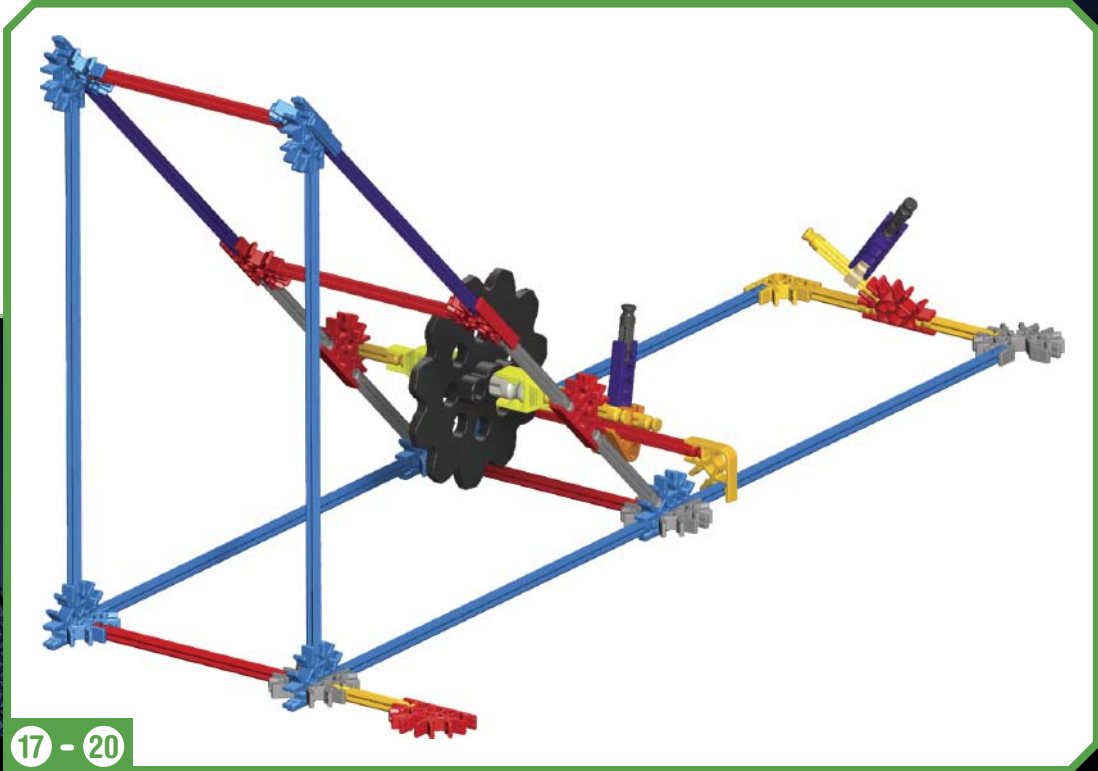
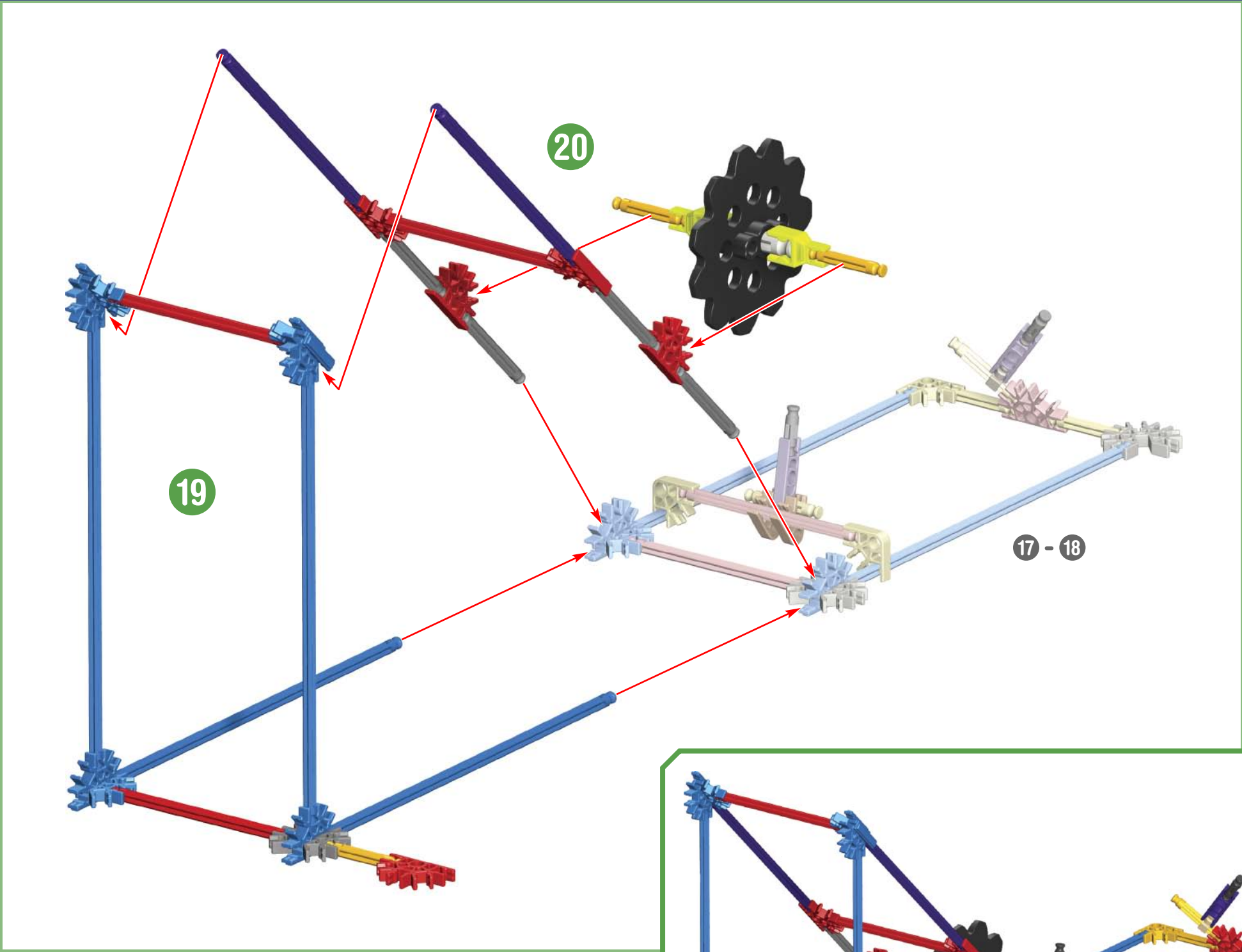

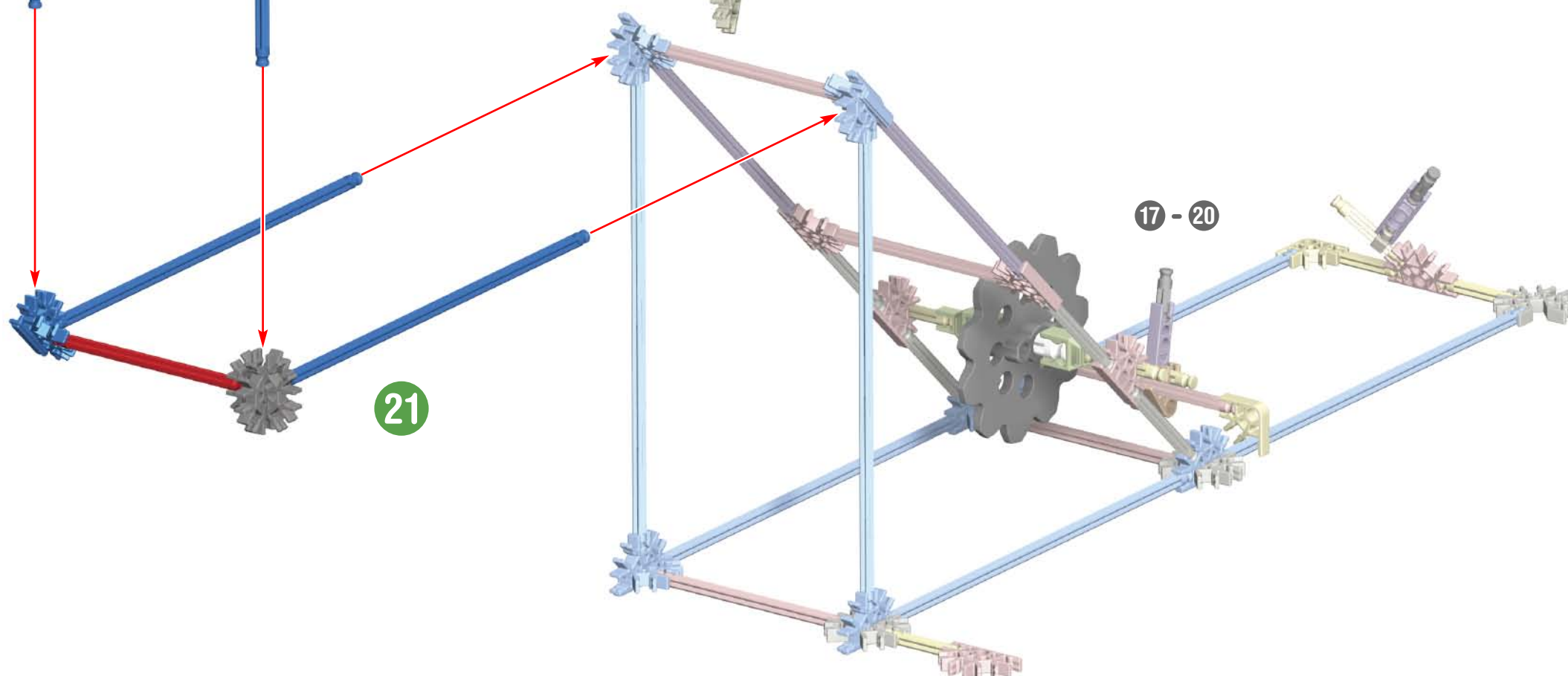
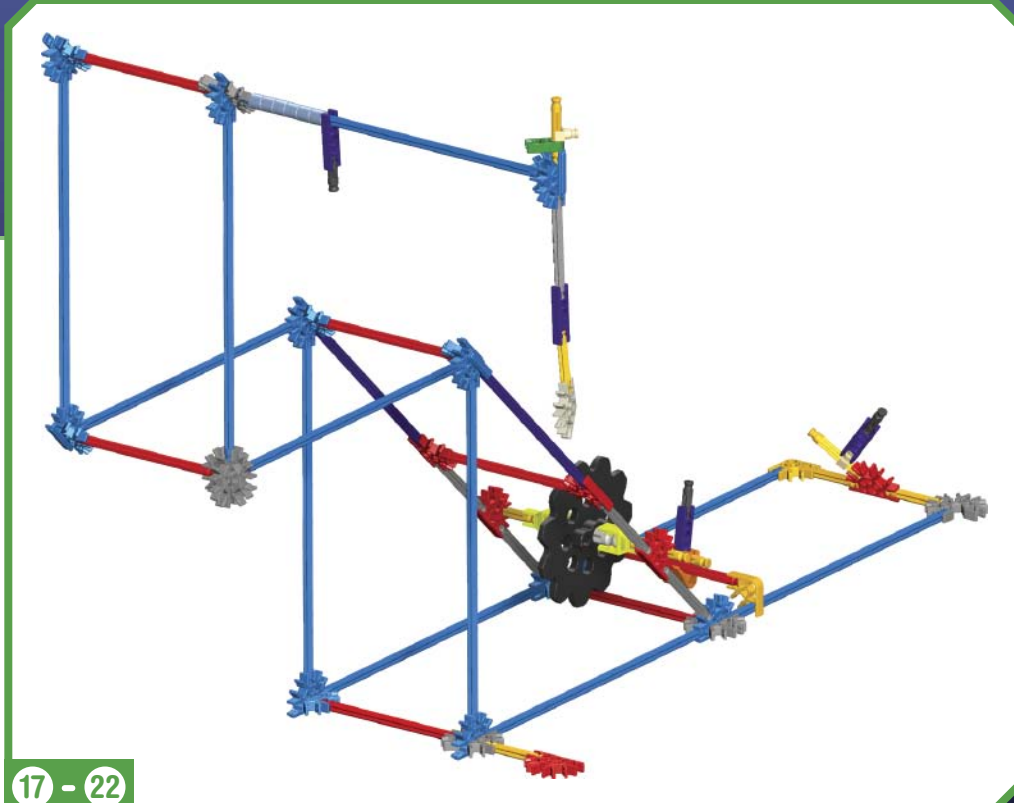

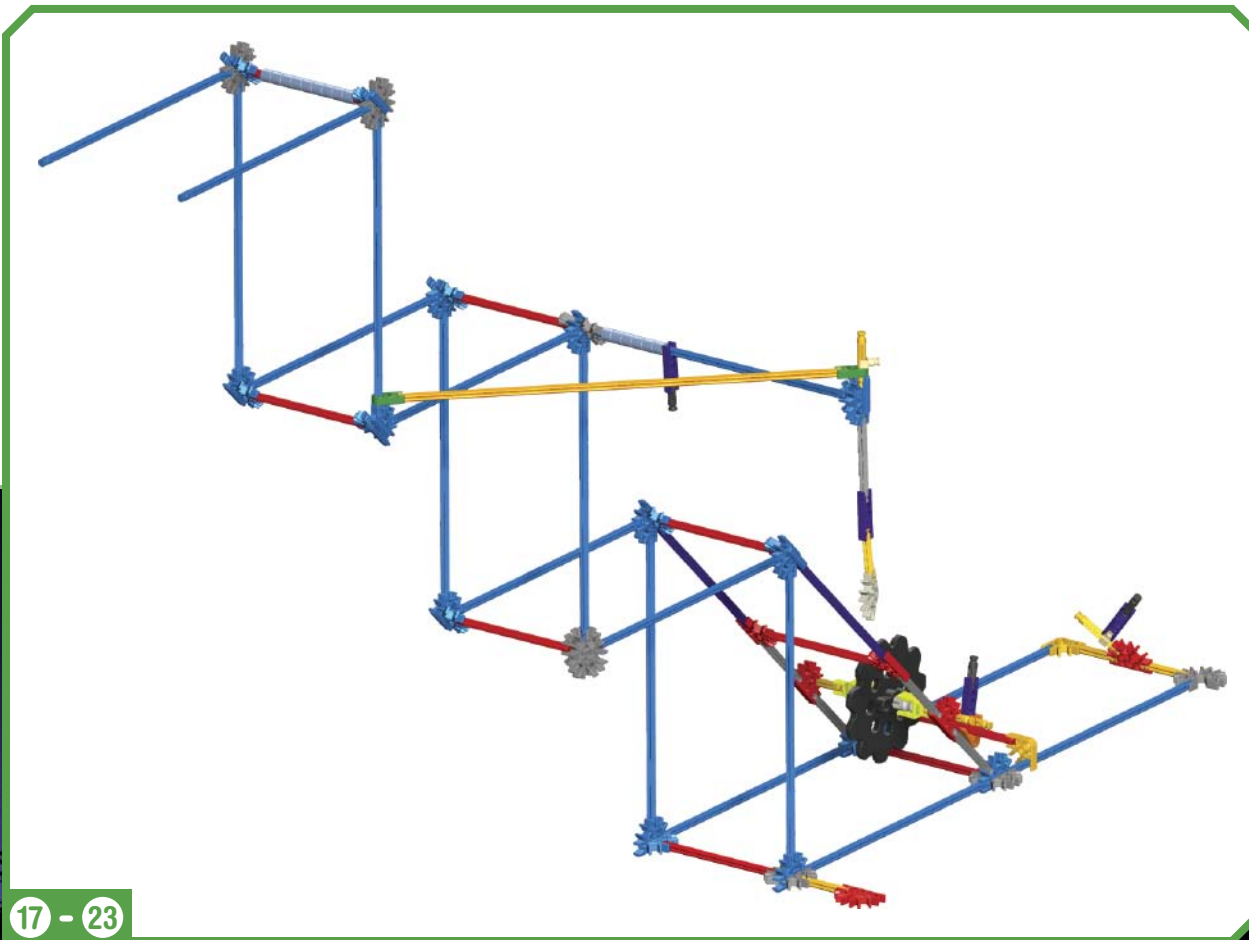
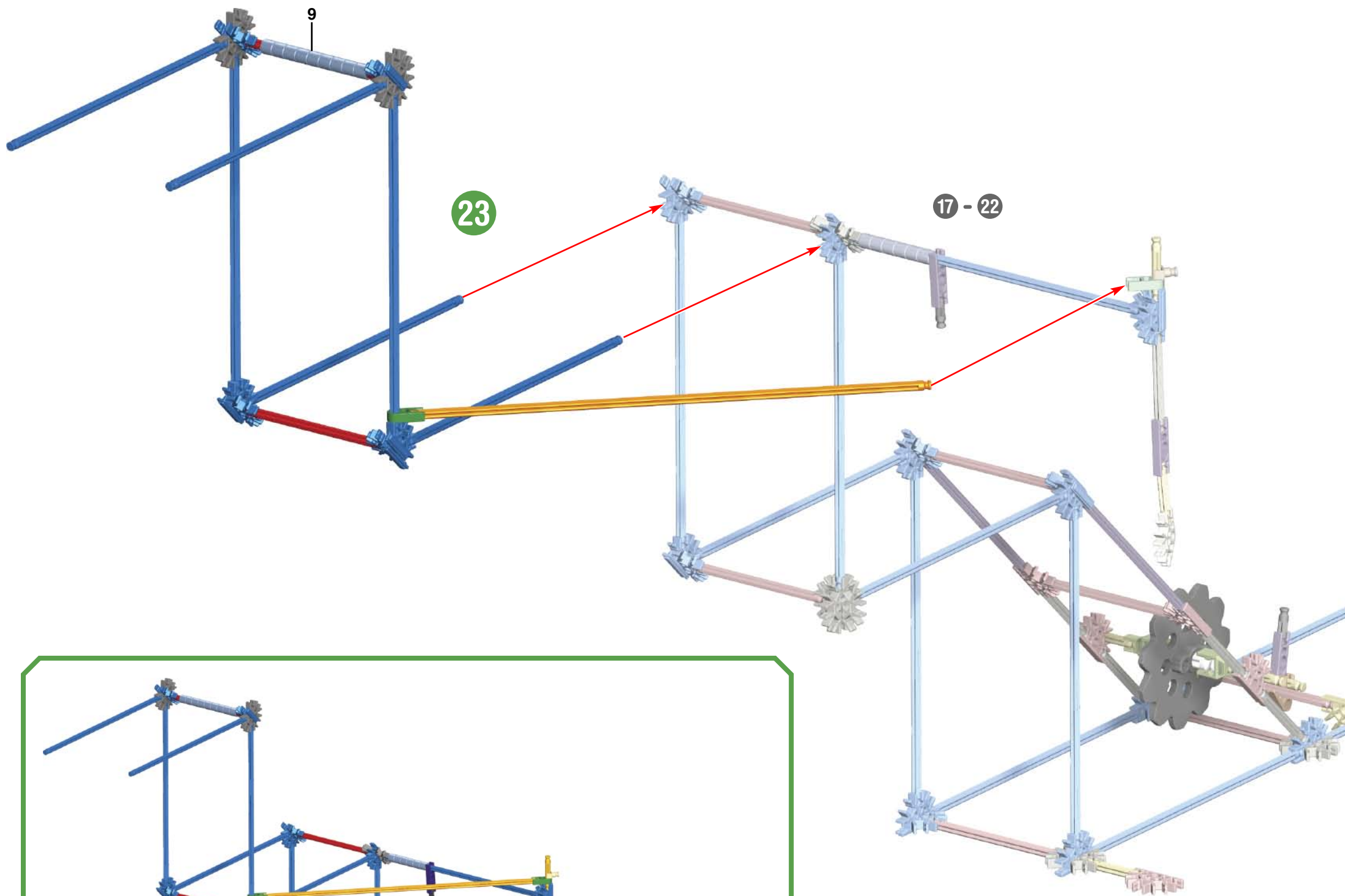

24

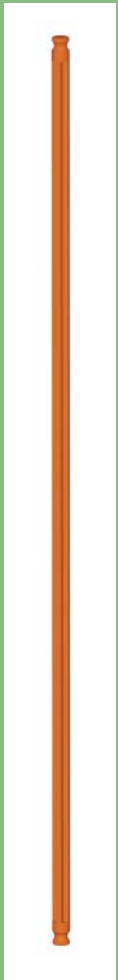
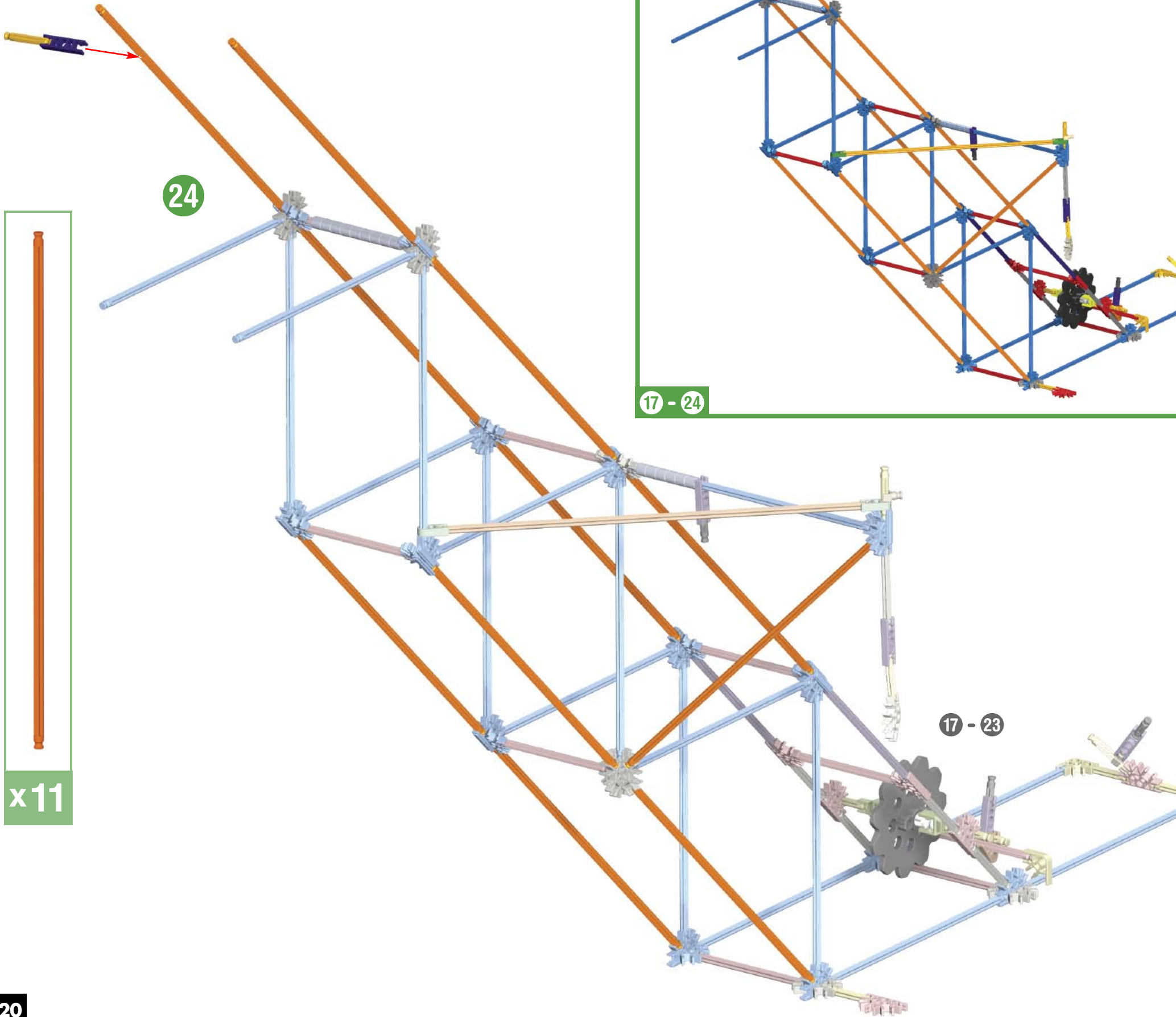

x11

17 - 24

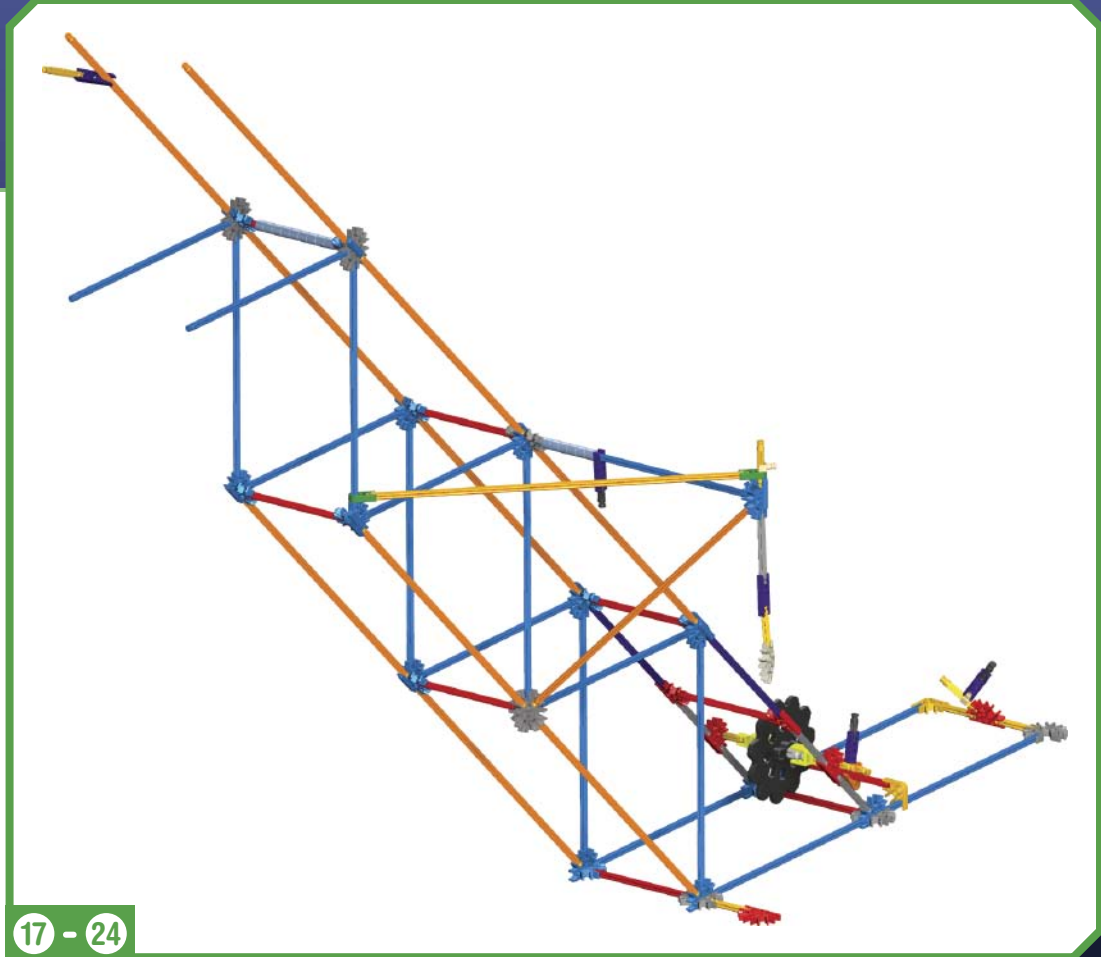

17 - 23



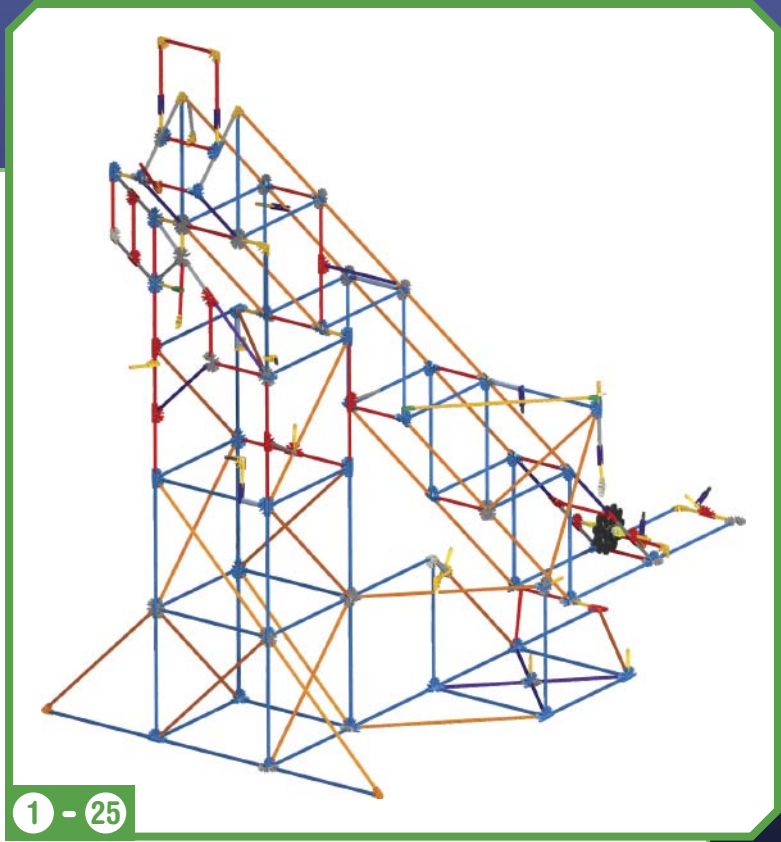
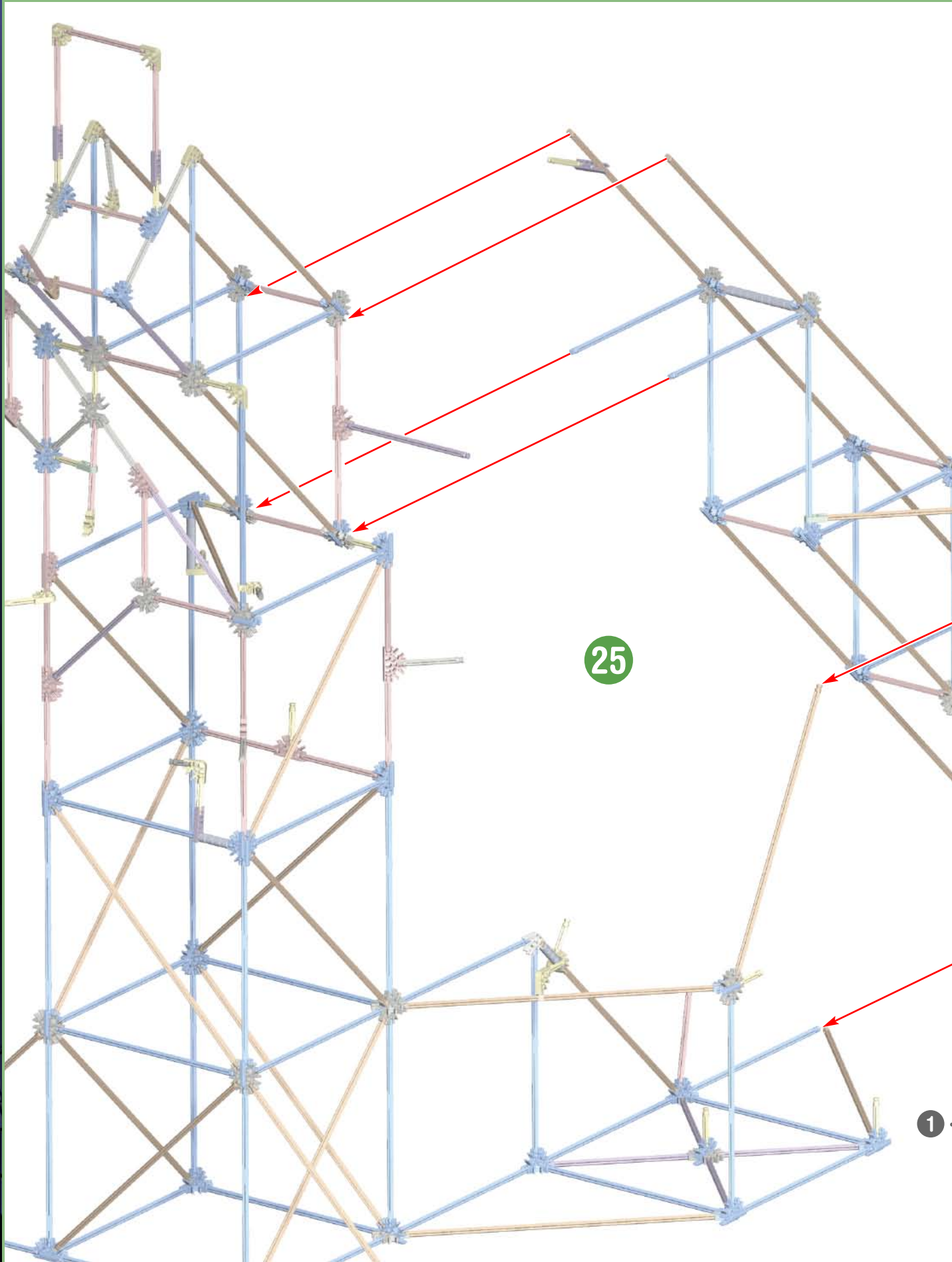

1 - 25

25

17 - 24

1 - 16

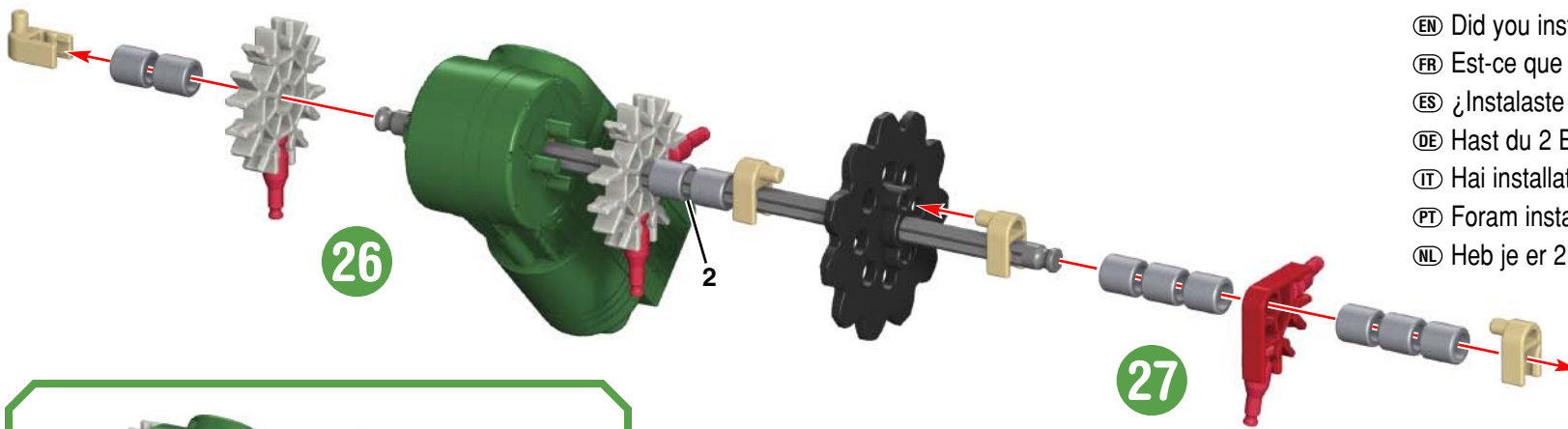

26

27

- Ⓔ Did you install 2 AA (or LR6) batteries in the motor?
- Ⓕ Est-ce que tu as installé 2 piles AA (ou LR6) dans le moteur ?
- Ⓖ ¿Instalaste dos pilas AA (o LR6) en el motor?
- Ⓗ Hast du 2 Batterien der Baugröße AA (oder LR6) eingelegt?
- Ⓙ Hai installato 2 batterie AA (o LR6) nel motore?
- Ⓟ Foram instaladas as pilhas 2 AA (ou LR6) no motor?
- Ⓝ Heb je er 2 AA (of LR6) batterijen ingestoken?

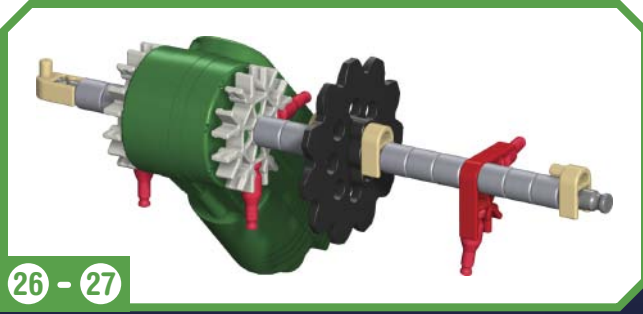

26 - 27

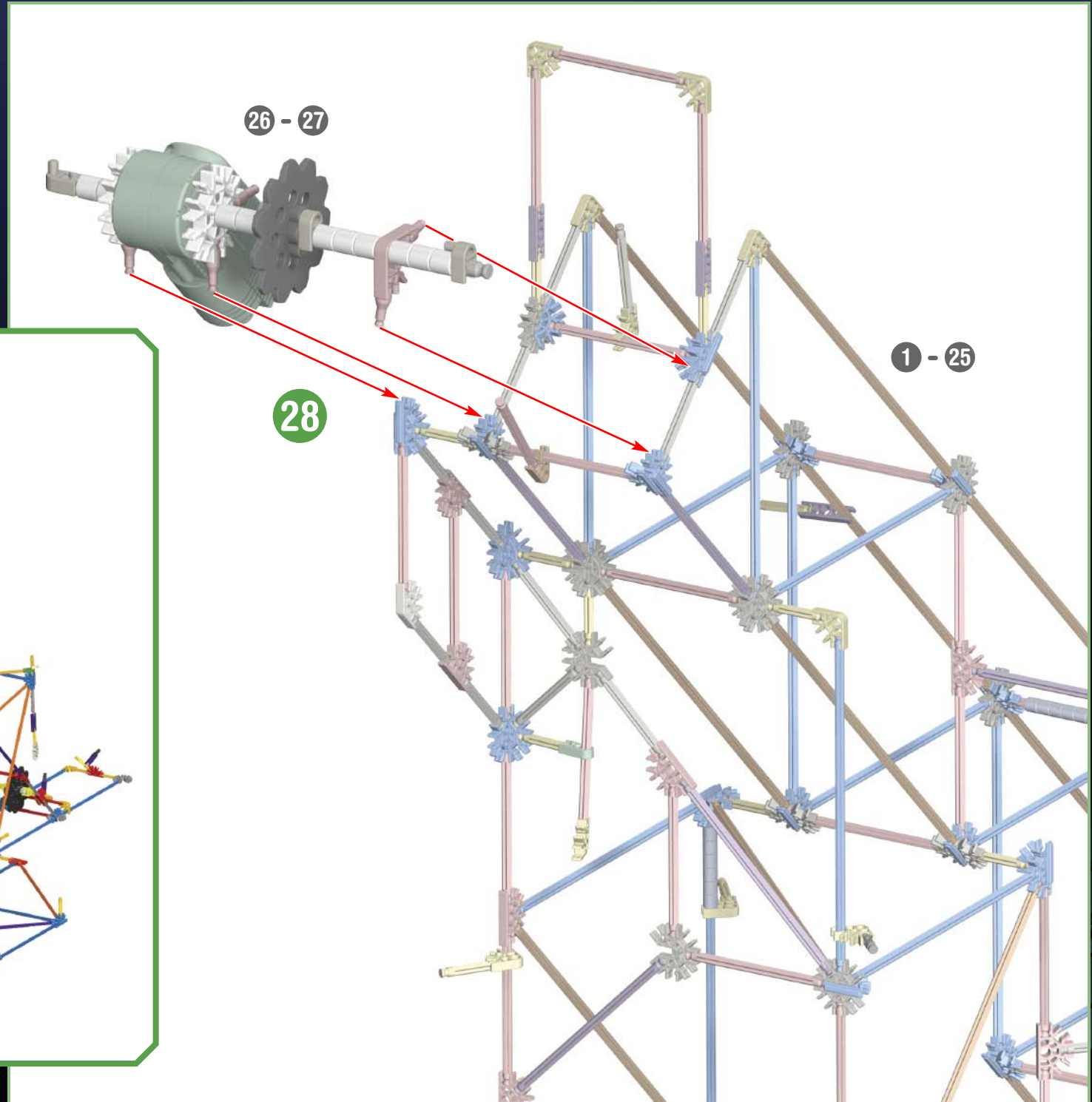

26 - 27

1 - 25

28

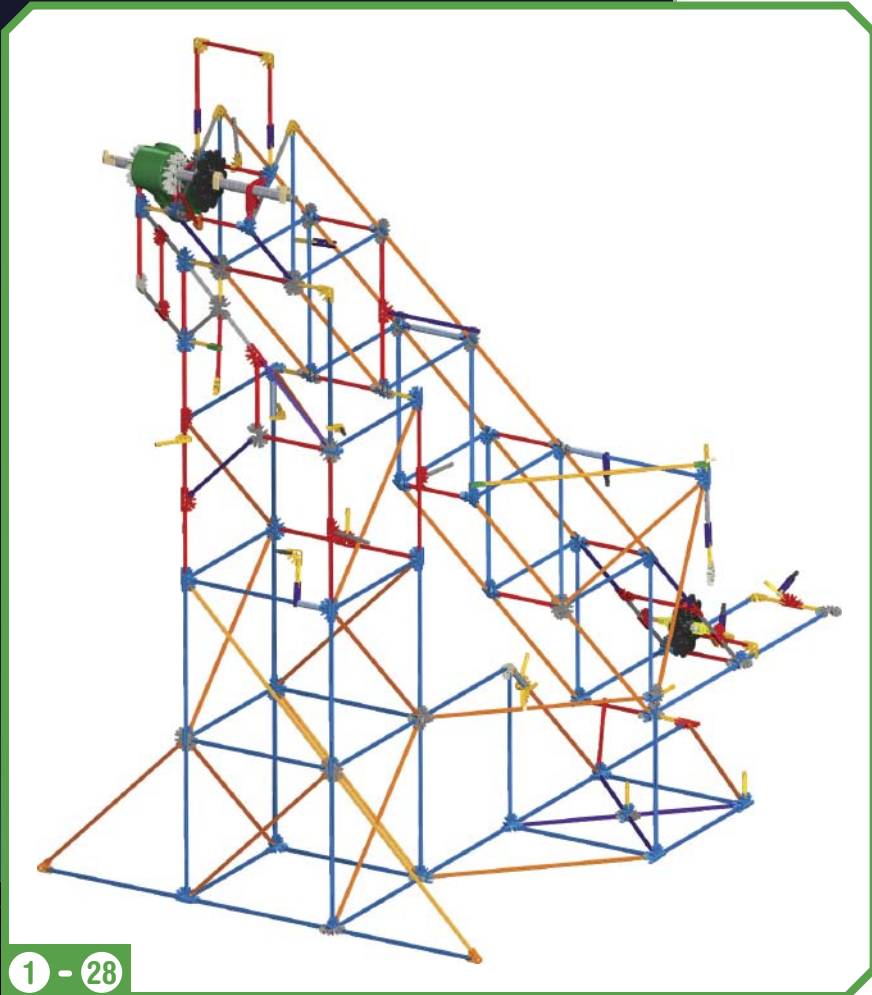

1 - 28

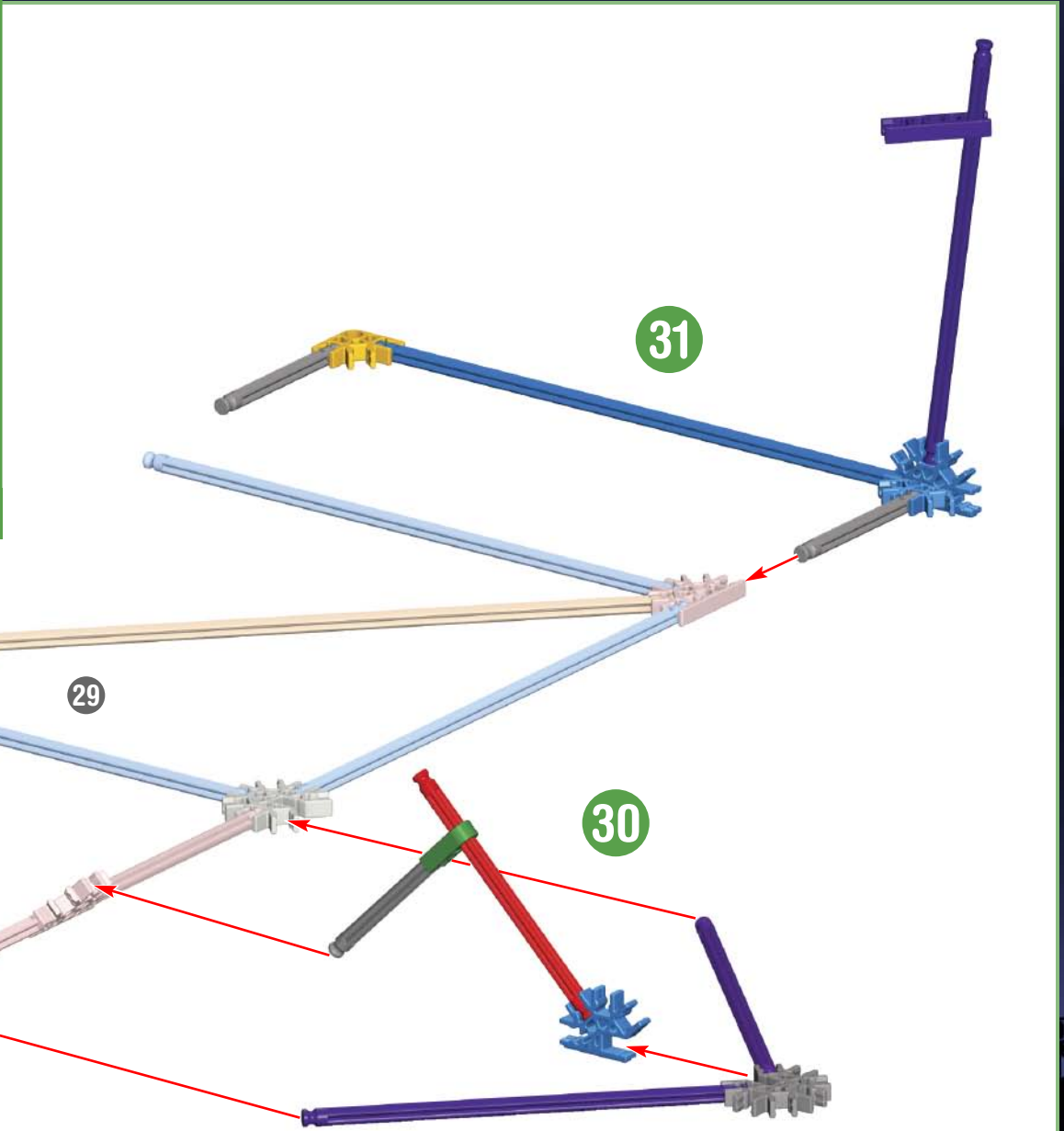
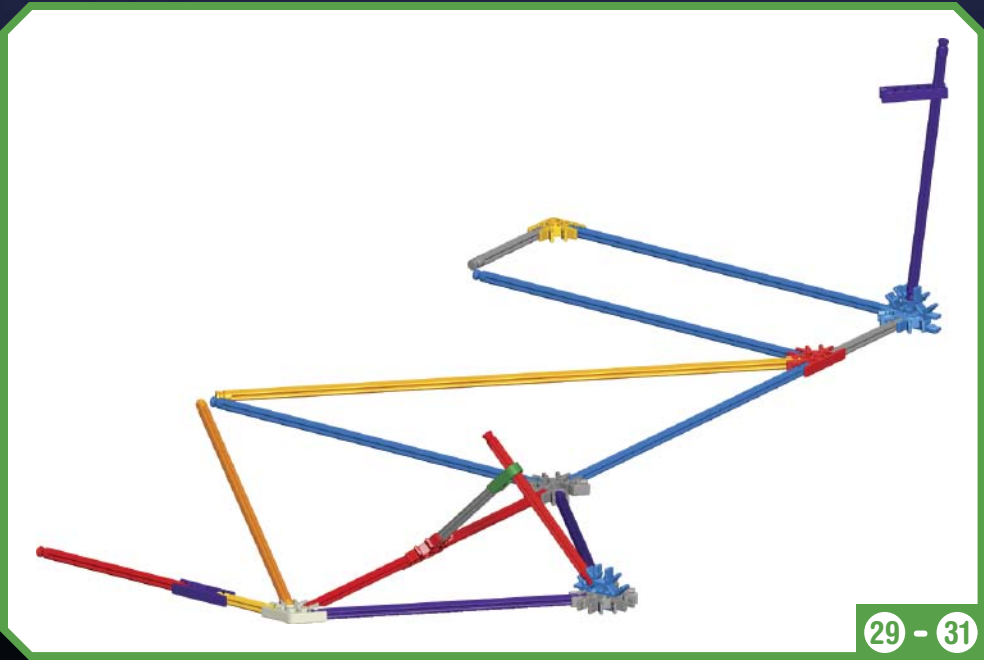

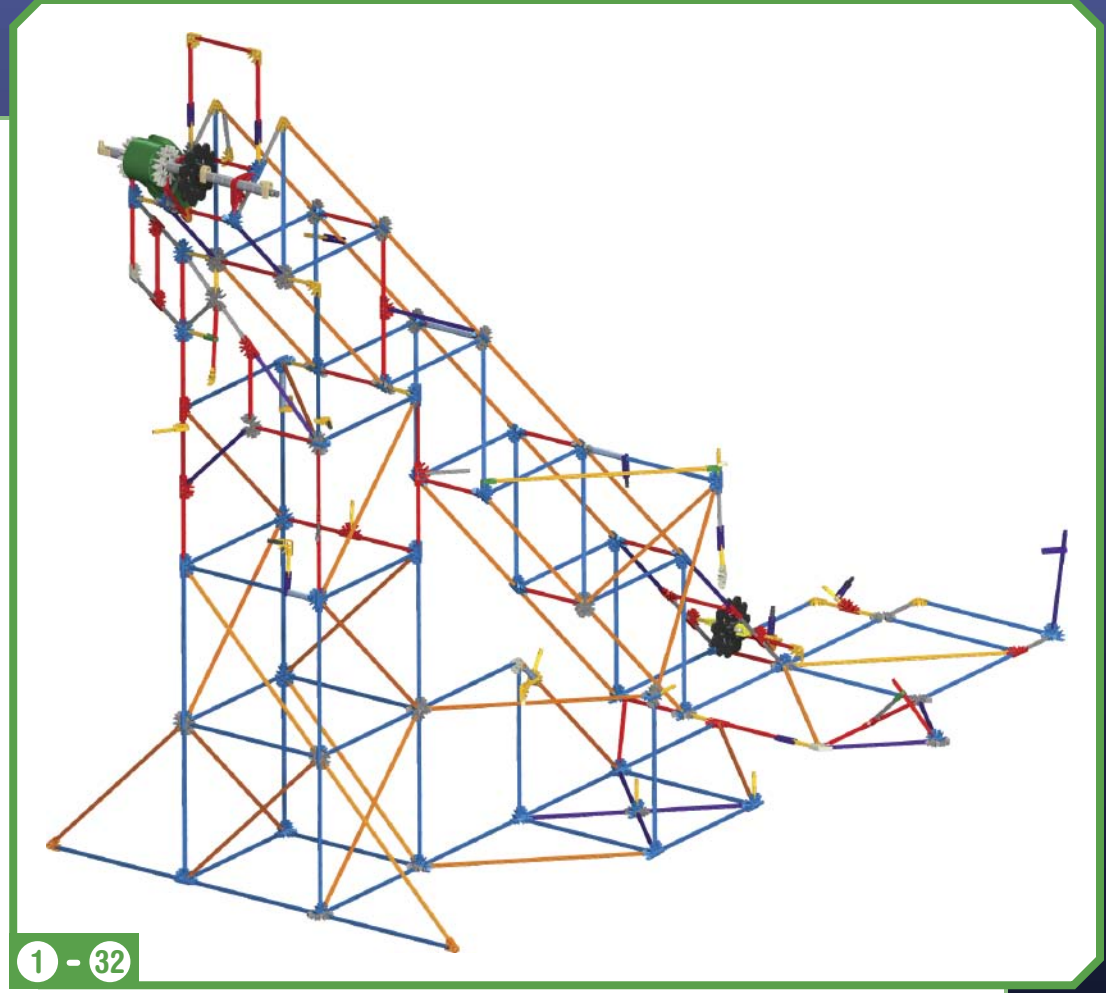
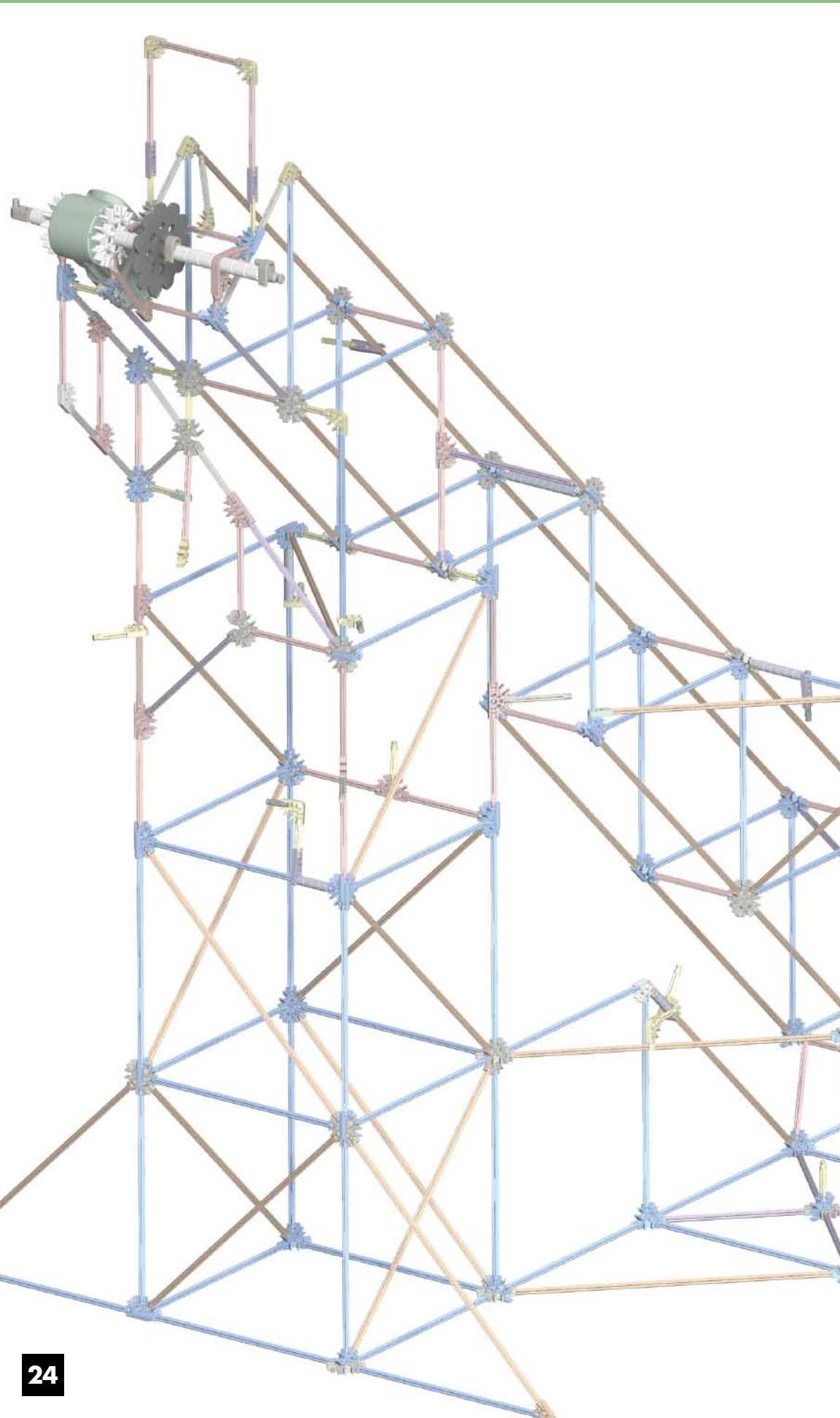

1 - 32

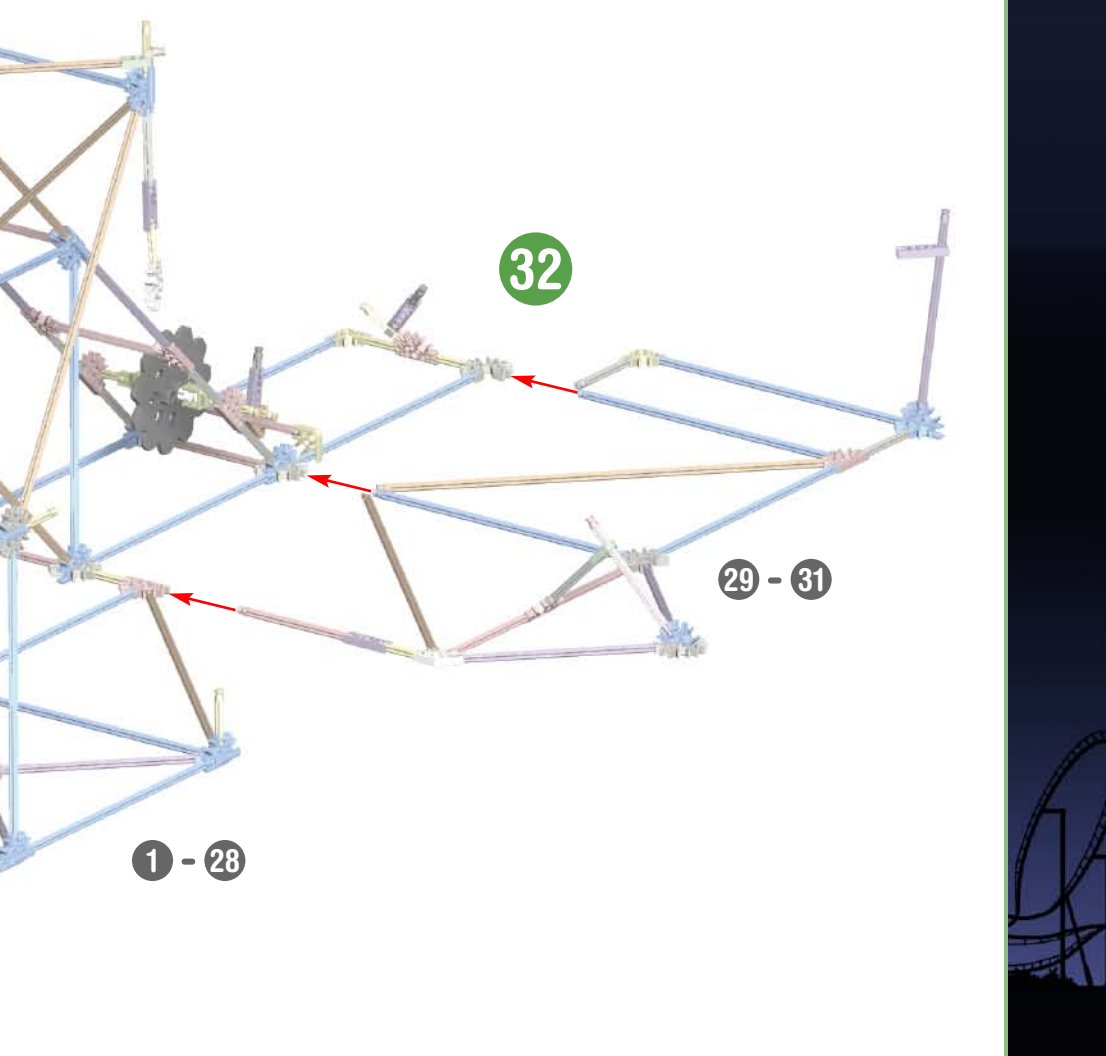

32

29 - 31

1 - 28



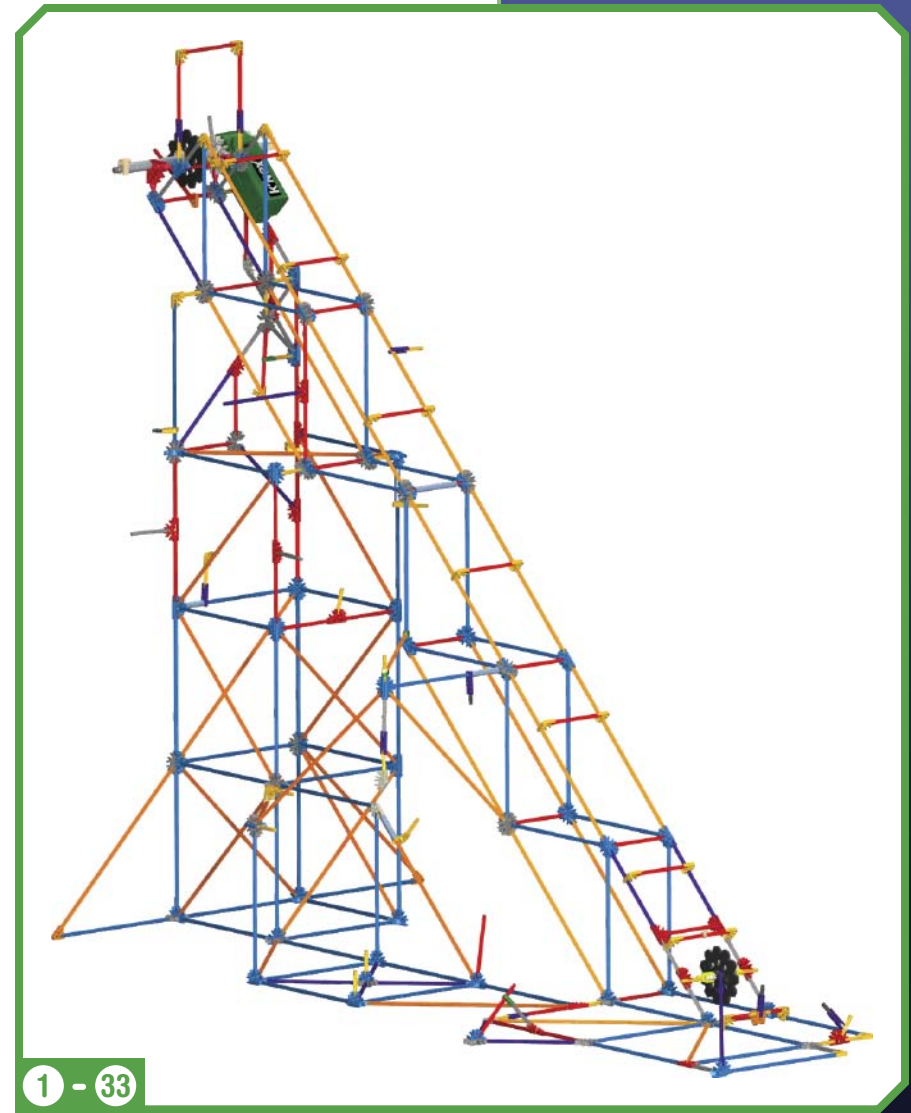
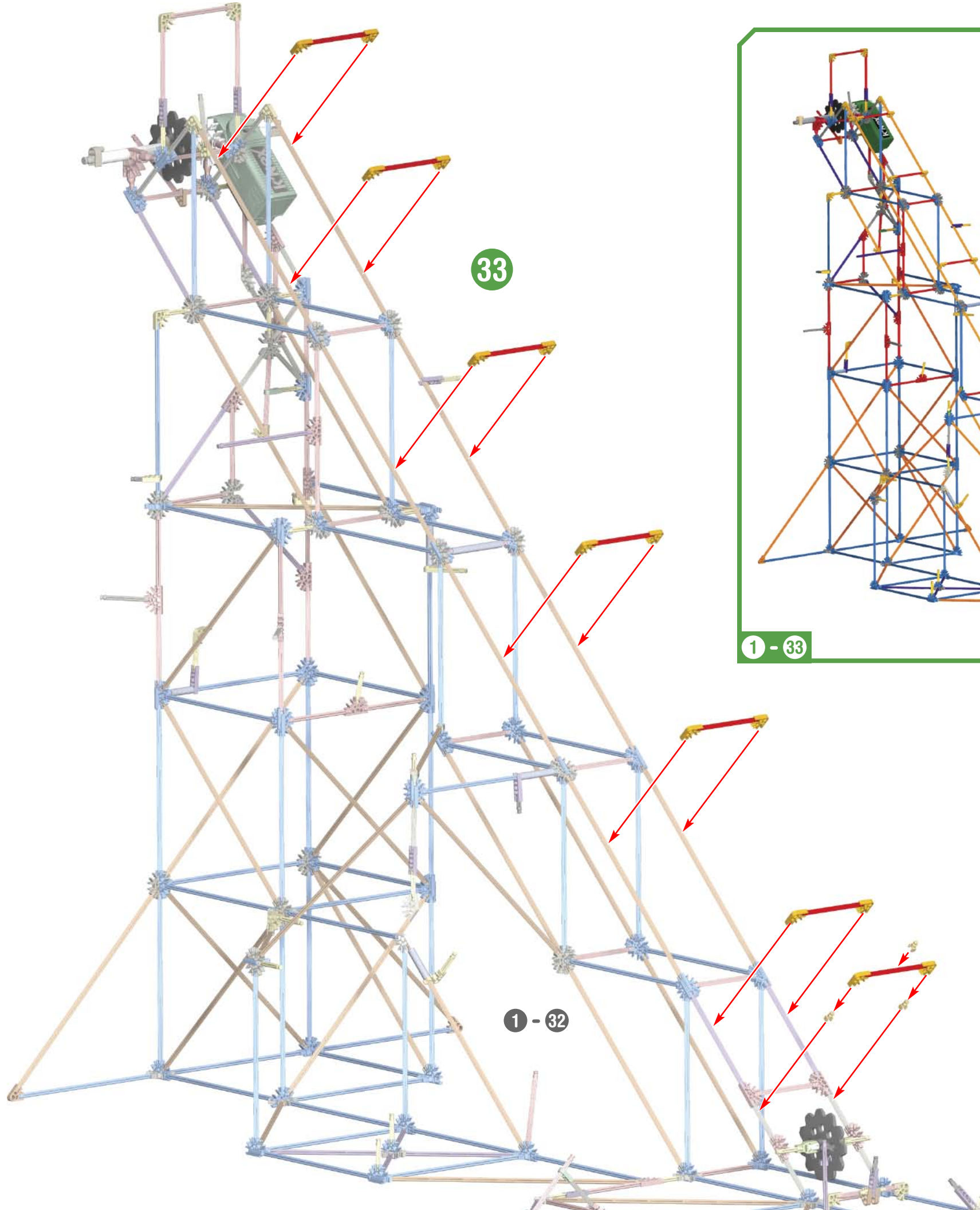

Track Building Tips: Conseils pour le circuit :

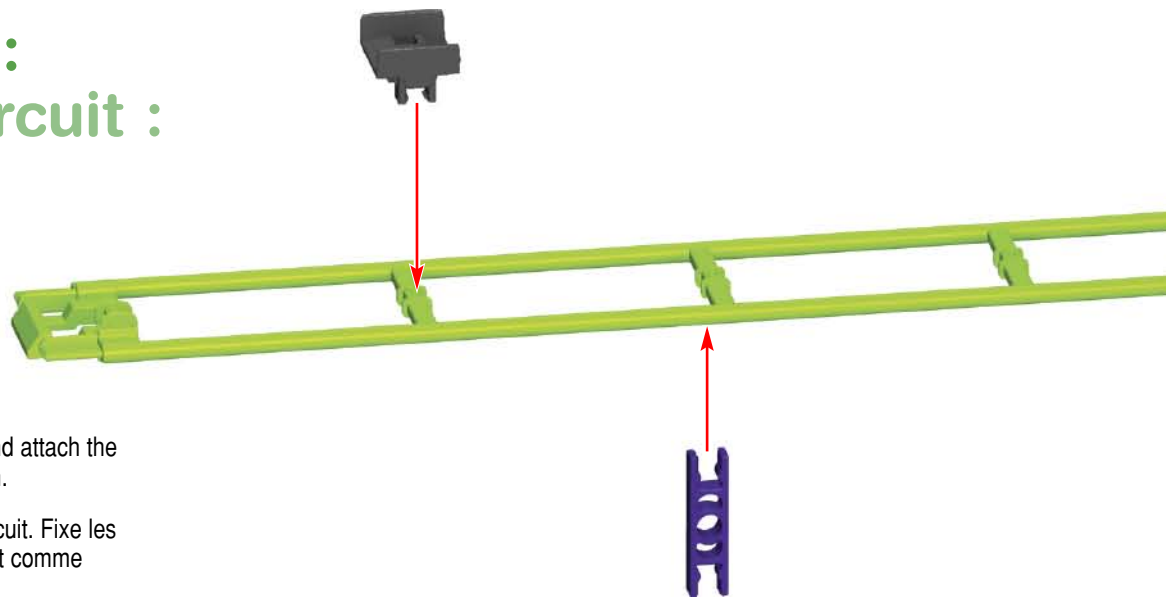

- Ⓔ Attach the black chain guides to the top of the track and attach the connectors to the bottom of the track exactly as shown.
- Ⓕ Fixe les guides de chaîne à la partie supérieure du circuit. Fixe les connecteurs à la partie inférieure du circuit exactement comme l'indique le schéma.

- Ⓔ Be sure to push the connectors on firmly until they "click".
- Ⓕ Pousse bien les connecteurs jusqu'à ce qu'ils « cliquent ».

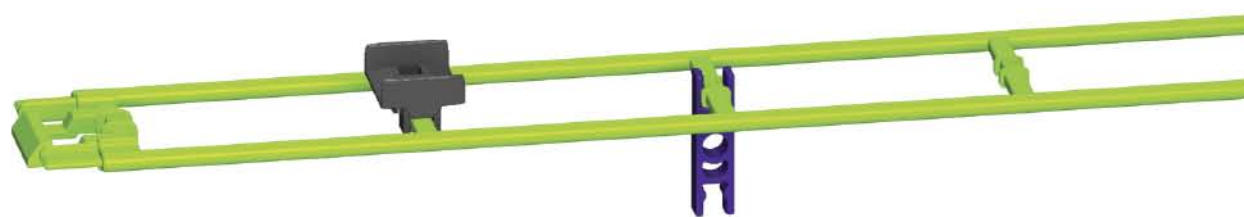

- Ⓔ Always connect the track top side to top side throughout the build.
- Ⓕ Connecte toujours le côté supérieur du circuit contre côté supérieur tout au long de la construction.

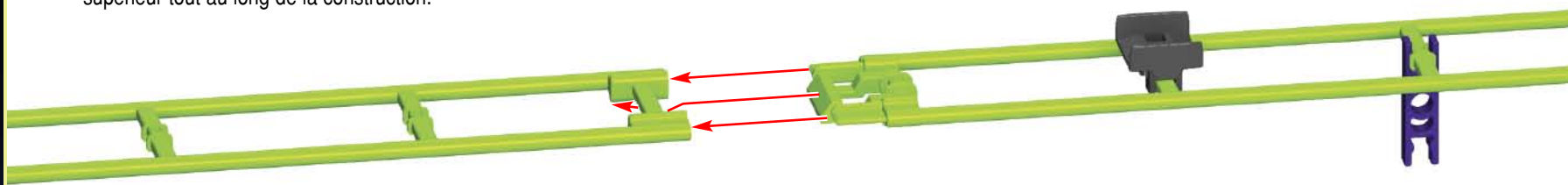

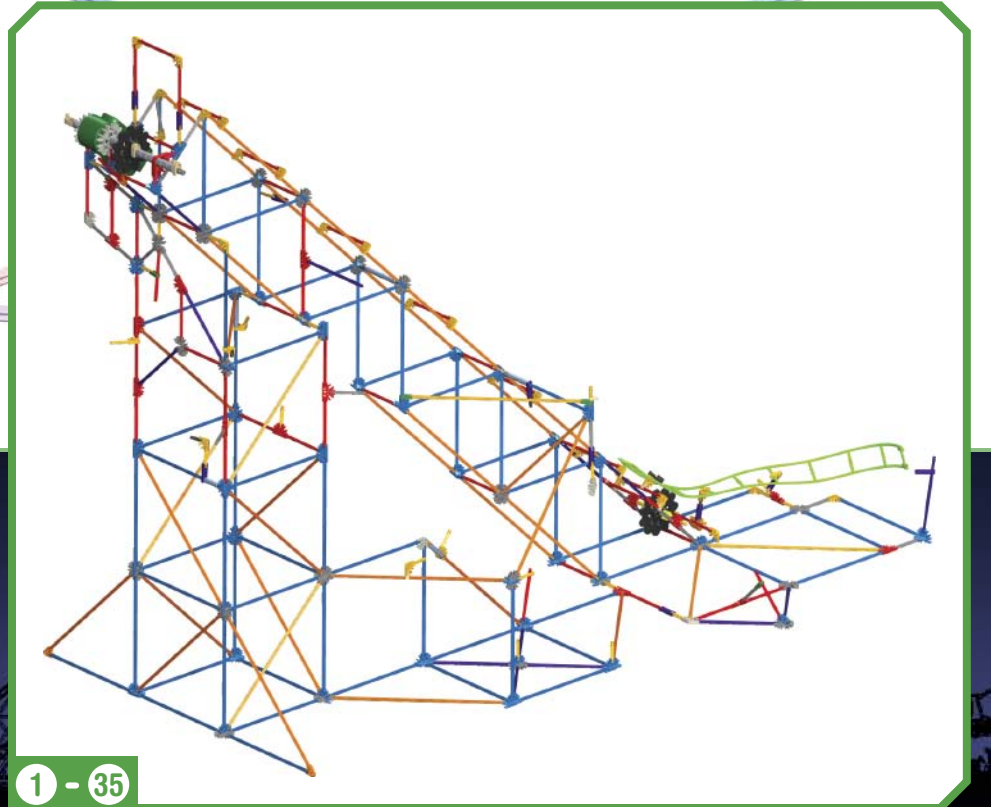
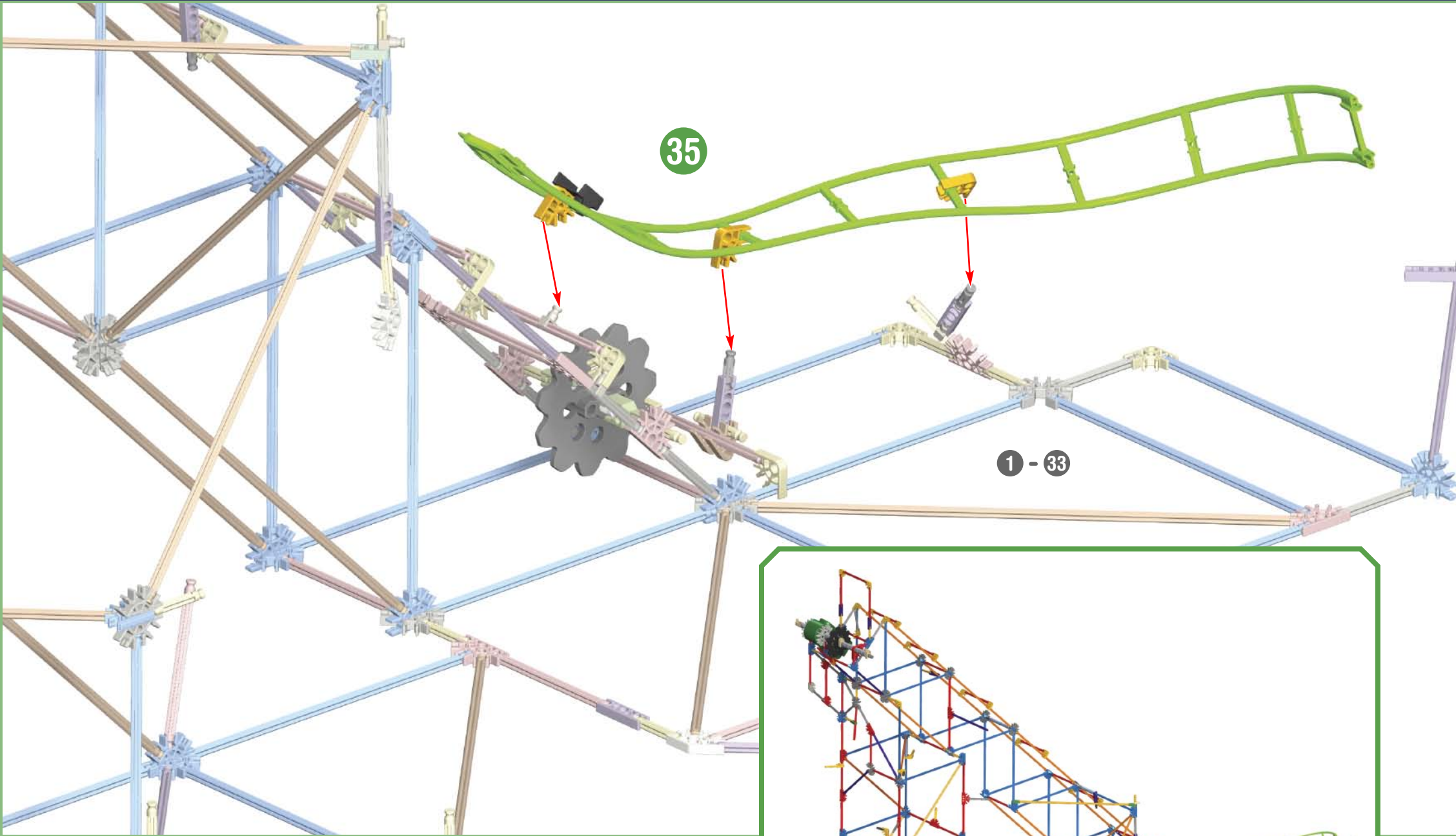
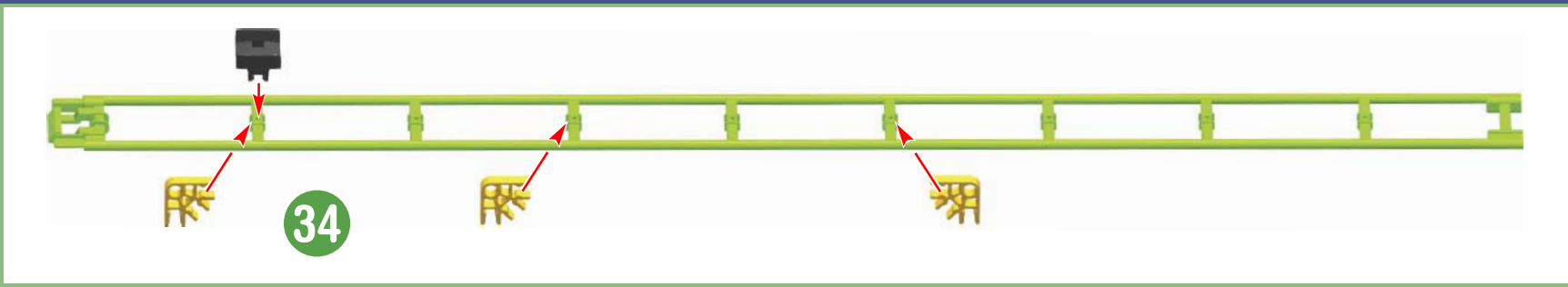

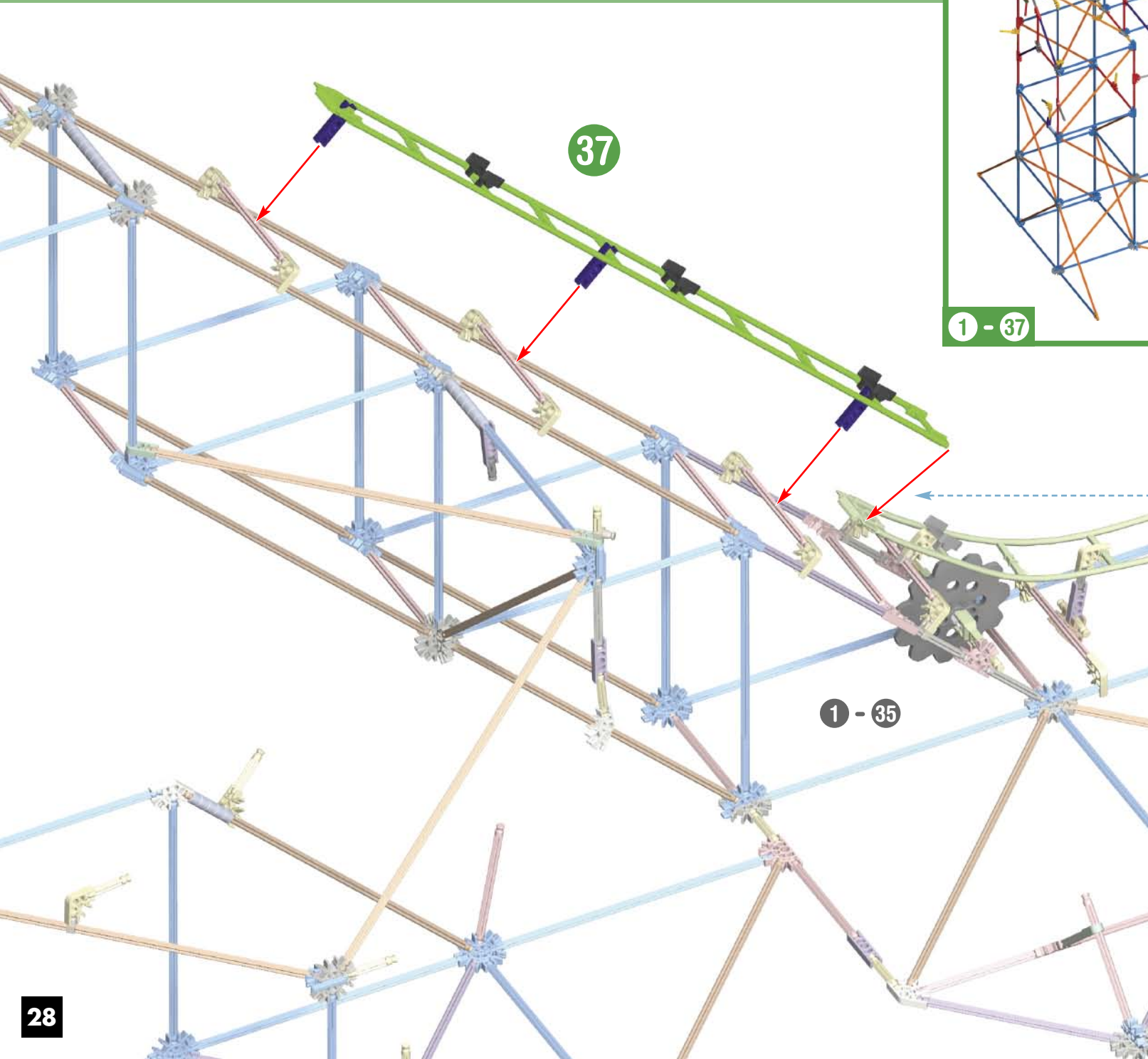
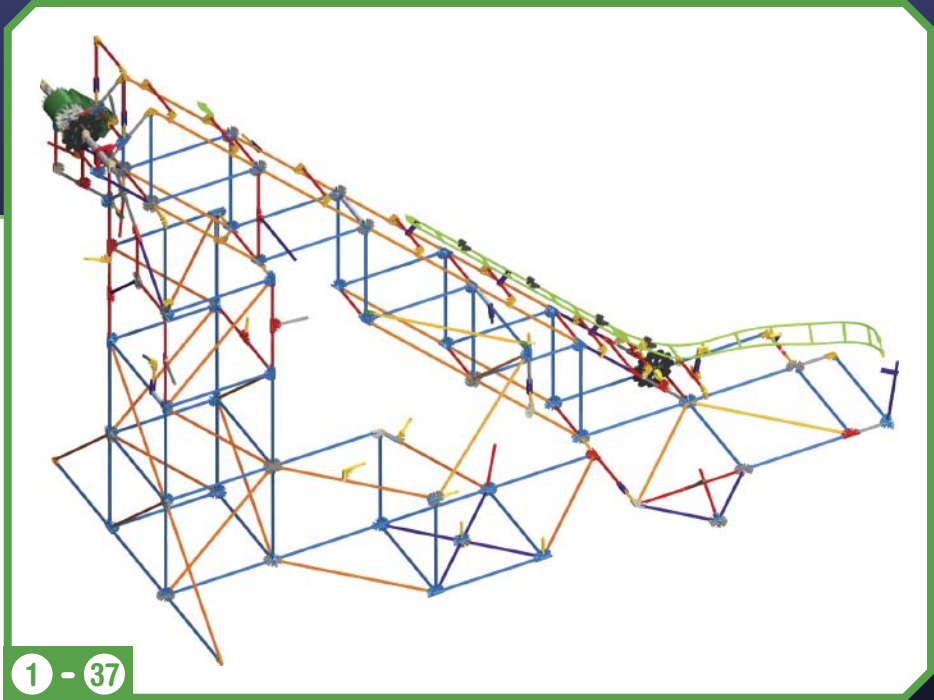
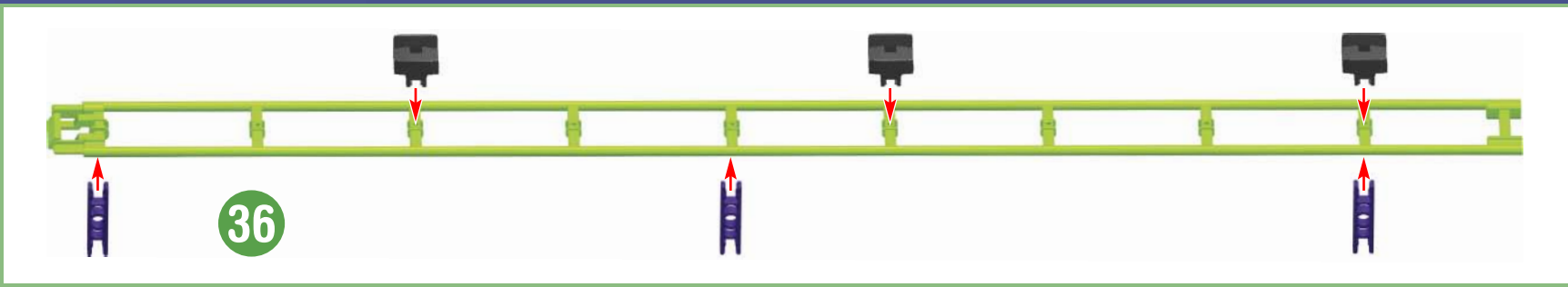

- (EN)** Always join this end of the track to the previous track piece first, then connect the rest of the track to the tower.
- (FR)** Connecte toujours le côté supérieur du circuit contre le côté supérieur tout au long de la construction.
- (ES)** Al construir, conecta siempre la pista de lado superior a lado superior.
- (DE)** Die einzelnen Schienenstücke müssen immer mit der Oberseite nach oben zeigen, wenn sie miteinander verbunden werden.
- (IT)** Collega sempre la rotaia parte superiore a parte superiore in tutta la costruzione.
- (PT)** Liga sempre a face superior da pista à face superior durante a montagem.
- (NL)** Maak steeds de bovenkant van het spoor vast aan de bovenkant tijdens de opbouw.



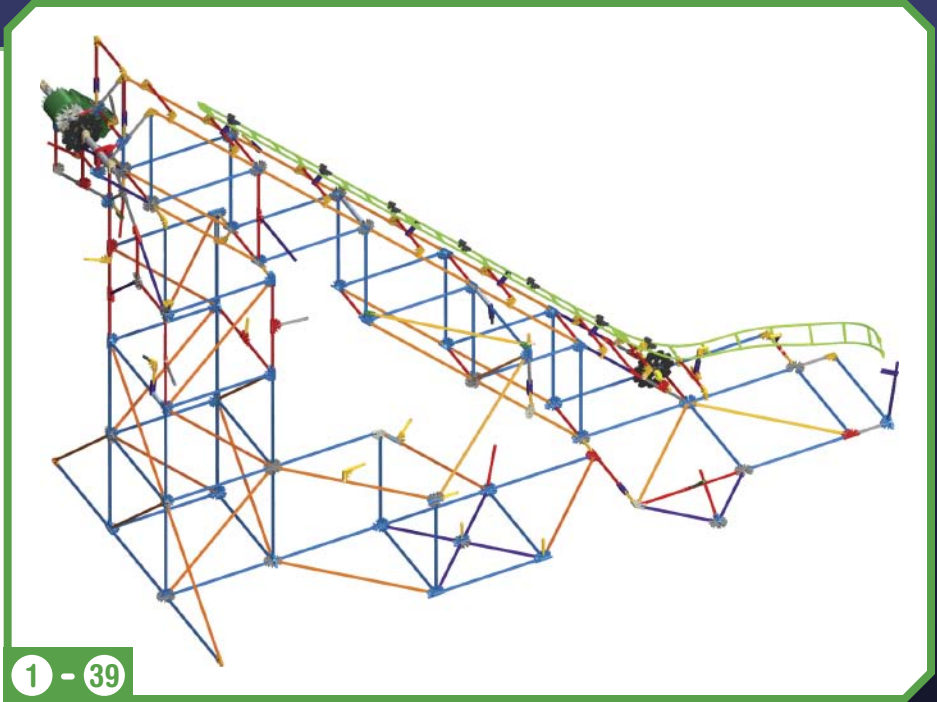
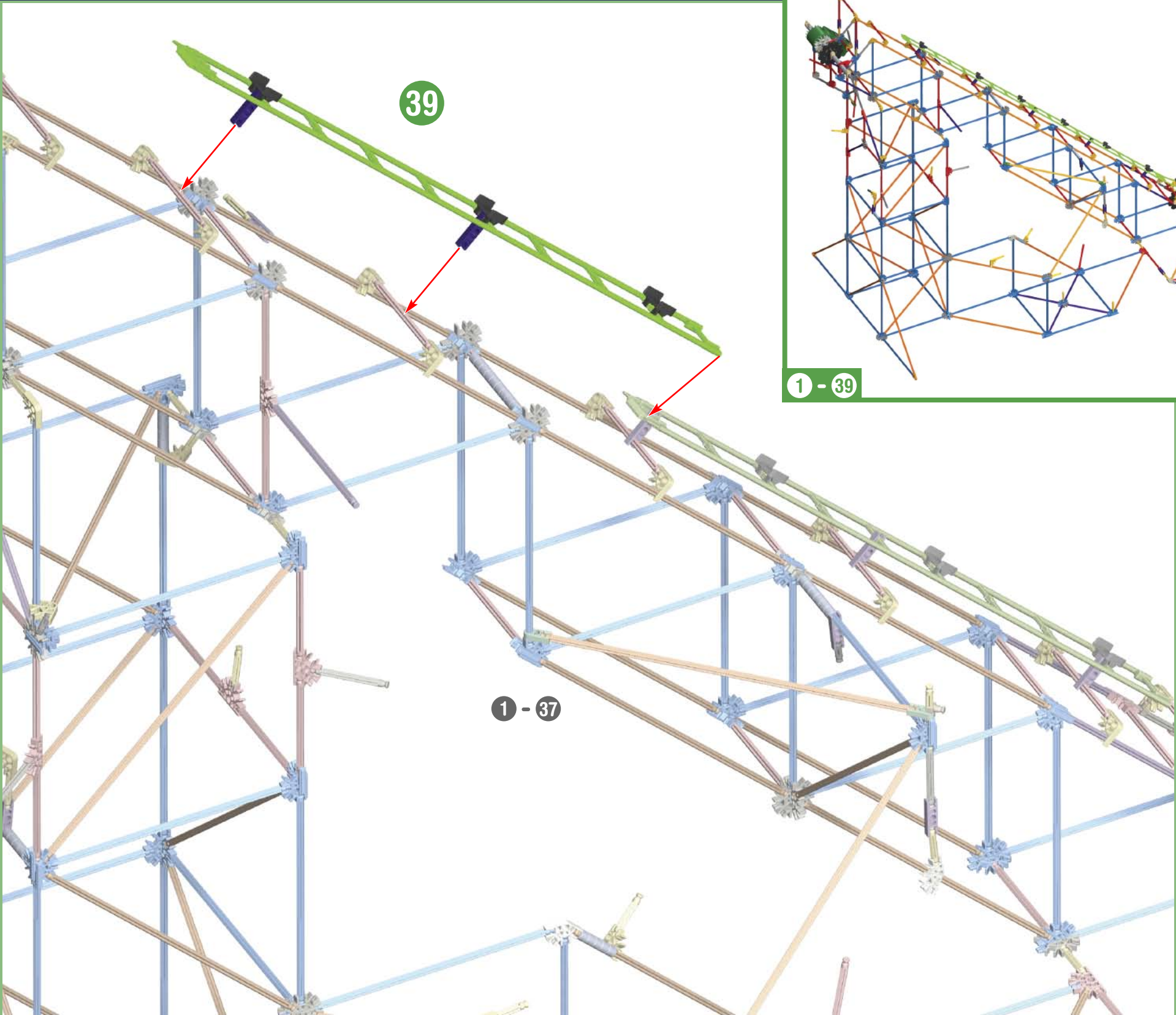
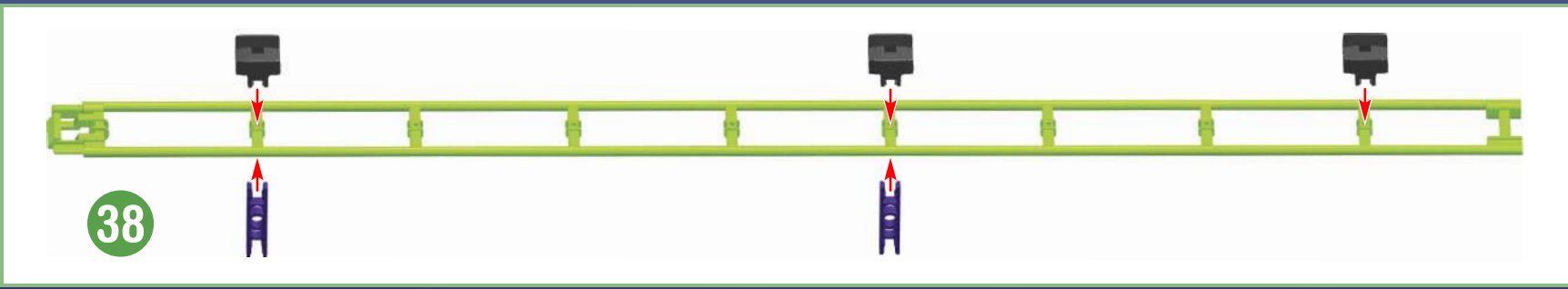

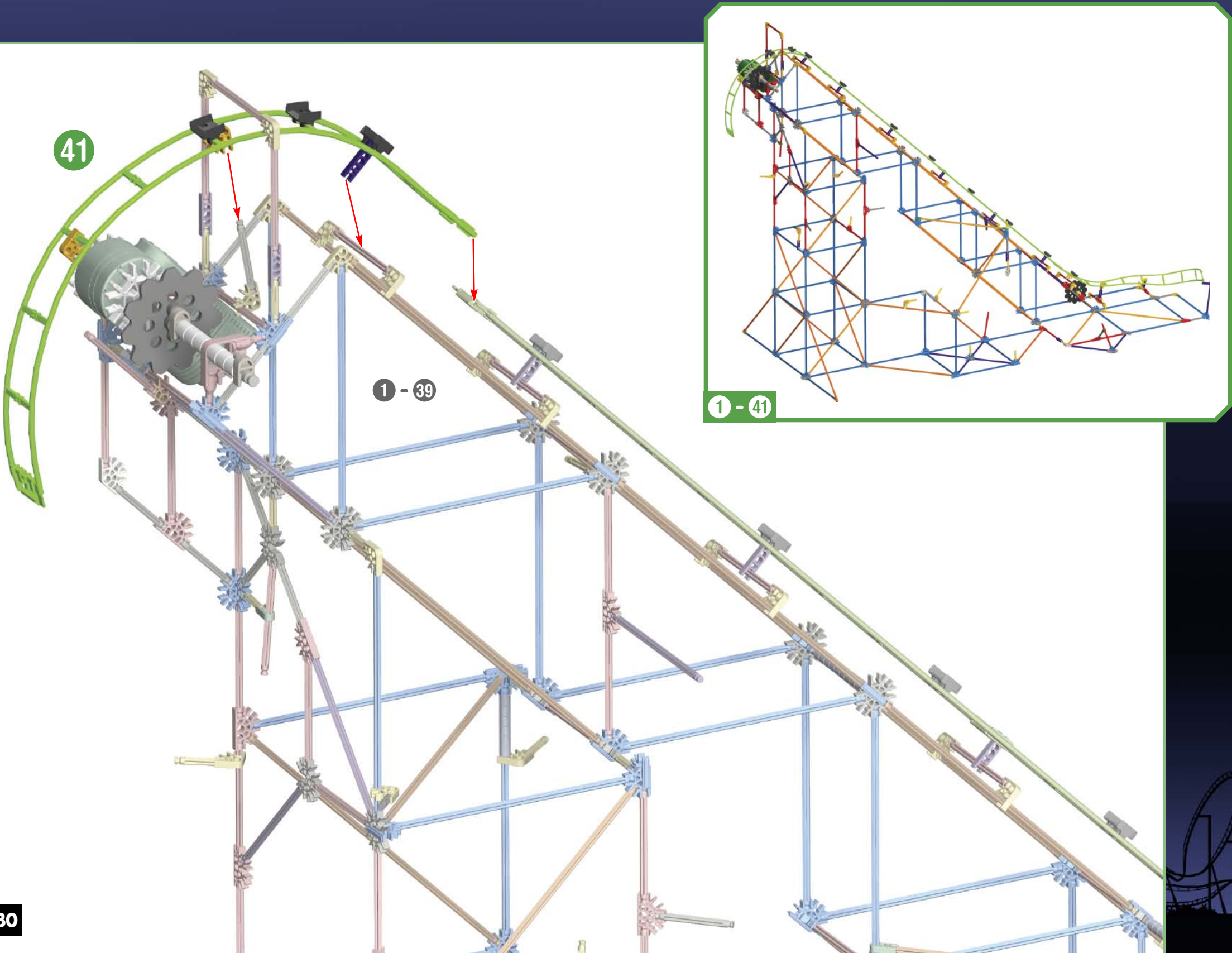
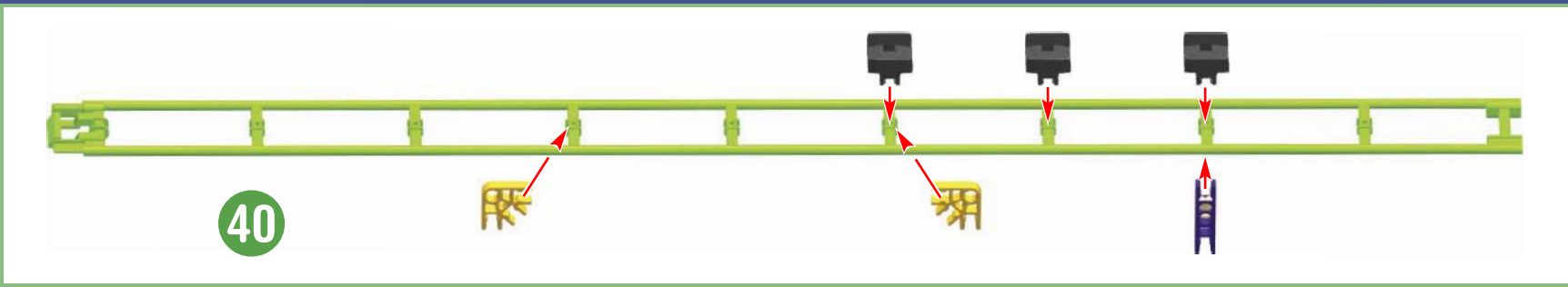



42

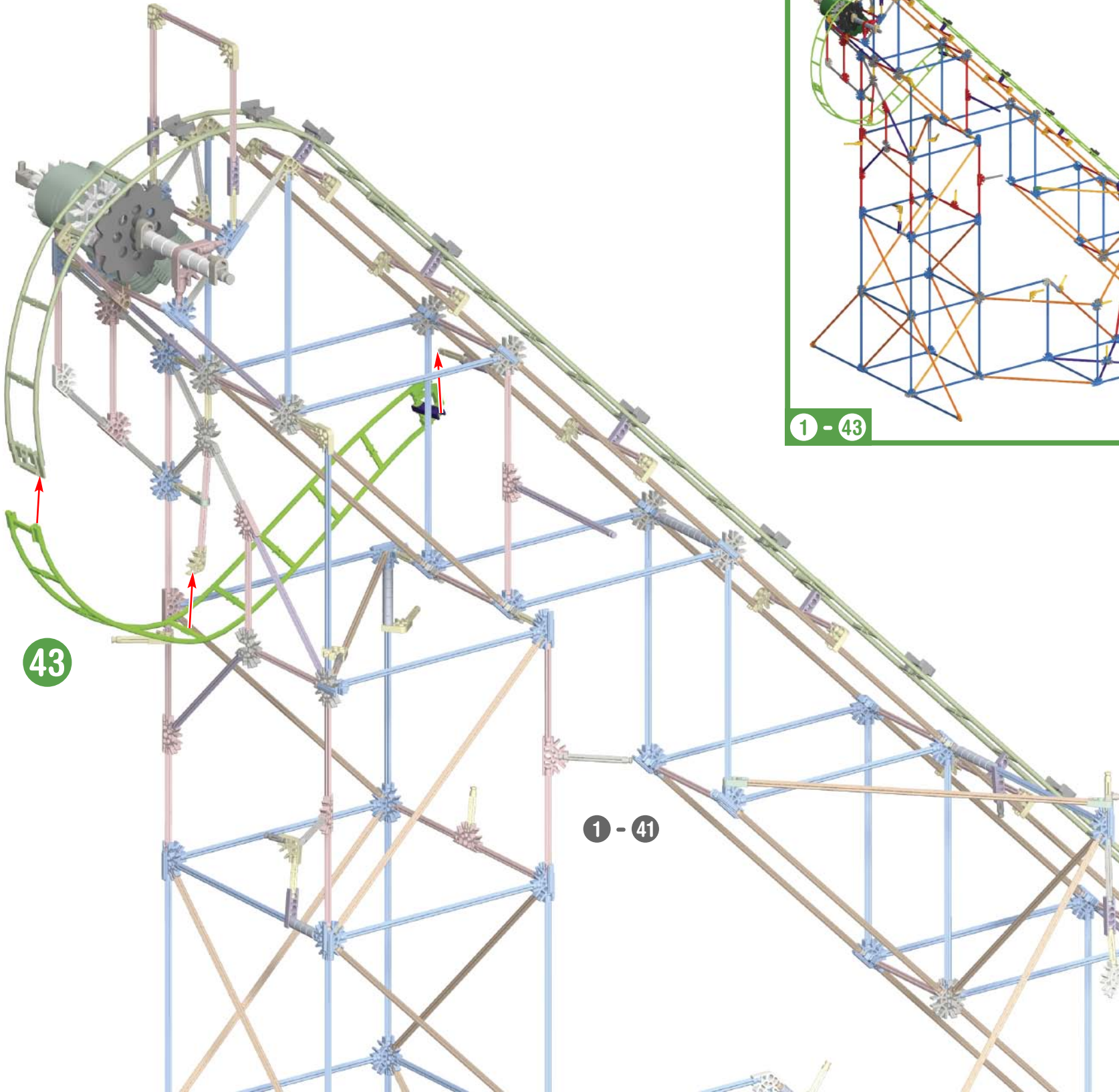

43

1 - 41

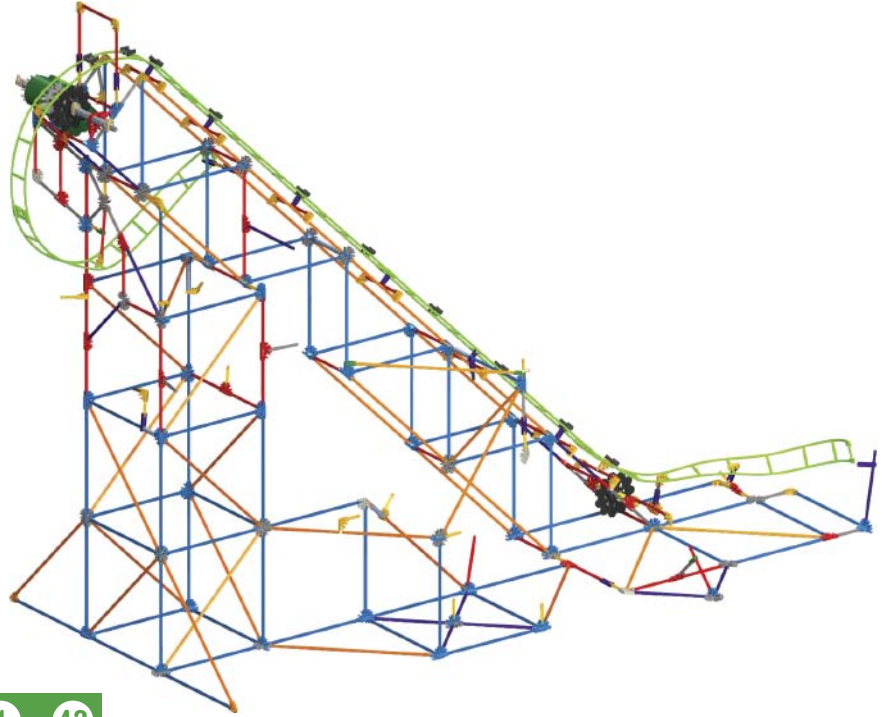

1 - 43



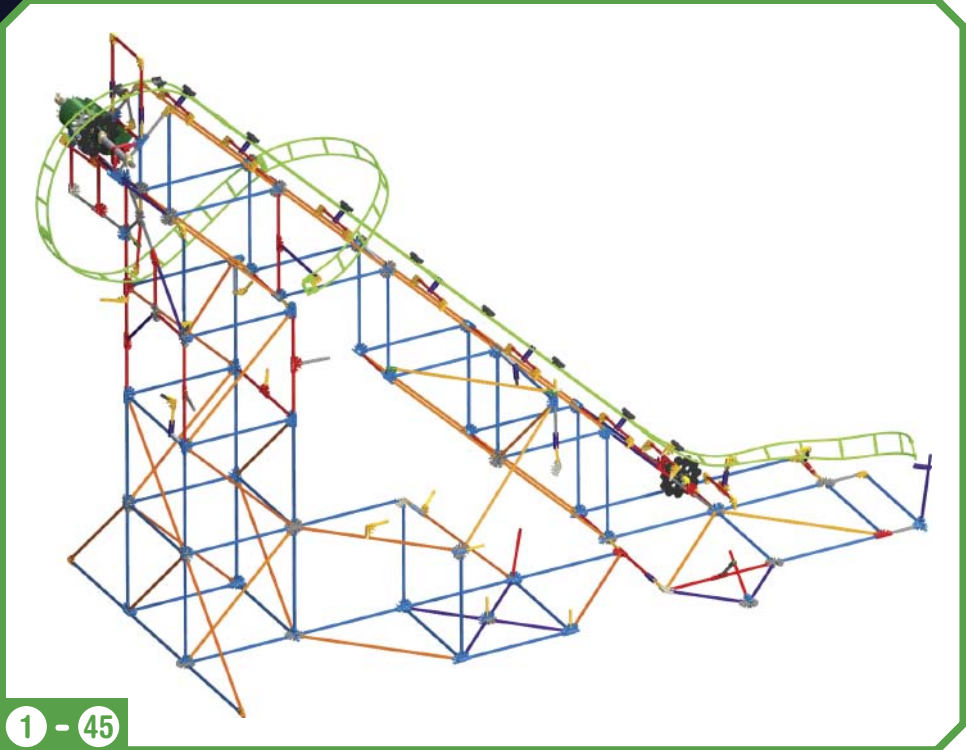
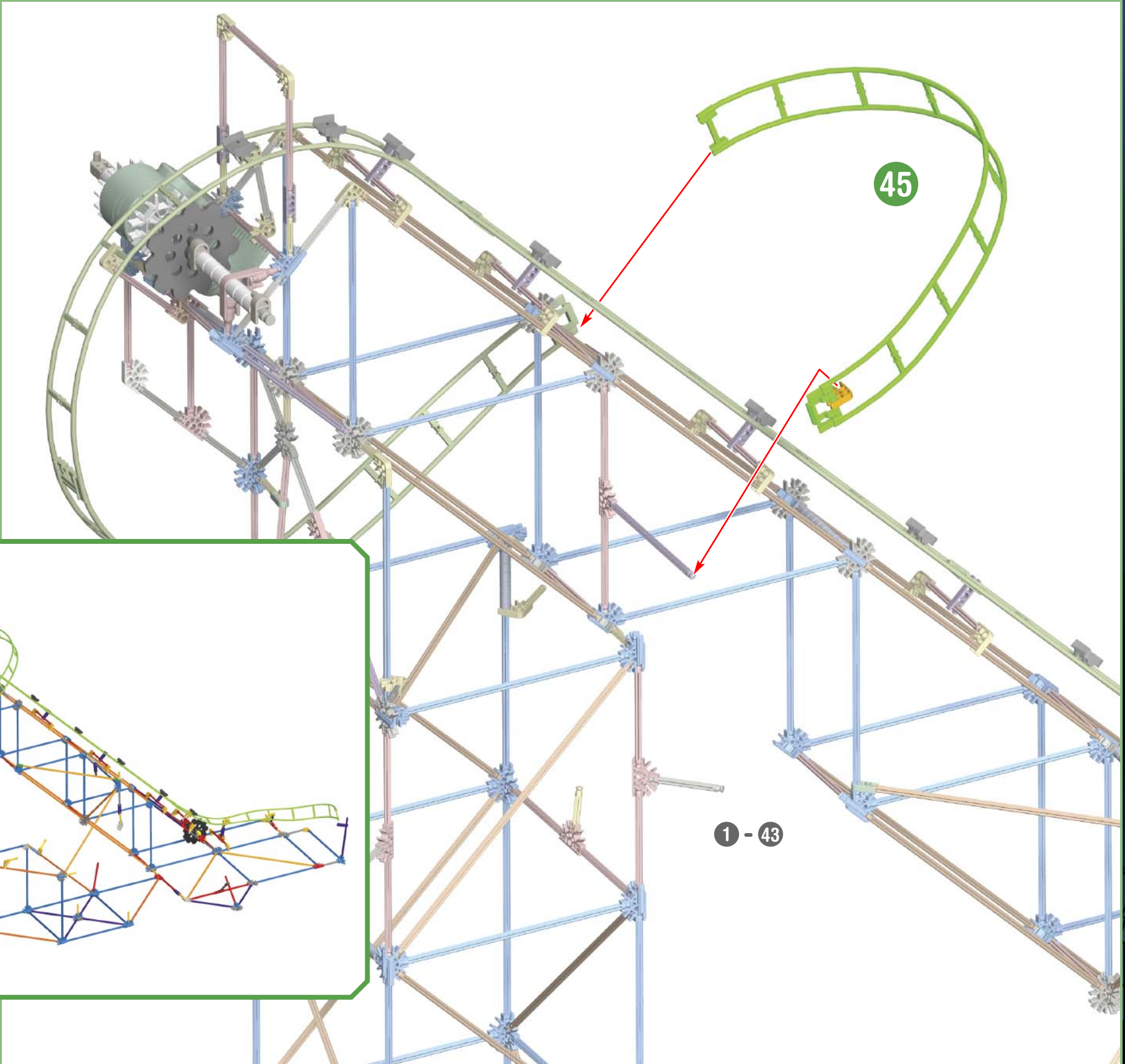
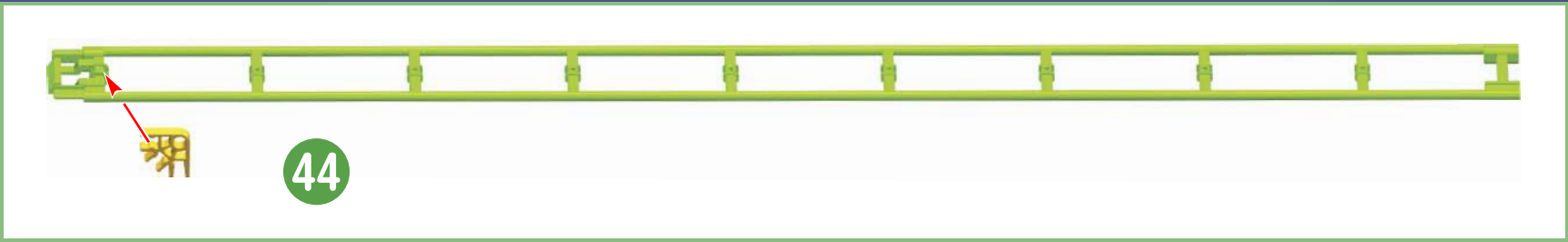

1 - 43

1 - 45

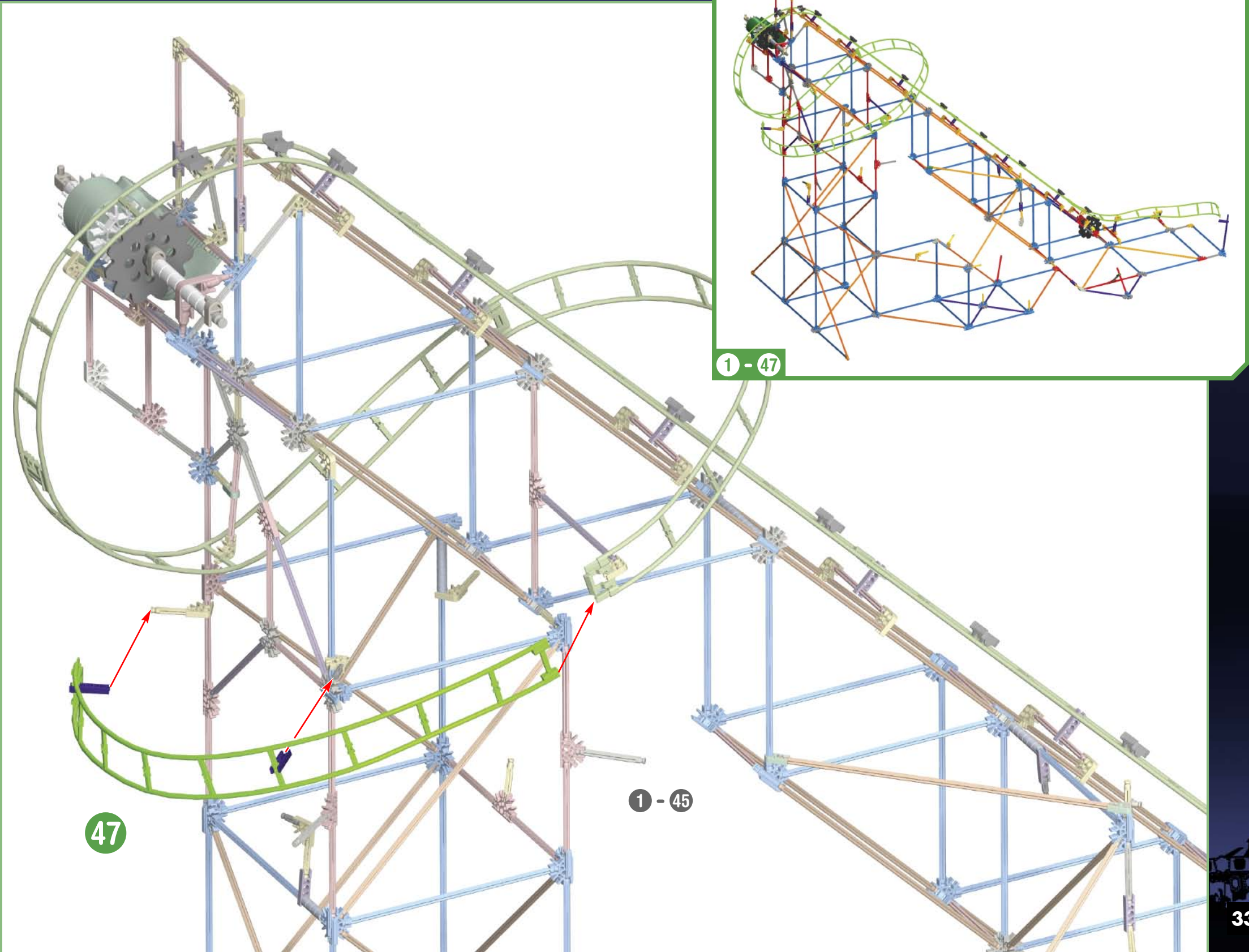
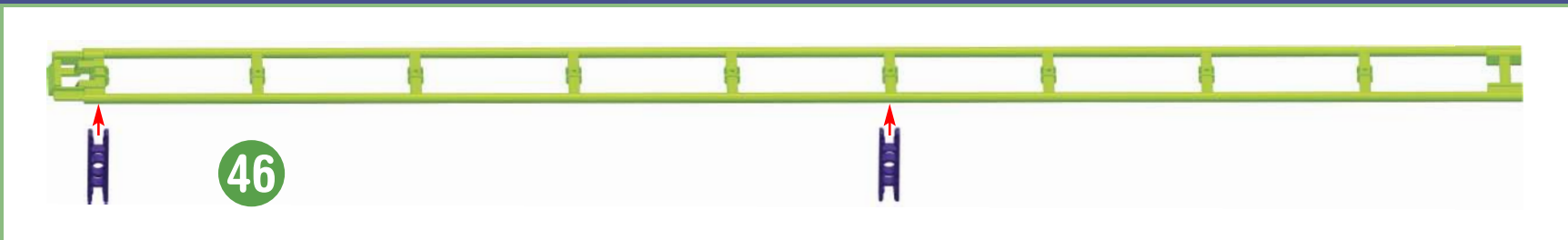

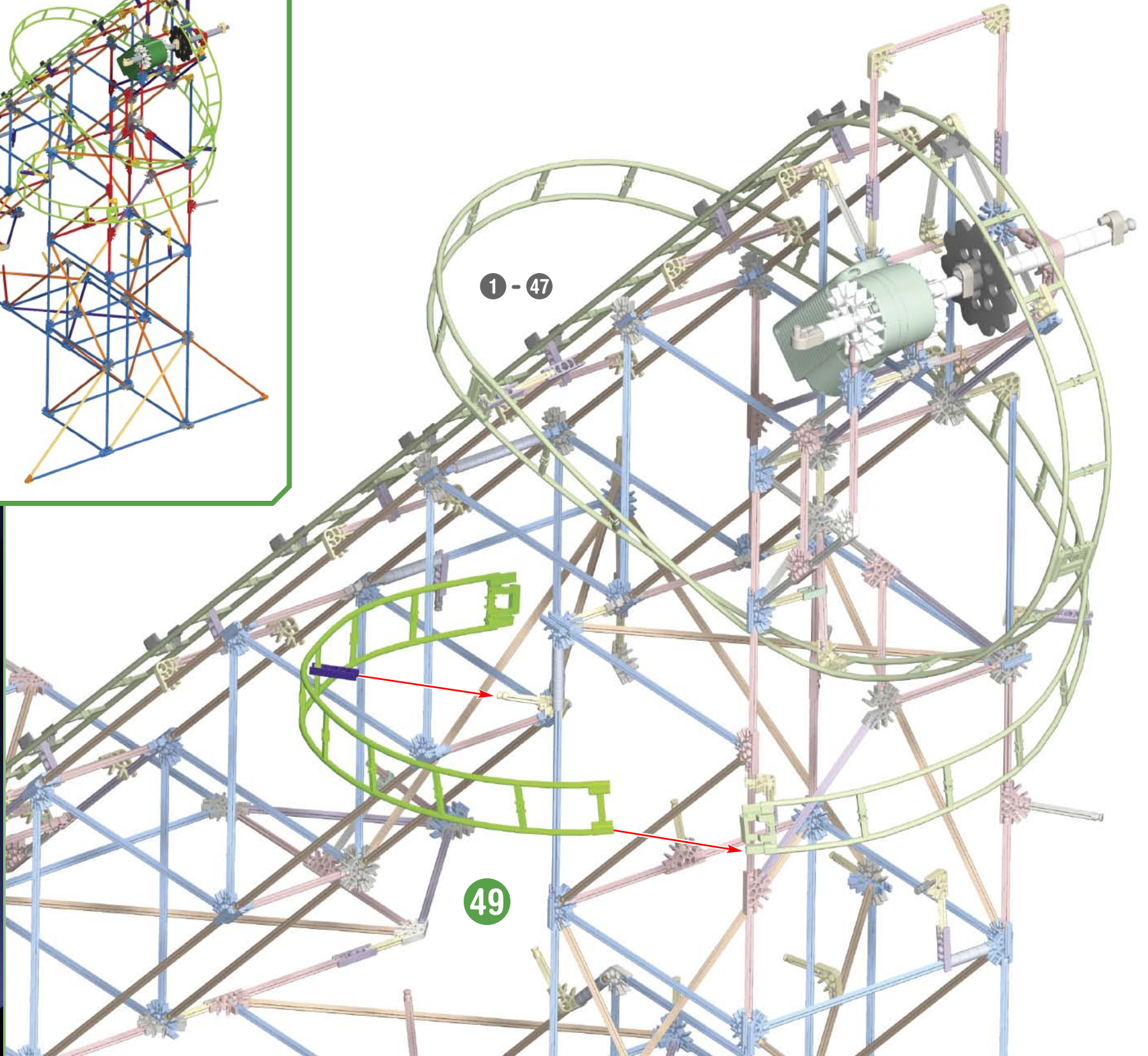
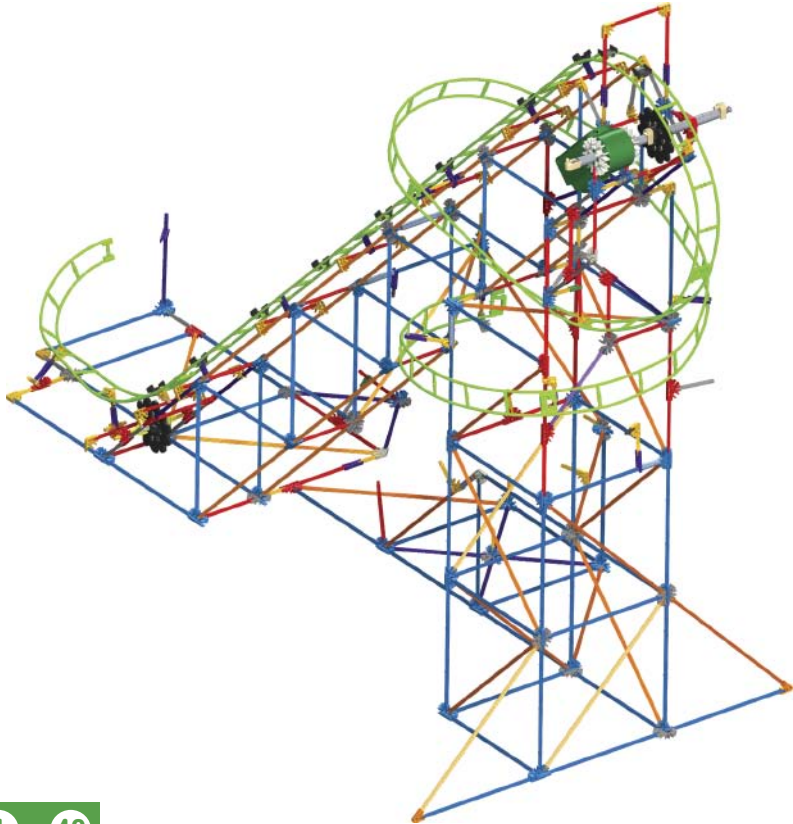



50

1 - 49

51

1 - 51

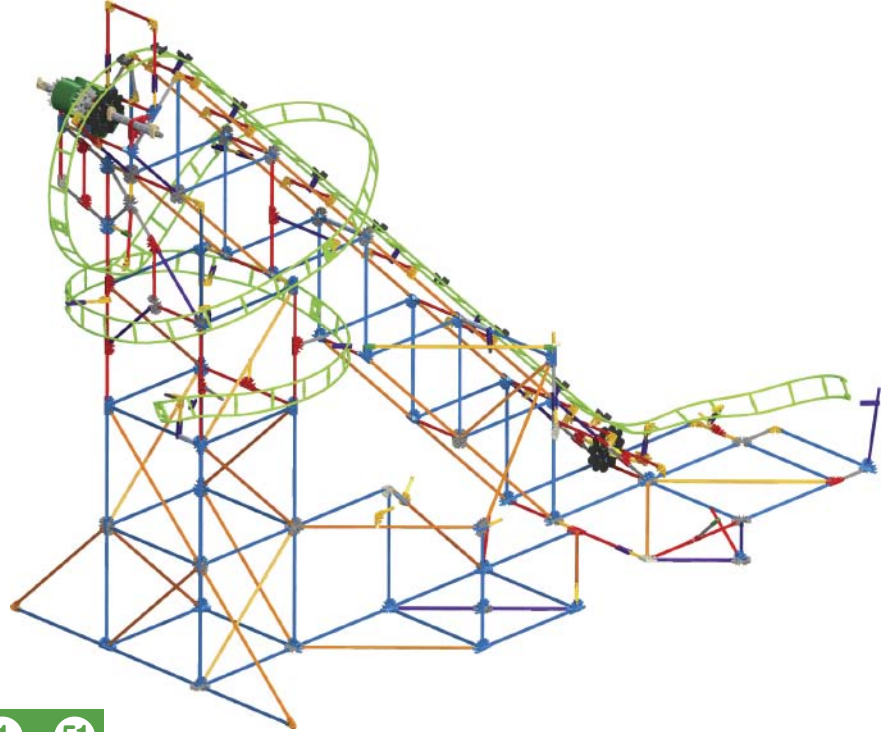

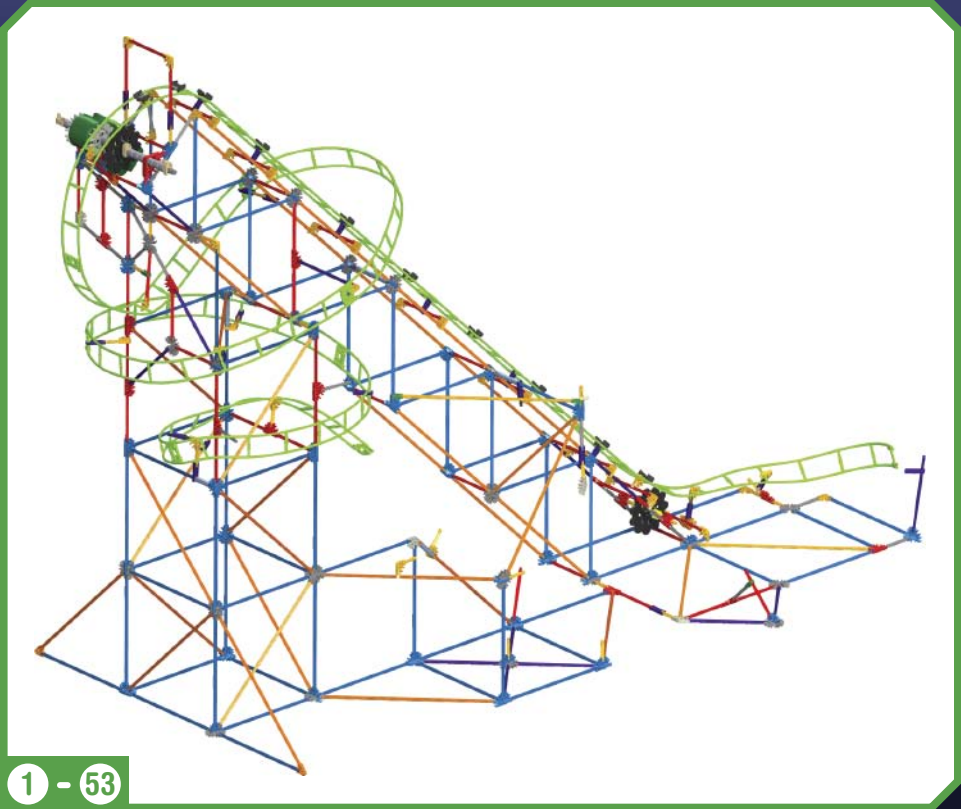
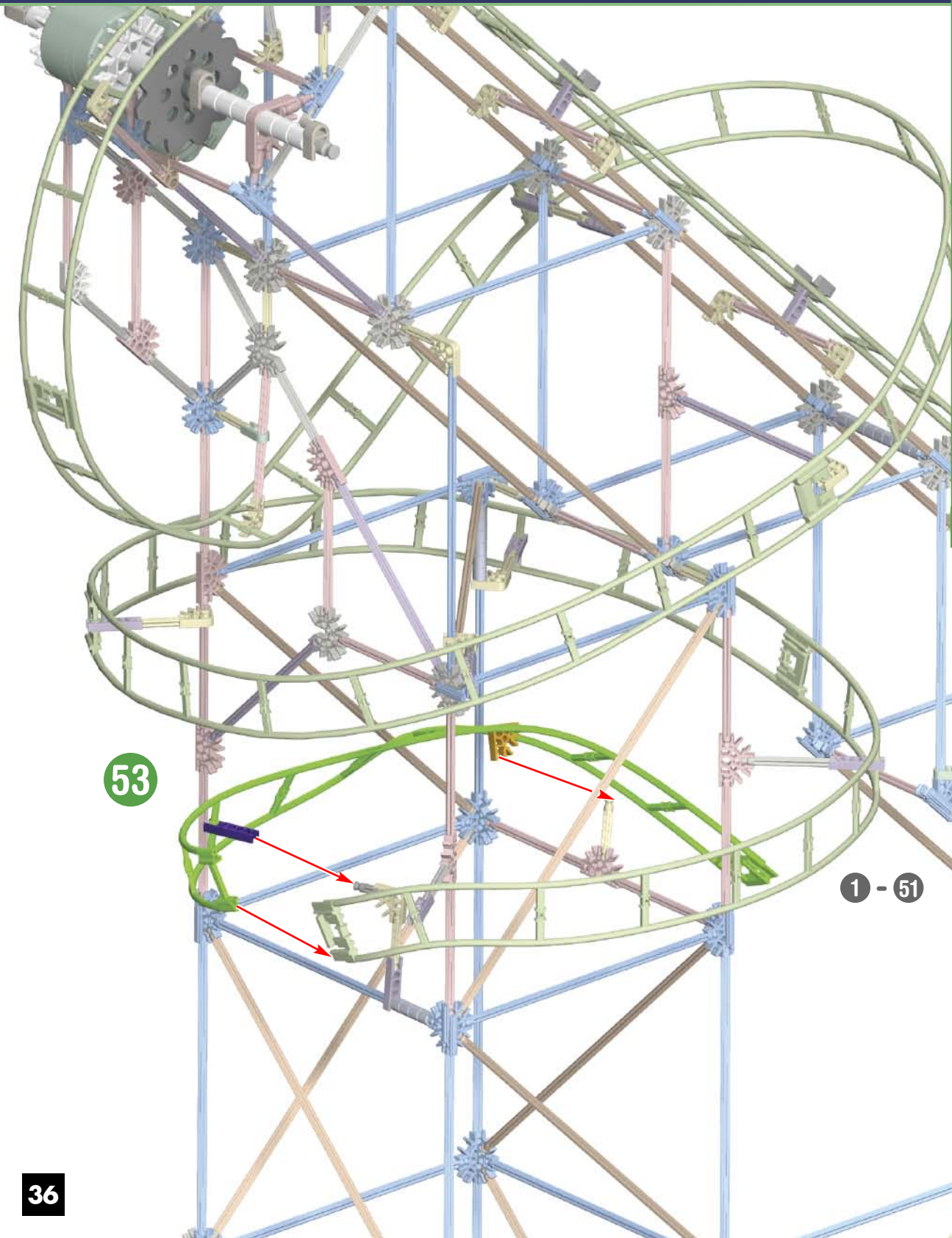
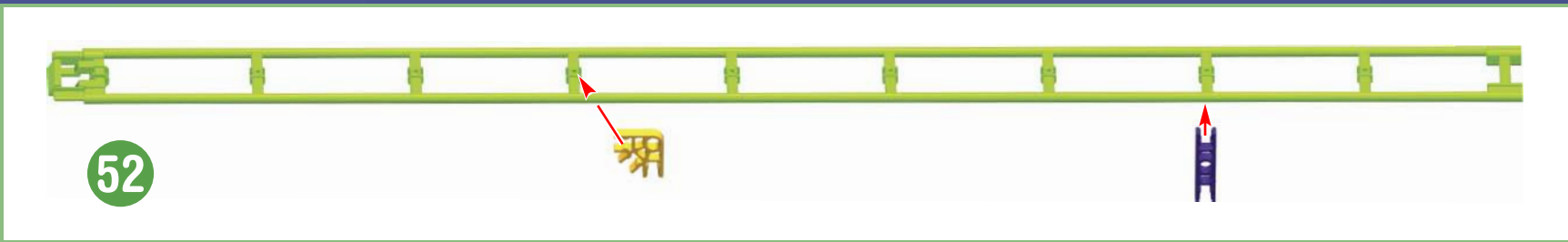

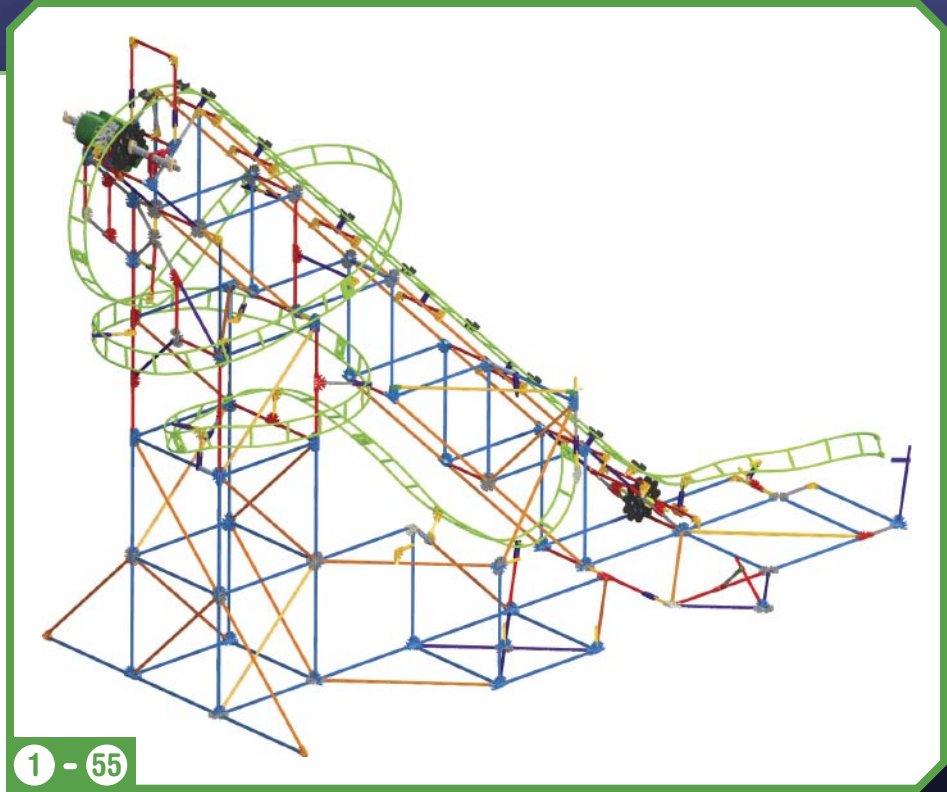
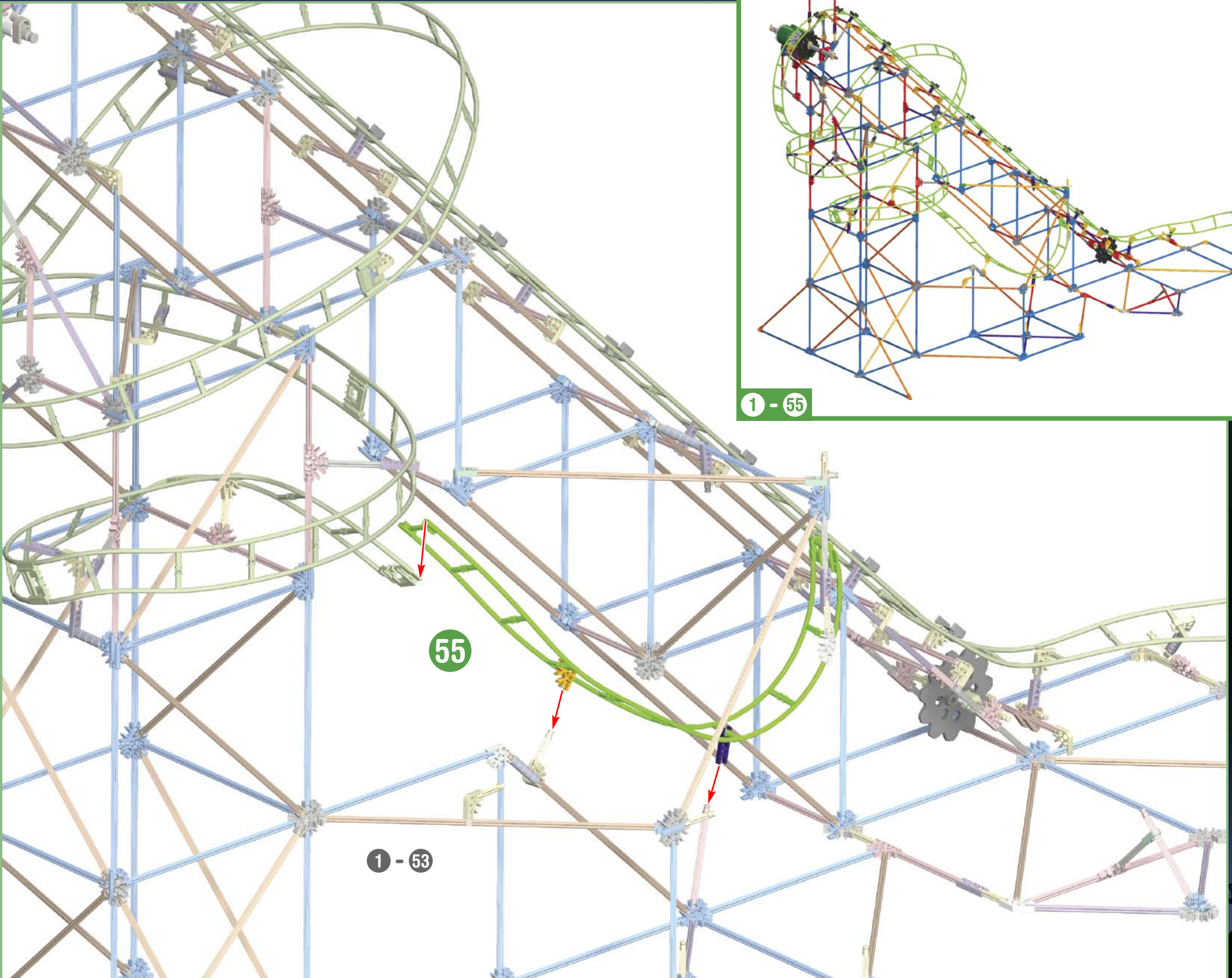

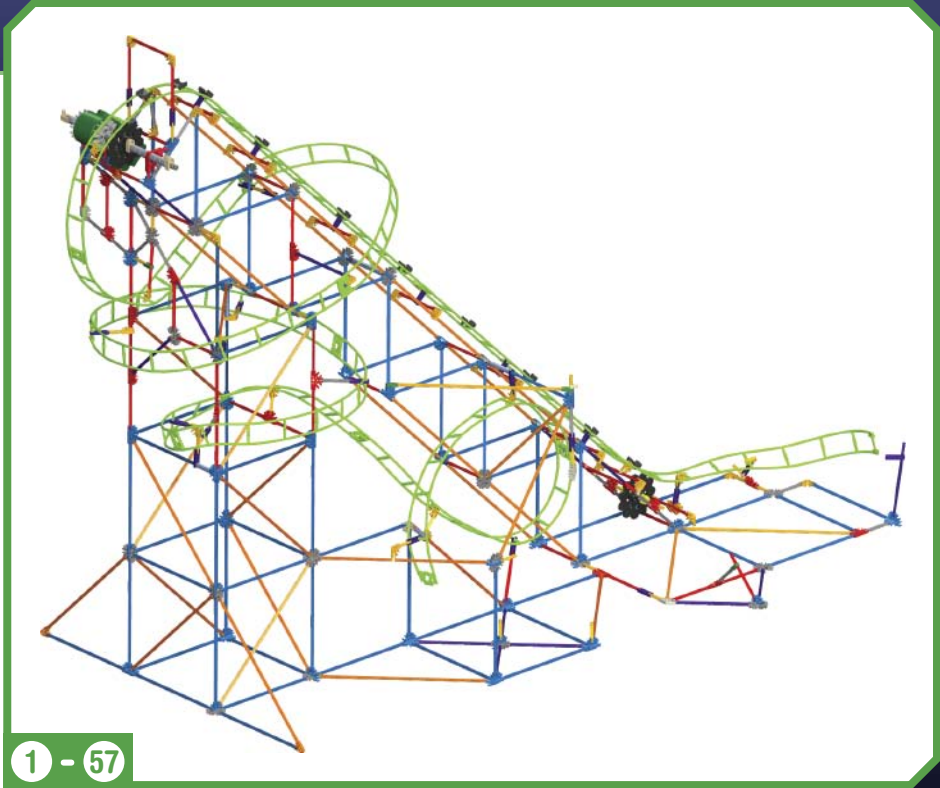
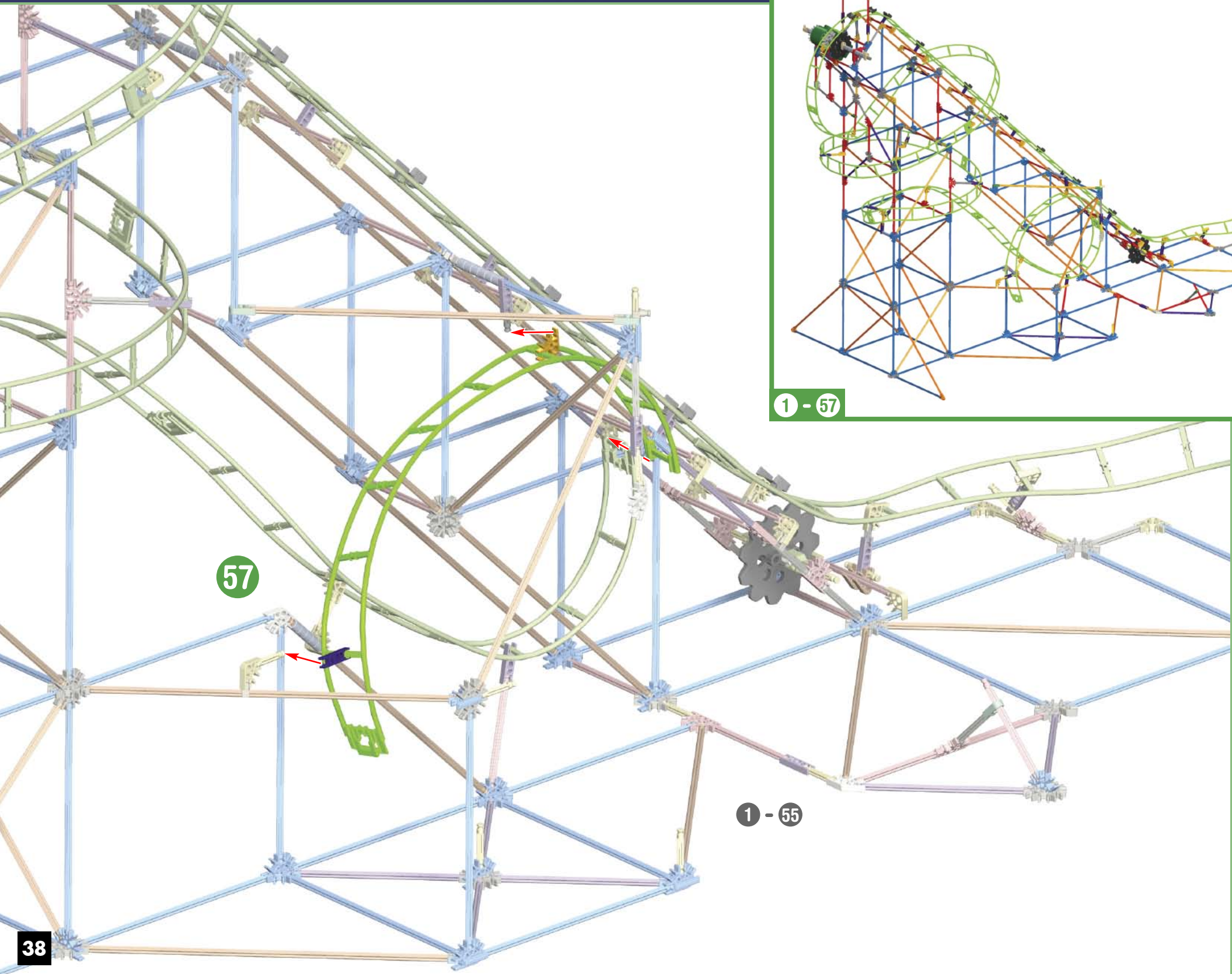

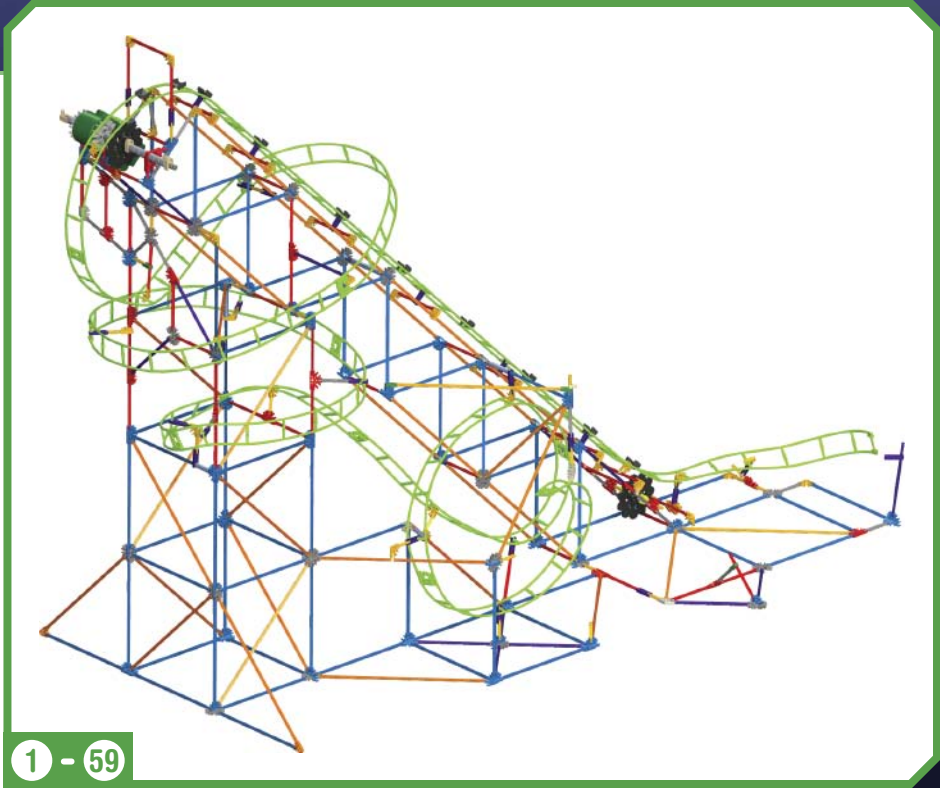
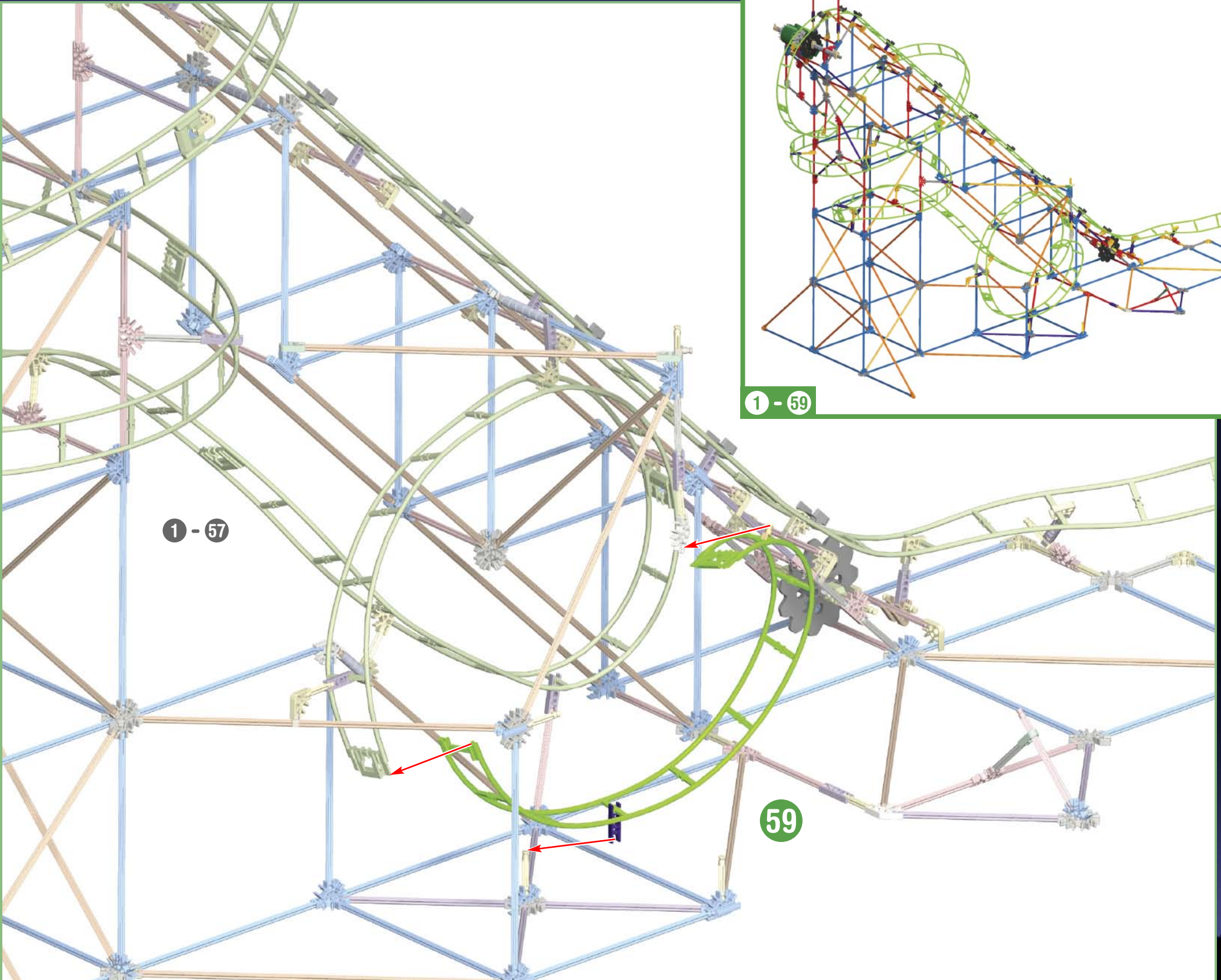

59



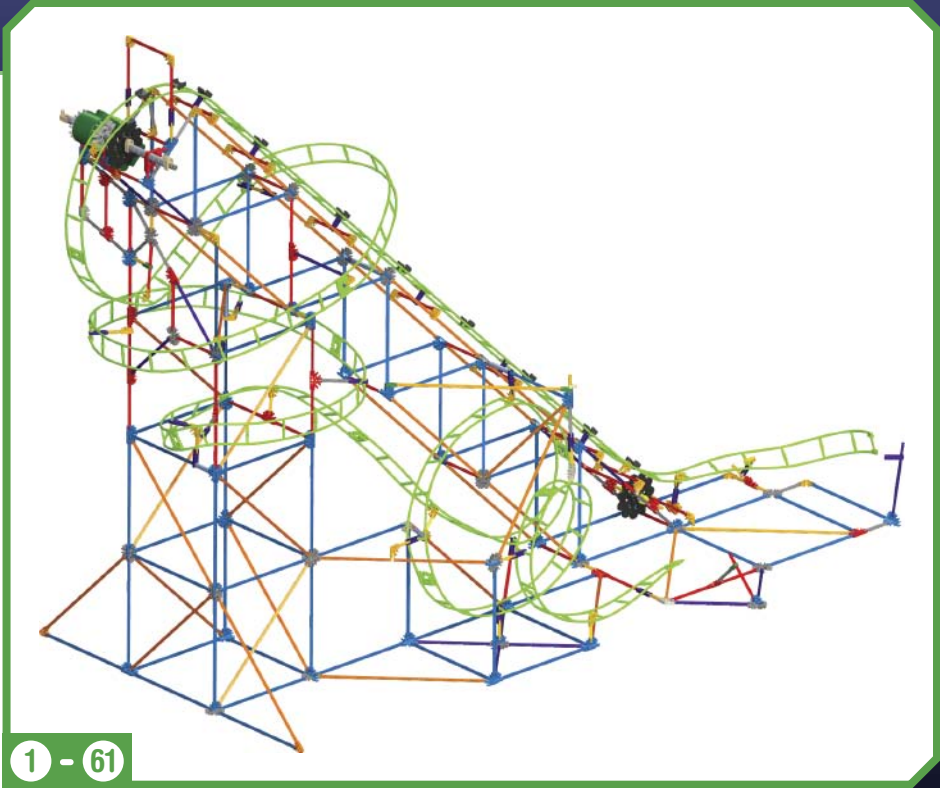
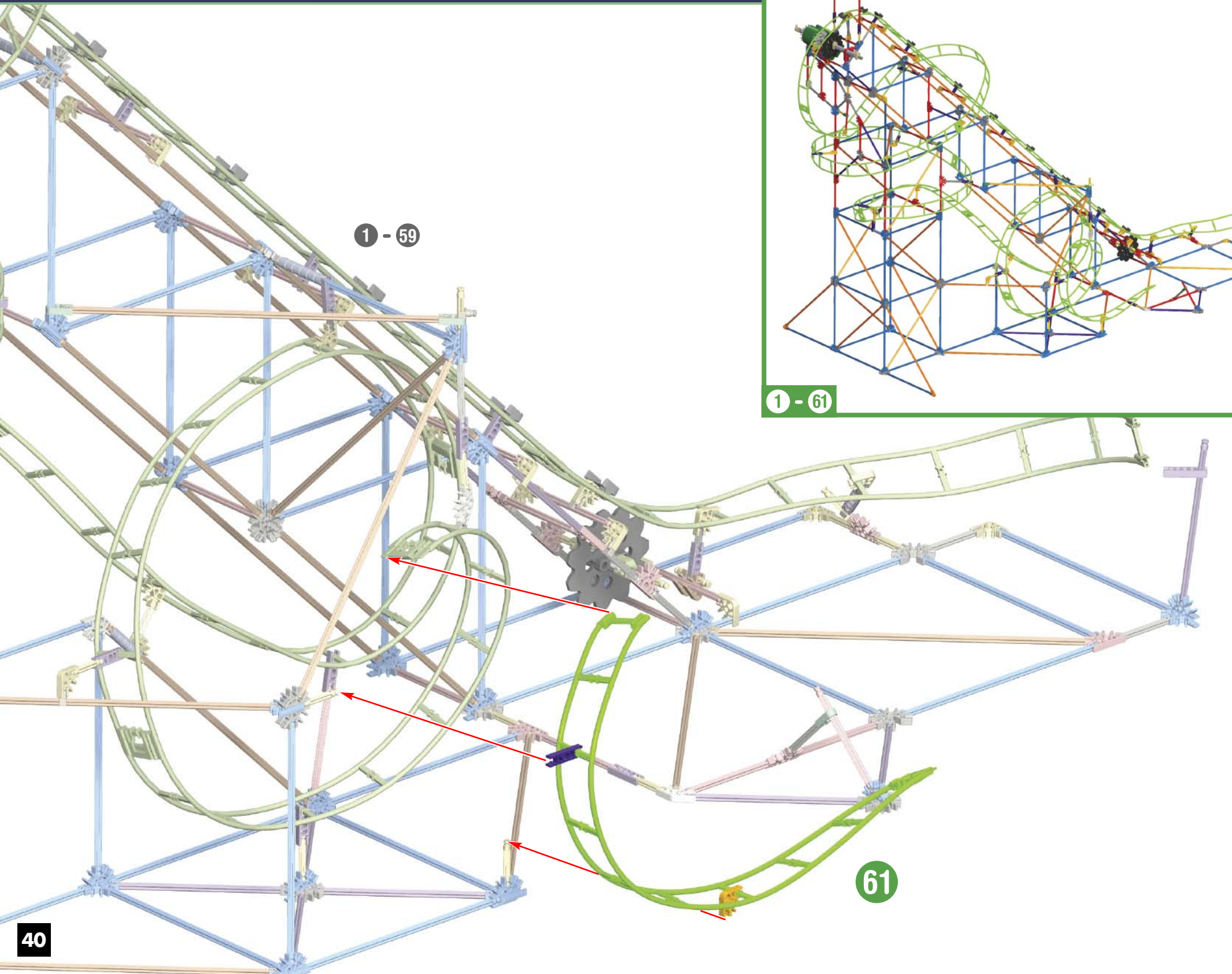

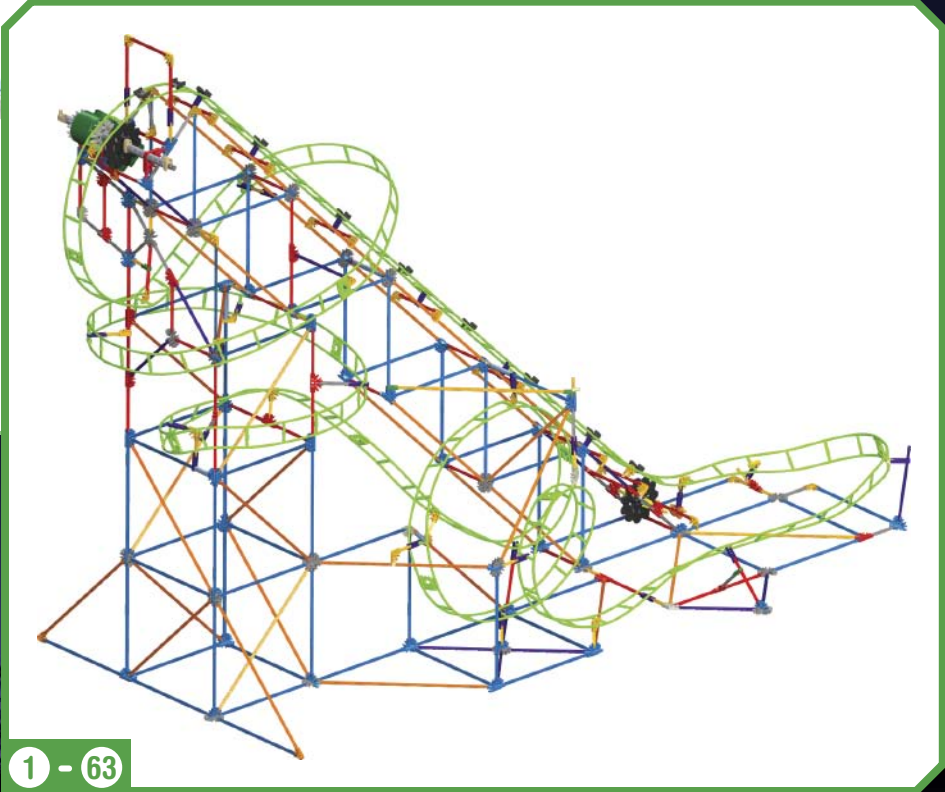
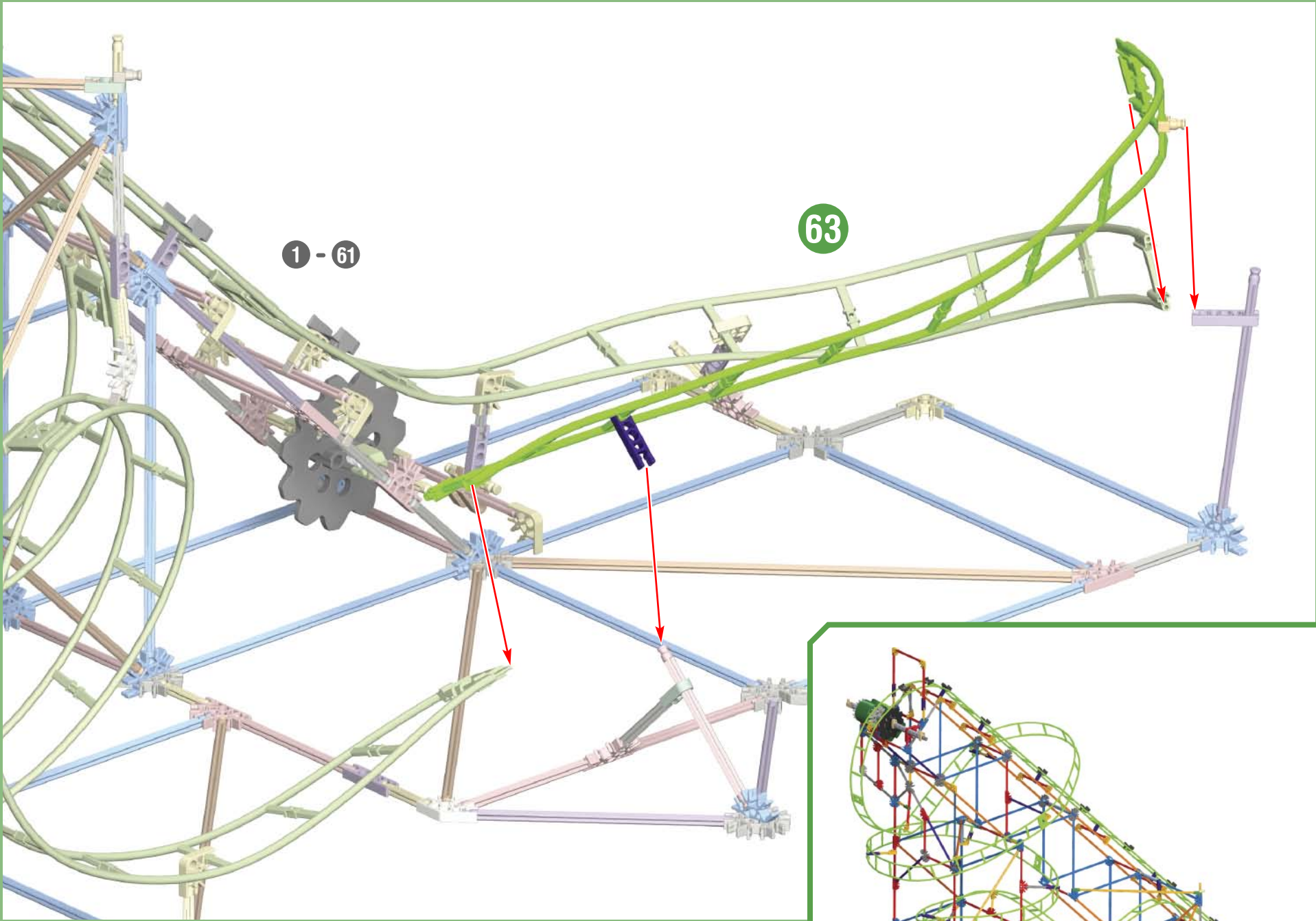



EN IMPORTANT: Attach all the chain links in the same direction.

FR IMPORTANT : Attache les chaînons dans le même sens.

ES IMPORTANTE: Conecta los Eslabones de la Cadena en la misma dirección.

DE WICHTIG: Befestige die Kettenglieder immer in die gleiche Richtung.

IT IMPORTANTE: Collegare le maglie della catena nella stessa direzione.

PT IMPORTANTE: Prende os Elos da Corrente seguindo a mesma direcção.

NL BELANGRIJK: Maak de ketenschakels vast in dexelfde richting.



x4



64

x1



x10



65

x16

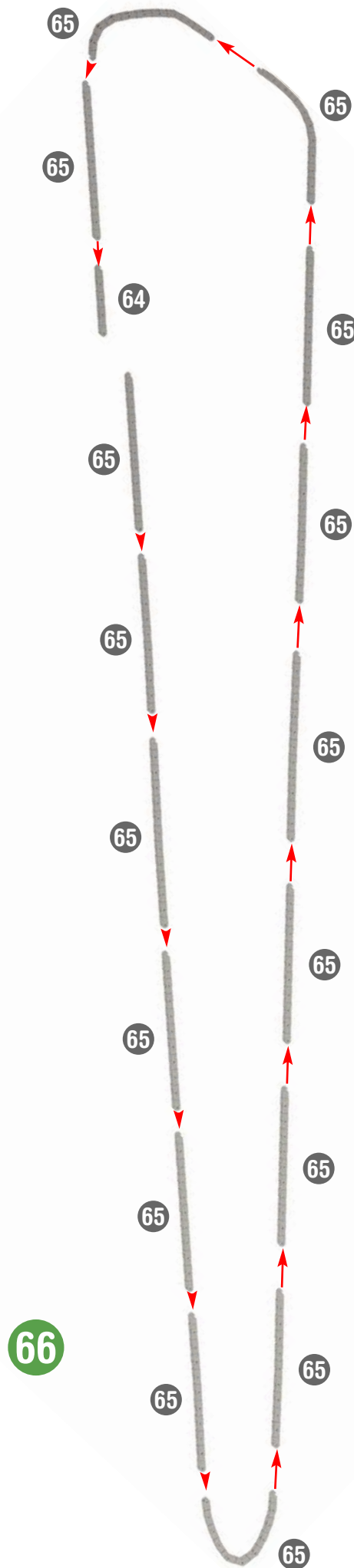

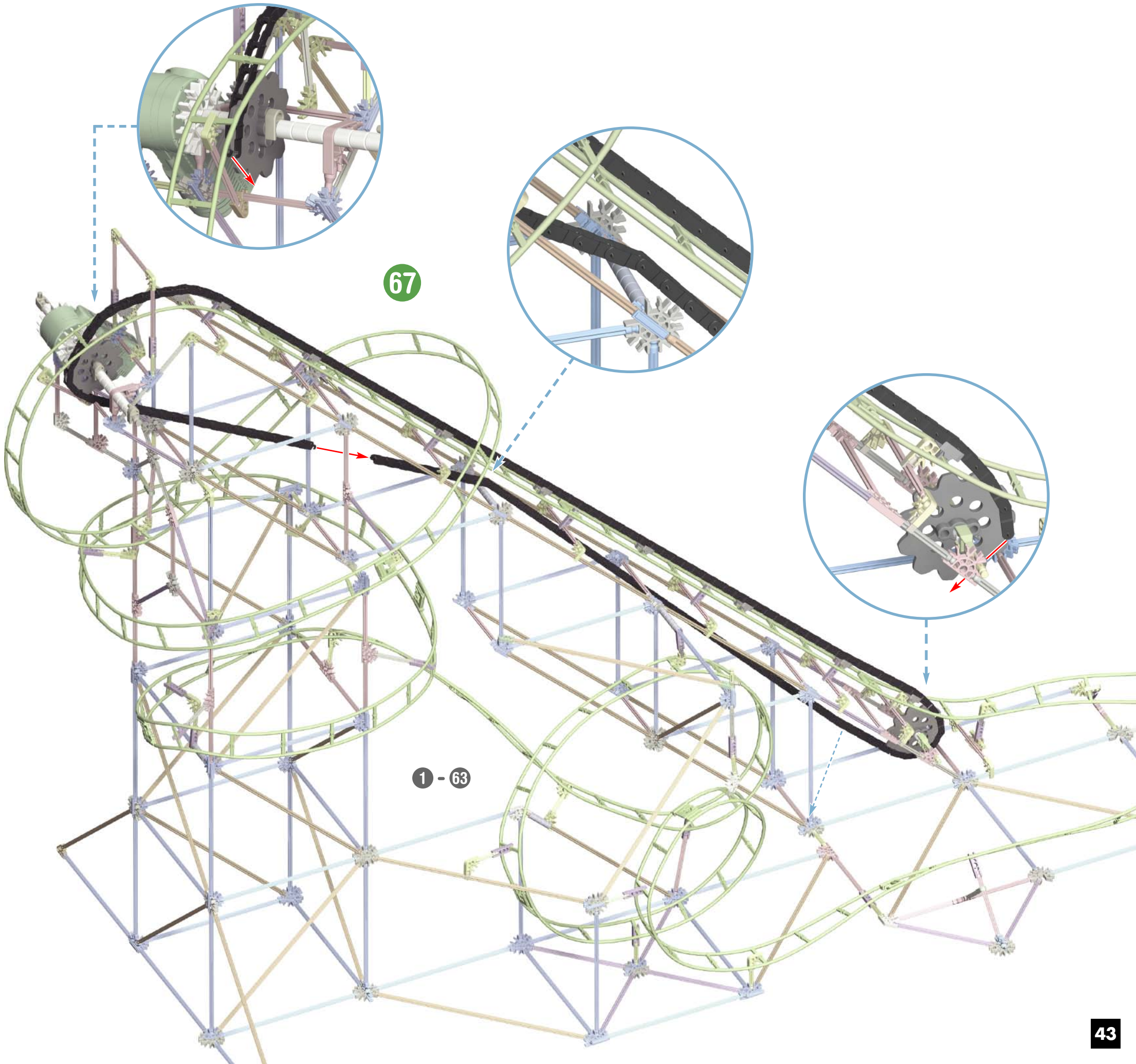

67

1 - 63

Ⓔ To attach the car, undo a piece of track and then thread the car wheels over the top side of the track. Then join the track pieces together. If the car gets stuck on the way down, make sure it is not hitting any K'NEX parts.

Ⓕ Pour fixer les voiture, défais un tronçon du circuit, puis fais passer les roues de la voiture par-dessus le côté supérieur du circuit. Assemble ensuite les tronçons du circuit. Si des voiture restent coincées au cours de la descente, vérifie que la voiture ne heurte pas des pièces K'NEX.

68

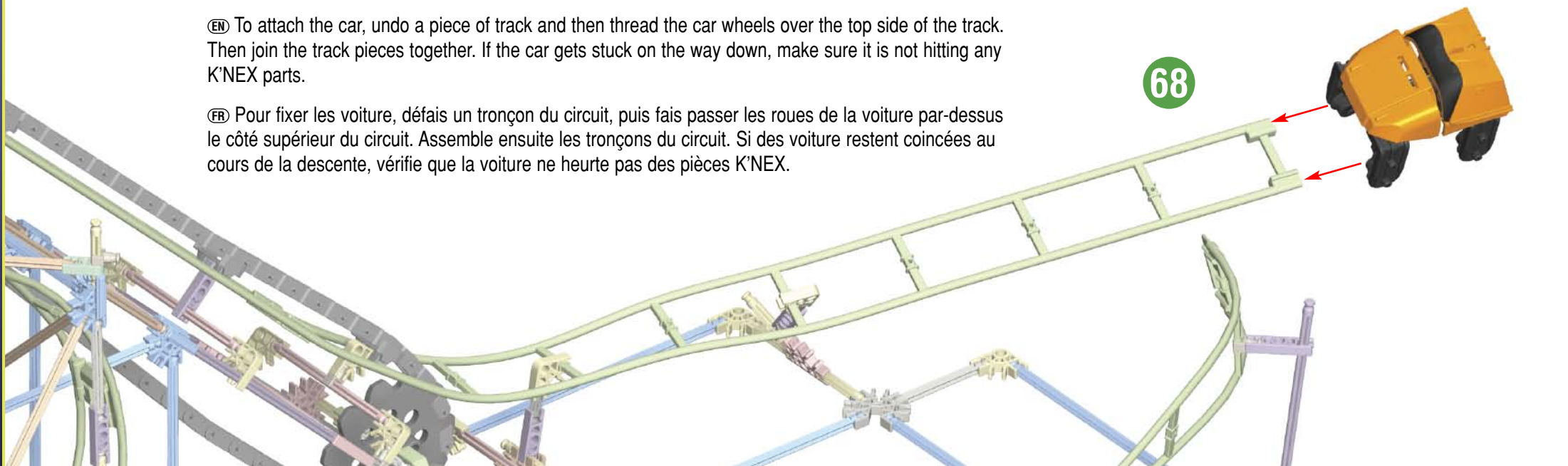

Ⓔ TIPS & TROUBLESHOOTING

If the motor is not working properly:

- Check to see if you have fresh batteries and that they are installed correctly.
- If it is still not working, call our Consumer Hotline at 1-800-KID-KNEX (USA and Canada only). See the back cover for other ways to contact K'NEX.

If a car gets stuck on the track:

- Is the model built correctly?
- Make sure the cars are not hitting any K'NEX parts.
- Are the track pieces connected properly?
- Are the cars attached to the track correctly?
- Adjust the track to eliminate any flat or little bumpy spots on the track.

Ⓕ CONSEILS & DÉPANNAGE

Si le moteur ou le module son ne marche pas :

- Vérifie que tu as des piles neuves et qu'elles sont installées correctement.
- Si ça ne marche toujours pas, appelle notre ligne d'assistance à la clientèle à 1-800-KID-KNEX (USA et Canada uniquement). Regarde au verso pour d'autres moyens de contacter K'NEX.

Si des voitures restent coincées au cours de la descente :

- Est-ce que le modèle est construit comme il faut ?
- Vérifie que la voiture ne heurte pas des pièces K'NEX.
- Est-ce que les pièces du circuit sont connectées comme il faut ?
- Est-ce que la voiture est fixée au circuit comme il faut ?
- Ajuste le circuit de façon à y éliminer des endroits plats.

Ⓔ Building Idea

Bonus instructions at
www.knex.com/thrill-rides

Ⓕ Idée de construction

Plans supplémentaires á
www.knex.com/thrill-rides

Ⓔ Idea para la construcción

Instrucciones de la prima en
www.knex.com/thrill-rides

Ⓔ Bauvorschlag

Zusätzliche Bauanleitungen bei
www.knex.com/thrill-rides

Ⓕ Idea di costruzione

Bonus Istruzioni a
www.knex.com/thrill-rides

Ⓕ Ideia de construção

Instruções do bônus em
www.knex.com/thrill-rides

Ⓕ Idee voor bouwen

De instructies van de bonus bij
www.knex.com/thrill-rides

PANTHER PEAK™



Informations importantes pour les parents et les enfants

Garde ces instructions à portée de la main. Elles comportent d'importantes informations de sécurité.

Lis tous les avertissements et les instructions avant de commencer le montage et l'exploitation du modèle.

⚠ AVERTISSEMENT : DANGER D'ÉTOUFFEMENT - Petites pièces.
Ne convient pas aux enfants de moins de 3 ans.

ATTENTION : Garde les cheveux, les doigts, la figure et les vêtements à l'écart de toutes les pièces mobiles.

ATTENTION : Faire attention de ne pas renverser le modèle. Le modèle devrait être placé sur une surface plate et dure.

- Partage l'expérience K'NEX avec ton enfant et fais du montage K'NEX un agréable projet de famille.
- Prends ton temps lors du montage. Ne te presse pas.
- Essaie de situer ton modèle dans le même sens que les instructions durant le montage.
- Le produit et les couleurs peuvent varier.

Informations Pile

ATTENTION :

- S'assurer d'installer les piles correctement et de suivre toujours les directives des fabricants du jouet et des piles.
- Ne pas mélanger des piles neuves avec des piles usées. Ne pas mélanger des piles alcalines avec des piles standard (Leclanché), ou des piles rechargeables (au nickel-cadmium). Il convient d'utiliser uniquement des piles du type recommandé ou d'un type équivalent.
- Retirer toujours les piles faibles ou mortes du produit ; ne pas faire court-circuiter les terminaux.
- Installer les piles en respectant la polarité (+/-) comme l'indique le schéma.

Conseils importants

- Les piles alcalines sont recommandées.
- Il est déconseillé d'utiliser des piles rechargeables.
- Retirer les piles rechargeables du jouet avant de les recharger; elles doivent être chargées exclusivement en présence d'un adulte.
- Les piles qui ne sont pas rechargeables ne doivent pas être rechargées.
- Veiller à ce que les éléments restent à l'abri de la poussière ; ne pas les plonger dans l'eau ; ne pas utiliser dans l'eau.

- Ne pas jeter les piles dans le feu ; elles risqueraient de fuir ou d'exploser et d'entraîner des blessures.
- Retirer toutes les piles si le jouet restera inutilisé pendant longtemps.
- Ne mettez pas les petites tiges dans les trous du moteur, elles endommageraient le moteur et il n'est pas possible de les enlever.
- Aidez l'environnement en jetant votre produit et son emballage de manière responsable. Le symbole de la poubelle à roulettes indique qu'il ne faut pas jeter le produit et les piles avec les ordures ménagères car ils contiennent des substances pouvant être nocives à l'environnement et à la santé. Veuillez utiliser les points de collecte de déchets ou les centres de tri désignés lorsque vous jetez l'article ou les piles.

Comment mettre et retirer des piles

Utiliser un petit Phillips tournevis pour desserrer la vis et pour enlever la couverture de batterie. Insérer 2 AA (ou LR6) batteries fraîches dans le compartiment de batterie avec la polarité correcte (+/-).

(Page 3)

Notions de base K'NEX pour le montage

Démarre ta construction

Pour commencer ton modèle, trouve l'étape numéro 1 et suis les numéros. Chaque pièce a sa propre forme et sa propre couleur. Regarde les illustrations, trouve les pièces qui correspondent à ce que tu vois et assemble-les. Pour t'aider pendant que tu construis, oriente ton modèle dans le même sens que les instructions. Les flèches t'indiquent où les pièces s'assemblent, mais les points de raccordement n'ont pas tous des flèches. Les pièces de couleur délavée sont celles que tu as déjà assemblées.

Espaceurs

Il y a des endroits sur ton modèle où tu auras besoin de te servir d'espaceurs. Assure-toi d'utiliser la bonne couleur et le nombre d'espaceurs indiqué sur les instructions.

Chaîne

Assure-toi de fixer tous les maillons de la chaîne dans le même sens.

Connecteurs

Tu peux assembler ces connecteurs tout à fait uniques en les faisant glisser l'un avec l'autre. Pousse fort jusqu'à ce que tu entendes un « clic ». Lis les instructions attentivement et positionne-les horizontalement ou verticalement, en suivant exactement les illustrations.

Liste des pièces

Avant de commencer à construire, assure-toi de comparer les pièces dans ta boîte à la liste de pièces fournie ici. S'il manque quelque chose, téléphone-nous ou écris-nous en te servant des informations figurant au verso de la notice. Nous sommes là pour t'aider !



Connettori

È molto importante posizionare i connettori blu e argento in una specifica direzione. Presta molta attenzione alle istruzioni e posiziona i connettori orizzontalmente o verticalmente proprio come illustrato. Spingi con forza fino ad udire un clic.

Elenco delle parti

Prima di cominciare a costruire, accertati di confrontare le parti che sono nel tuo set con l'elenco delle parti qui. Se ne manca una chiamaci o scriviici usando le informazioni che sono nella retrocopertina. Noi siamo qui per aiutarli!

(Pagina 26)

Punte delle rotaie:

Attaca le guide a catena sulla parte superiore della rotaia. Collega i connettori sulla base della rotaia esattamente come illustrato.

Premi i connettori saldamente fino a che si fissano con uno scatto.

Collega sempre la rotaia parte superiore a parte superiore in tutta la costruzione.

(Pagina 44)

Per collegare le carrozza, stacca un pezzo di rotaia e quindi infila le ruote della carrozza sulla parte superiore della rotaia. Quindi unisci i pezzi della rotaia. Se le carrozze si arrestano durante la discesa, Controlla che la carrozza non abbia colpito qualche altra parte K'NEX.

Suggerimenti e risoluzione dei problemi

Se il motore o il modulo del suono non funzionano:

- Controlla che le batterie siano nuove e che siano installate correttamente.
- Se ancora non dovesse funzionare, chiama il numero di assistenza ai clienti 1-800-KID-KNEX (USA e Canada soltanto). Vedi il retro della scatola per trovare altri modi di contattare K'NEX.

Se le carrozze si arrestano durante la discesa:

- Il modello è costruito correttamente?
- Controlla che la carrozza non abbia colpito qualche altra parte K'NEX.
- I pezzi della rotaia sono collegati correttamente?
- La carrozza è collegata alla rotaia correttamente?
- Regola la rotaia per eliminare qualsiasi parte piatta sulla stessa.

(PT) Português

(Página 2)

Coisas importantes para os Pais e os Miúdos

Mantenha estas instruções num local de fácil acesso, pois contém informações importantes de segurança.

Lê as instruções e advertências antes de começares a construir e a operar o modelo.

AVISO: PERIGO DE SUFOCAÇÃO - Peças pequenas. Não se destina a crianças com menos de 3 anos de idade.

CUIDADO: Mantém o cabelo, os dedos, a cara e a roupa afastados de todas as peças móveis.

CUIDADO: O cabelo da criança pode ficar emaranhado se entrar em contacto com as peças móveis do brinquedo.

- Compartilhe da experiência K'NEX com os miúdos e faça com que o processo de construção com K'NEX se torne numa aventura entre família.
- Não te precipites para assim poderes desfrutar do processo de construção. Não o faças à pressa!
- Tenta fazer com que o teu modelo esteja virado exactamente na mesma direcção indicada nas instruções.
- Tanto o produto como as respectivas cores podem variar.

Informações sobre as pilhas

CUIDADO:

- Certifique-se de que introduz as pilhas correctamente e siga sempre as instruções do fabricante da bateria e do brinquedo.
- Não combine pilhas usadas com pilhas novas, pilhas alcalinas, padrão (carbono-zinco) ou pilhas recarregáveis (níquel-cádmio). Deverão ser usadas apenas pilhas do mesmo tipo ou equivalentes ao tipo recomendado.
- Retire sempre as pilhas fracas ou gastas do produto; não provoque um curto-circuito nos terminais de alimentação.
- Introduza as pilhas com a polaridade correcta (+/-), conforme se mostra.

Conselhos importantes

- Recomenda se o uso de pilhas alcalinas.
- Não se recomenda o uso de pilhas recarregáveis.
- Retire as pilhas recarregáveis do brinquedo antes de as carregar; estas pilhas devem ser recarregadas apenas sob vigilância de adultos.
- As pilhas não recarregáveis não devem ser carregadas.
- Mantenha os componentes livres de poeiras; não mergulhe em água nem use água.
- Não elimine as pilhas queimando-as; estas podem apresentar fugas ou explodir causando lesões.
- Retire todas as pilhas do brinquedo se não tencionar usá-lo durante um longo período de tempo.
- Não coloque varetas de tamanho inferior a 5,1 cm (2 pol.) em nenhuma abertura do motor; as varetas causarão danos no motor e não podem ser removidas.
- Ajude o ambiente eliminando o seu produto e a embalagem vazia responsabilmente. A imagem do contentor do lixo com rodinhas indica que o produto e as pilhas não devem ser eliminados juntamente com os resíduos domésticos pois contém substâncias que podem provocar efeitos novíços no ambiente e na saúde. Por favor use os pontos de recolha designados ou as instalações de reciclagem quando necessitar de eliminar o produto ou as pilhas.

Como inserir e remover as pilhas

Usar uma chave de fenda principal pequena de Phillips para afrouxar o parafuso e para remover a tampa de bateria. Introduzir 2 AA (ou LR6) baterias frescas no compartimento de bateria com a polaridade correta (+/-).

(Página 3)

Pontos básicos para a construção K'NEX

Inicia a construção

Para começar o teu modelo, procura o **1** e segue os números. Cada peça tem a sua própria forma definida e cor. Basta simplesmente olhares para a ilustração, procurar as peças do teu jogo correspondentes às que estás a ver e, em seguida, conectar umas nas outras. Enquanto estás a montar as peças, tenta manter o teu modelo na mesma direcção, conforme mostrado na ilustração, para assim ligares as peças correctamente. As cores desbotadas indicam que esta secção já está montada. Passarás então a fazer a conexão da nova secção no local indicado pelas setas.

Espaçadores

Existirão certos pontos no teu modelo que necessitam a colocação de espaçadores azuis e prateados. Assegura-te que os contas cuidadosamente.

Corrente

Assegura-te que prendes todos os elos da corrente seguindo a mesma direcção.

Conectores

É muito importante que posiciones os conectores azuis e cor de prateados numa direcção específica. Presta muita atenção às instruções e coloca estes conectores horizontal ou verticalmente, exactamente conforme se mostra nas ilustrações. Junta as partes simultaneamente e com firmeza até ouvires um "estalido".

Lista de peças

Antes de iniciares a construção, certifica-te de que comparas as peças do teu conjunto com a lista das peças aqui. Se faltar alguma peça telefona ou escreve-nos usando as informações indicadas na contracapa. Estamos aqui para te ajudar!

(Página 26)

Sugestões para a Pista:

Prende as Guias de Corrente ao topo da Pista. Liga os conectores à base da Pista exactamente como demonstrado.

Faz avançar os conectores firmemente até “encaixarem” com um estalido.

Liga sempre a face superior da Pista à face superior durante a montagem.

(Página 44)

Para prenderes as carruagem, desliga uma peça da pista e, seguidamente, enfia as rodas da carruagem sobre a face superior da pista. Depois junta as peças da pista umas às outras. Se as carruagem ficarem encravadas na descida, assegura-te de que a carruagem não está a chocar contra outras peças K'NEX.

Sugestões e Resolução de Problemas

Se o Motor ou o Módulo de Som não funcionar:

- Verifica se as pilhas são novas e se estão instaladas correctamente.
- Caso continuem sem funcionar, contacta a Linha Directa de Atendimento ao Consumidor através do número 1-800-KID-KNEX (apenas nos EUA e no Canadá). Consulta a contra capa para mais informações sobre como contactares a K'NEX.

Se as Carruagens ficarem encravadas na descida:

- O modelo foi construído correctamente?
- Assegura-te de que a Carruagem não está a chocar contra outras peças K'NEX.
- As peças da Pista estão ligadas correctamente?
- A Carruagem está presa à Pista correctamente?
- Ajusta a Pista para eliminares qualquer ponto plano na Pista.

(NL) Nederlands

(Bladzijde 2)

Belangrijke gegevens voor ouders en kinderen

Bewaar deze aanwijzingen op een gemakkelijk bereikbare plaats. Ze bevatten belangrijke veiligheidsgegevens.

Gelieve alle waarschuwingen en aanwijzingen te lezen vóór je het model begint op te bouwen en te gebruiken.

WAARSCHUWING: VERSTIKKINGSGEVAAR - Kleine onderdelen. Niet geschikt voor kinderen onder 3 jaar.

OPGEPAST: Hou het haar, de vingers, het gezicht en kledij verwijderd van alle bewegende onderdelen.

OPGEPAST: Als het haar van het kind in aanraking komt met bewegende onderdelen van het speelgoed kan het haar verstrikt raken.

- Deel de K'NEX ondervinding met je kind en maak van het bouwen met K'NEX een aangenaam familieavontuur.
- Neem je tijd tijdens het bouwen en monteren. Spoed je niet!
- Tracht je model in dezelfde richting te plaatsen als de aanwijzingen terwijl je bouwt en monteert.
- Produkt en kleuren kunnen afwijken.

Batterijgegevens

OPGEPAST:

- Verzeker je ervan dat de batterijen er op de juiste manier in te steken en volg steeds de aanduidingen van de speelgoed- en batterijenfabrikanten.

- Meng geen oude en nieuwe batterijen of alkalische, gewone (koolstof-zink) of herlaadbaarse (nikkel-cadmium) batterijen met mekaar. Uitsluitend batterijen van dezelfde of van een aanbevolen equivalente soort dienen gebruikt te worden.
- Verwijder steeds uitgeputte of ontladen batterijen uit het produkt; veroorzaak geen kortsluiting van de voedingspolen.
- Steek de batterijen erin volgens de juiste polariteit (+/-) zoals afgebeeld.

Belangrijke tips

- Alkalische batterijen worden aanbevolen.
- Herlaadbare batterijen worden niet aanbevolen.
- Verwijder herlaadbare batterijen uit het speelgoed alvorens ze te herladen; ze moeten slechts herladen worden onder het toezicht van een volwassene.
- Niet-herlaadbare batterijen mogen niet herladen worden.
- Bescherm onderdelen tegen stof; dompel ze niet of gebruik ze niet in water.
- Werp de batterijen niet in het vuur; ze zouden kunnen lekken of ontploffen en verwondingen veroorzaken.
- Verwijder alle batterijen wanneer het speelgoed gedurende lange tijd niet gebruikt zal worden.
- Plaats staafjes in de openingen van het motor, zij zouden de motor beschadigen en kunnen niet worden verwijderd.
- Help de omgeving door uw product en verpakking verantwoordelijk weg te werpen. Het symbol met de vuilnisbak op wietjes duidt aan dat het product en de batterijen niet mogen weggeworpen worden in huishoudvuil vermits ze stoffen bevatten die de omgeving en de gezondheid kunnen schaden. Gelieve de aangeduide verzamelpunten of recyclageinstallaties te gebruiken wanneer u zich wil ontdoen van dit artikel of deze batterijen.

Insteken en verwijderen van batterijen

Gebruik een kleine hoofdschroevendraaier Phillips om de schroef los te maken en de batterijdekking te verwijderen. Neem 2 verse AA (of LR6) batterijen in het batterijcompartiment met op de correcte polariteit (+/-).

(Bladzijde 3)

Basisstappen voor K'NEX bouwen

Begin te bouwen

Om met je model te beginnen, vind eerst het nummer 1 en volg de nummers. Elk stuk heeft zijn eigen vorm en kleur. Kijk gewoonweg naar de afbeeldingen, vind de overeenstemmende stukken terug in je geheel en maak ze aan mekaar vast. Tracht je model in dezelfde richting te plaatsen als de aanwijzingen terwijl je bouwt en monteert. De vervaagde kleuren duiden aan dat dit deel reeds is opgebouwd. Gelieve het nieuwe deel vast te koppelen op de plaats aangeduid door de pijlen.

Koppelstukken

Er zijn blauwe en zilveren koppelstukken met speciale lange gleuven. Ze schuiven in mekaar zoals je kunt zien op de afbeeldingen. Duw deze onderdelen in mekaar tot je een “klik” hoort.

Tussenstukken

In je model zijn er plaatsen waar blauwe en zilveren tussenstukken moeten toegevoegd worden.

Verzeker je ervan de juiste kleur te gebruiken en tel ze zorgvuldig.

Keten

Maak zeker dat alle ketenschakels vastgemaakt worden in dezelfde richting.

Onderdelenlijst

Voor je begint te bouwen, vergewis je ervan de onderdelen in je geheel na te gaan met de onderdelenlijst hier. Wanneer iets ontbreekt, bel ons op of schrijf ons door gebruik te maken van de informatie op het achterblad. We staan er om je te helpen !

(Bladzijde 26)

Spoortips:

Maak de kettinggidsen vast bovenaan het spoor. Maak de koppelstukken vast aan de onderkant van het spoor precies zoals afgebeeld.

Druk de koppelstukken goed erin tot ze “klikken”.

Maak steeds de bovenkant van het spoor vast aan de bovenkant tijdens de opbouw.

(Bladzijde 44)

Om de wagen vast te maken, maak een stuk spoor los en breng dan de wielen van de wagen aan over de bovenkant van het spoor. Maak vervolgens de spoorstukken aan mekaar vast. Wanneer wagens vastlopen tijdens de daling, verzeker je ervan dat de wagen tegen geen K'NEX onderdelen aanloopt.

Tips & Oplossen van problemen

Wanneer de motor- of klankmodule niet werkt:

- Kijk na dat je nieuwe batterijen hebt en dat ze er behoorlijk zijn aangebracht.
- Werkt het nog steeds niet, bel dan de Klantendienst Hotline op aan het nummer 1-800-KID-KNEX (uitsluitend in de VS en Canada). Kijk naar het achterblad voor andere manieren om contact op te nemen met K'NEX.

Wanneer wagens vastlopen tijdens de daling:

- Is het model behoorlijk opgebouwd?
- Verzeker je ervan dat de wagen tegen geen K'NEX onderdelen aanloopt.
- Zijn de spoorstukken behoorlijk verbonden?
- Is de wagen behoorlijk aan het spoor verbonden?
- Ajusteer het spoor om platte stukken op het spoor te verwijderen.

KNEX.COM

COLLECT & BUILD™



LIGHT-UP FERRIS WHEEL™



K'NEX Customer Service; Tel 1-800-KID-KNEX (USA/CAN only); email@knex.com; www.knex.com
For Customer Service outside USA/CAN contact your local distributor at: <http://www.knex.com/distributors>
(FR) Le Service clients hors d'USA/CAN, s'il vous plaît contacter le distributeur local. L'information à <http://www.knex.com/distributors>
(AZ) (NZ) (UK) (DE) (NL) (BE) (CH) (CL) (PE) <http://www.knex.com/distributors>
(UK) TOMY Careline, PO Box 20, Totton, Hants, SO40 3YF; Tel 023 8066 2600
(FR) ALLO TOMY SAV, Parc d'affaires International, 74166 ARCHAMPS; Tél 0 820 013 013
(UK) (FR) (DE) (NL) <http://www.tomy.eu>

Product & colors may vary. Standard K'NEX parts made in the USA. K'NEX and Imagine, Build, Play are registered trademarks of K'NEX Limited Partnership Group.

(FR) Produits et couleurs peuvent varier. Pièces K'NEX courantes fabriqués aux États-Unis. K'NEX et Imagine, Build, Play sont des marques déposées de K'NEX Limited Partnership Group.

(ES) El producto y los colores pueden variar. Piezas estándar de K'NEX hechas en EE.UU. K'NEX y Imagine, Build, Play son marcas registradas de K'NEX Limited Partnership Group.

Sold separately. Some products may not be available in all markets.

Vendus séparément. Certains produits ne sont pas disponibles pour tous les marchés.

Se venden por separado. Algunos productos no pueden estar disponibles en todos los mercados.

Separat verkauft. Einige Produkte können möglicherweise nicht in allen Märkten vorhanden sein.

Venduto esclusivamente. Alcuni prodotti non possono essere disponibili in tutti i mercati.

Vendido separada. Alguns produtos não podem estar disponíveis em todos os mercados.

Afzonderlijk verkocht. Sommige producten kunnen niet in alle markten beschikbaar zijn.



©2010 K'NEX Limited Partnership Group
P.O. Box 700
Hatfield, PA
19440-0700

158108.11-V1-05/10