



# Silver Edition Value Tub



[www.KNEX.com](http://www.KNEX.com)



**6-12**

Building System  
Système De Construction

**WARNING:**  
CHOKING HAZARD - Small parts.  
Not for children under 3 years.

**AVERTISSEMENT:**  
DANGER D'ÉTOUFFEMENT - Pièces de petite taille.  
Ne pas donner aux enfants de moins de 3ans.

## Contents

|                                      |           |                                  |           |
|--------------------------------------|-----------|----------------------------------|-----------|
| <b>About the Set</b> . . . . .       | <b>2</b>  | <b>Road Grader</b> . . . . .     | <b>14</b> |
| <b>Welcome</b> . . . . .             | <b>2</b>  | <b>Spin-O-Matic</b> . . . . .    | <b>16</b> |
| <b>Building with K'NEX</b> . . . . . | <b>3</b>  | <b>Suspension Car</b> . . . . .  | <b>17</b> |
| <b>Models To Build</b>               |           | <b>Castle</b> . . . . .          | <b>20</b> |
| Space Shuttle . . . . .              | <b>4</b>  | <b>Picture Frame</b> . . . . .   | <b>21</b> |
| Motorcycle . . . . .                 | <b>5</b>  | <b>Helicopter</b> . . . . .      | <b>22</b> |
| Owl . . . . .                        | <b>6</b>  | <b>Mini Carousel</b> . . . . .   | <b>24</b> |
| Dragster . . . . .                   | <b>6</b>  | <b>Flat Frog</b> . . . . .       | <b>26</b> |
| Windsurfer . . . . .                 | <b>7</b>  | <b>Windmill</b> . . . . .        | <b>28</b> |
| Steam Ship . . . . .                 | <b>8</b>  | <b>What's Included</b> . . . . . | <b>30</b> |
| Mini Ferris Wheel . . . . .          | <b>8</b>  | <b>What's Next?</b> . . . . .    | <b>30</b> |
| Tow Truck . . . . .                  | <b>9</b>  | (F) French Language . . . . .    | <b>30</b> |
| Ring Toss . . . . .                  | <b>10</b> | (E) Spanish Language . . . . .   | <b>31</b> |
| Trike . . . . .                      | <b>11</b> | (D) German Language . . . . .    | <b>31</b> |
| Galaxy Woman . . . . .               | <b>13</b> | (NL) Dutch Language . . . . .    | <b>31</b> |

## About the Set

Build as many as you can - it's up to you!  
Build the Mini Carousel, Ring Toss,  
Windsurfer, Motorcycle and more!

Celebrate building fun with this great  
Building Set from K'NEX! The set includes  
instructions for building some of the most  
popular K'NEX models developed over the  
past ten years! Follow the instructions to build  
vehicles, creatures, rides and more or use  
your imagination to build endless creations!  
Get ready for some building fun!



## Welcome!

**The fun is about to begin!**

I designed the K'NEX building system for  
kids like you - kids who want to build in a  
whole new way. Using our snap-together  
Rods, Connectors and color-coded  
instructions, you can build the models  
we've designed - or you can use your  
imagination and build cool models of  
your own! That's what K'NEX is all about  
- getting an idea and making it happen.  
Just like I did when I invented K'NEX!

*Joel Glickman*  
Inventor of K'NEX

# Building with K'NEX

Hi! I'm your K'NEX building buddy. The instructions in this book will help

you build 30 models to start you on your way to being a K'NEXpert! You'll find models for three levels of building. Look for me before each build, holding up a sign to show you how difficult each model will be, ... check this out:



**Friendly Challenge**



**Moderate Challenge**



**Greater Challenge**

## Ready, Set, Build

To begin your model, find the  and follow the numbers. Each piece has its own shape and color. Just look at the picture, find the pieces in your set that

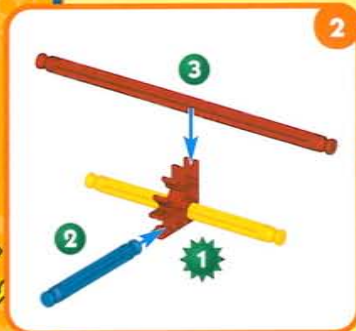

match what you see, and snap them together. Try to hold your model in the same direction as in the picture so you'll attach your pieces to the right place.

## Movin' On

The faded colors tell you this section is already built. You'll want to

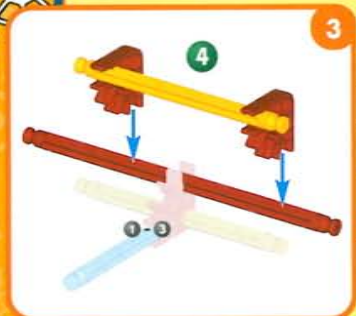

connect the new section to the place where the arrows are pointing. This piece will be in full color.

## Spacers

There are places in your model where you need to add blue and silver Spacers. Be sure to count them carefully.



## Connectors

It's very important to position blue and purple Connectors in a specific direction. Pay close attention to the instructions, and position these Connectors horizontally or vertically exactly as they are shown. Push together tightly until you hear a "click".

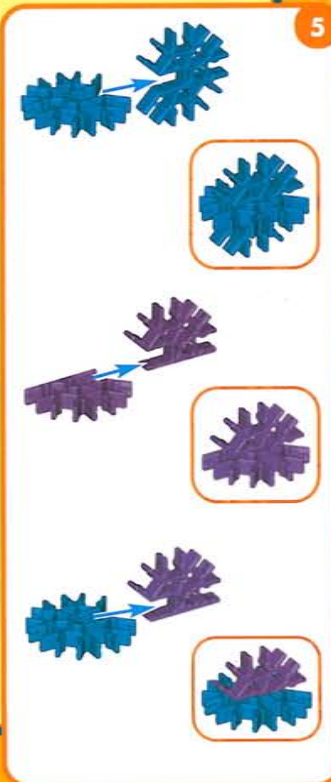

# Space Shuttle

**HOT**  
**1992**  
**PICKS**



# Motorcycle

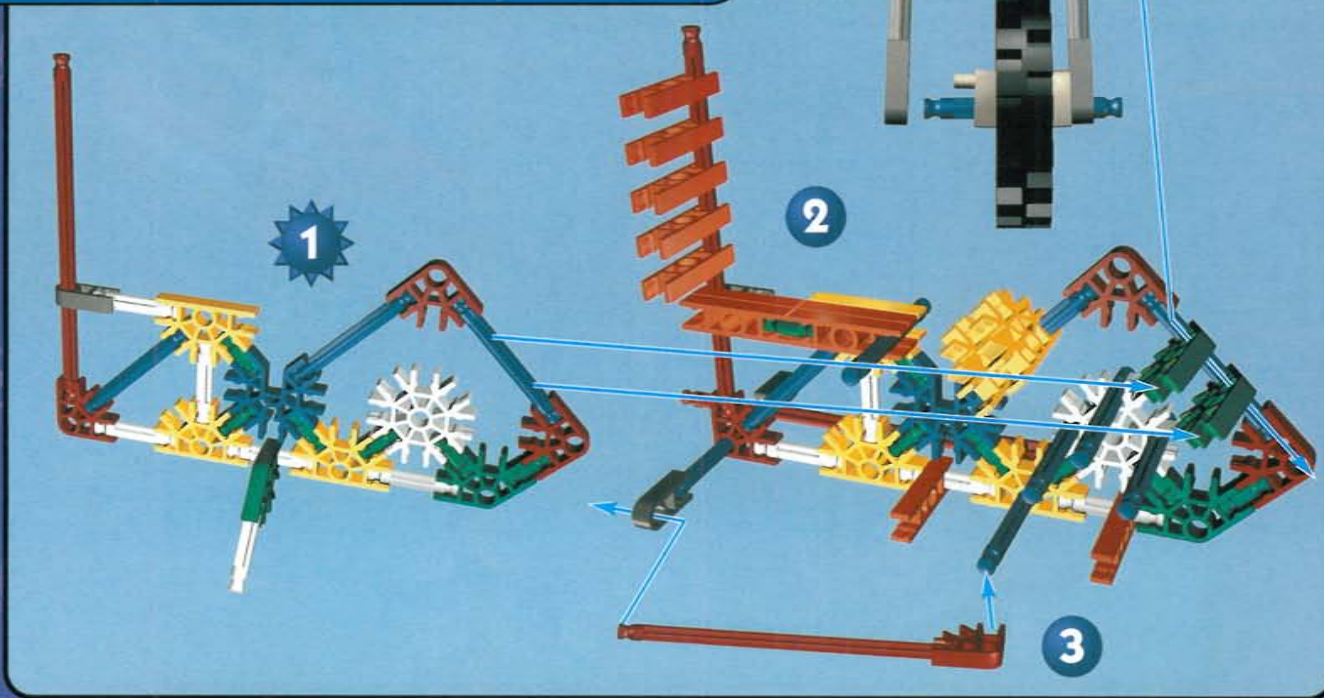
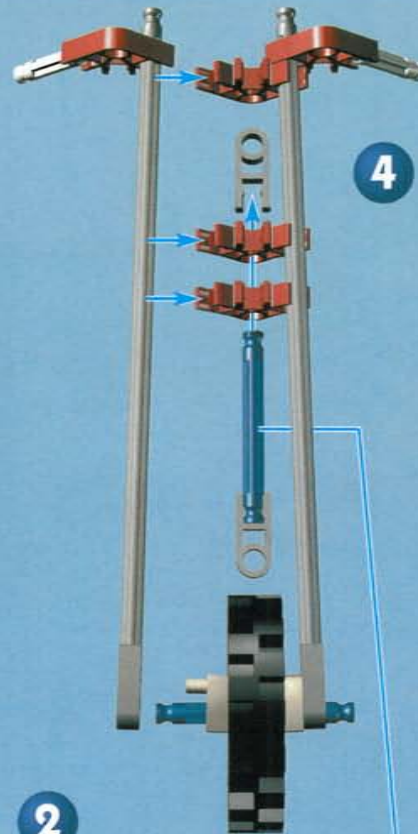

# Owl

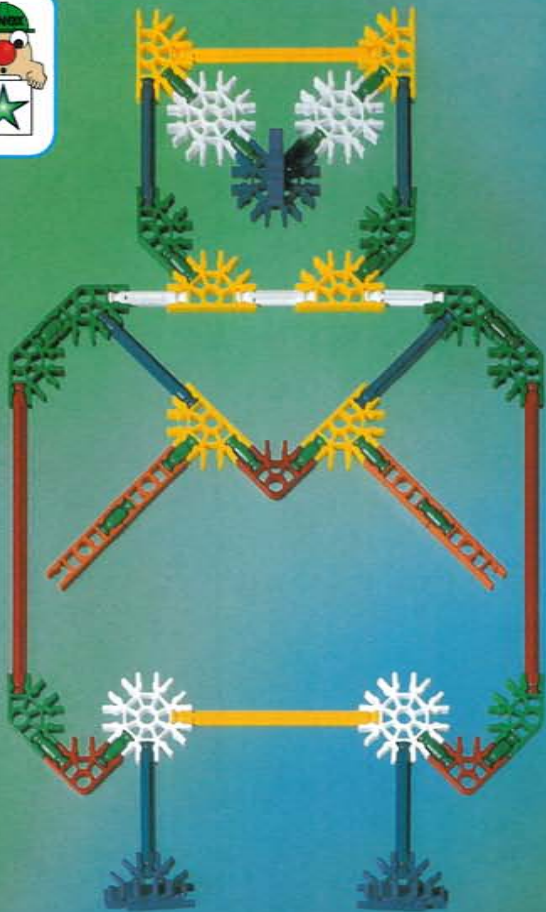

# Dragster

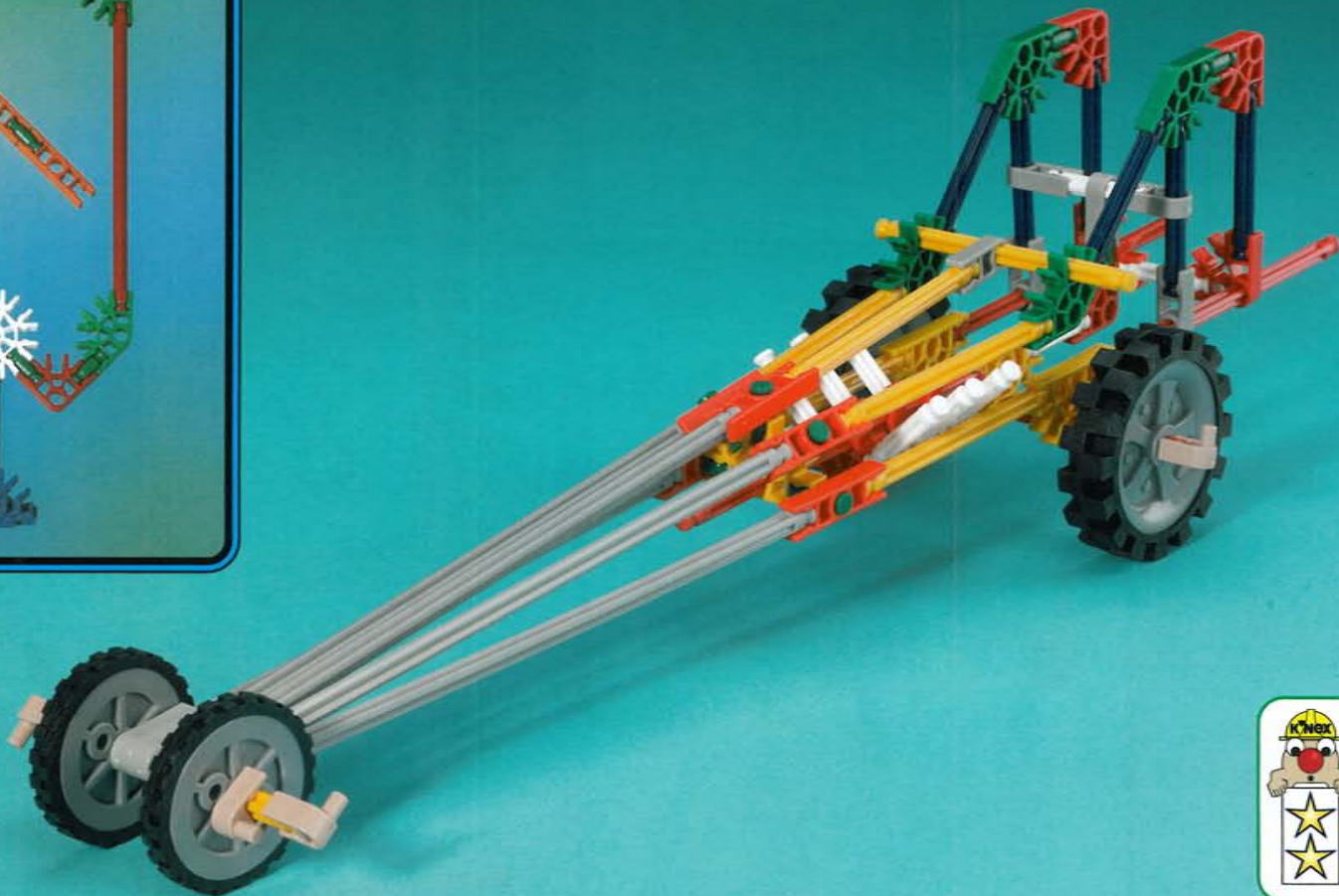

# Windsurfer

**HOT**  
**1994**  
**PICKS**

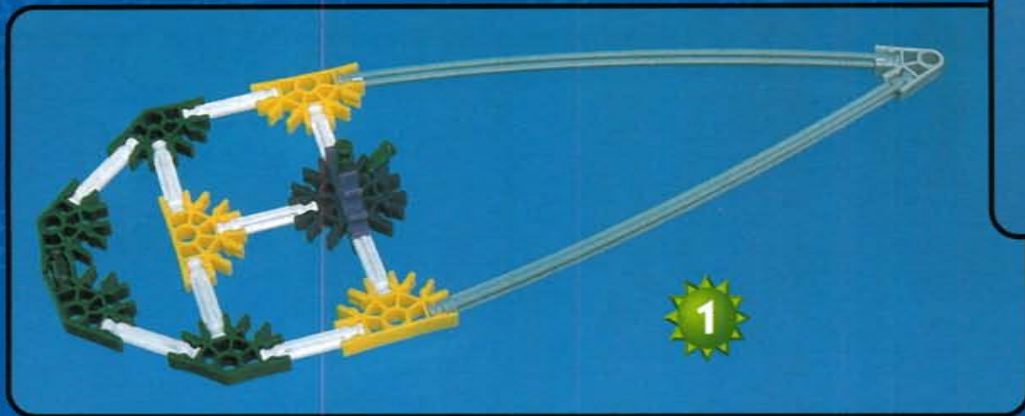

# Steam Ship

**HOT**  
**1994**  
**PICKS**

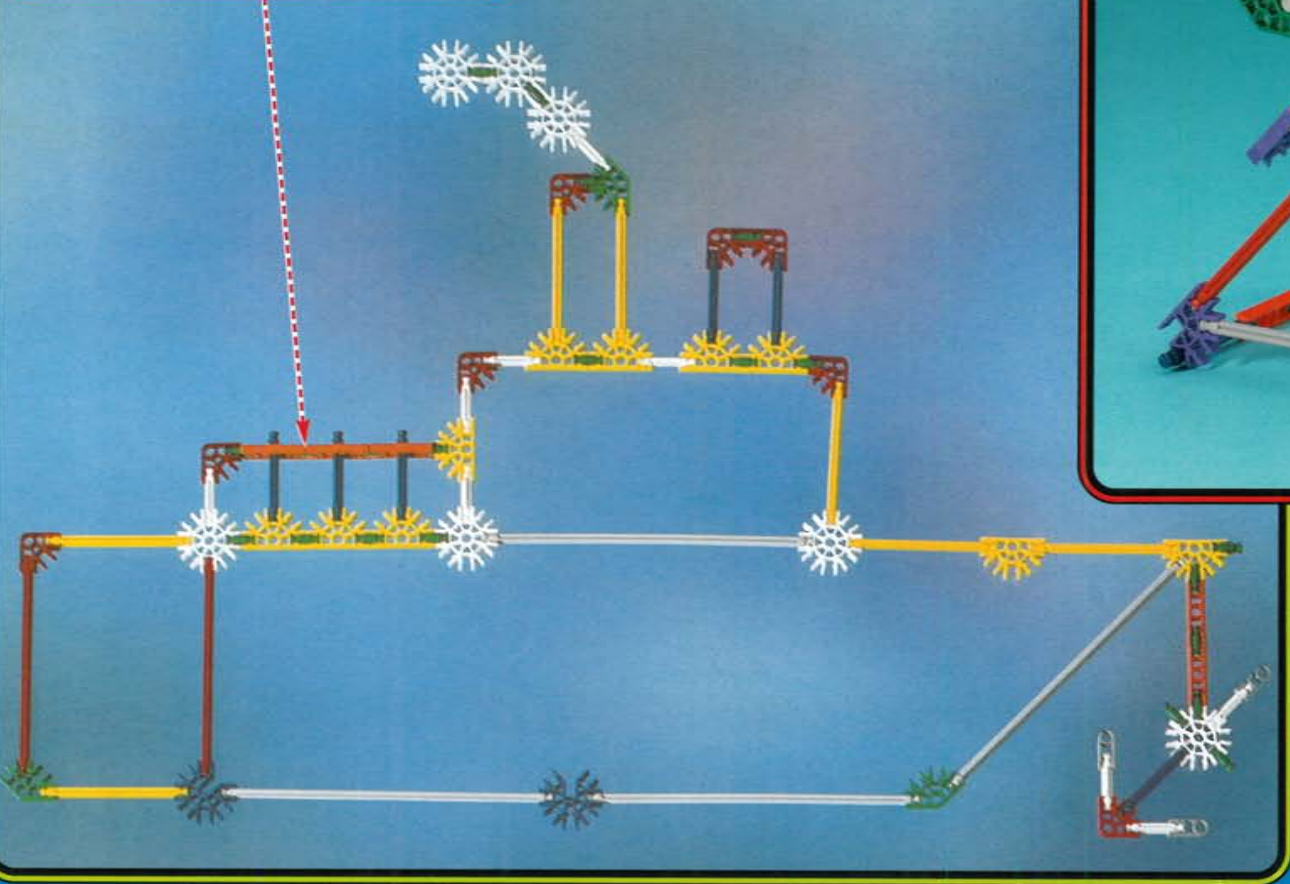

# Mini Ferris Wheel



**HOT**  
**1995**  
**PICKS**

# Tow Truck



1 - 5

# Ring Toss

**HOT**  
**1996**  
**PICKS**

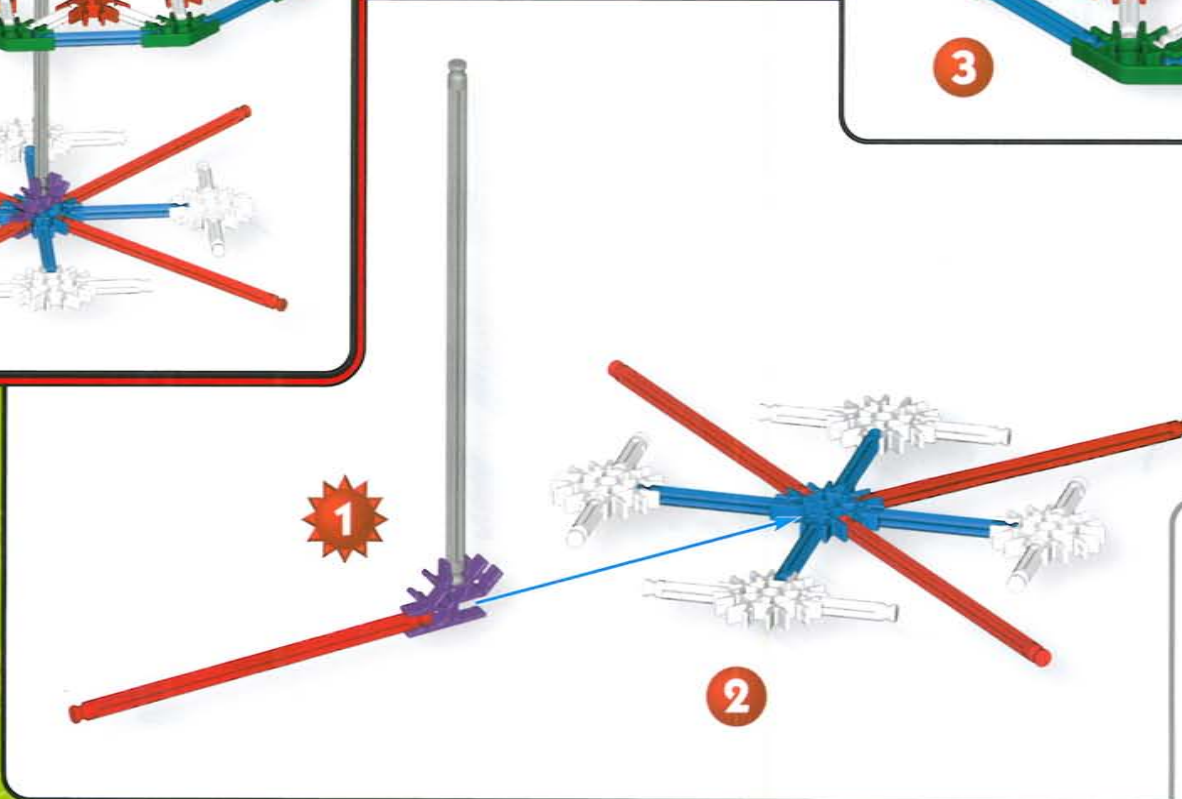
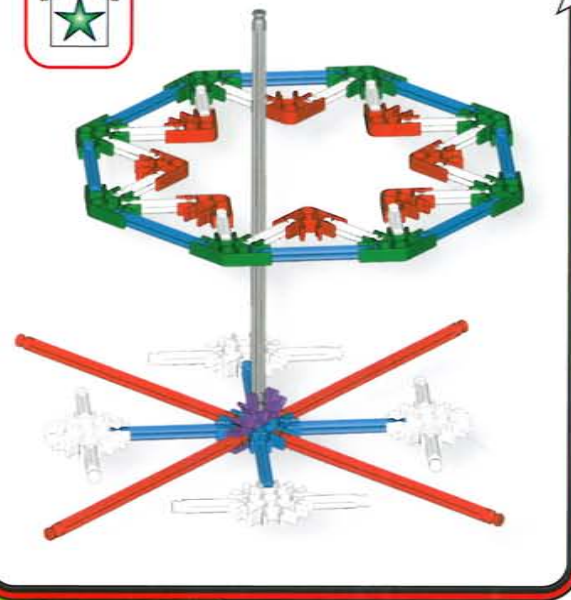
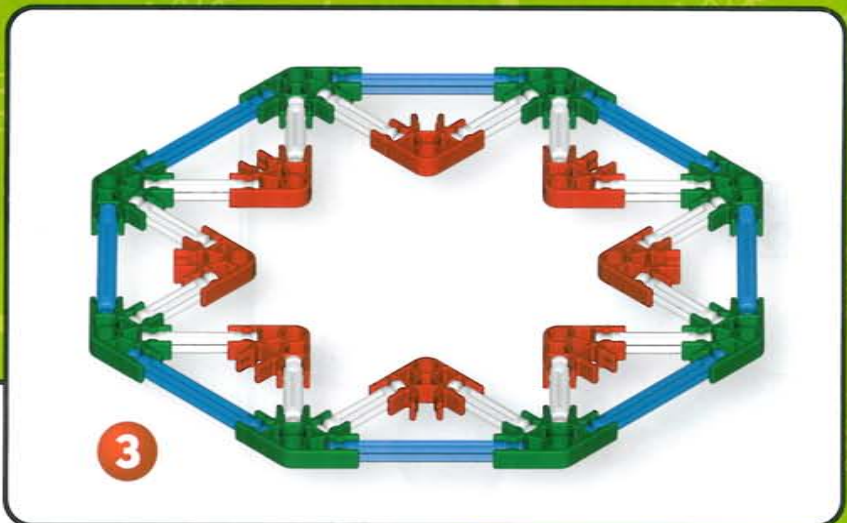

# Trike

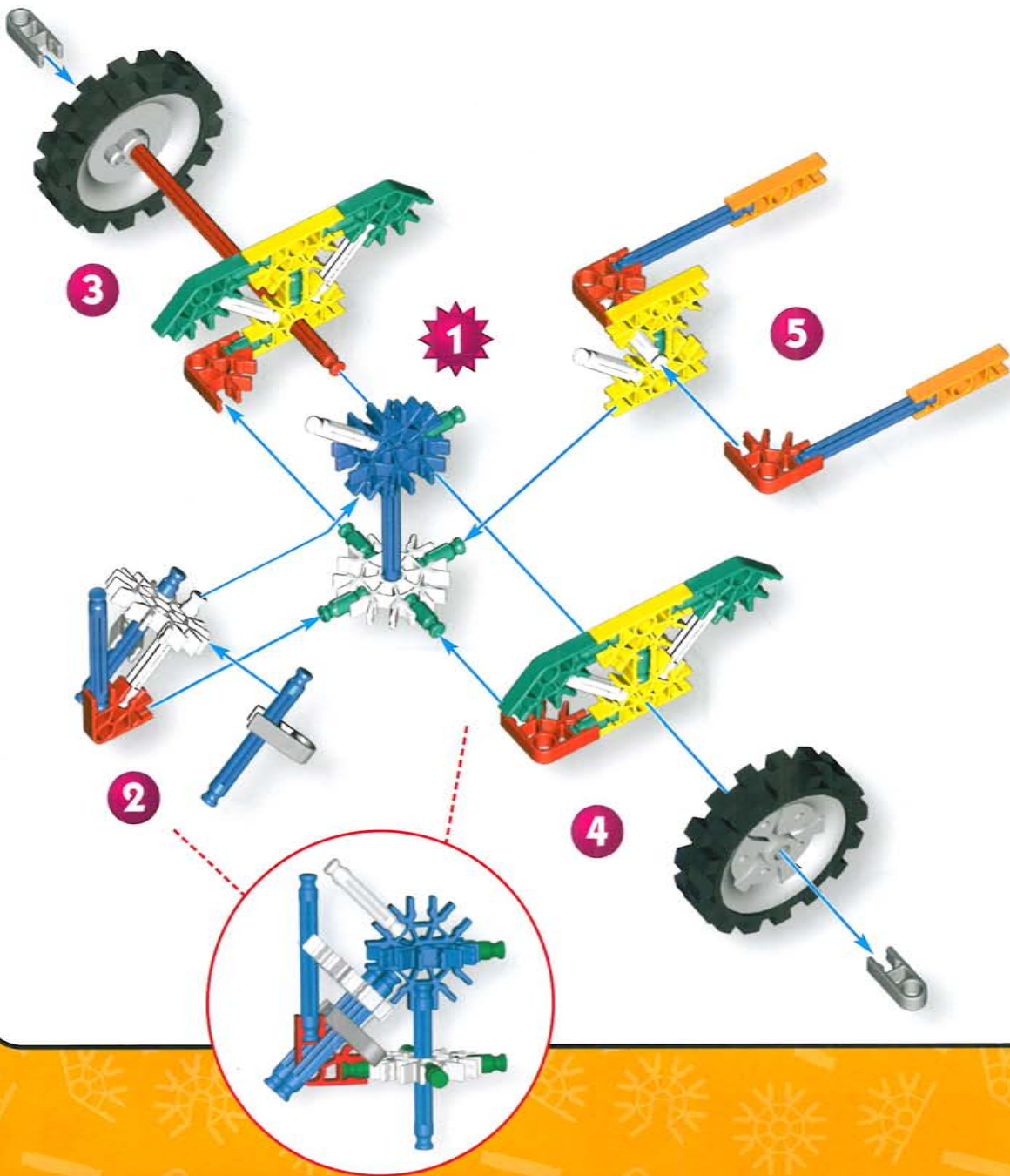
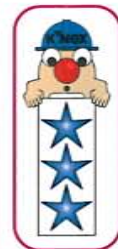



# Galaxy Woman

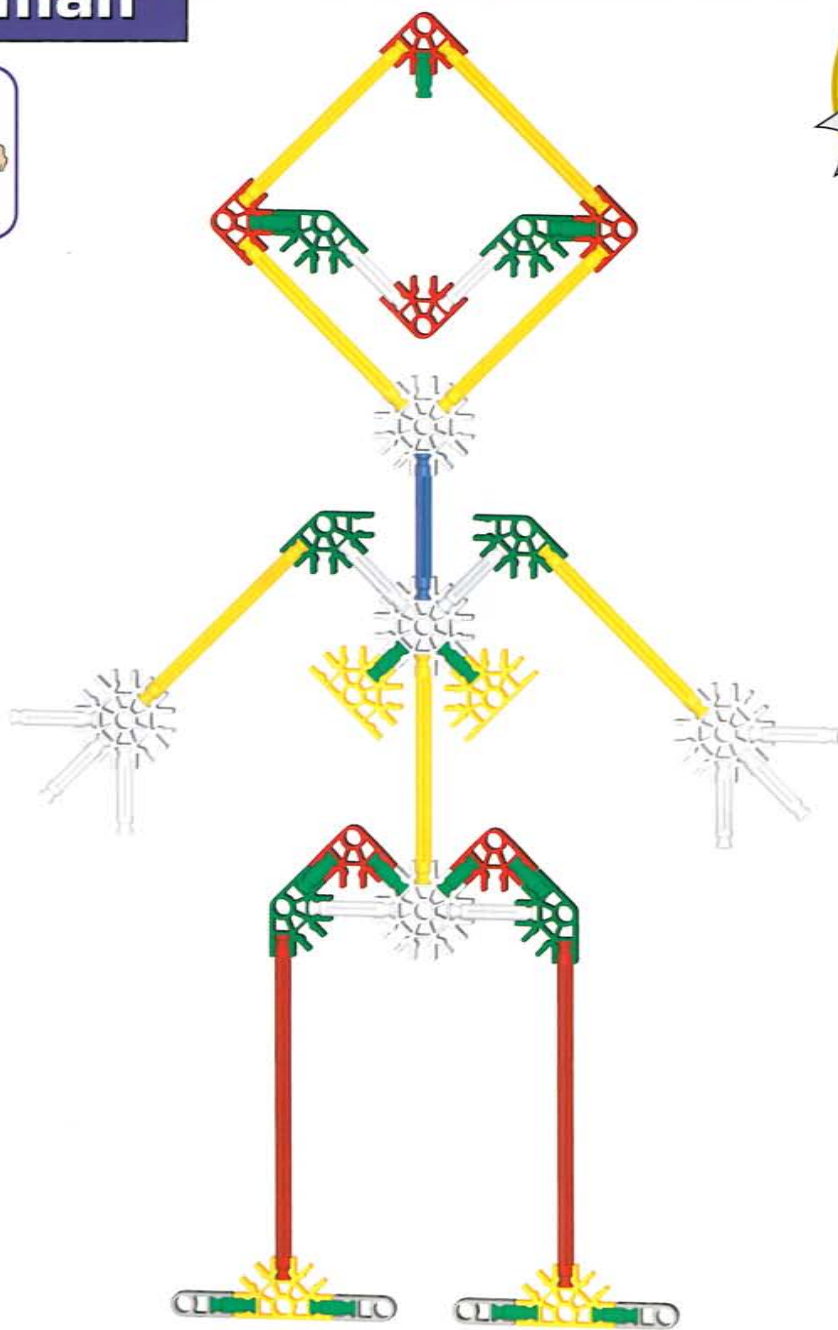

# Road Grader

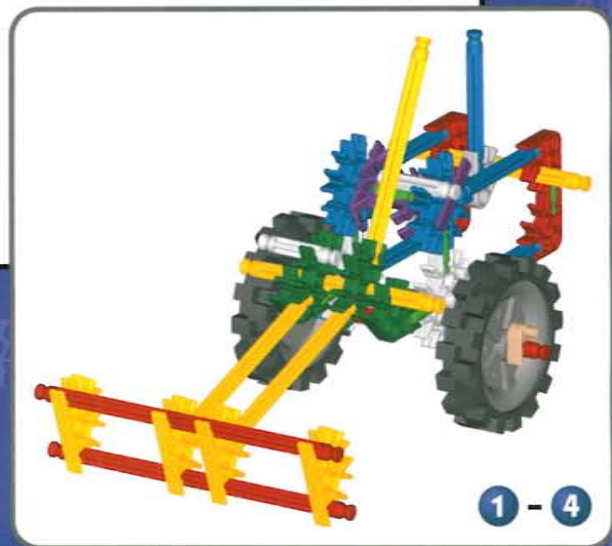
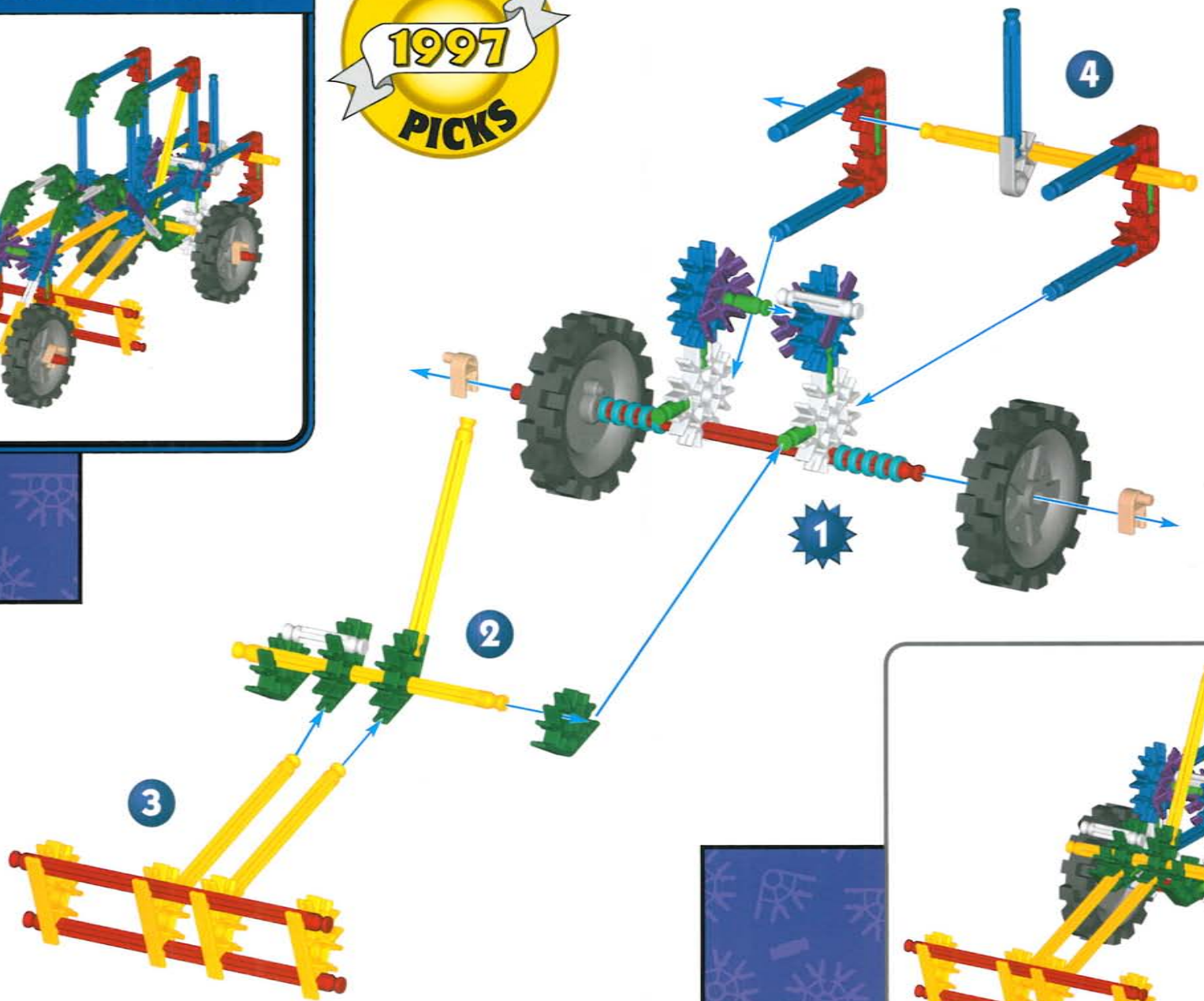

1 - 4

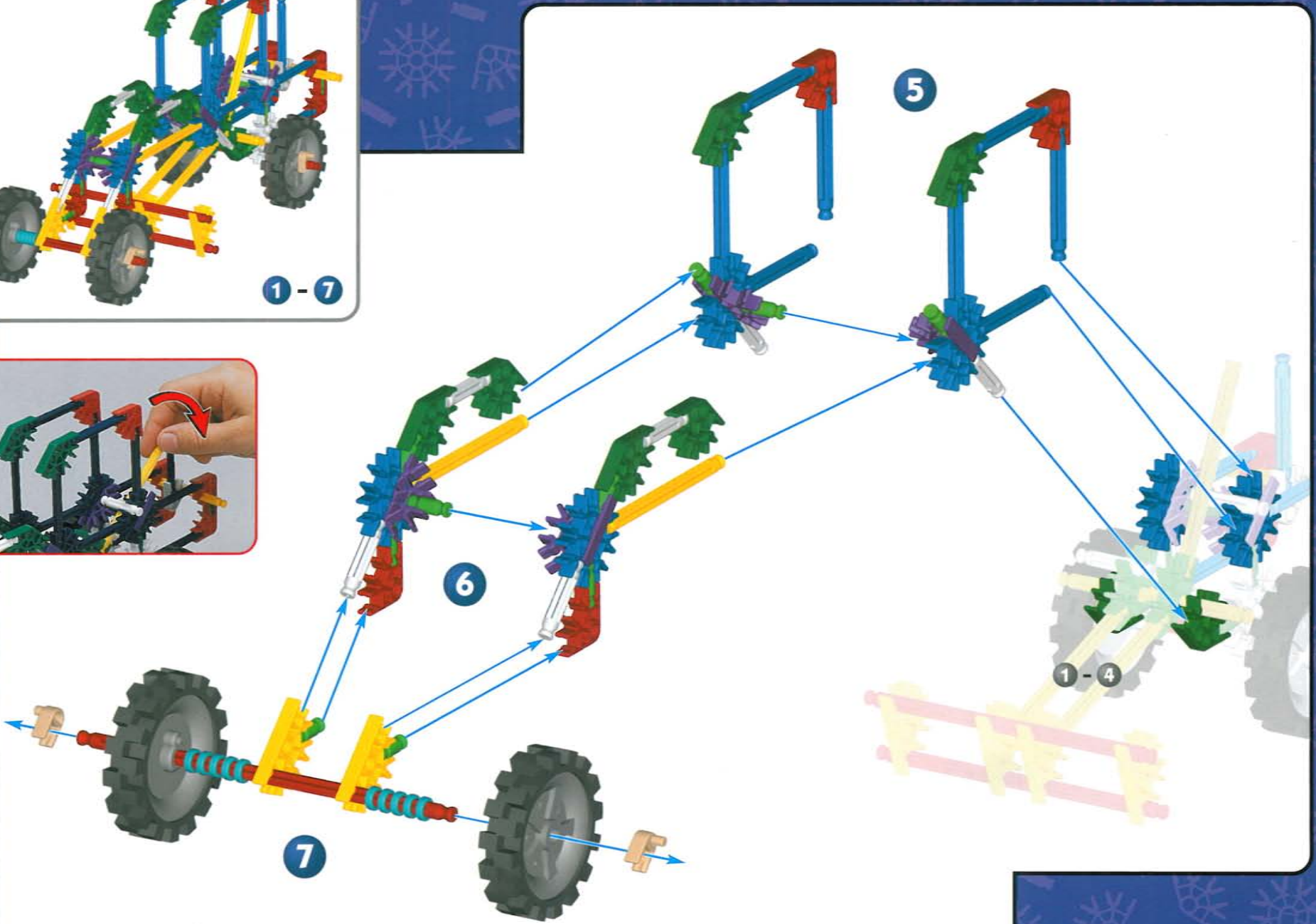
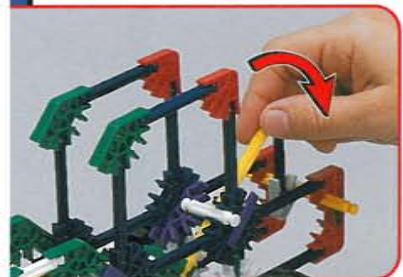

# Spin-O-Matic

**HOT**  
**1998**  
**PICKS**



# Suspension Car



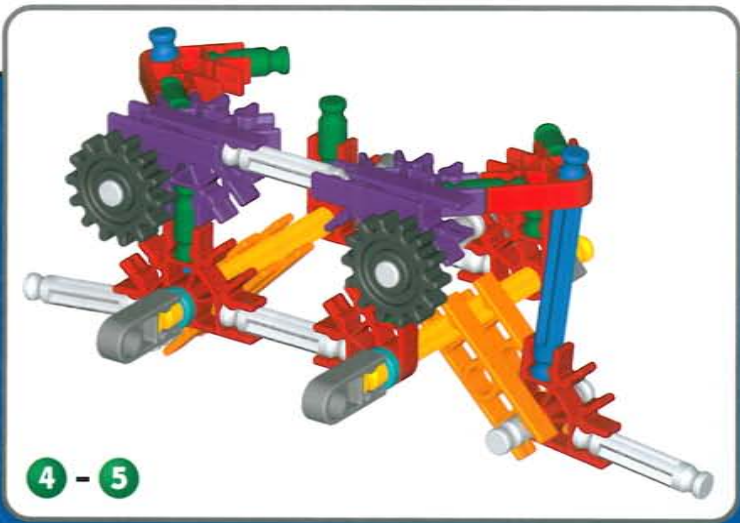
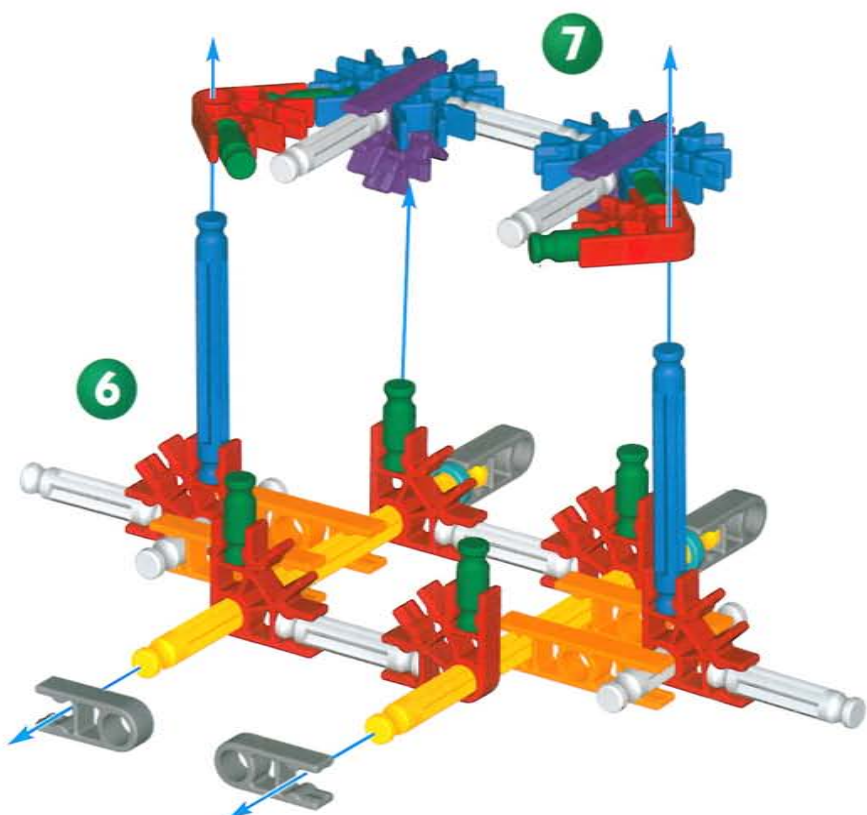
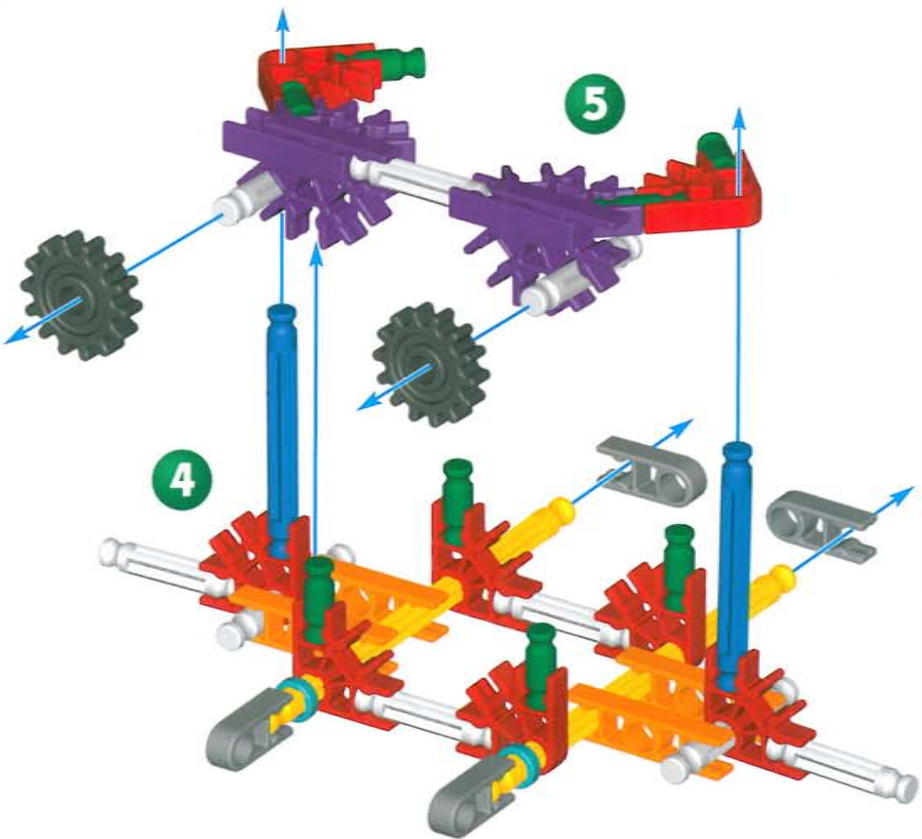

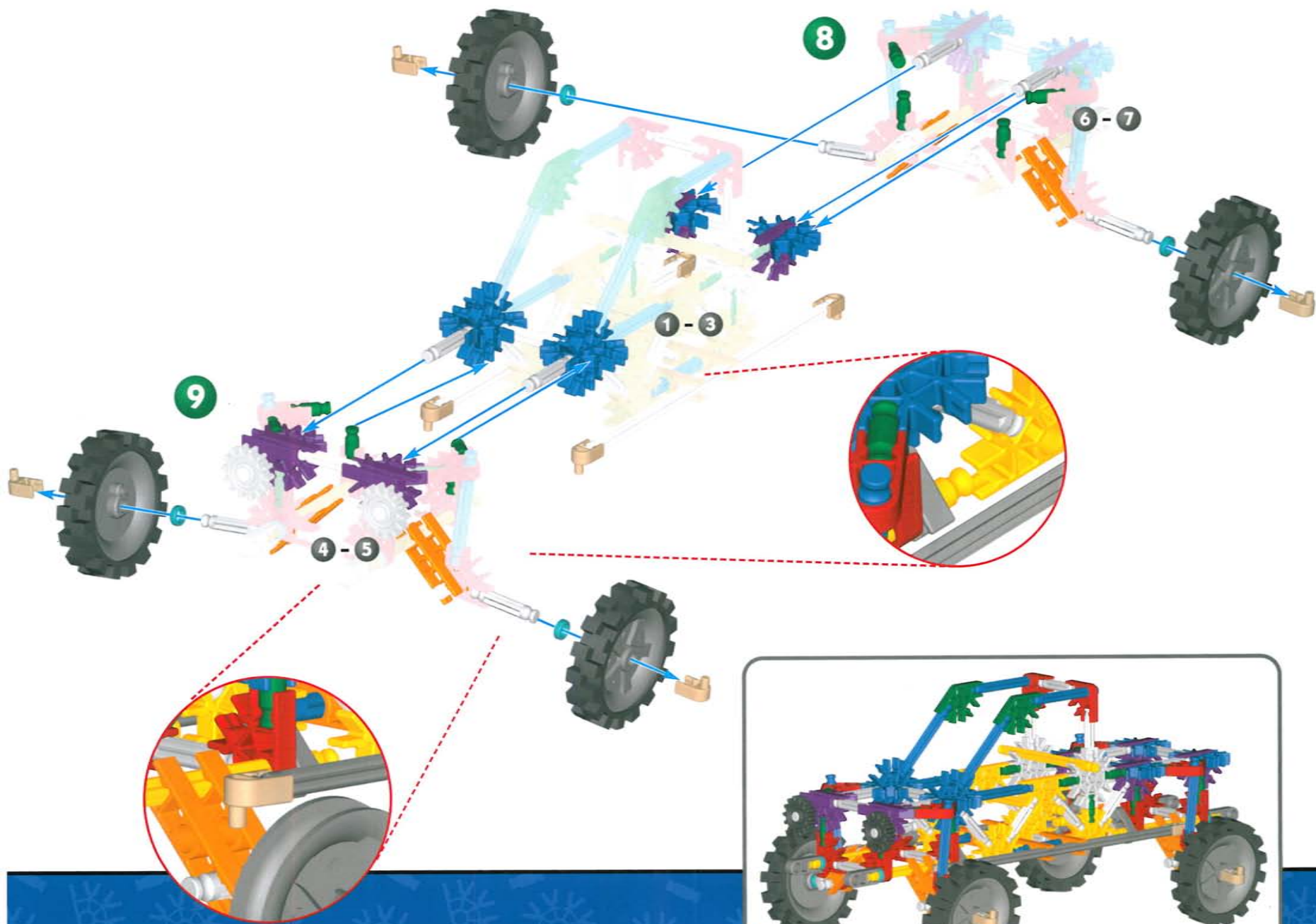

1 - 9

# Castle

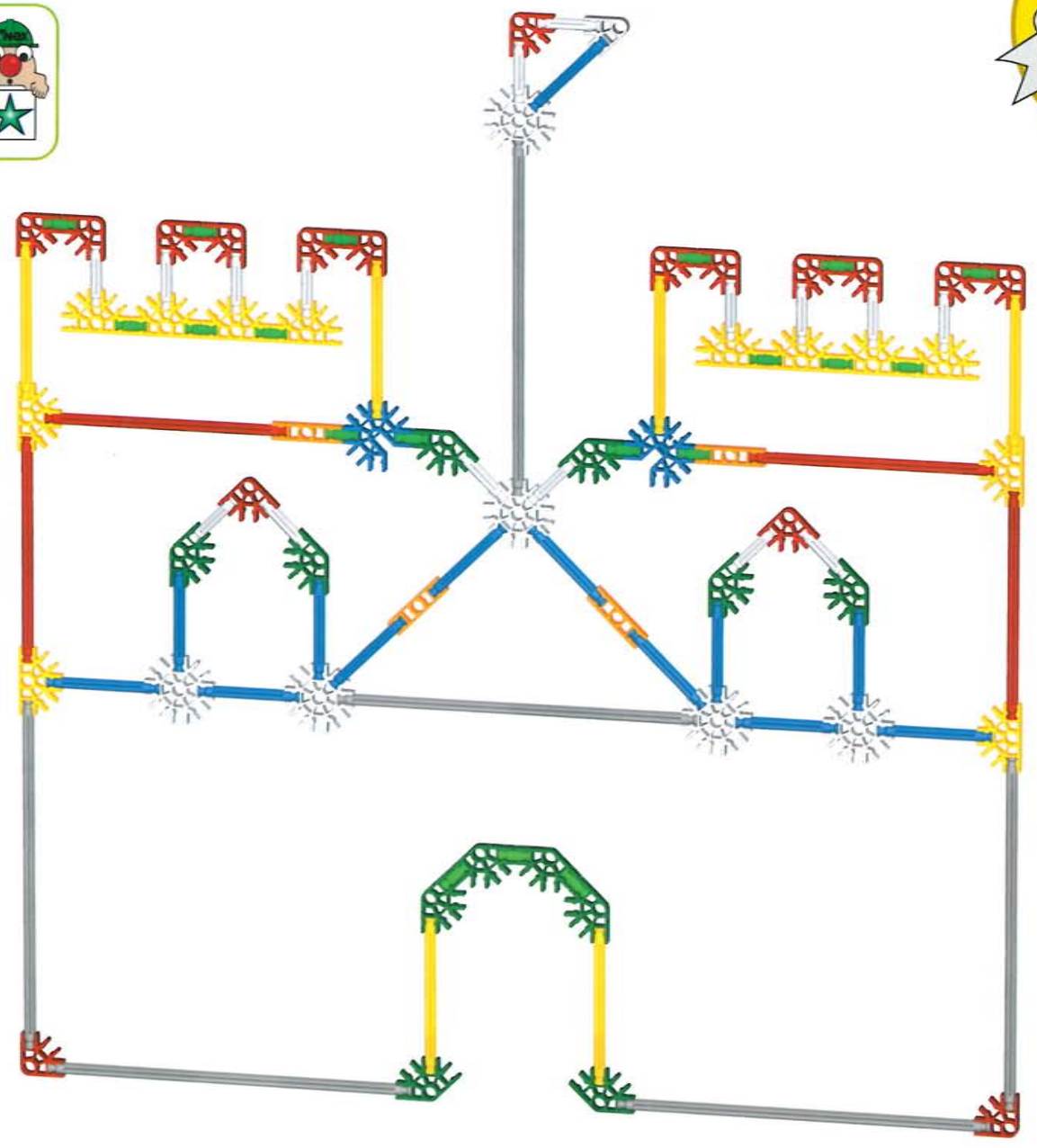



# Picture Frame

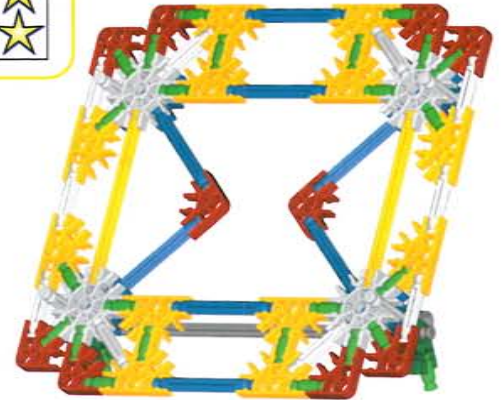

1

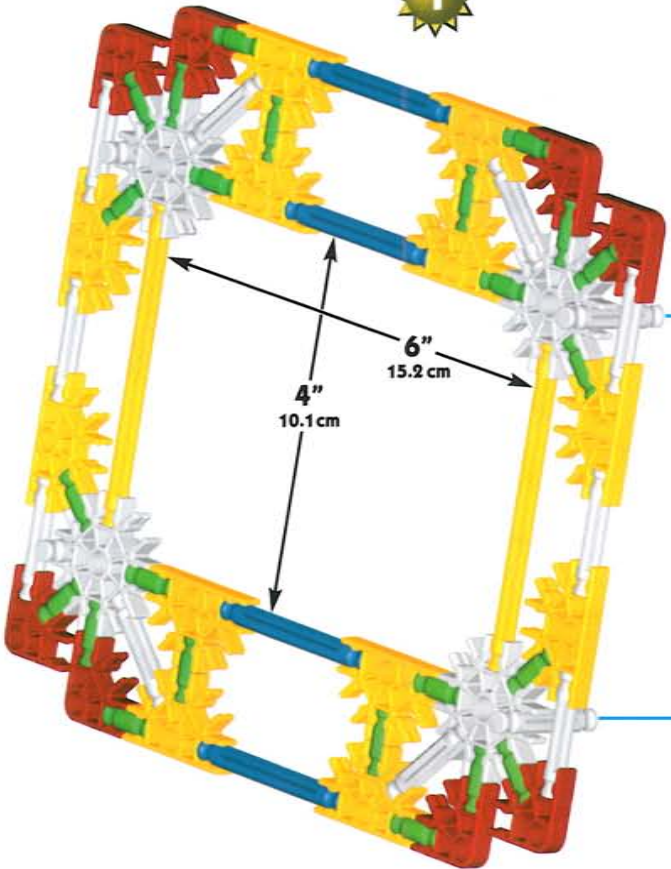

2

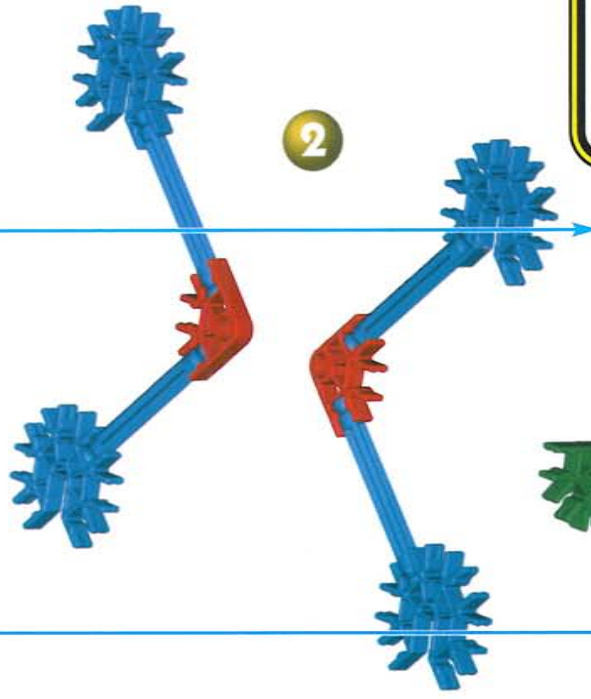

3



# Helicopter

**HOT**  
**2000**  
**PICKS**

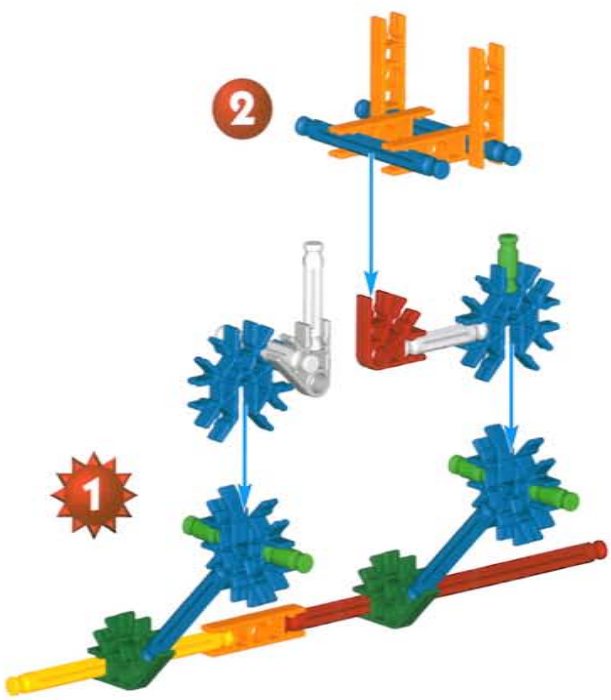
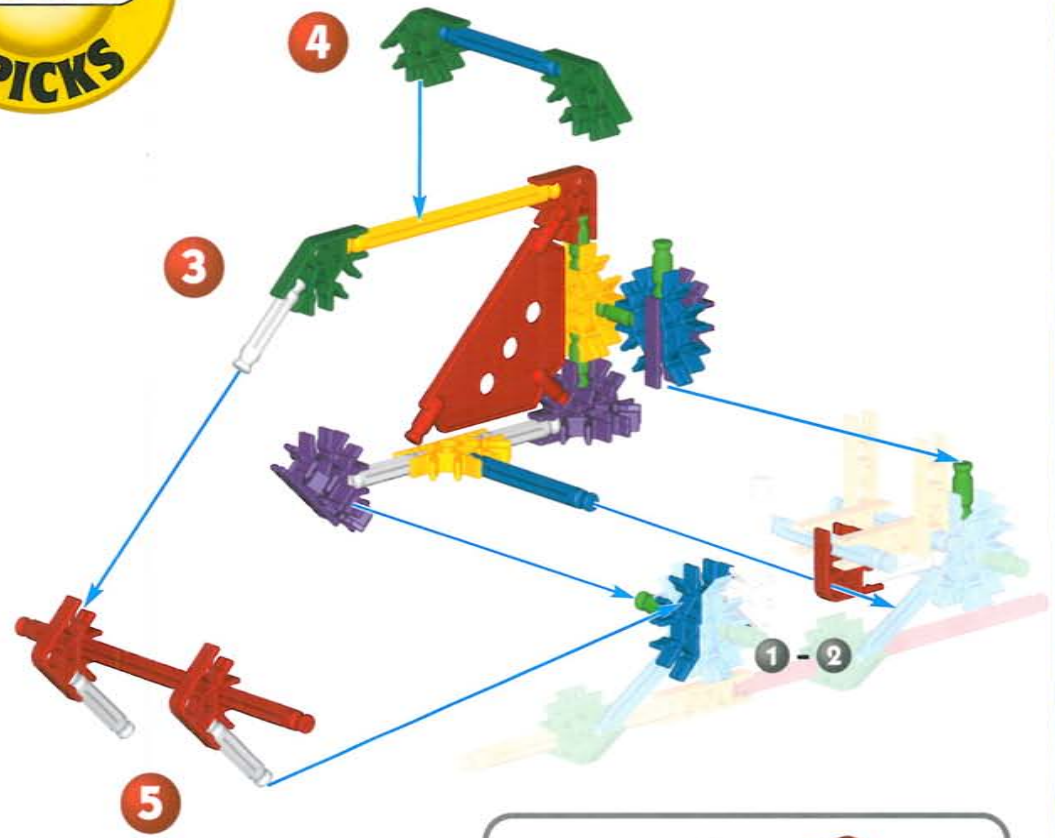
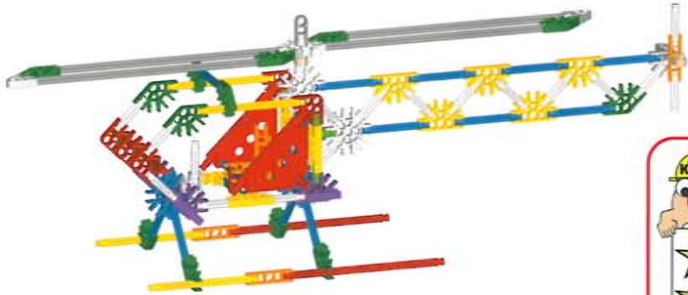

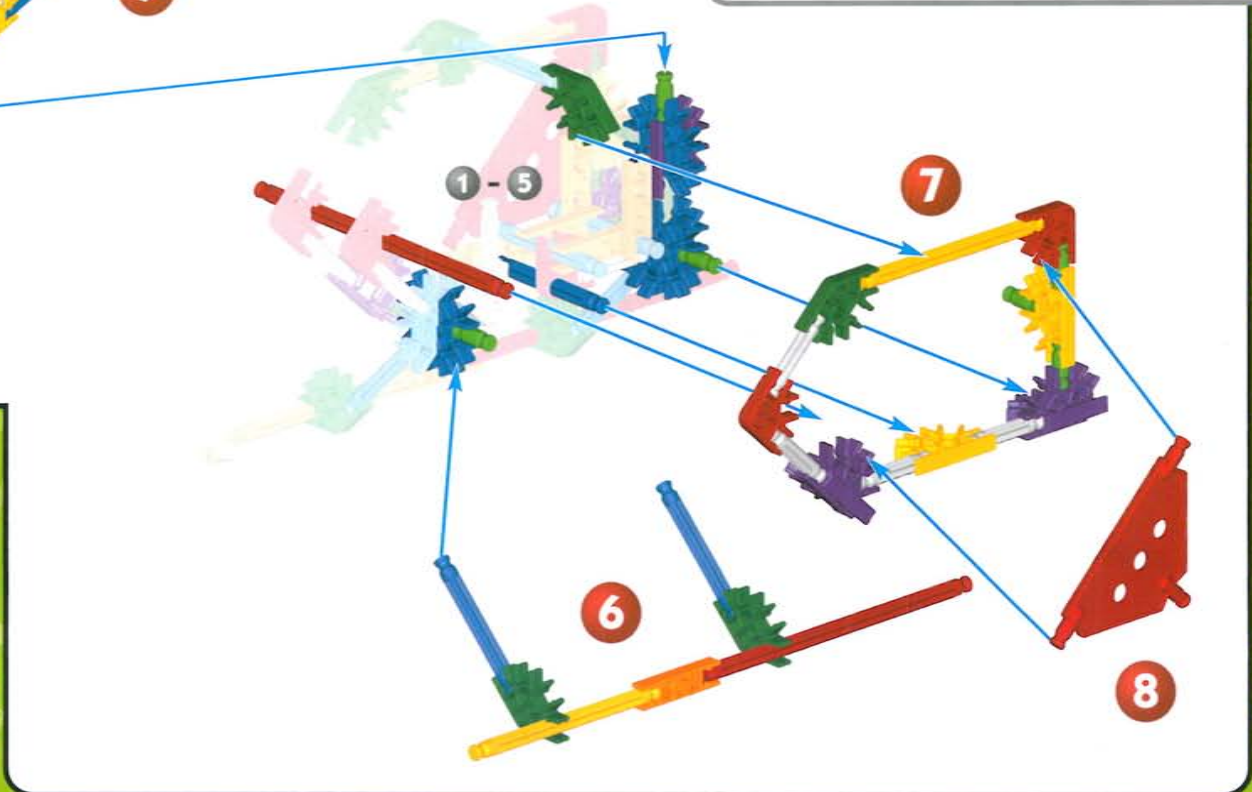
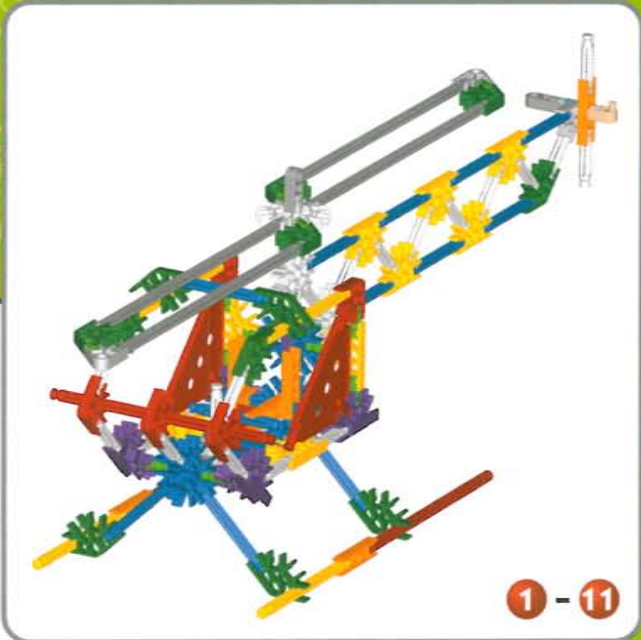
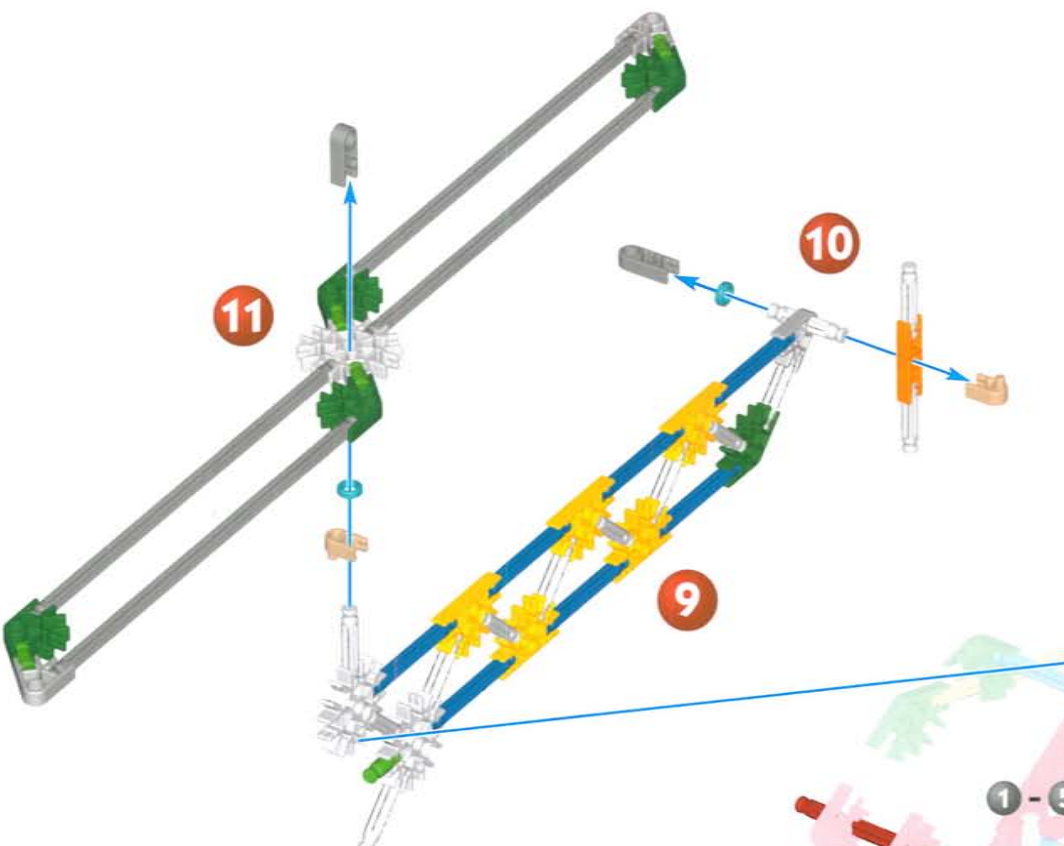

# Mini Carousel

**HOT**  
**2000**  
**PICKS**

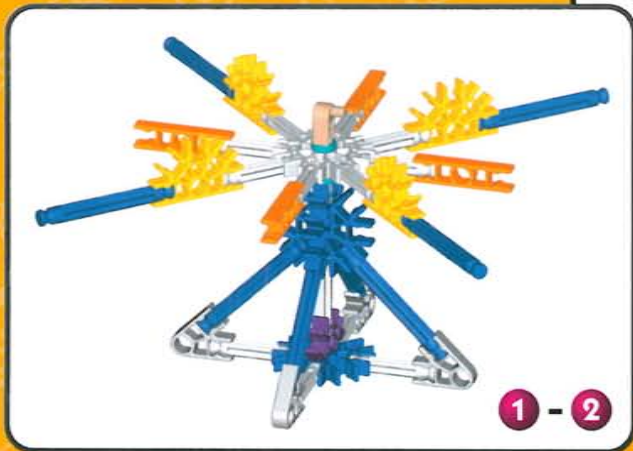
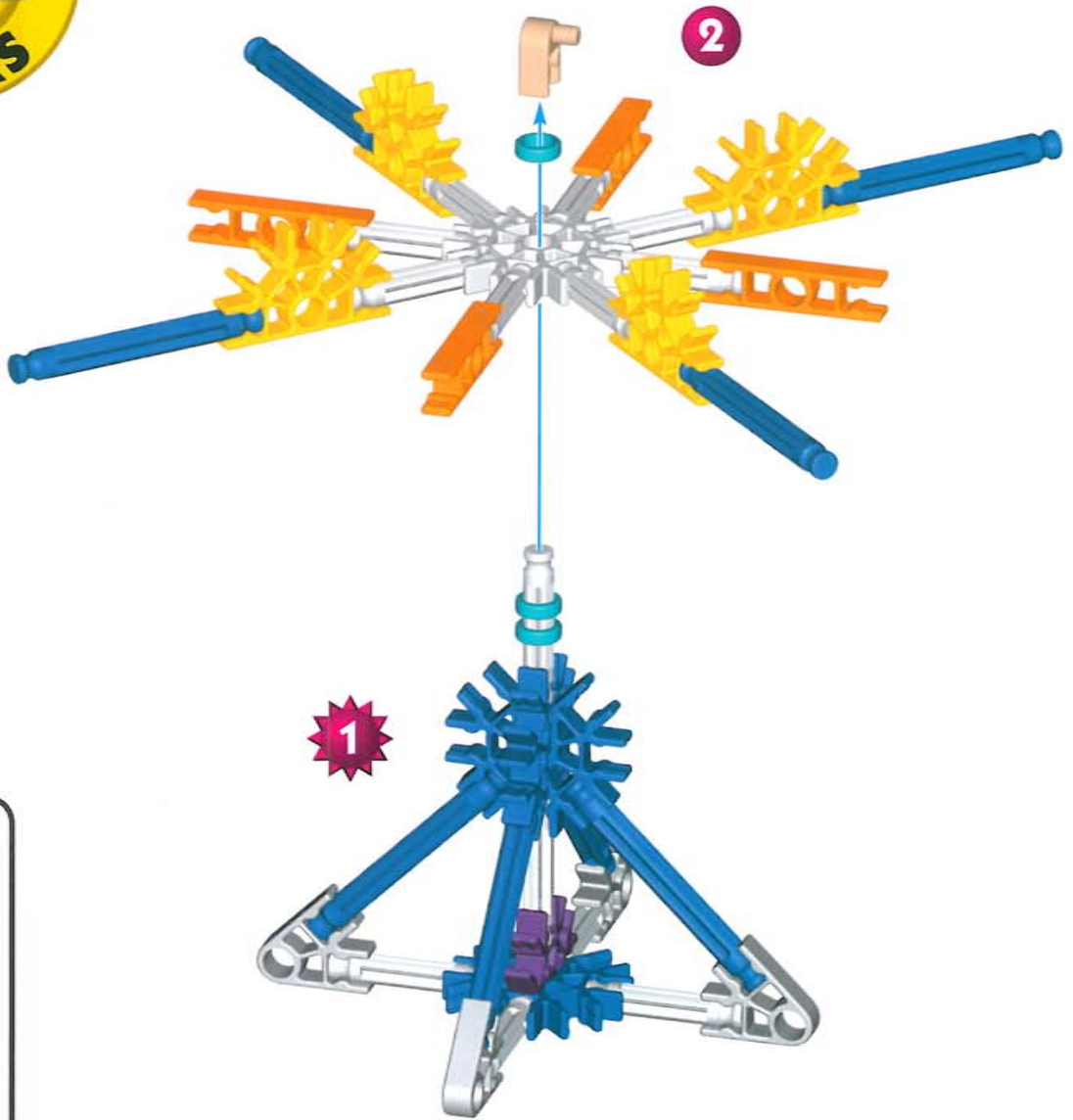
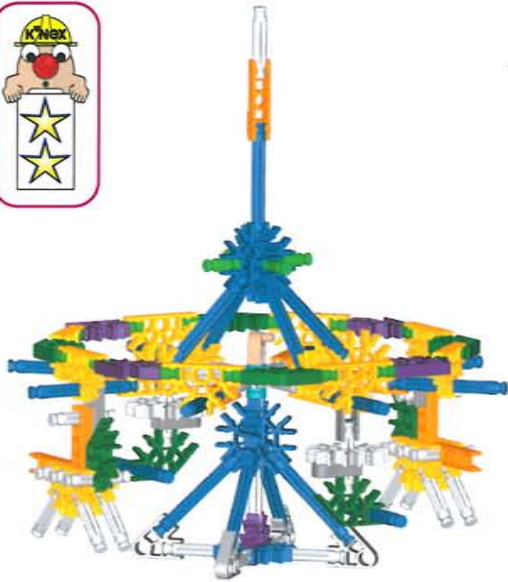

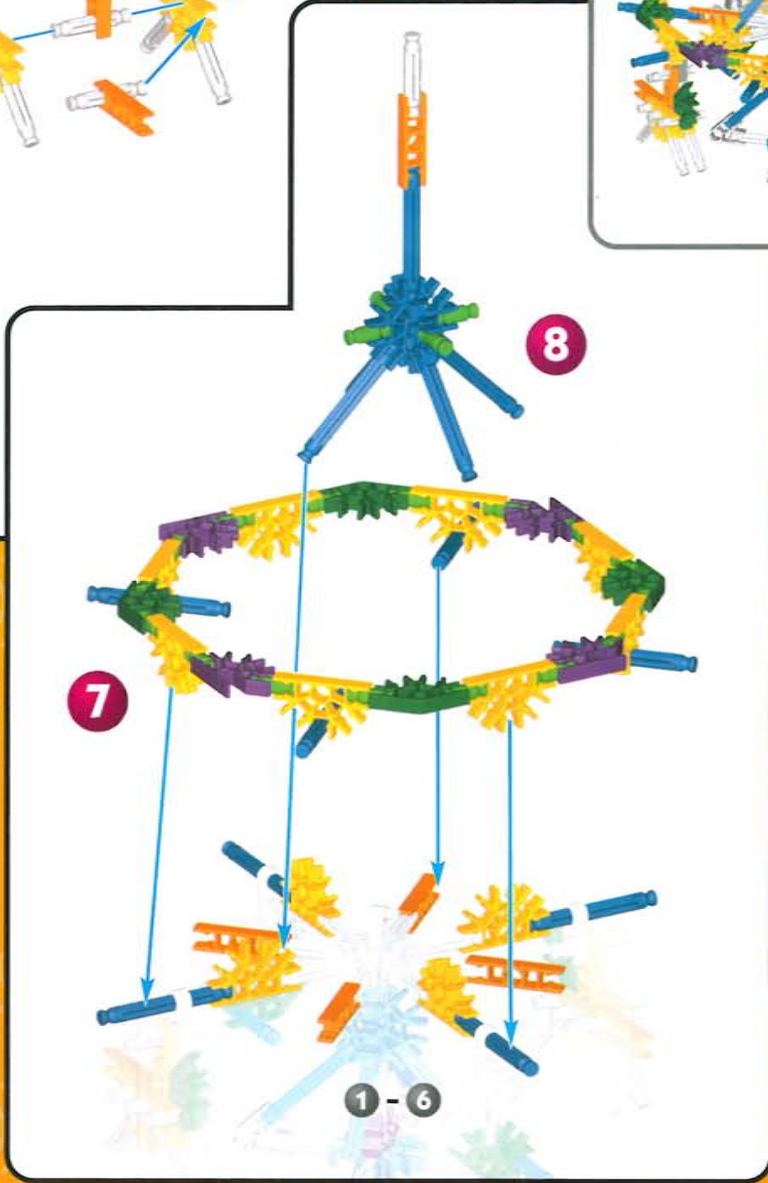
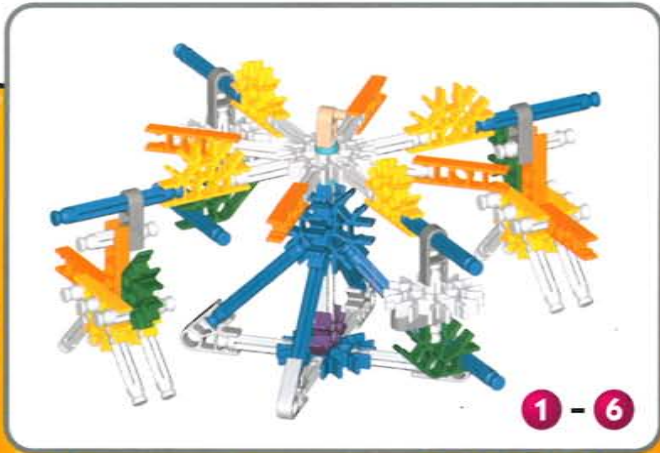
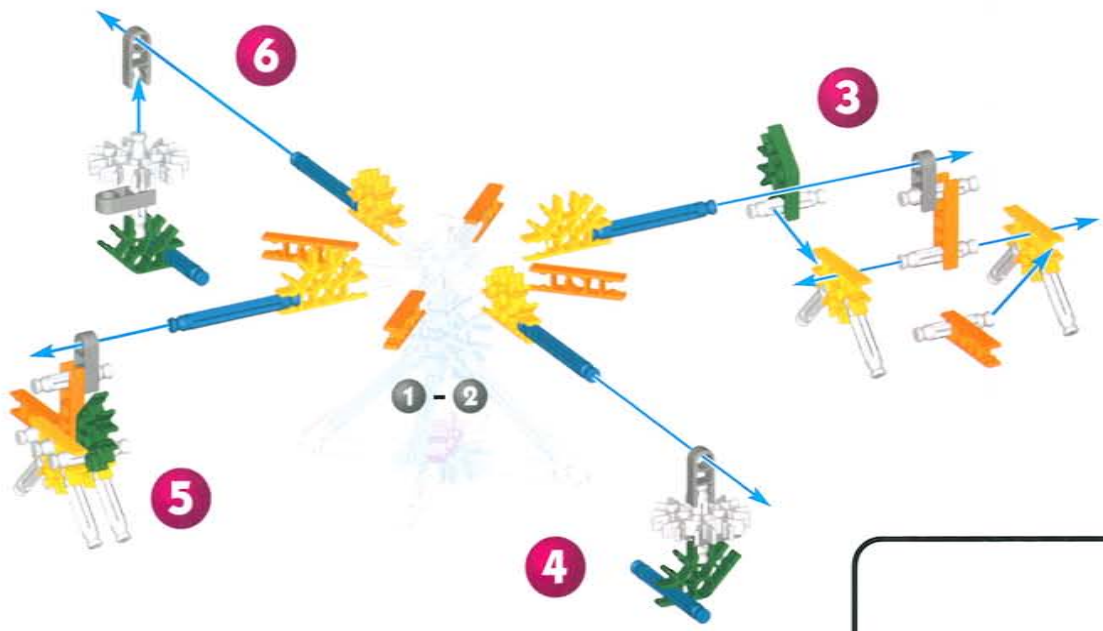

# Flat Frog

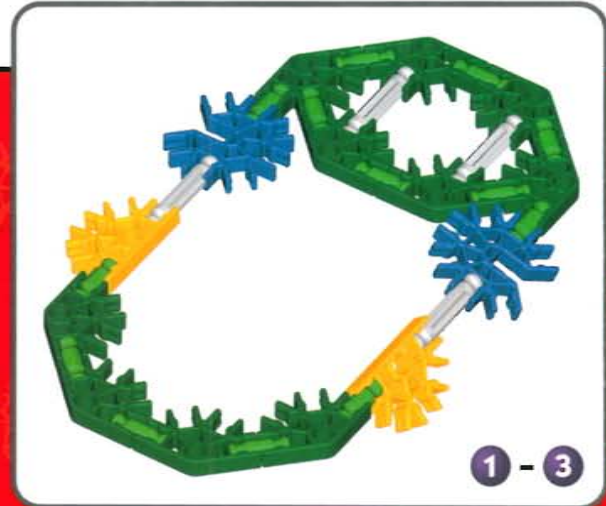
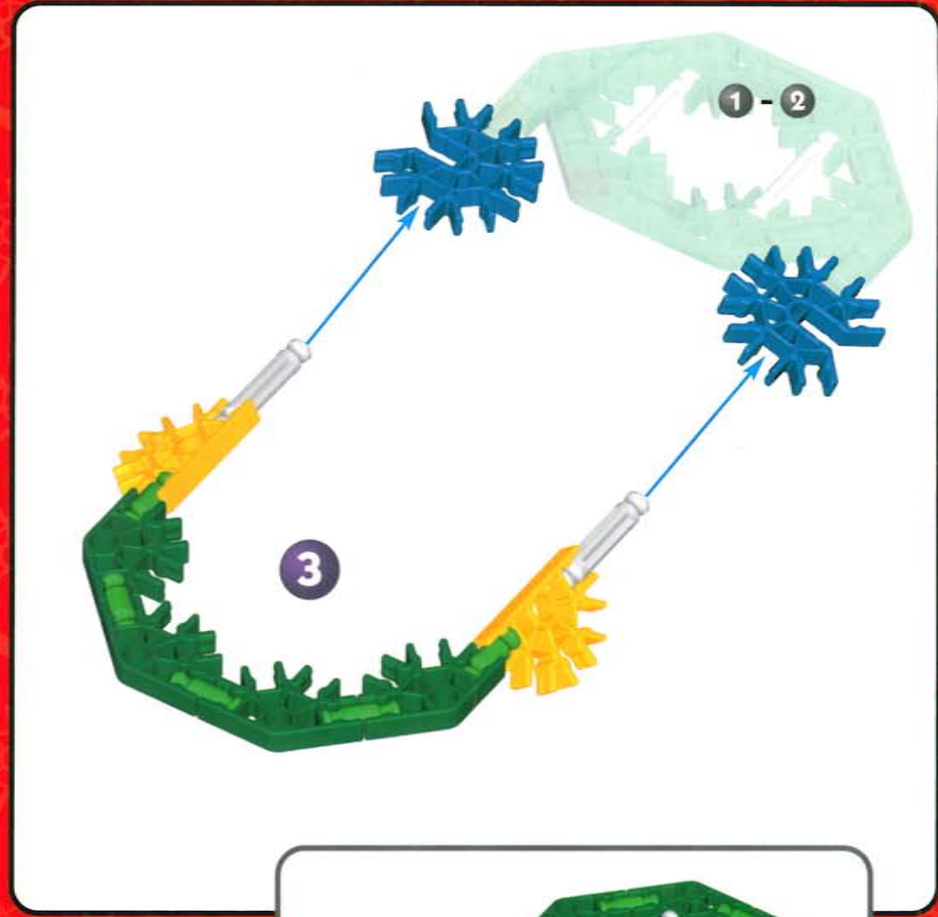
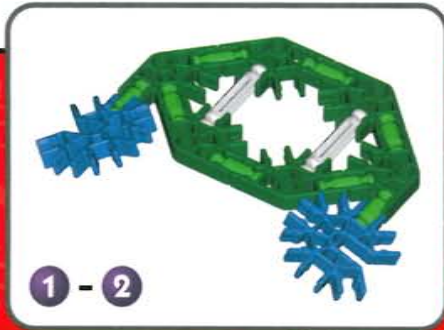
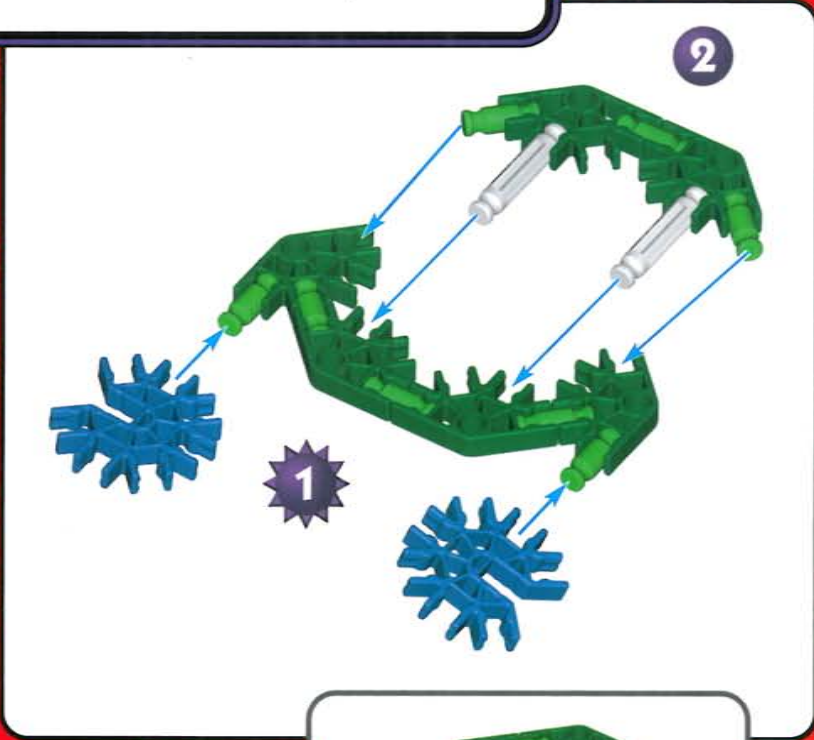

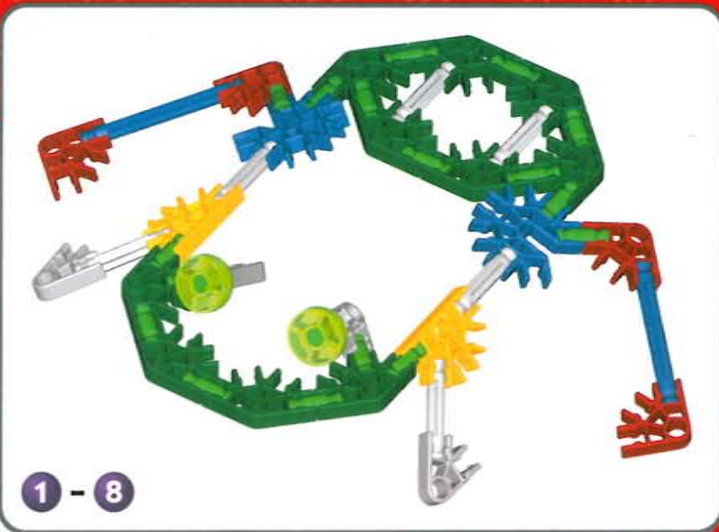
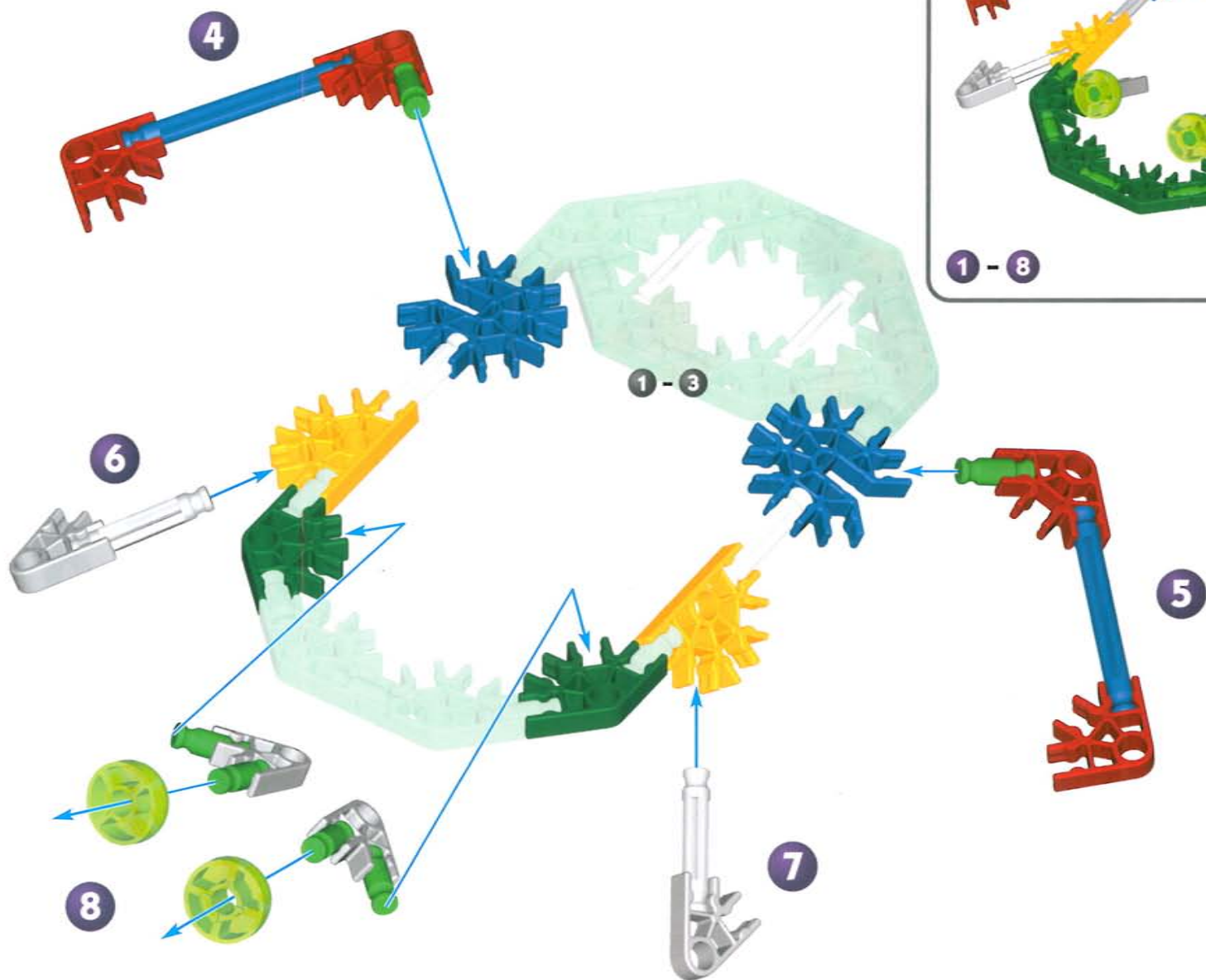

# Windmill

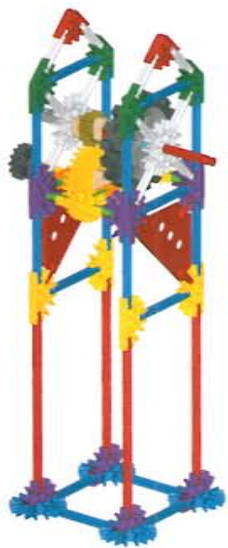
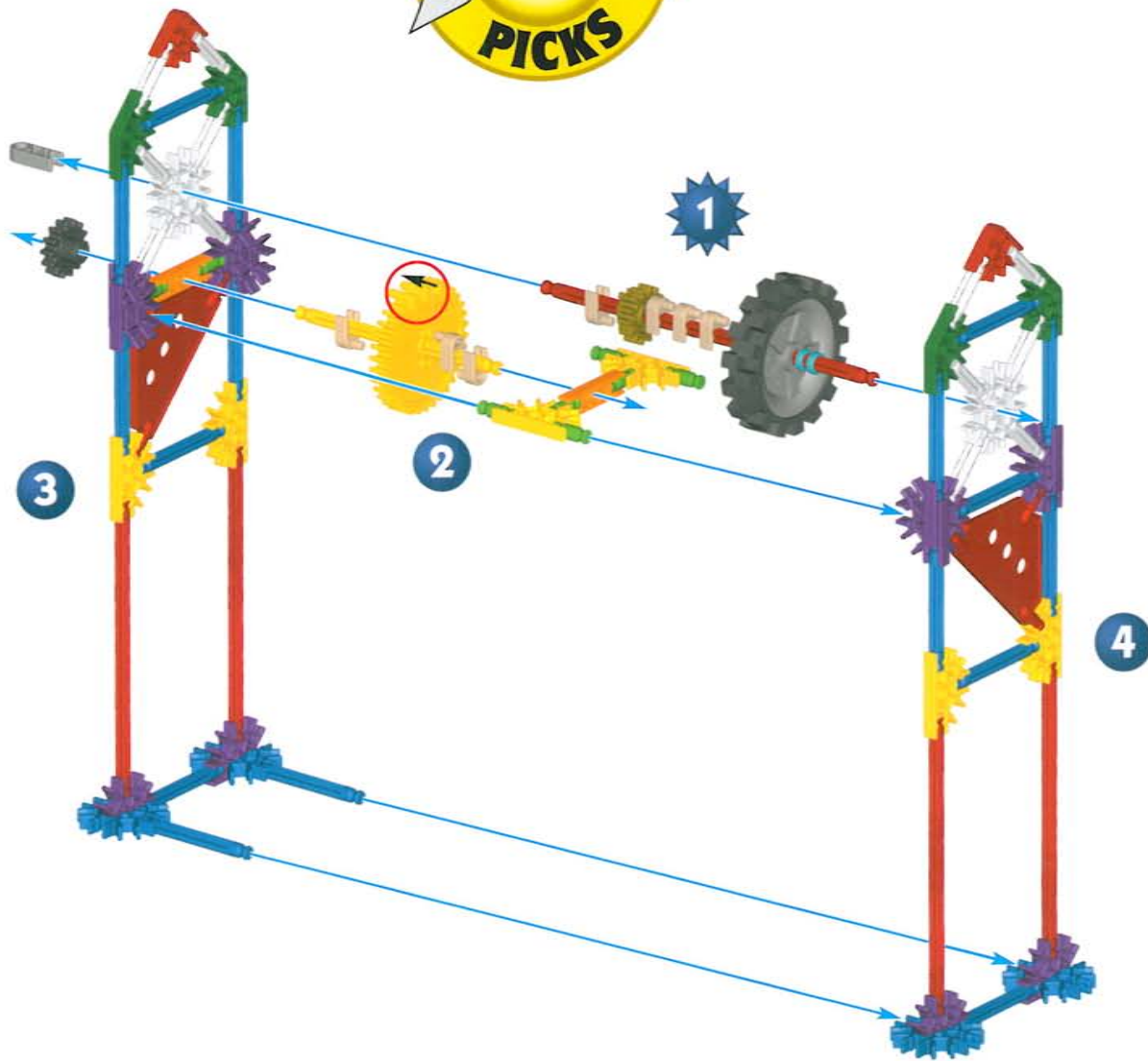
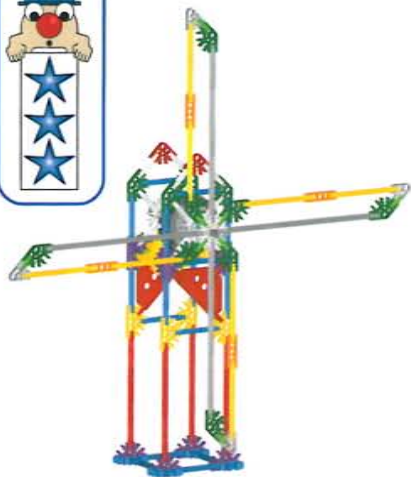

1 - 4

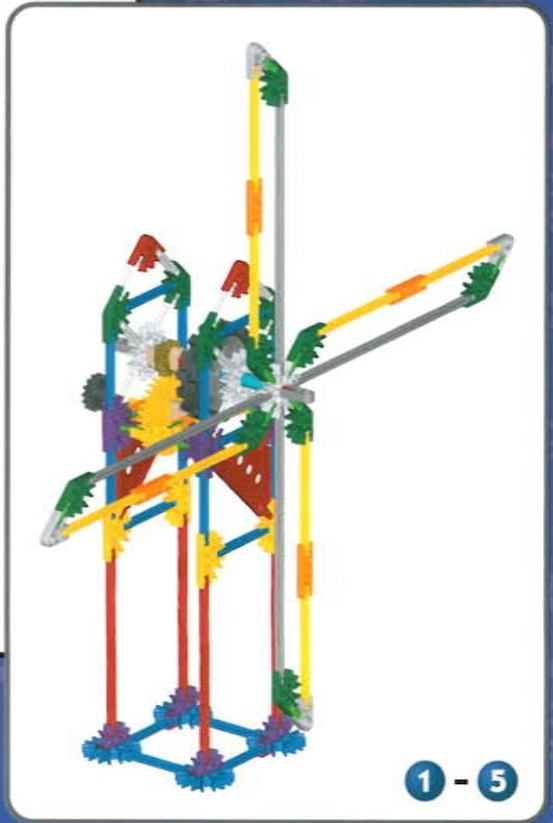
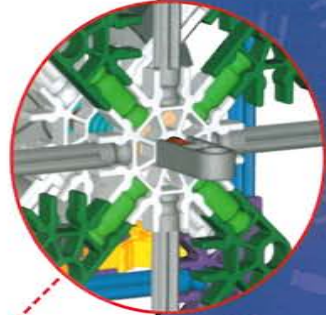
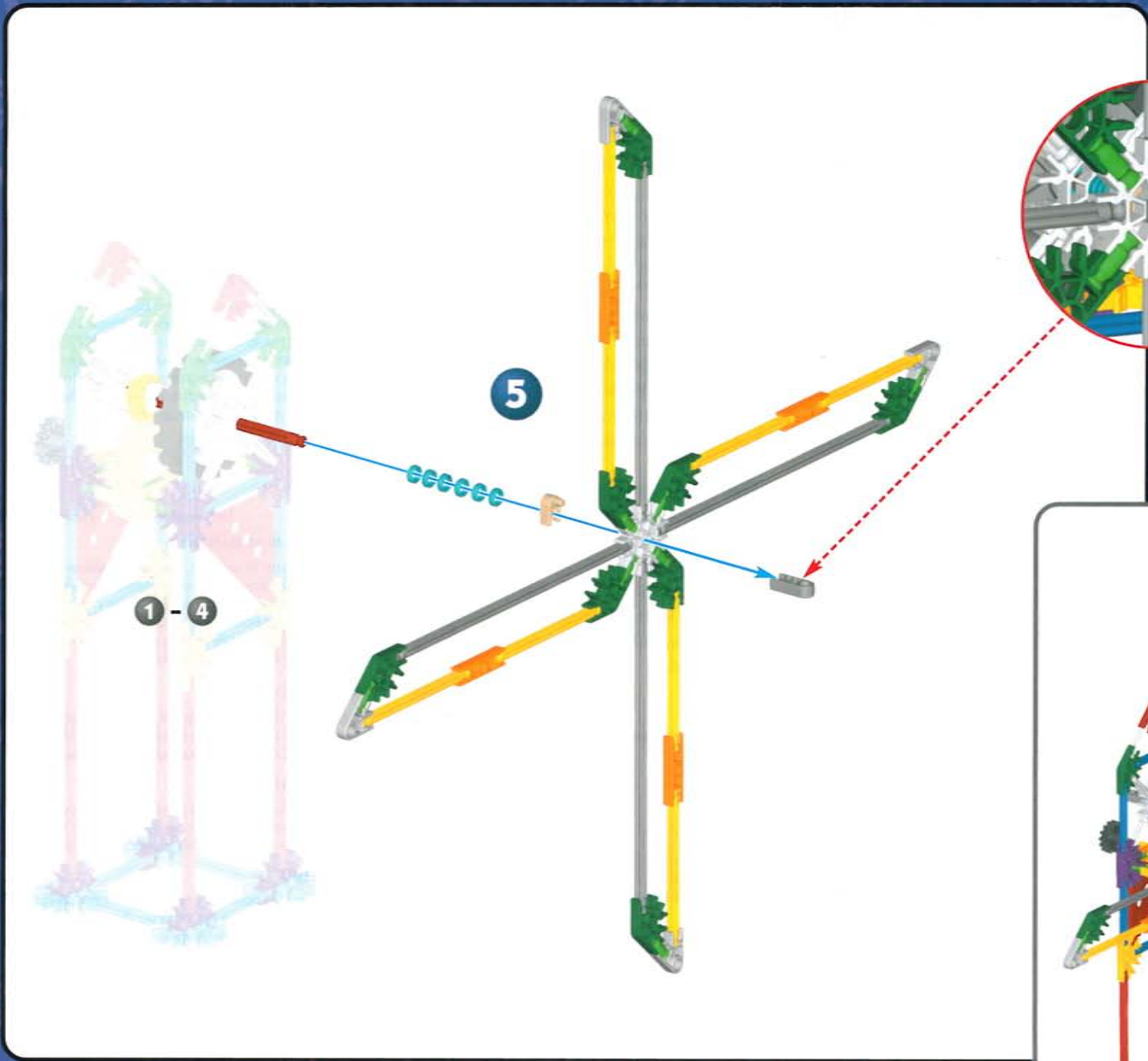

## What's Included

Before you start building, be sure to compare the parts in your case with the parts listed below. If anything is missing, check out the back cover of this instructions booklet for how to contact us. We're here to help!

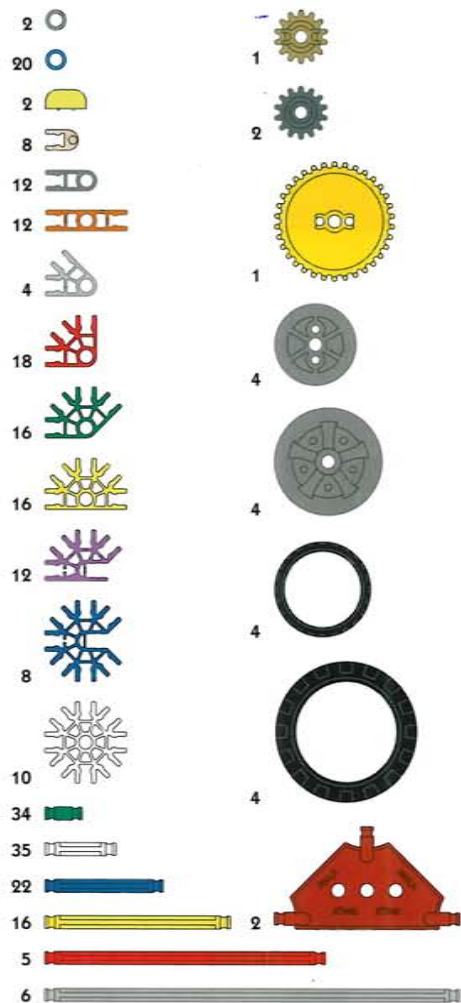

## What's Next?

Congratulations, you've mastered this K'NEX Building Set! But don't forget some of the best ideas come from your own imagination.

**What other things can you think of to build?** Begin with the models you made from this set and turn them into your own designs by changing parts around. It's that easy. What can you come up with? Change the color of your **Dragster** by using different K'NEX parts. Change the design of your **Picture Frame** into a different shape. You can even turn the models into something totally different. Turn the **Space Shuttle** into an **Airplane** or the **Owl** into a **Hawk!** For ideas, look around the room or outside your window and try to build what you see. You can with K'NEX!

**What's next after the models are built?** Show them off to your family and friends or find new ways to play with your K'NEX models using other toys or things around the house. For example, make "people" out of construction paper to ride on your **Mini Ferris Wheel** or build a tree out of popsicle sticks for your **Owl** to perch on. What ideas can you think of?



**Bonjour!**

**F** Le plaisir va commencer! J'ai conçu le système de construction K'NEX pour des enfants comme toi—des enfants qui veulent construire d'une façon tout à fait différente. À l'aide de nos tiges qui s'enclenchent, de connecteurs et d'instructions à code de couleur, tu peux construire et monter les modèles que nous avons conçus—ou bien, tu peux utiliser ton imagination et construire de fabuleux modèles de ta création personnelle! C'est ce que représente K'NEX—se former une idée et la réaliser. Je l'ai fait moi-même quand j'ai inventé K'NEX!

Joel Glickman  
Inventeur de K'NEX

Construis-en autant que tu peux n'est à toi de voir! Construis le Mini Carrousel, le Ring Toss, le Wind Surfer, la Motorcycle et d'autres choses encore!

Laisse-toi emporter par les joies de la construction avec ce Special Edition Tub de K'NEX! La série comprend des instructions pour construire quelques-uns des modèles K'NEX qui ont remporté le plus de succès ces dix dernières années! Suis les instructions pour construire des véhicules, des créatures, des manèges et bien d'autres choses encore, ou bien fais appel à ton imagination et laisse-lui libre cours! En tout cas, prépare-toi à bien t'amuser!

### Montage avec K'NEX

**1.** Bonjour! Je suis là pour t'aider à monter ton K'NEX. Les directives de ce livret vont t'aider à construire 10 modèles, te mettant sur la voie pour devenir un K'NEXpert! Tu trouveras des modèles pour trois niveaux de difficulté. Cherche-moi sur la boîte avant de construire, je brandis un panneau pour t'indiquer le niveau de difficulté de chaque modèle...Regarde:



Défi amical



Défi modéré



Plus grand défi

### Prépare-toi à construire

**2.** Pour commencer le modèle, trouve le numéro et suis les chiffres. Chaque pièce a sa propre forme et couleur. Il suffit de regarder l'illustration, de trouver les pièces dans ton jeu qui correspondent à ce que tu vois et de les enclencher. Essaie de tenir le modèle dans le même sens que dans l'illustration. Ainsi, les pièces seront attachées correctement.

### Continuation

**3.** Les couleurs affaiblies indiquent que cette partie est déjà montée. Tu dois raccorder la nouvelle partie à l'endroit indiqué par les flèches. Ces pièces seront en pleine couleur.

### Pièces d'écartement

**4.** Il y a des endroits dans ton modèle où tu dois ajouter des pièces d'écartement bleues et argentées. Assure-toi d'utiliser la couleur exacte et de compter les pièces avec soin.

### Connecteurs

**5.** Tu trouveras des connecteurs bleus et violets comportant des fentes extra-longues. Ils se glissent l'un dans l'autre tel qu'illustré. Pousse les pièces ensemble jusqu'à ce que tu entendes un "clac".

### Et après ?

Félicitations, tu maîtrises désormais les K'NEX Building Set! Mais n'oublie pas que les meilleures idées sortent parfois tout droit de ton imagination.

Que peux-tu bien construire d'autre? Commence par les modèles que tu as construits à partir de cette série et transforme-les en changeant les pièces de place. Ce n'est pas plus difficile que

cela. Que peux-tu inventer toi ? Change la couleur de ton Dragster en utilisant différentes pièces K'NEX. Change le motif de ton Picture Frame et donne-lui une autre forme. Tu peux même complètement transformer les modèles. Transforme la Space Shuttle en Airplane ou l'Owl en Hawk ! Si tu es à court d'idées, regarde dans ta chambre ou par la fenêtre et essaie de construire des choses que tu vois. Avec K'NEX, c'est possible !

Des modèles une fois construits, qu'est-ce qui se passe ? Montre les à ta famille et tes amis ou bien trouve d'autres façons de jouer avec tes modèles K'NEX en te servant d'autres jouets ou d'objets qui traînent chez toi. Tu peux par exemple, fabriquer des « personnages » avec du papier de couleur et leur faire faire des tours sur ta Mini Ferris Wheel ou fabriquer un arbre à l'aide de bâtonnets de glace pour que ton Owl puisse se percher dessus. Que peux-tu bien imaginer d'autre ?

### E Qué se incluye

Antes de empezar a construir, asegúrate de comparar las partes que hay en tu caja con las partes que hoy en la lista de la página 4. Si alguna cosa falta, en la contraportada de este folleto de instrucciones encontrarás la manera de ponerte en contacto con nosotros. ¡Estamos aquí para ayudarte!

### Construcción con K'NEX

1. ¡Hola! Soy tu compañero en la construcción. Las instrucciones que ves en este libro te ayudarán a construir diez modelos que te pondrán en camino de ser un K'NEXpert. Encontrarás modelos para tres niveles de construcción. Búscame antes de cada construcción, estaré sosteniendo un cartel que te dirá cuánto puede ser difícil.



### Todo listo, comienza a construir

1. Para comenzar tu modelo, busca el y sigue los números. Cada pieza tiene su propia forma y color. Simplemente mira los dibujos, busca las piezas correspondientes en tu juego y después conéctalas. Mientras construyes, trata de colocar tu modelo en la misma dirección que se muestra en las instrucciones.

### Continúa

1. Los colores desteñidos muestran que esta sección ya está construida. Conecta las nuevas secciones en los lugares señalados por las flechas. Las nuevas piezas que agregues estarán en colores vivos.

### Espaciadores

1. Hay lugares en tu modelo donde tendrás que agregar espaciadores azules y plateados. Cerciérate de usar el color correcto y cuéntalos con cuidado.

### Conectores

1. Hay conectores azules y plateados con ranuras largas especiales. Se enganchan deslizándose como ves en los dibujos. Conecta estas piezas empujándolas hasta que oigas "clic".

### D Inhalt

Bevor du mit dem Bau beginnst, solltest du unbedingt die Teile in deinem Baukasten mit denen, die auf Seite 4 aufgelistet sind, vergleichen. Bitte setze dich mit uns in Verbindung, falls der Inhalt unvollständig ist (siehe Rückseite dieser Broschüre). Wir helfen dir dann!

### Bauen mit K'NEX

1. Hallo, ich bin dein K'NEX-Bauhelfer. Die Anleitungen in diesem Heft helfen dir 10 Modelle zu bauen, damit du ein K'NEXperte werden kannst! Es gibt drei Schwierigkeitsstufen. Schau nach mir bevor du mit dem Bau eines Modells beginnst. Auf einem Schild zeige ich dir den Schwierigkeitsgrad für jedes Modell:



einfach



mittel



schwieriger

### Achtung - und los geht's

2. Um mit dem Bau deines Modells zu beginnen, suchst du zuerst das Teil mit der Nummer , dann das mit der Nummer 2 und so weiter. Jedes Teil hat eine bestimmte Form und Farbe. Schau einfach auf das Bild und suche dann die gleichen Teile in deinem Bausatz. Dann steckst du die Teile zusammen. Am besten ist es, wenn du die Teile im selben Winkel hältst, wie in der Abbildung, damit du sie an der richtigen Stelle anbringst.

### Und weiter geht's

3. An den blassen Farben kannst du erkennen, welcher Teil bereits fertig ist. Das neue Teil gehört da hin, wo Pfeile hin zeigen. Dieser Teil ist in bunter Farbe.

### Abstandsstücke

4. An bestimmten Stellen in deinem Modell musst du Abstandshalter, sogenannte Spacer, einbauen. Diese Abstandshalter sind blau und silberfarben. Achte darauf, dass du die richtige Farbe wählst und dass du die richtige Anzahl davon verwendest.

### Verbindungsstücke

5. Blaue und silberfarbene Steckanschlüsse haben besonders lange Schlitze. Wie du auf der Abbildung sehen kannst, lassen sie sich ineinander schieben. Achte beim Aneinanderfügen dieser Teile darauf, dass du ein Klickgeräusch hörst. Erst dann sind die Teile fest miteinander verbunden.

### NL Wat zit erin

Voor je begint te bouwen, verzeker je ervan de onderdelen in je doos na te kijken ten opzichte van de op page 4 aangeduide onderdelen. Wanneer iets afwezig is, kijk naar de achterkant van dit boekje om contact met ons op te nemen. We zijn er om je te helpen!

### Bouwen met K'NEX

1. Hoii! Ik ben je K'NEX bouwvriend. De aanwijzingen in dit boekje zullen je helpen met 10 modellen te bouwen en om je op weg te brengen om een K'NEXpert te worden! Je vindt modellen voor drie bouwpeilen. Voor je begint te bouwen, kijk even naar me uit met mijn kenteken om je aan te tonen hoe moeilijk elk model zal zijn ... kijk maar:



Niet moeilijk



Nogal moeilijk



Zeker moeilijk

### Klaar - Bouwen maar

2. Om met je model te beginnen, zoek naar en volg de nummers. Elk onderdeel heeft dezelfde vorm en kleur. Kijk gewoonweg naar de afbeelding, vind in je geheel de stukken die overeenstemmen met wat je ziet en druk ze in mekaar. Tracht je model in dezelfde richting te behouden als op de afbeelding zodat je de stukken op de juiste plaats zult vastmaken.

### Verder ...

3. De vage kleuren duiden aan dat dit gedeelte reeds opgebouwd is. Het nieuwe deel moet aangebracht worden op de plaats waarop de peilen gericht zijn. Dit stuk zal in volle kleur aangetoond zijn.

### Afstandsstukken

4. In je model zijn er plaatsen waar blauwe en zilveren tussenstukken moeten toegevoegd worden. Verzeker je ervan de juiste kleur te gebruiken en tel ze zorgvuldig.

### Koppelstukken

5. Er zijn blauwe en zilveren koppelstukken met speciale lange gleuven. Ze schuiven in mekaar zoals je kunt zien op de afbeeldingen. Duw deze onderdelen in mekaar tot je een "klik" hoort.

US Printed in USA

Product and colors may vary.  
Models can be built one at a time.  
K'NEX is a registered trademark of K'NEX Industries, Inc.

Manufactured under U.S. Patents 5,061,219; 5,137,486; 5,199,919;  
5,238,438; 5,346,420; 5,350,331; 5,368,514; 5,421,762; 5,423,707;  
5,427,559; 5,518,435; D383,509; D388,475; D389,203; D391,843;  
D391,921; D392,555.

Other U.S. and foreign patents pending.  
Conforms to the Requirements of ASTM Standard Consumer  
Safety Specification on Toy Safety, F963-96a.

F Imprimerie aux USA

Le produit et les couleurs peuvent varier.  
La plupart des modèles peuvent être construits un à la fois.  
K'NEX est une marque déposée de K'NEX Industries, Inc.

Fabriqué sous brevets américains 5,061,219; 5,137,486; 5,199,919;  
5,238,438; 5,346,420; 5,350,331; 5,368,514; 5,421,762; 5,423,707;  
5,427,559; 5,518,435; D383,509; D388,475; D389,203; D391,843;  
D391,921; D392,555.

Autres brevets américains et étrangers en instance.  
Conforme aux spécifications de sécurité du consommateur  
sur la sécurité des jouets de la norme ASTM F963-96a.



US 1-800-KID-KNEX US/Canada only (English only)

GB 00800-22427276 UK/Ireland only

F E D NL 001-215-996-4823



US Consumer Services  
K'NEX Industries, Inc.  
P.O. Box 700  
Hatfield, PA 19440-0700



GB K'NEX  
Newport Consumer Services  
Hasbro UK Ltd., Caswell Way  
Newport, Gwent NP9 0YH



[www.knex.com](http://www.knex.com)



[email@knex.com](mailto:email@knex.com)



©2003 K'NEX Industries, Inc.  
P.O. Box 700  
Hatfield, PA 19440-0700

403552.11-V1-5/03