

Serpent's Spiral Coaster™

**BUILDING  
IDEA**

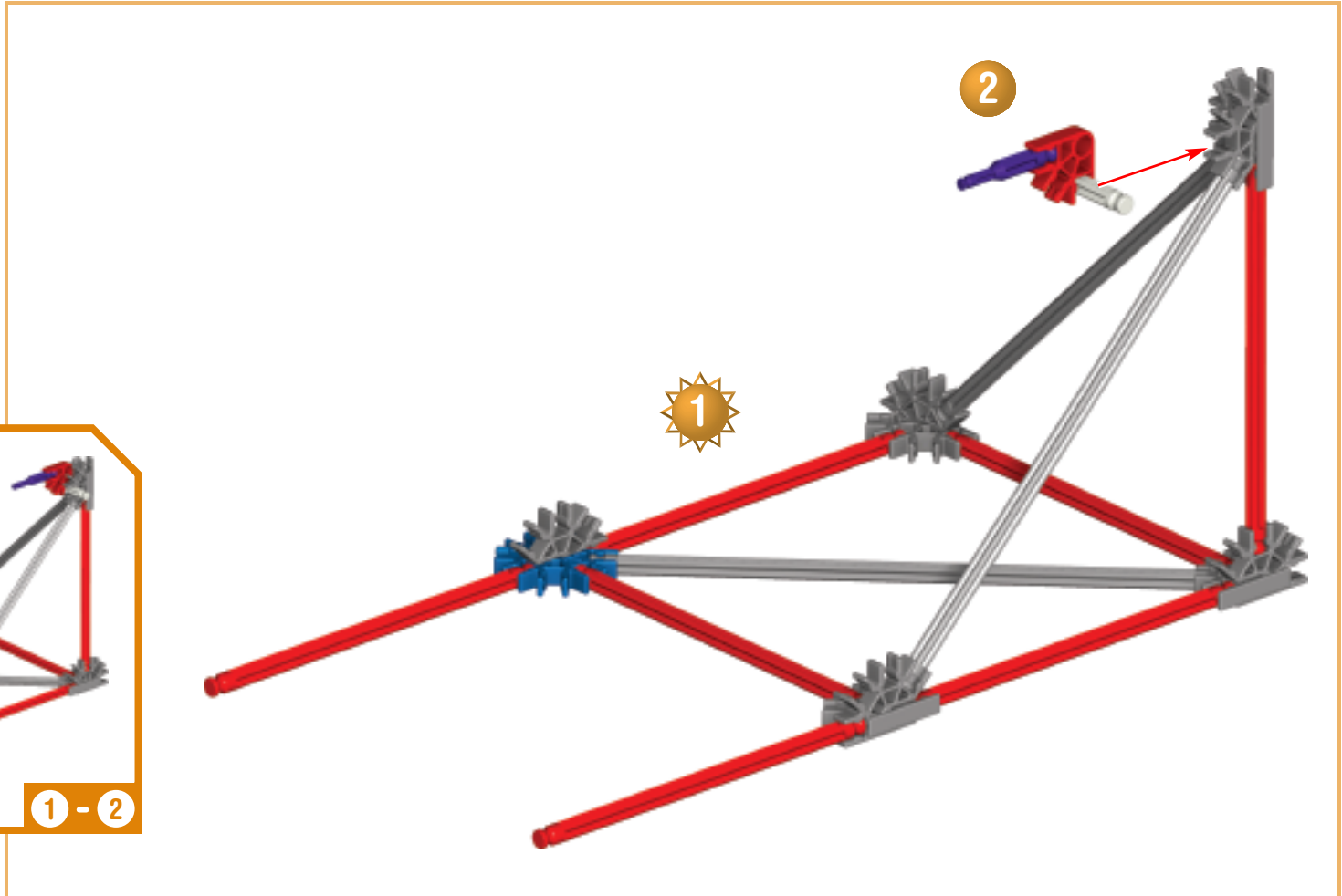

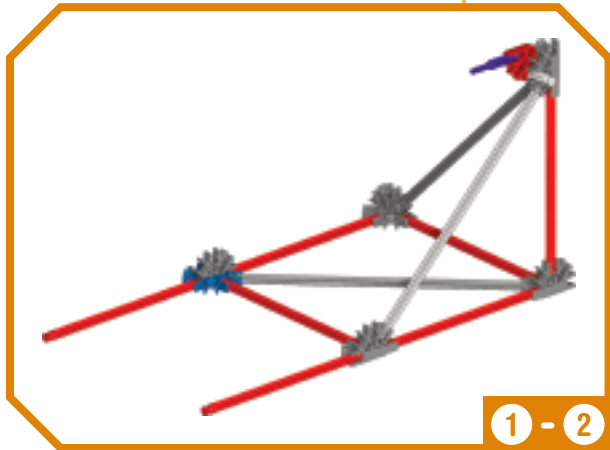

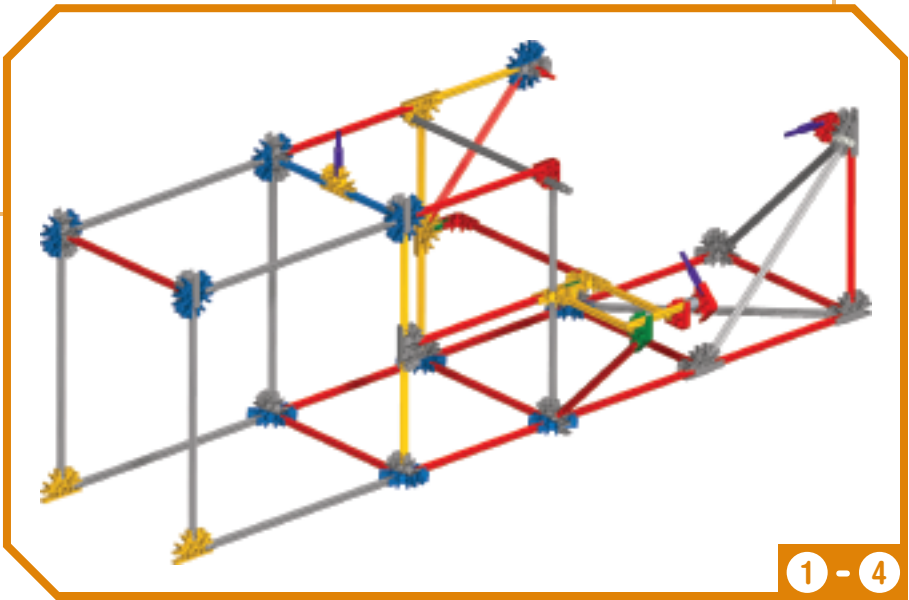
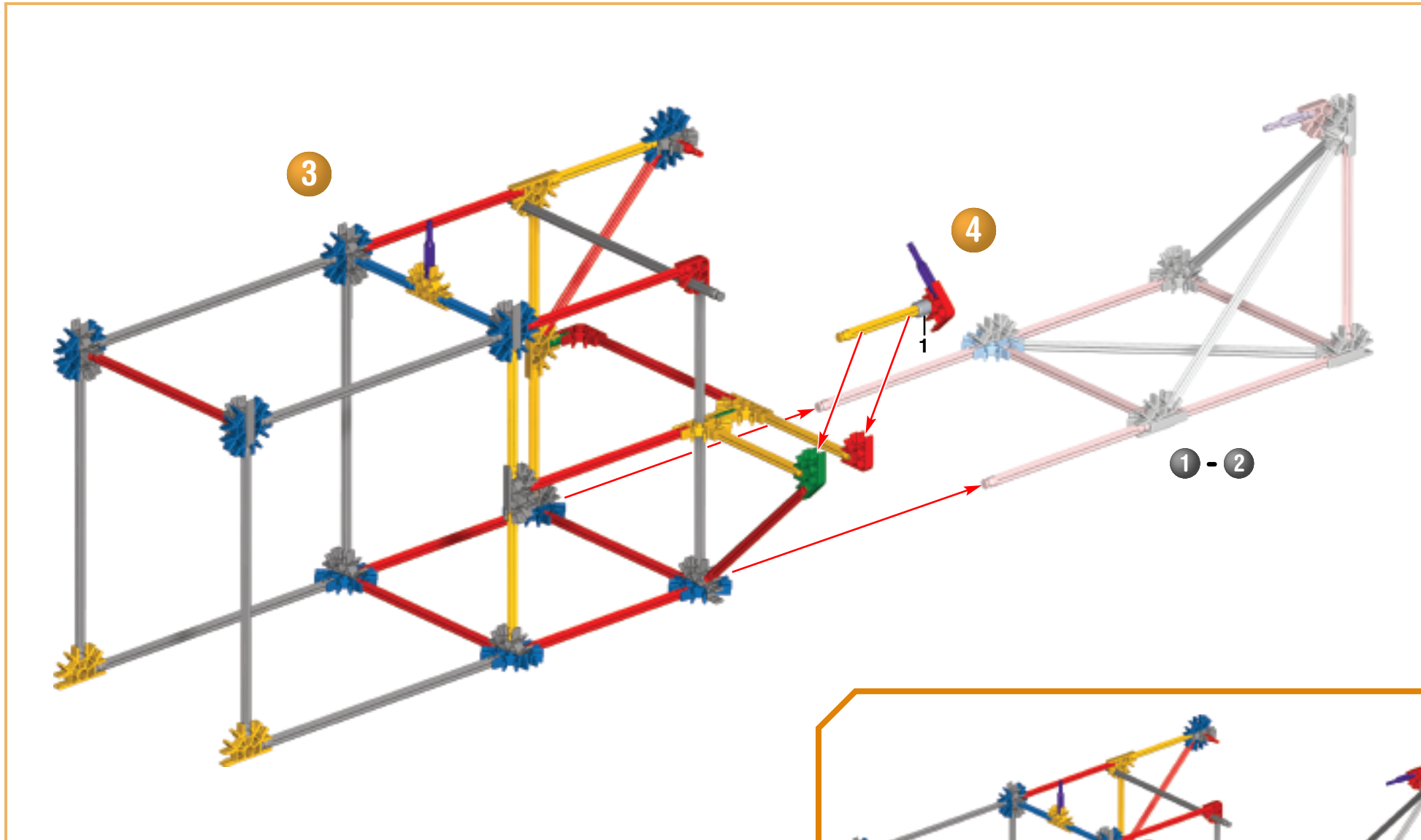
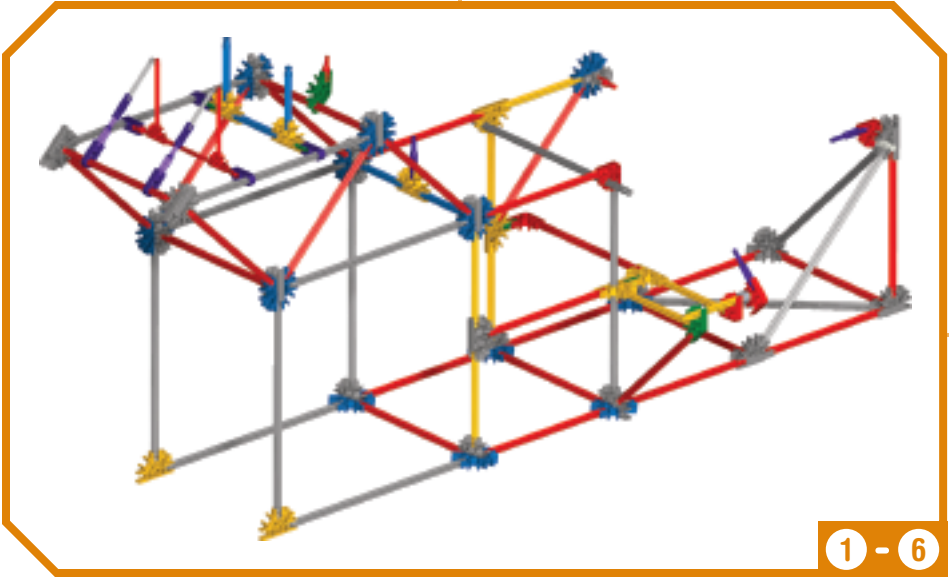
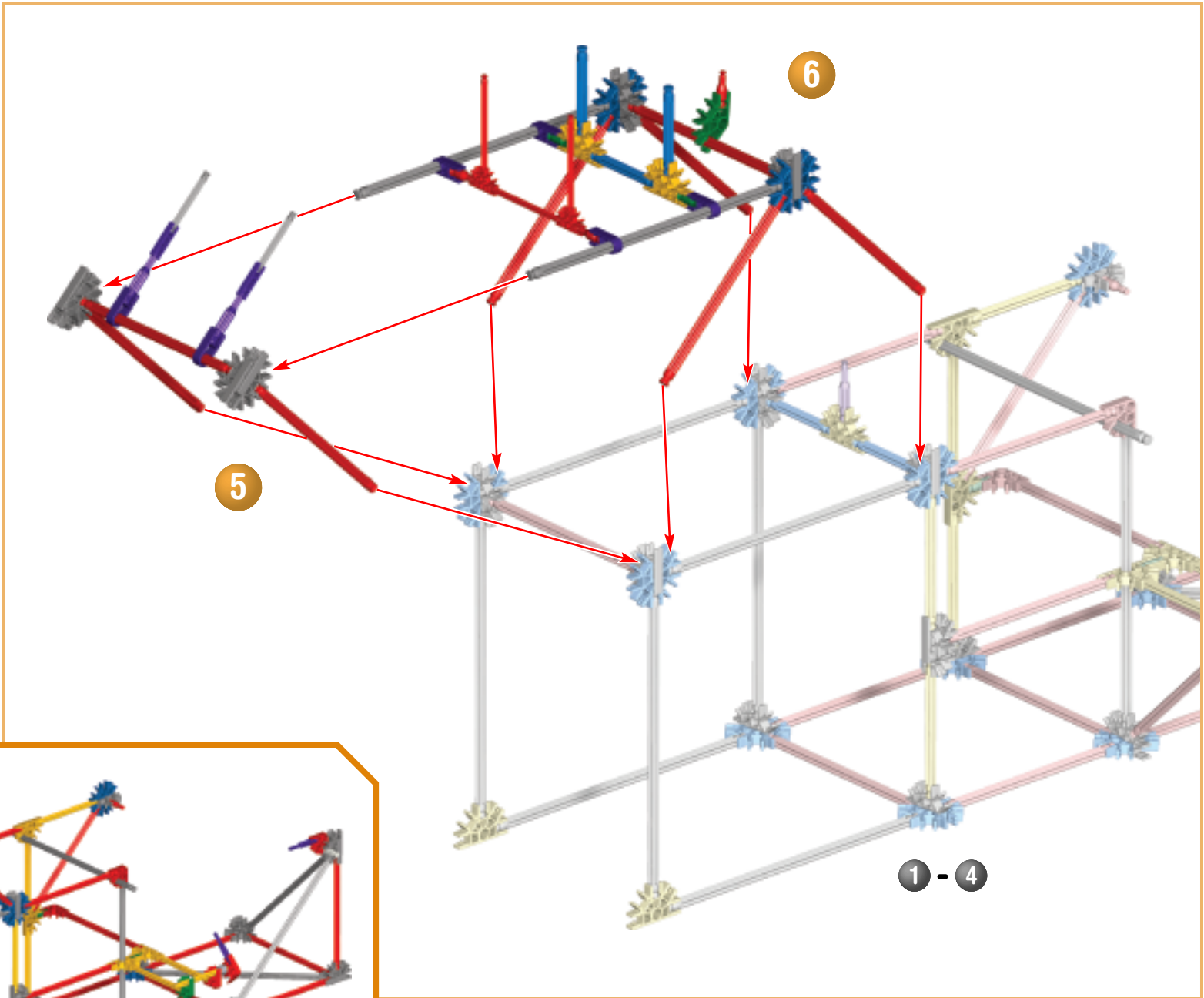

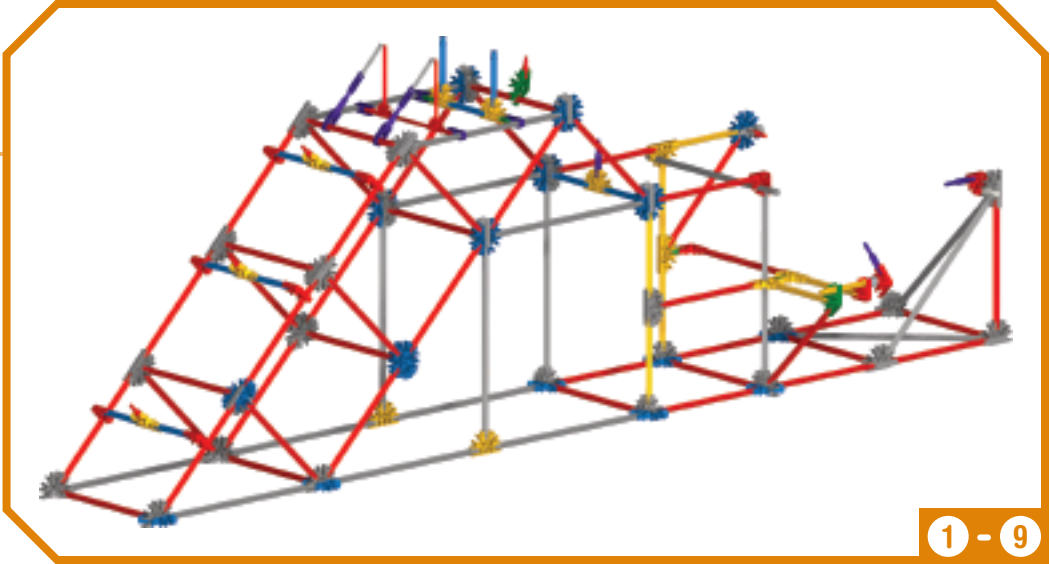
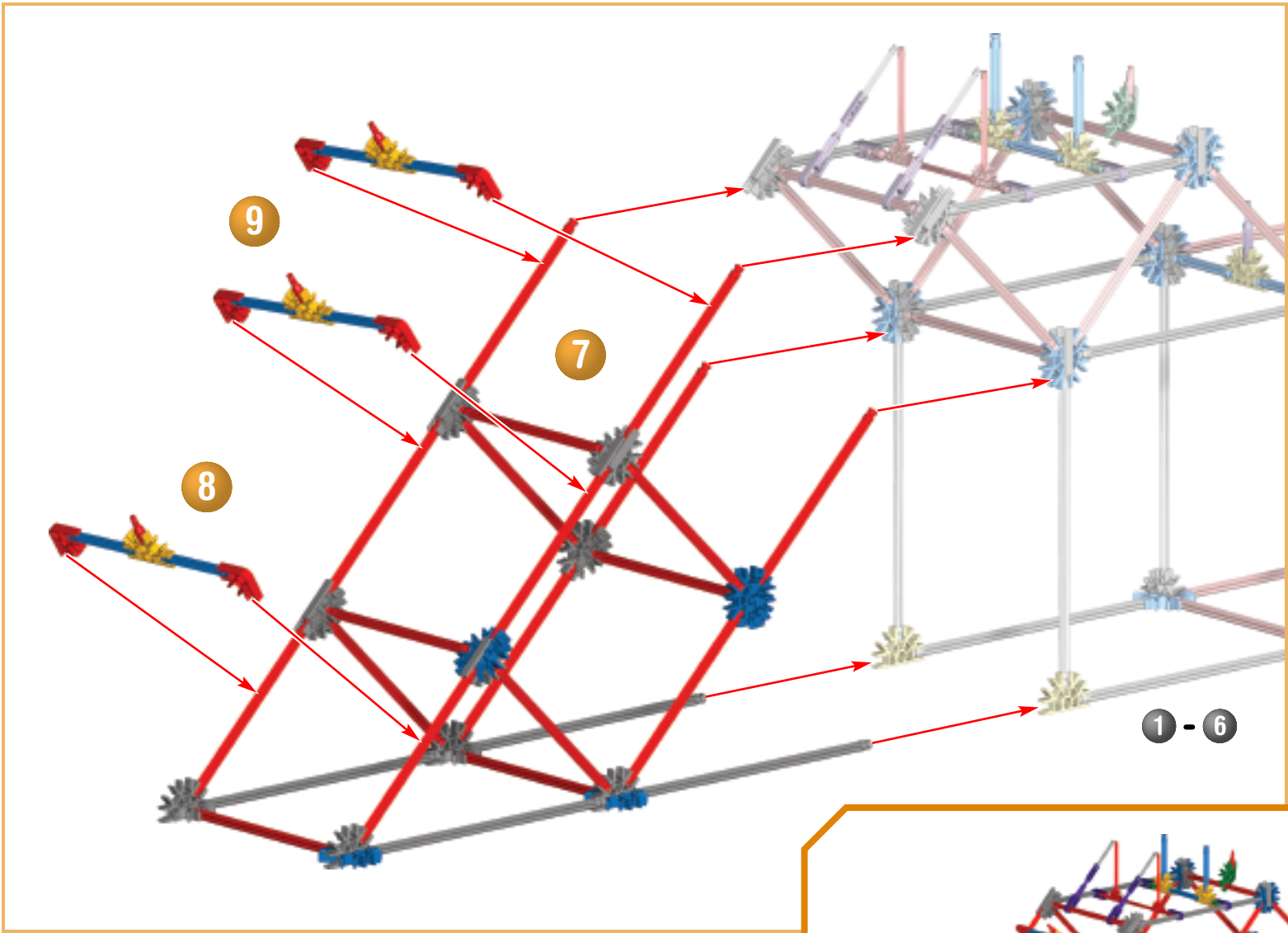

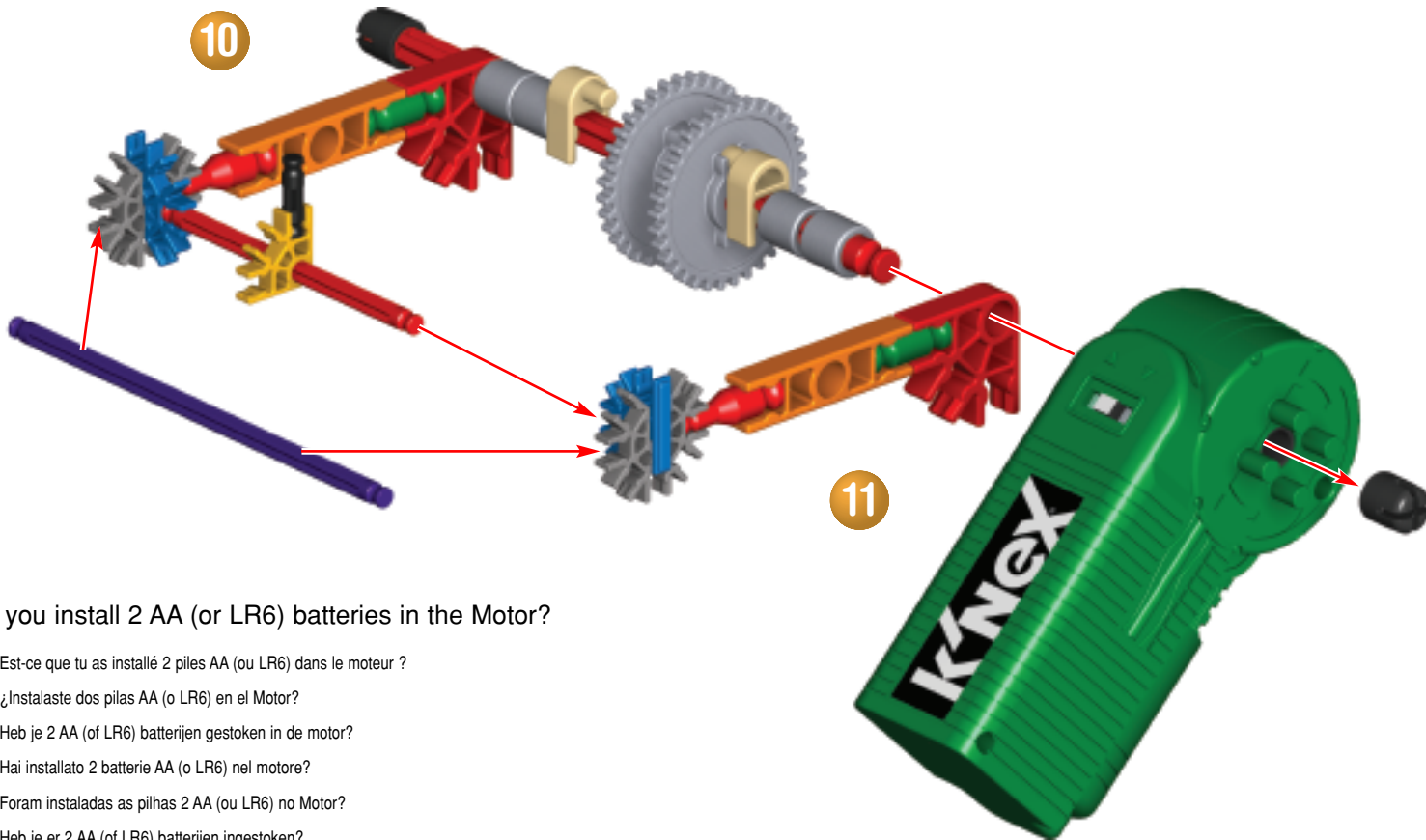

Did you install 2 AA (or LR6) batteries in the Motor?

- Ⓕ FR Est-ce que tu as installé 2 piles AA (ou LR6) dans le moteur ?
- Ⓔ ES ¿Instalaste dos pilas AA (o LR6) en el Motor?
- Ⓓ DE Heb je 2 AA (of LR6) batterijen gestoken in de motor?
- Ⓘ IT Hai installato 2 batterie AA (o LR6) nel motore?
- Ⓟ PT Foram instaladas as pilhas 2 AA (ou LR6) no Motor?
- Ⓝ NL Heb je er 2 AA (of LR6) batterijen ingestoken?
- Ⓢ SV Installerade du 2AA (eller LR6) batterier?
- Ⓓ DA Har du sat 2 AA (eller LR6) batterier i?
- Ⓝ NO Har du installert 2AA (eller LR6) batteriene?
- Ⓕ FI Oletko asentanut 2AA (tai LR6) -paristot?



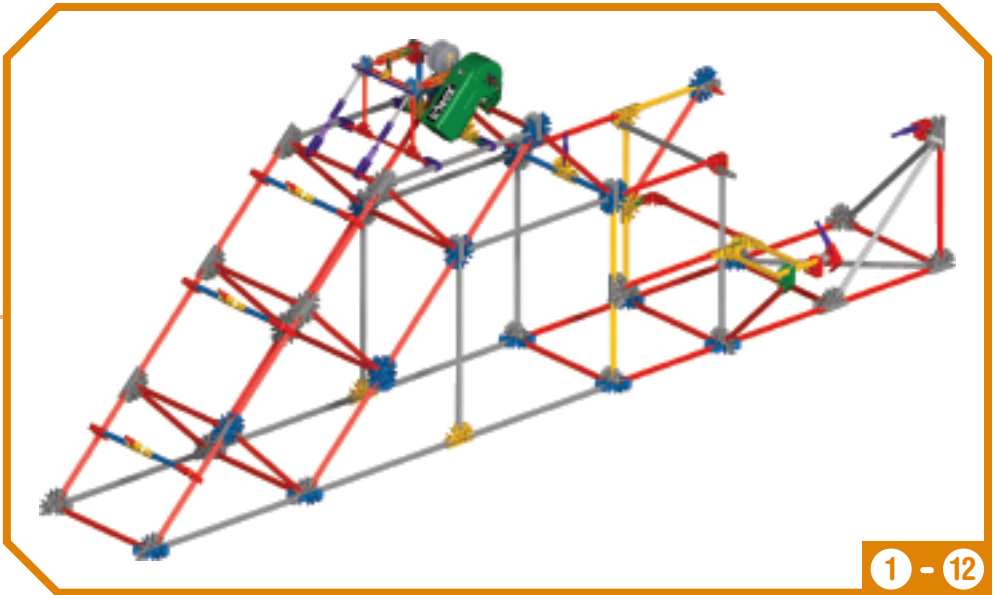
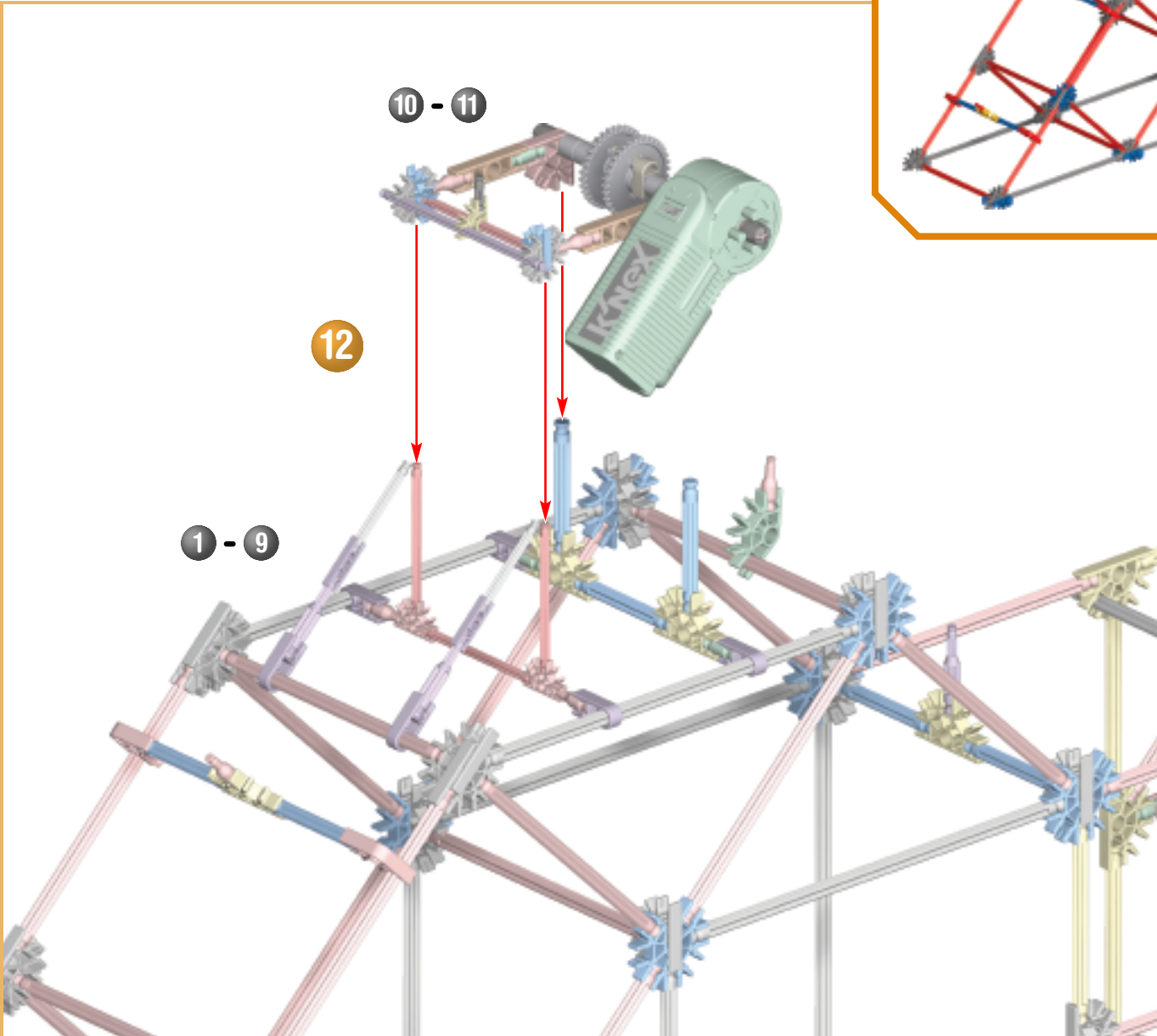

1 - 12



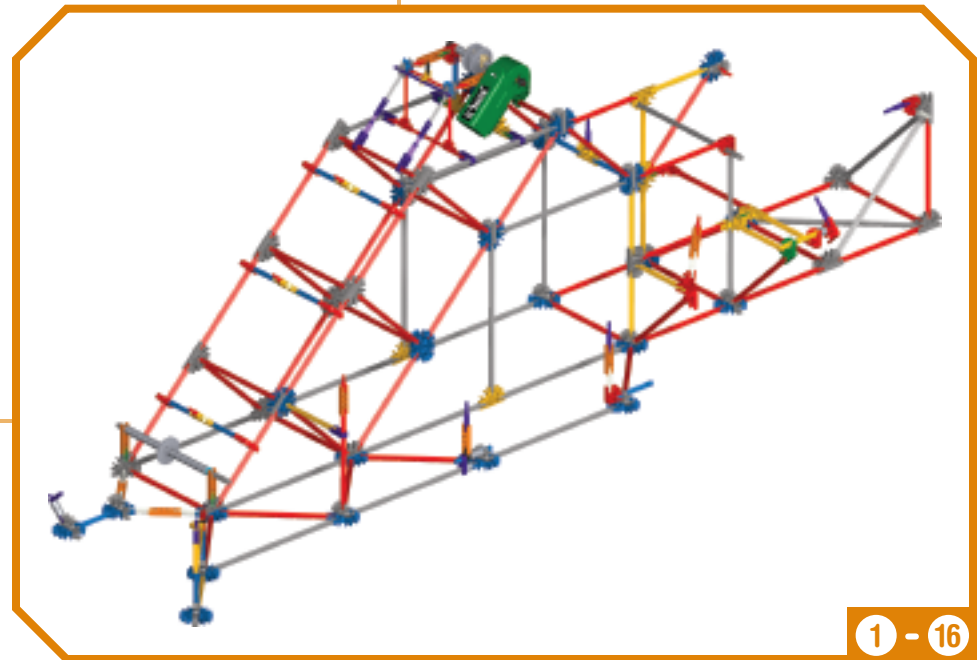
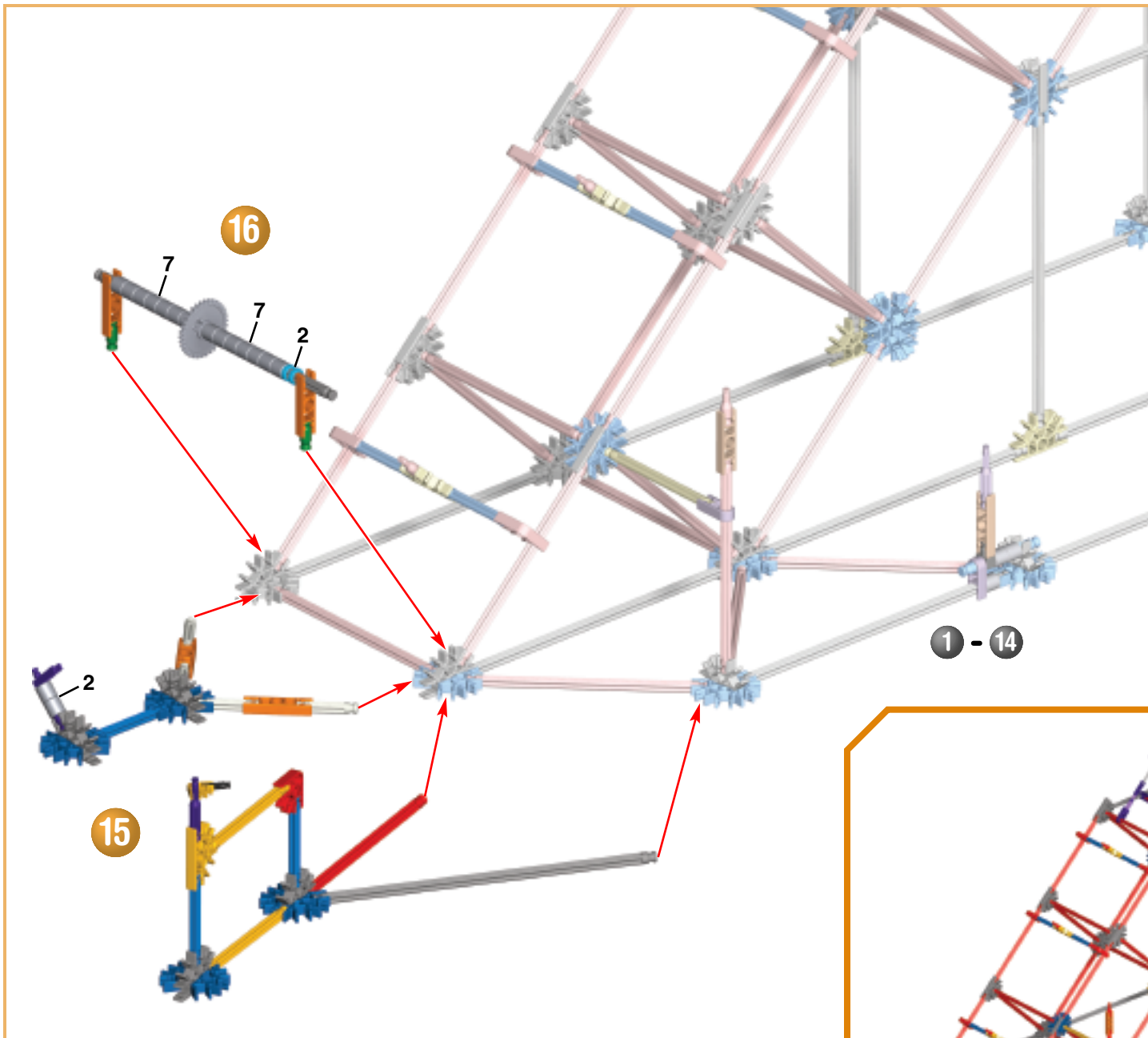

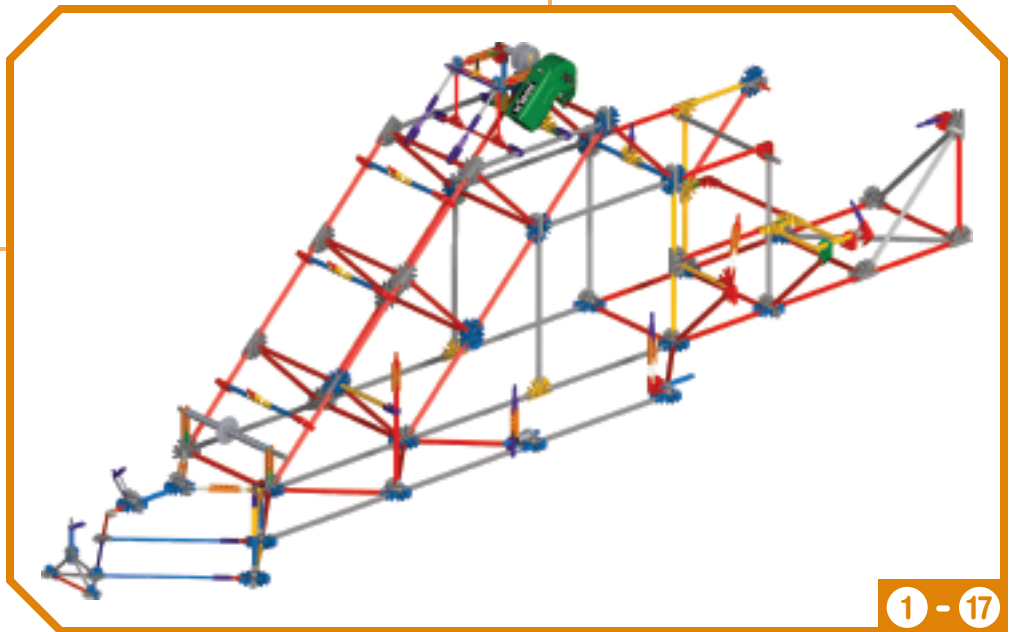
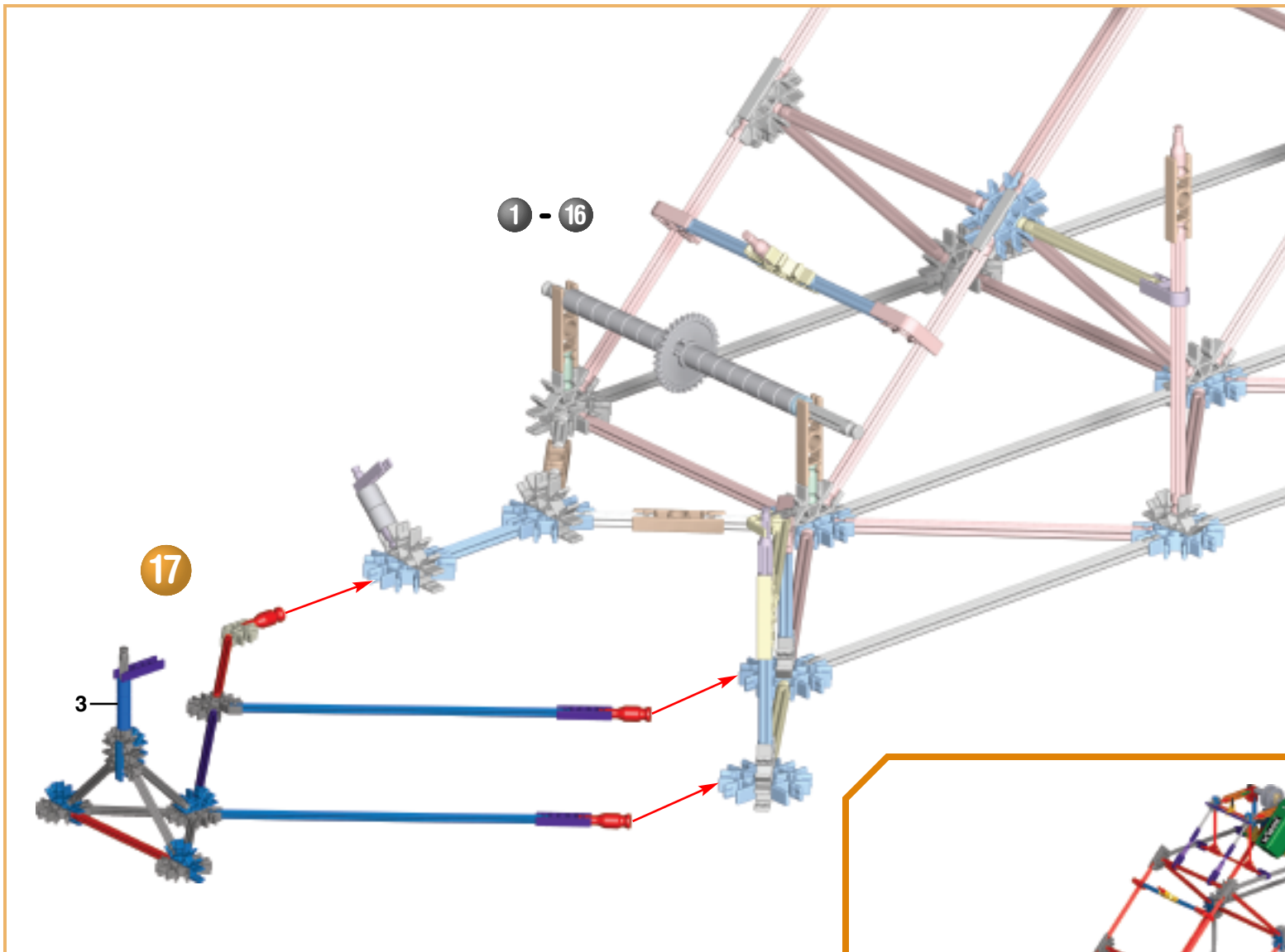

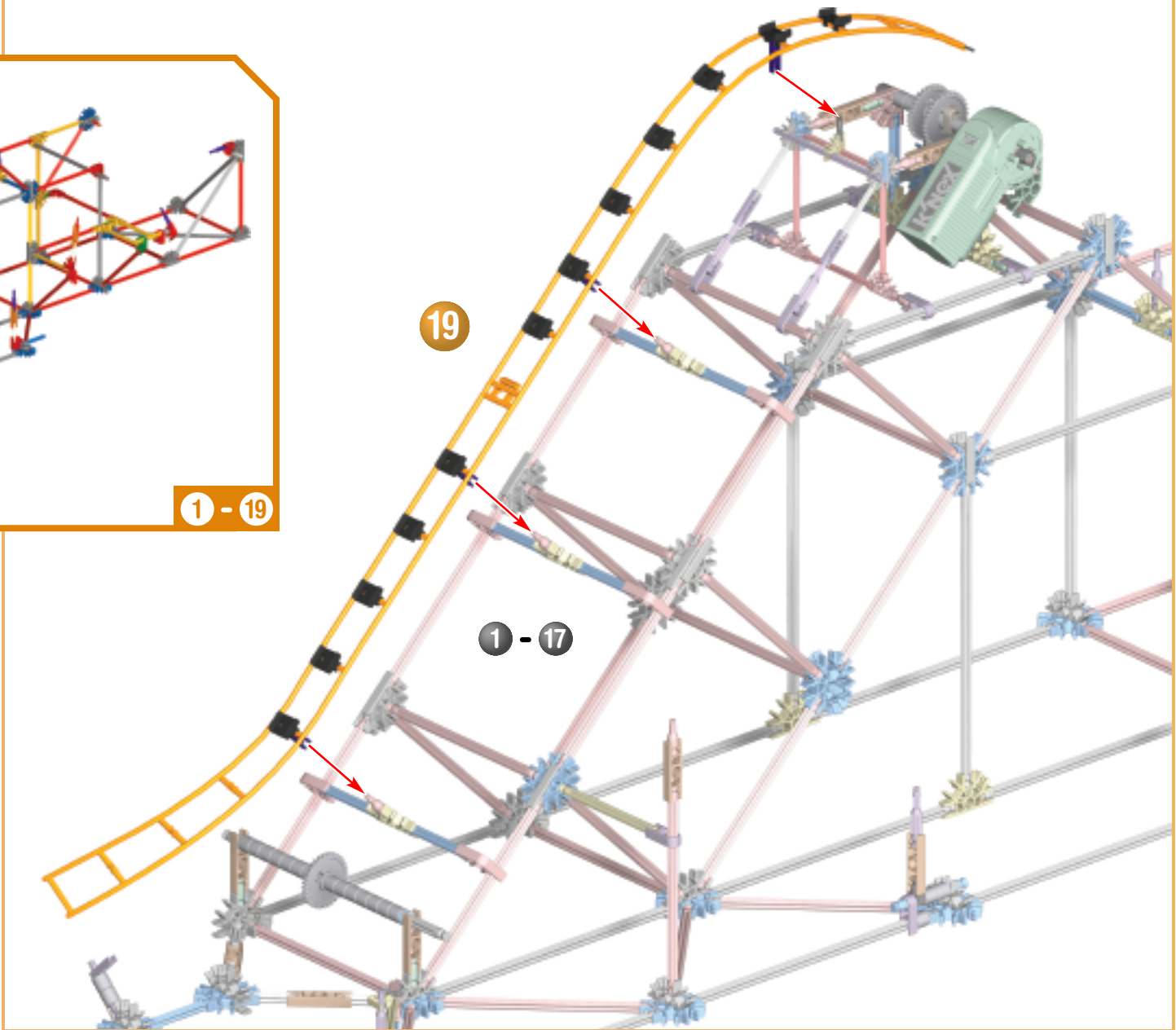
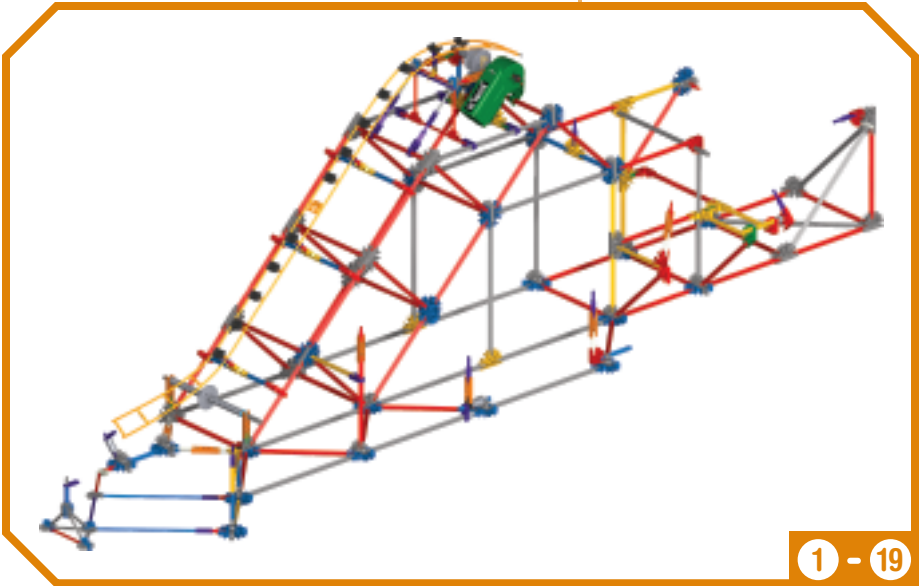
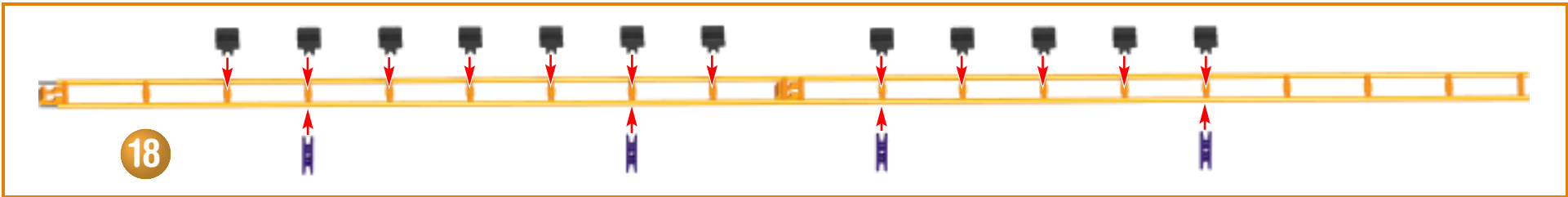

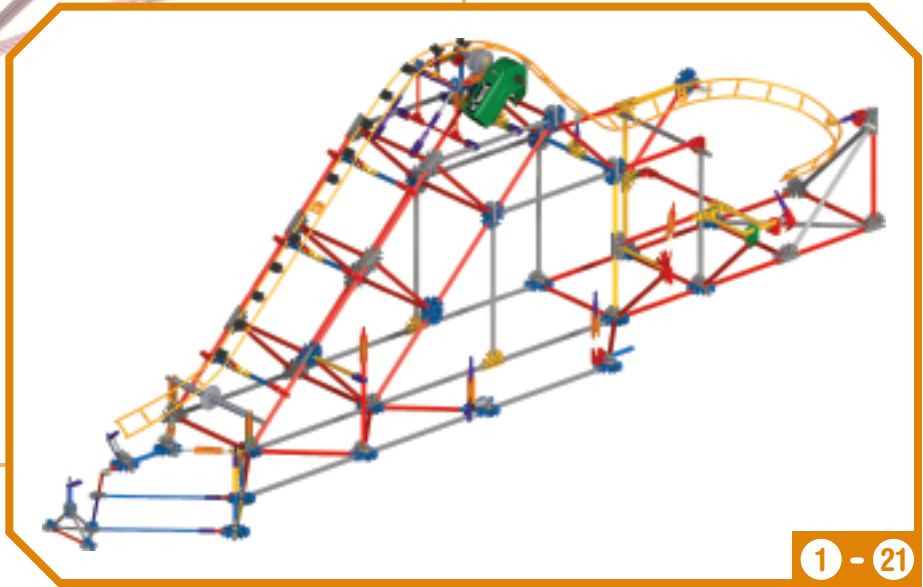
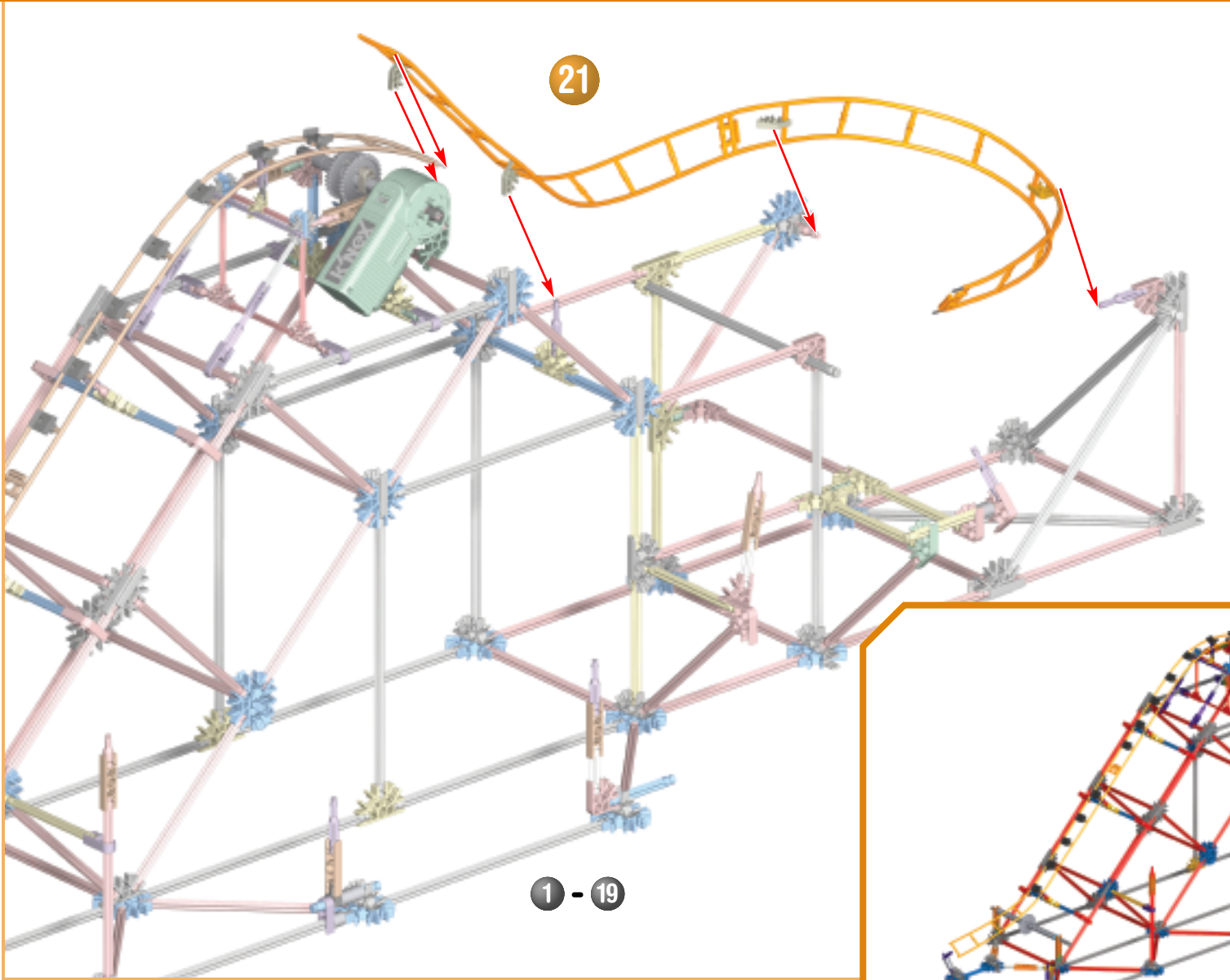
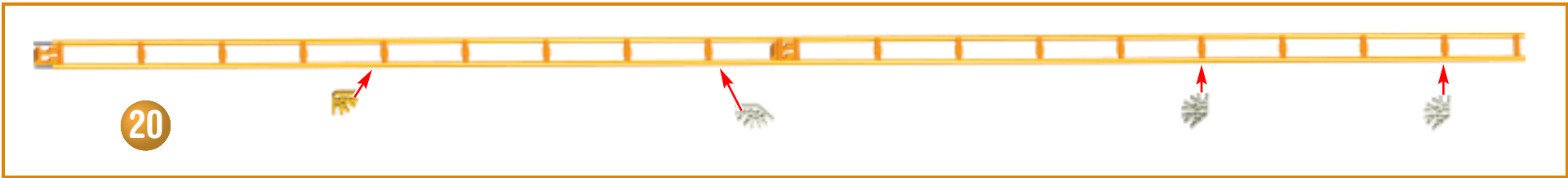

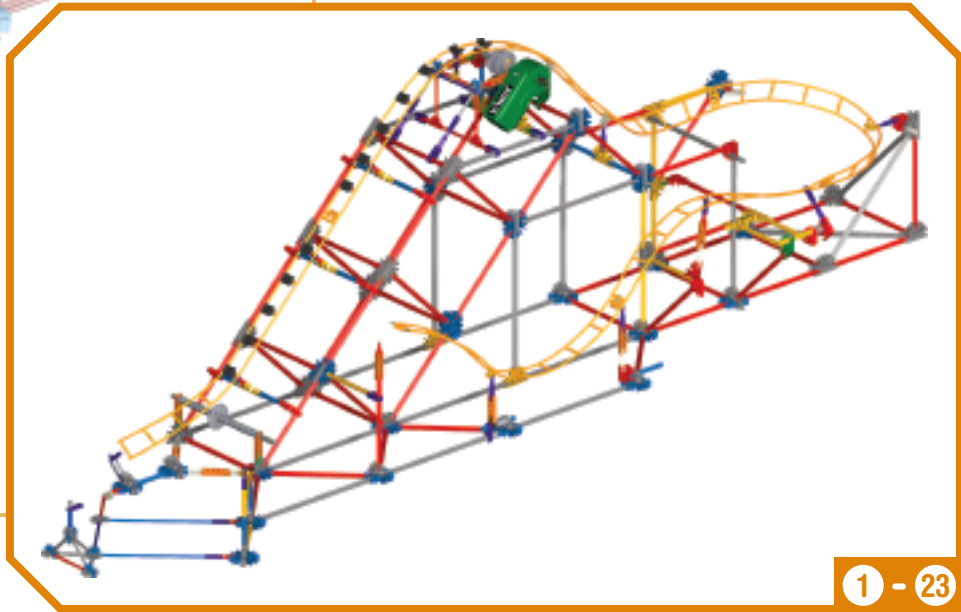
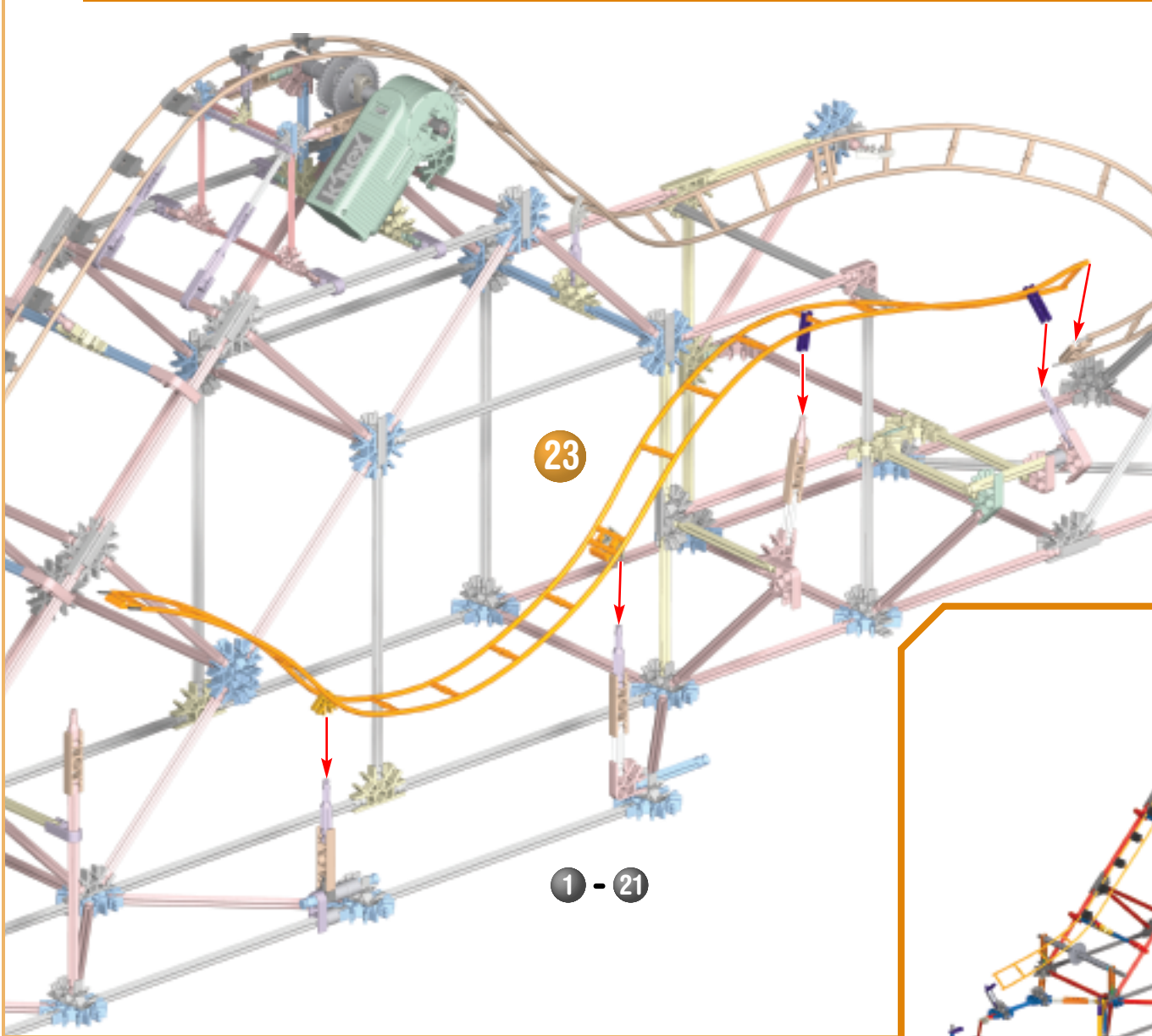
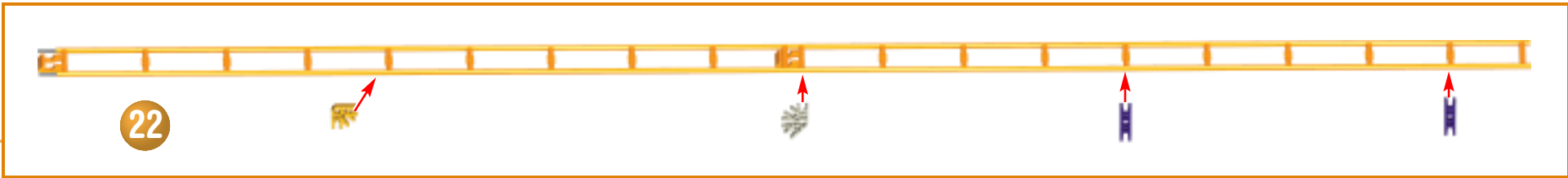

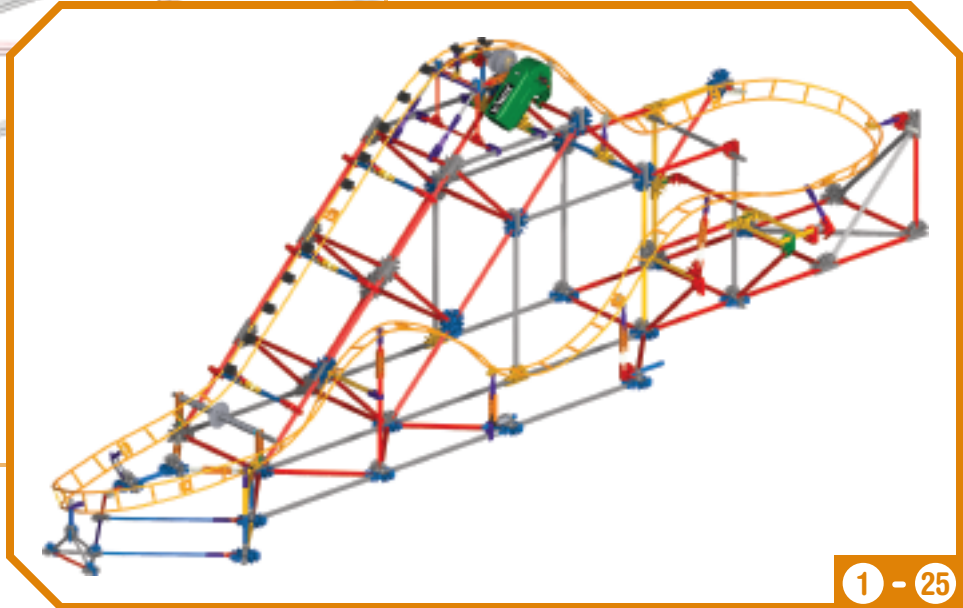
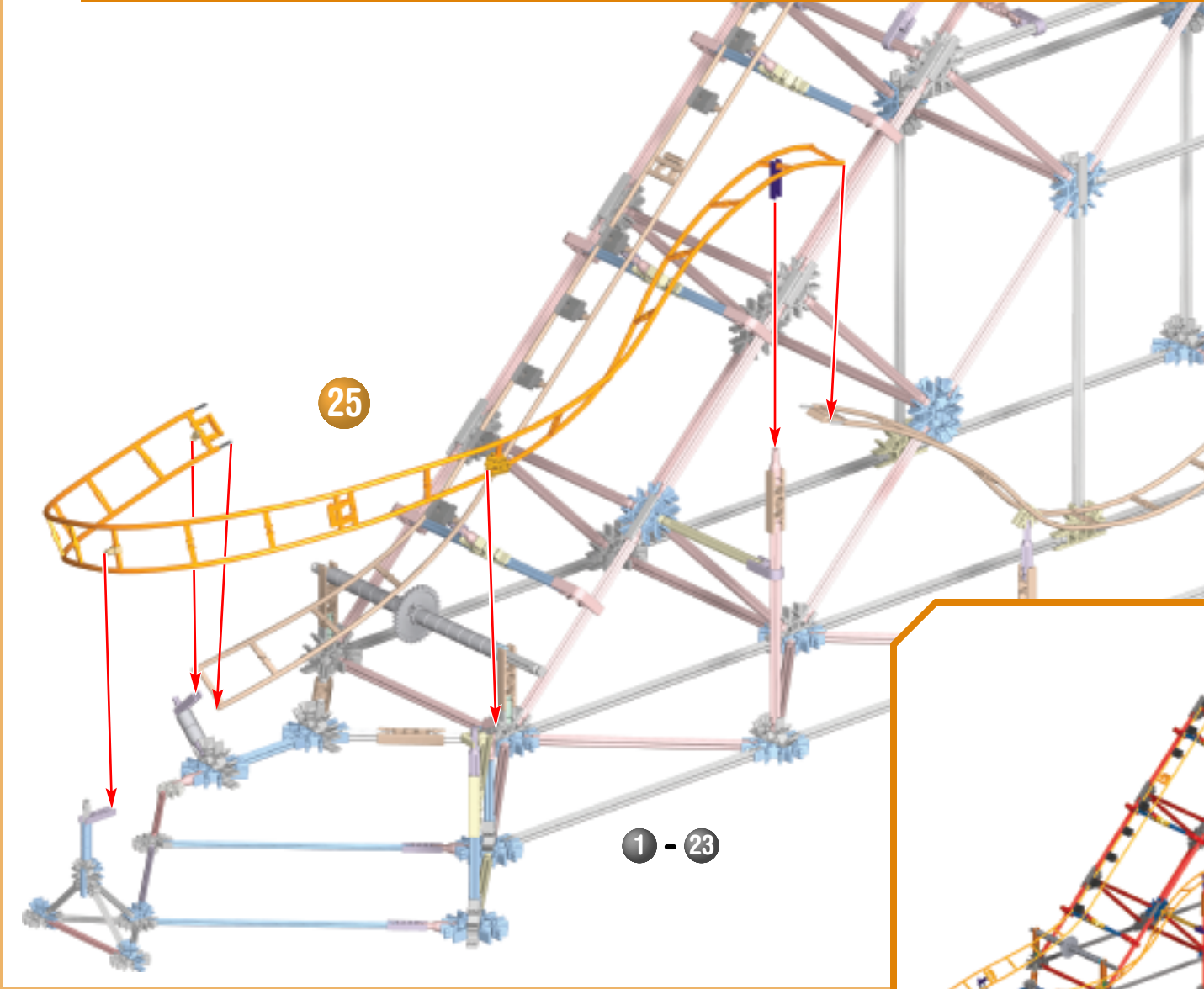

26

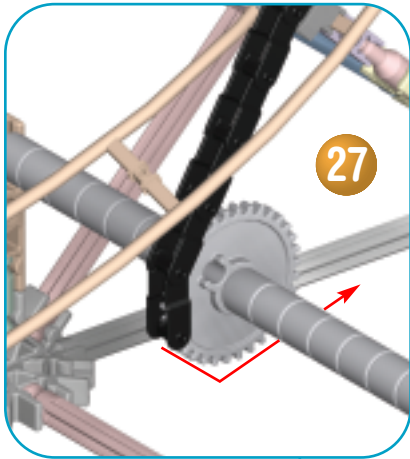
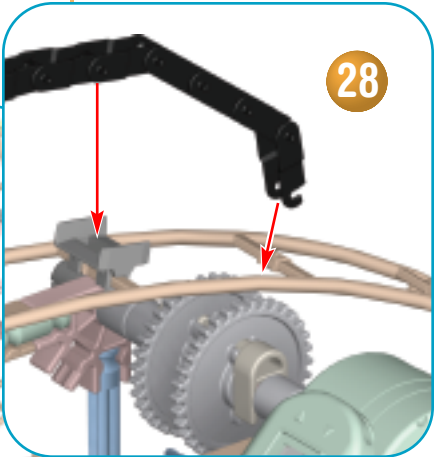

1 - 25

1 - 28

