

BRINK OF EXTINCT

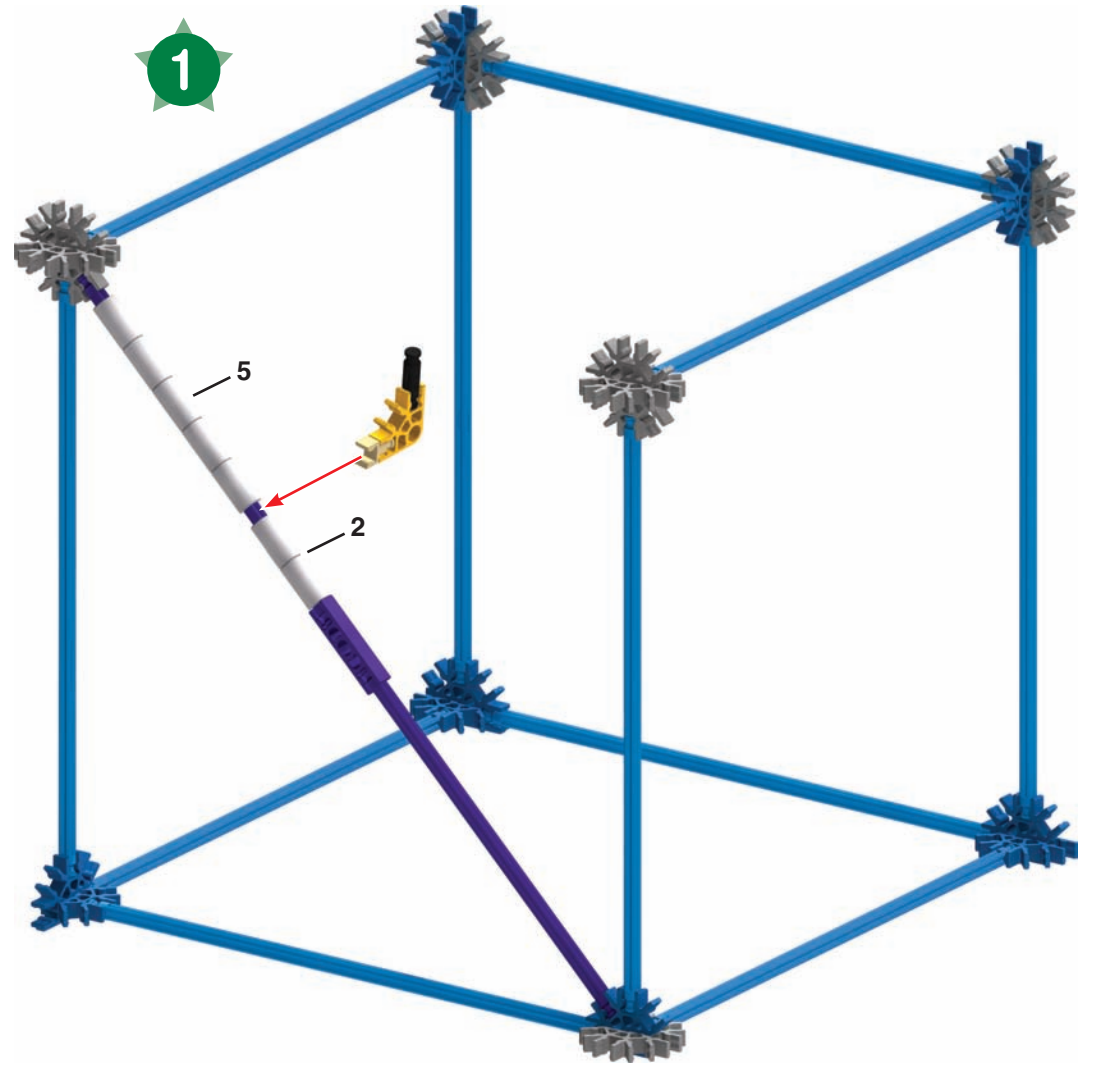

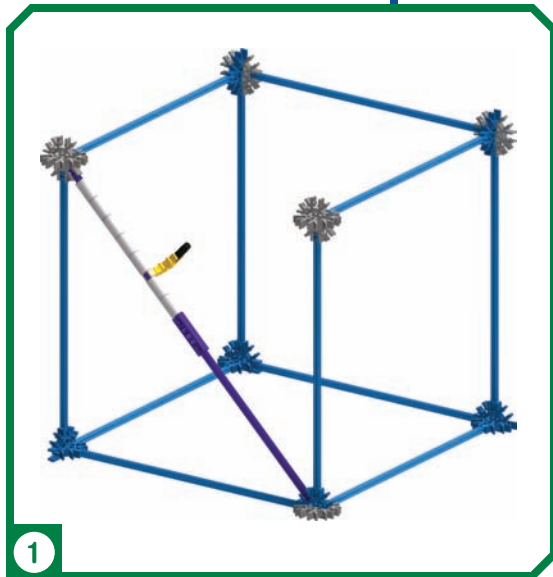

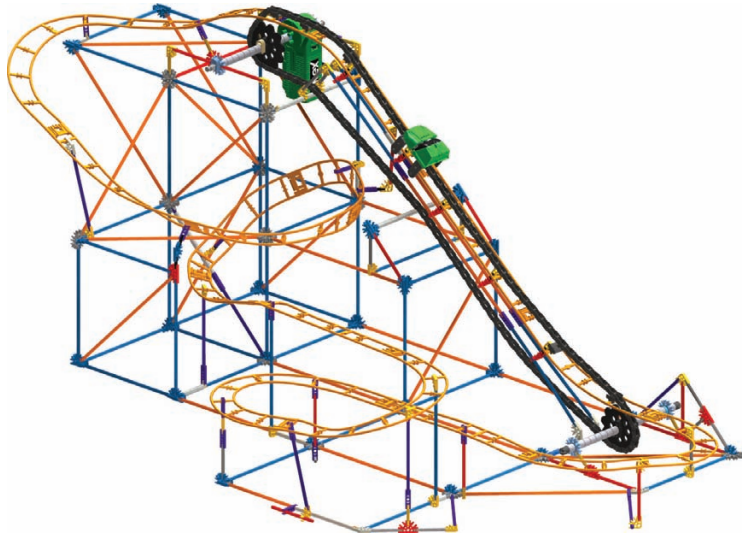
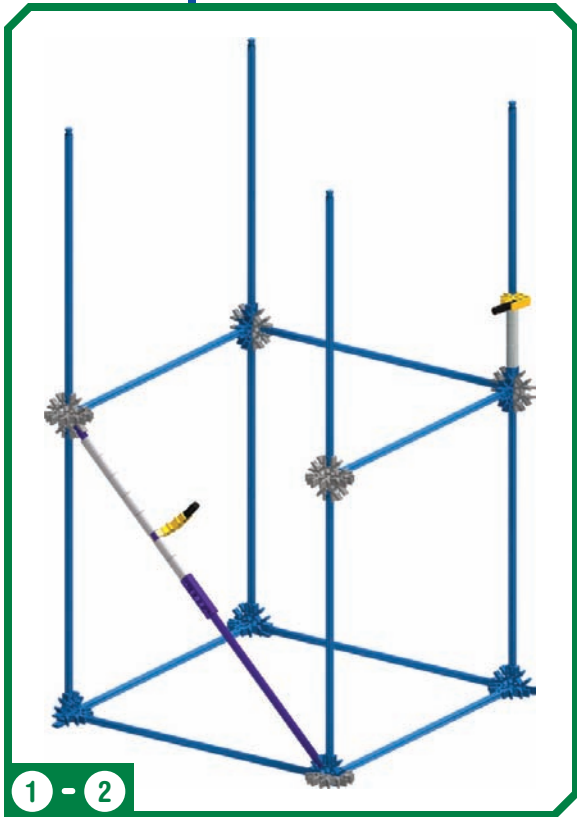
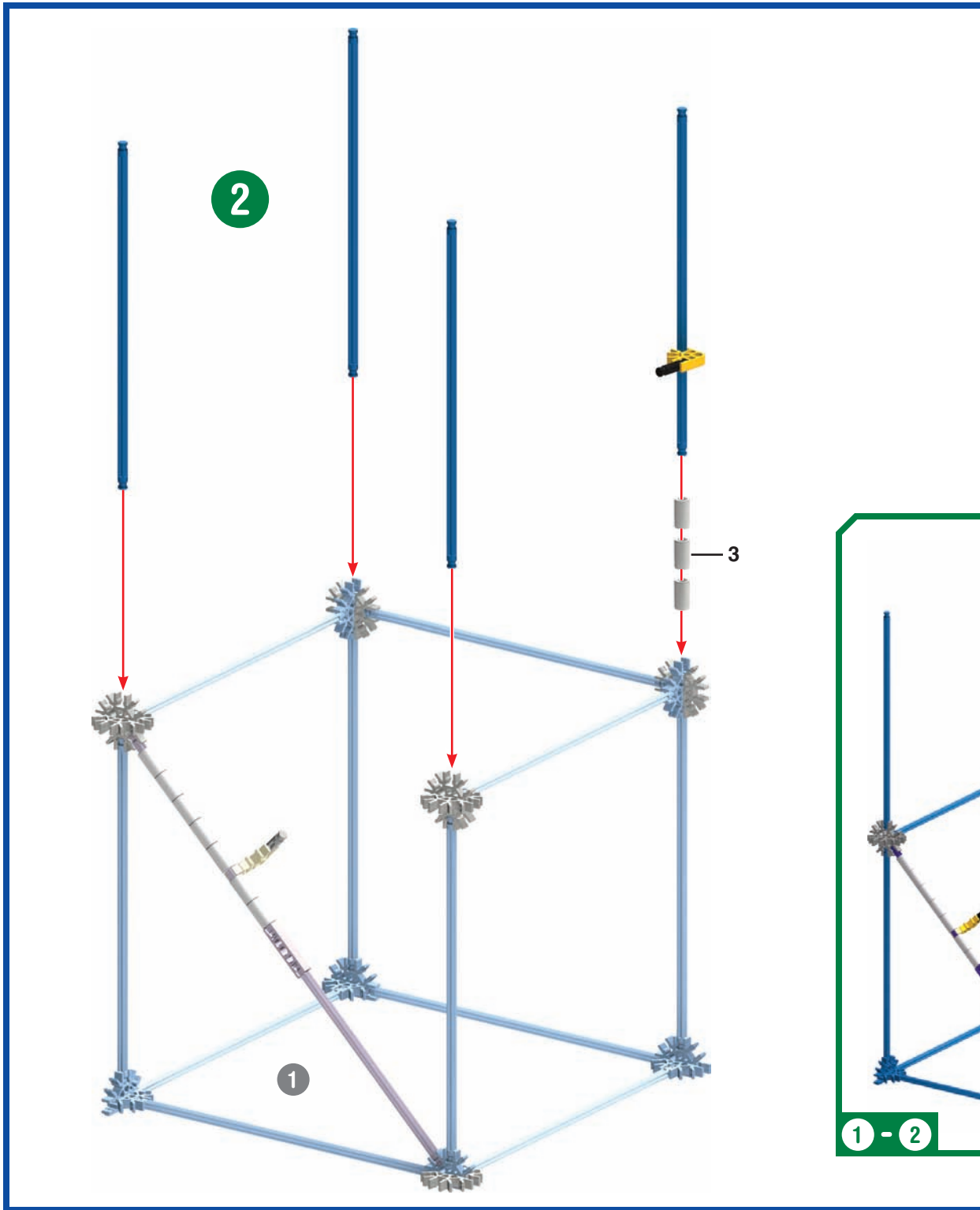
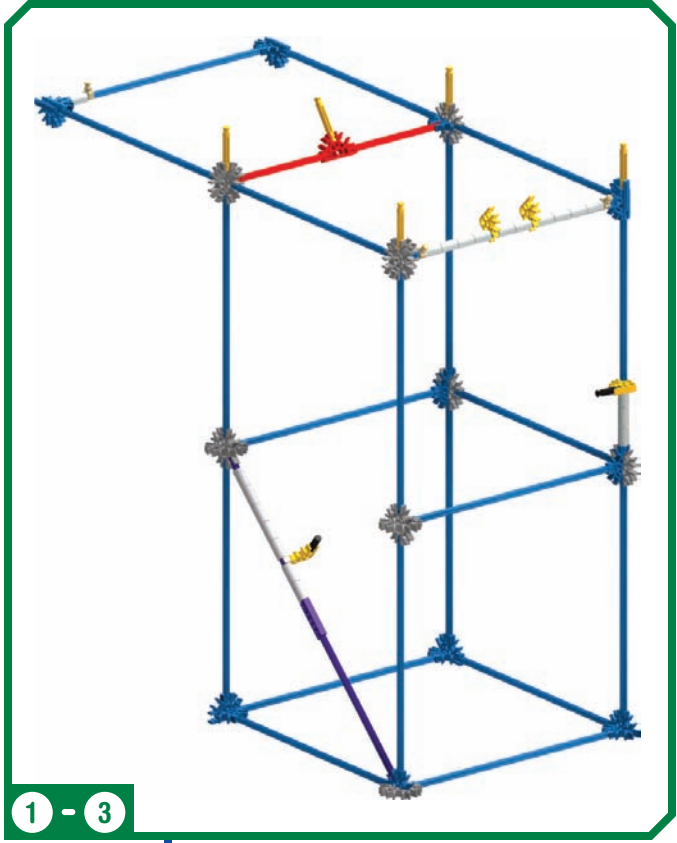
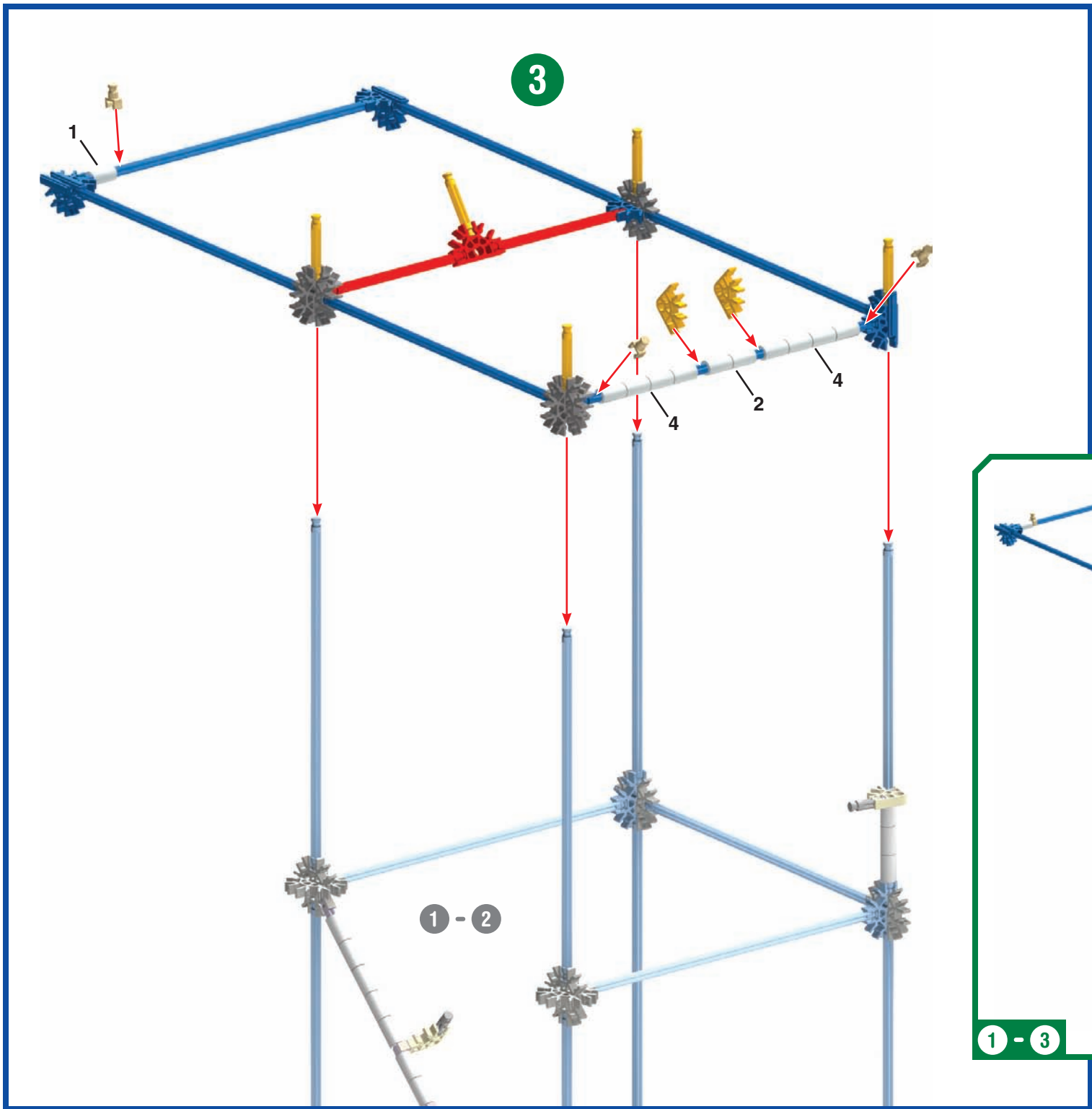

Did you install 2 AA (or LR6) batteries in the motor?

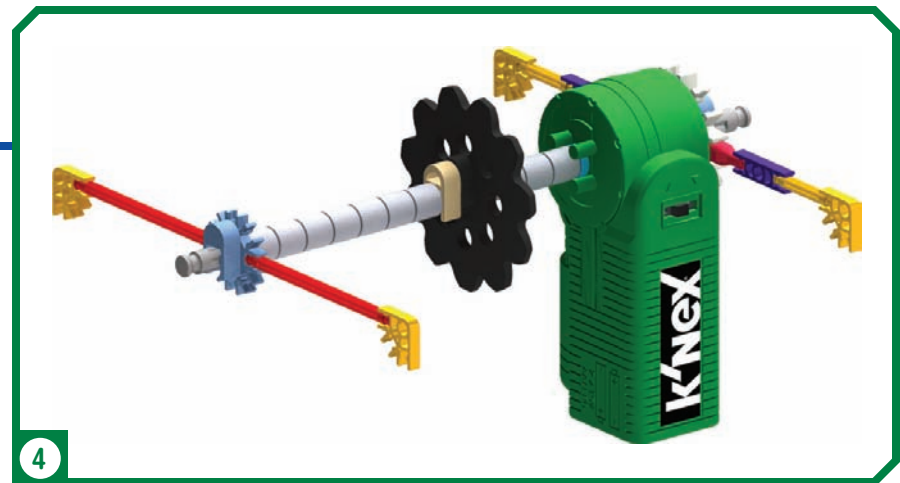
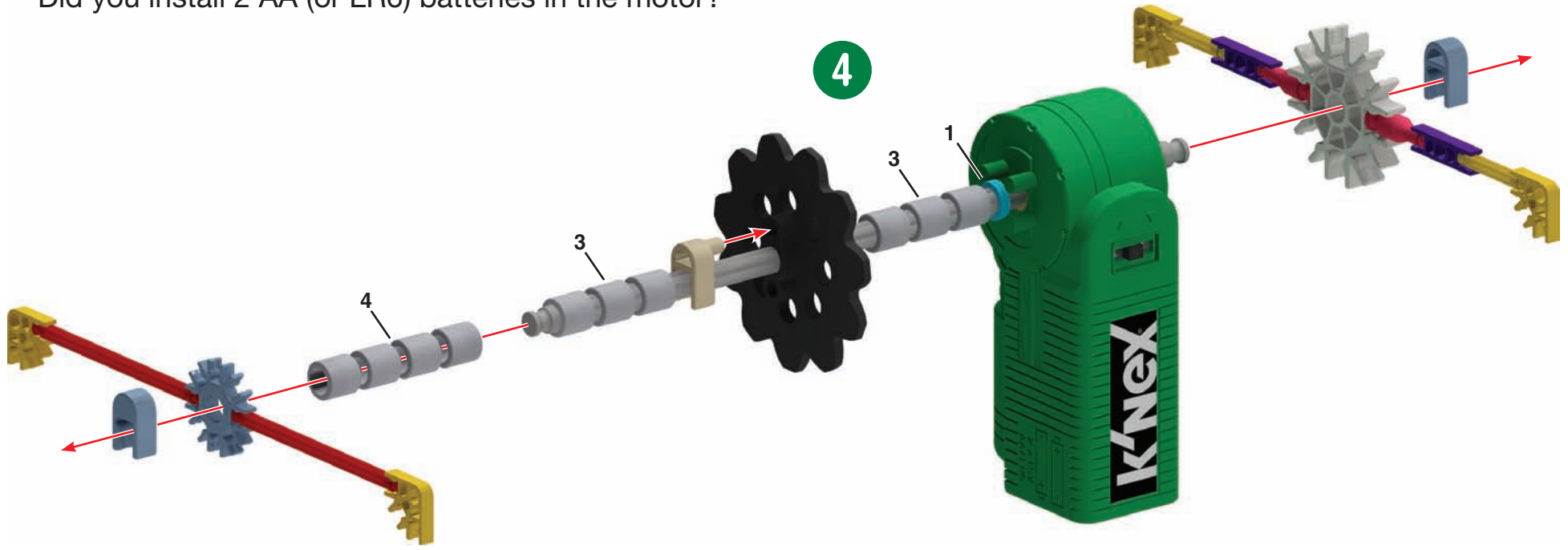

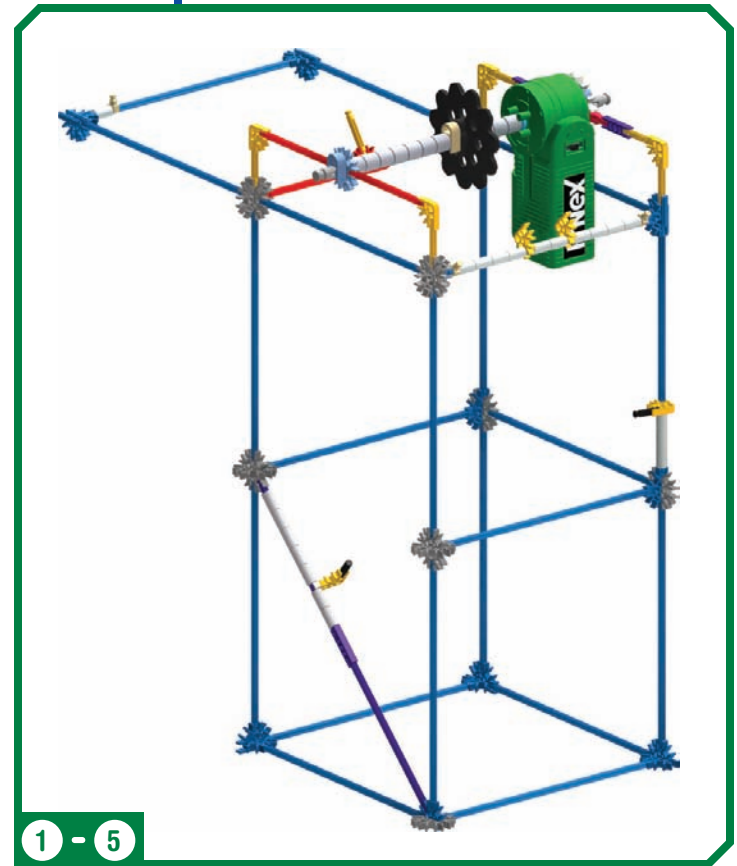
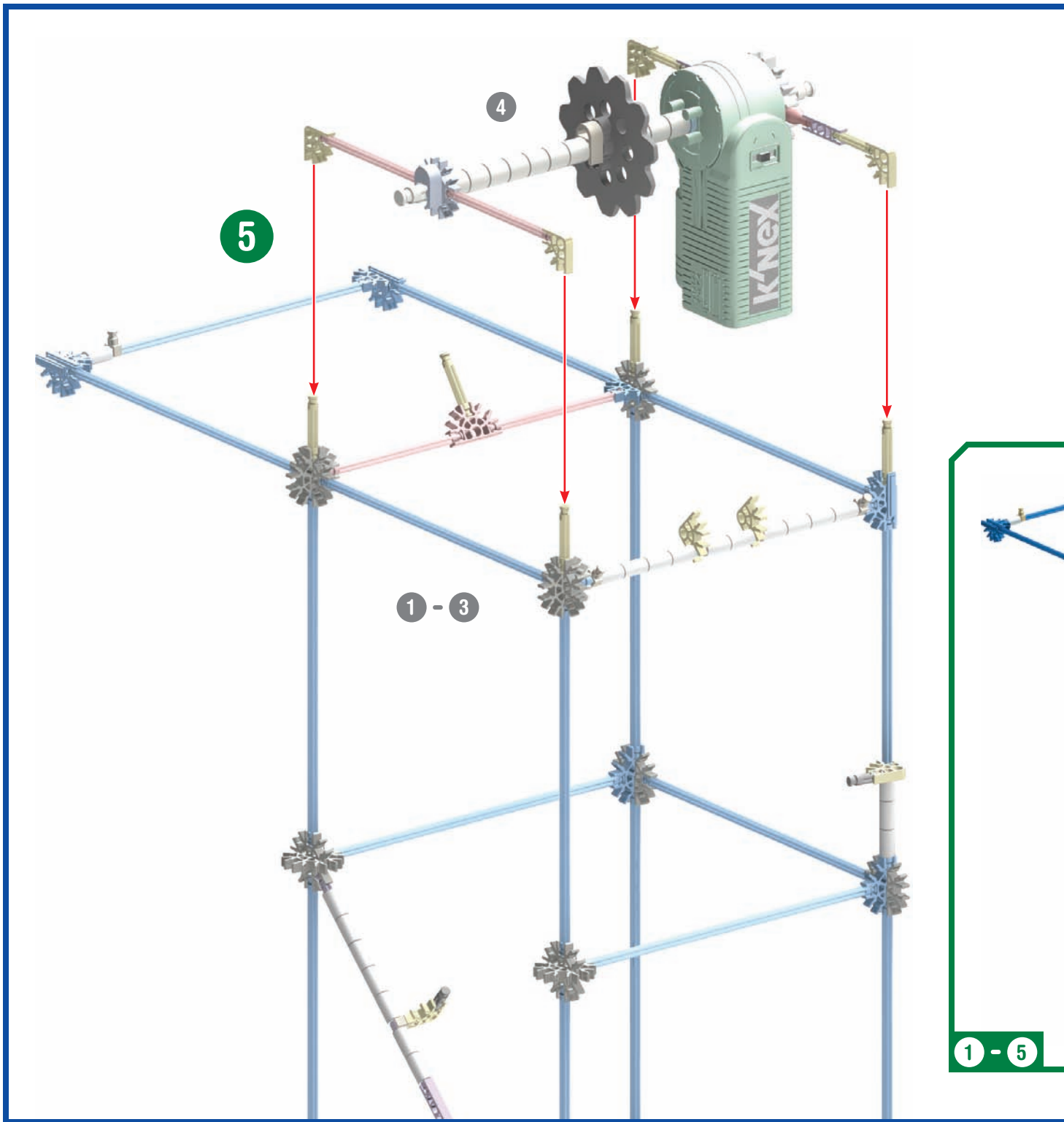

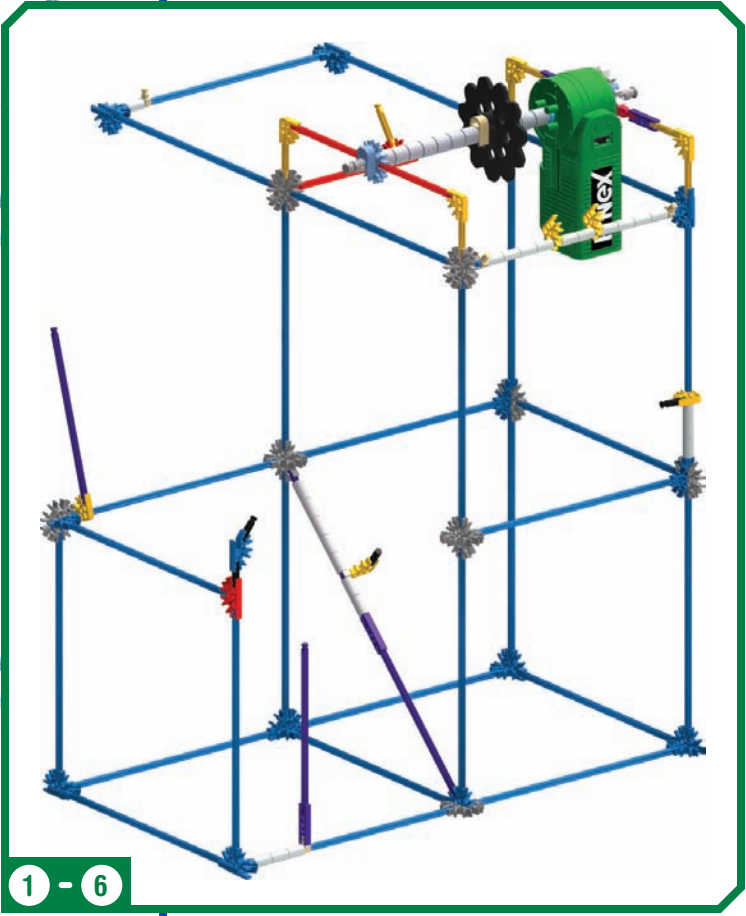
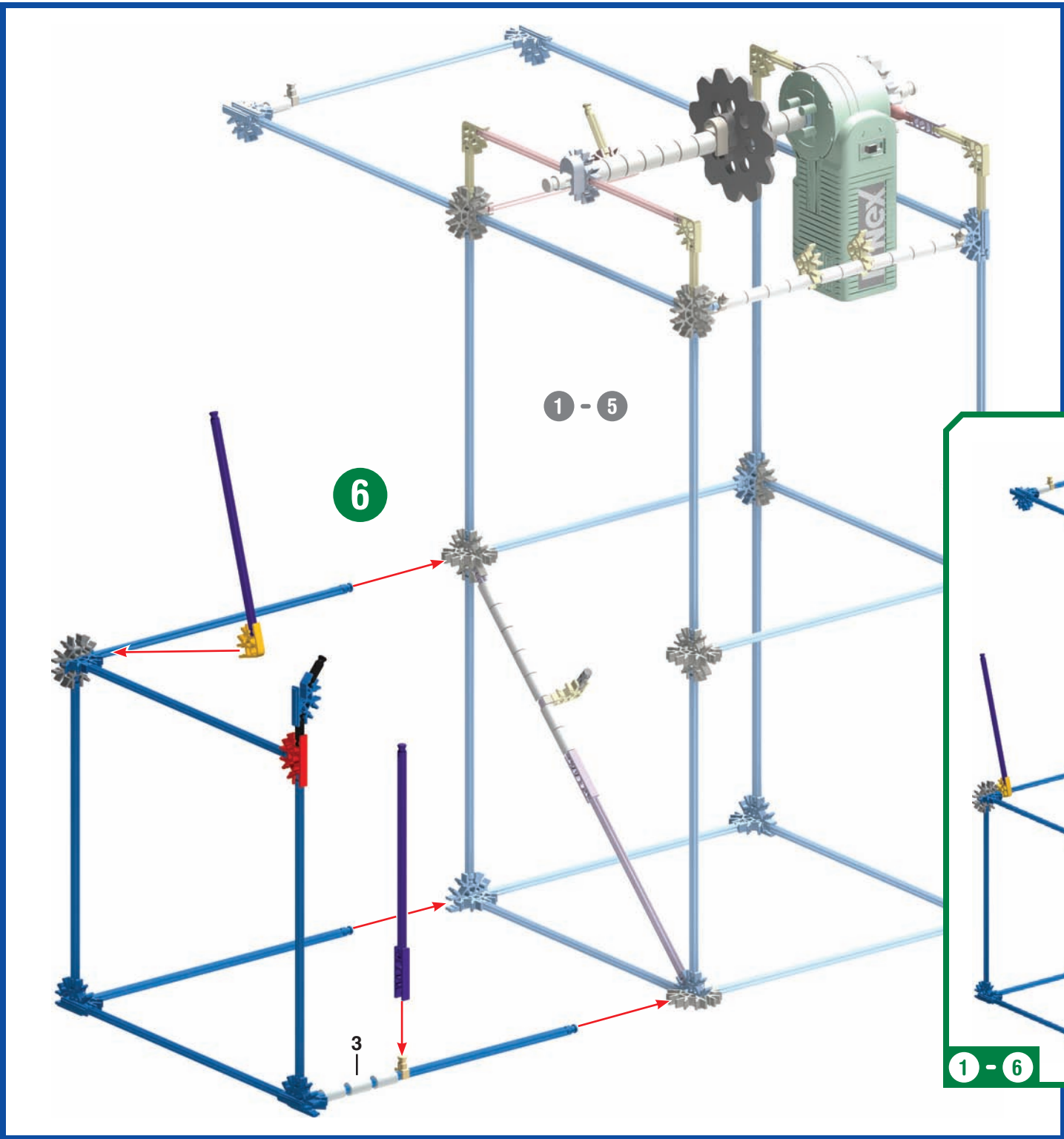

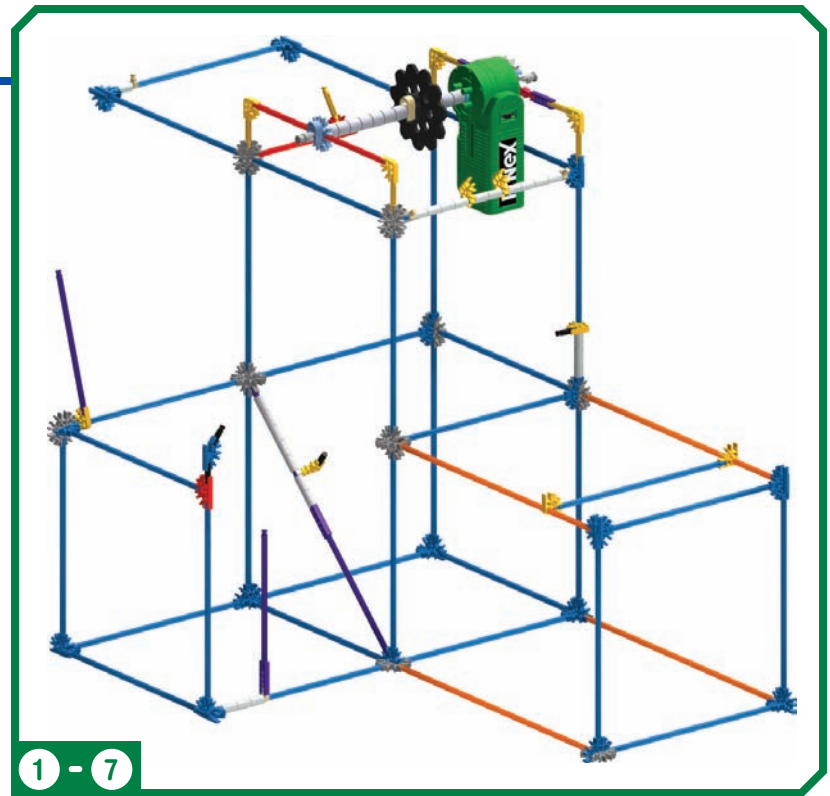
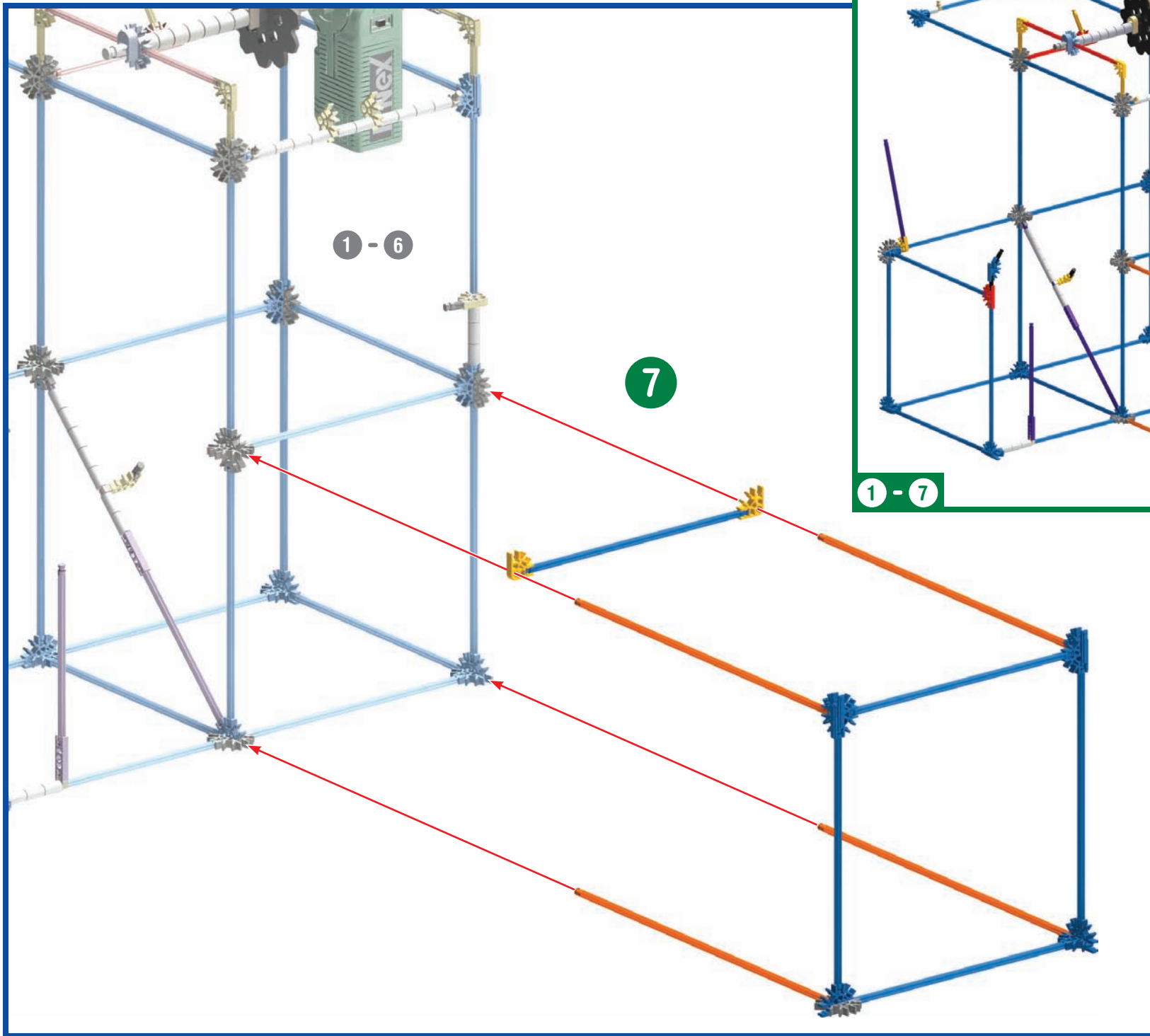

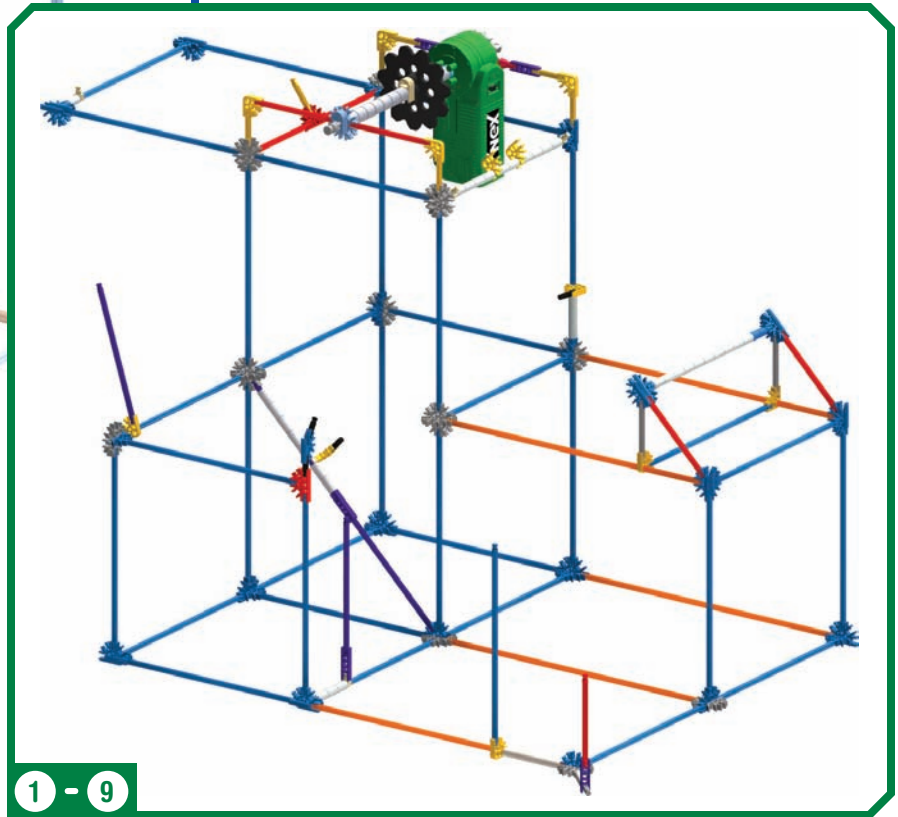
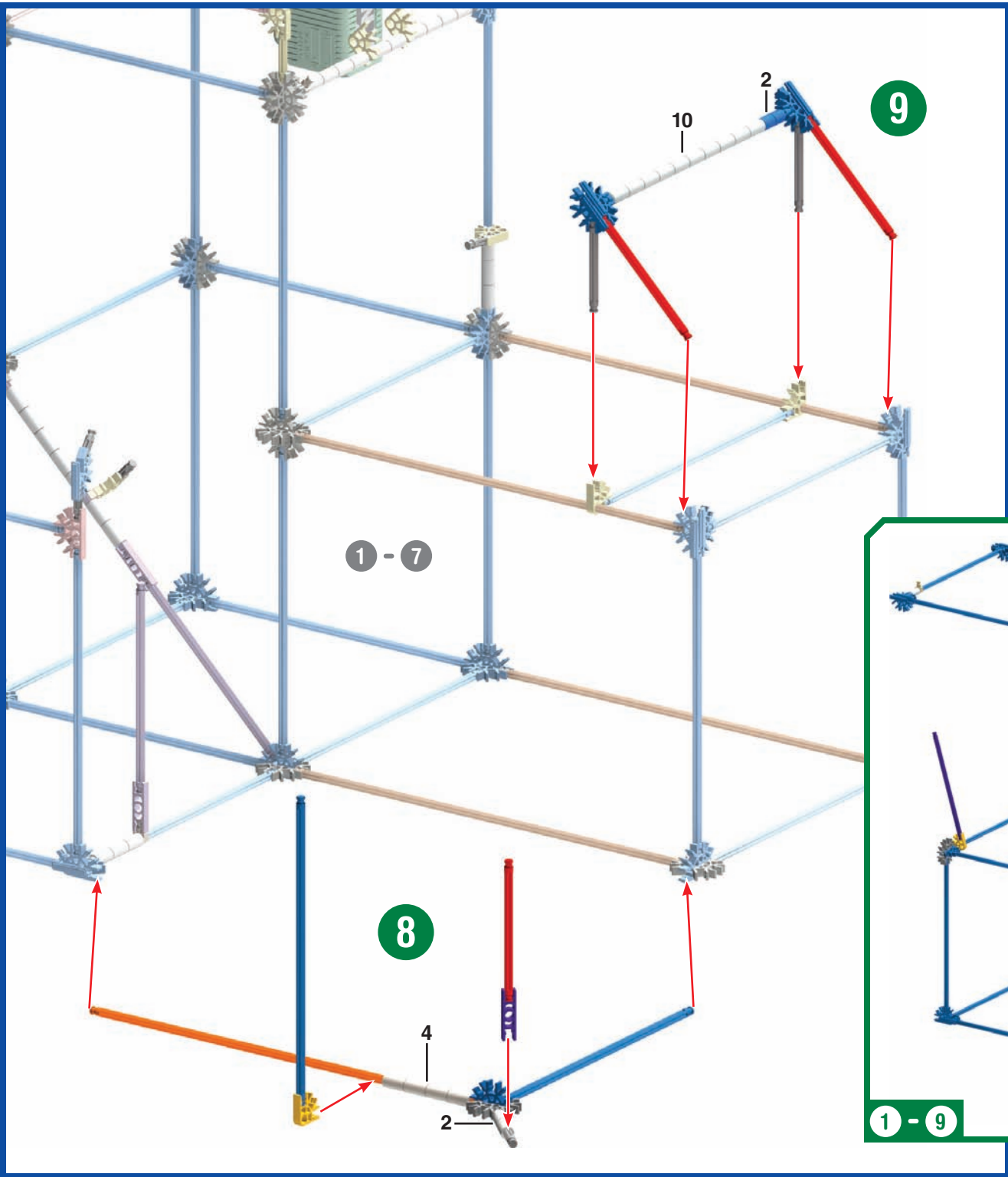

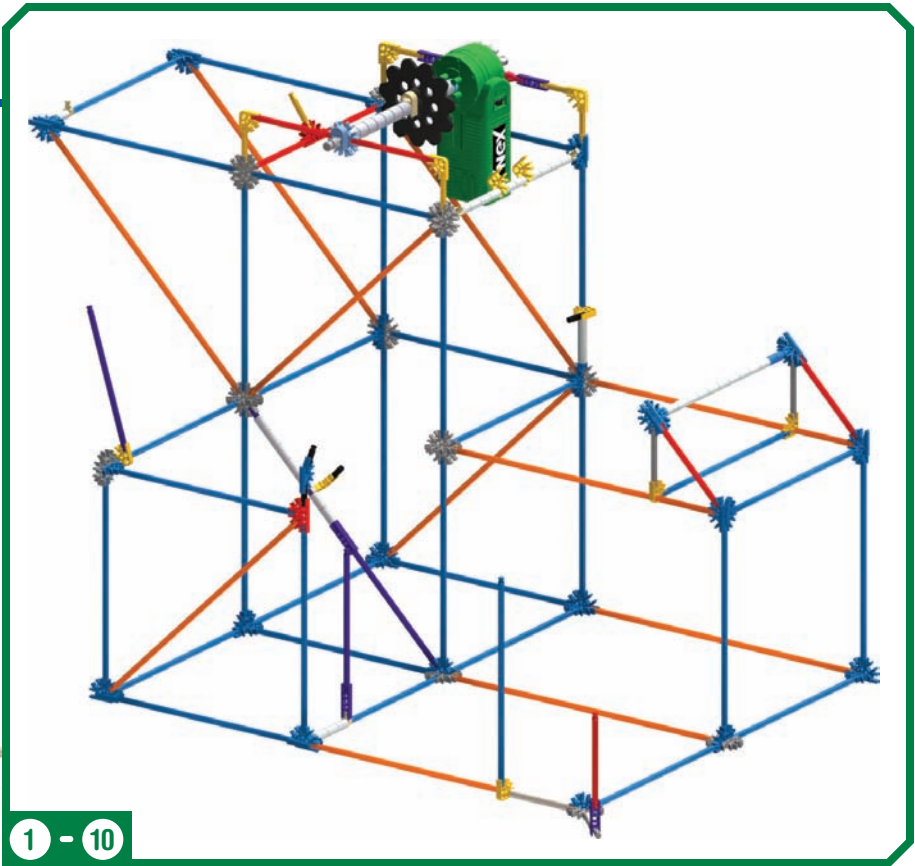
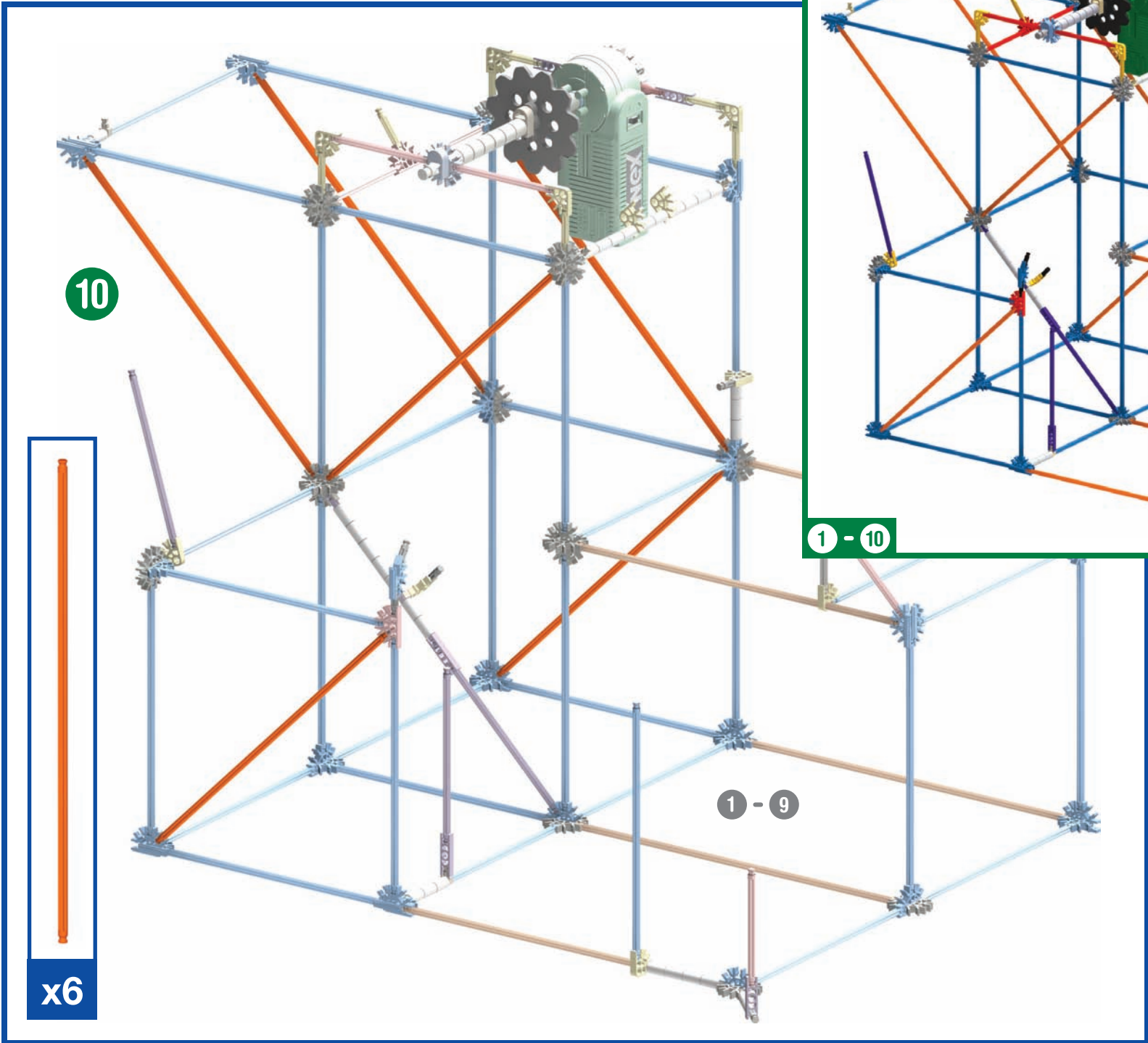

11



x6

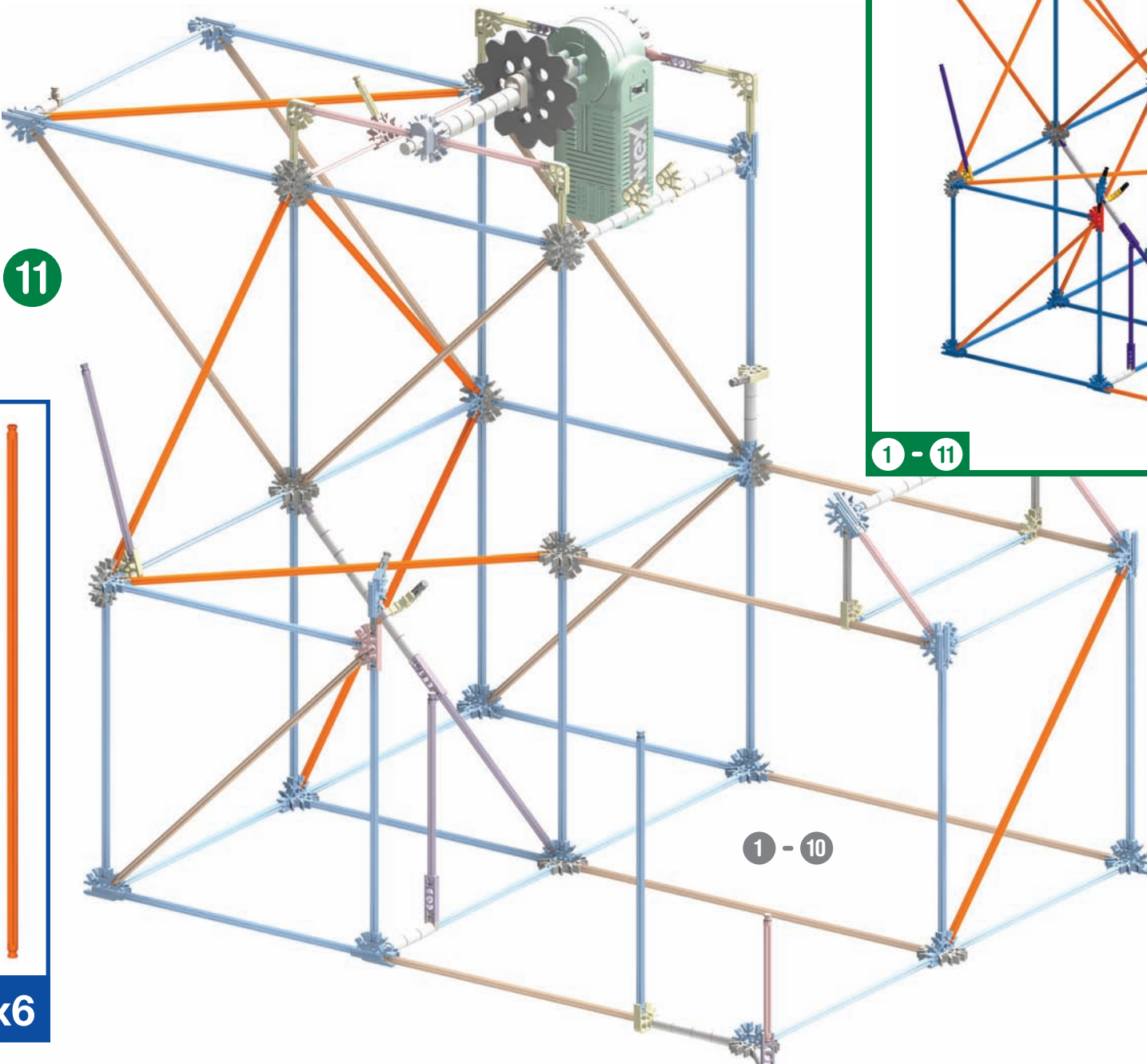

1 - 11

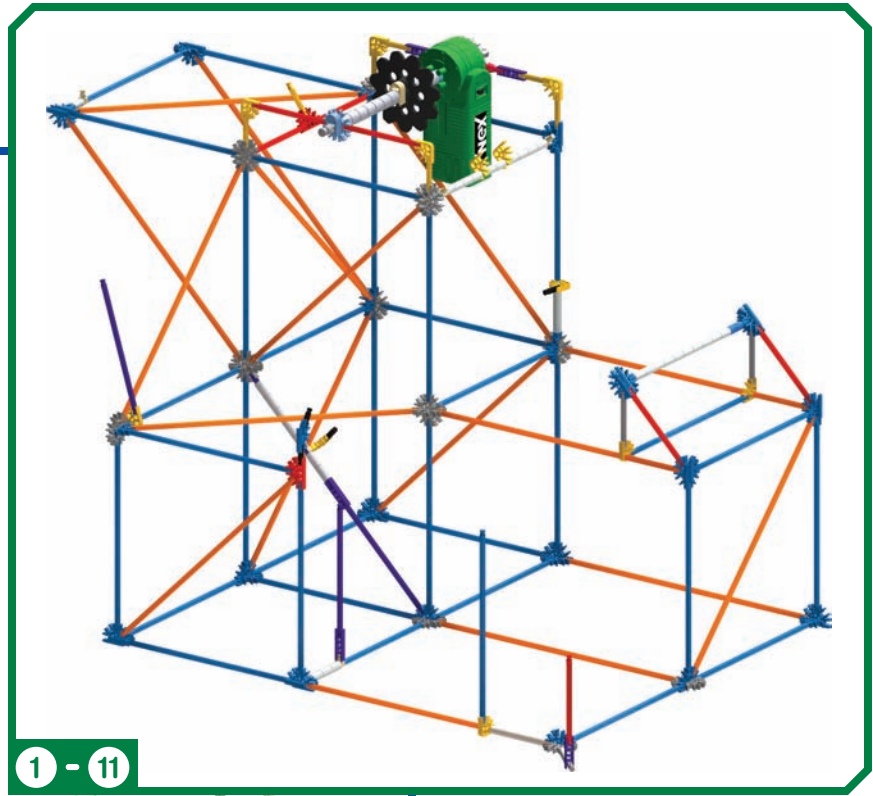

1 - 10

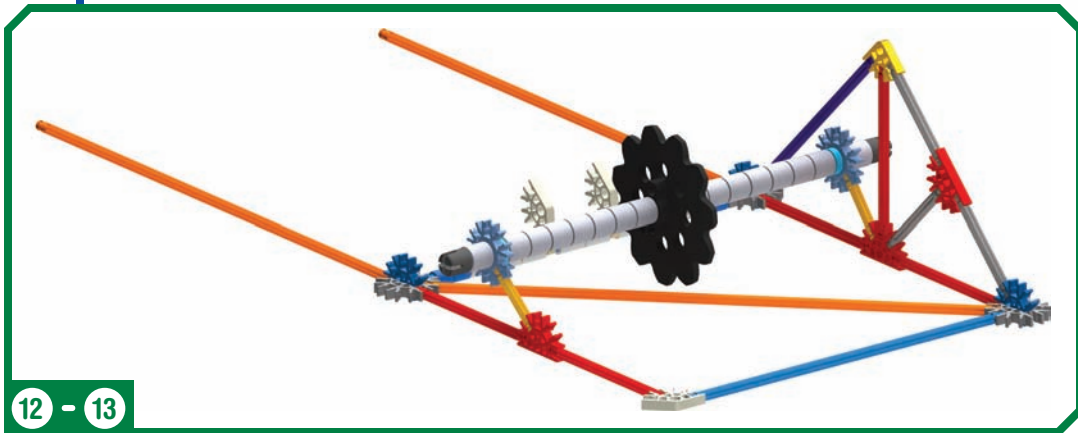
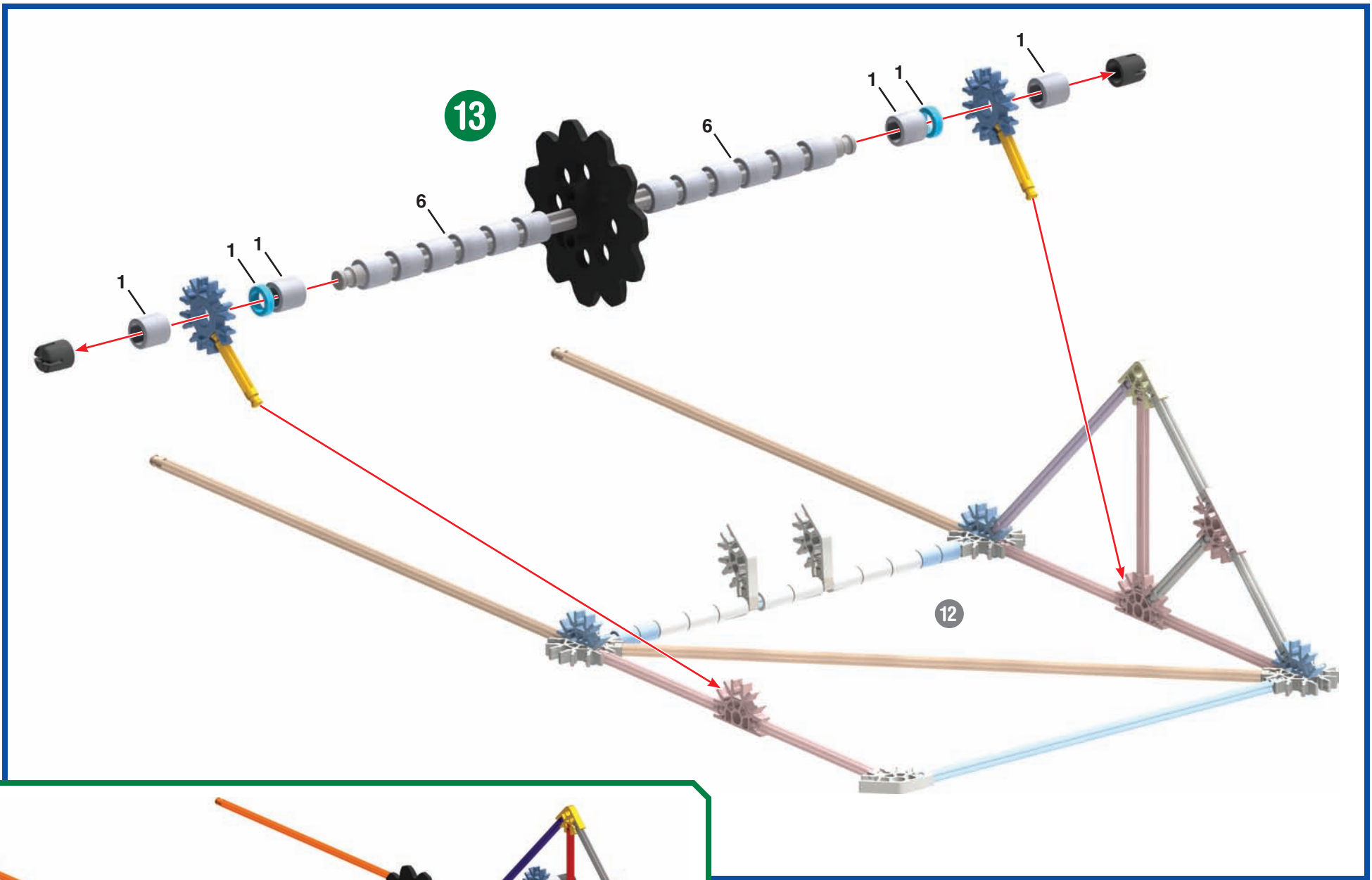

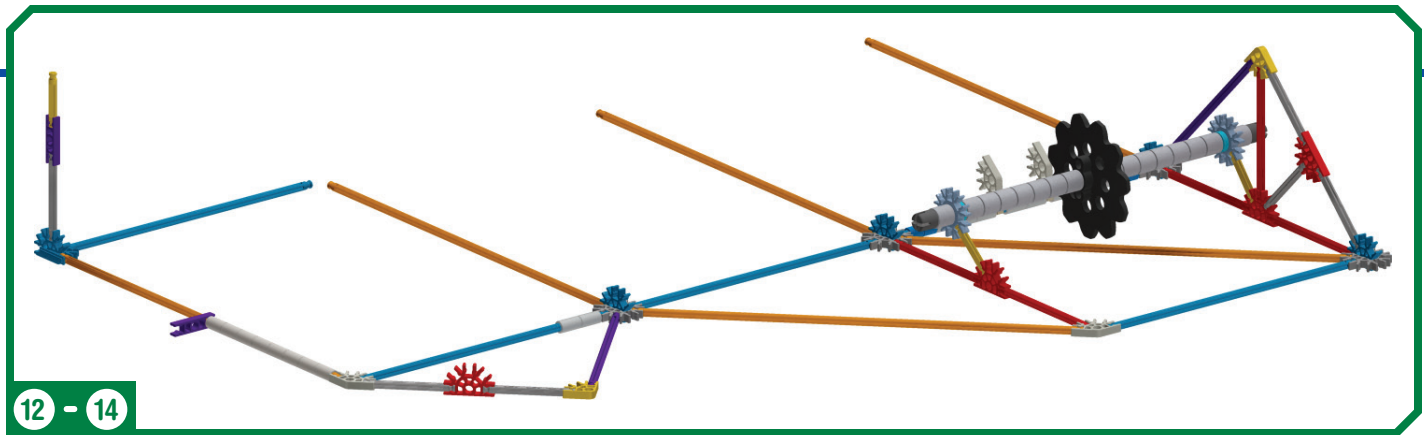
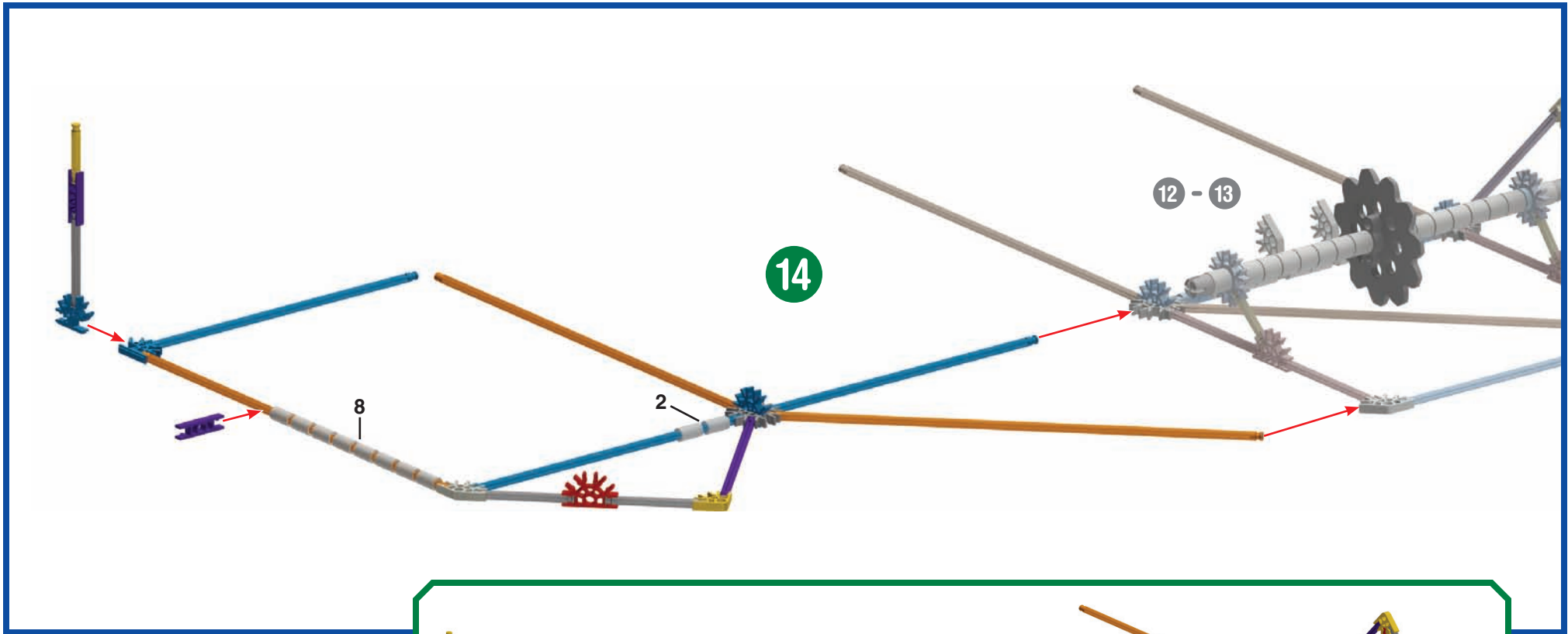

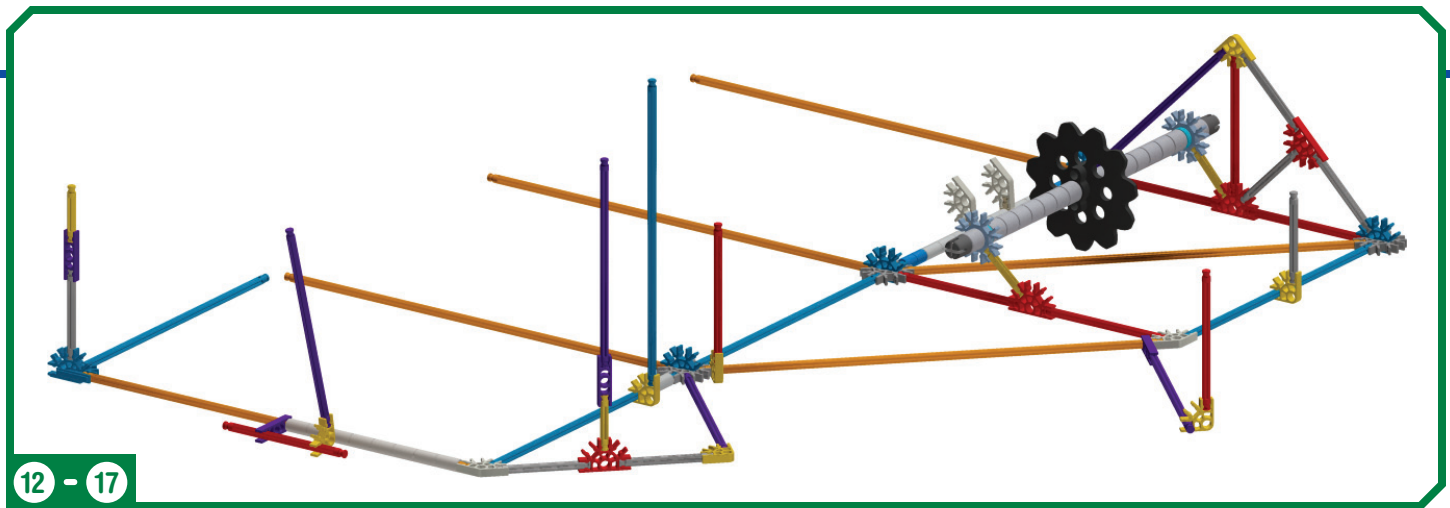
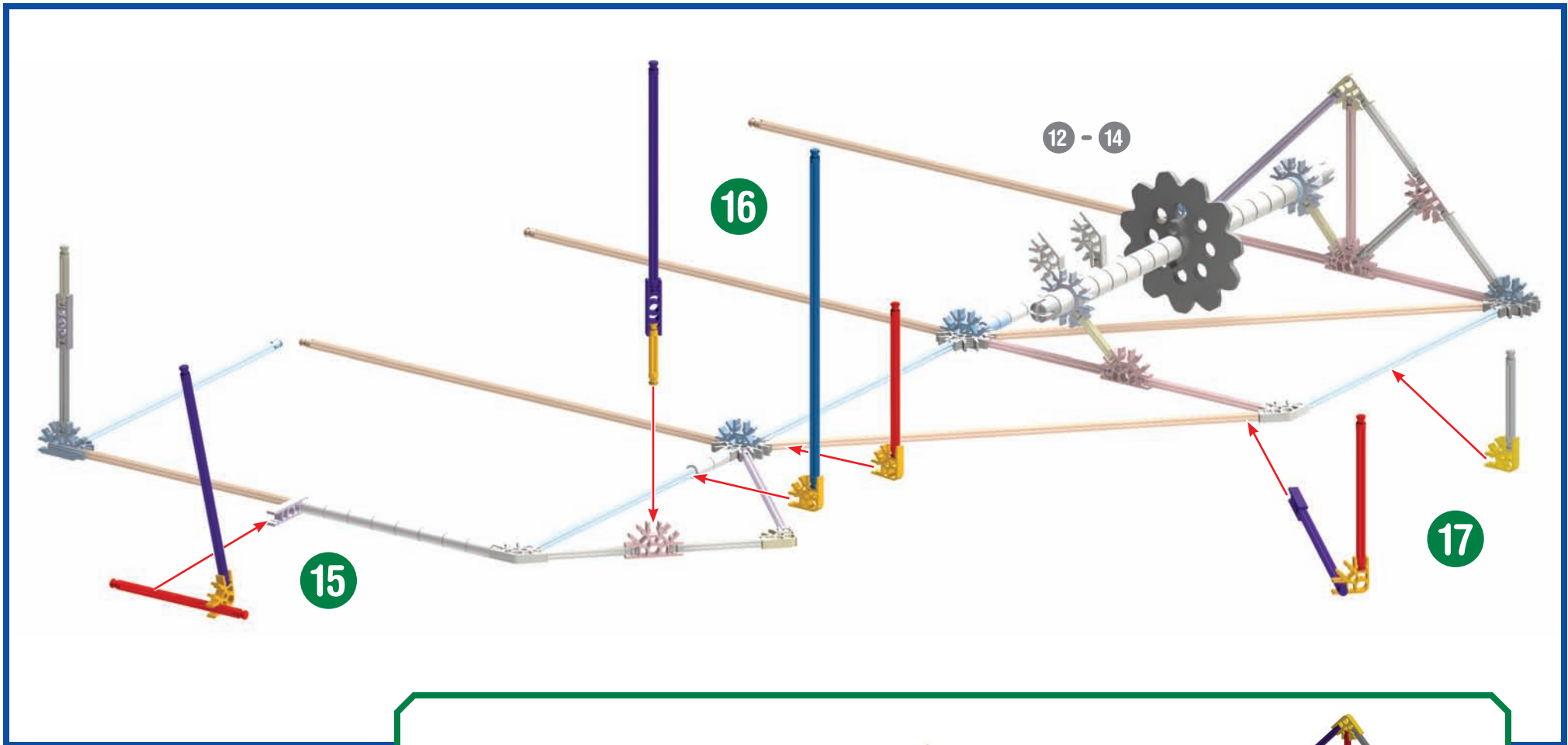

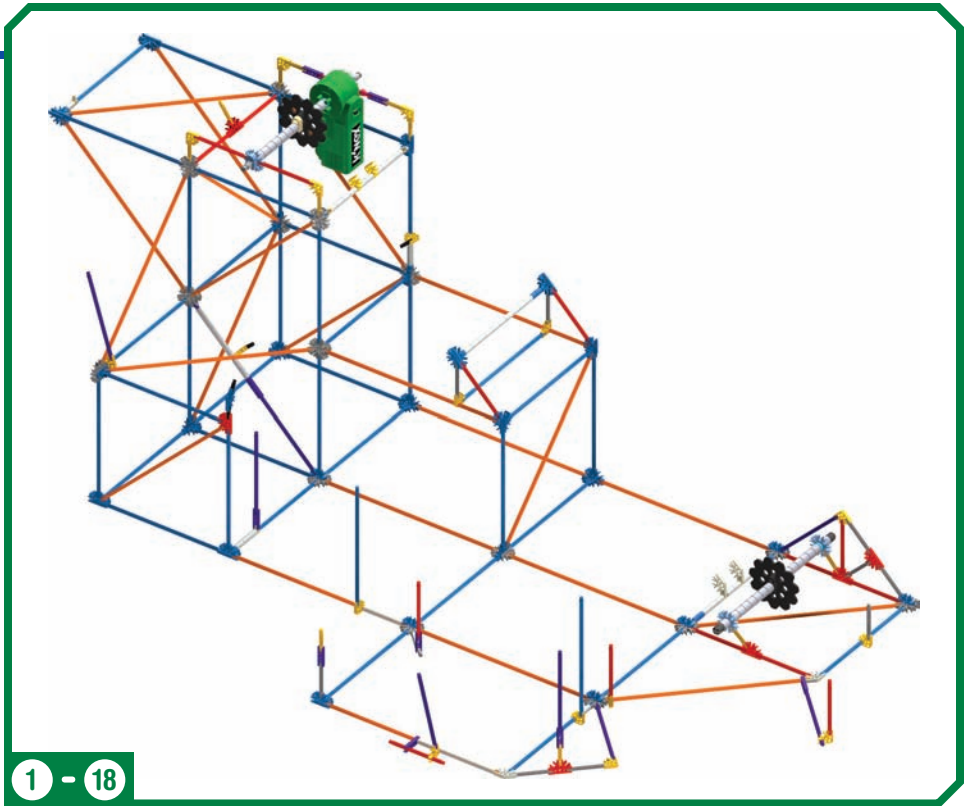
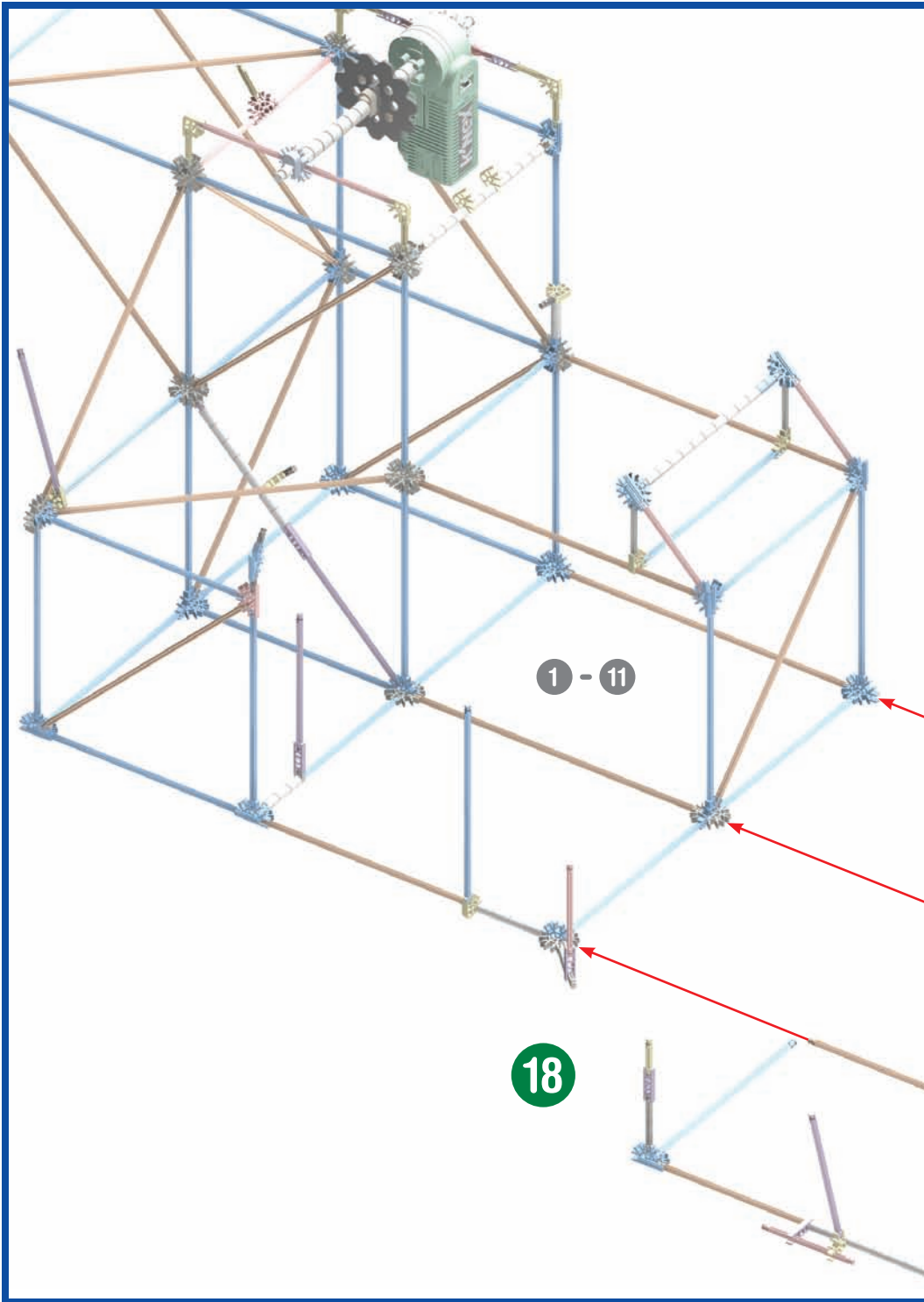

18

12 - 17

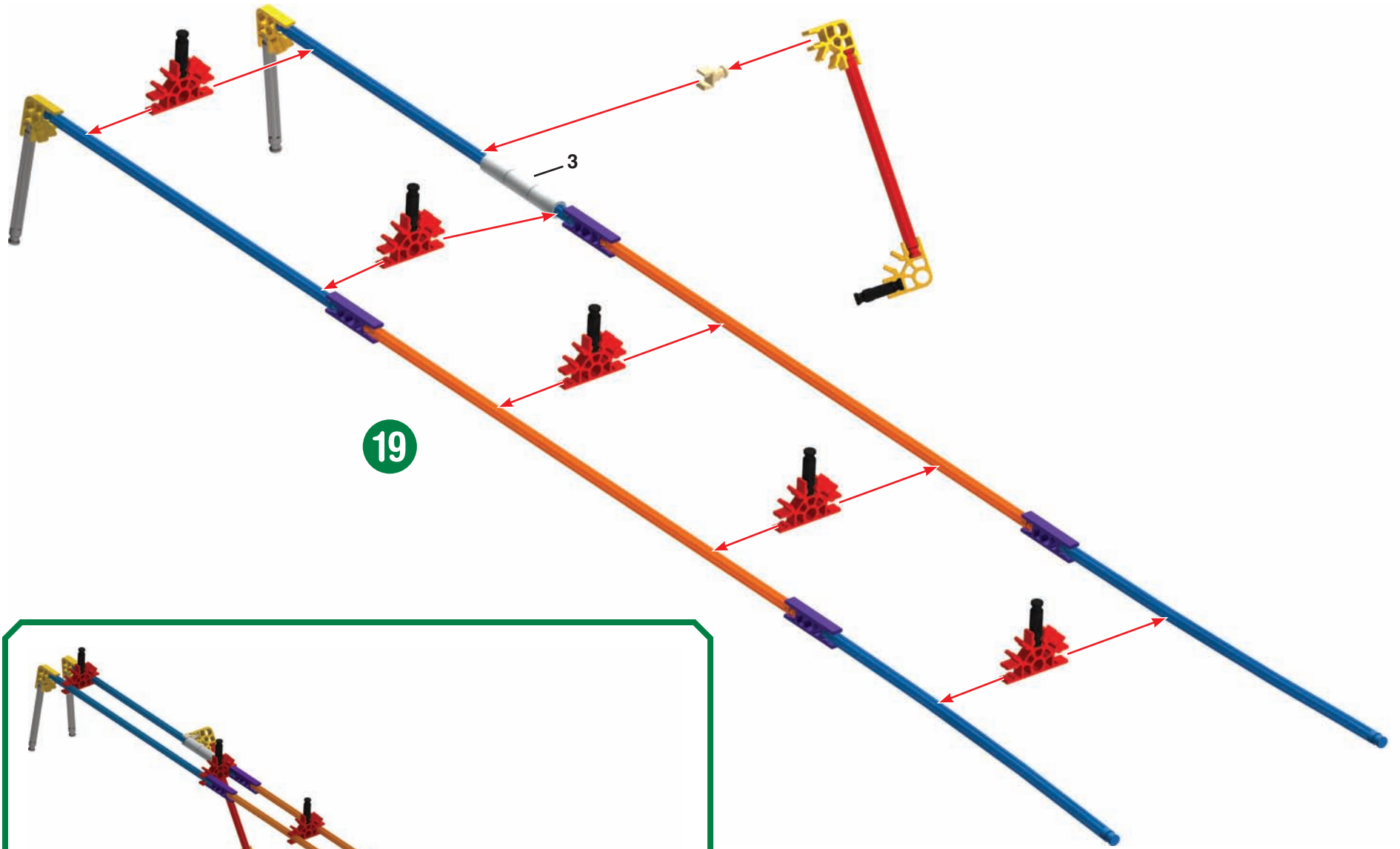

19

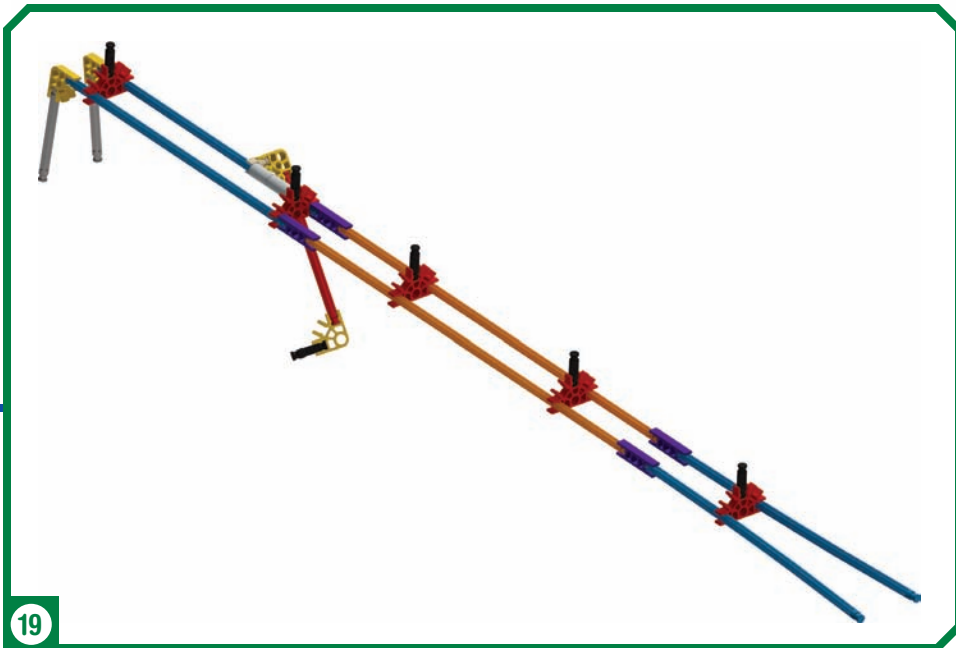

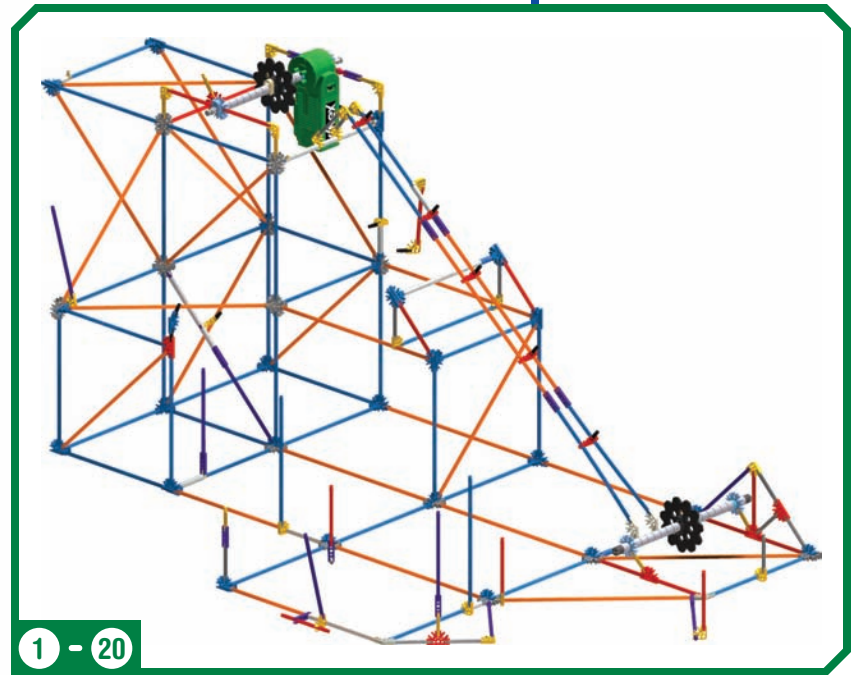
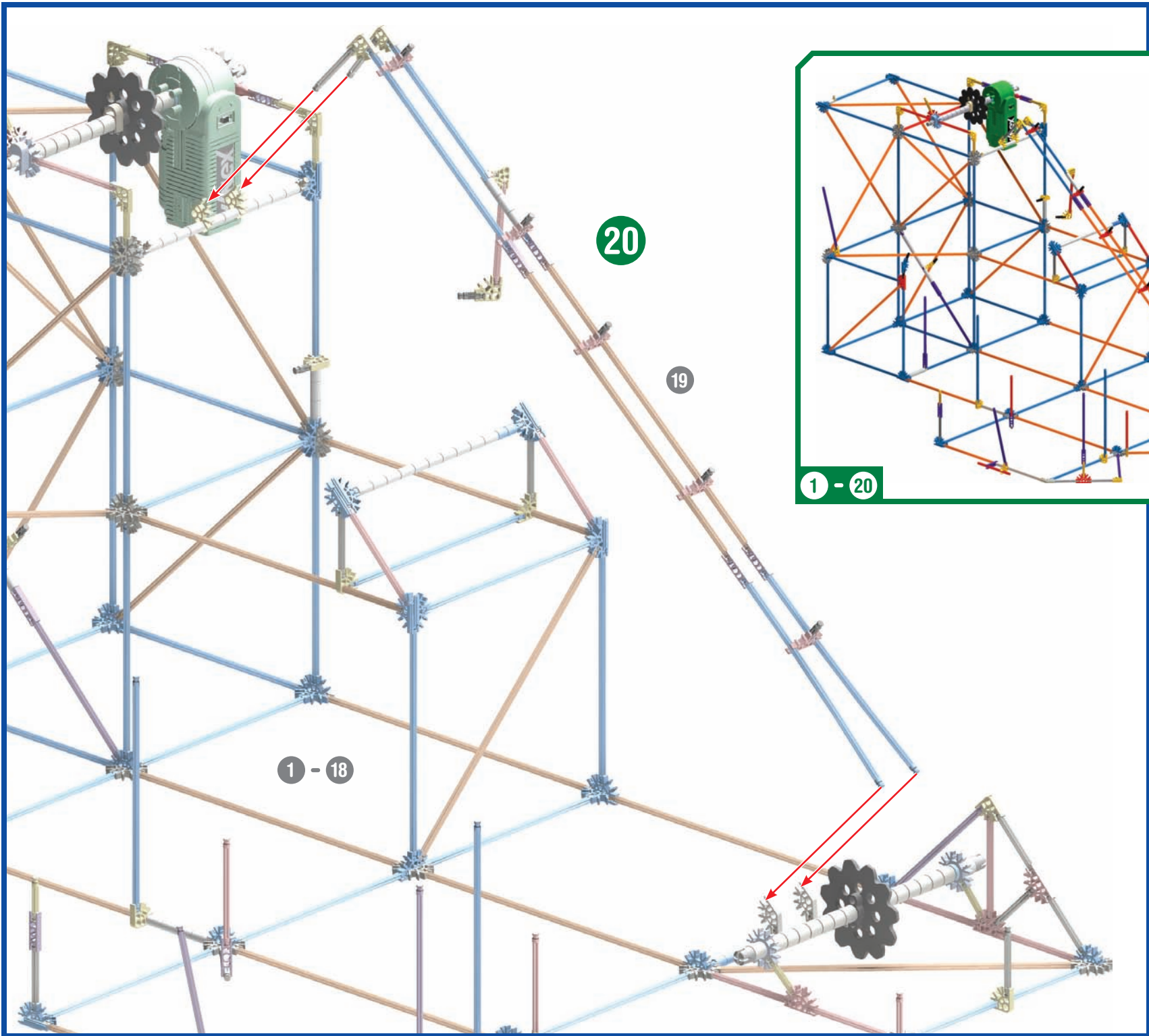

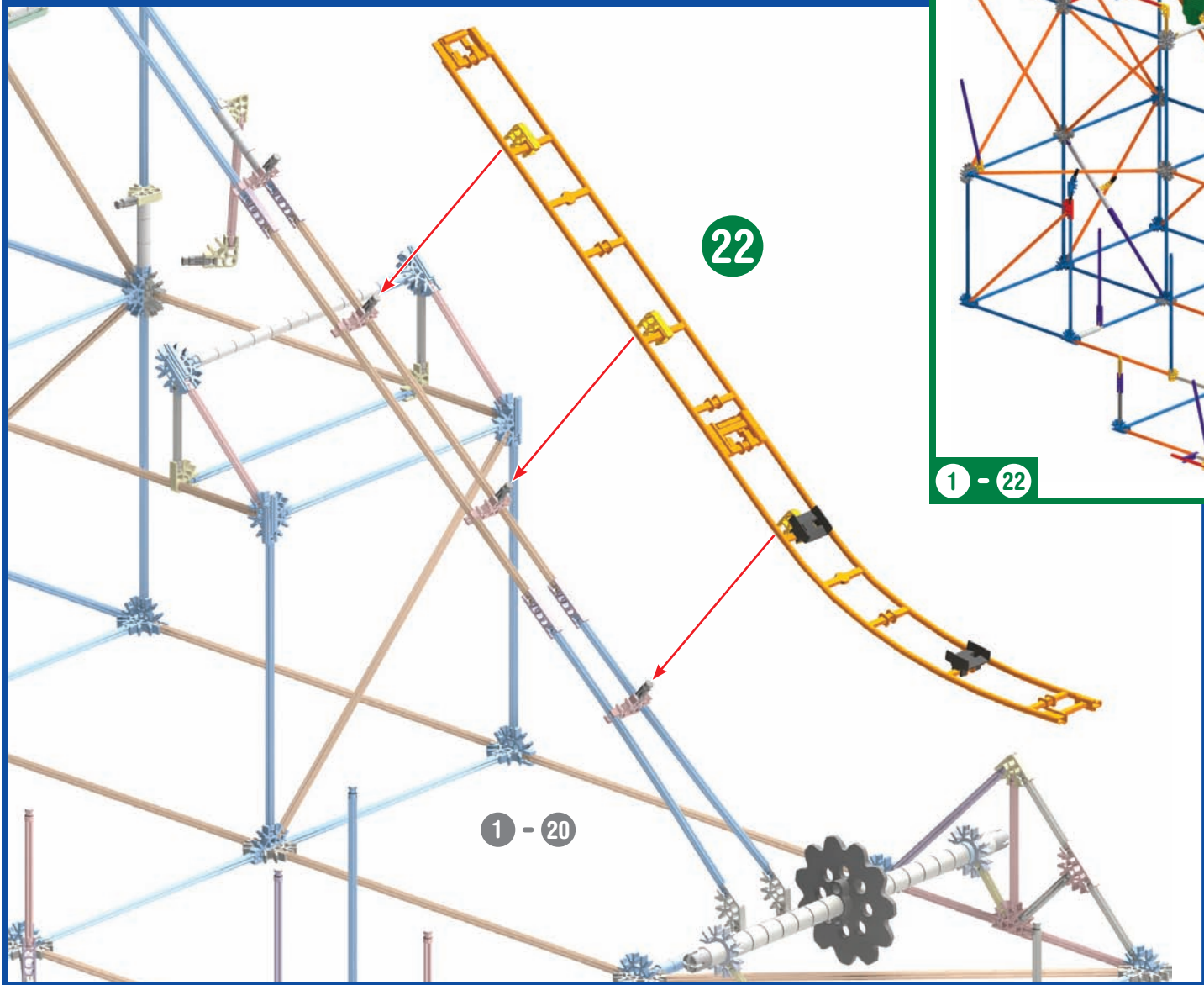
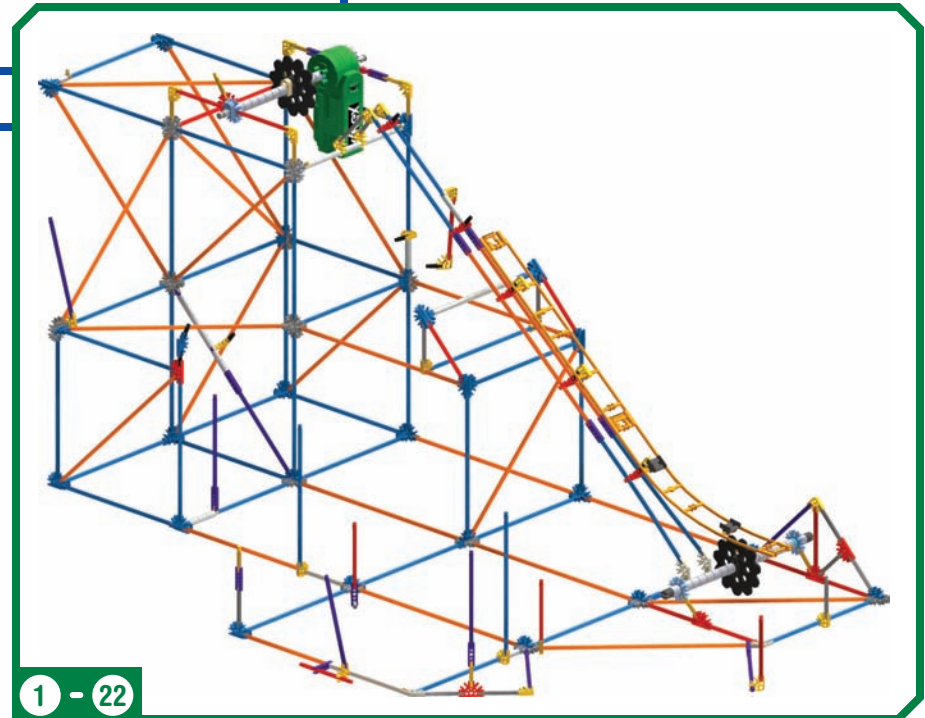
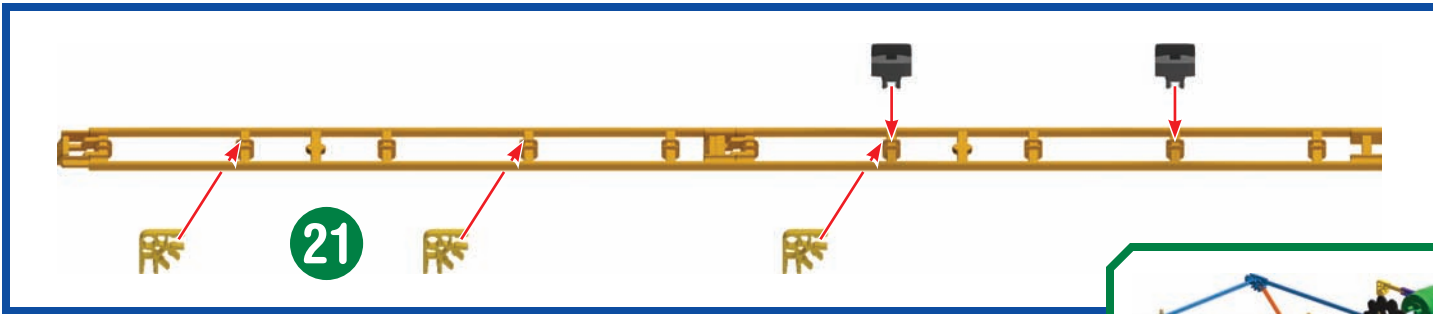

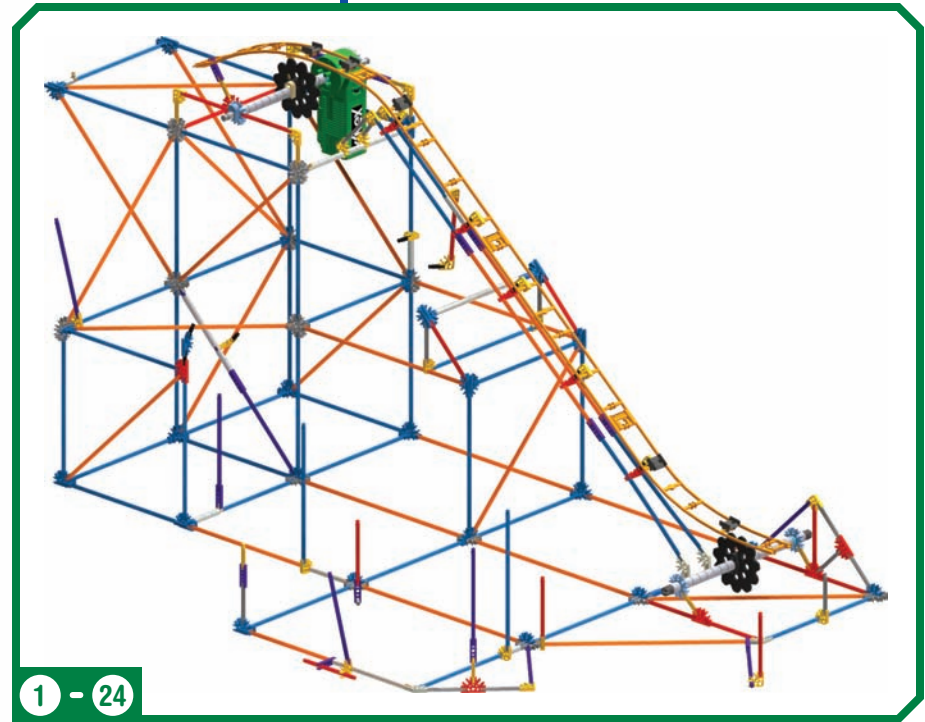
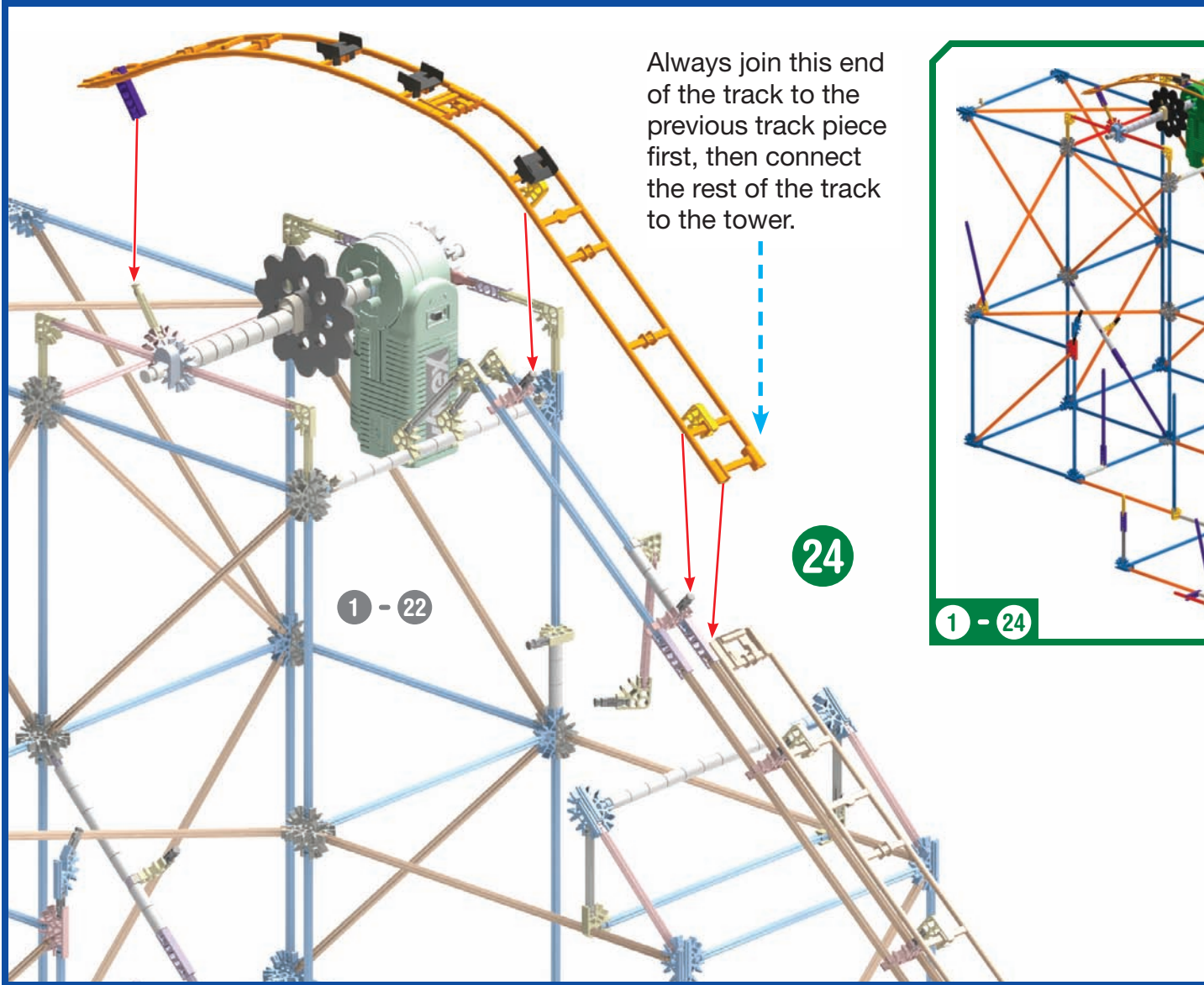
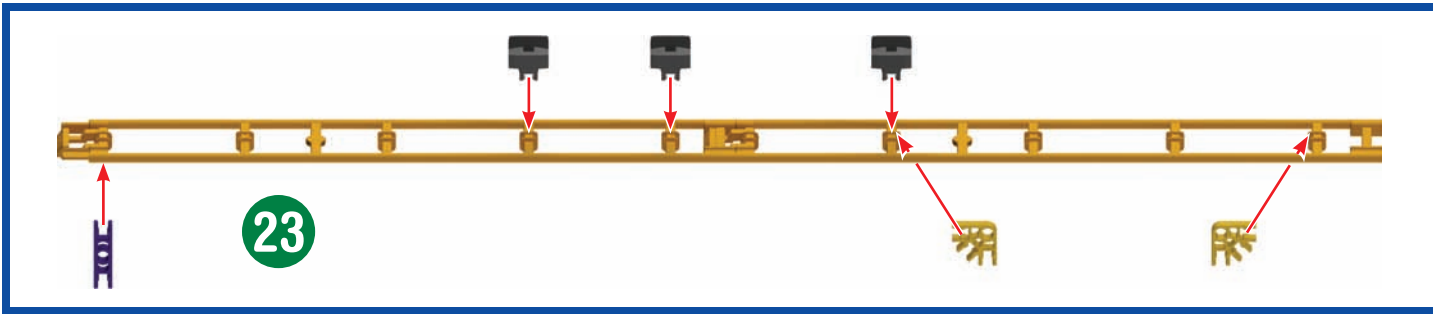

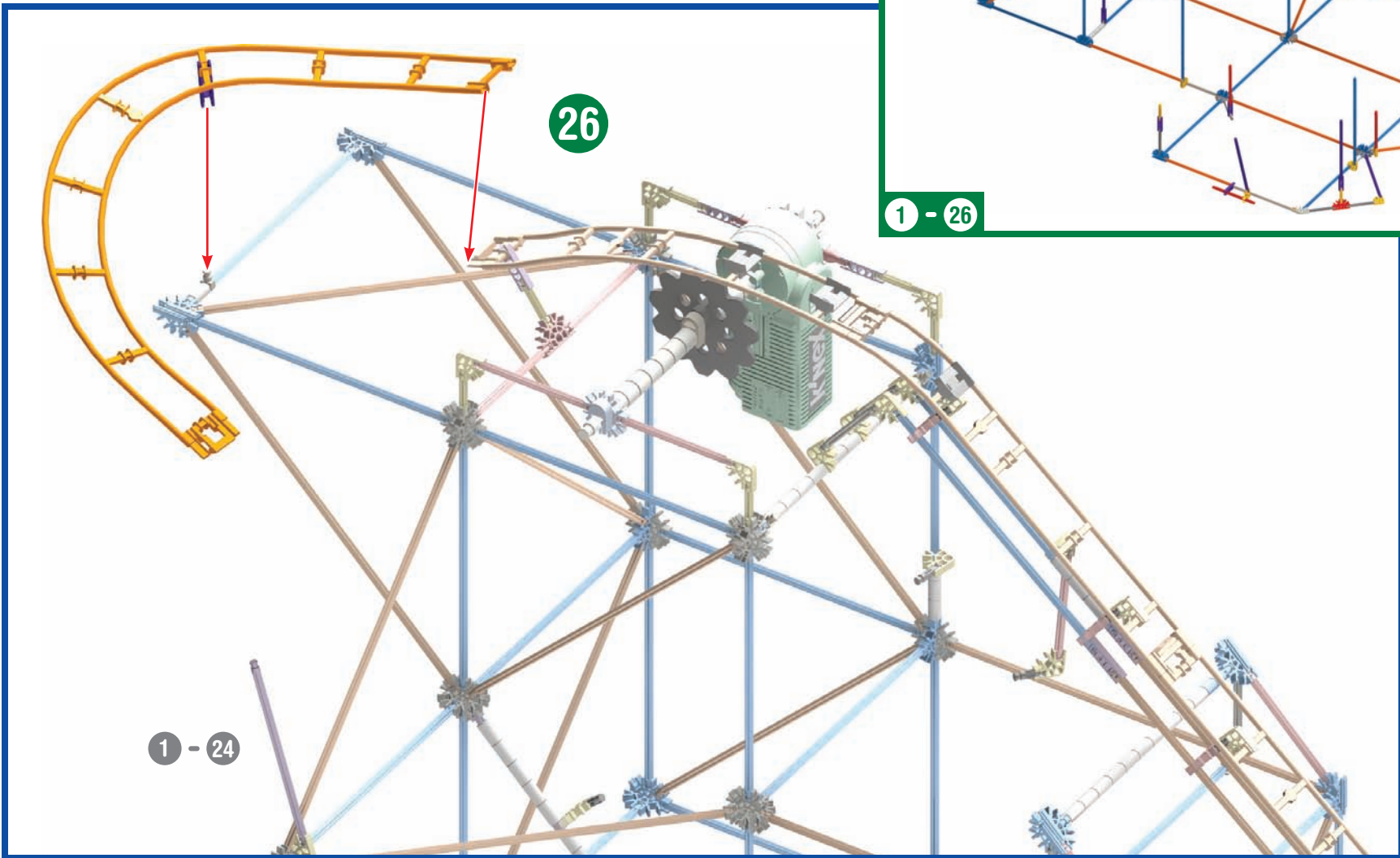
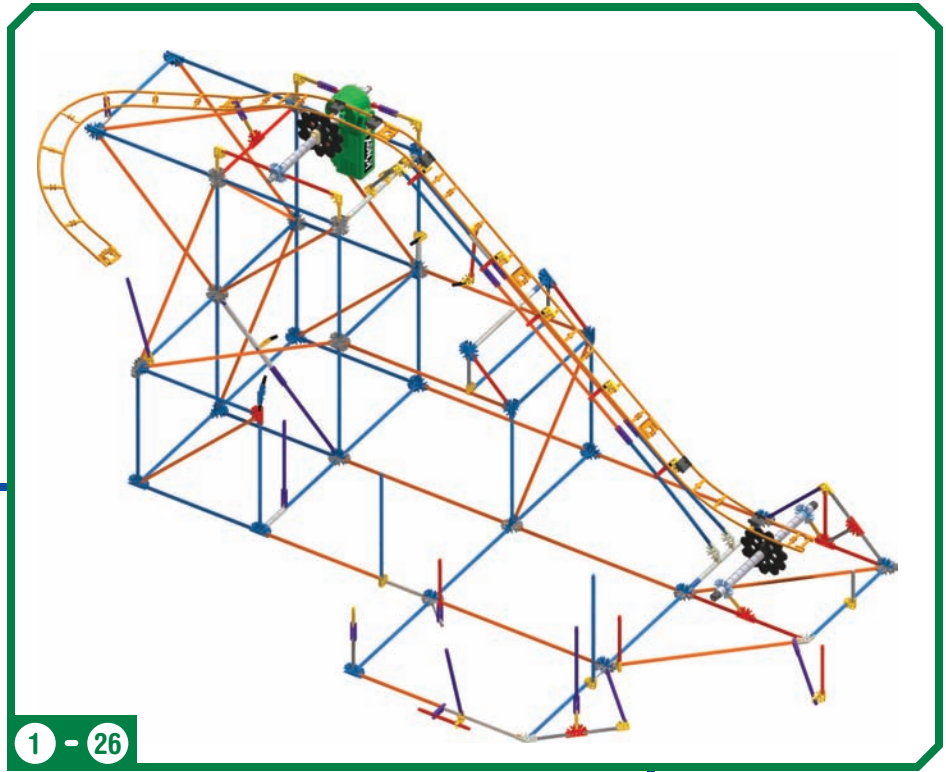
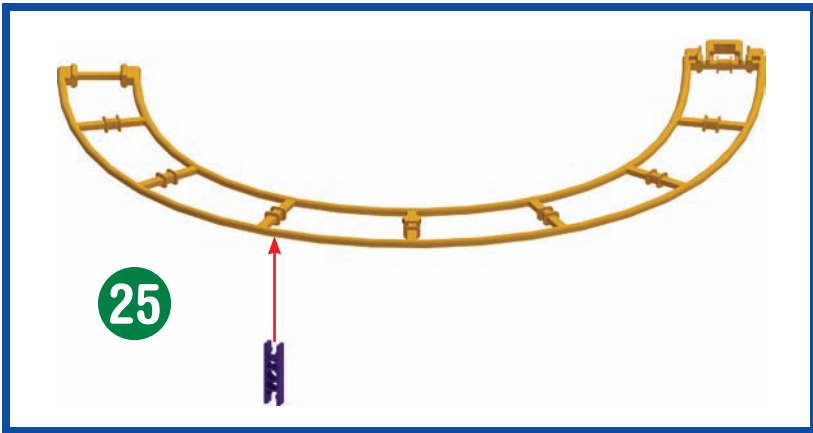

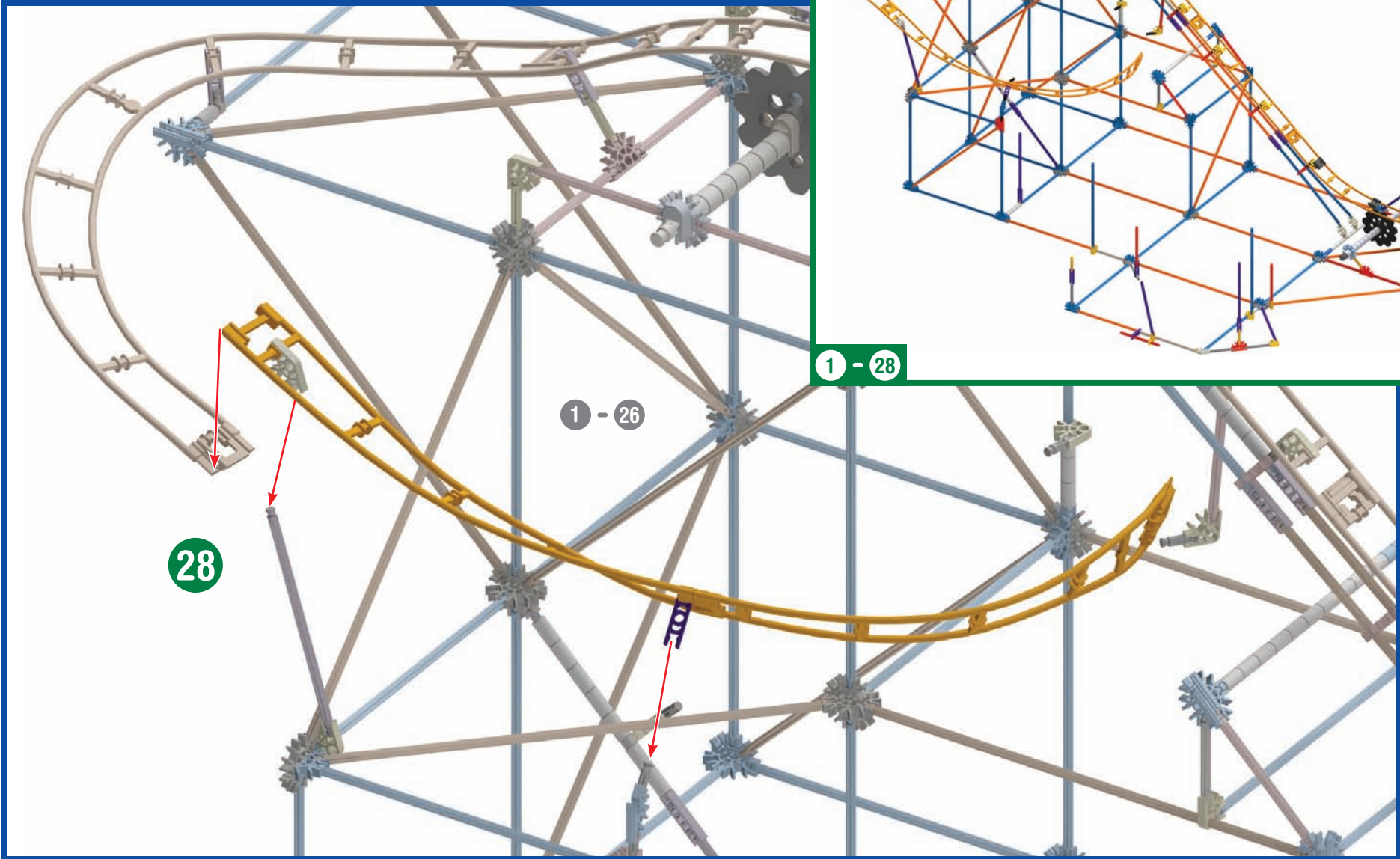
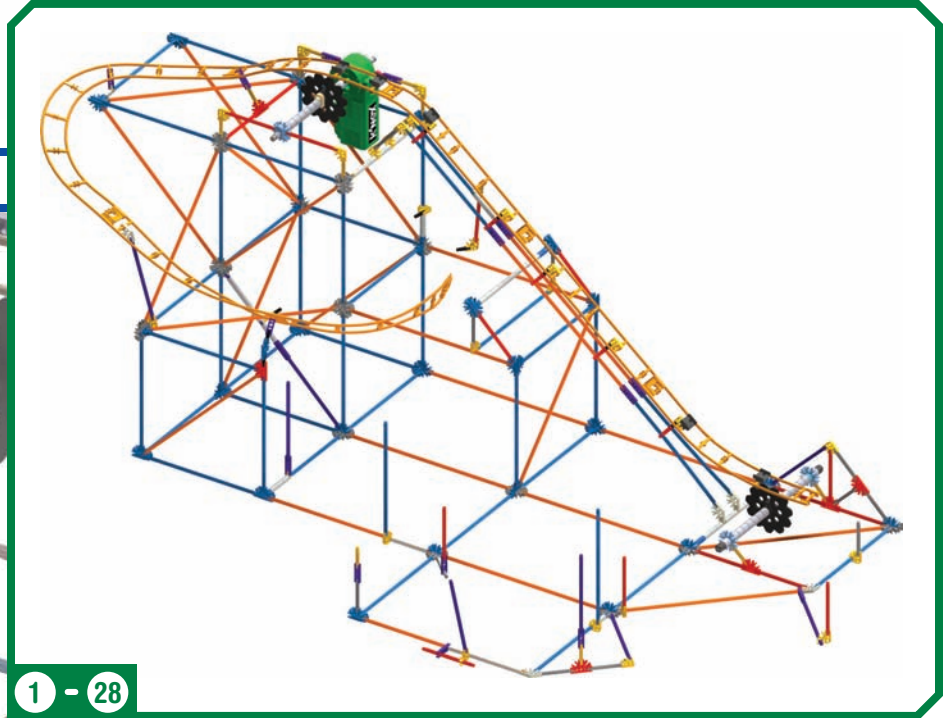
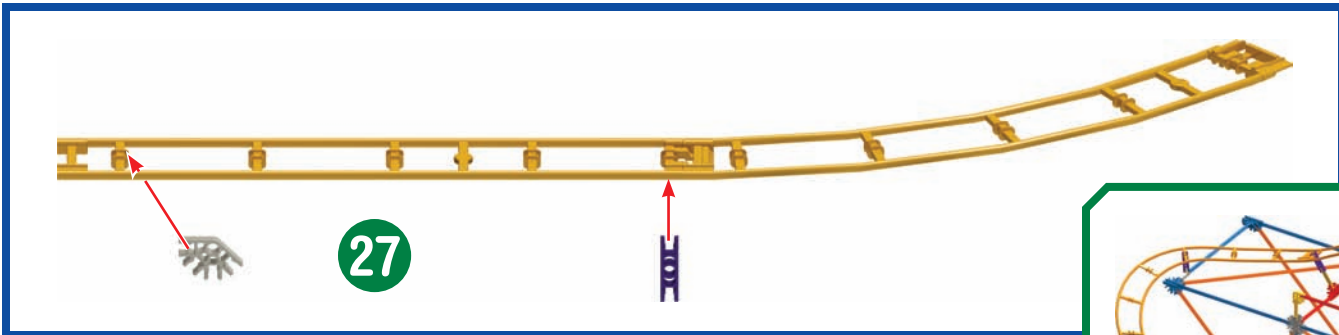

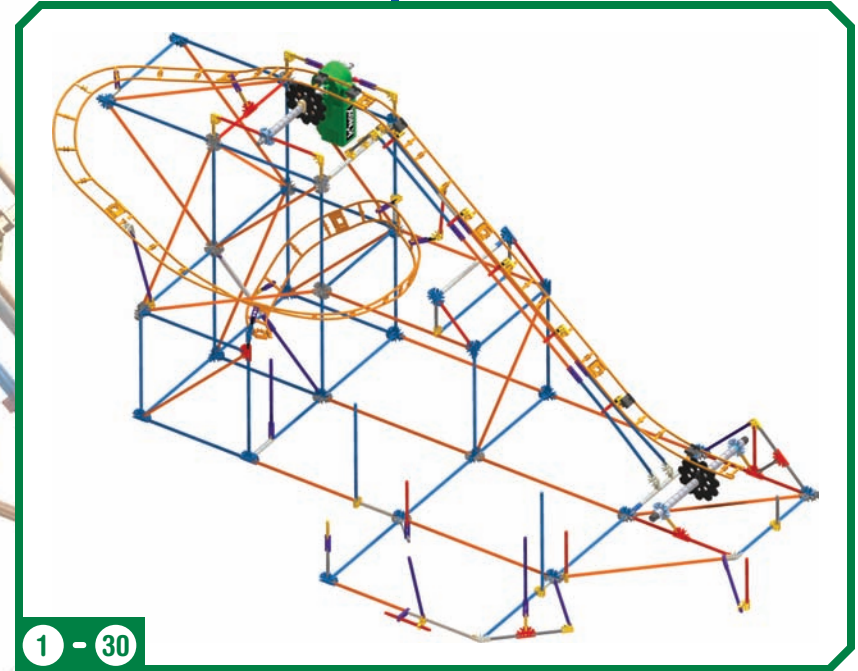
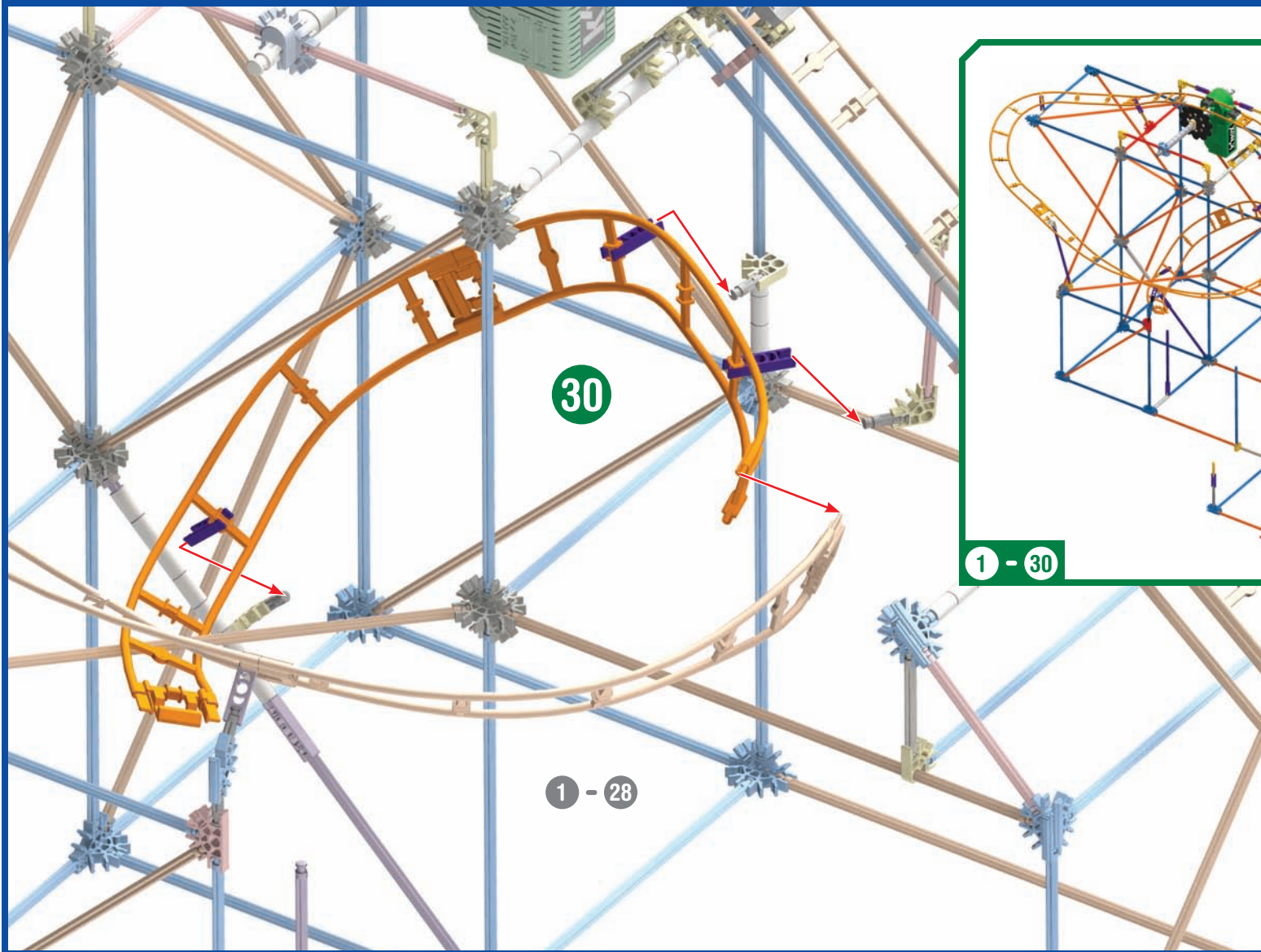

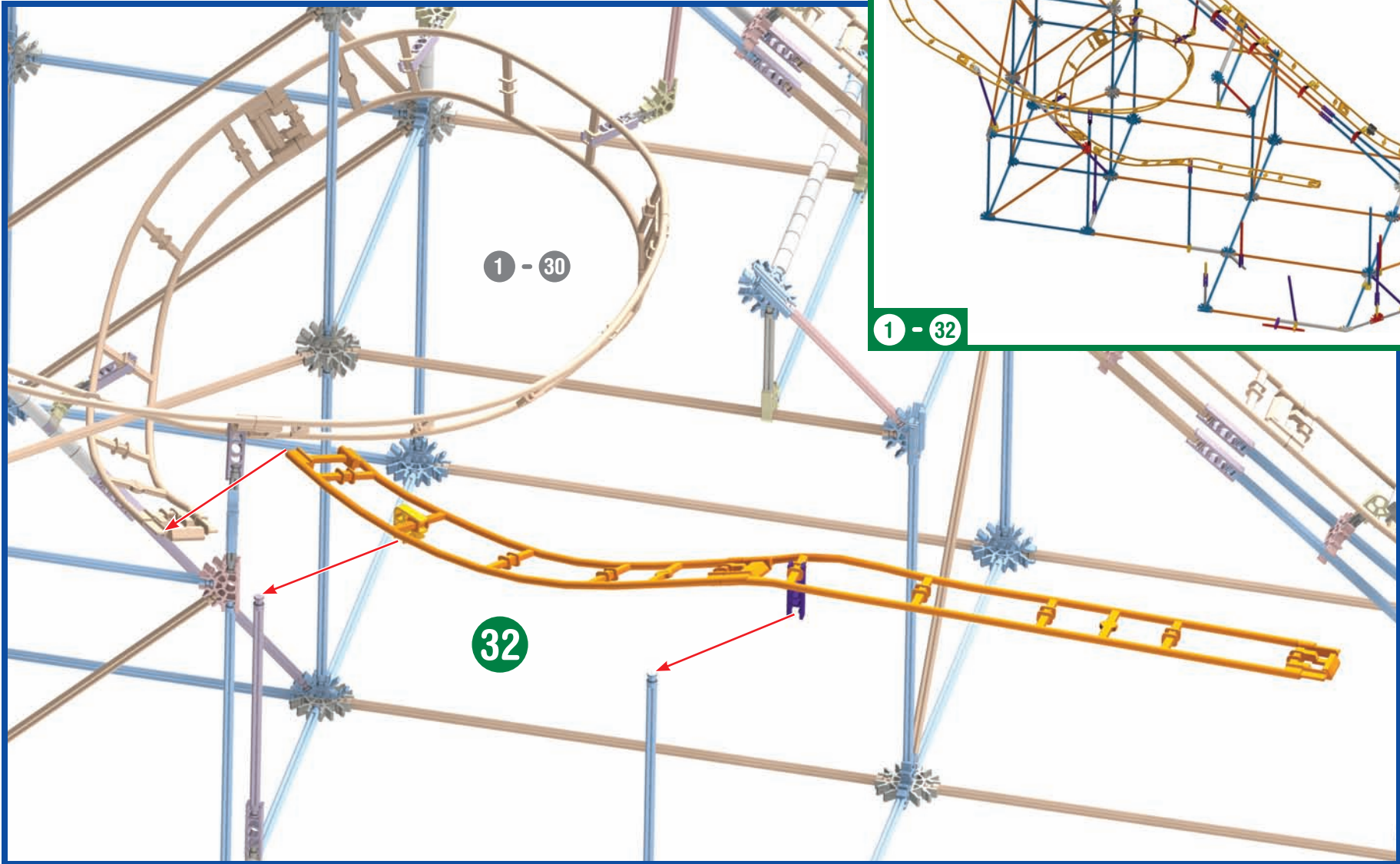
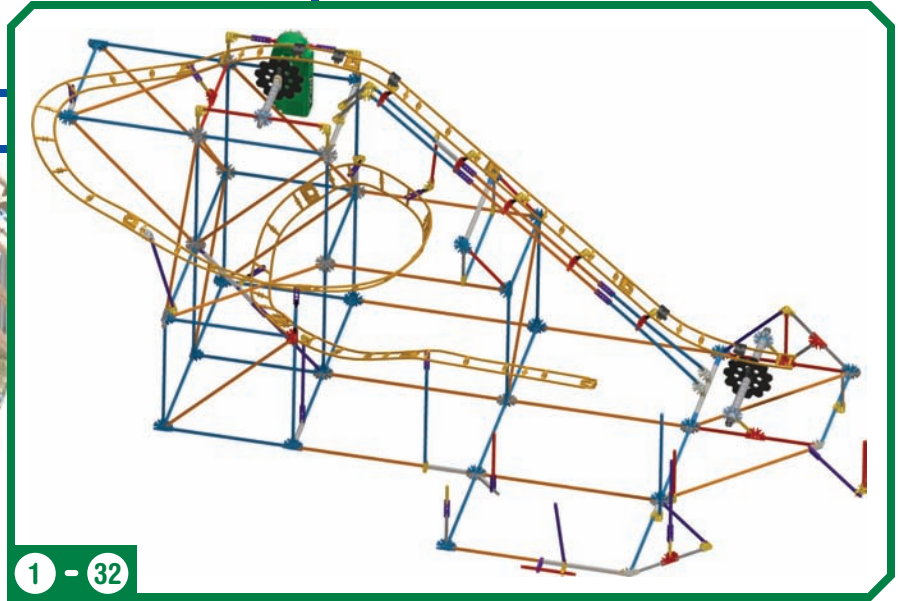
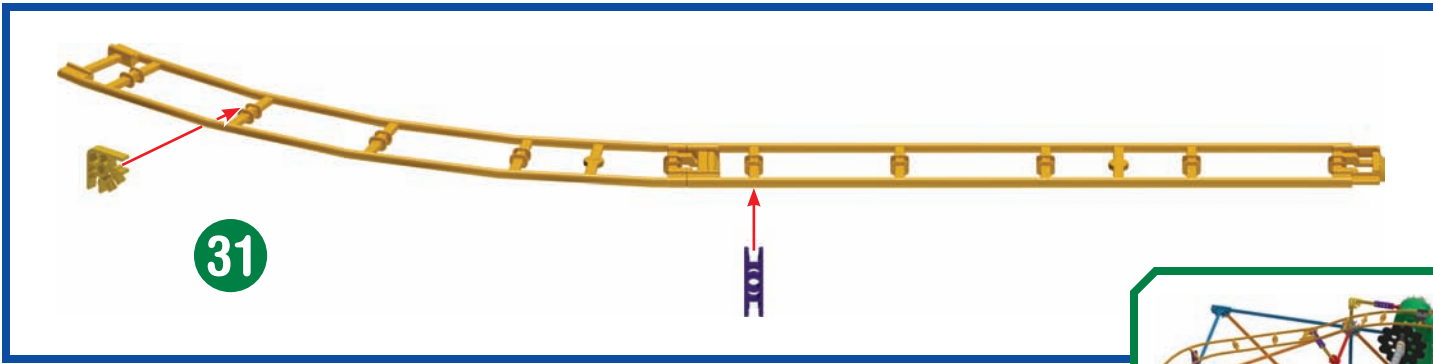

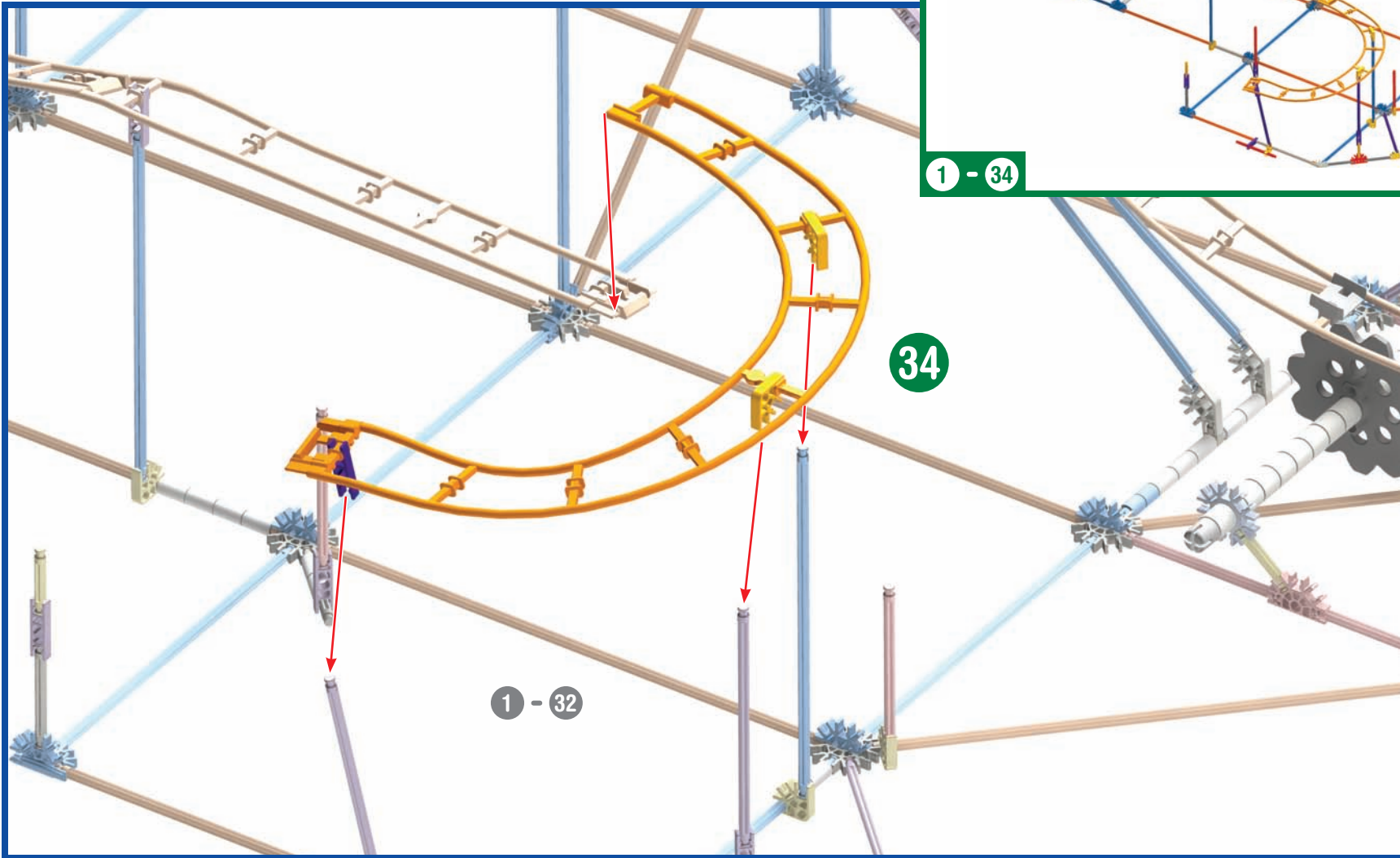
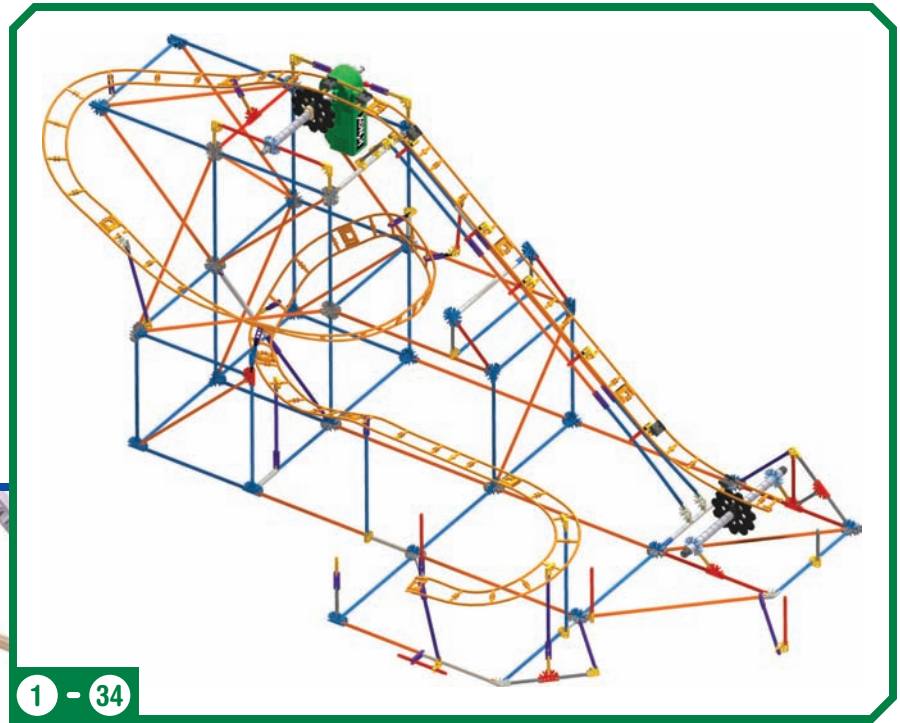
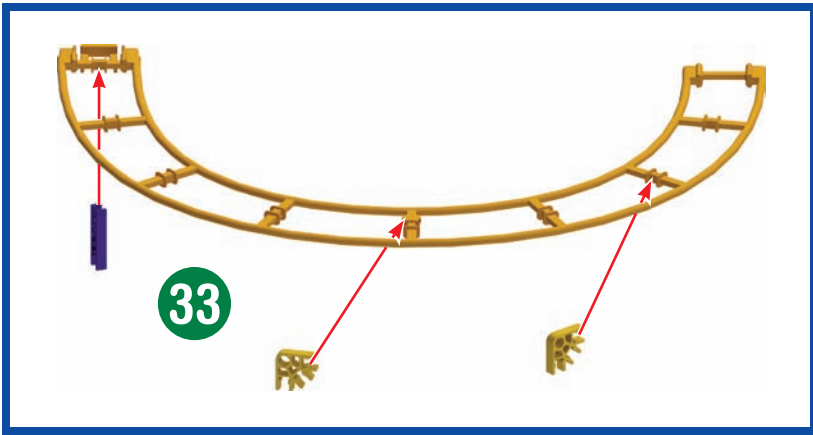

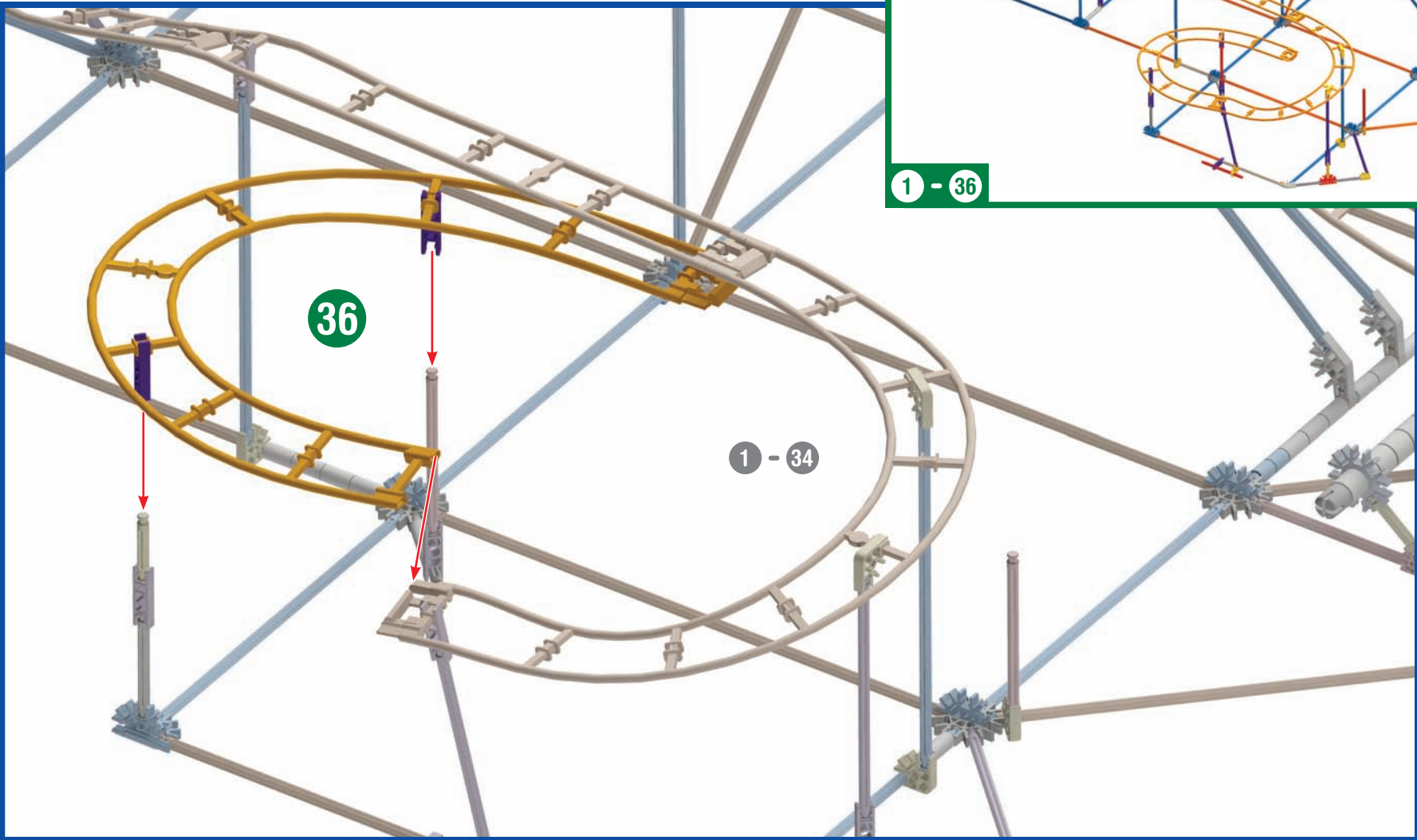
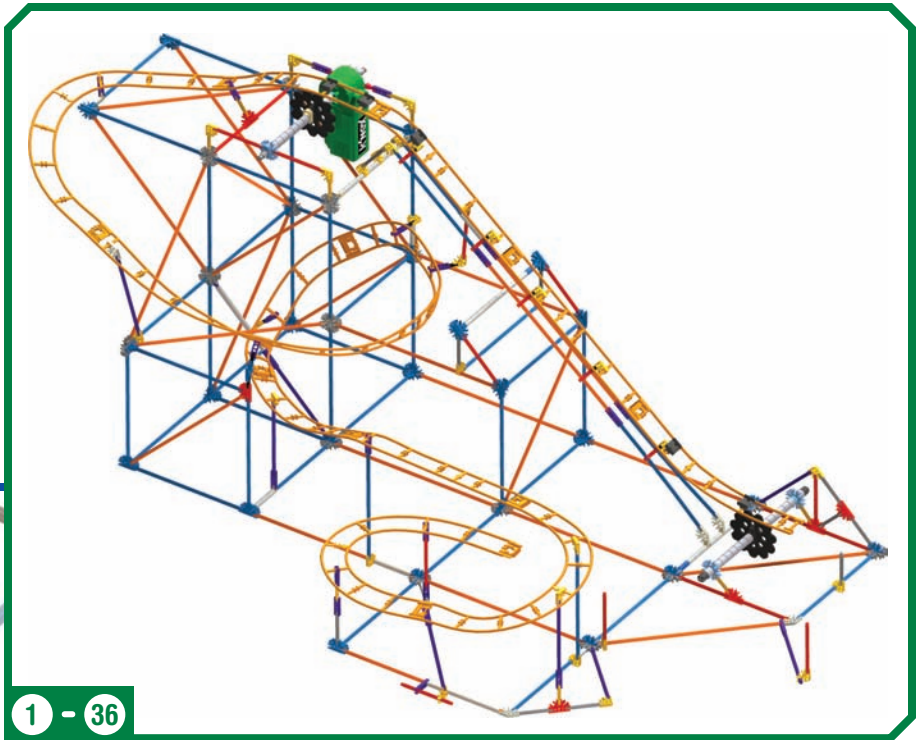
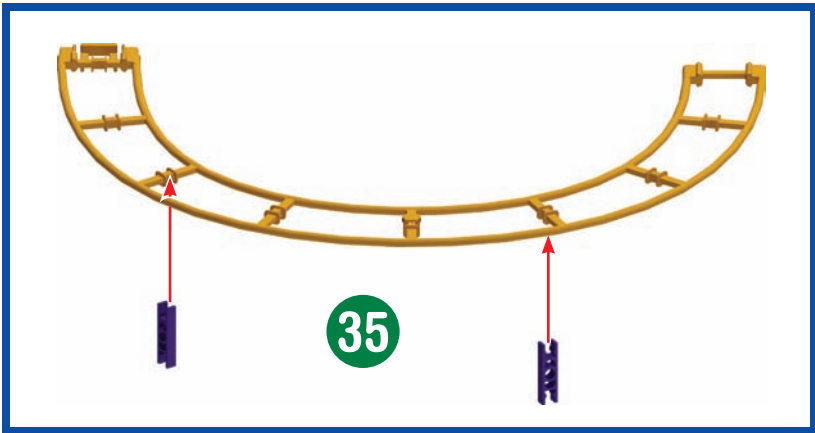

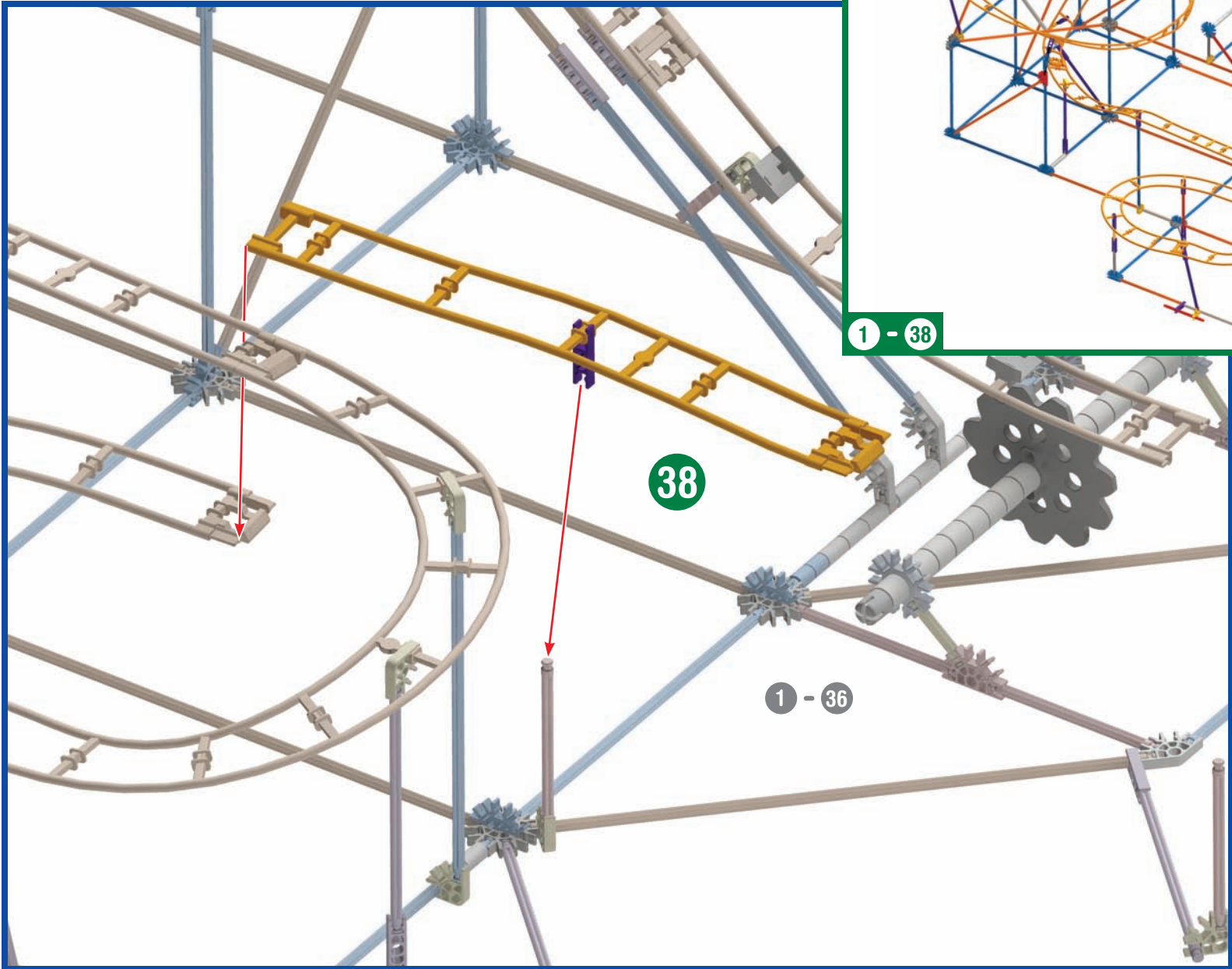
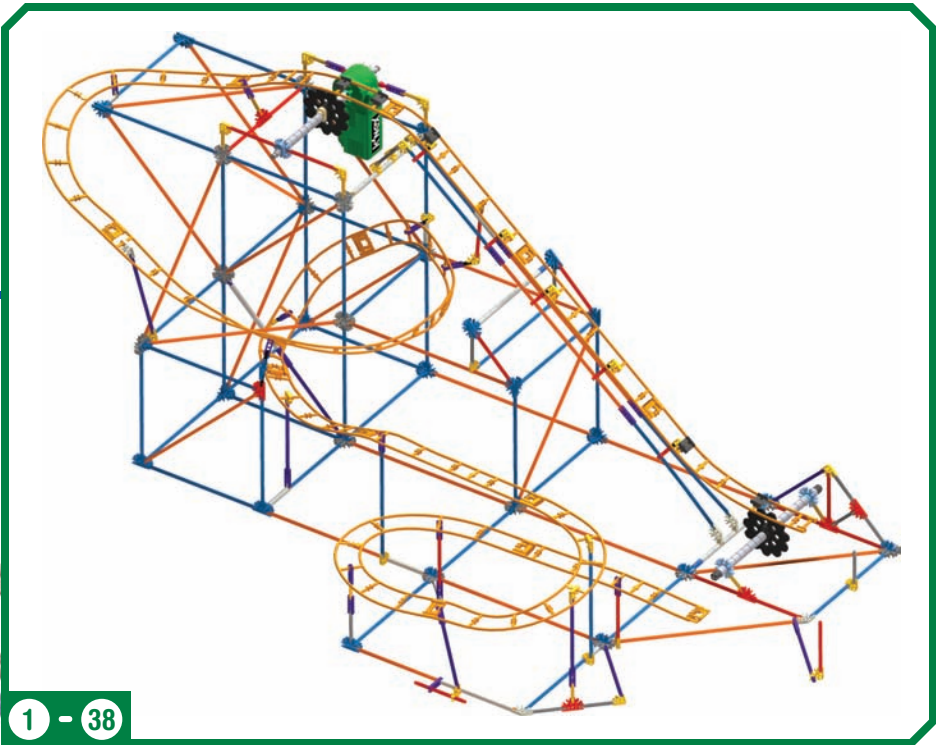
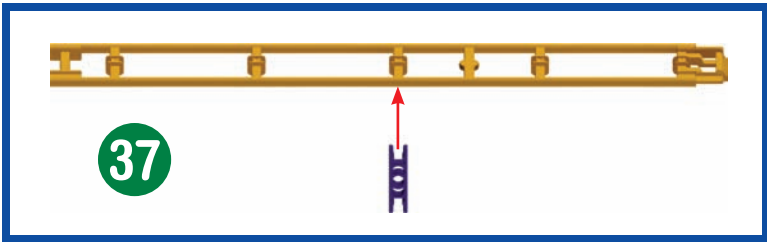

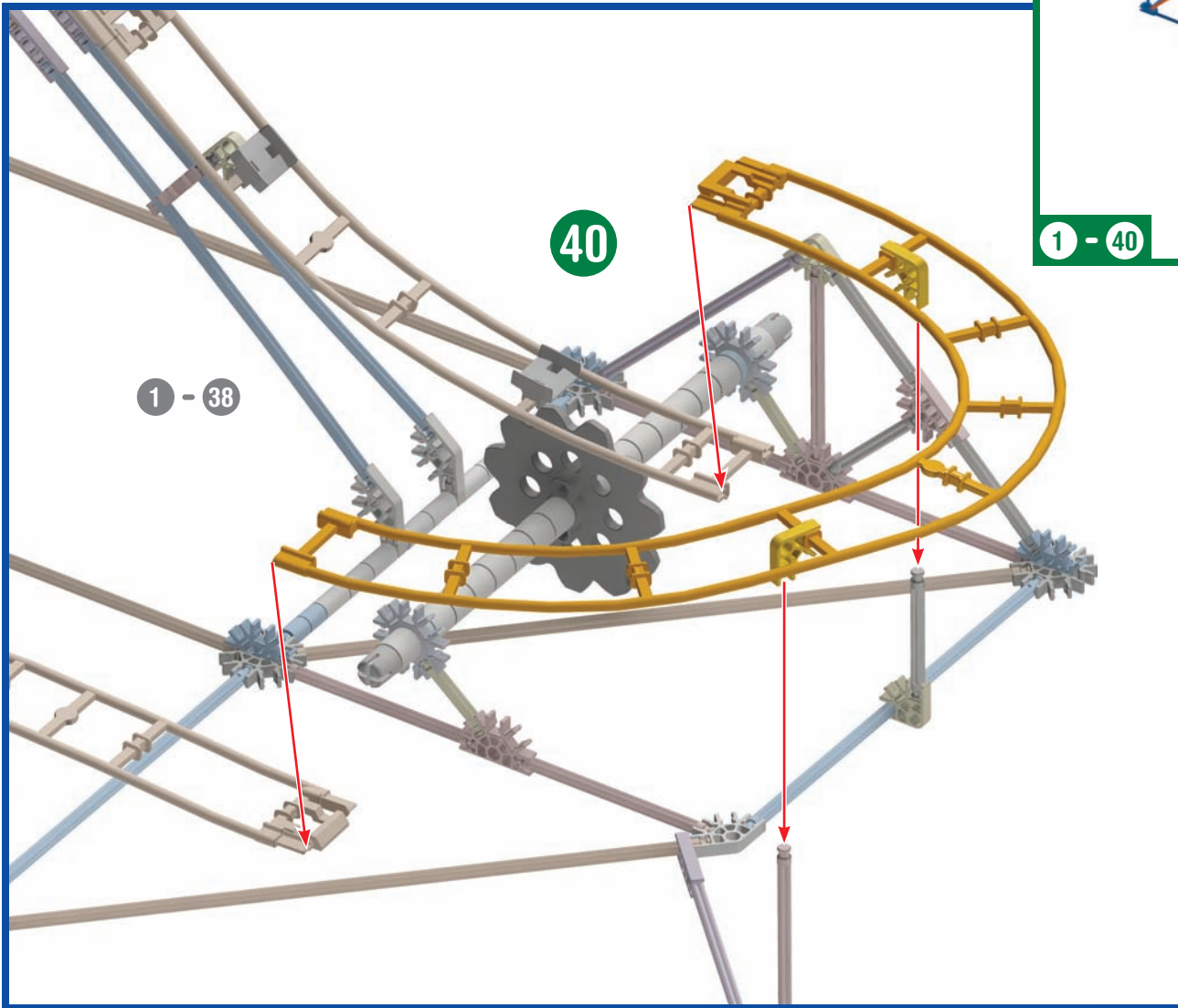
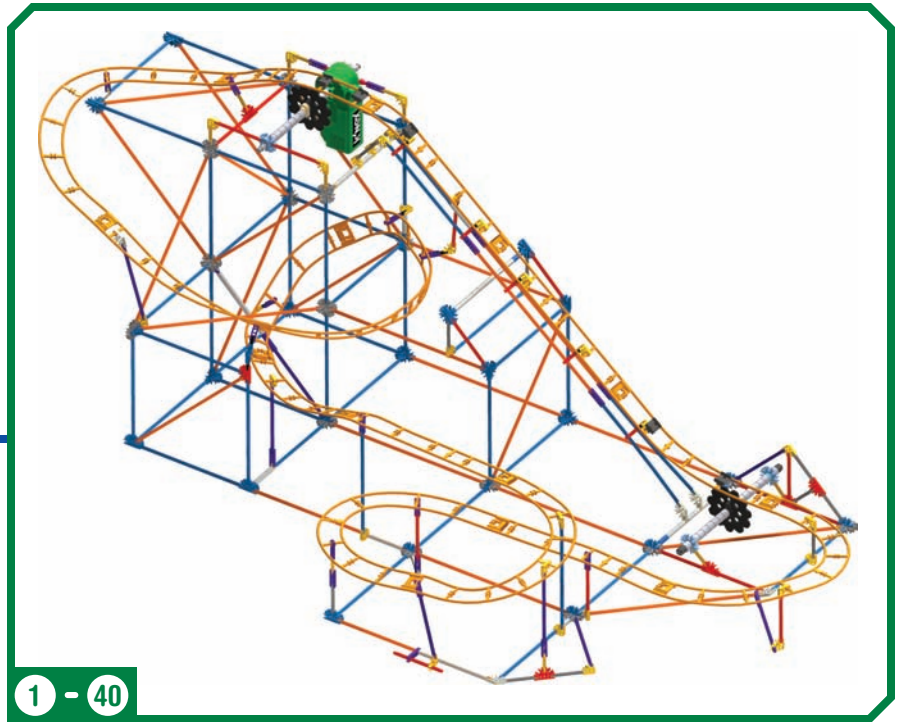
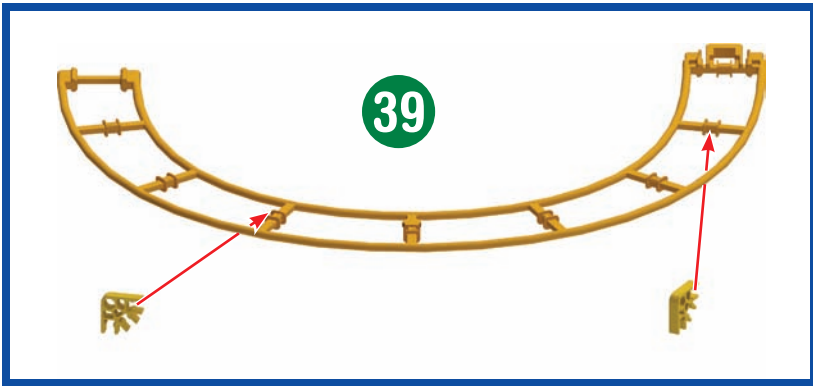



IMPORTANT: Attach all the chain links in the same direction.

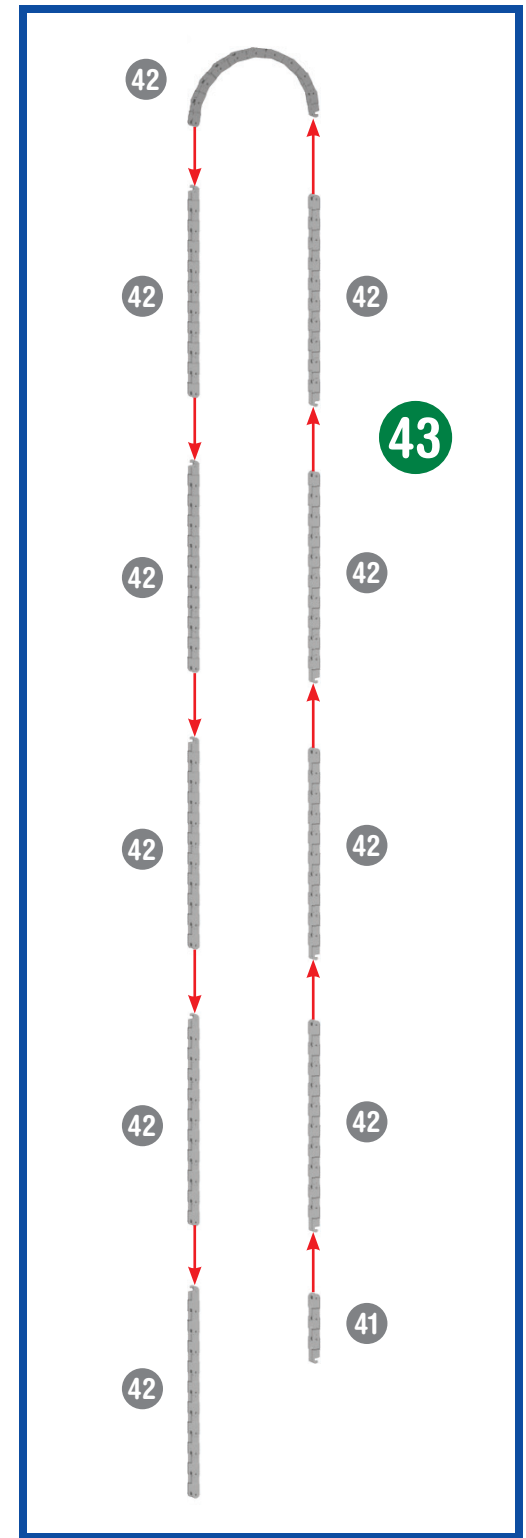
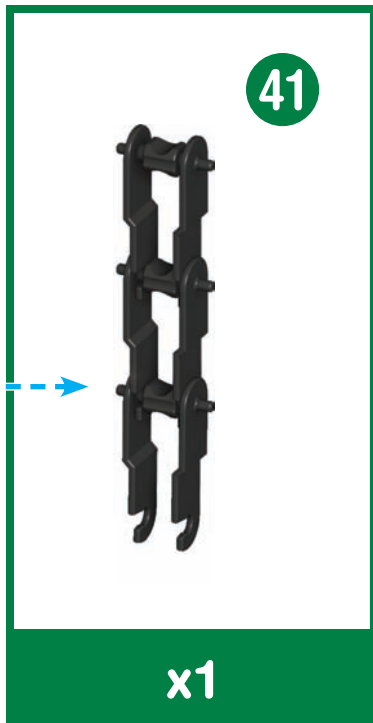

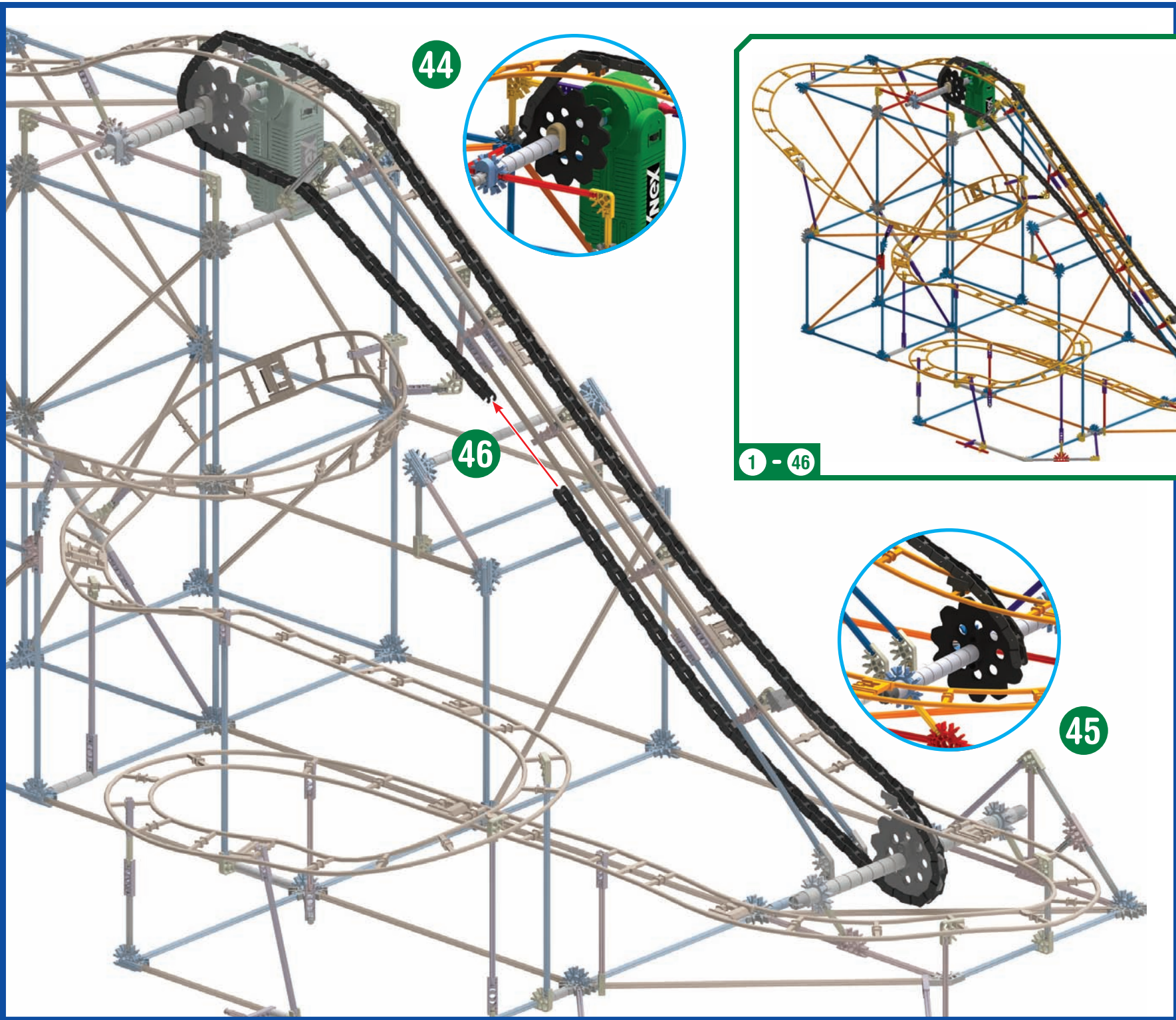

44

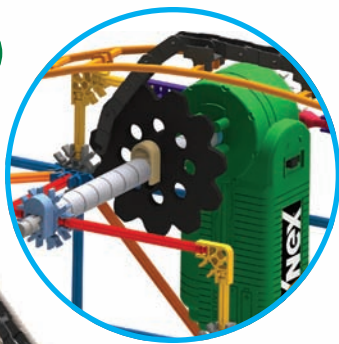

46

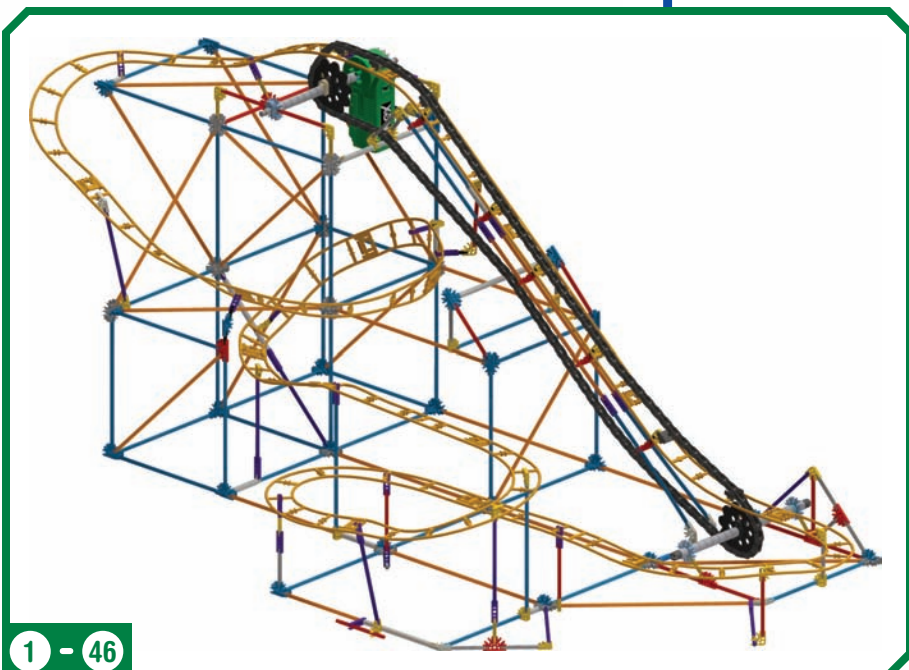

1 - 46



45



47

To attach the car, undo a piece of track and then thread the car wheels over the top side of the track. Then join the track pieces together.

If the car gets stuck on the way down, make sure it is not hitting any K'NEX parts.



BRINK OF EXTINCT