

CONDOR'S CURVE COASTER

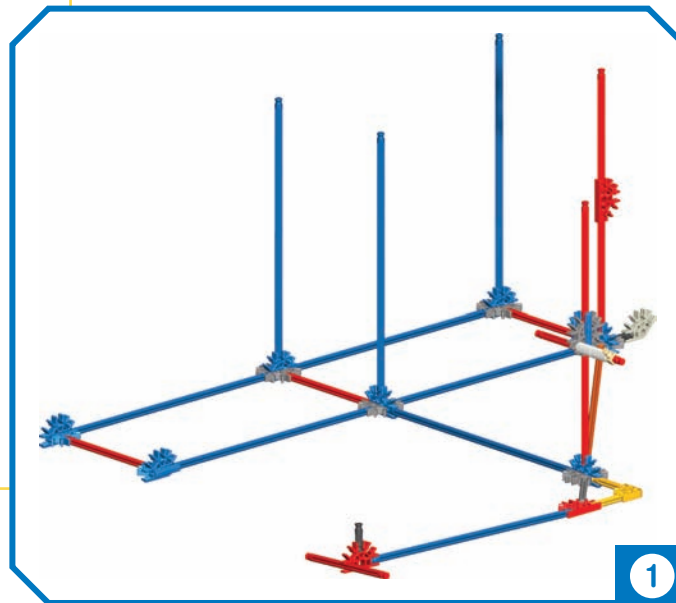

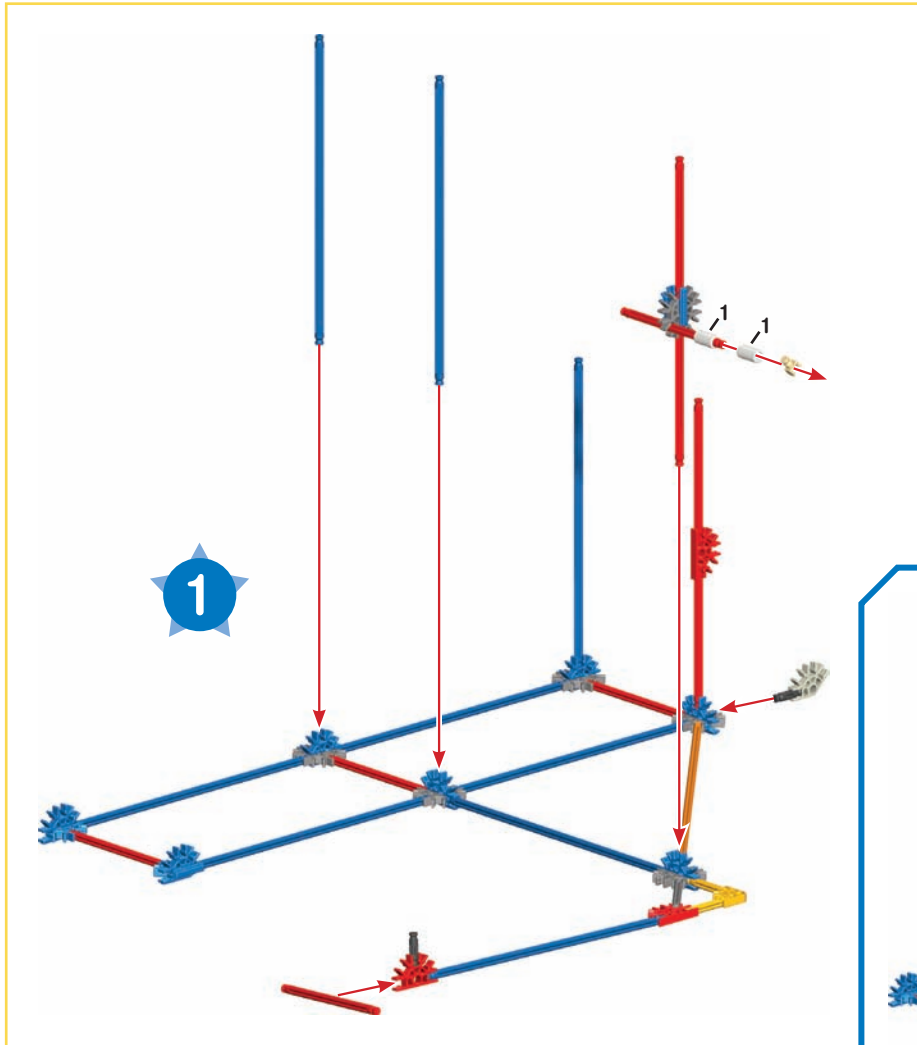

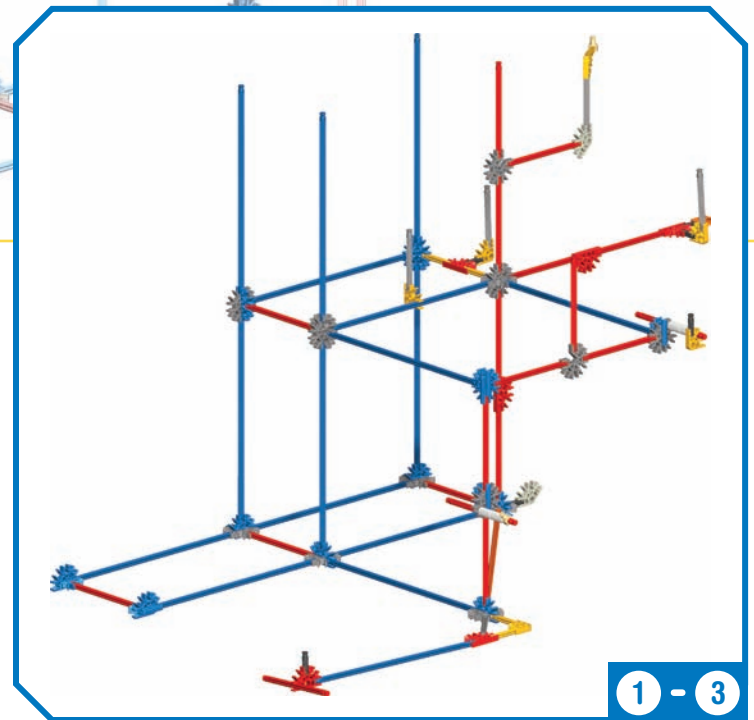

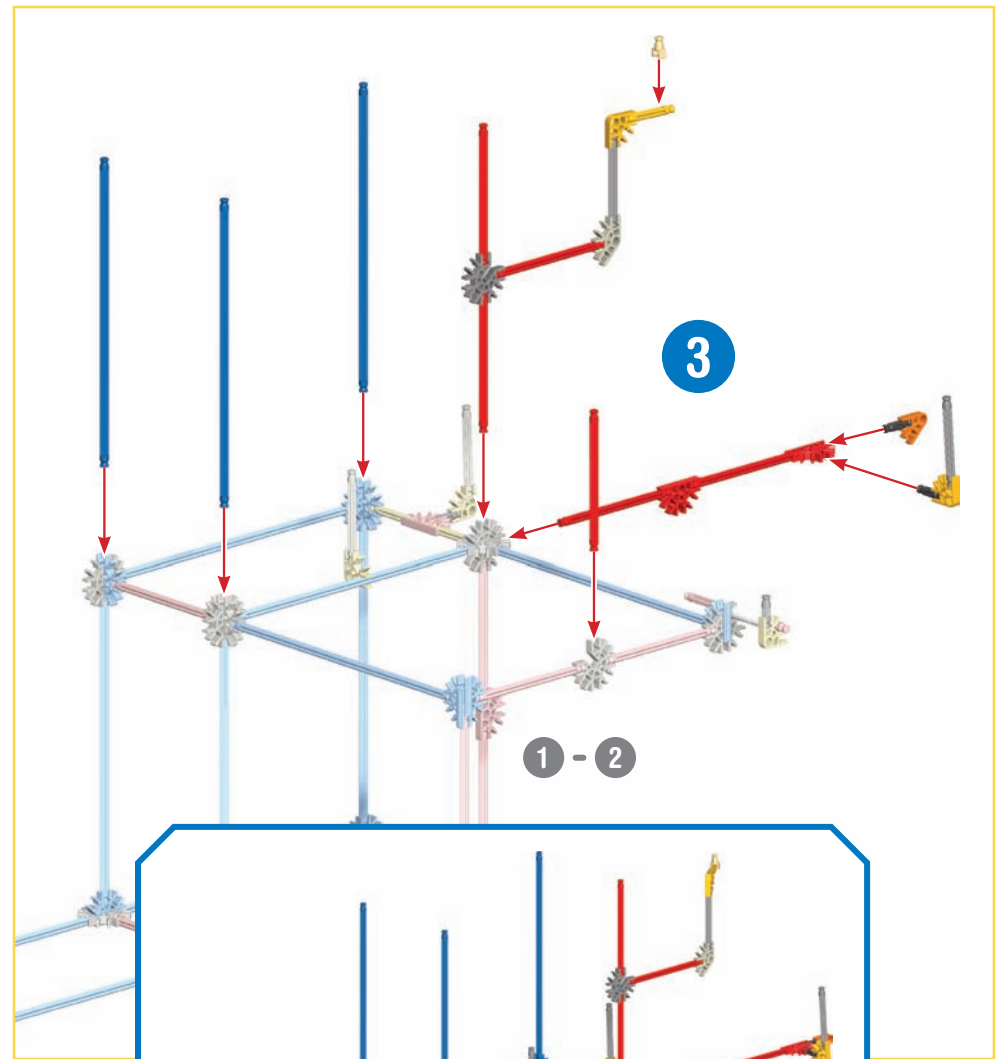
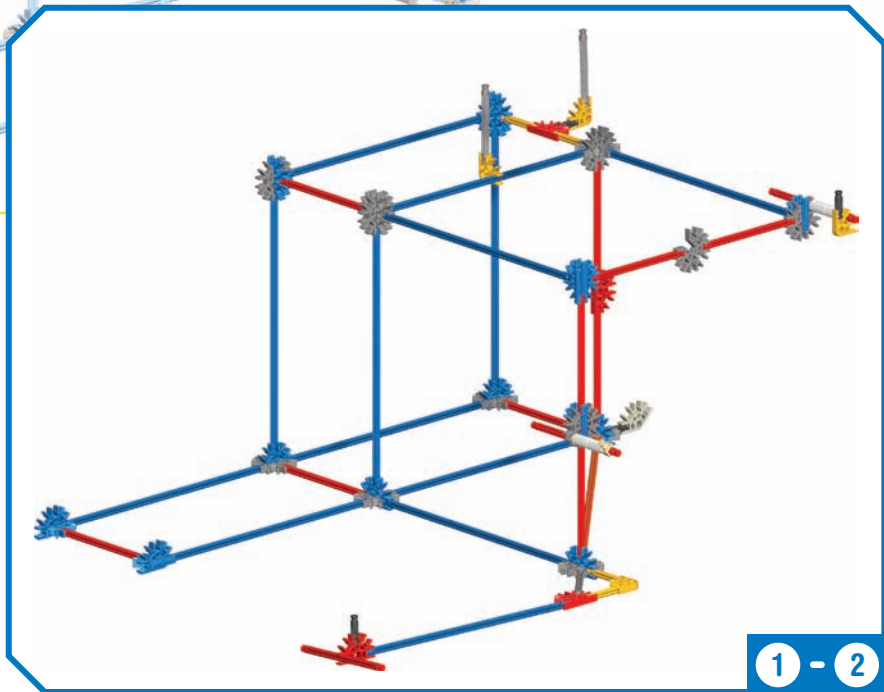
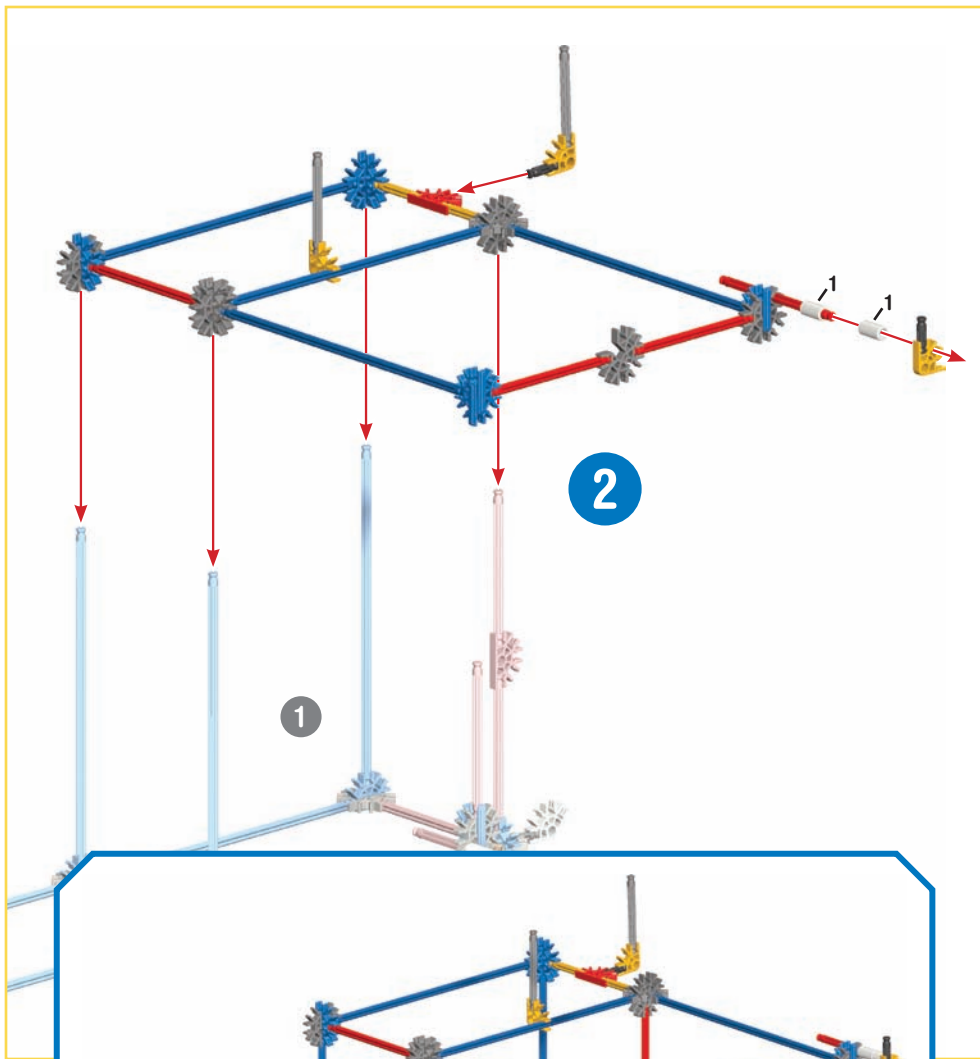
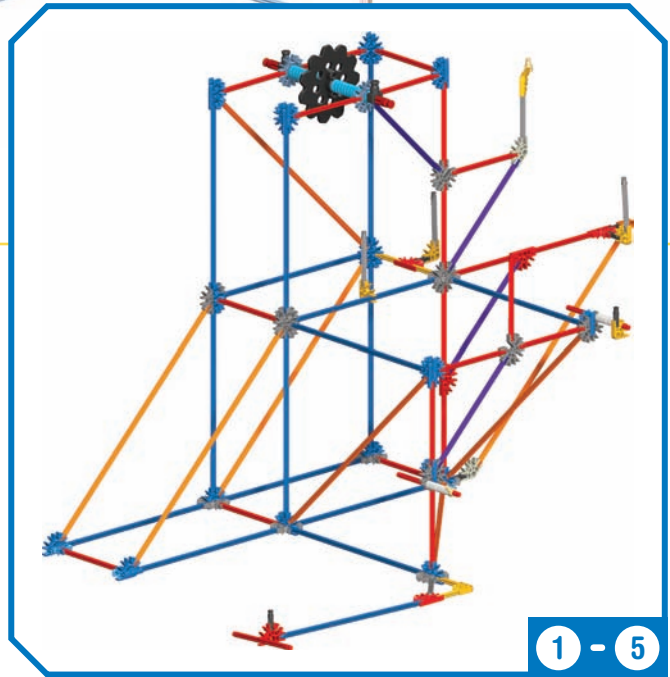
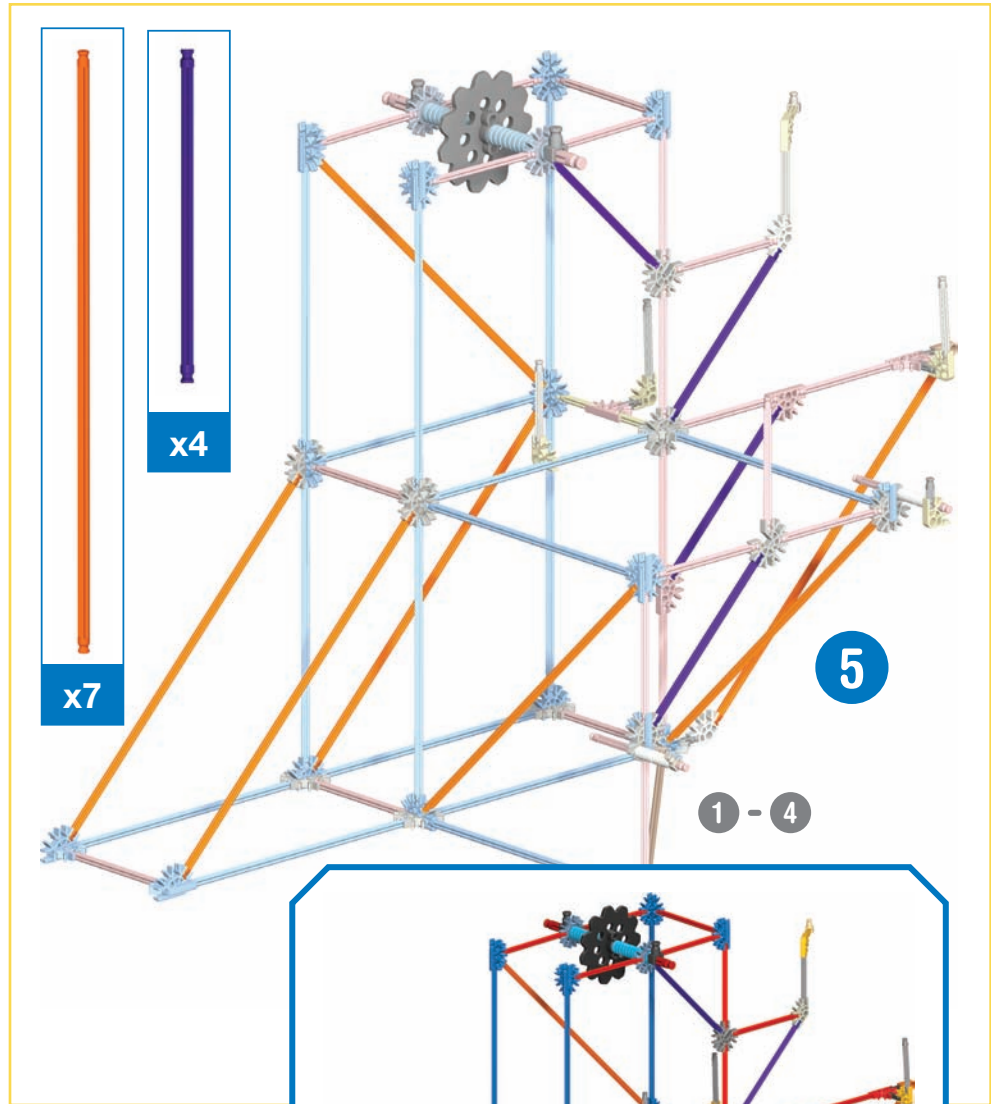
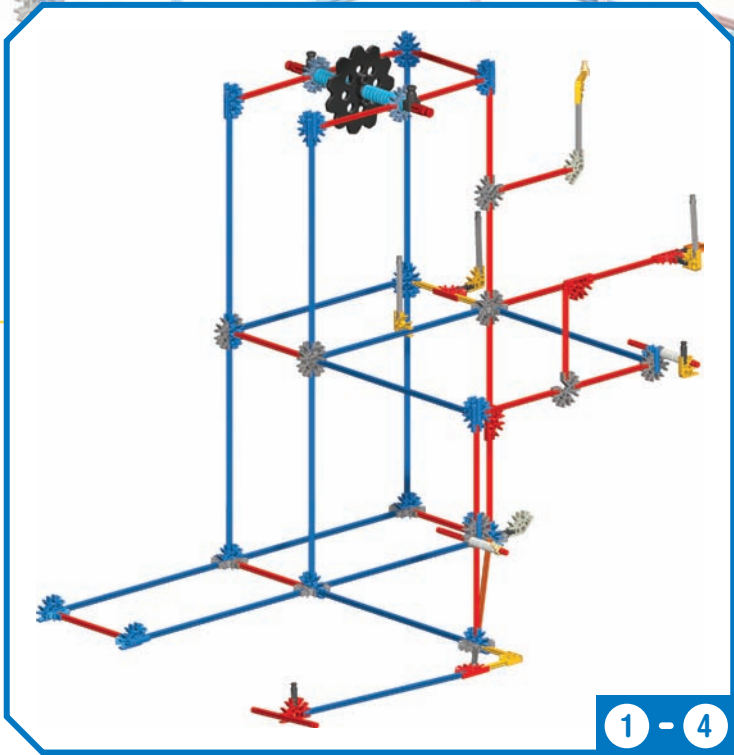
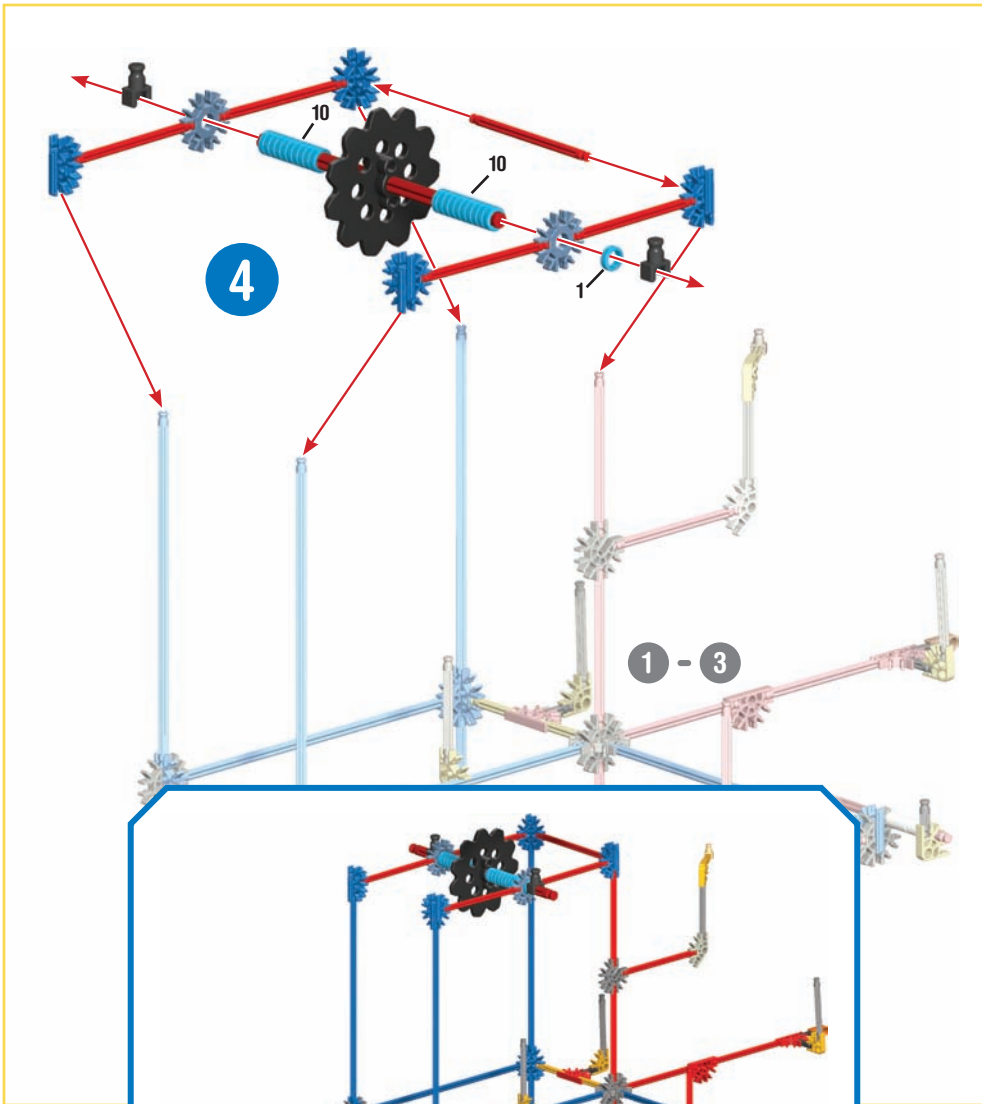
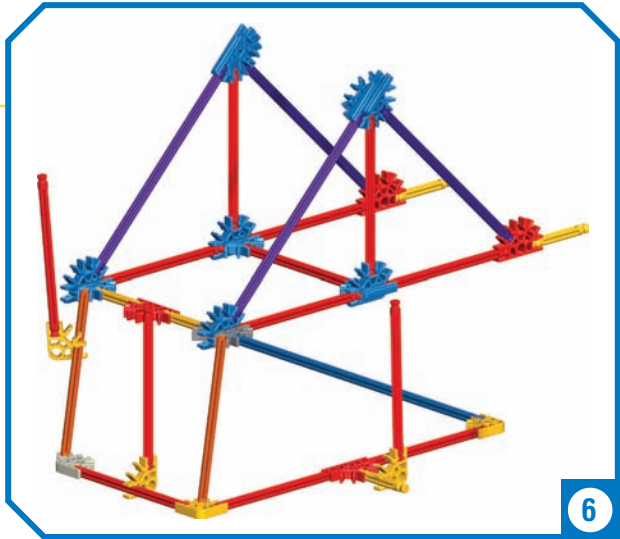
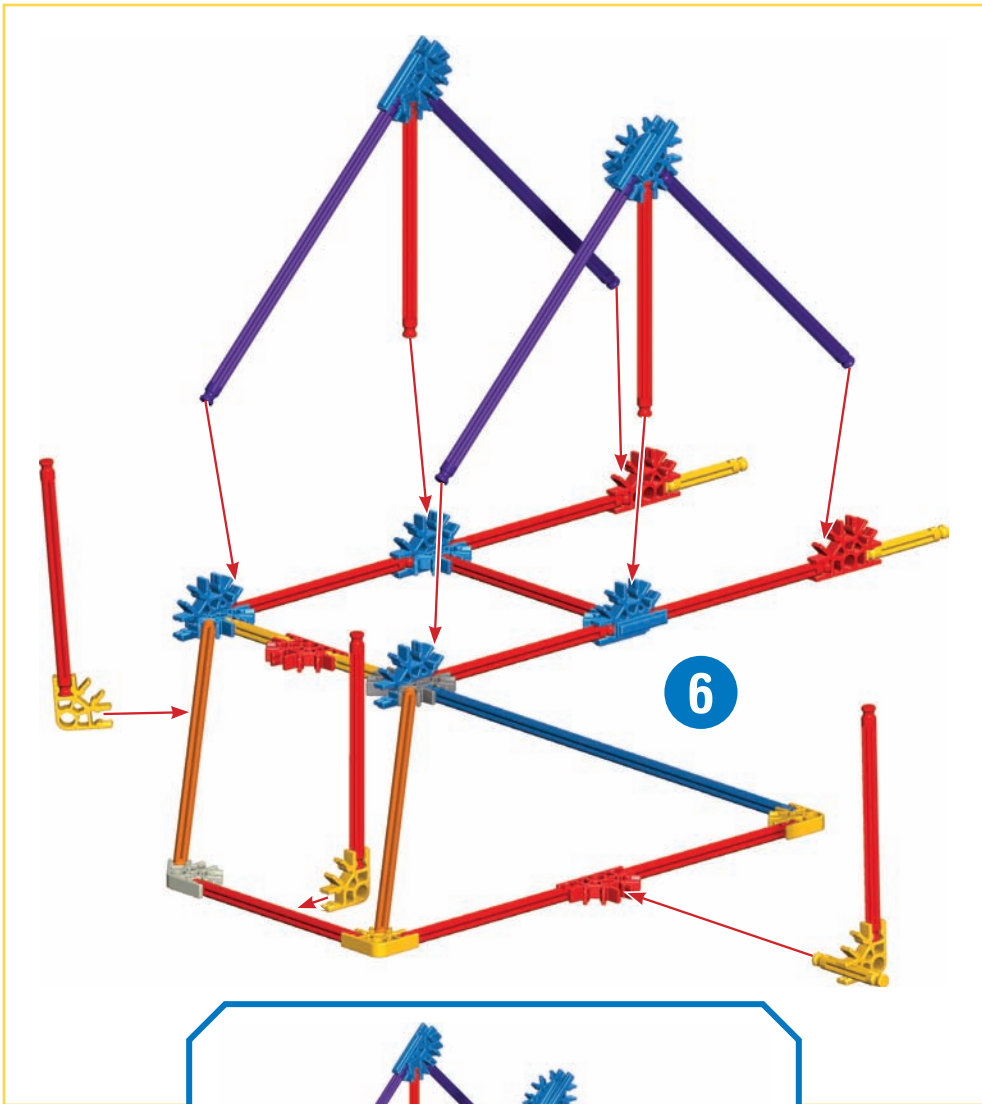

6

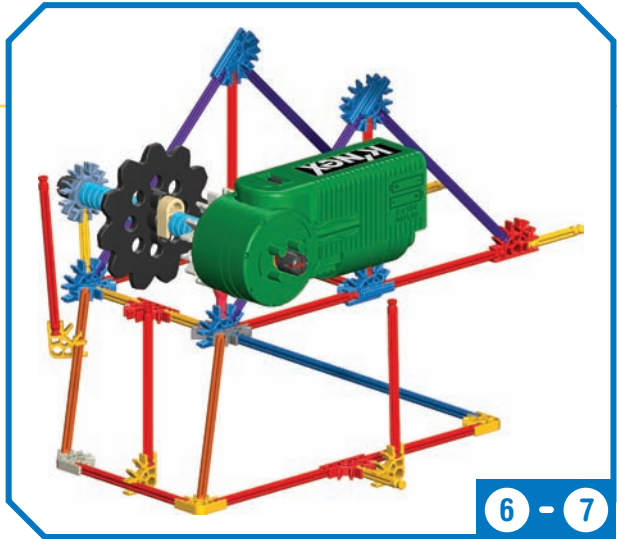
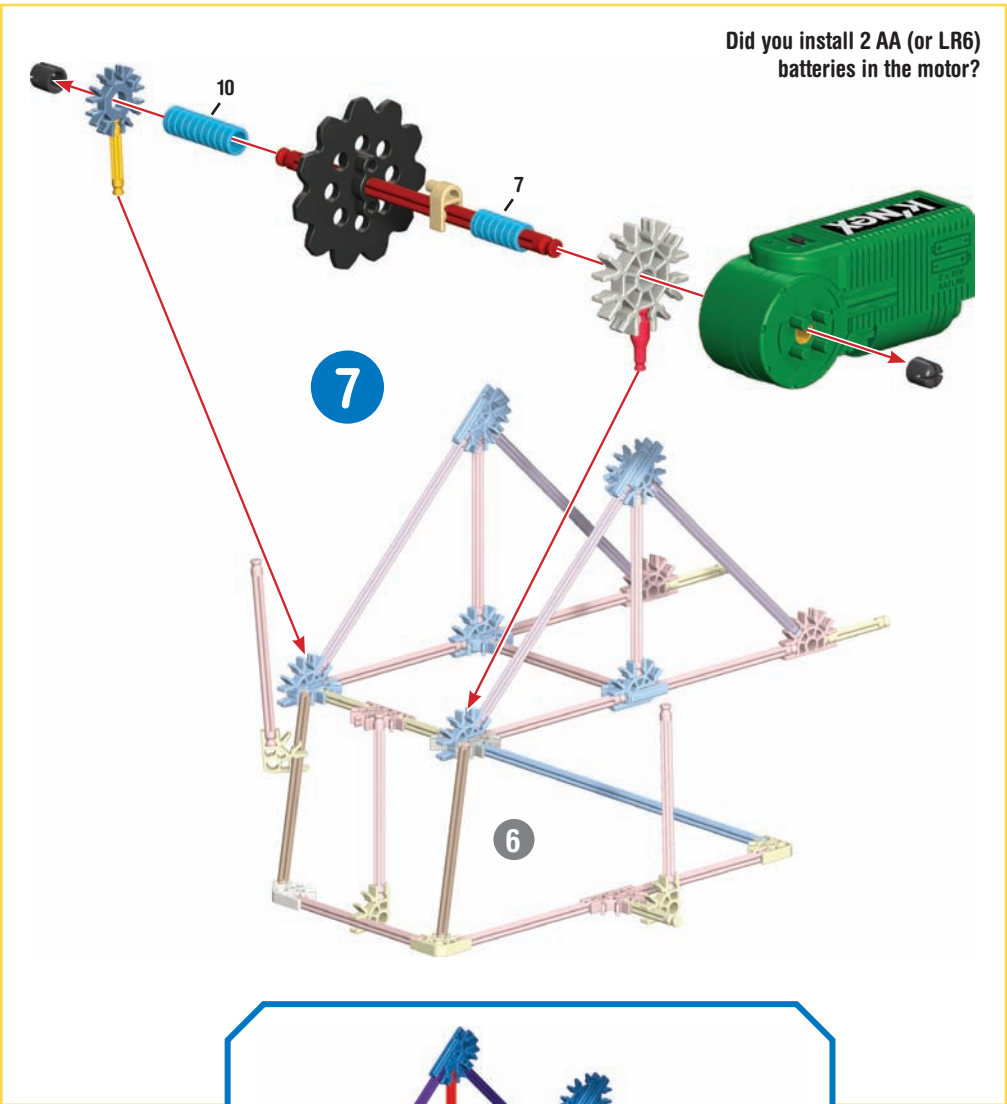

6 - 7

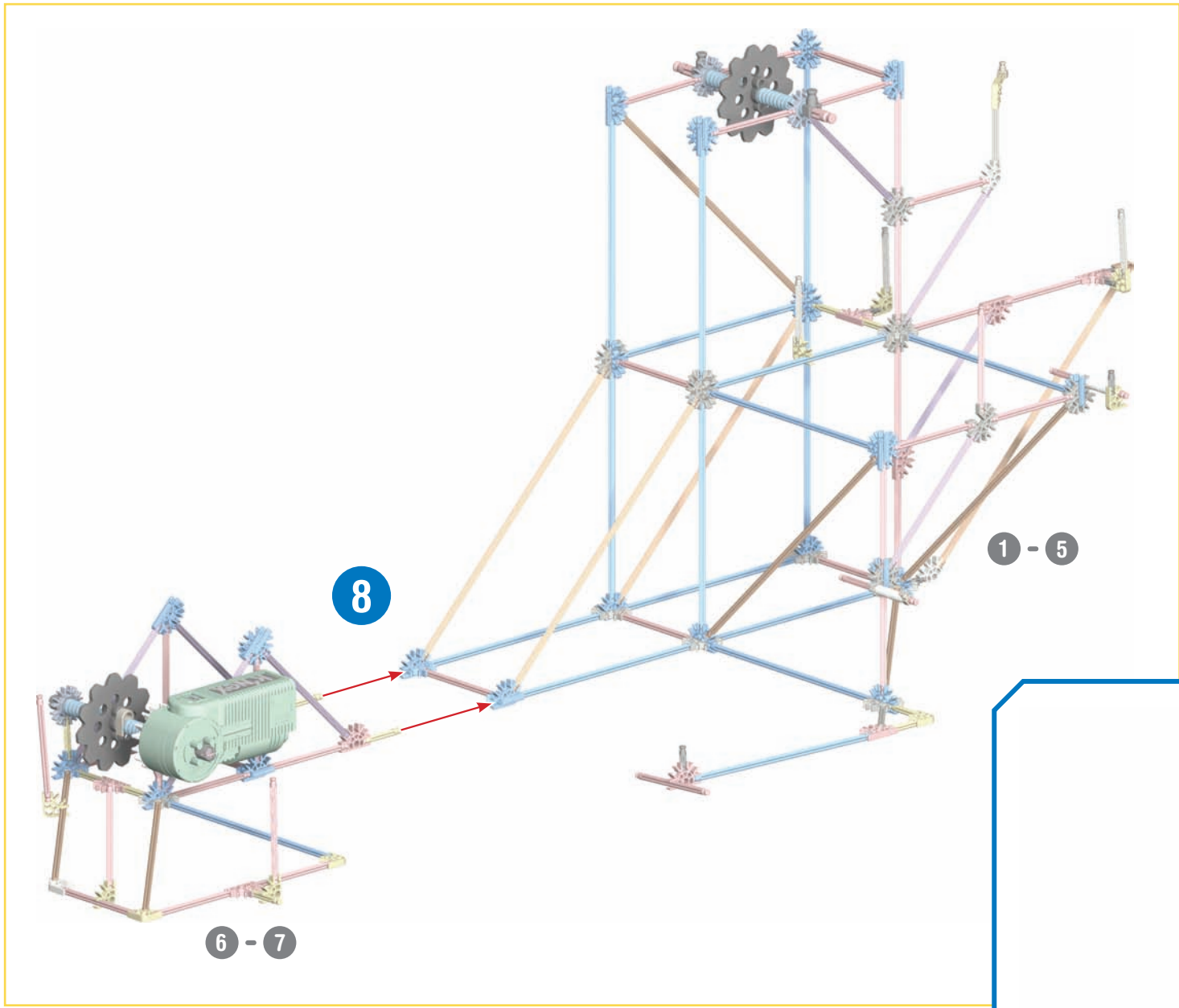

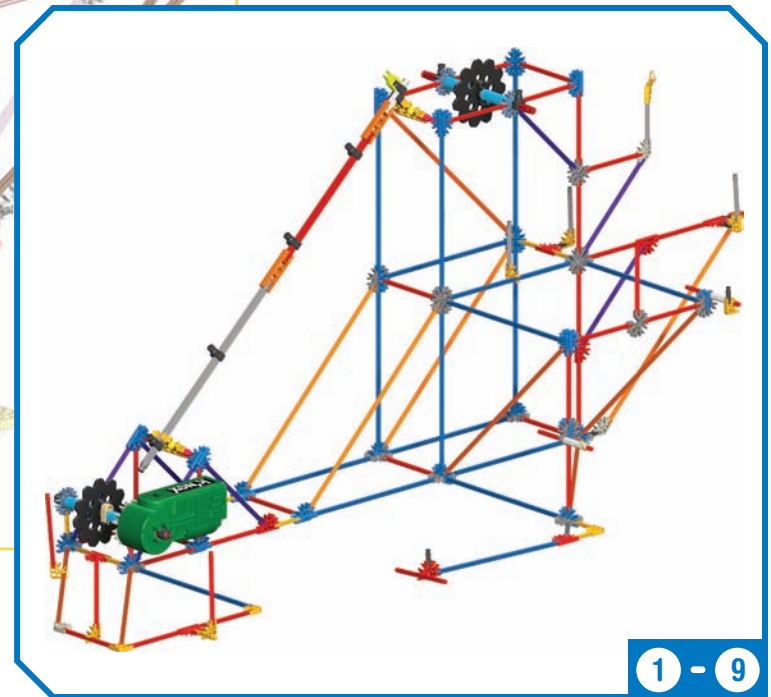
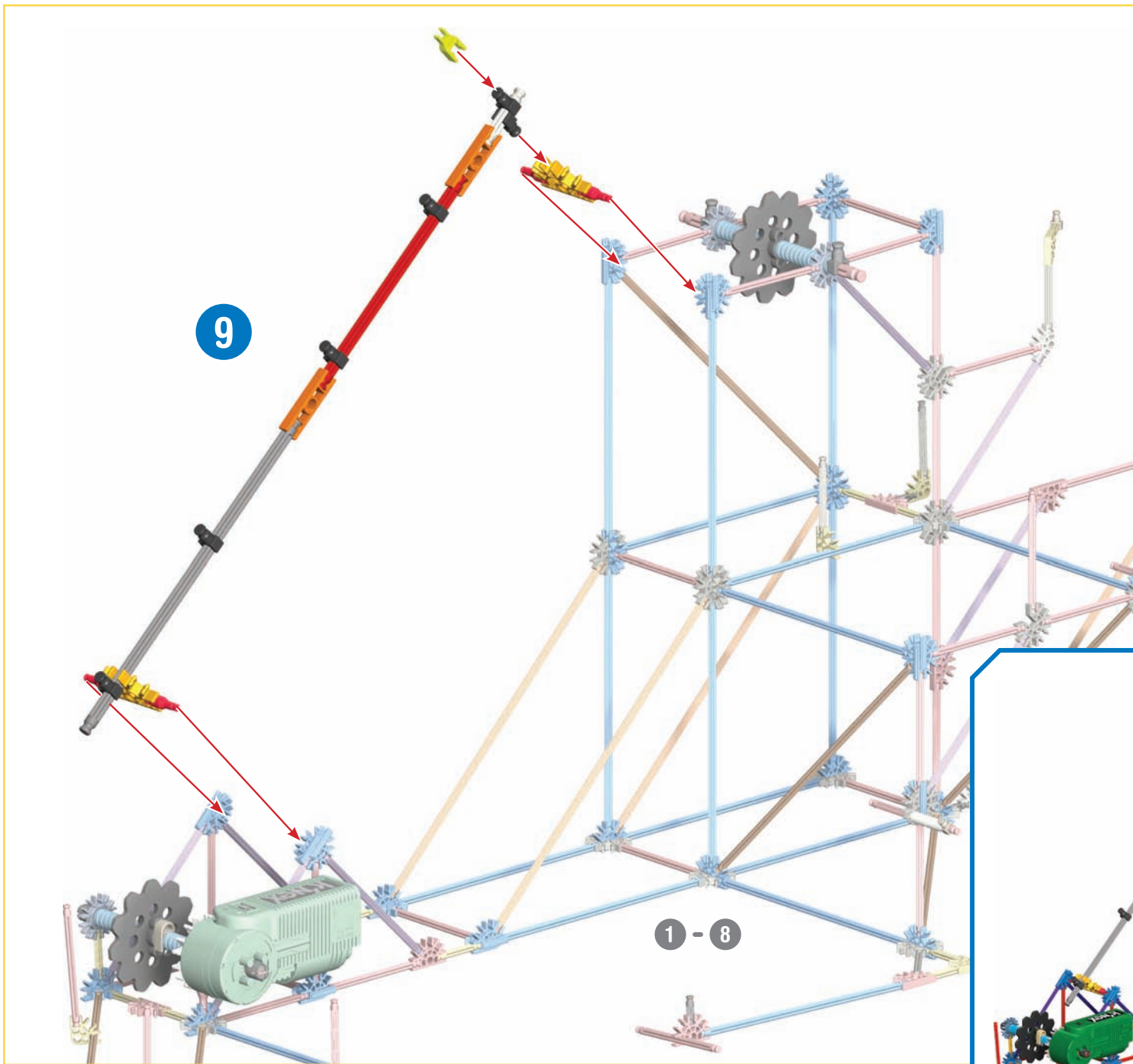

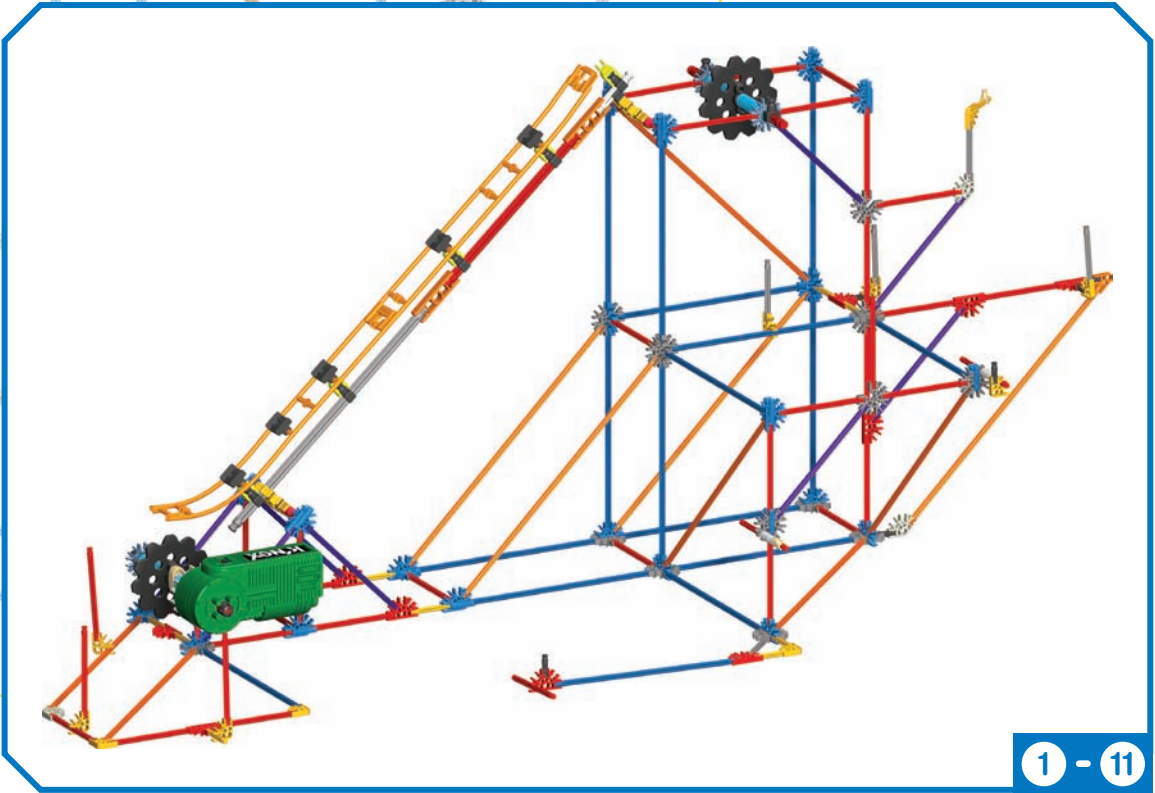
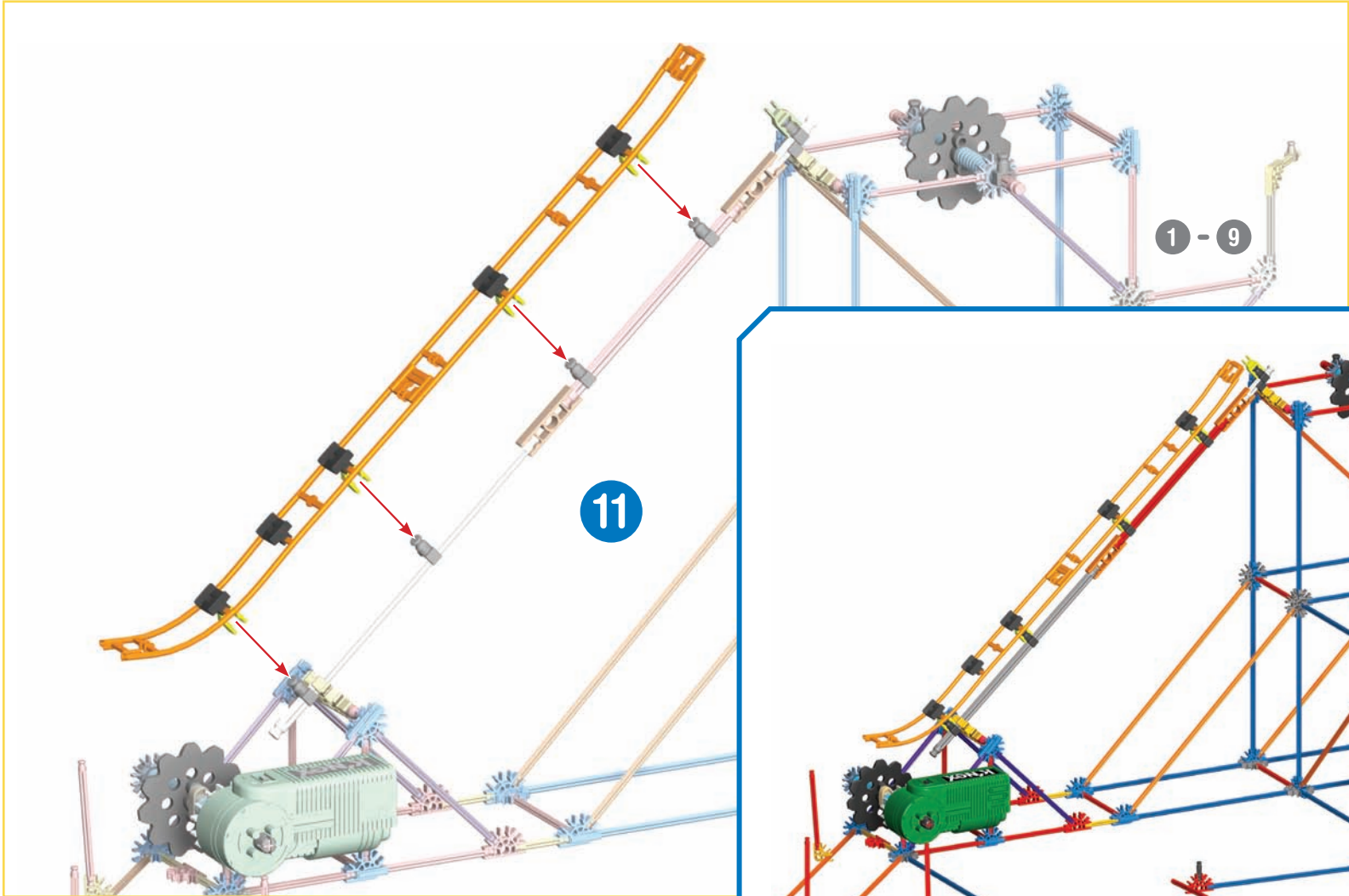
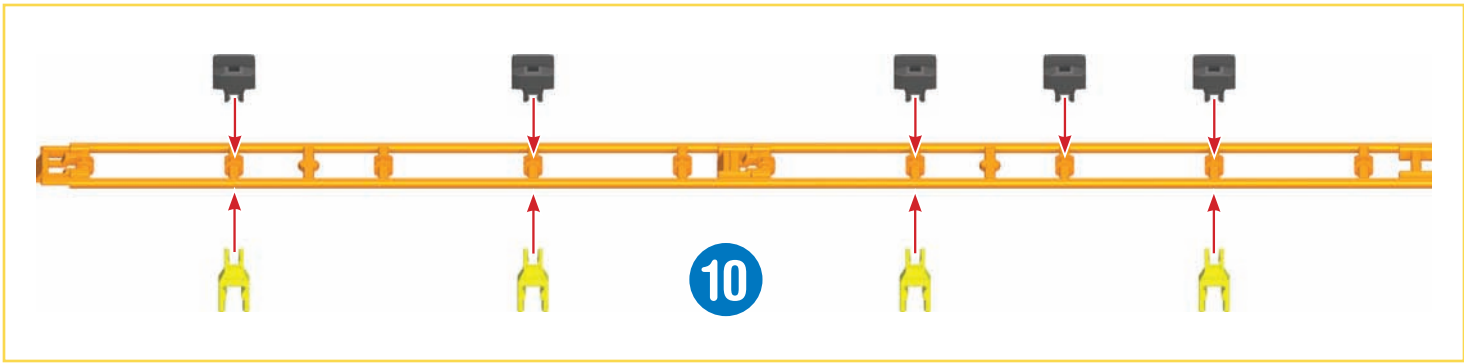

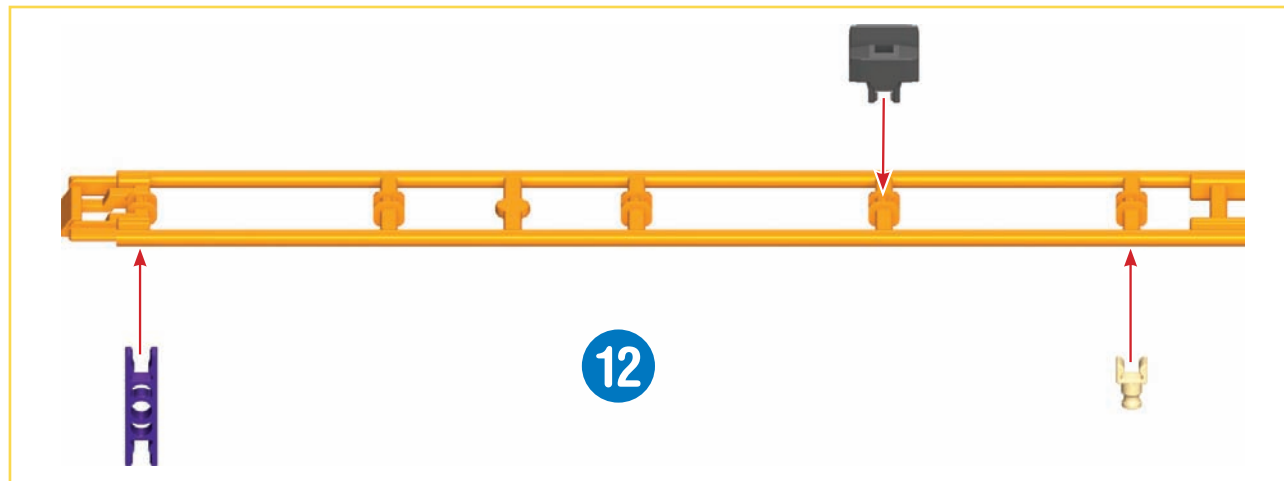

Always join this end of the track to the previous track piece first, then connect the rest of the track to the tower.

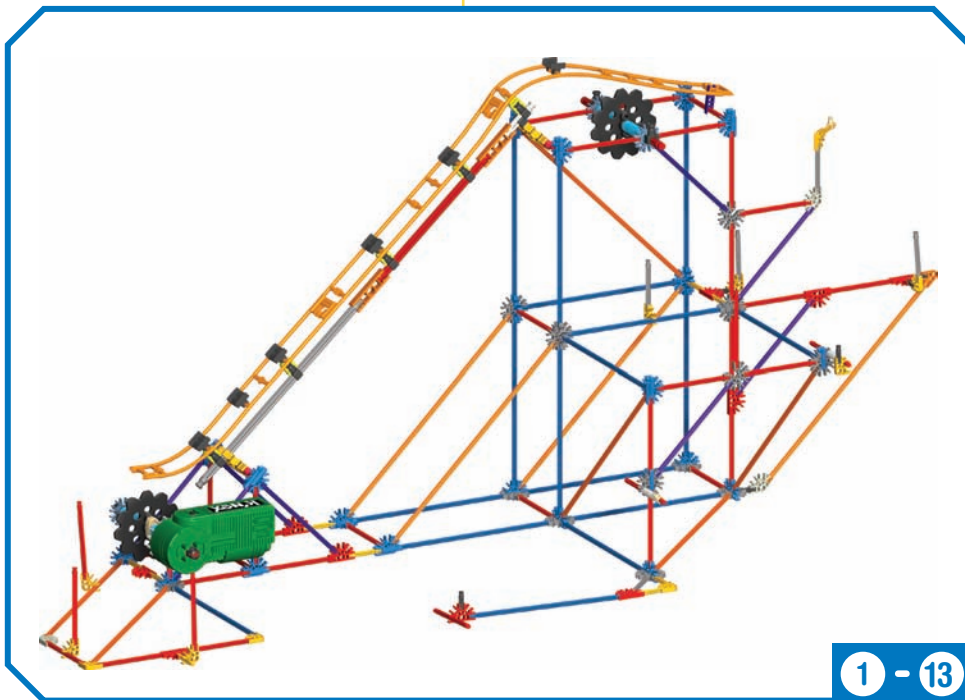
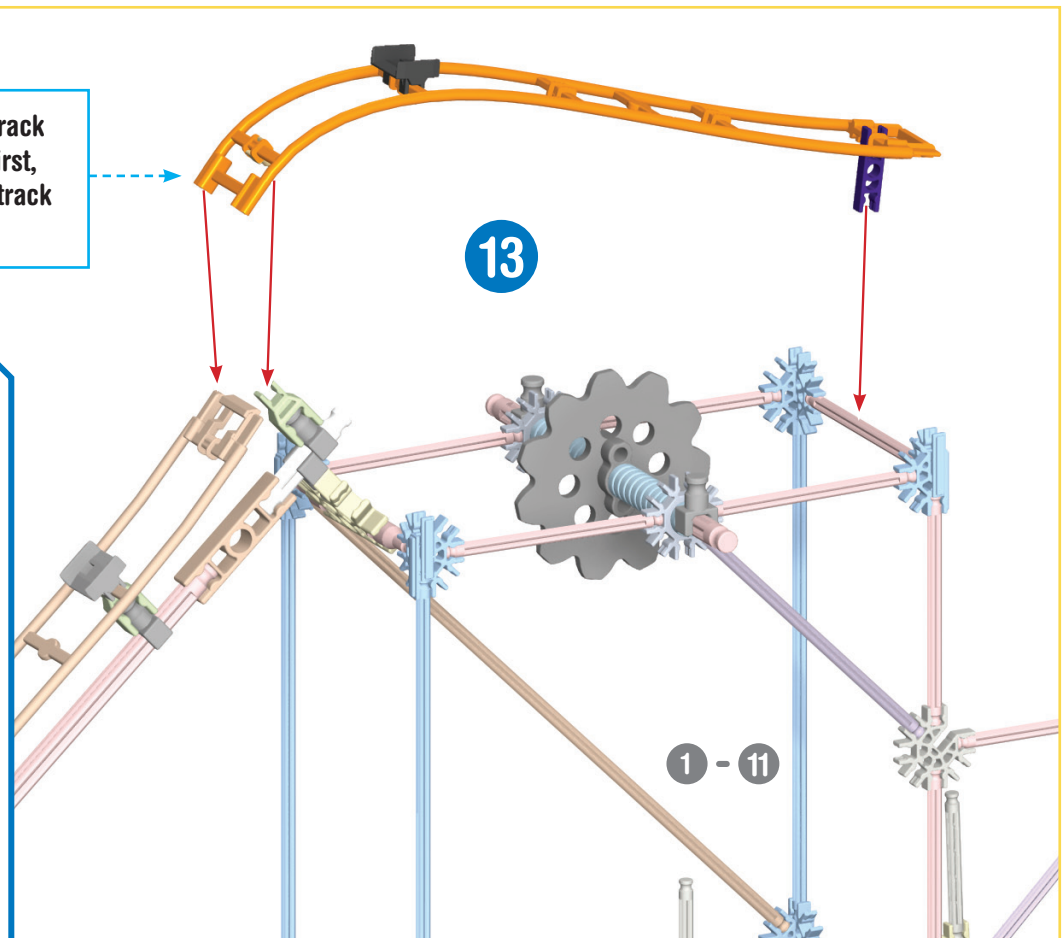

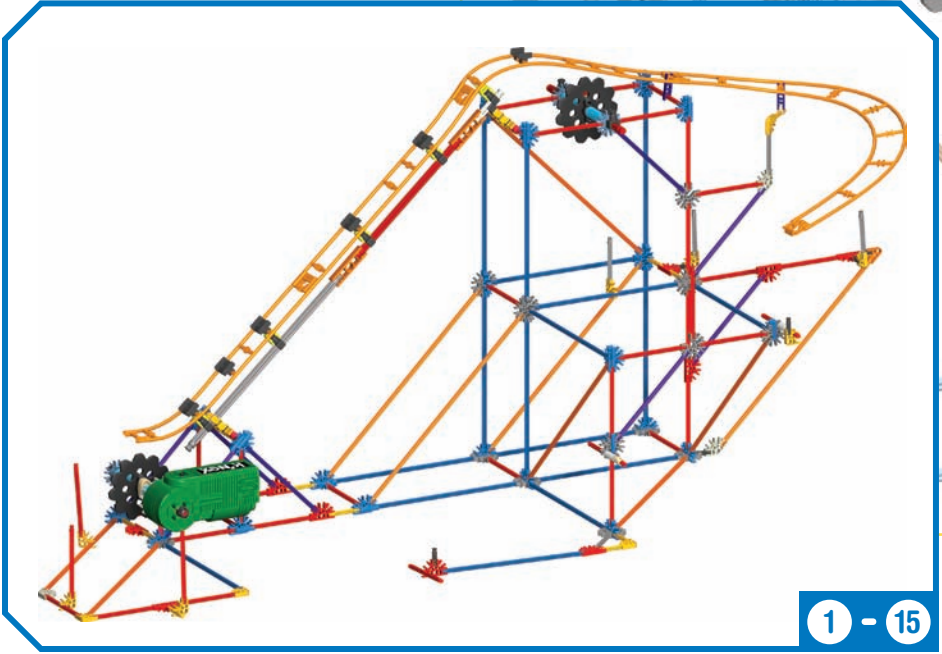
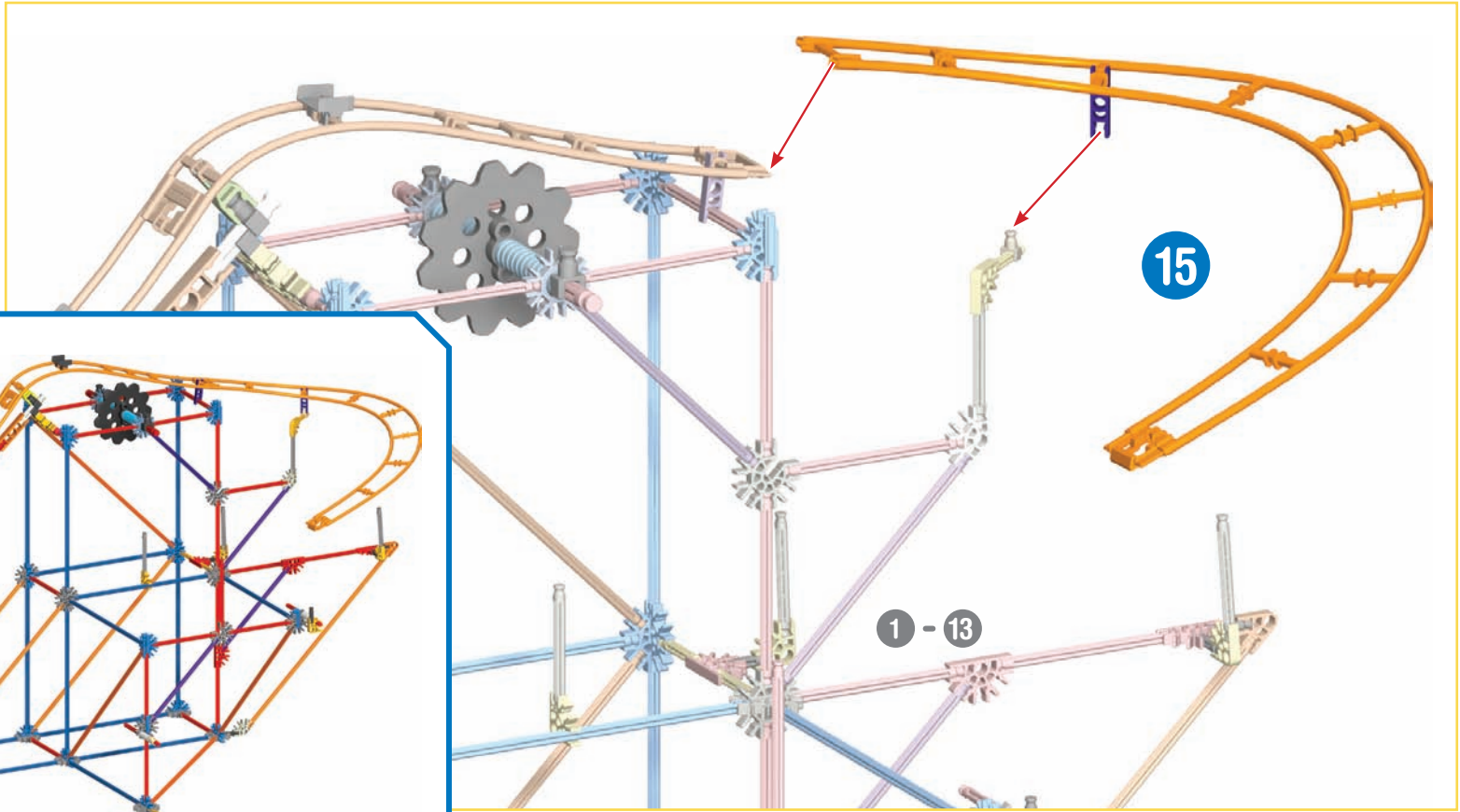
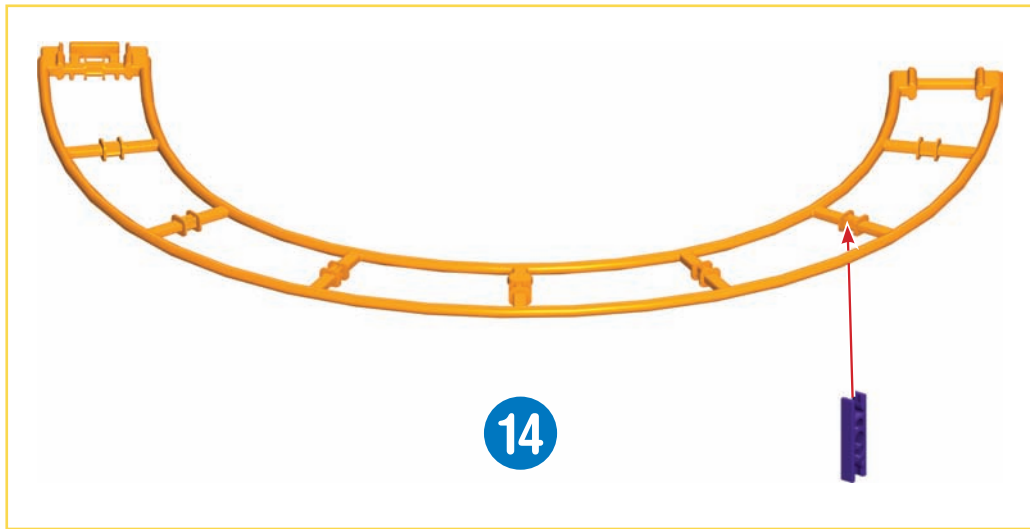

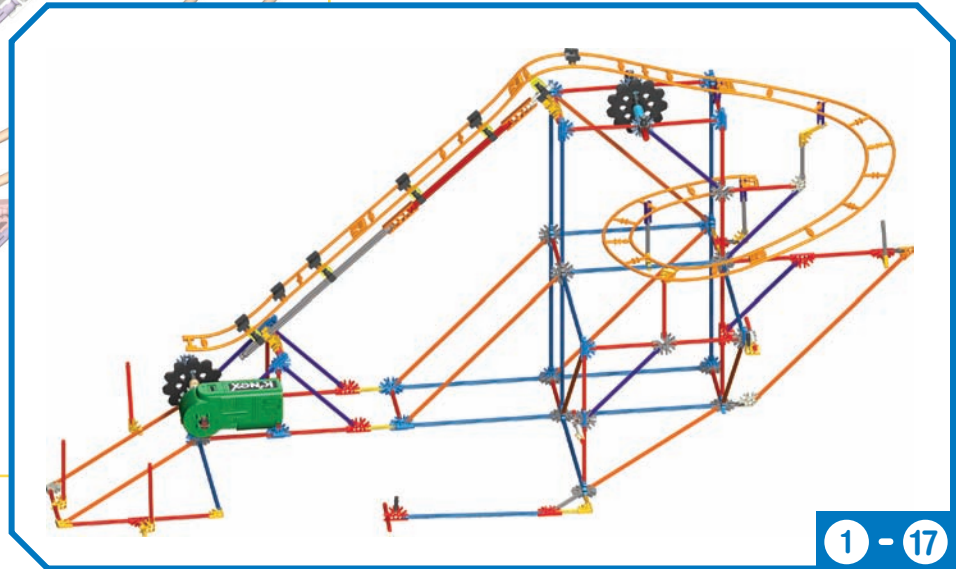
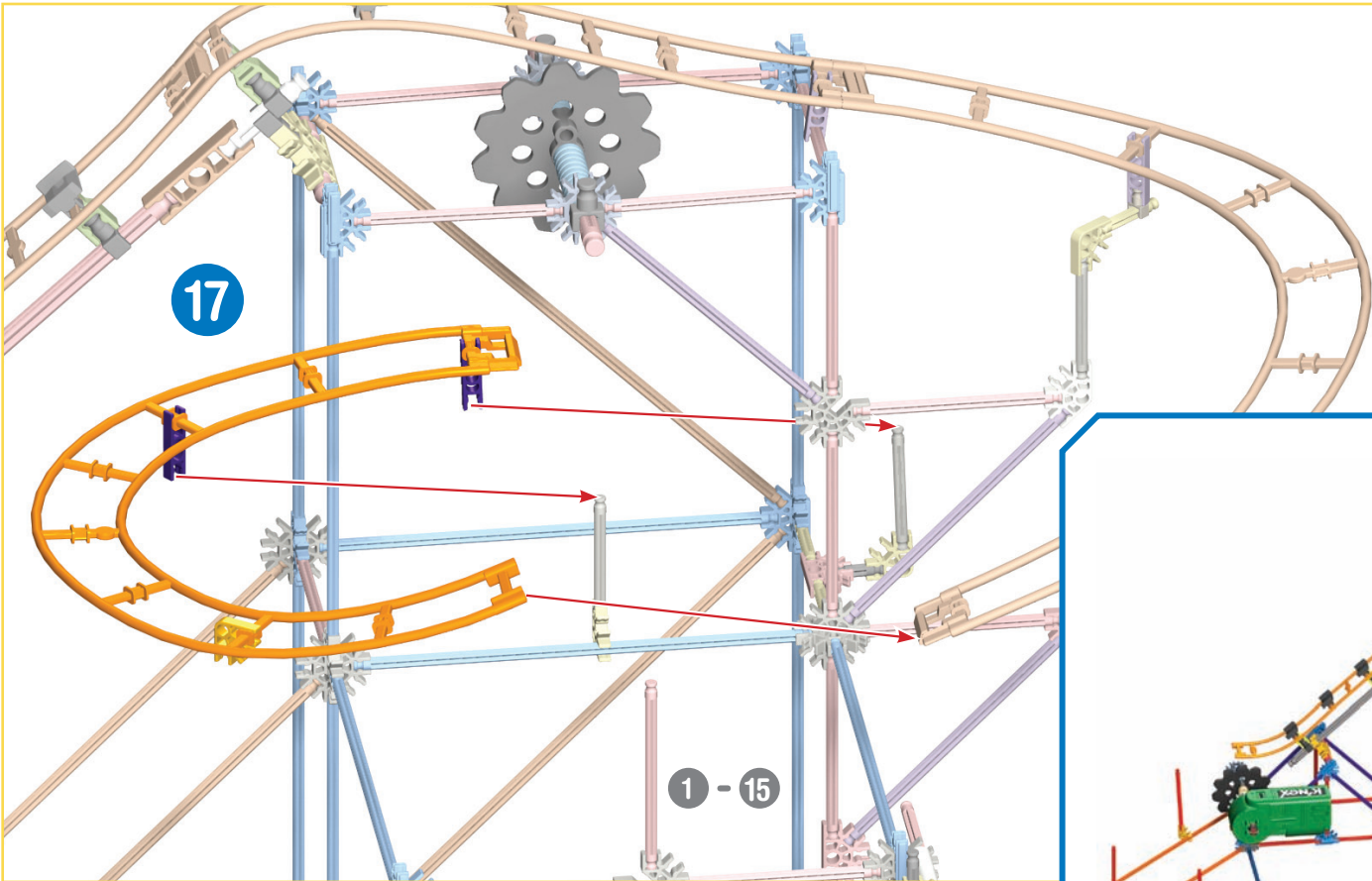
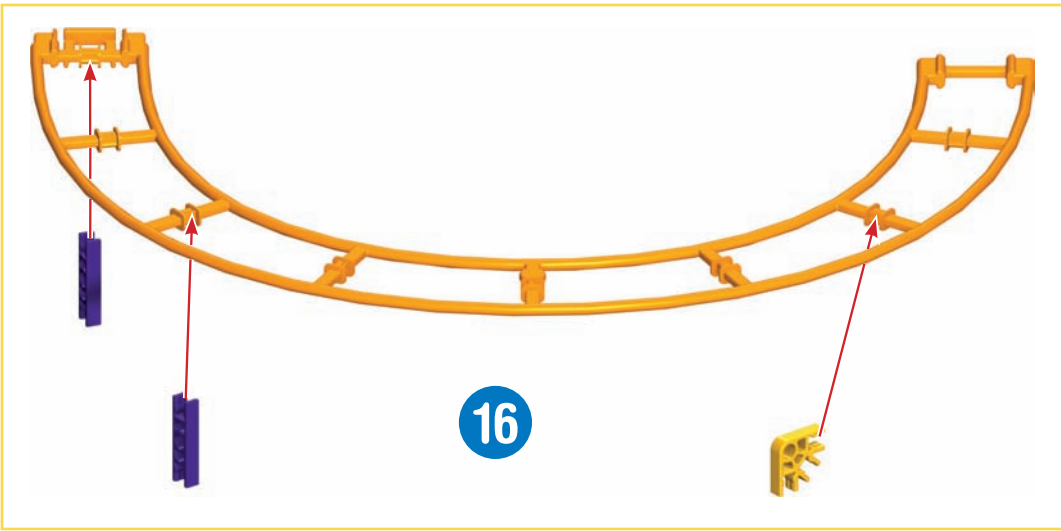

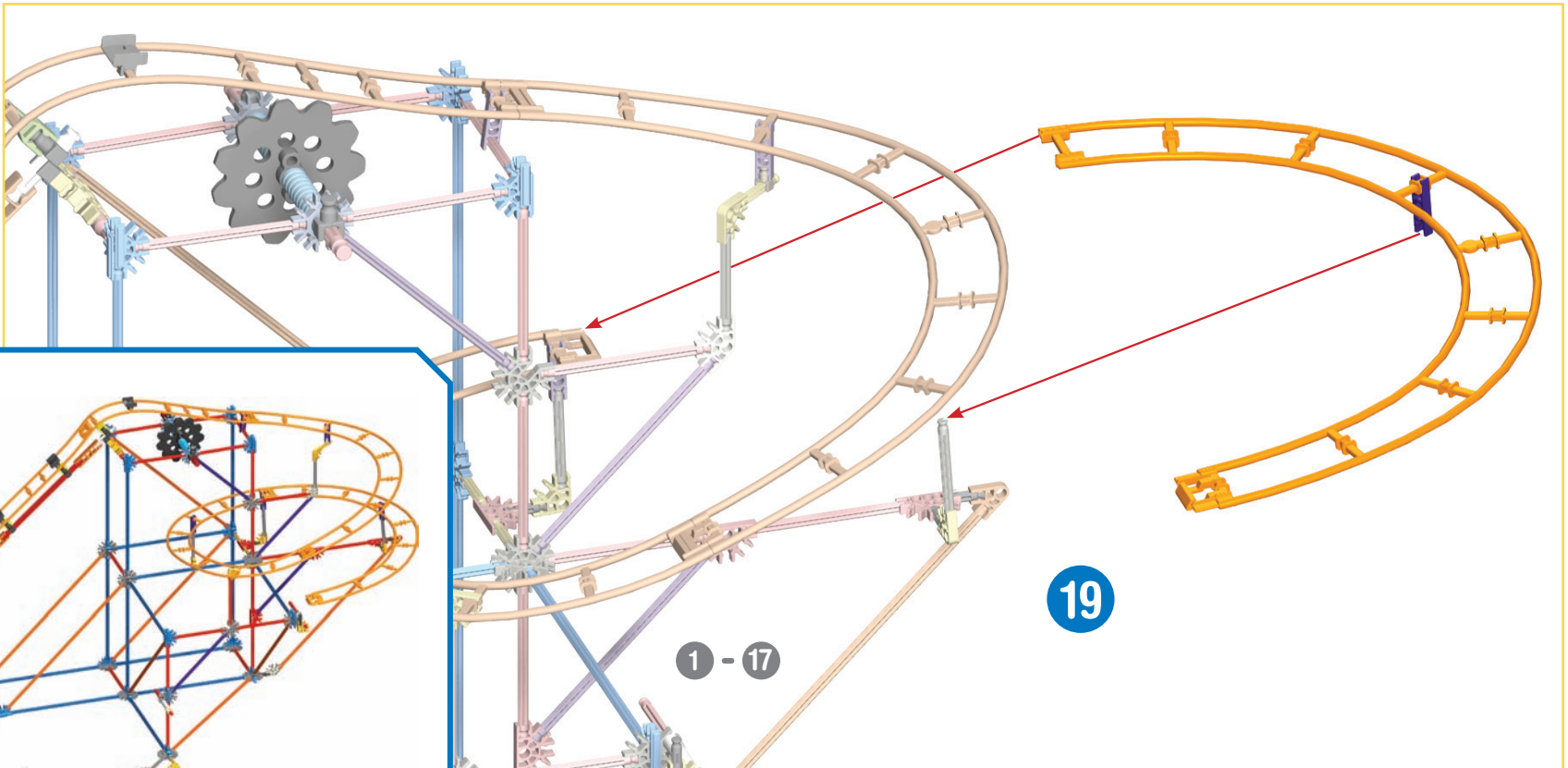
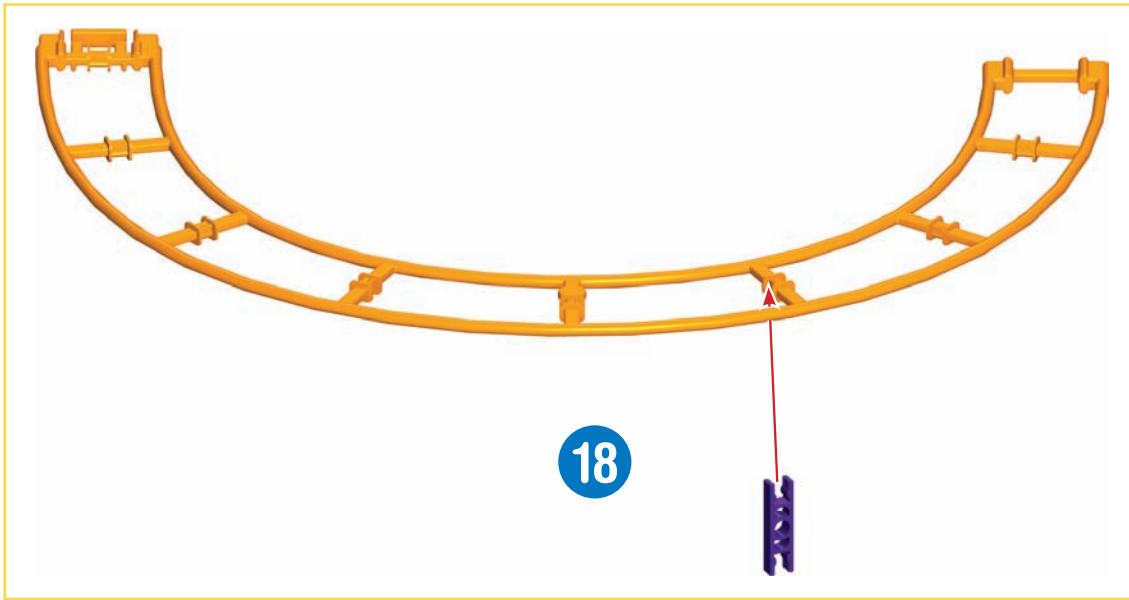

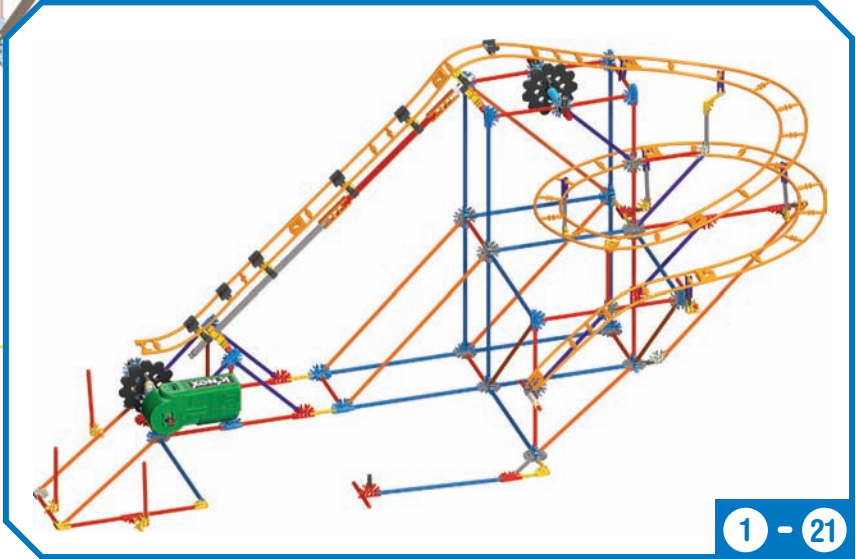
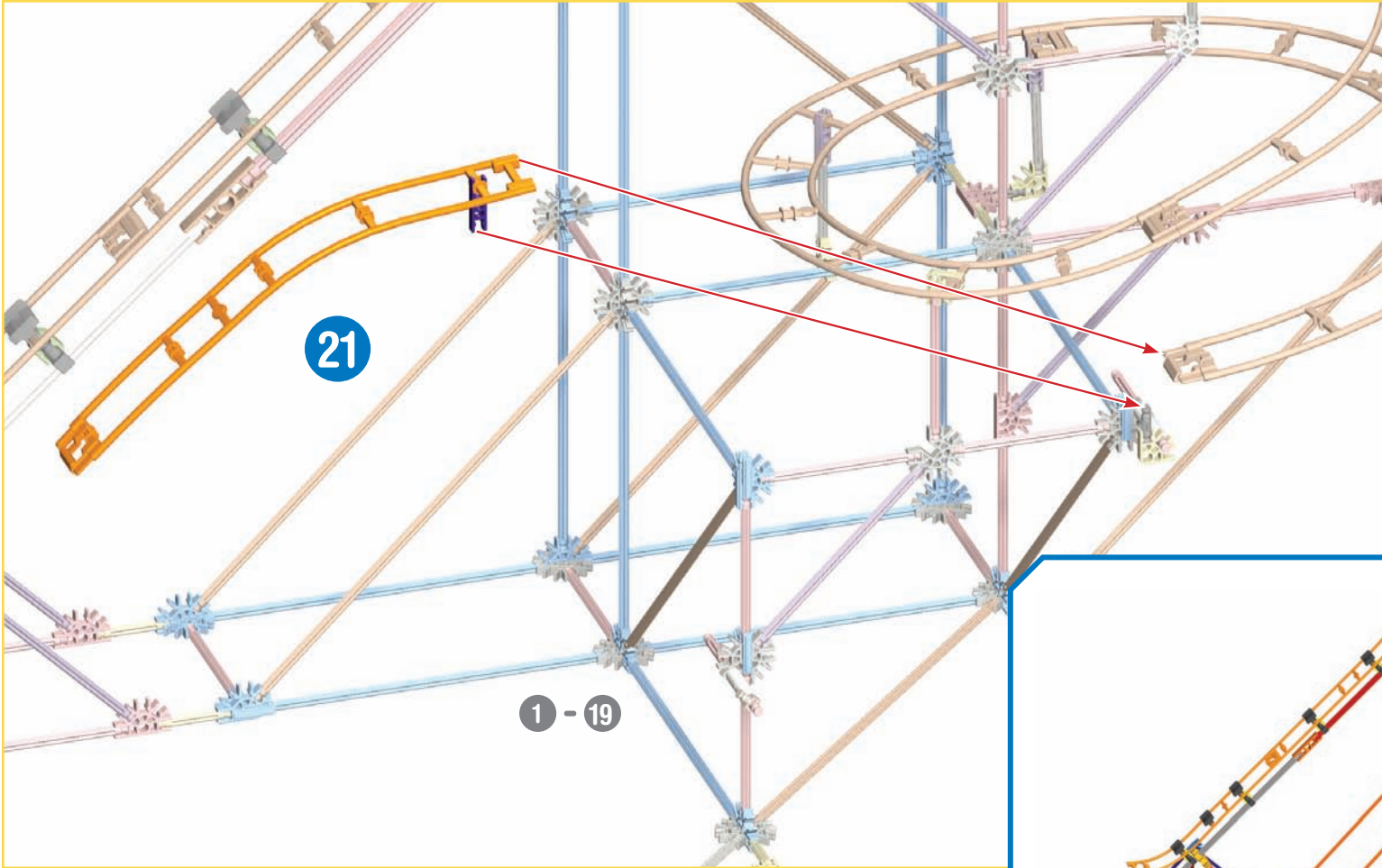
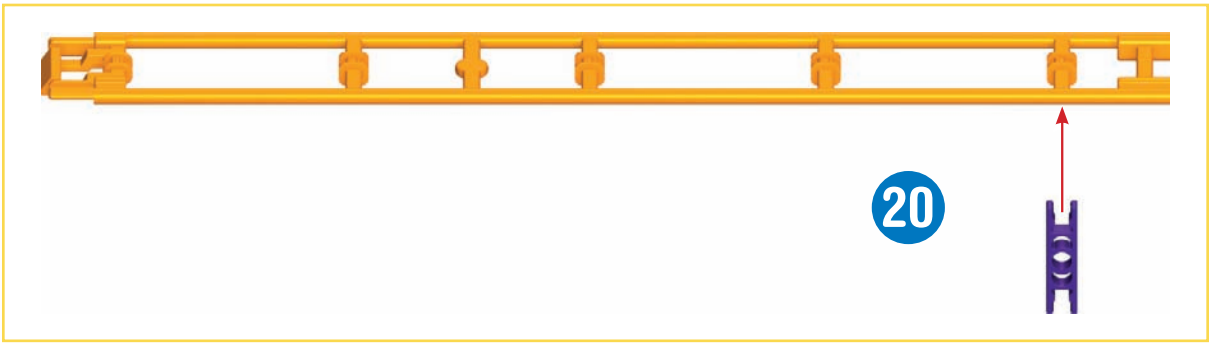

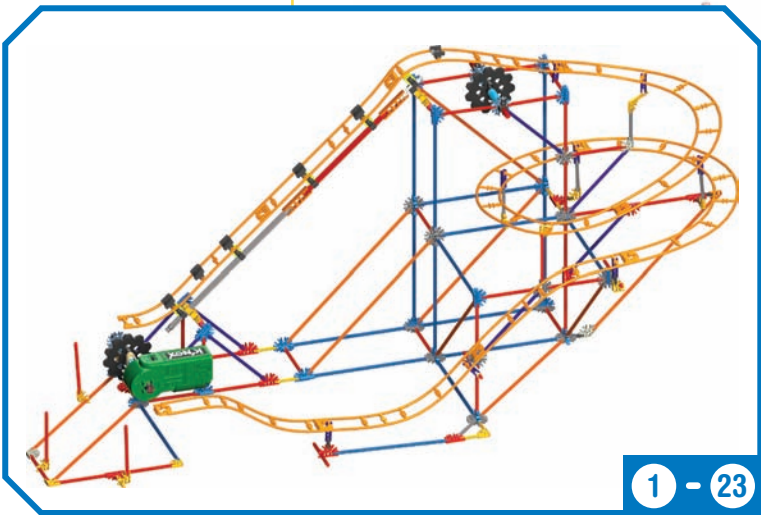
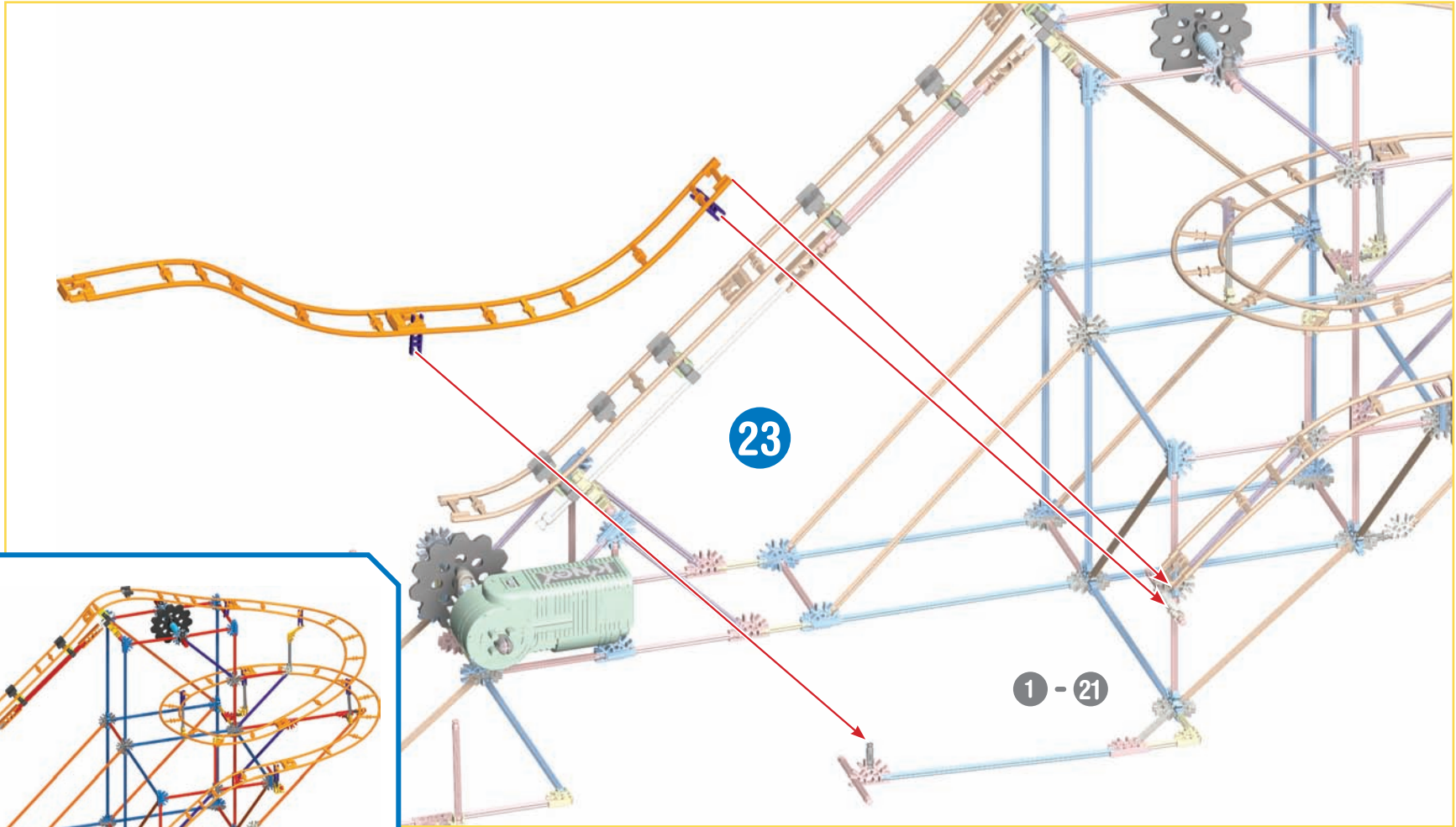
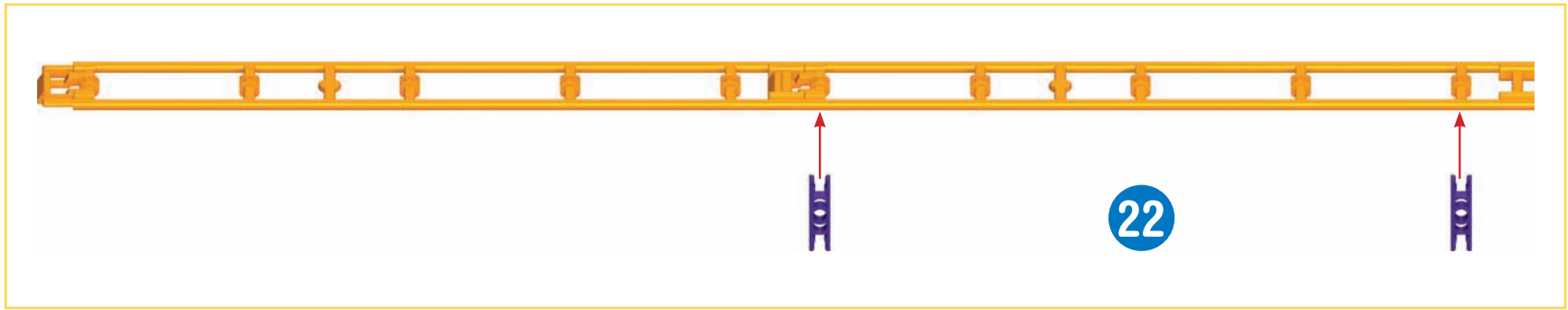

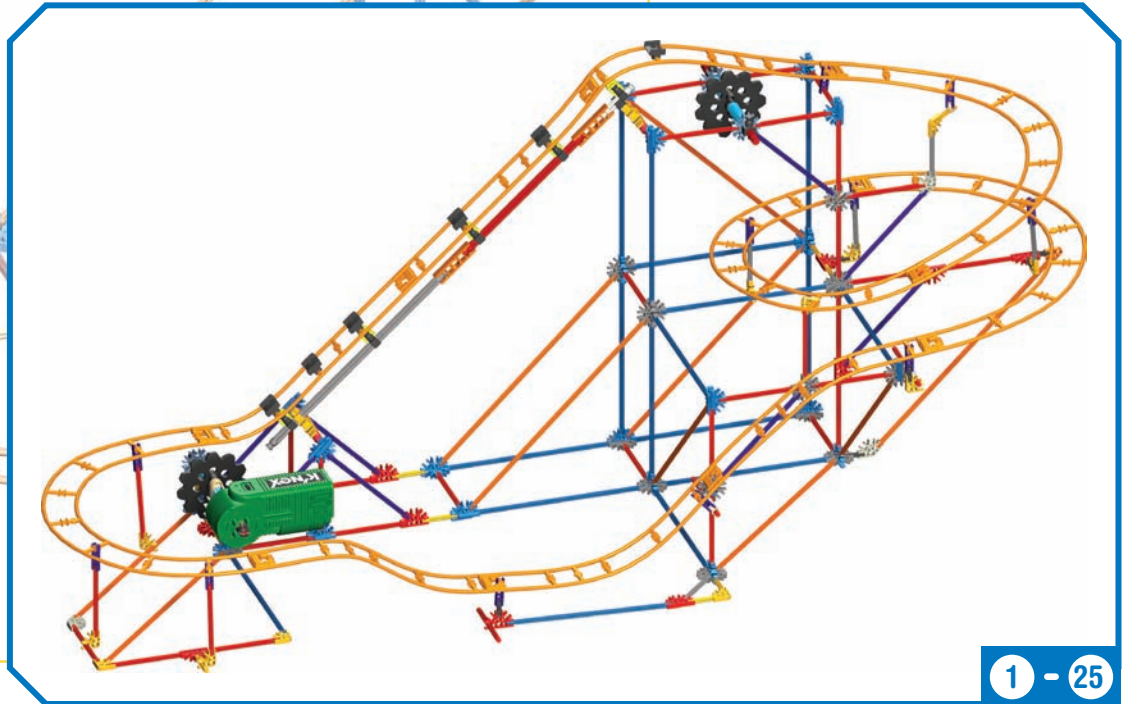
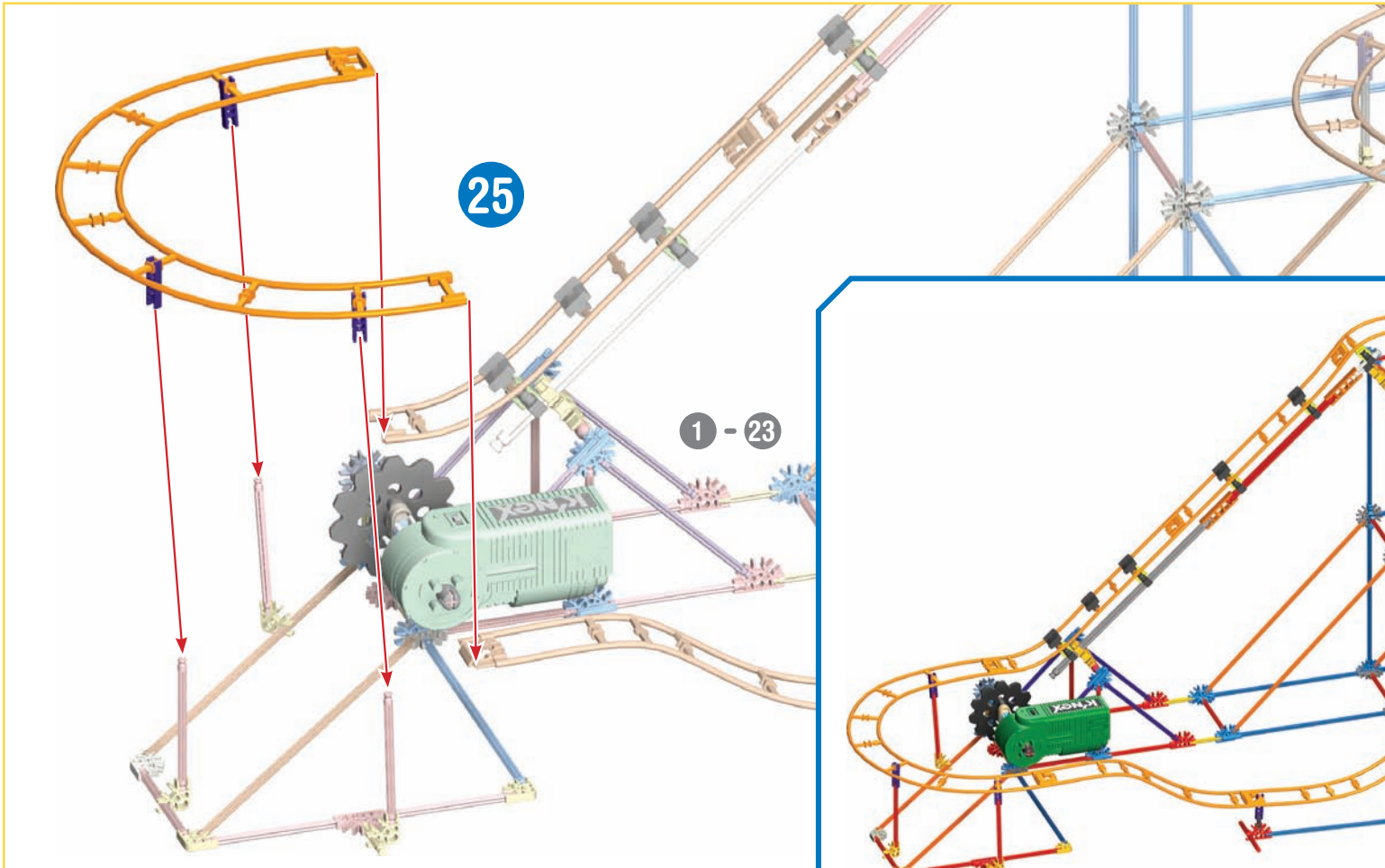
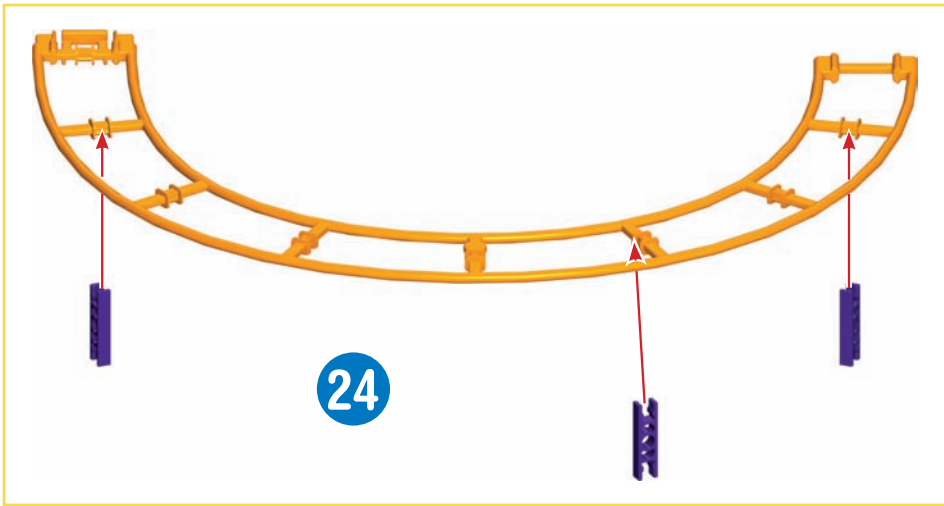

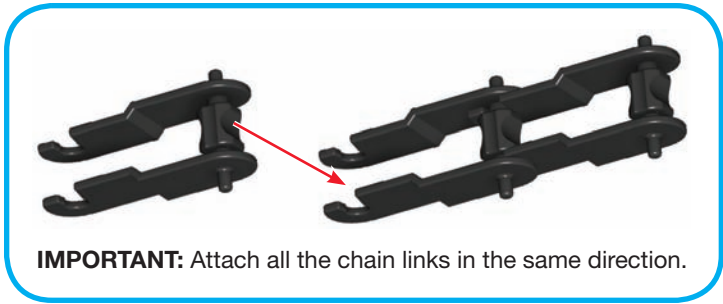

26

x3

x1

27

x10

x8

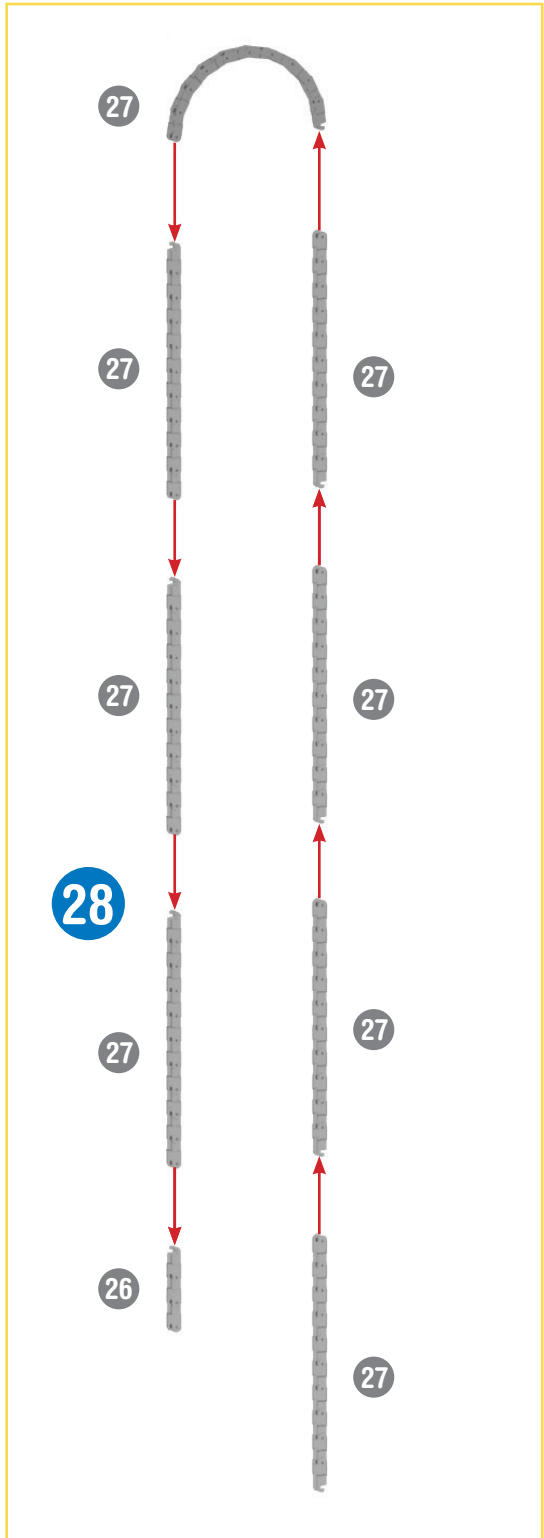

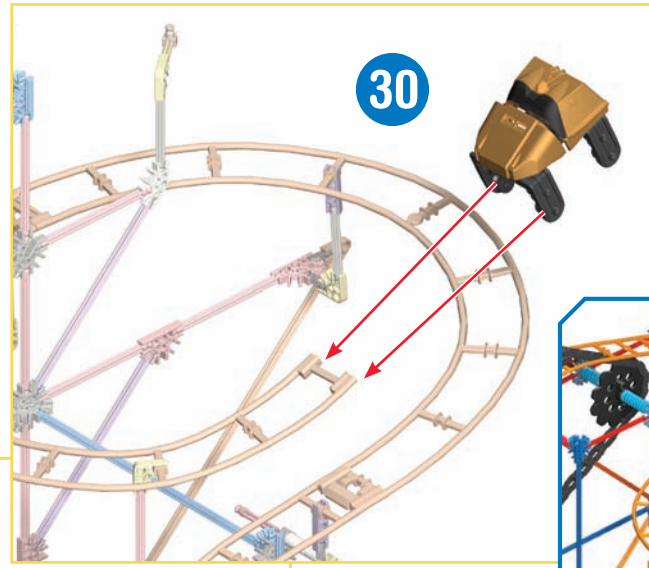

To attach the car, undo a piece of track and then thread the car wheels over the top side of the track. Then join the track pieces together. If the car gets stuck on the way down, make sure it is not hitting any K'NEX parts.



29

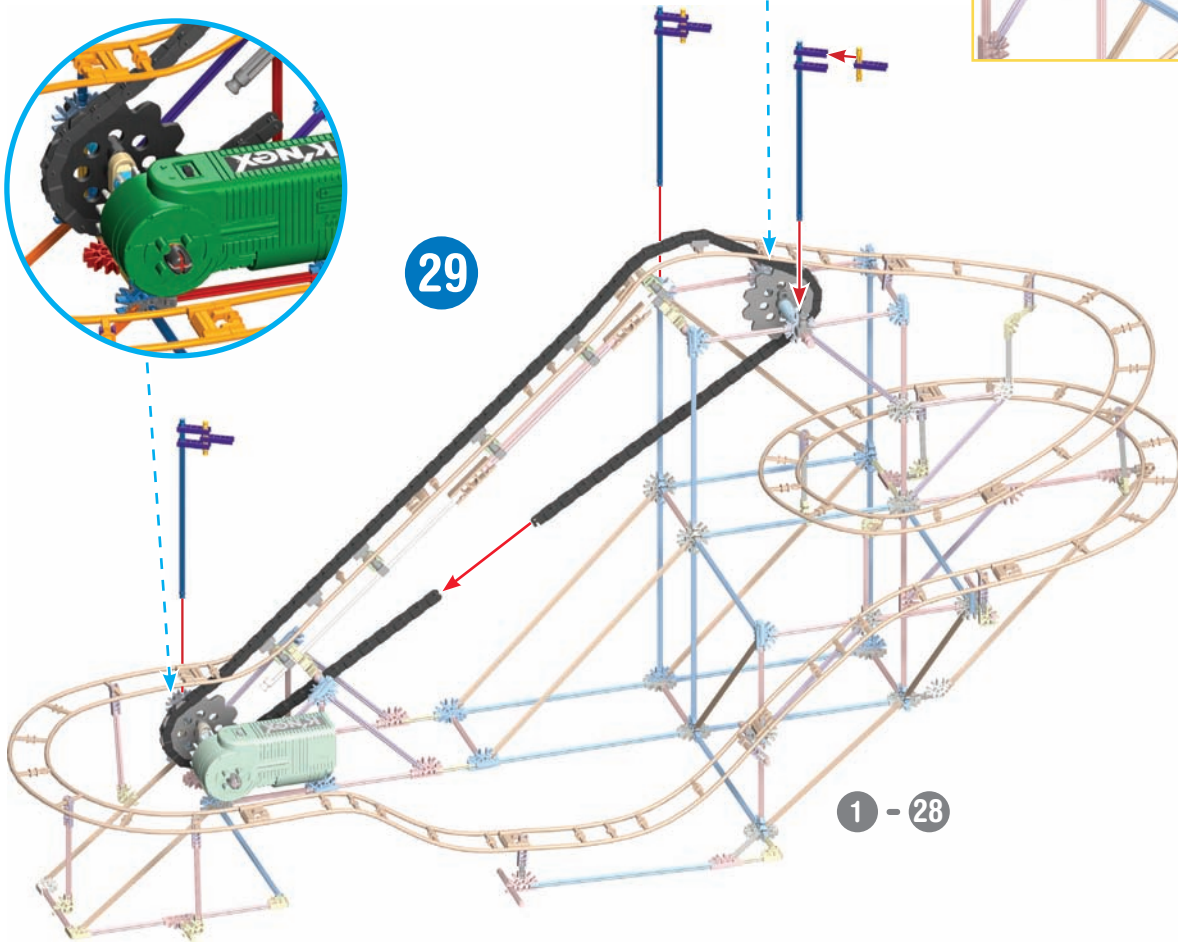

1 - 28

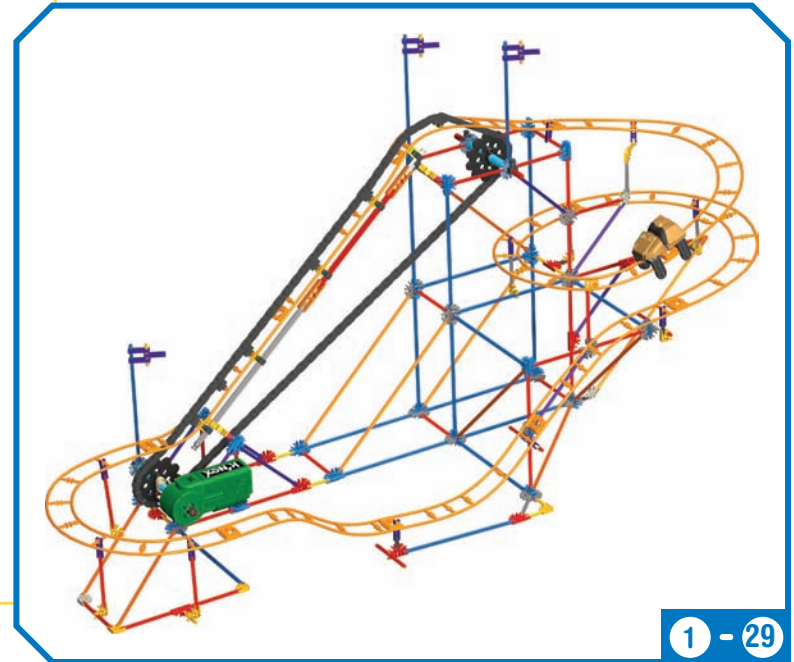

1 - 29