

k'nex

PANTHER ATTACK Additional Build

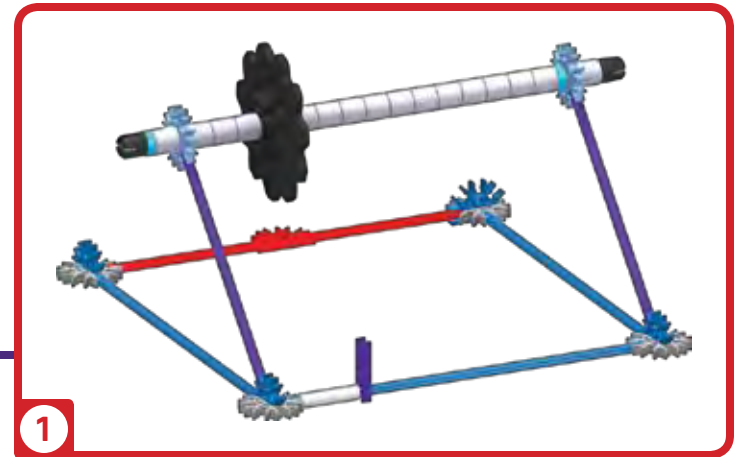

1

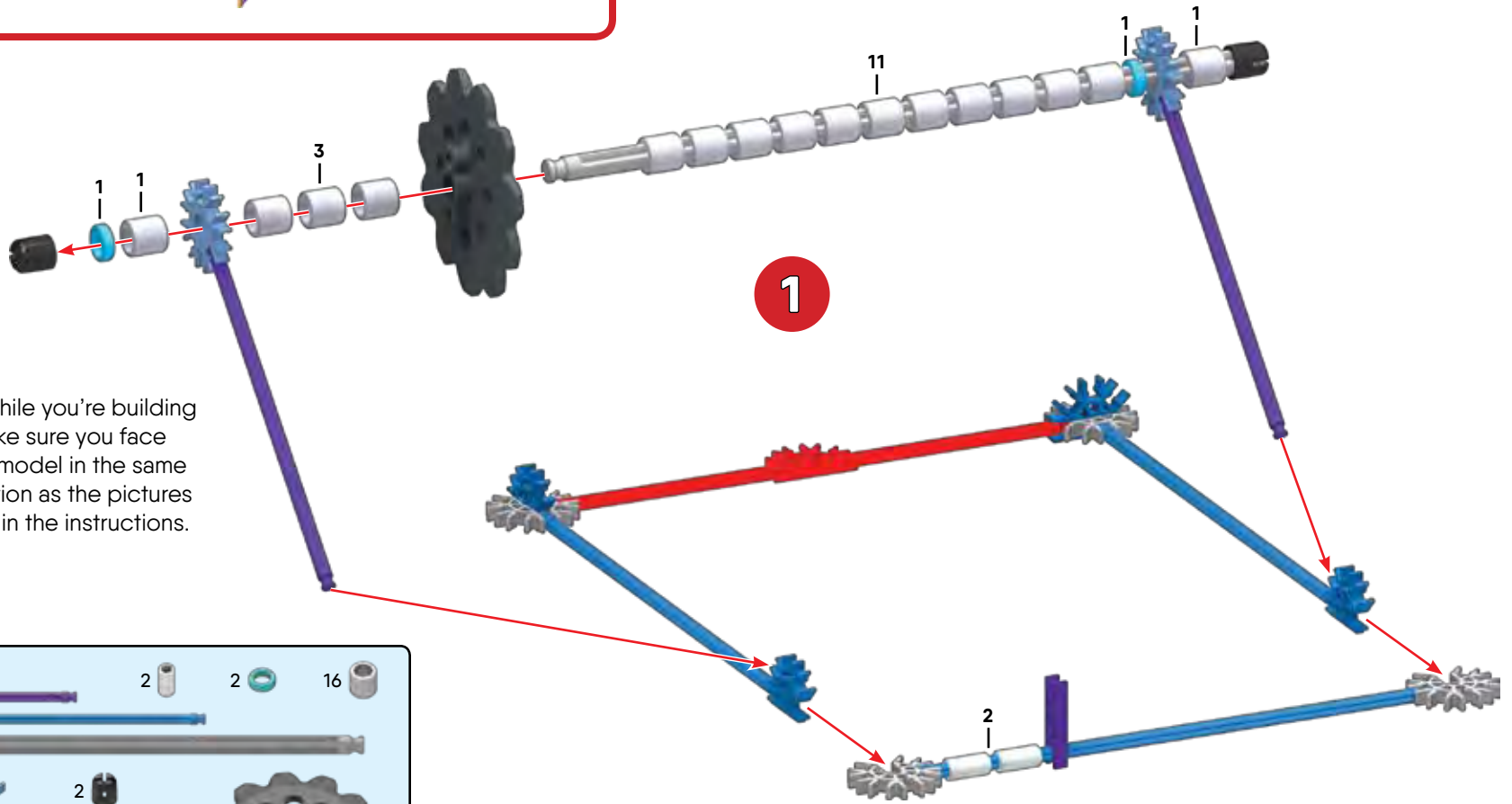

1

TIP: While you're building make sure you face your model in the same direction as the pictures show in the instructions.

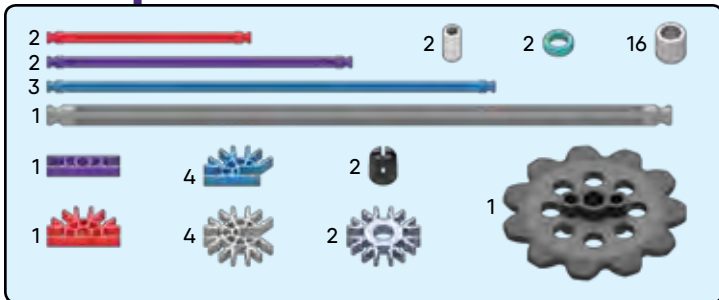

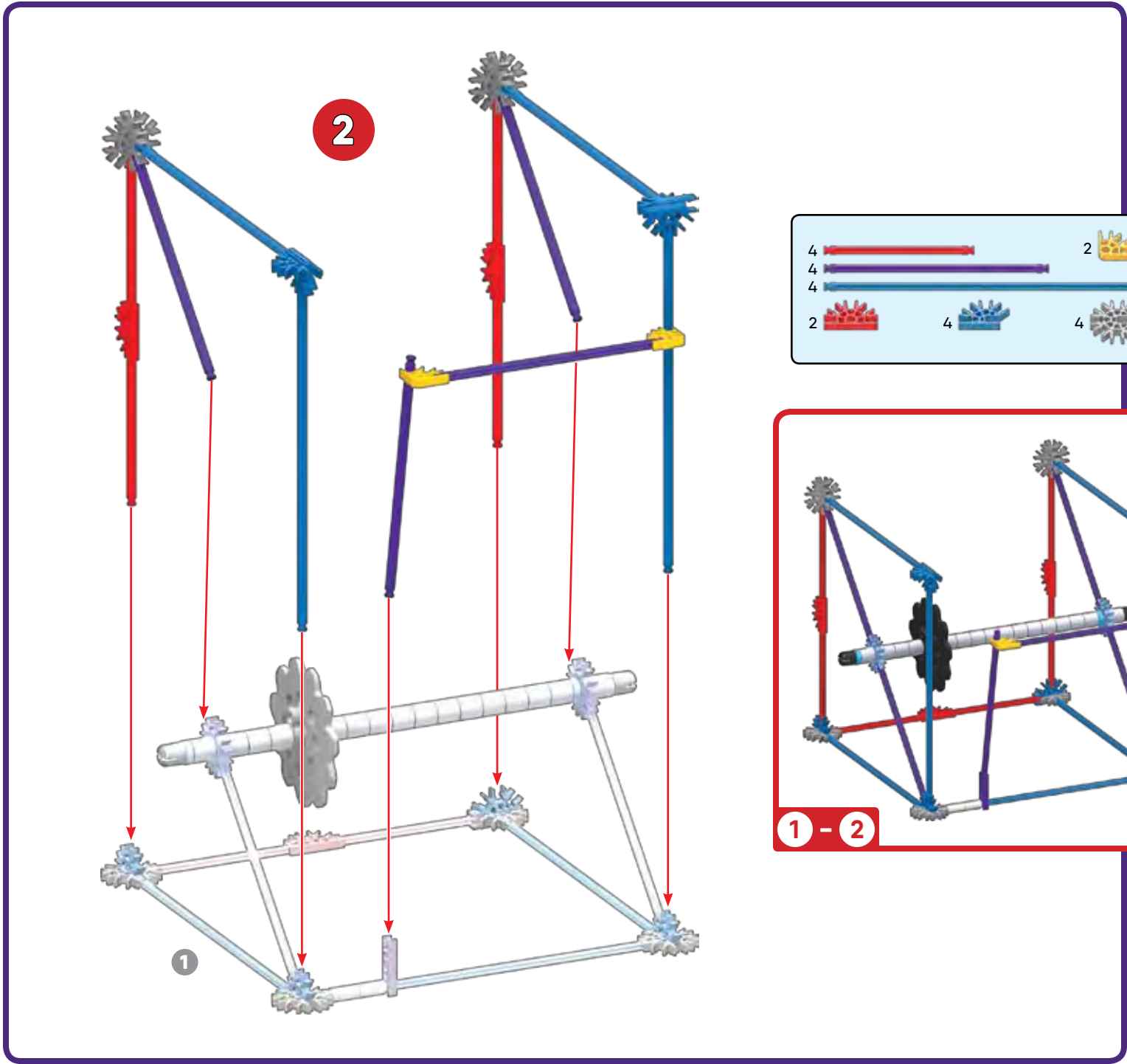

2

1

4		2	
4			
4			
2		4	
		4	

1 - 2

3

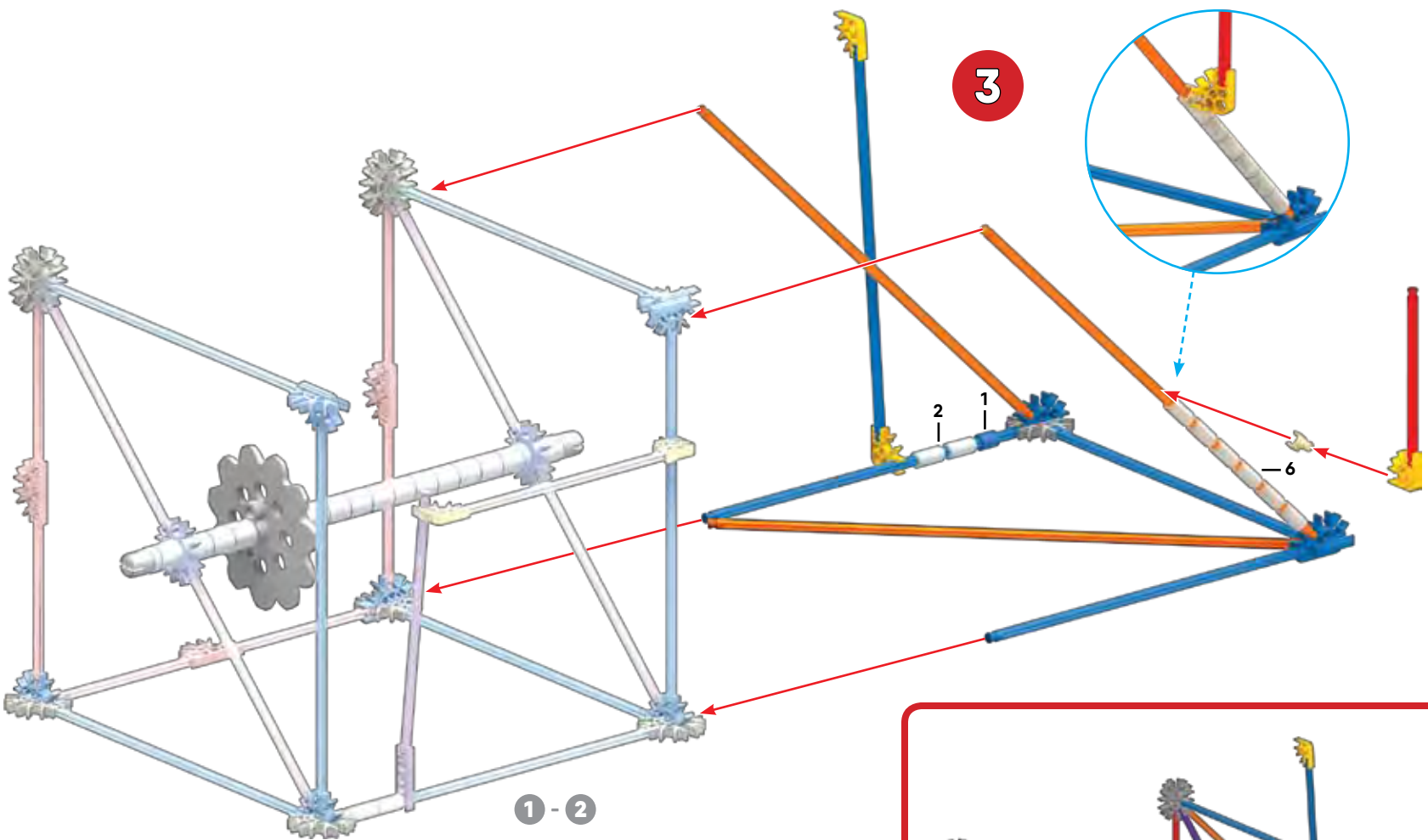

1 - 2

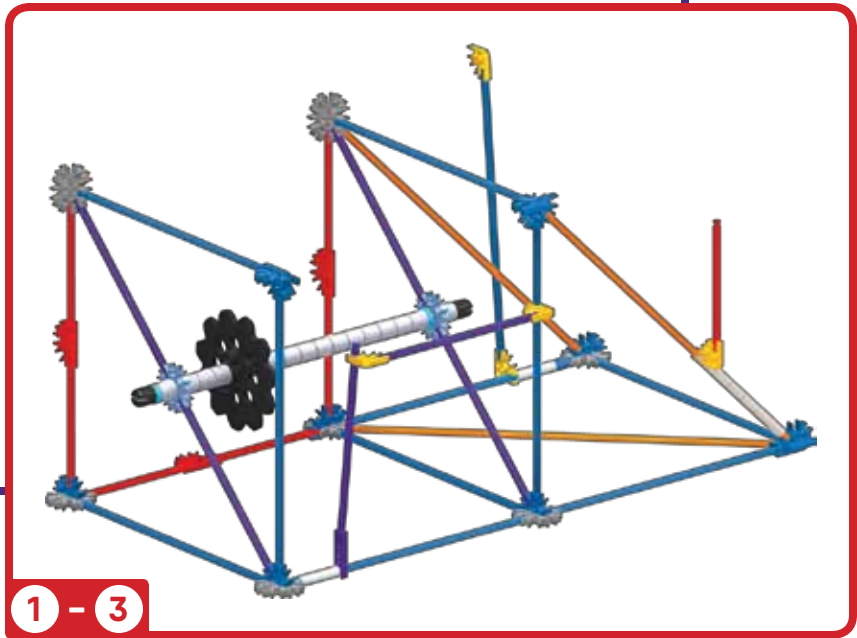
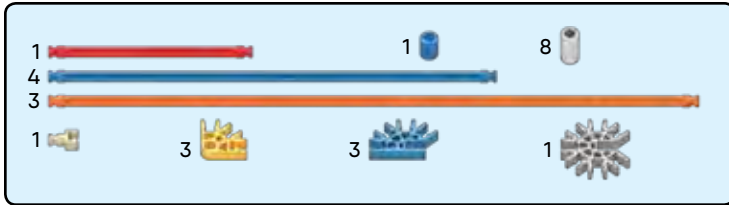

1 - 3

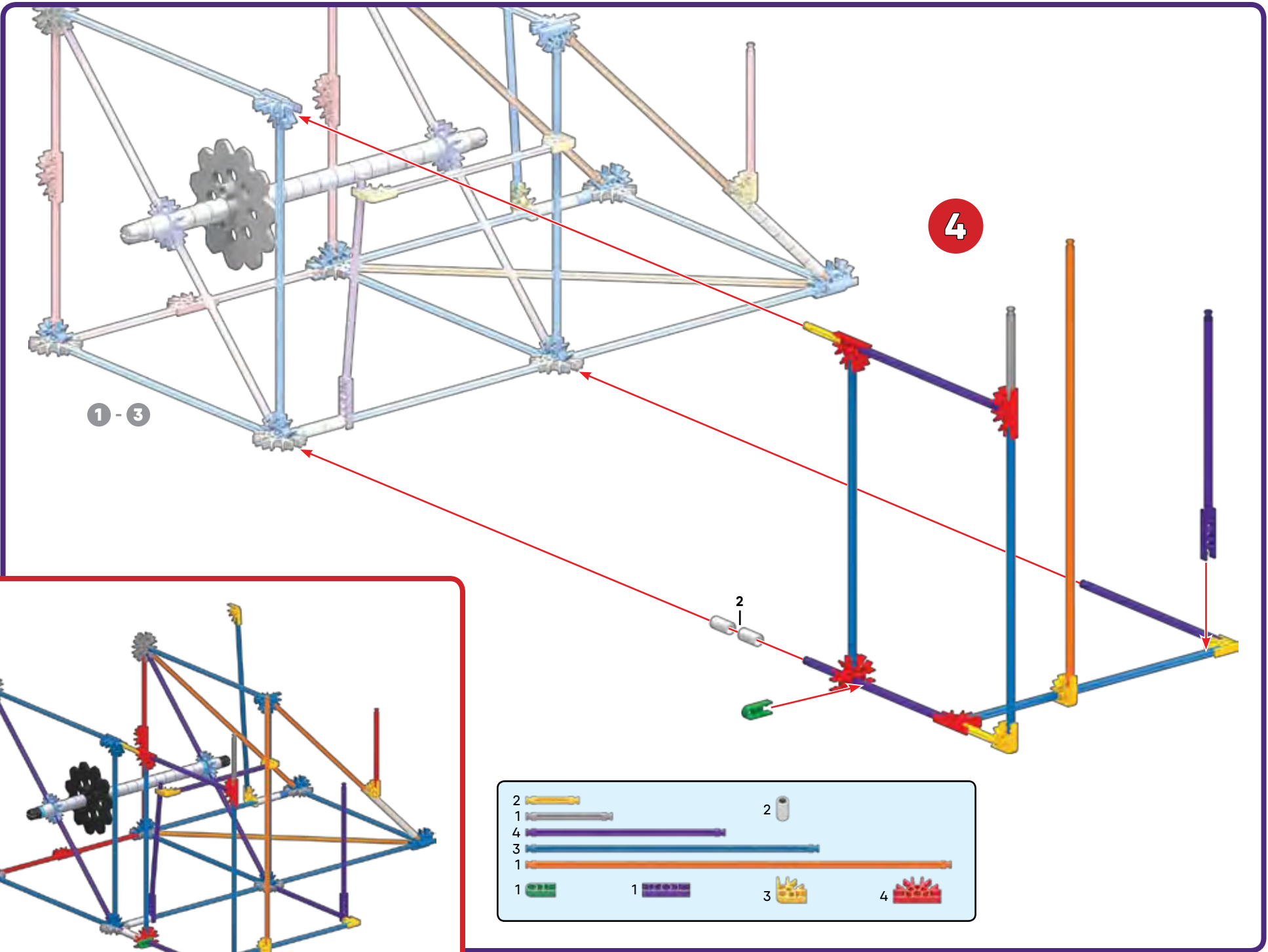

1 - 3

4

2

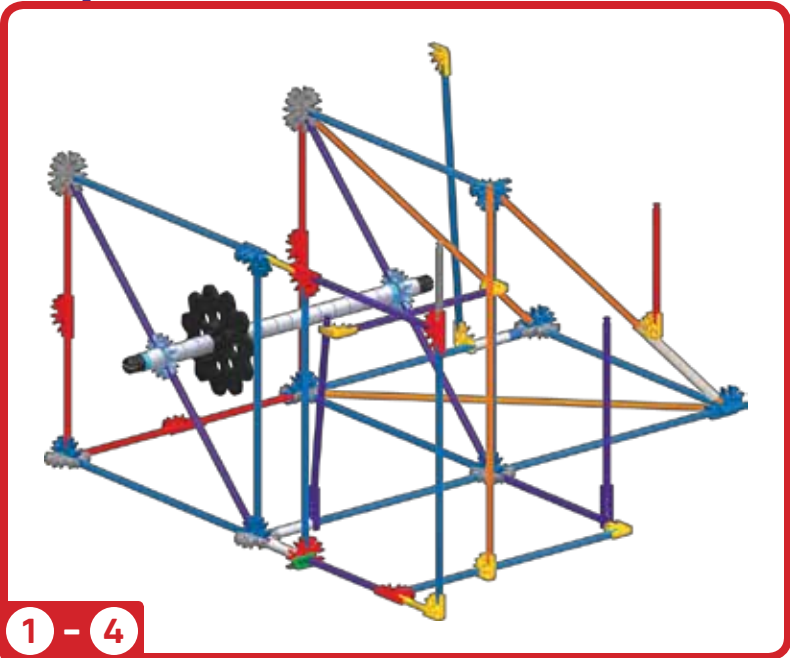

1 - 4

- | | | | |
|---|--|---|--|
| 2 | | 2 | |
| 1 | | | |
| 4 | | | |
| 3 | | | |
| 1 | | | |
| 1 | | 1 | |
| | | 3 | |
| | | 4 | |

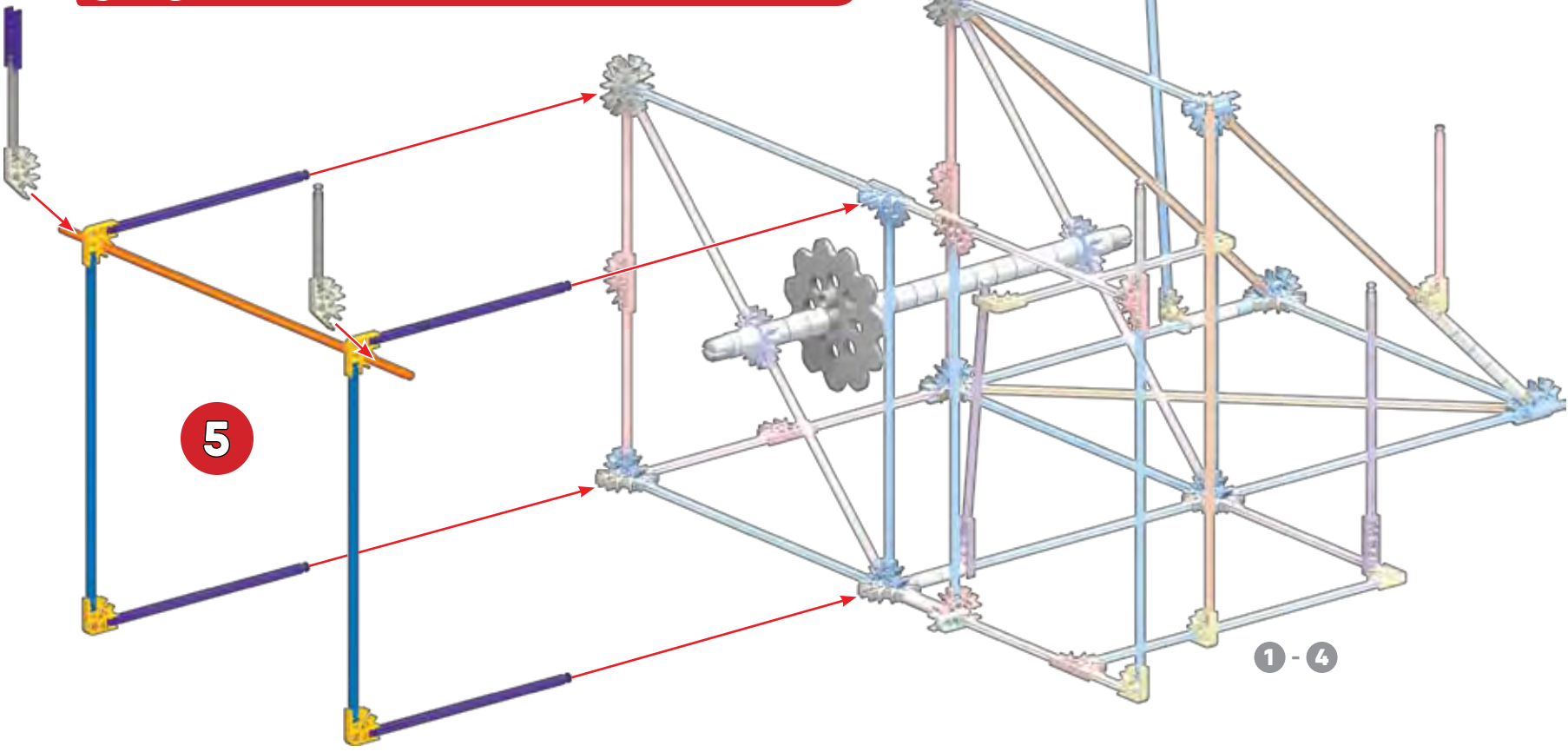
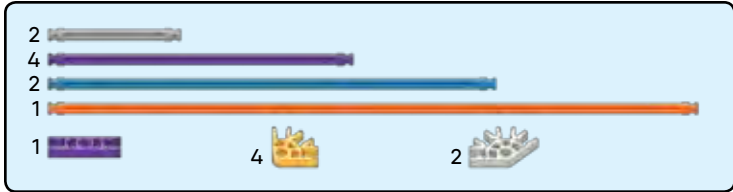
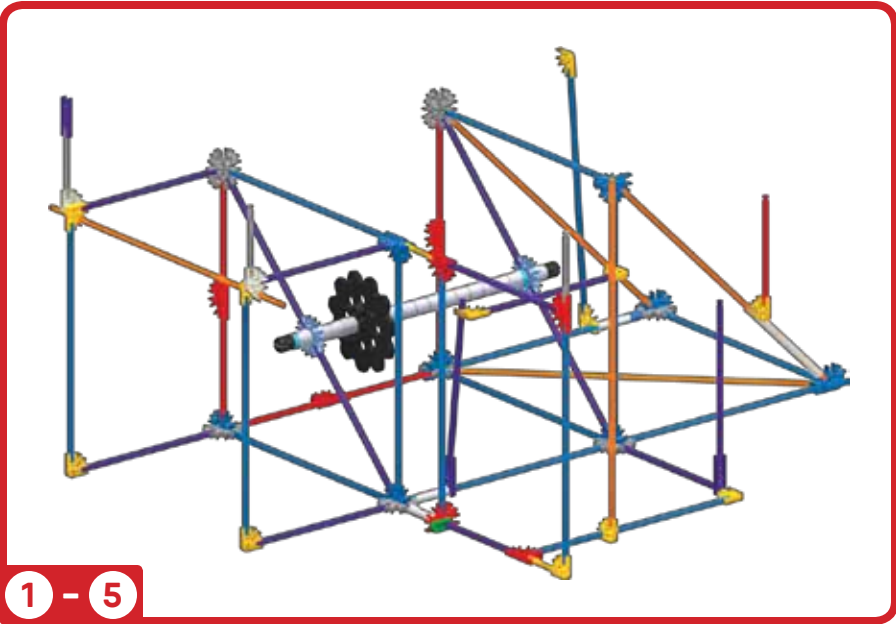

6

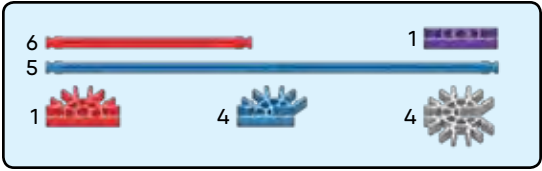
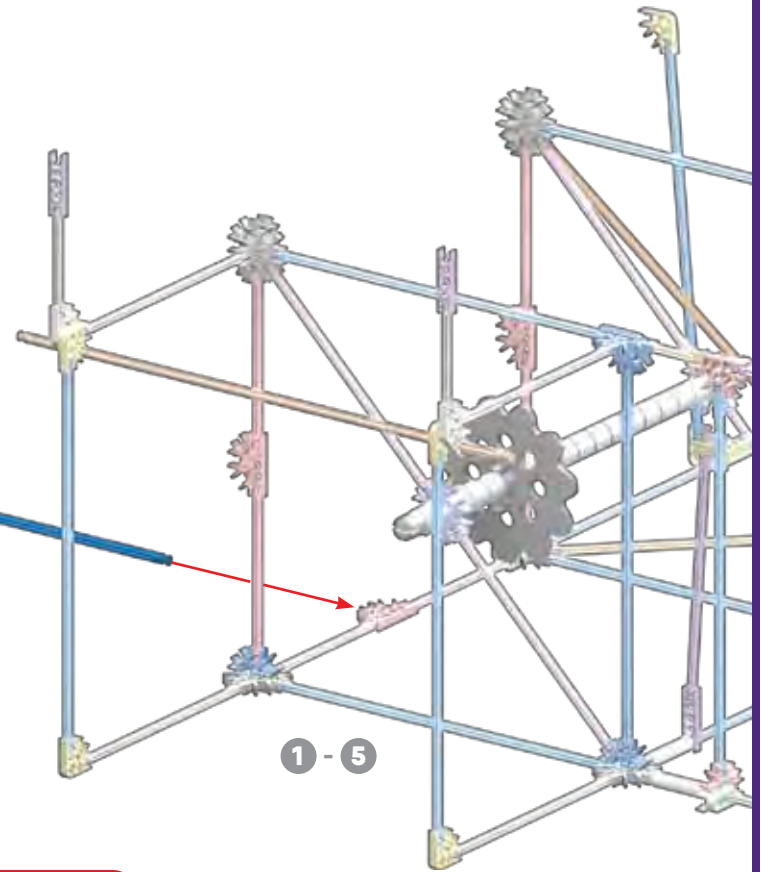
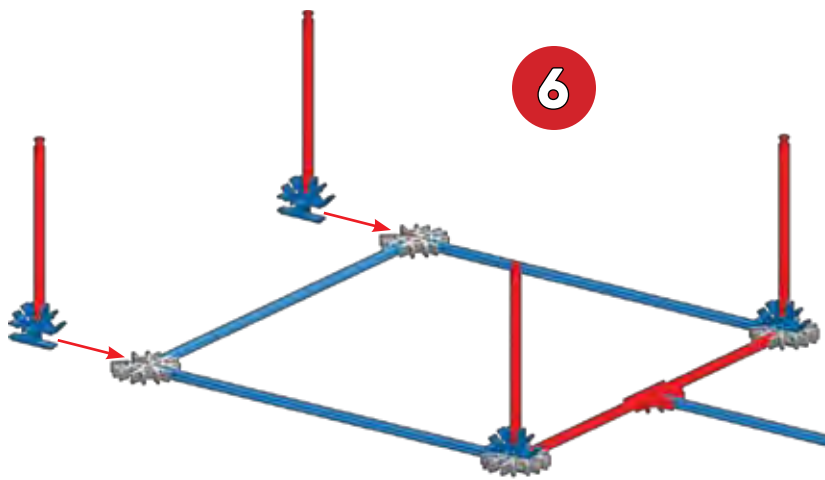

1 - 5

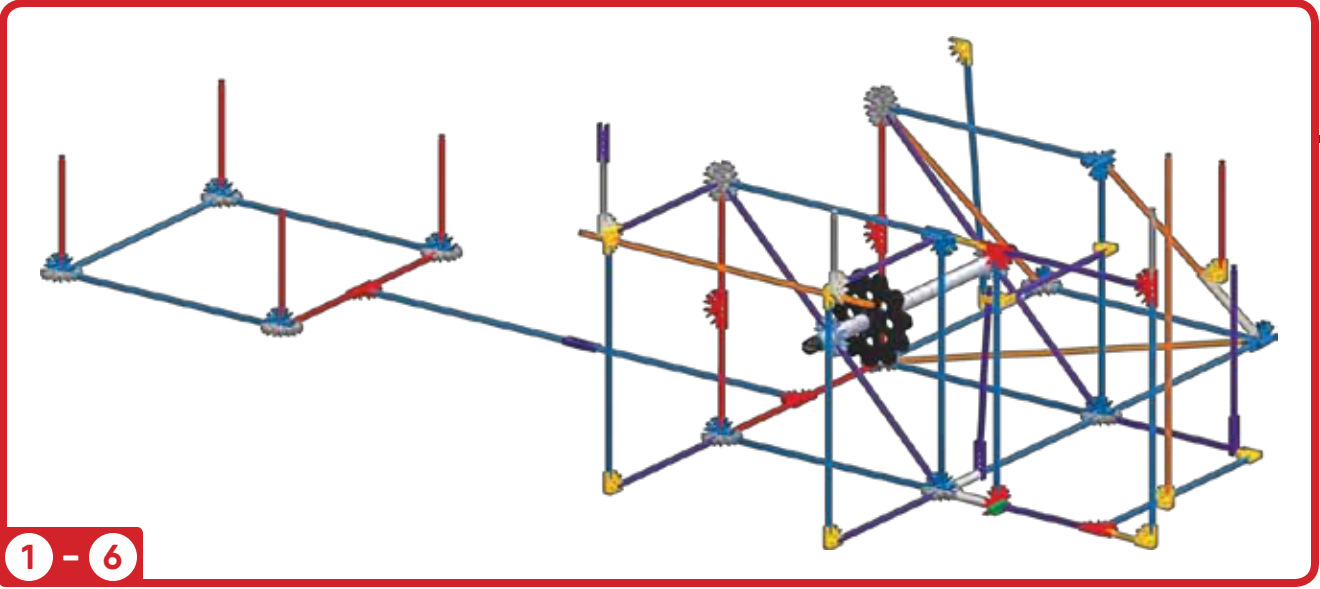

1 - 6

7

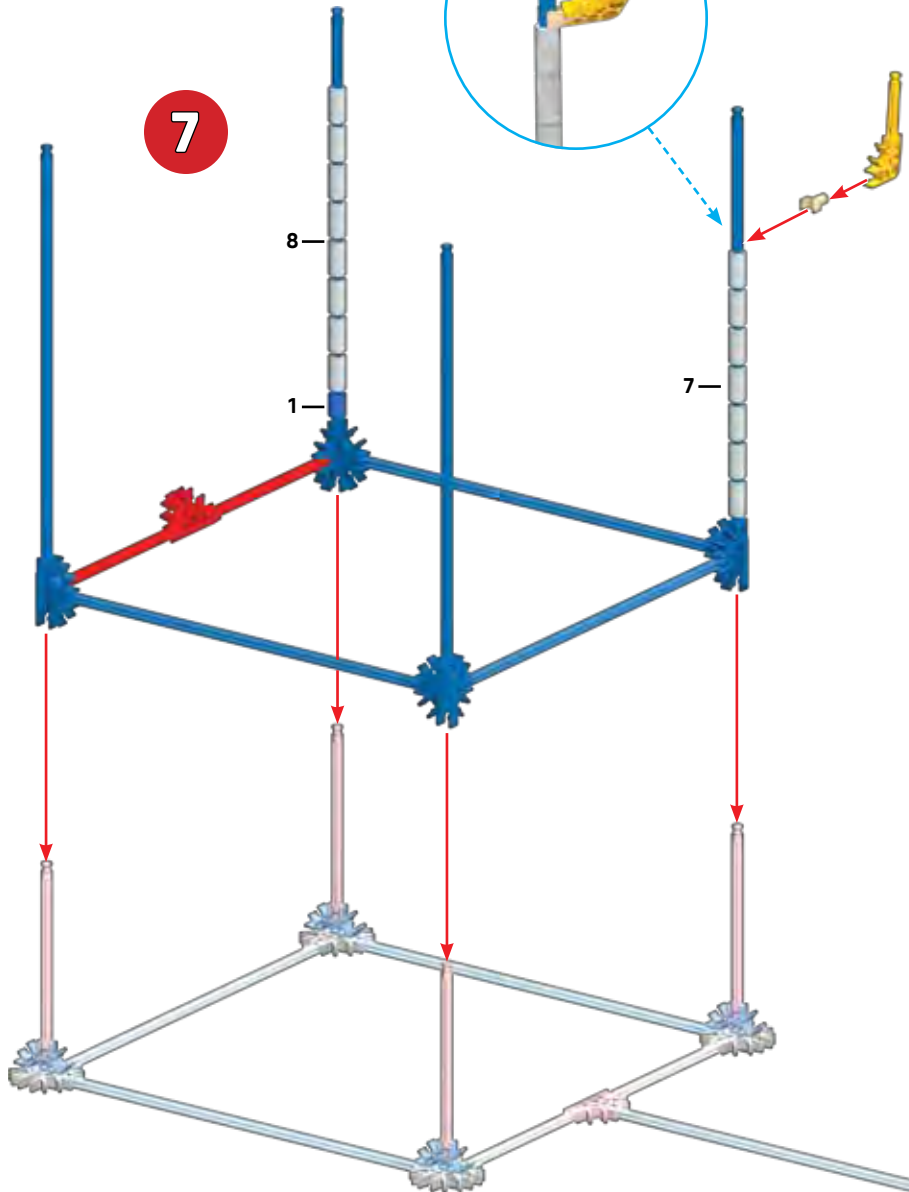
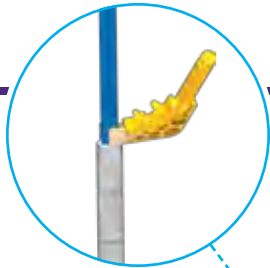

1 - 7

- | | | | | | |
|---|--|---|--|----|--|
| 1 | | 1 | | 15 | |
| 2 | | | | | |
| 7 | | | | | |
| 1 | | 1 | | 1 | |
| | | | | 8 | |

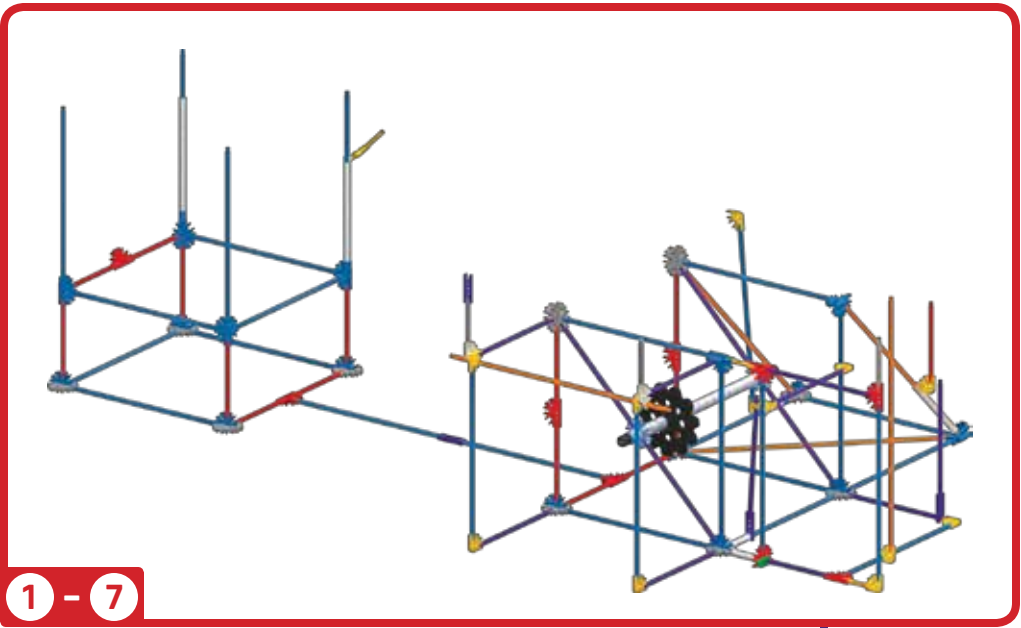

1 - 6

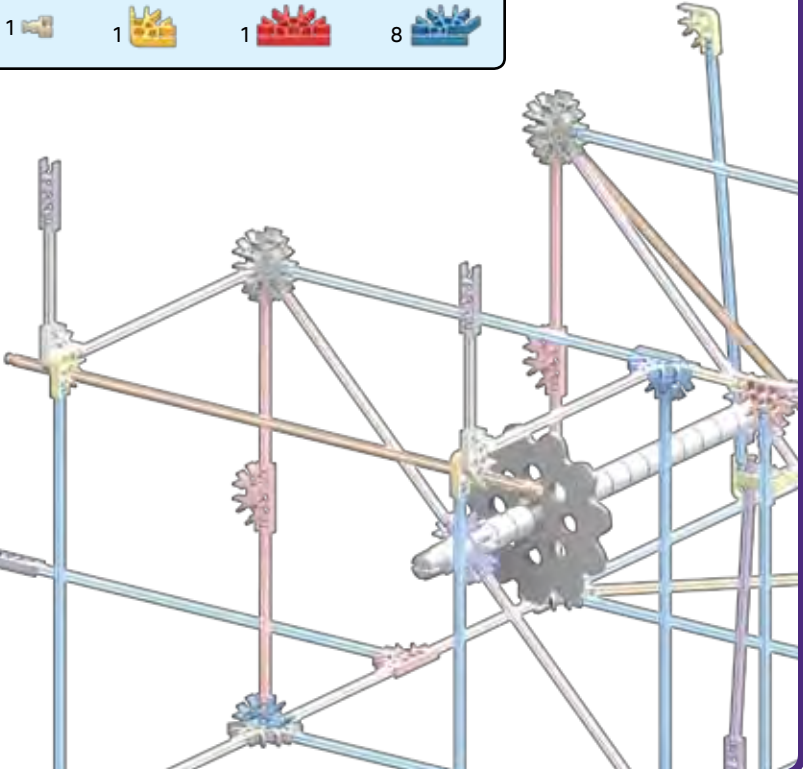

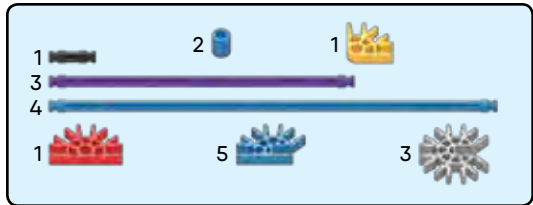
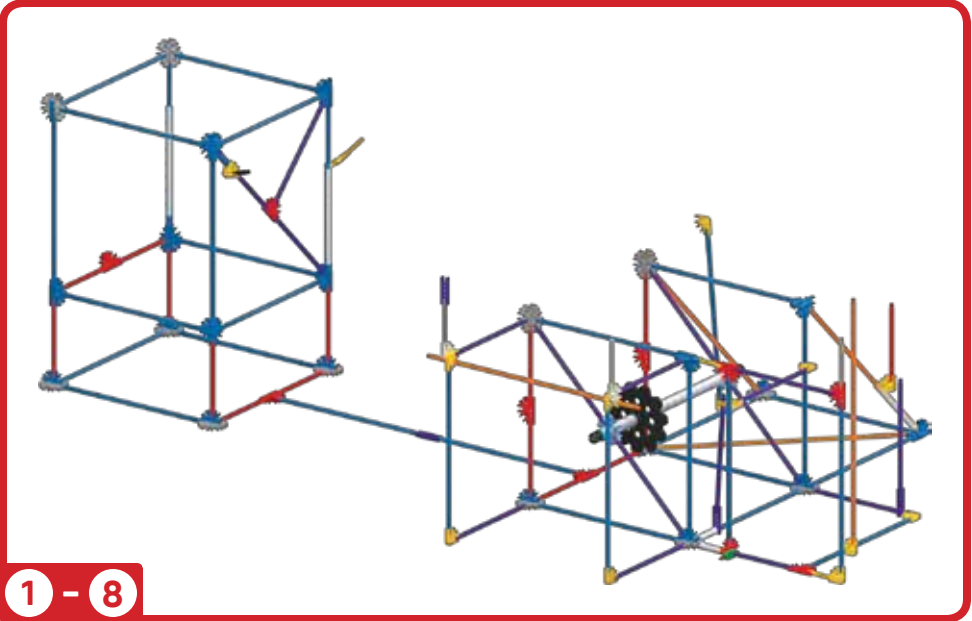
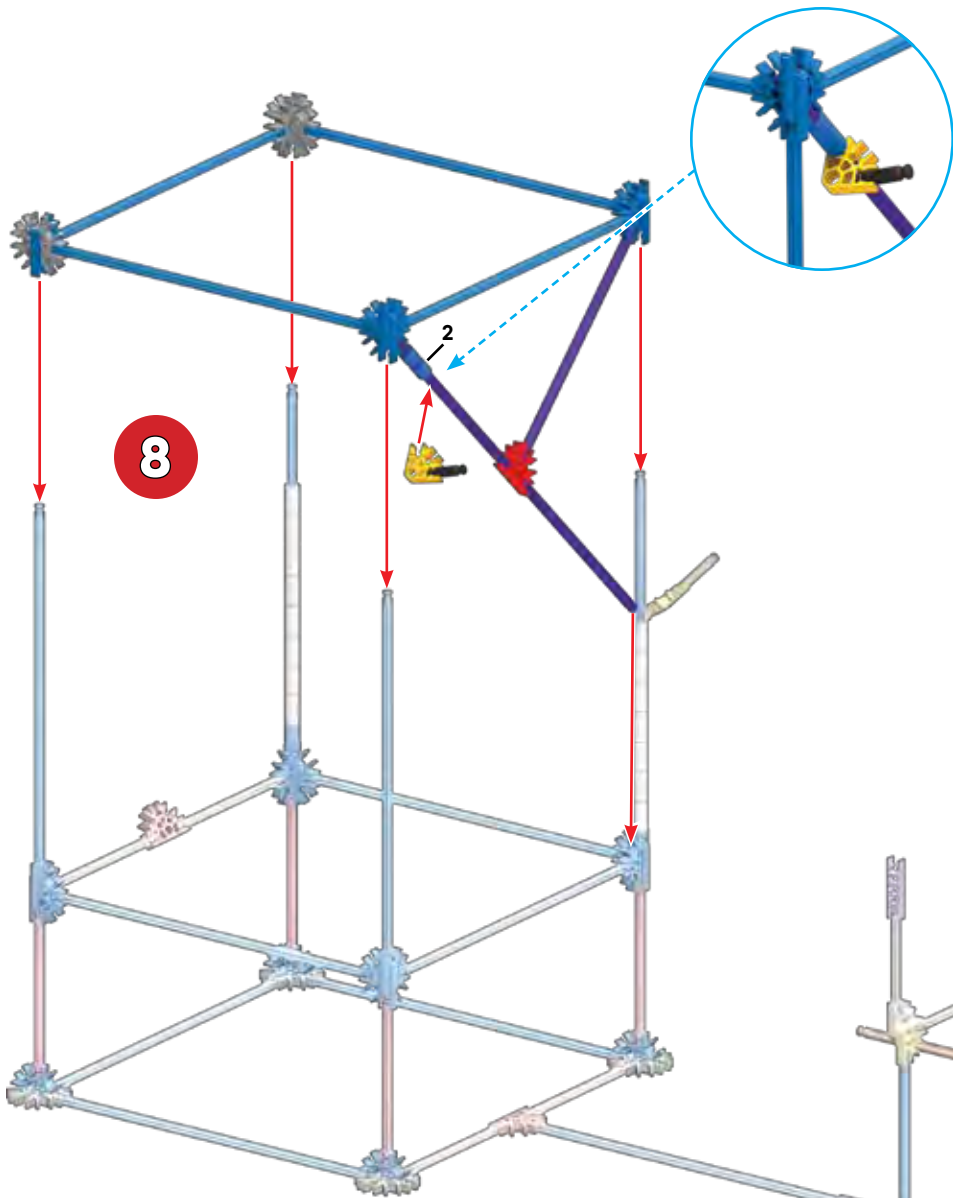

1 - 7

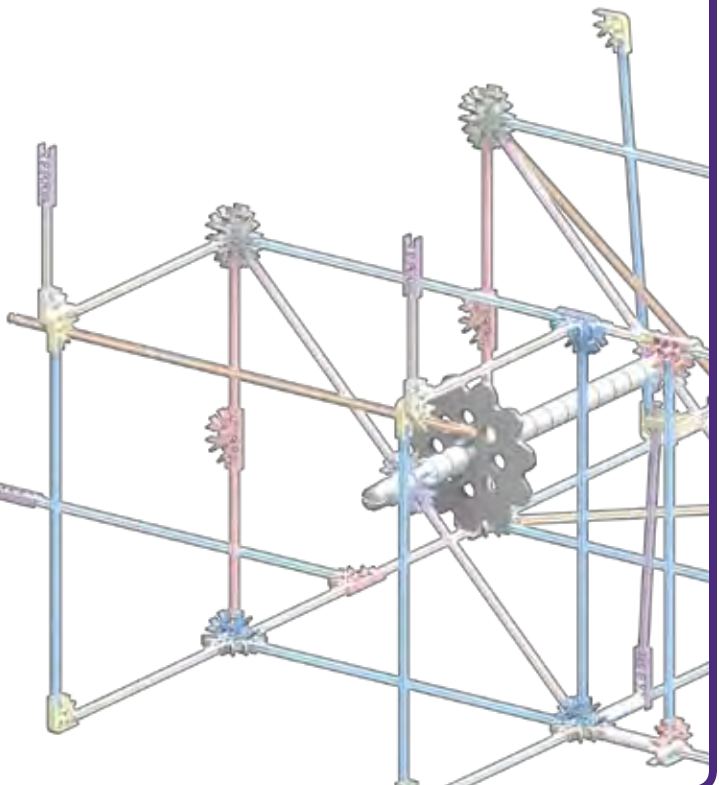

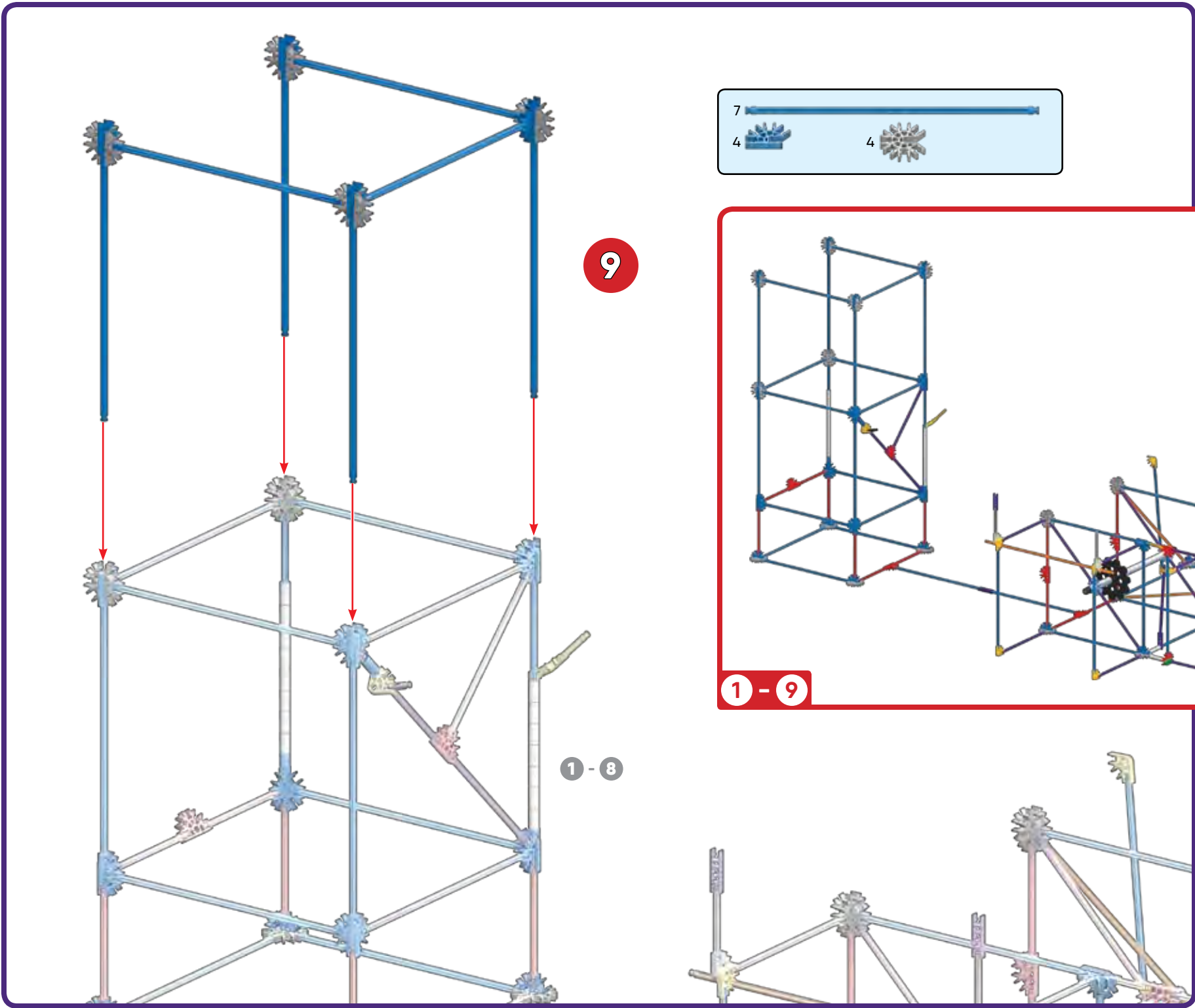

9

7 

4  4 

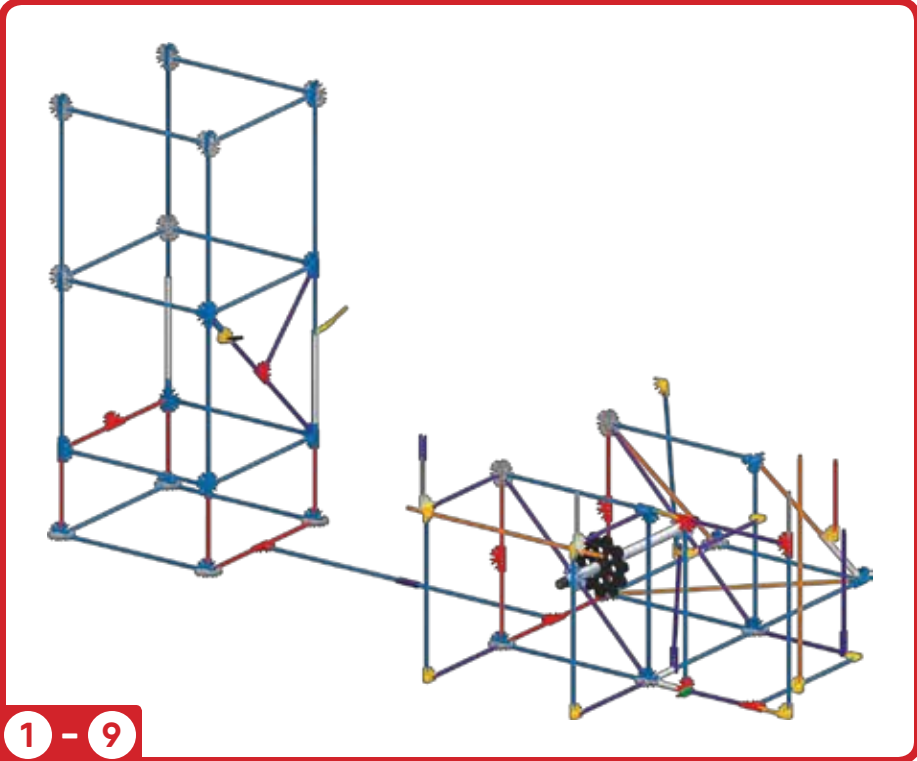

1 - 9

1 - 8

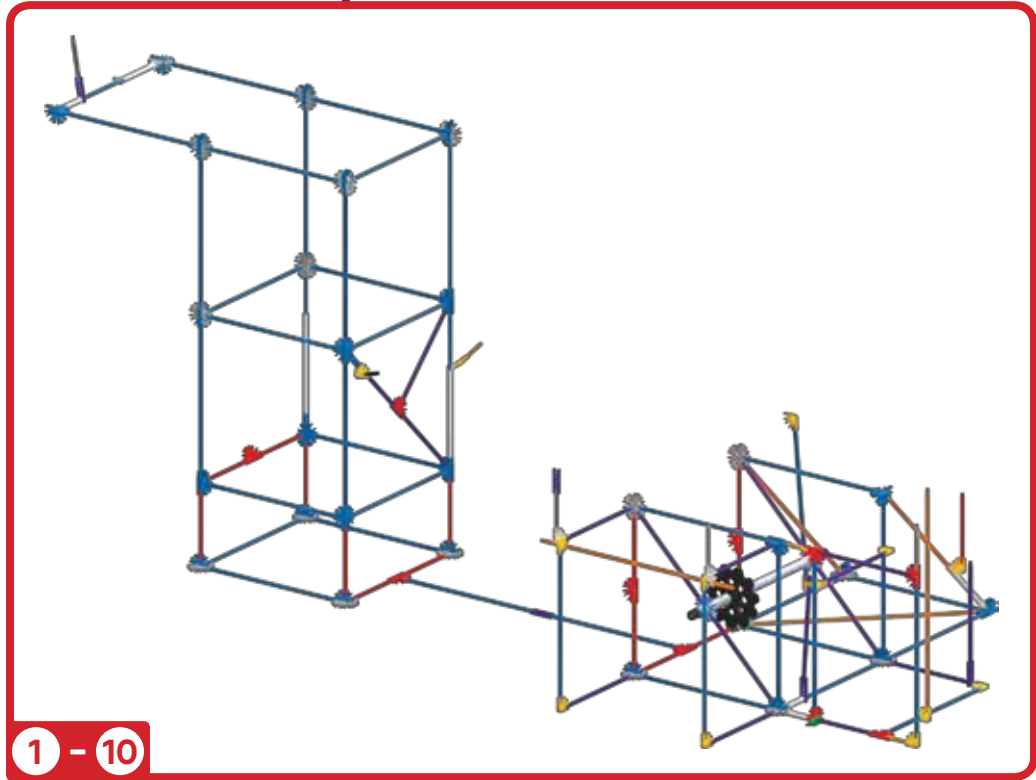

1 - 10

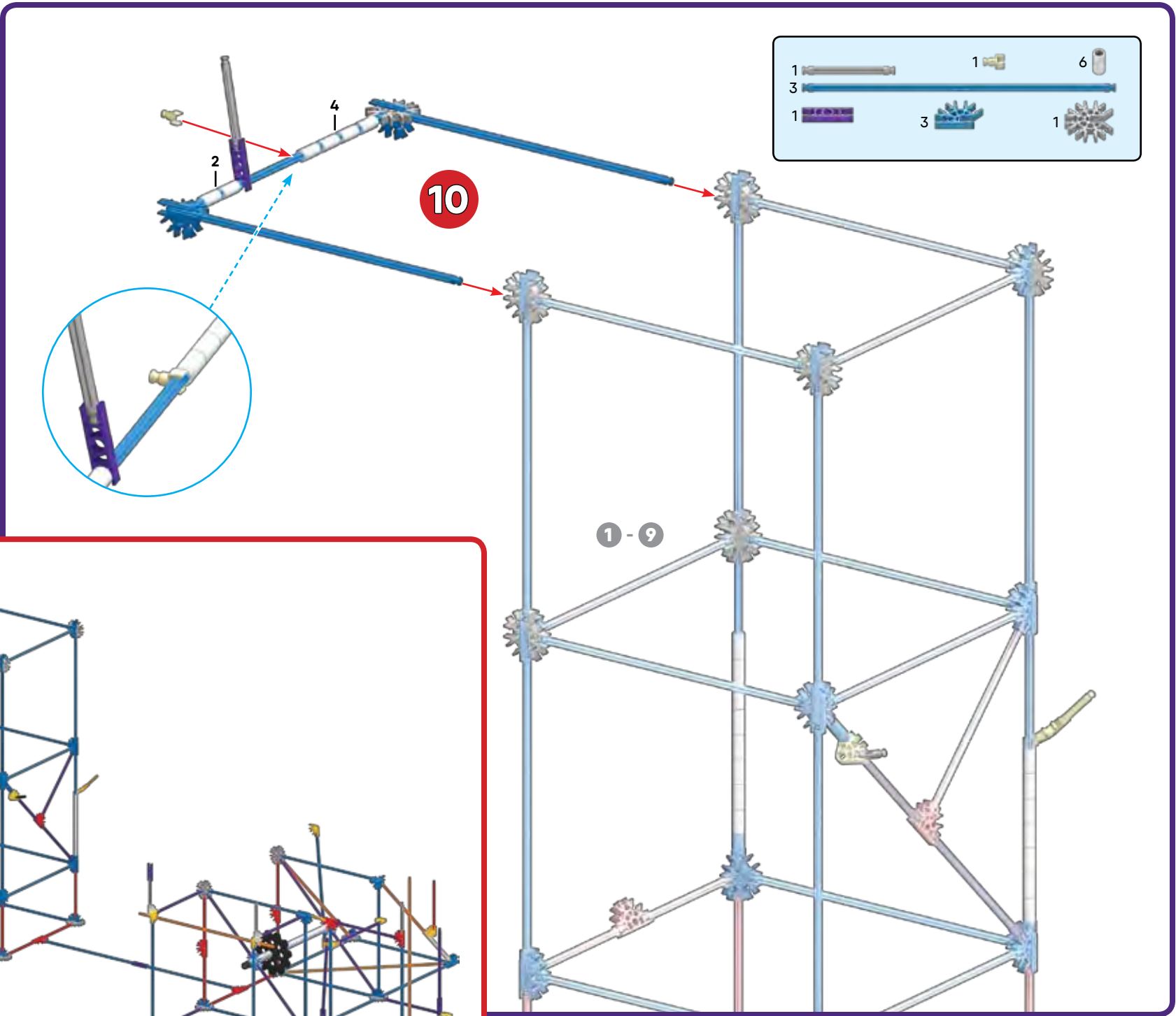

- | | | |
|---|---|---|
| 1 | 1 | 6 |
| 3 | | |
| 1 | 3 | 1 |

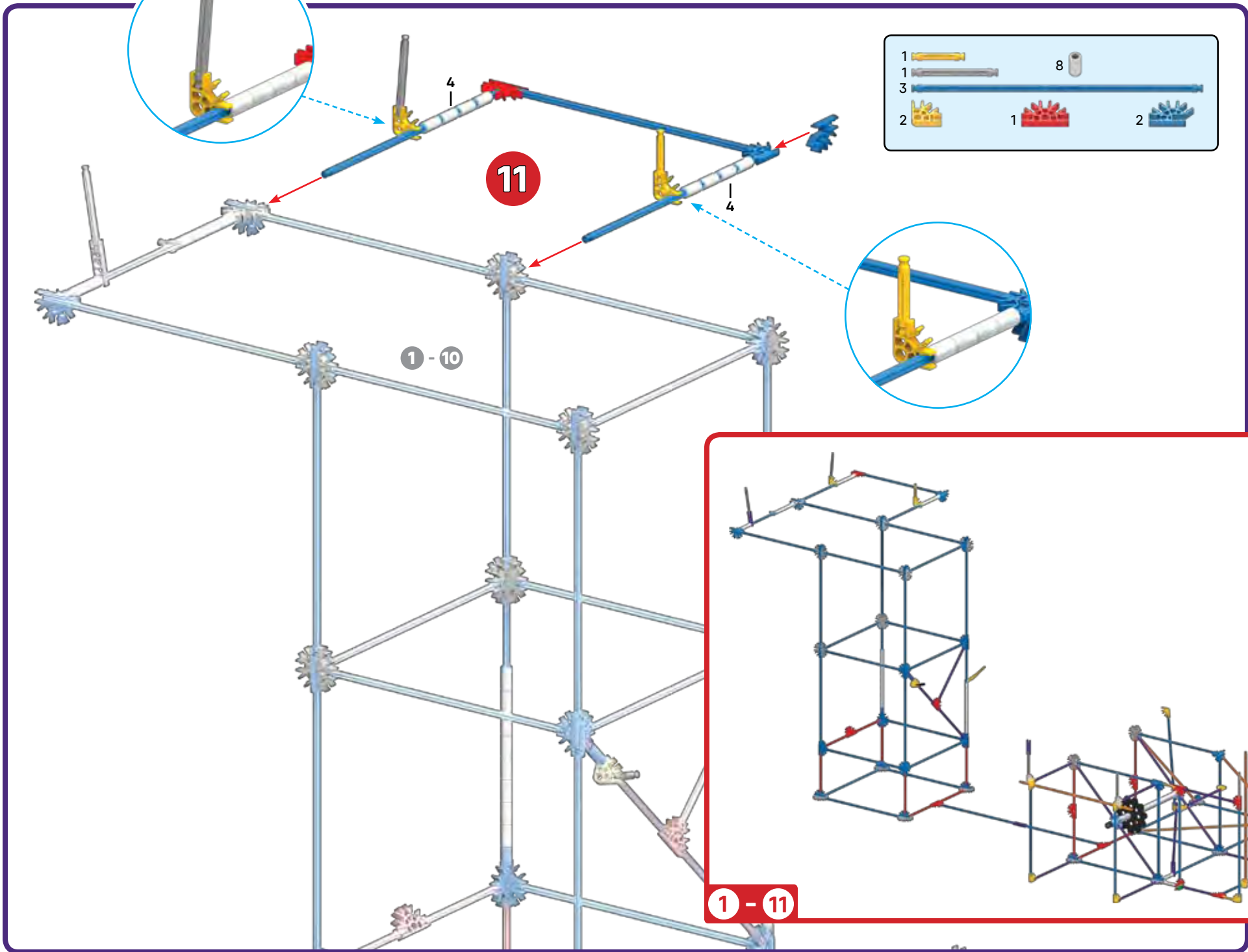

- | | | | |
|---|--|---|--|
| 1 | | 8 | |
| 1 | | | |
| 3 | | | |
| 2 | | 1 | |
| | | 2 | |

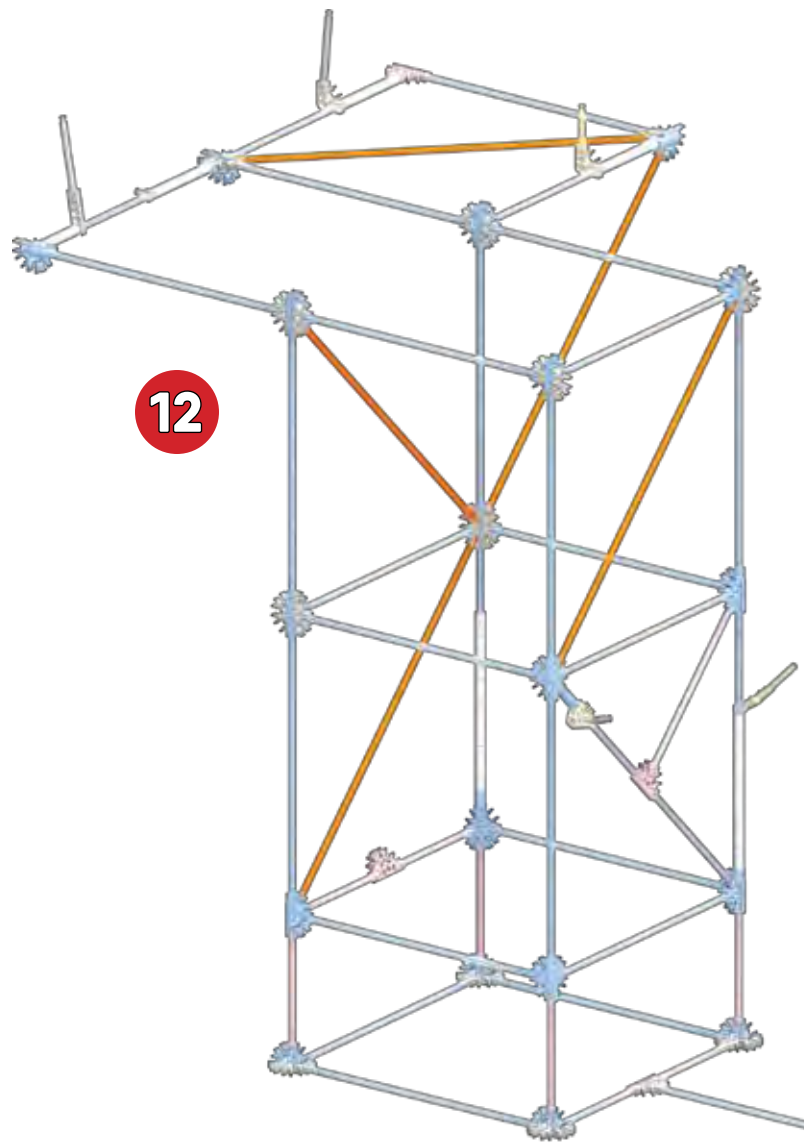

12

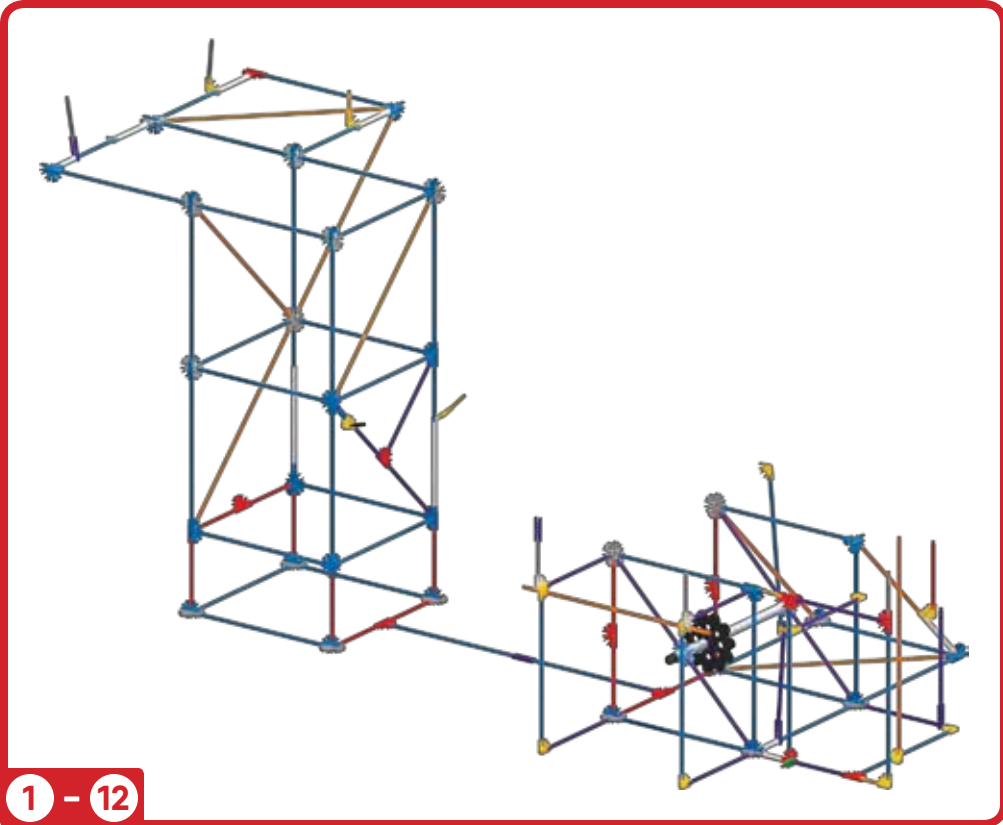

1 - 12

1 - 11

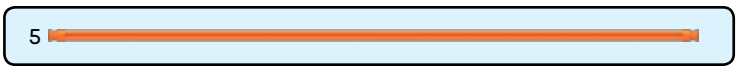

5

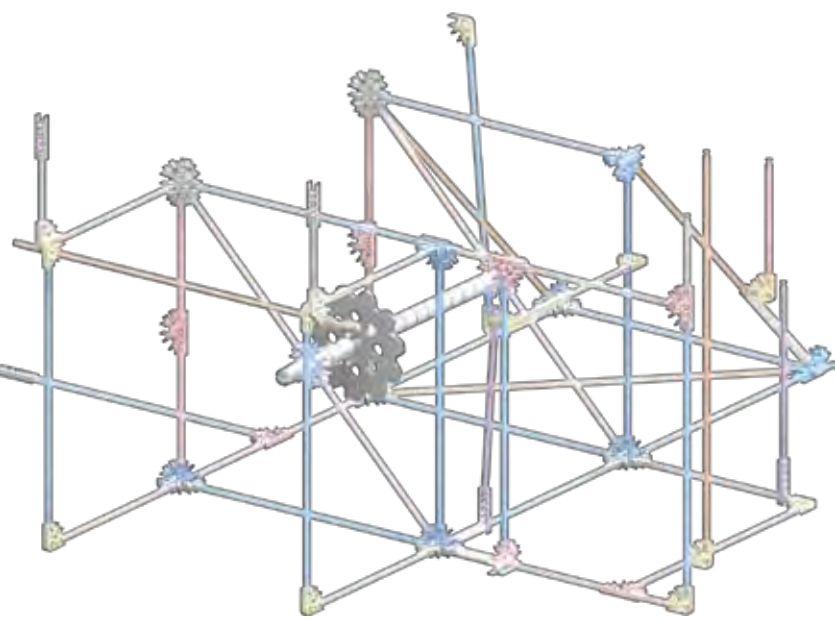

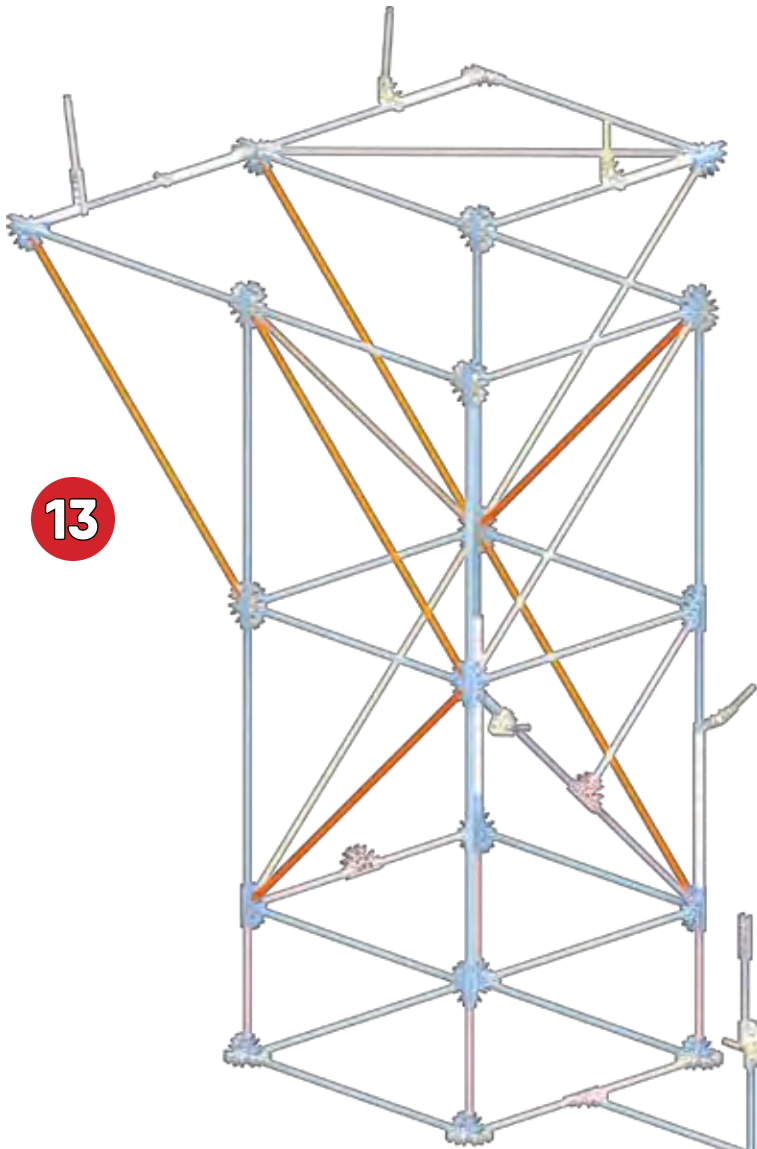

13

1 - 13

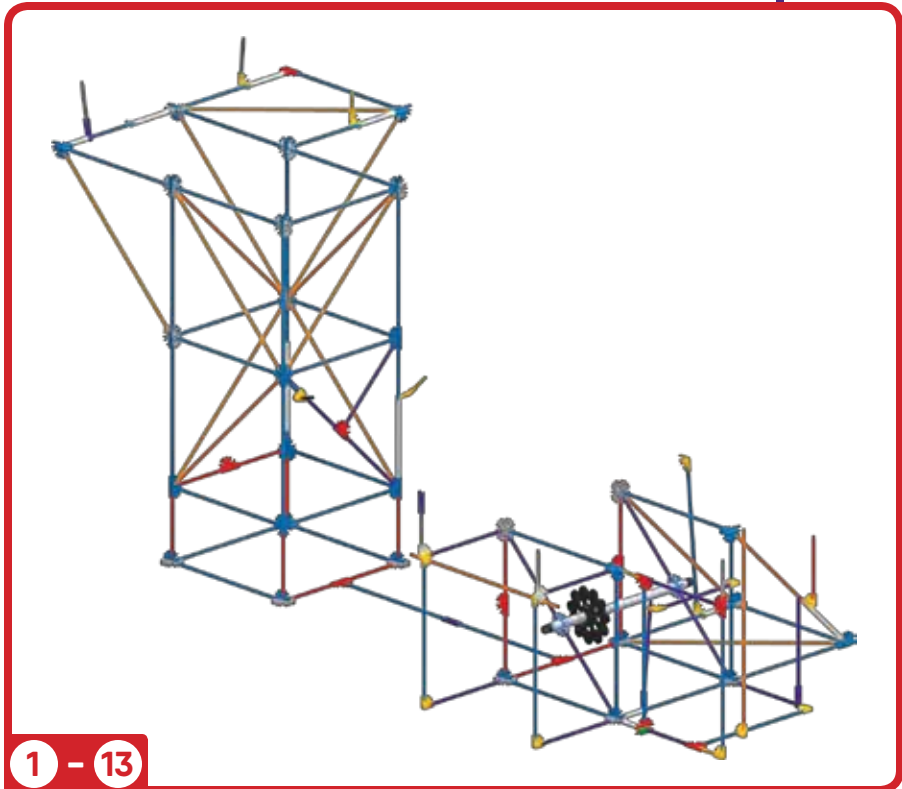

1 - 12

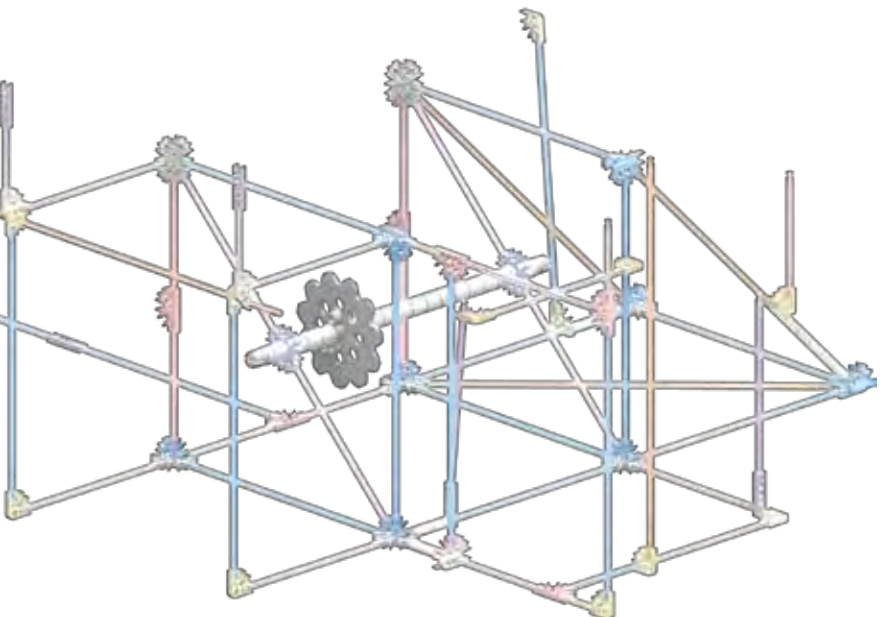

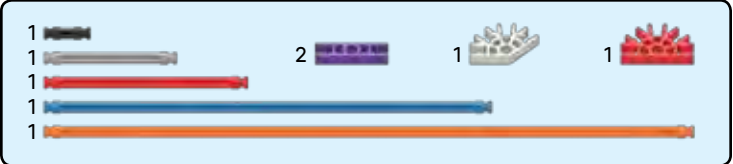
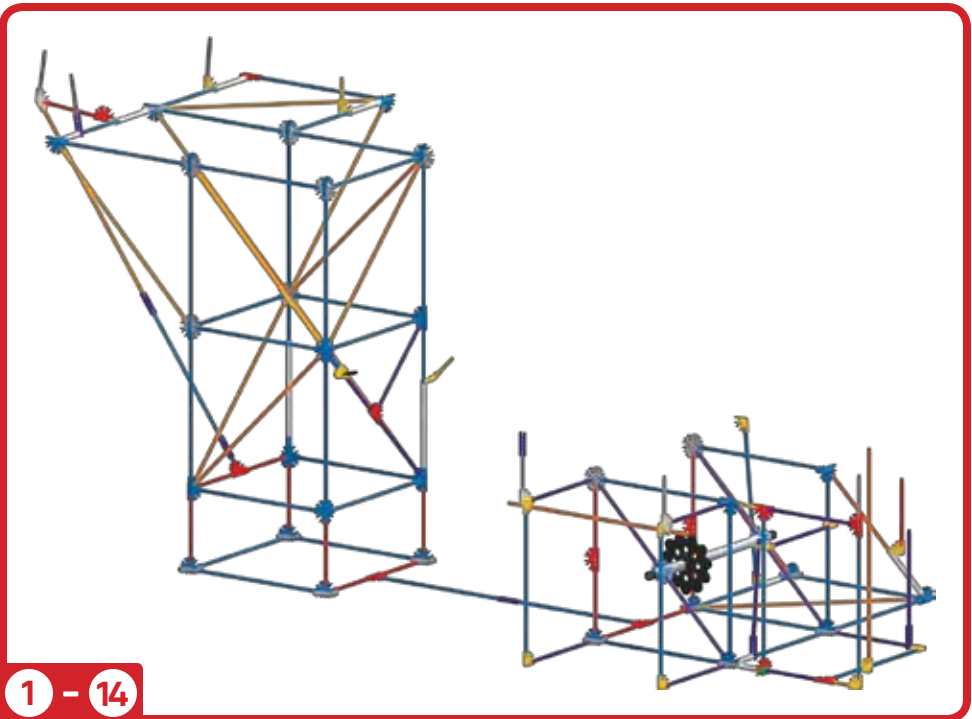
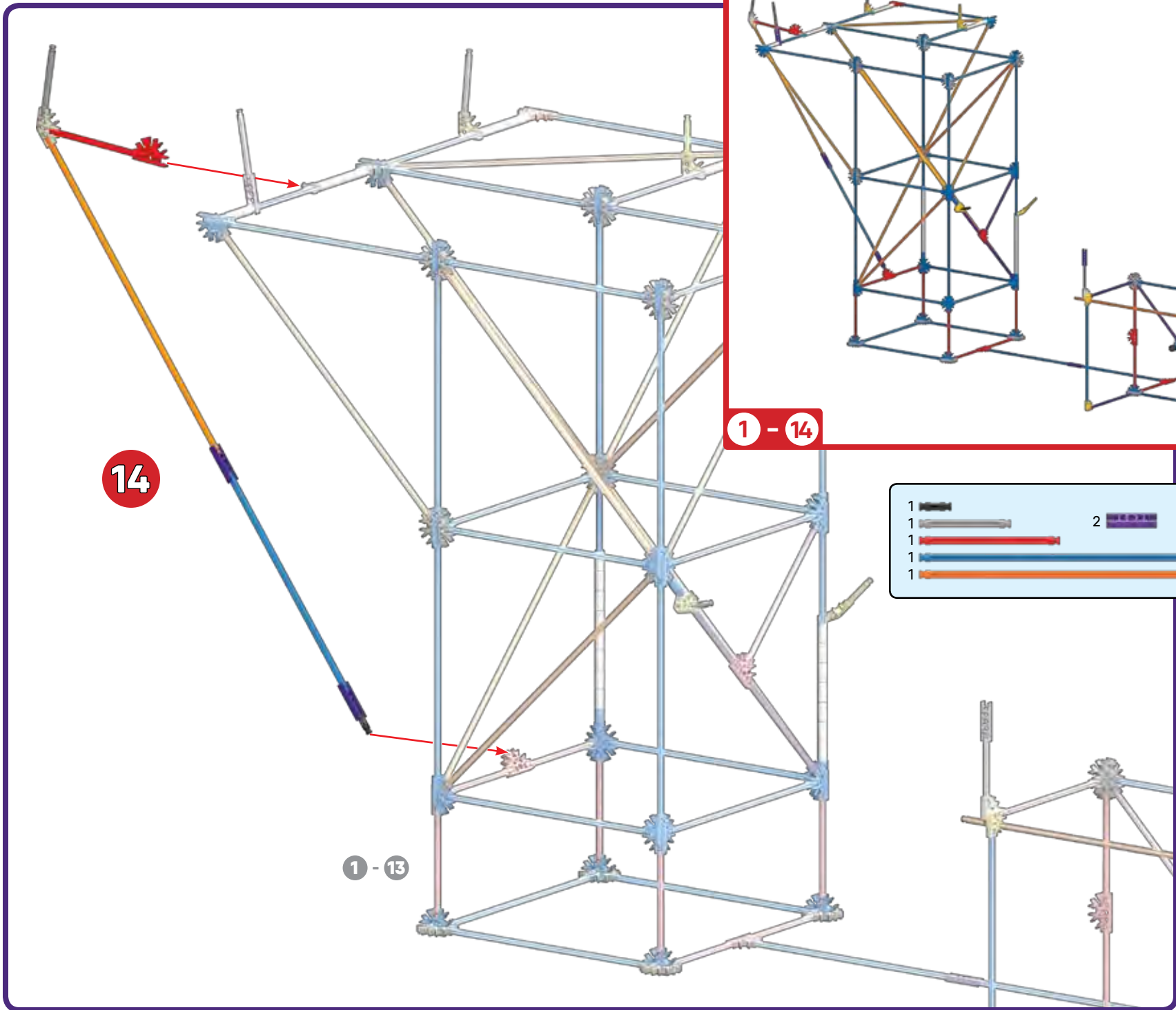

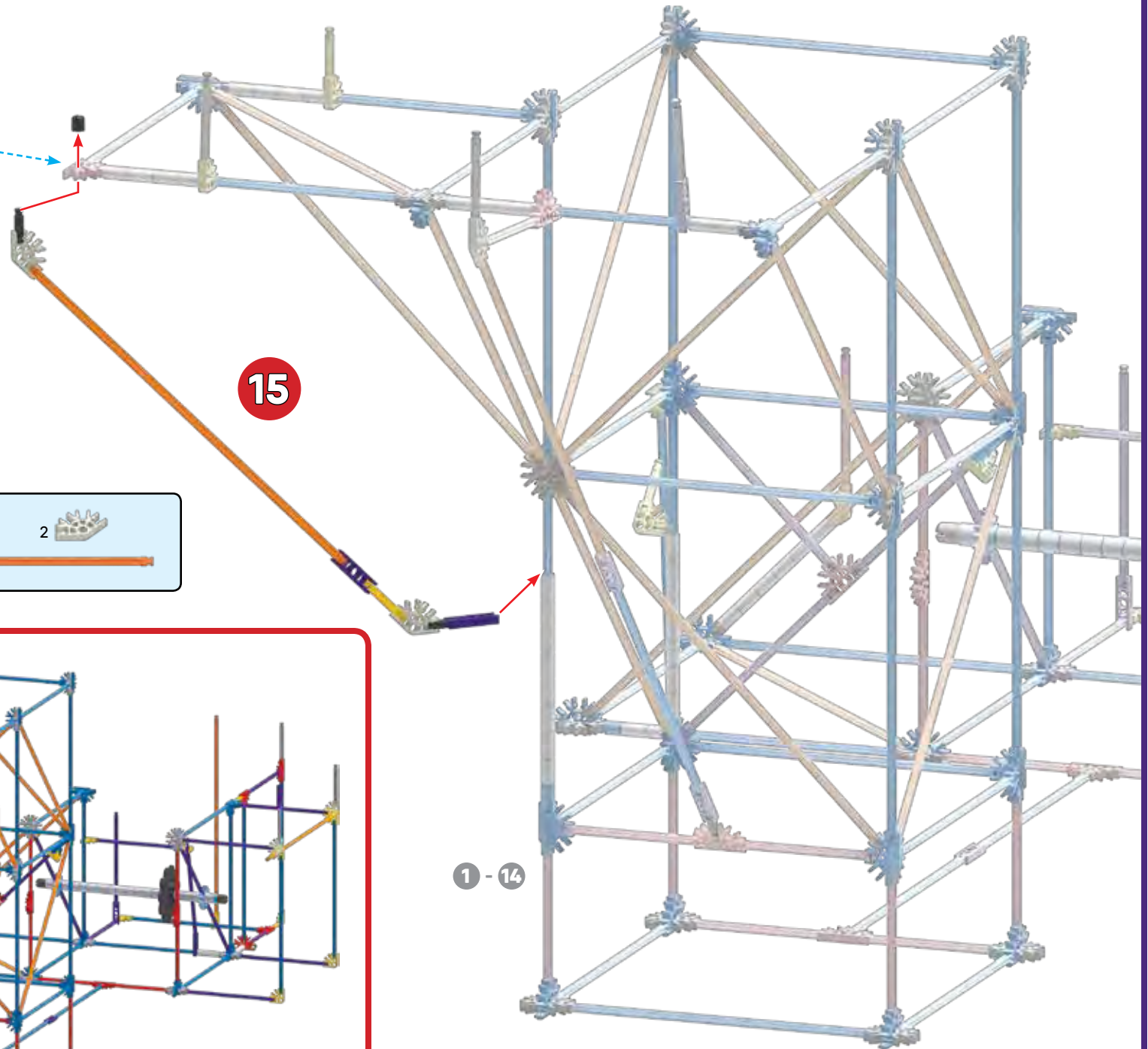
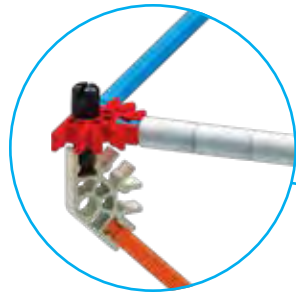

15

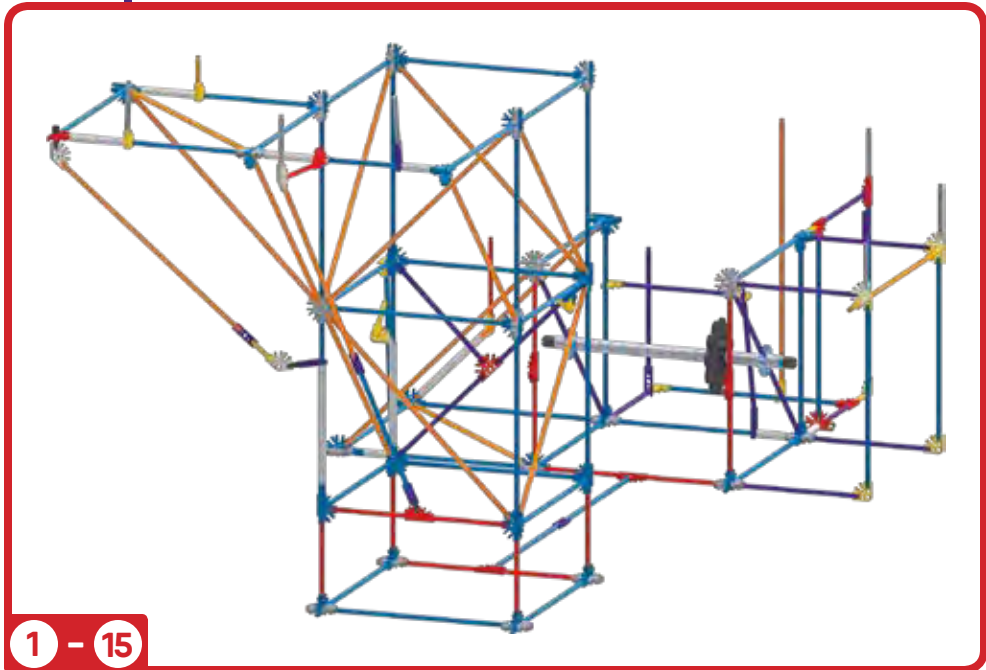
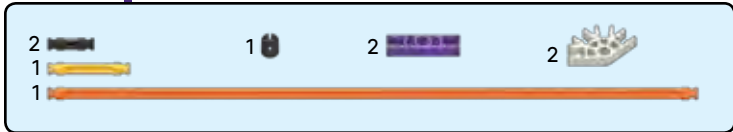

1 - 15

1 - 14

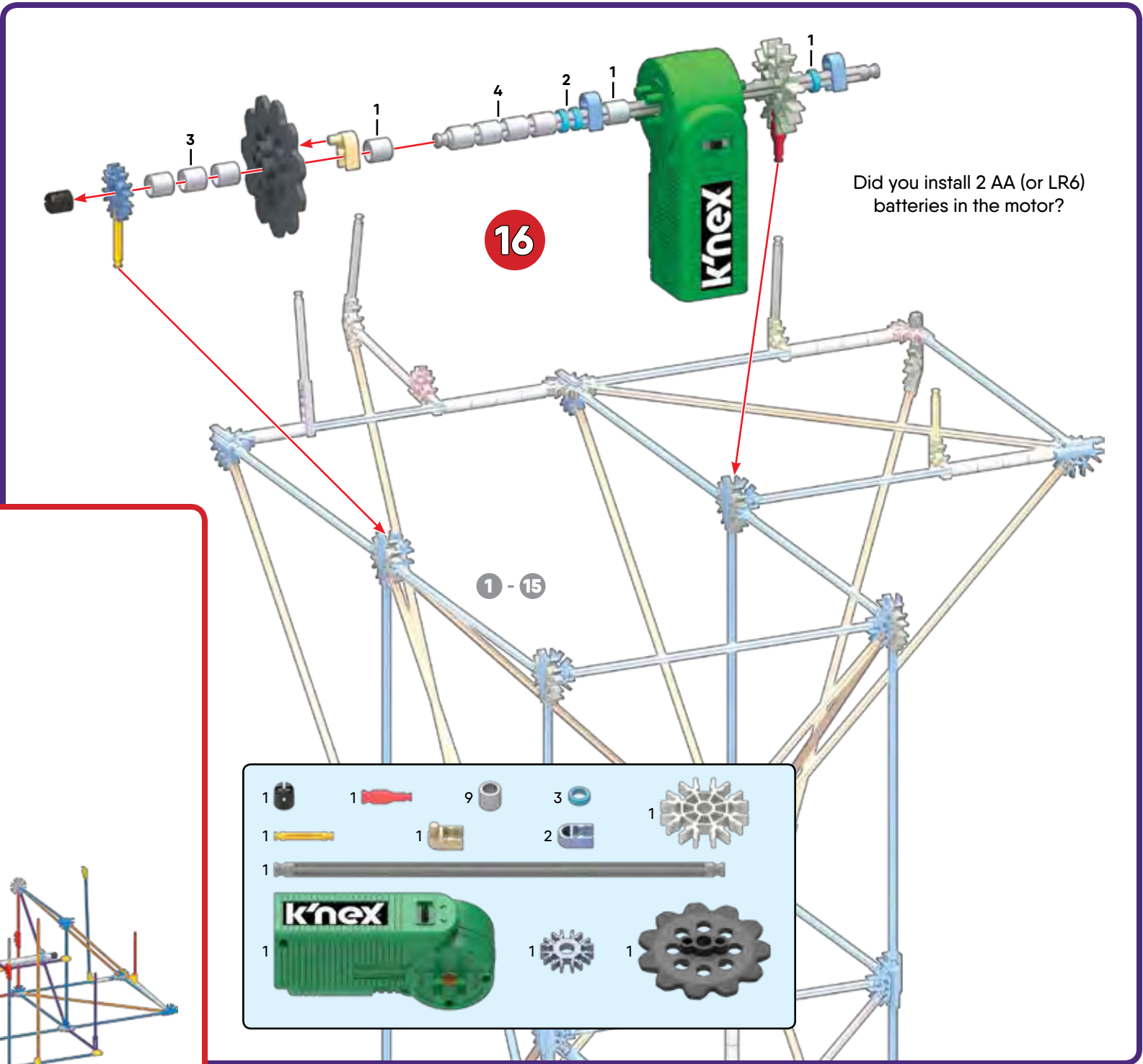

Did you install 2 AA (or LR6) batteries in the motor?

16

1 - 15



1 - 16

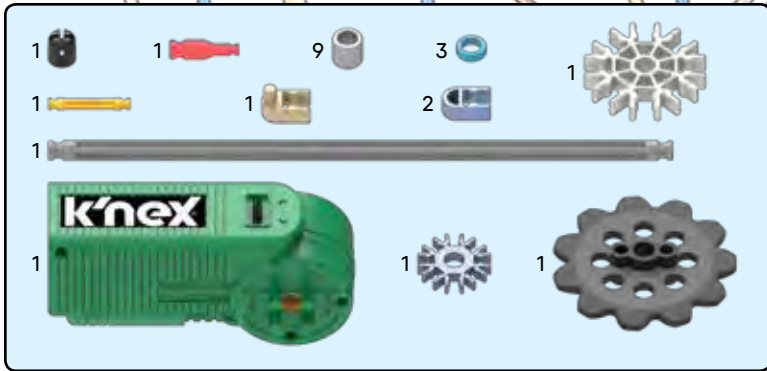

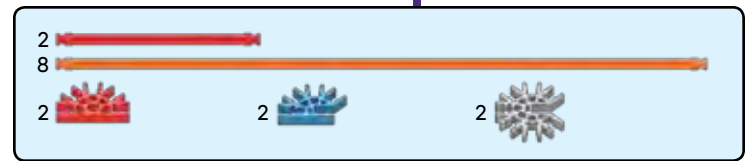
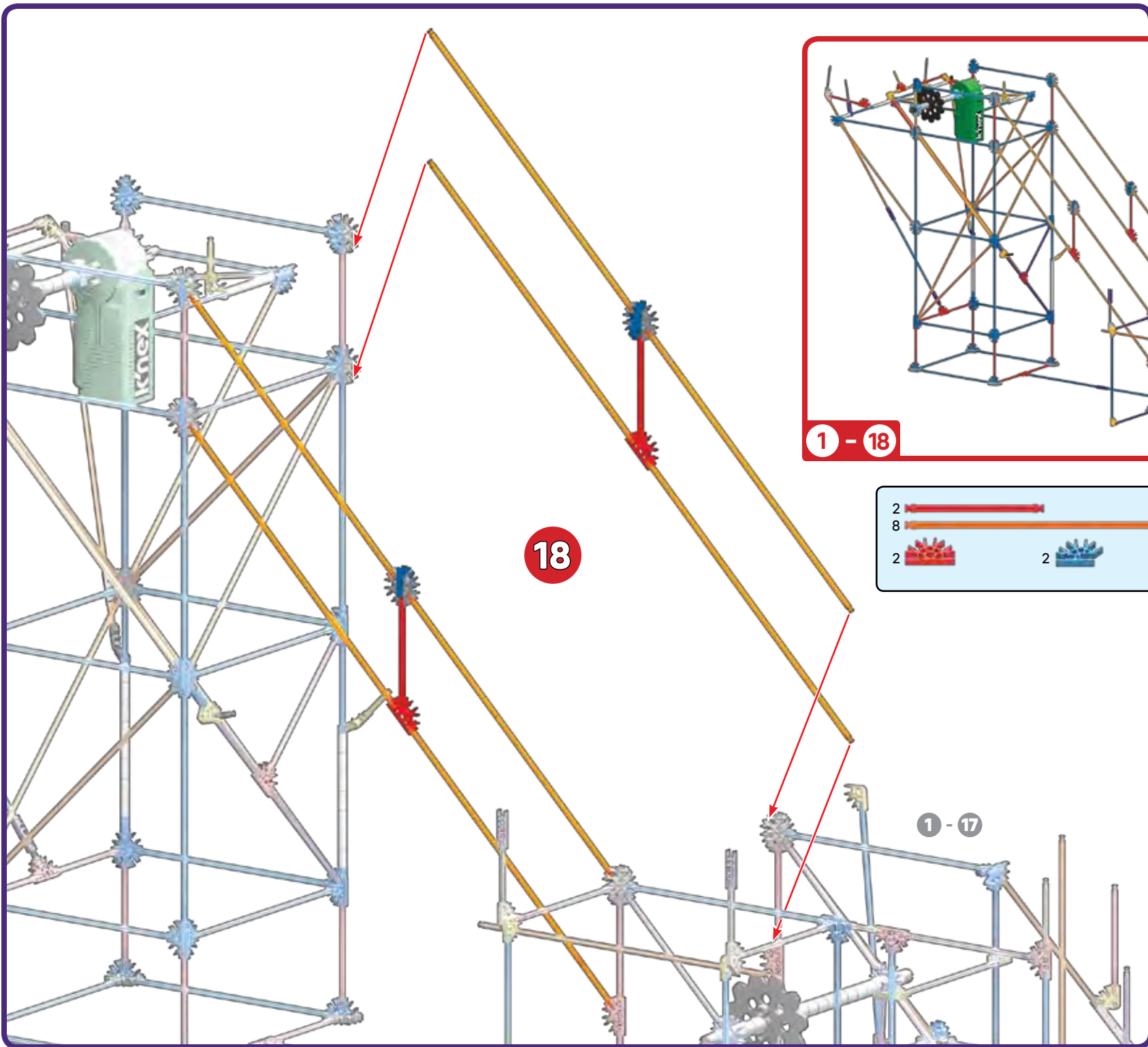

1 - 17

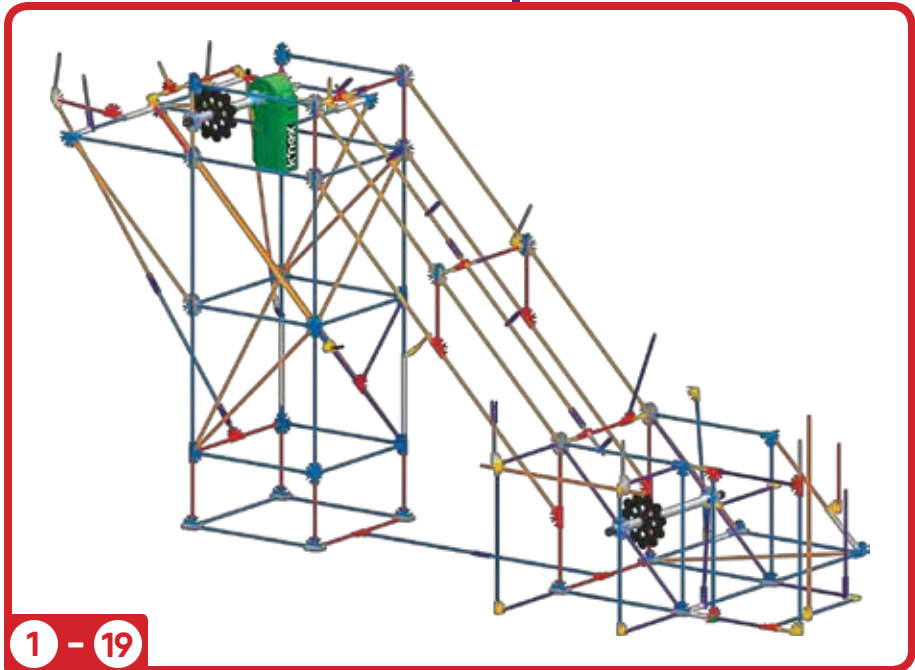
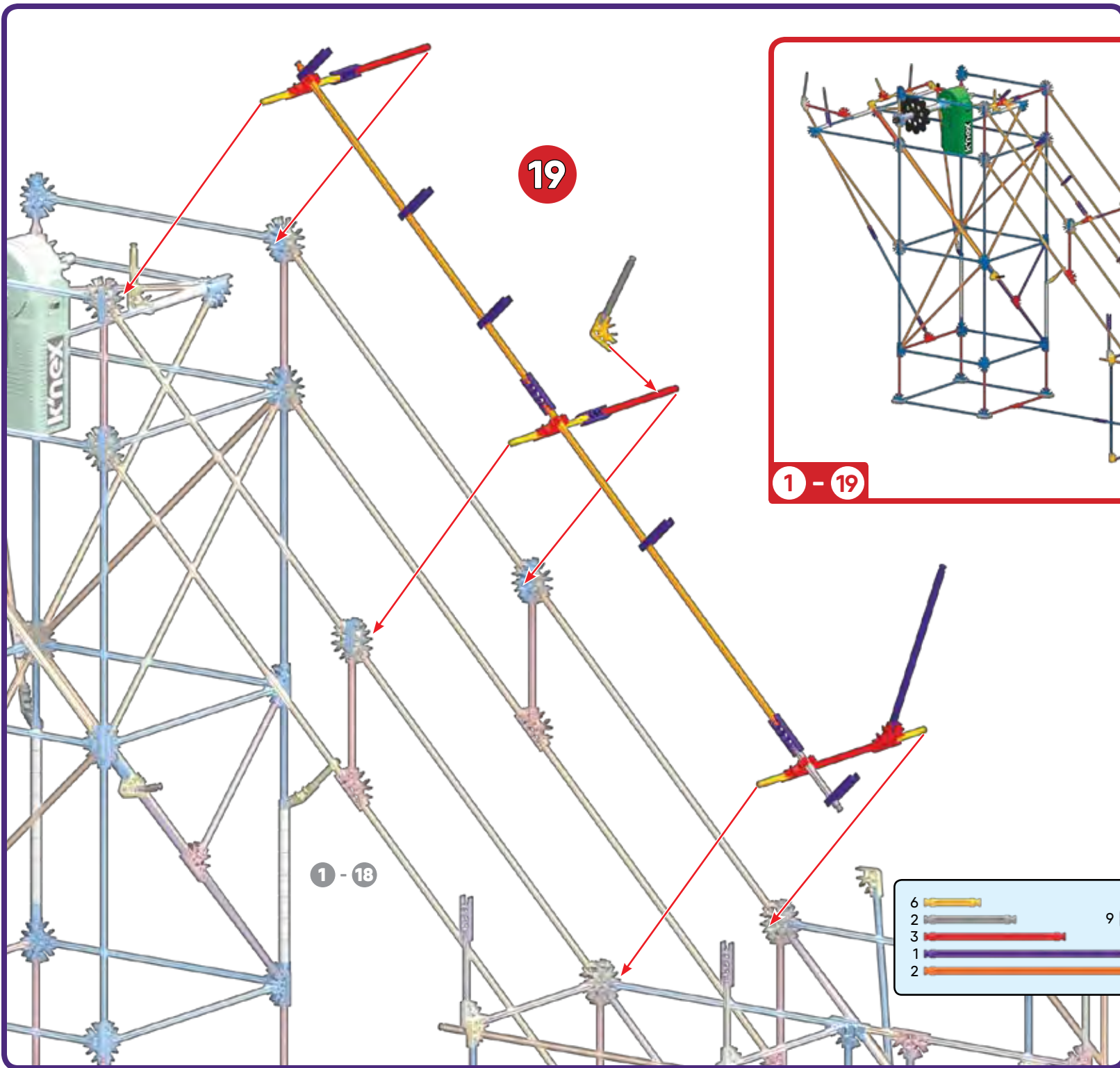

- | | | | | | | | |
|---|--|---|--|---|--|---|--|
| 6 | | 9 | | 1 | | 4 | |
| 2 | | | | | | | |
| 3 | | | | | | | |
| 1 | | | | | | | |
| 2 | | | | | | | |

Attach the black chain guides and the connectors to the track exactly as shown.

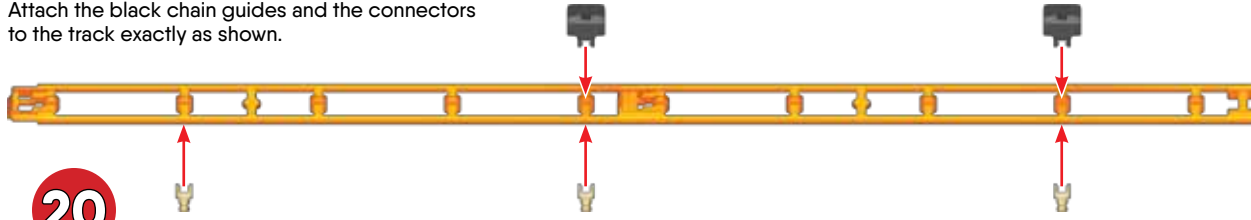

20

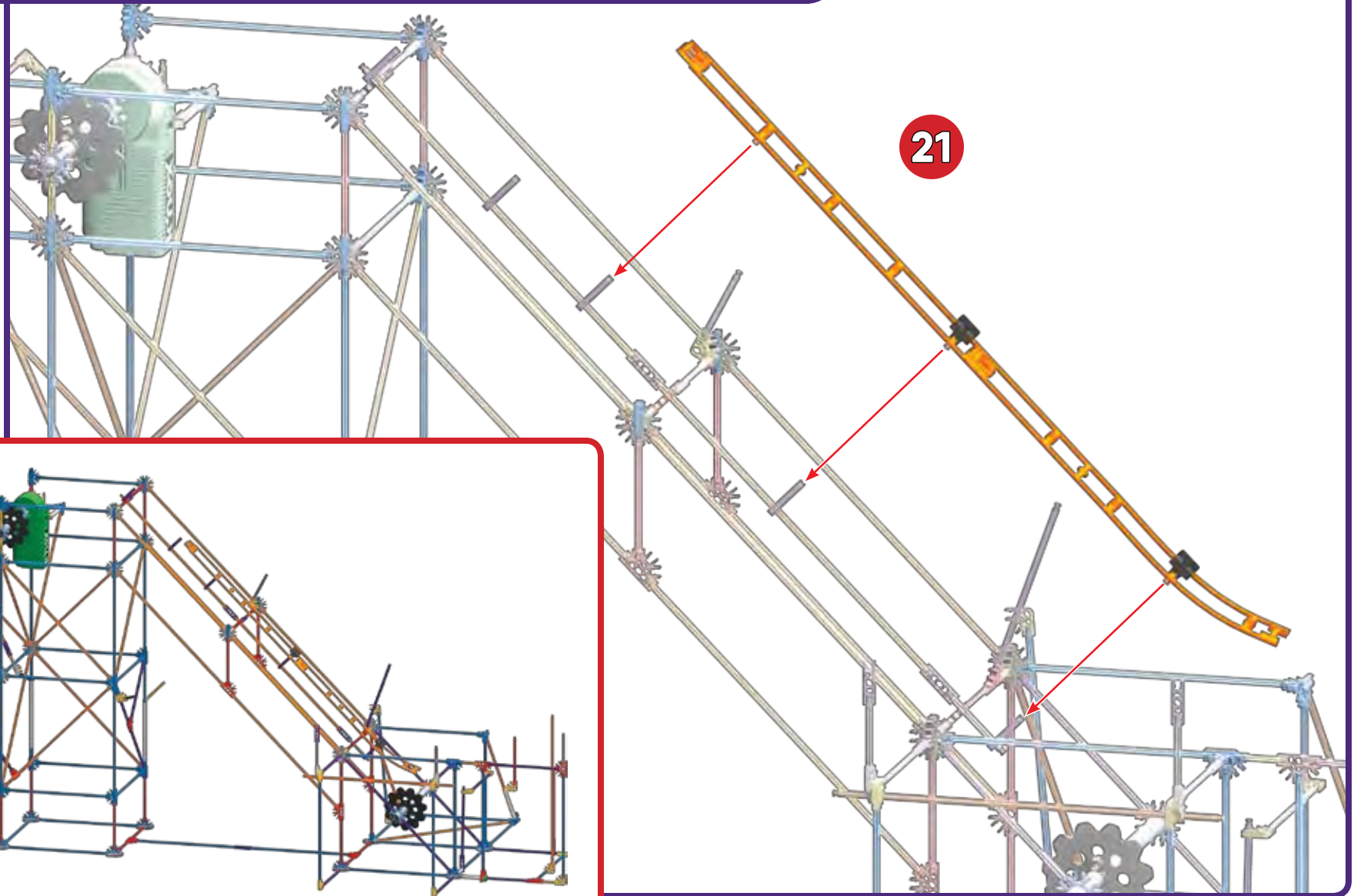

21

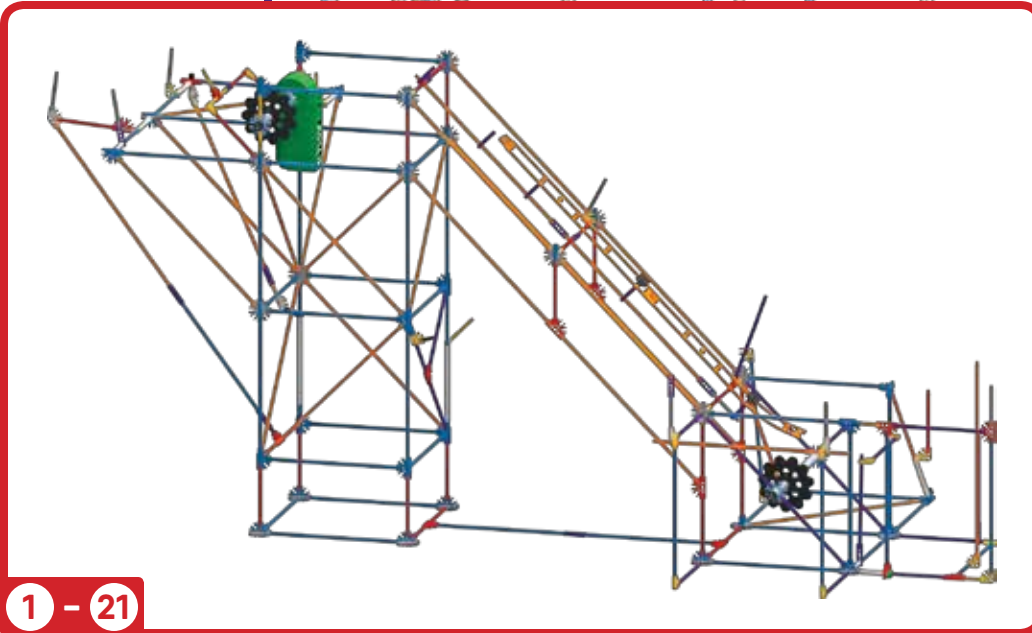

1 - 21

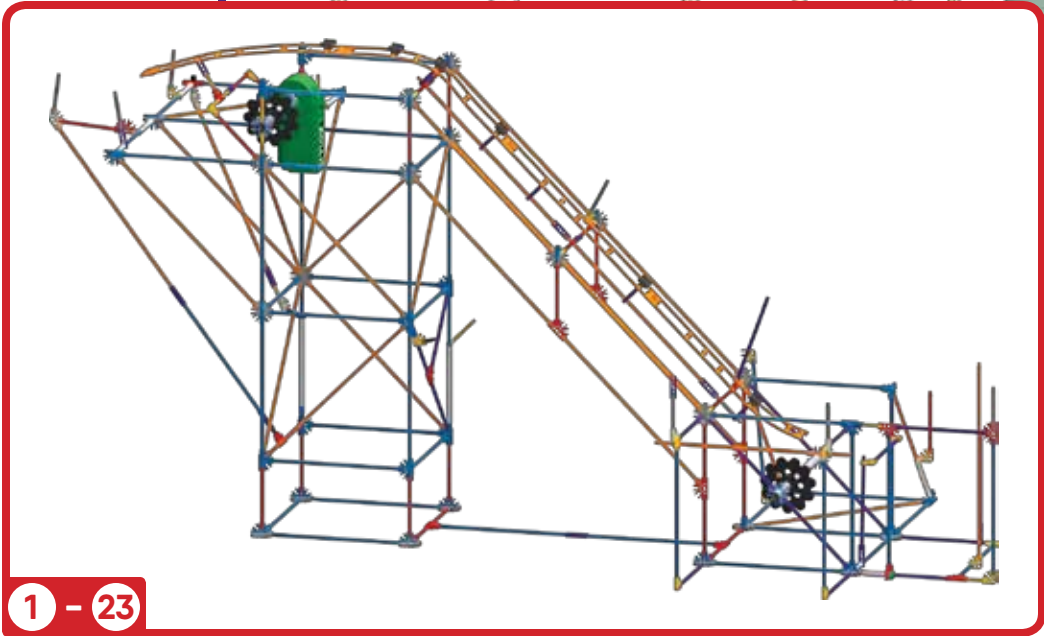
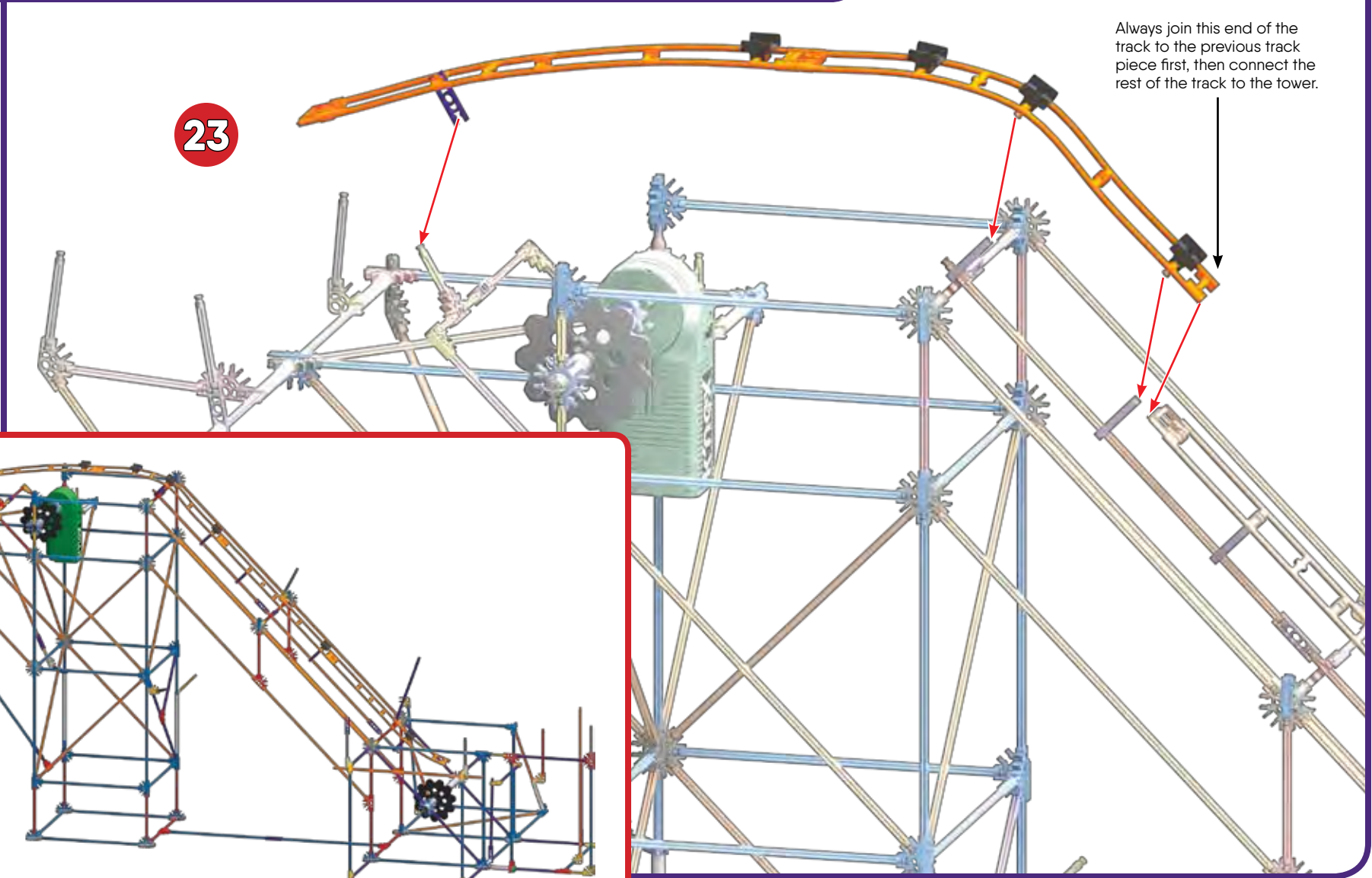
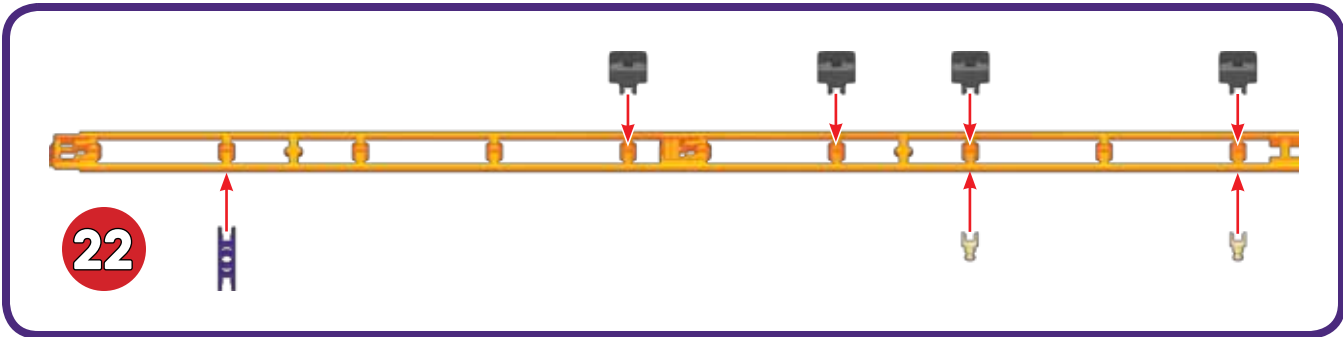

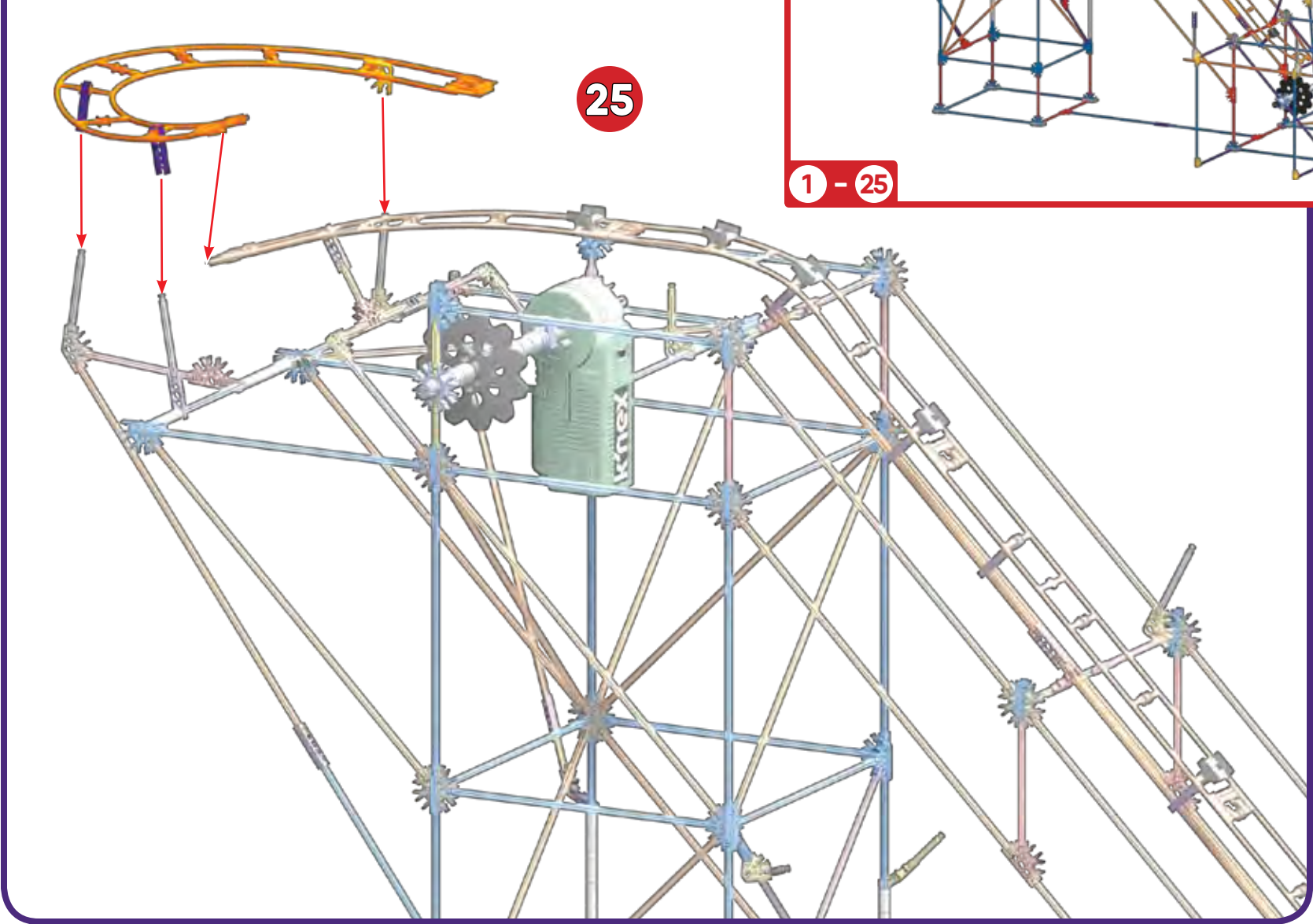
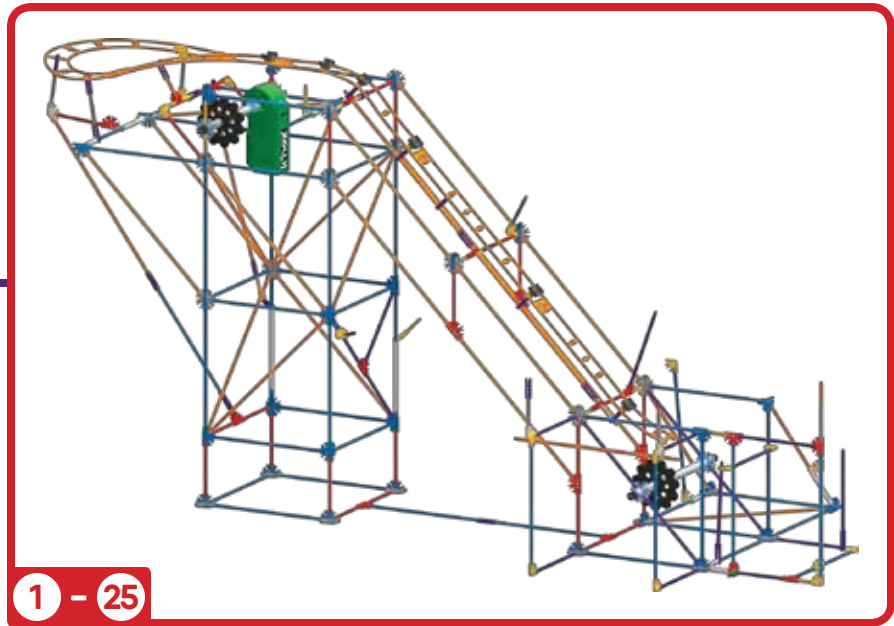
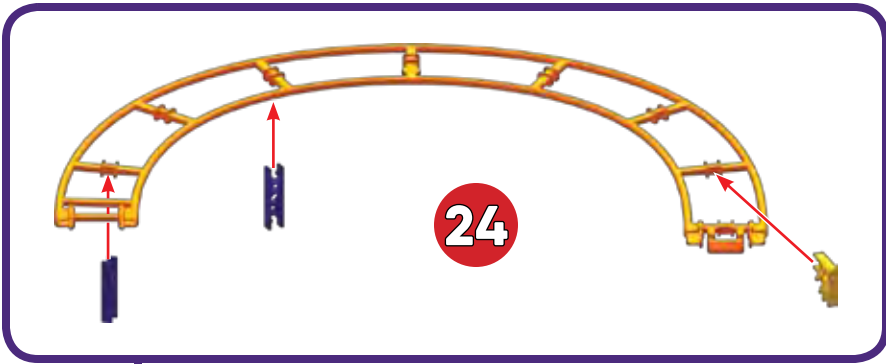

26



27

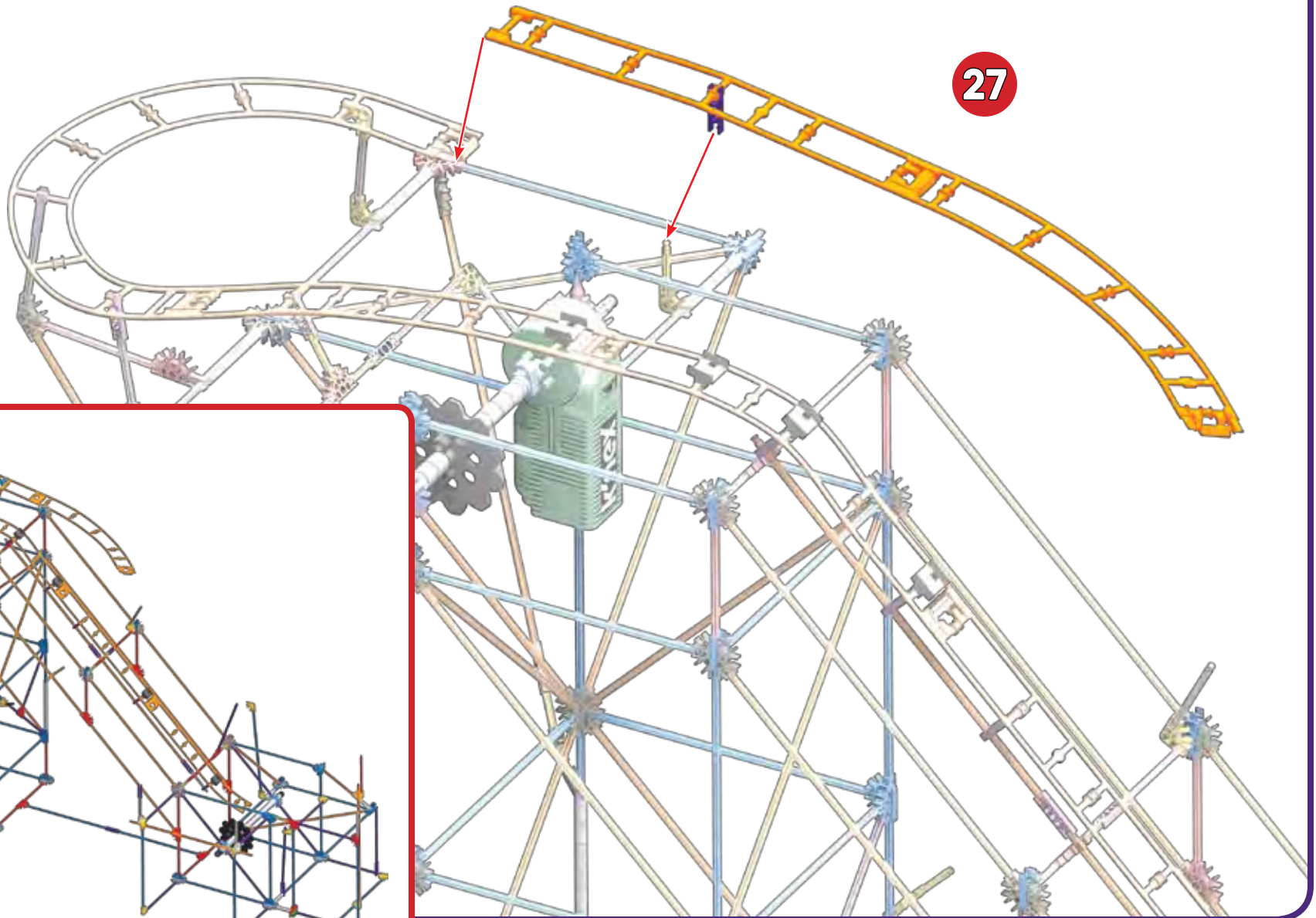

1 - 27

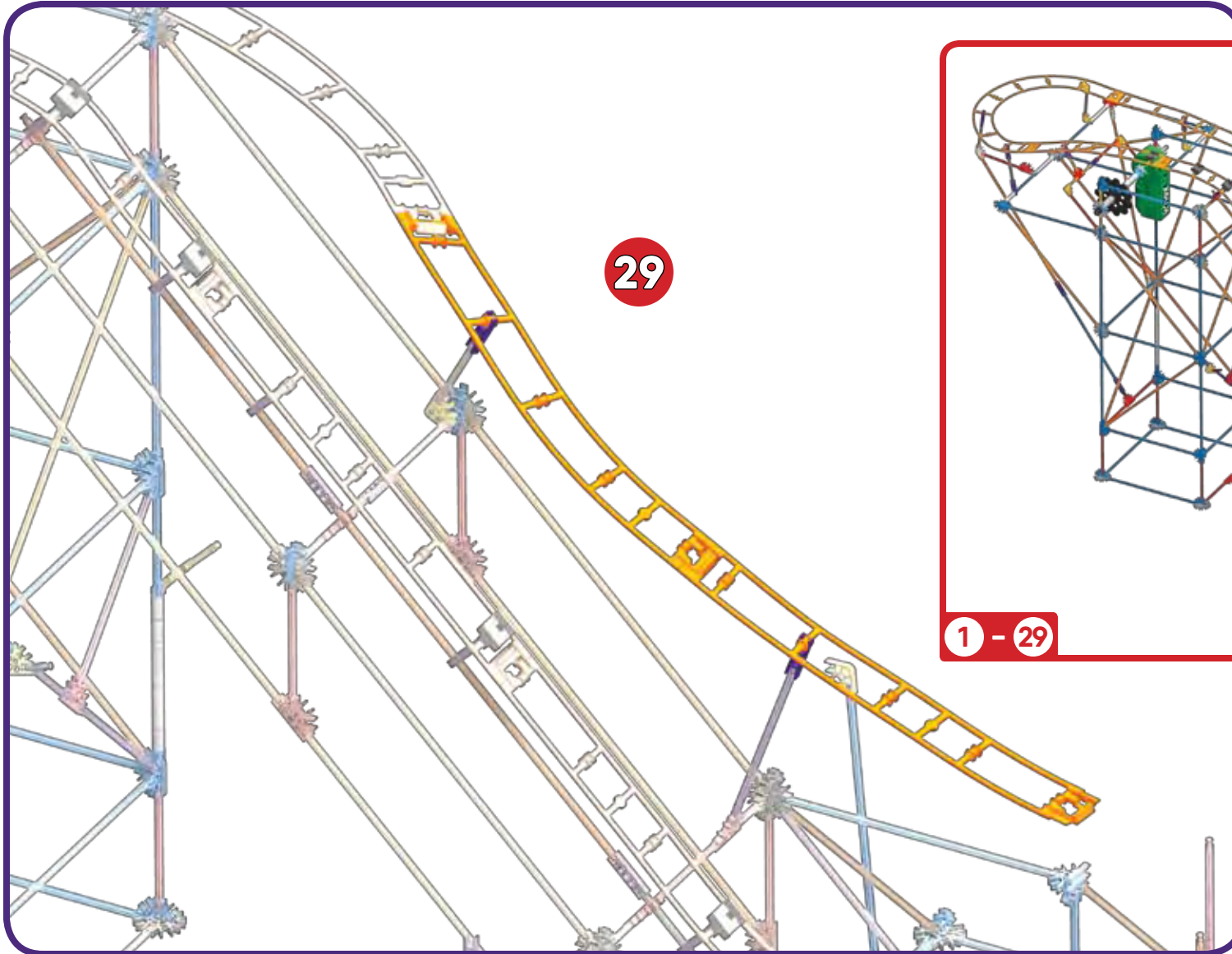
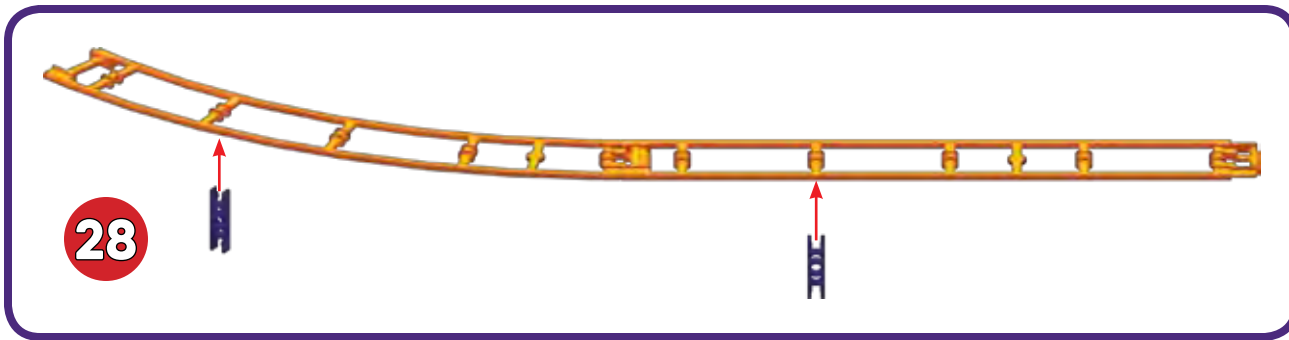

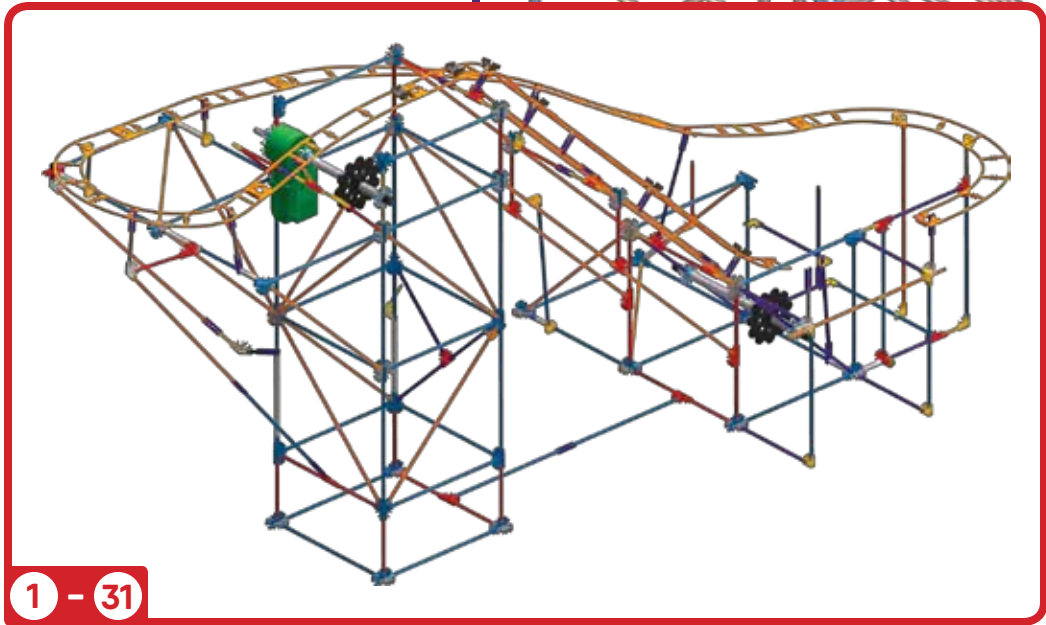
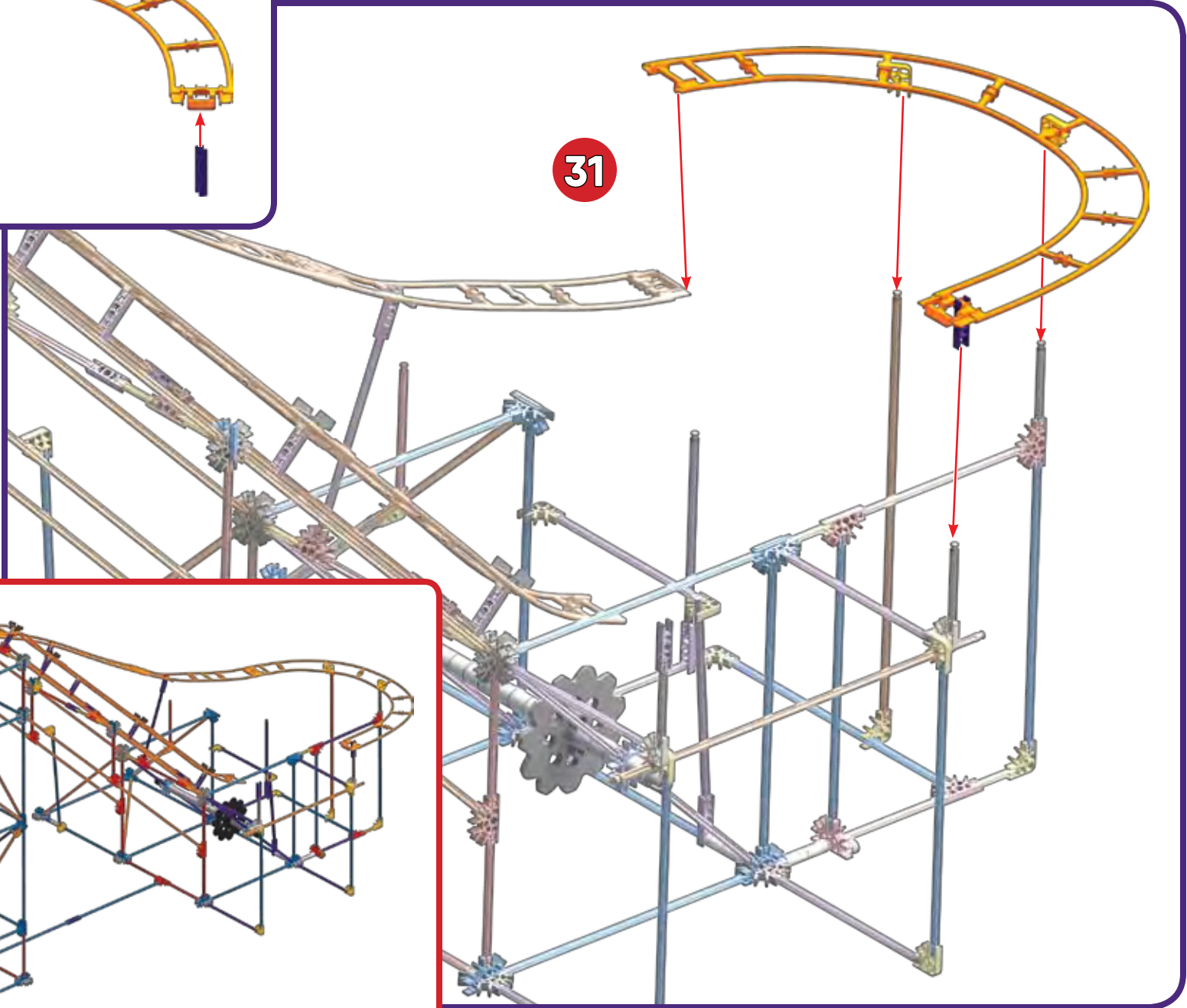
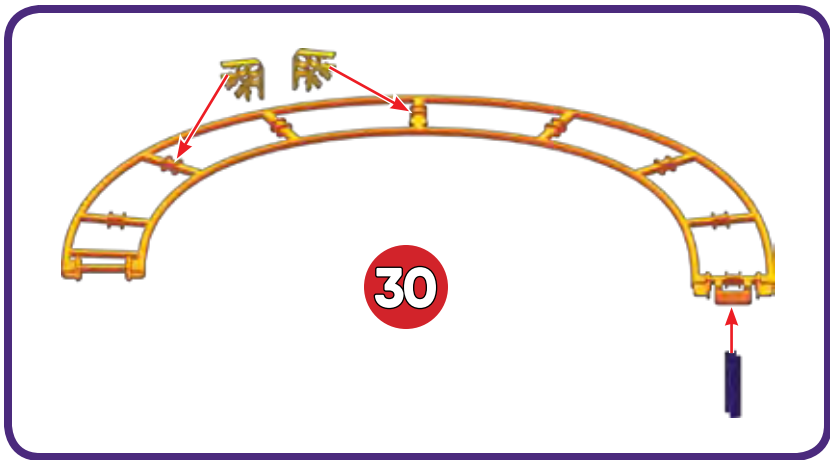

1 - 31



32

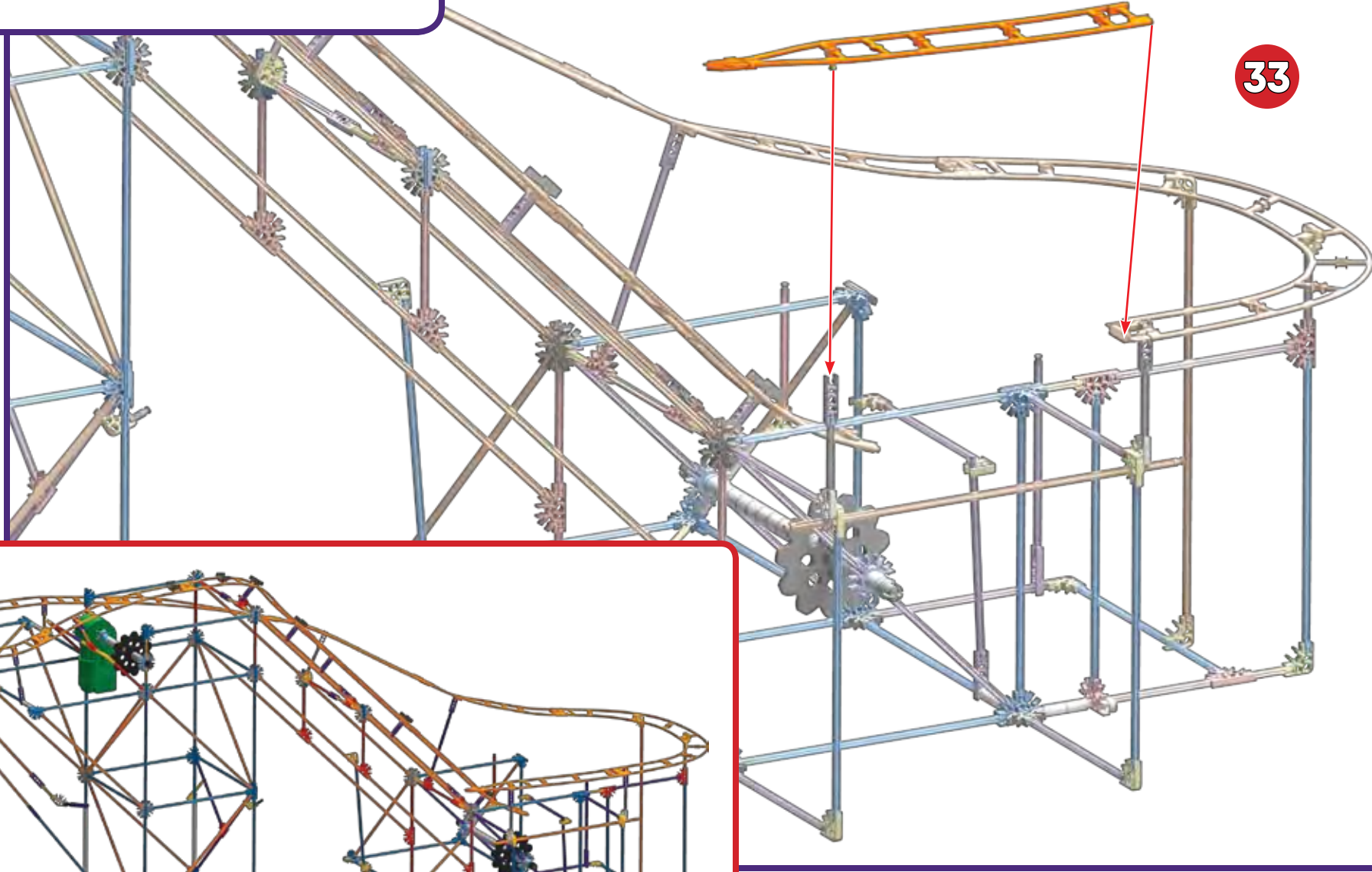

33

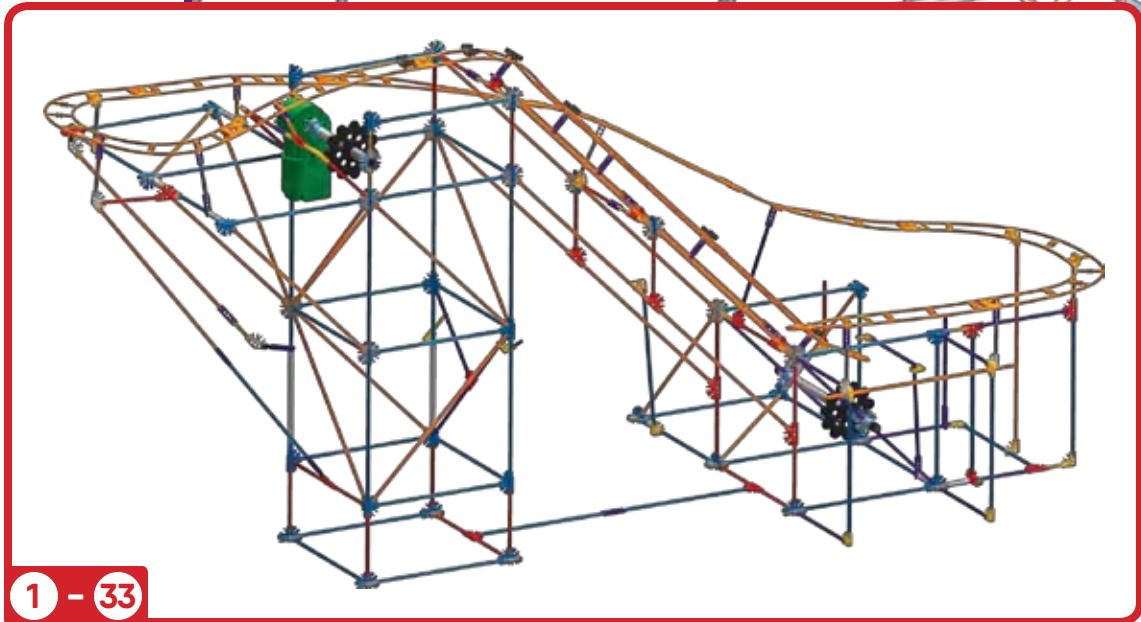

1 - 33

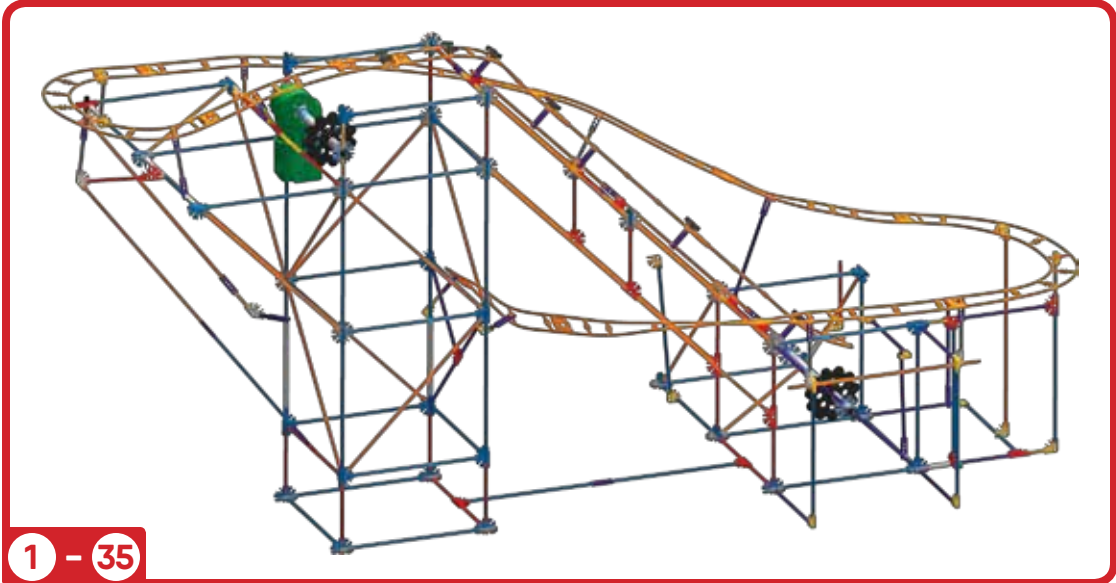
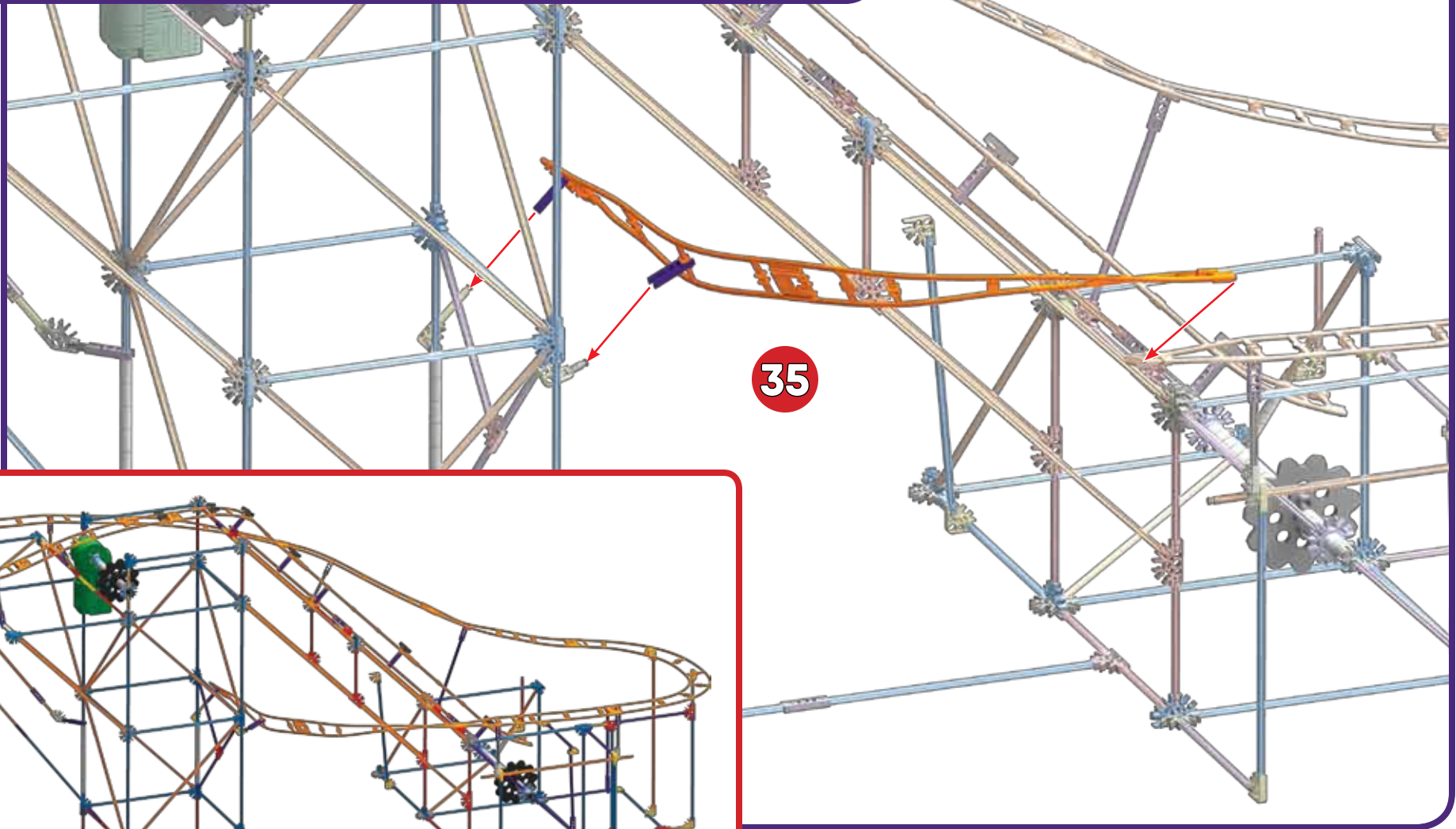
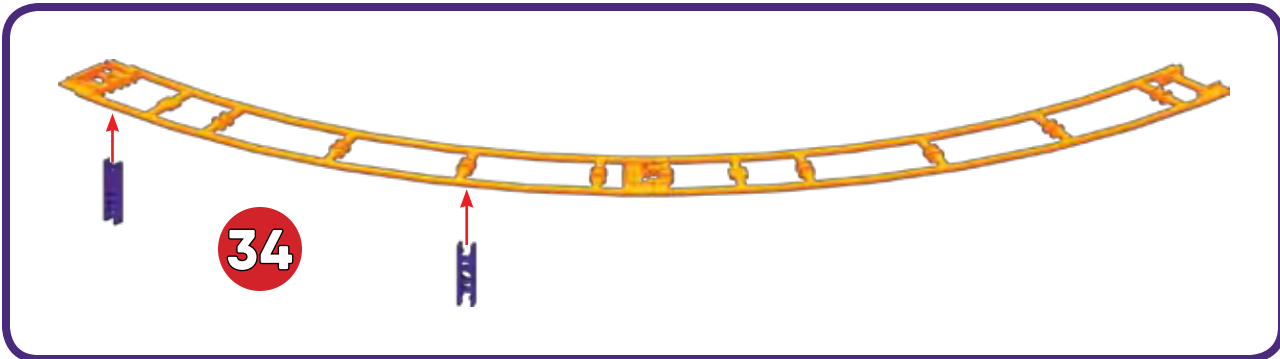

36



37

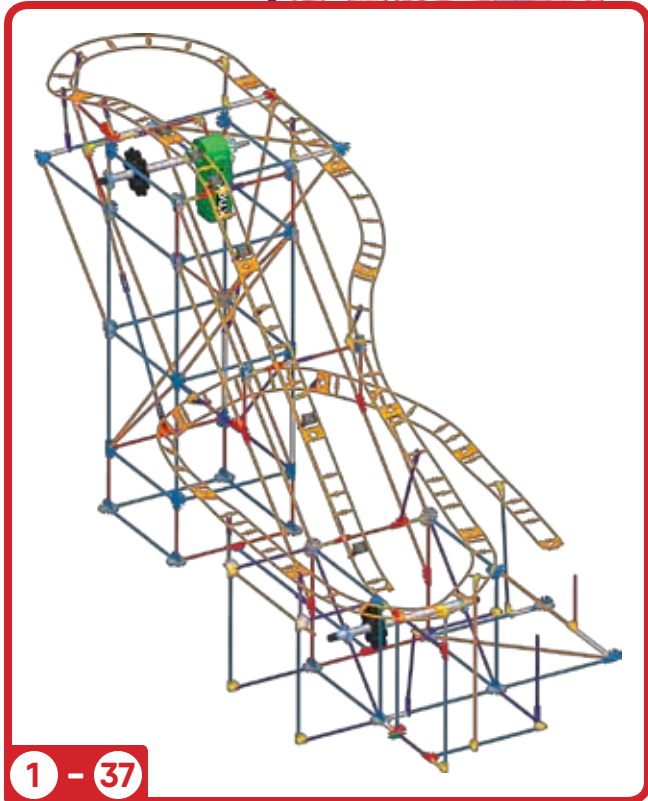
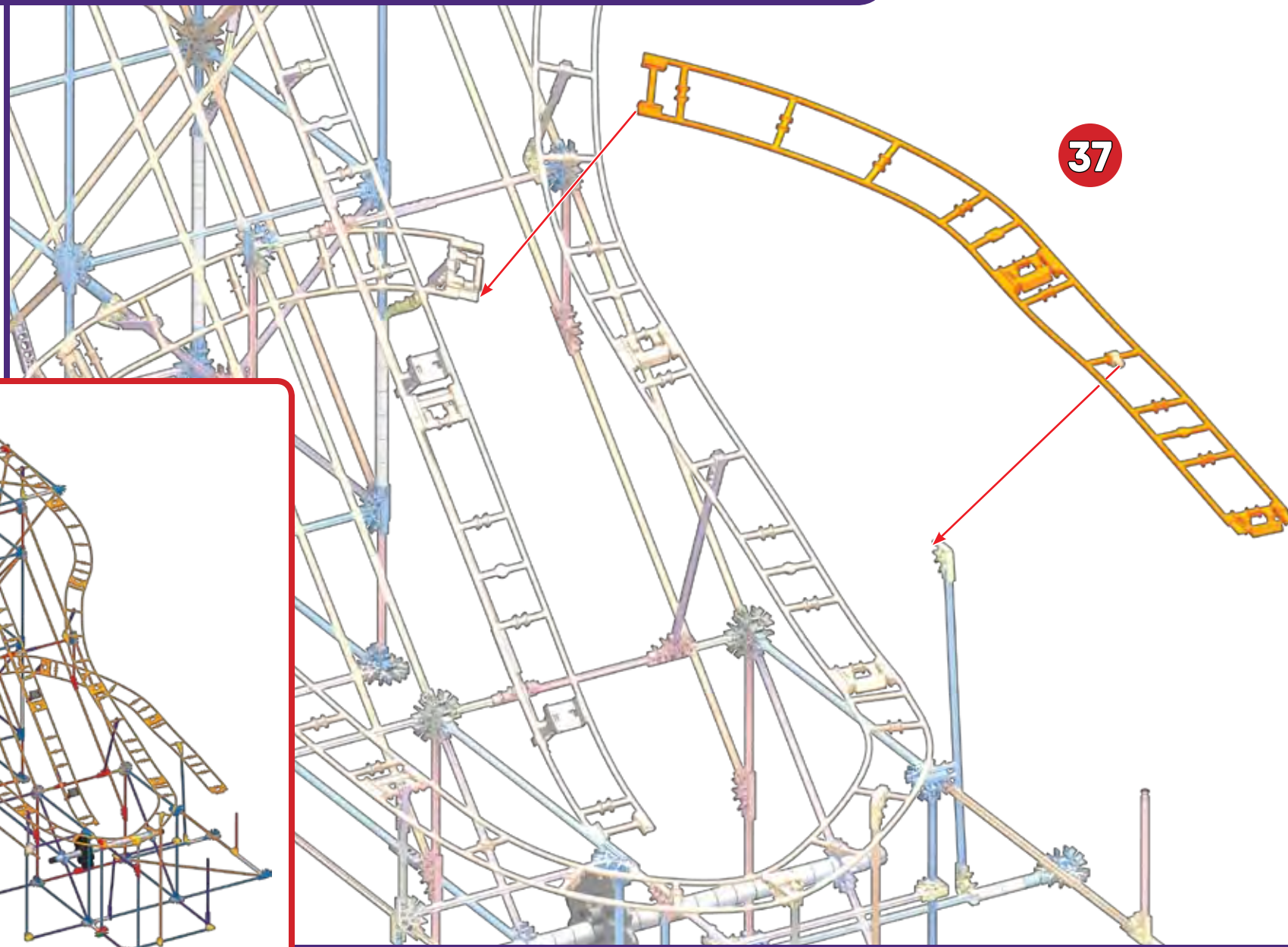

1 - 37

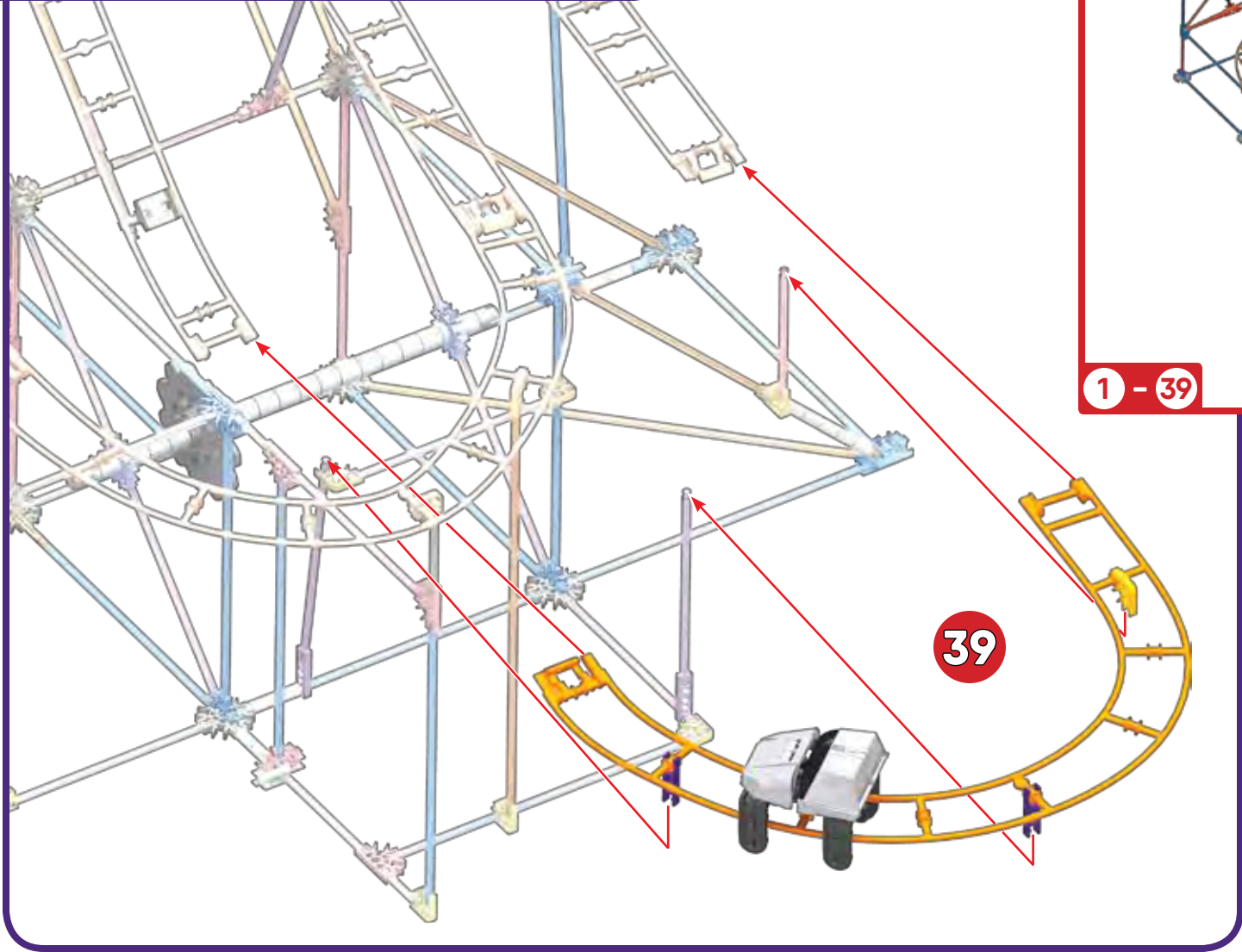
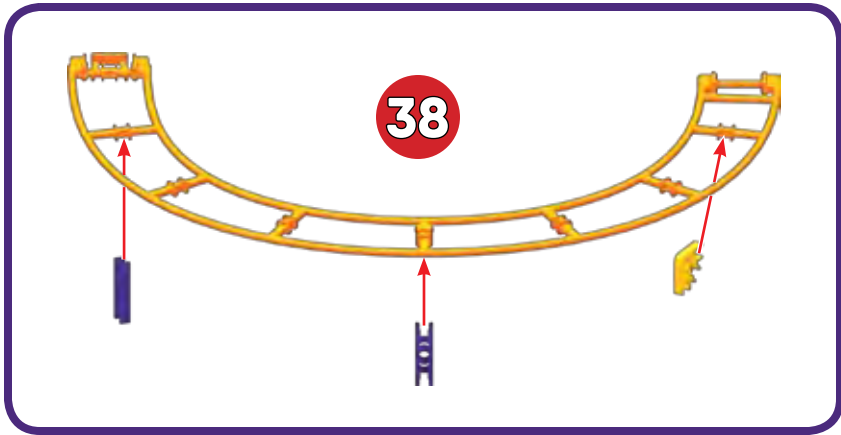



IMPORTANT: Attach all the chain links in the same direction.

40



x9



x1

41



x10



x10

42

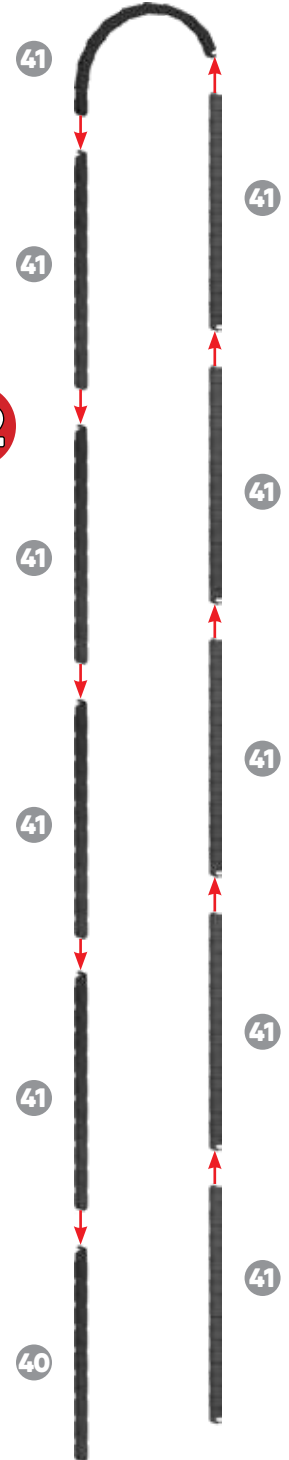

k'nex **PANTHER
ATTACK**
Additional Build

1 - 43

43

