

K'NEX

Building Worlds Kids Love®

SUPER MARIO 3D LAND

FLYING CLOUD™
BUILDING SET
VOLANT NUAGE™
JEU DE CONSTRUCTION



PROPELLER BOX™



ITEM BOX™



TAIL GOOMBA™

LIMITED EDITION!
EDITION LIMITÉE !



8+

38528

Jouet de Construction
d'AMÉRIQUE™

AMERICA'S
Building Toy™



1

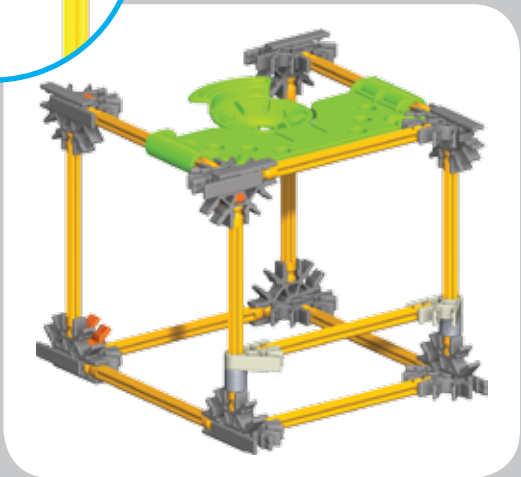
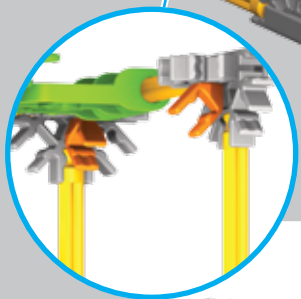
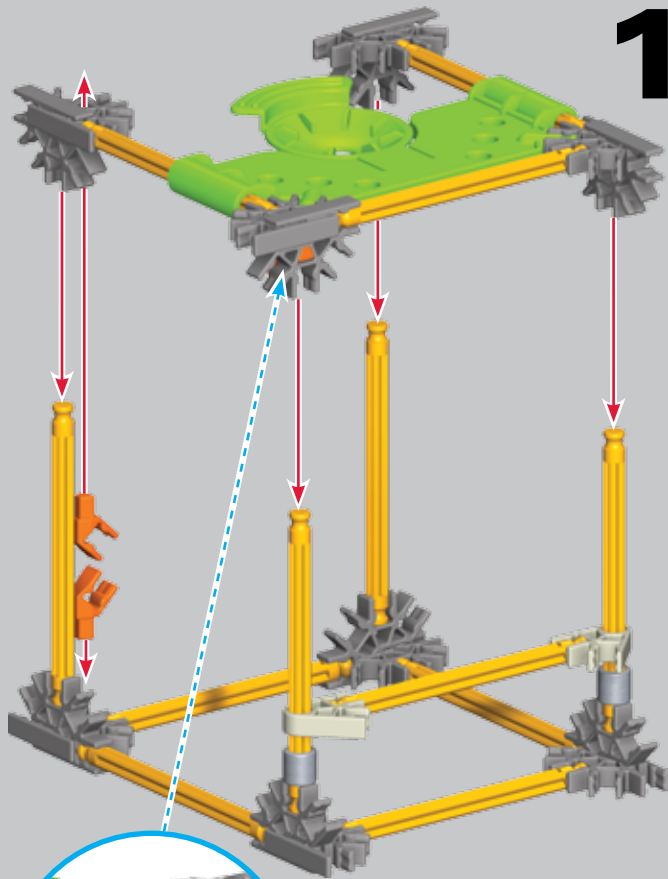

2

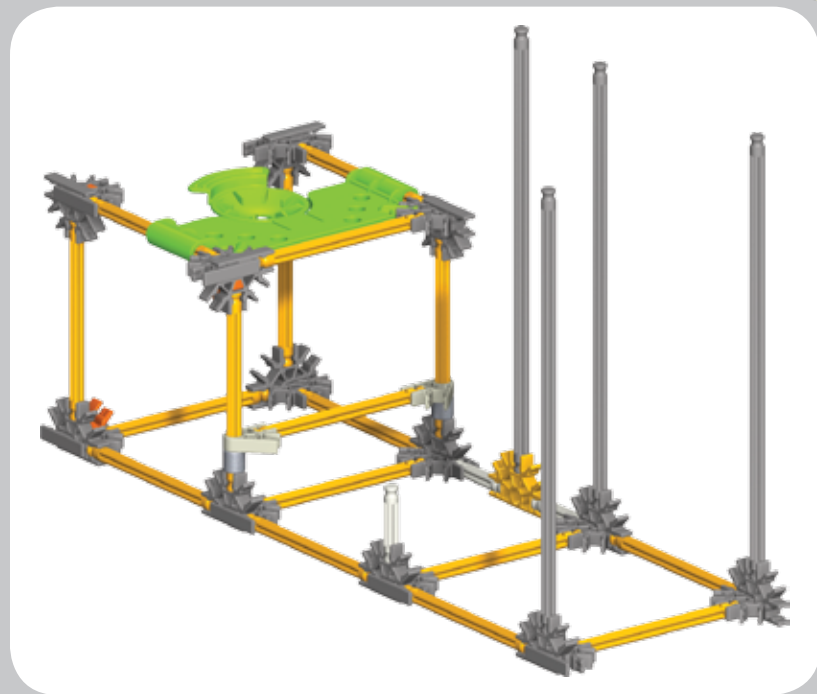
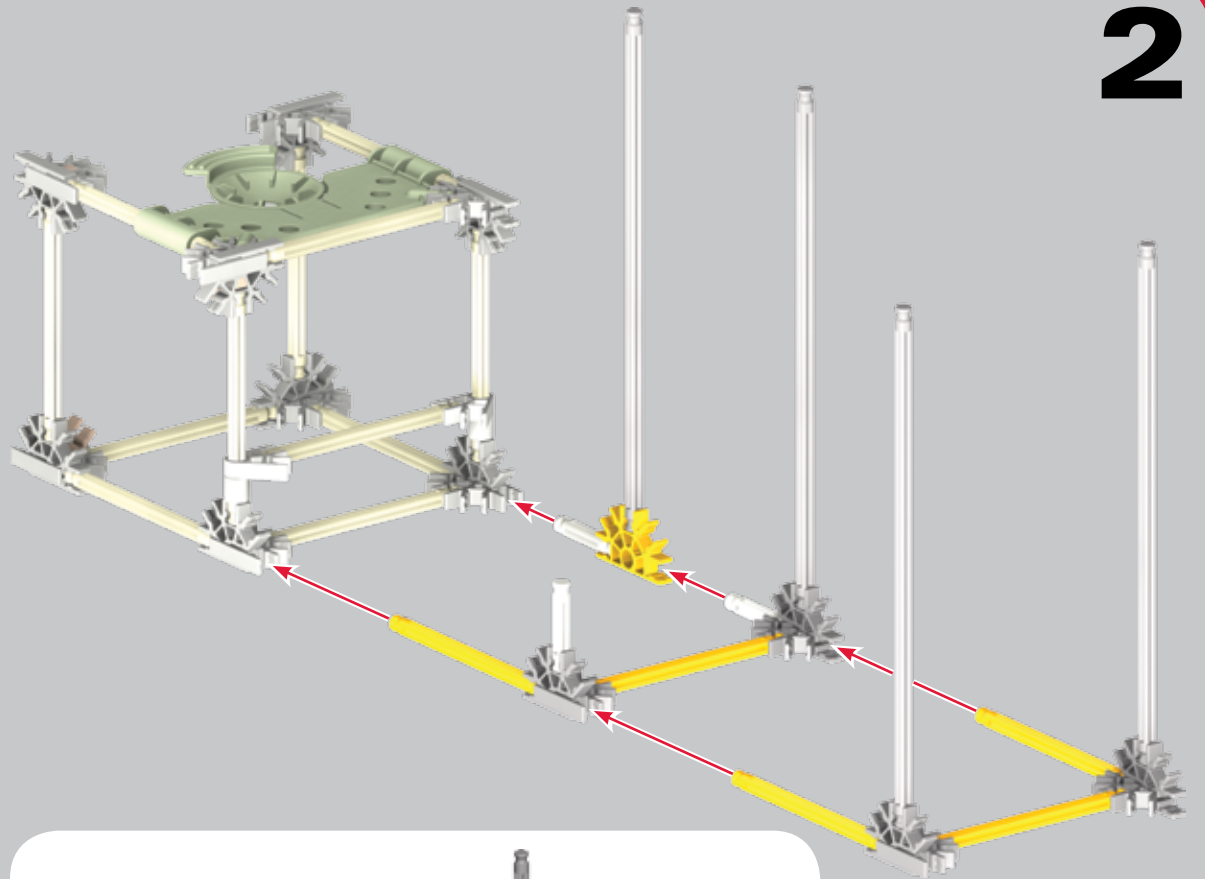

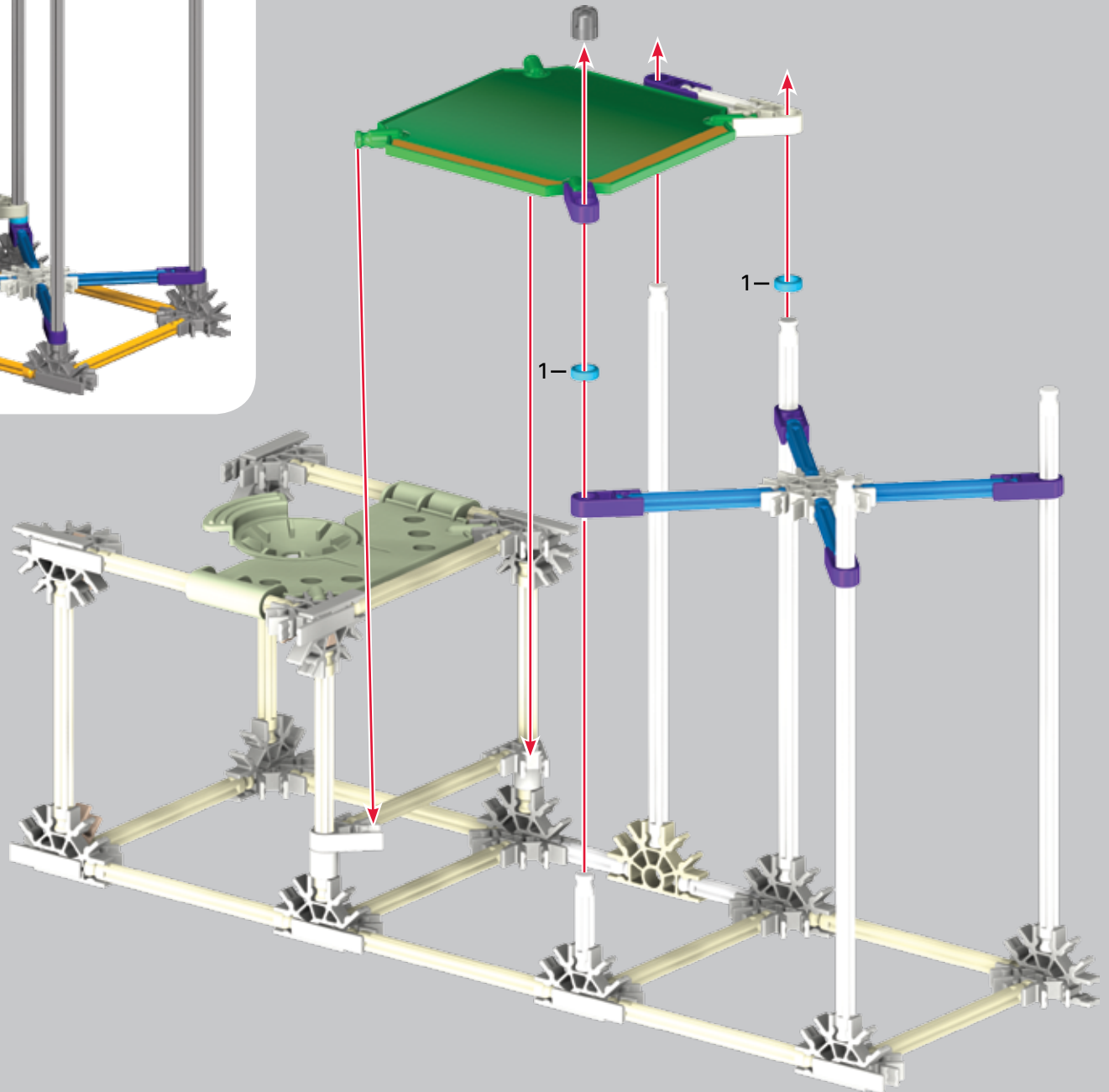
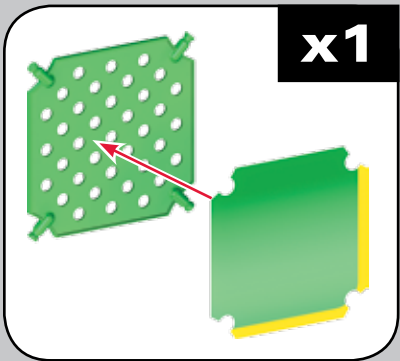
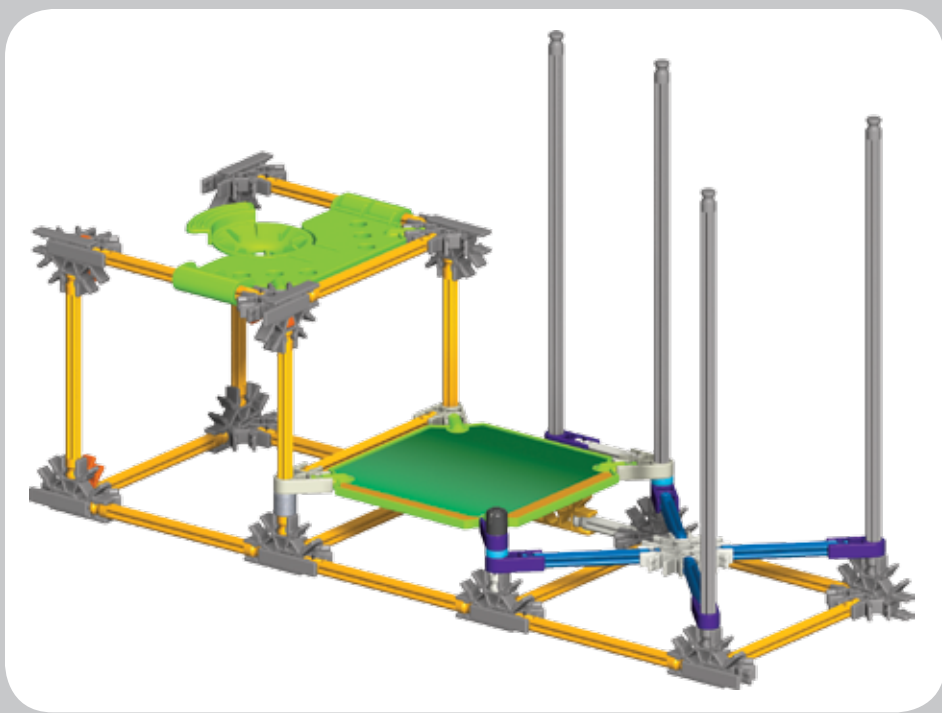

- Apply stickers
- Appelez des autocollants
- Aplicar pegatinas
- Anbringen von Aufklebern
- Applicare gli adesivi
- Aplicar adesivos
- Aanbrengen stickers

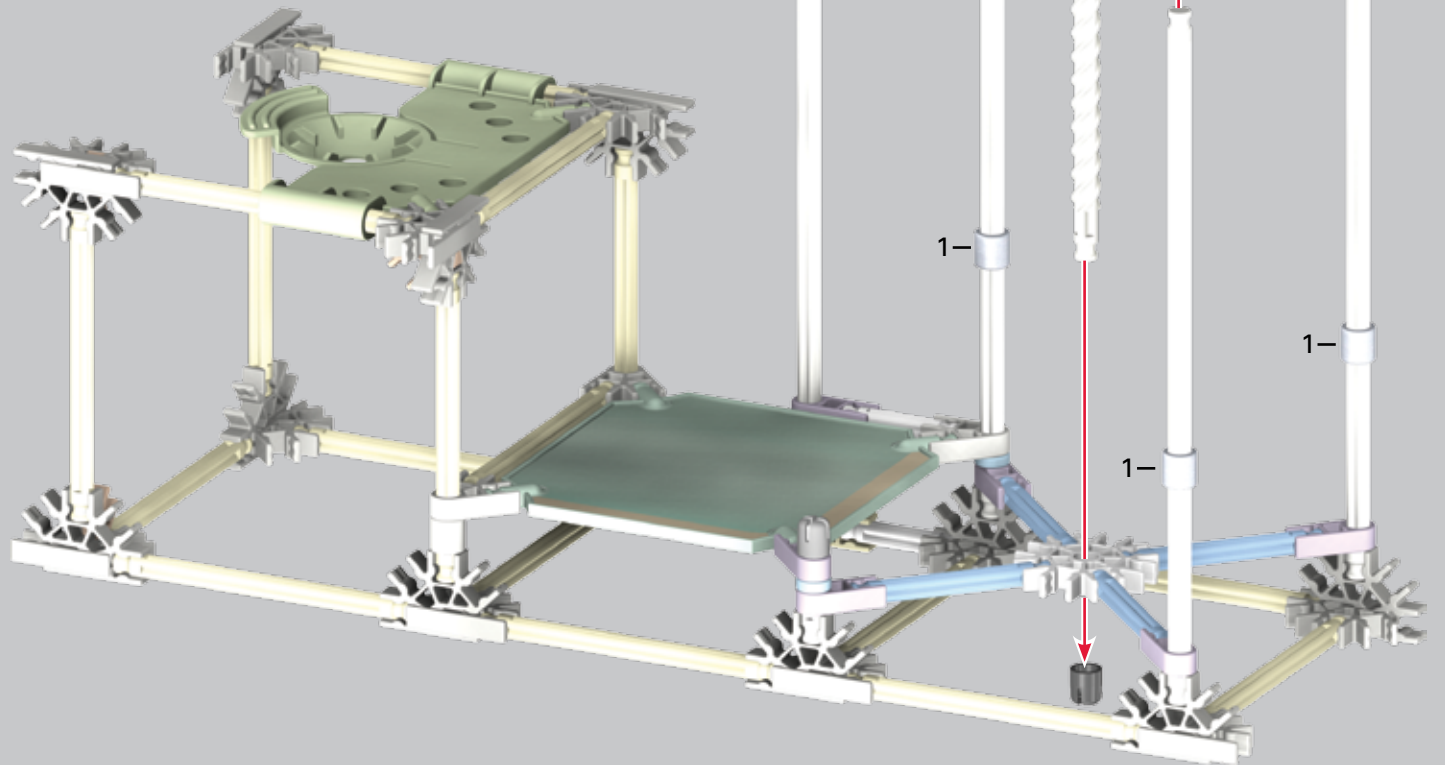
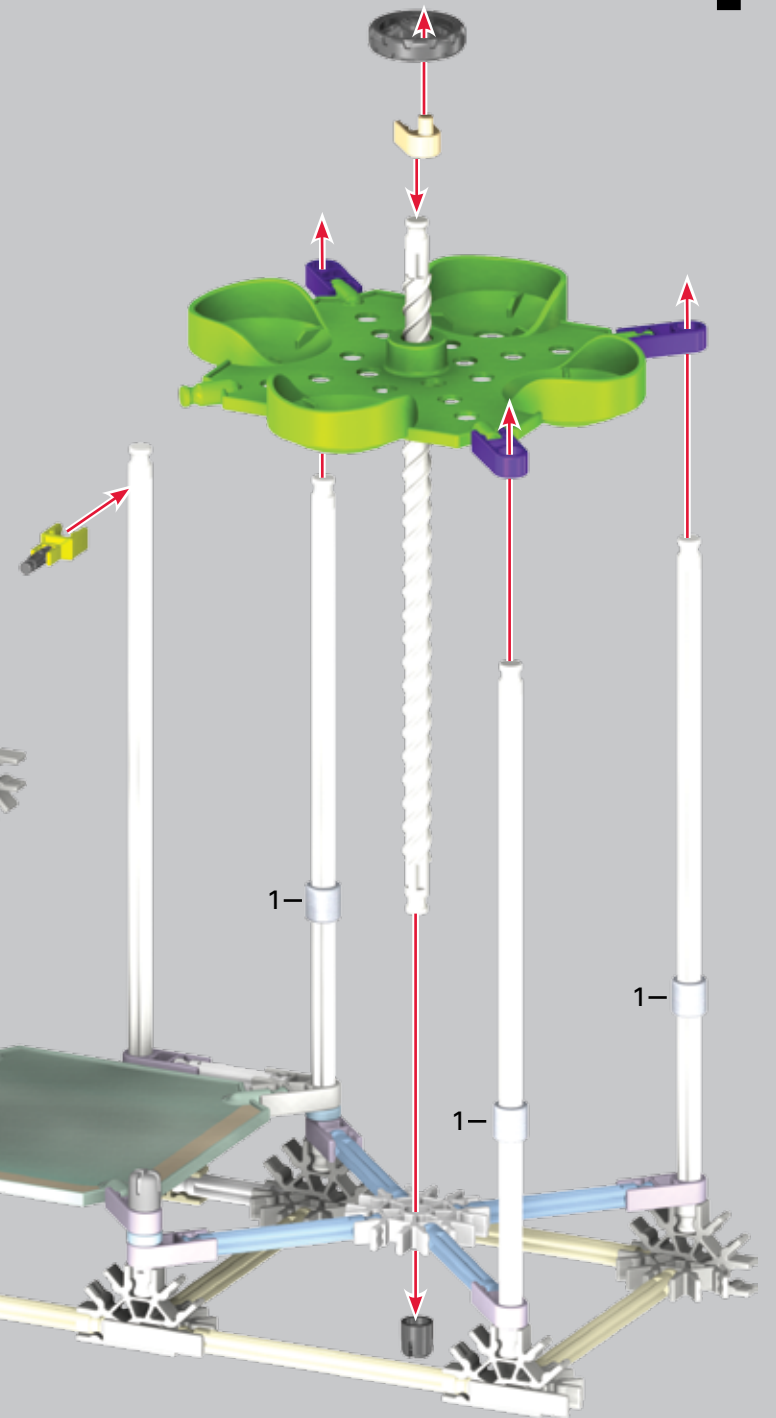
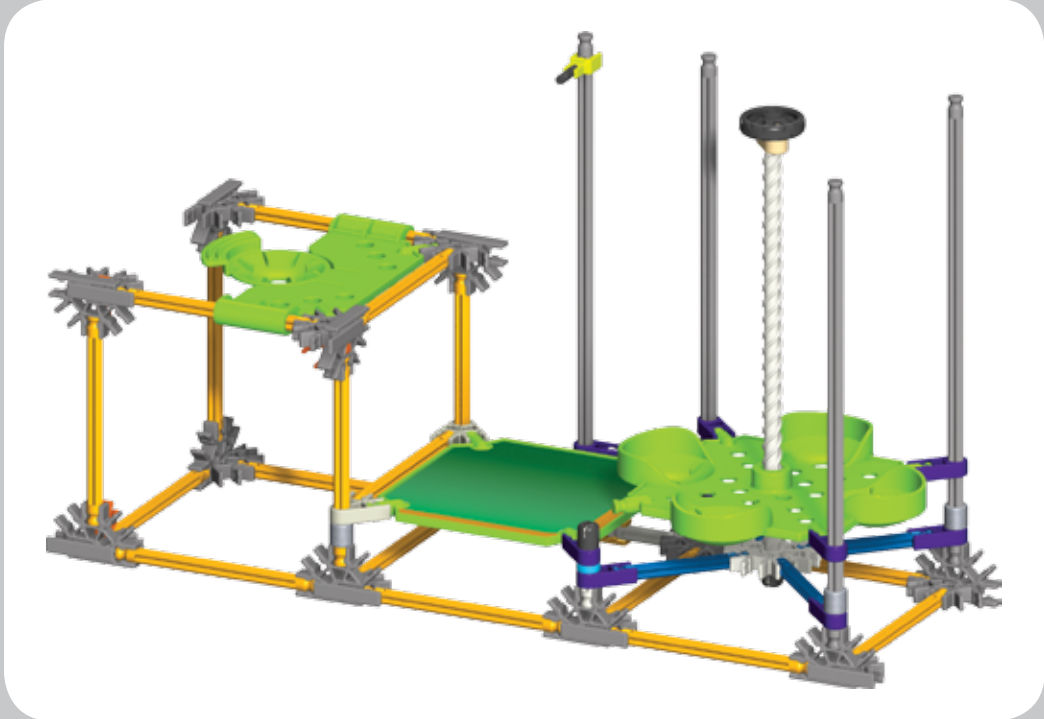

5

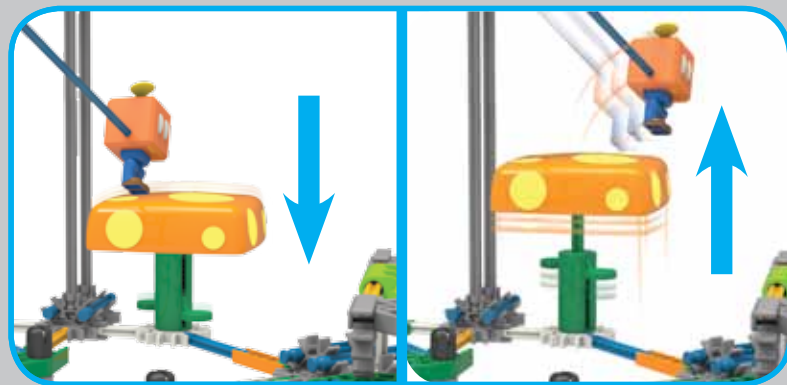
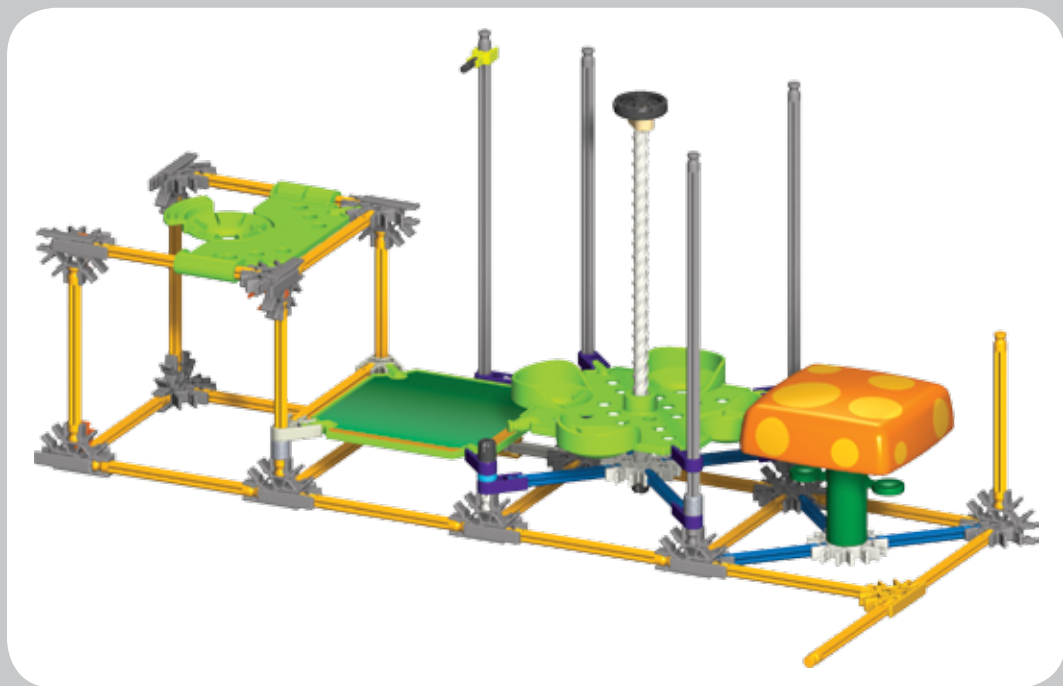
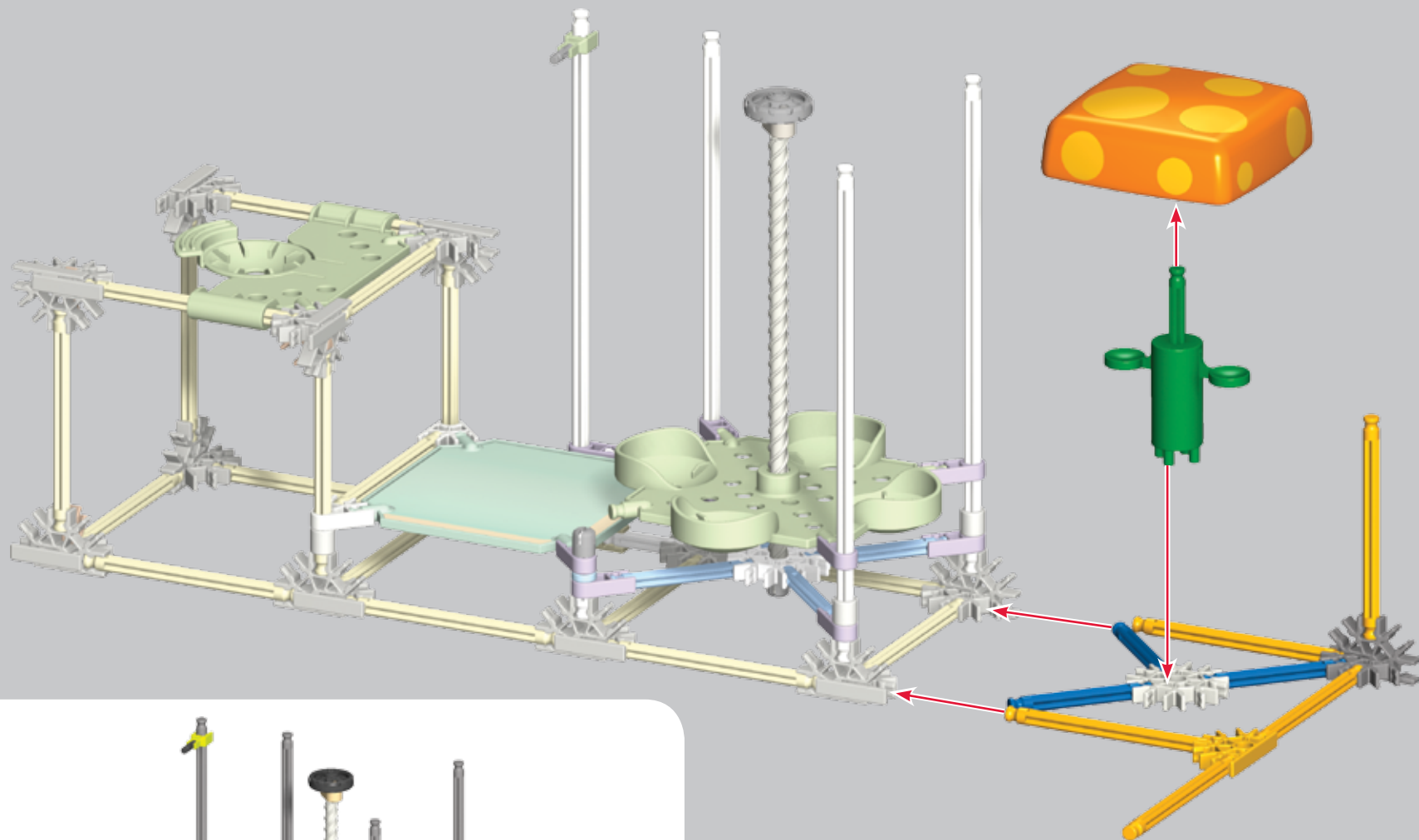

6

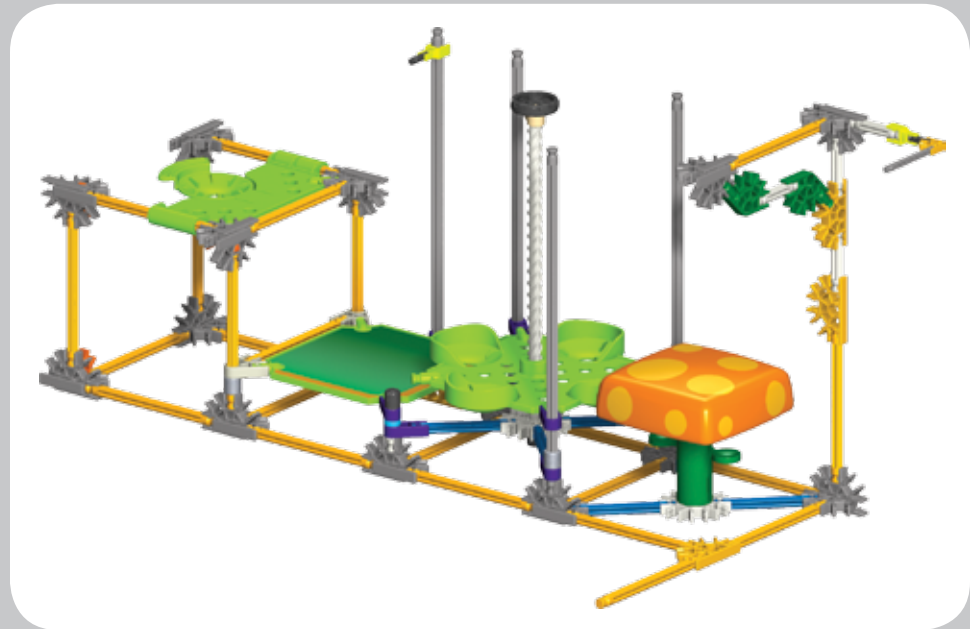
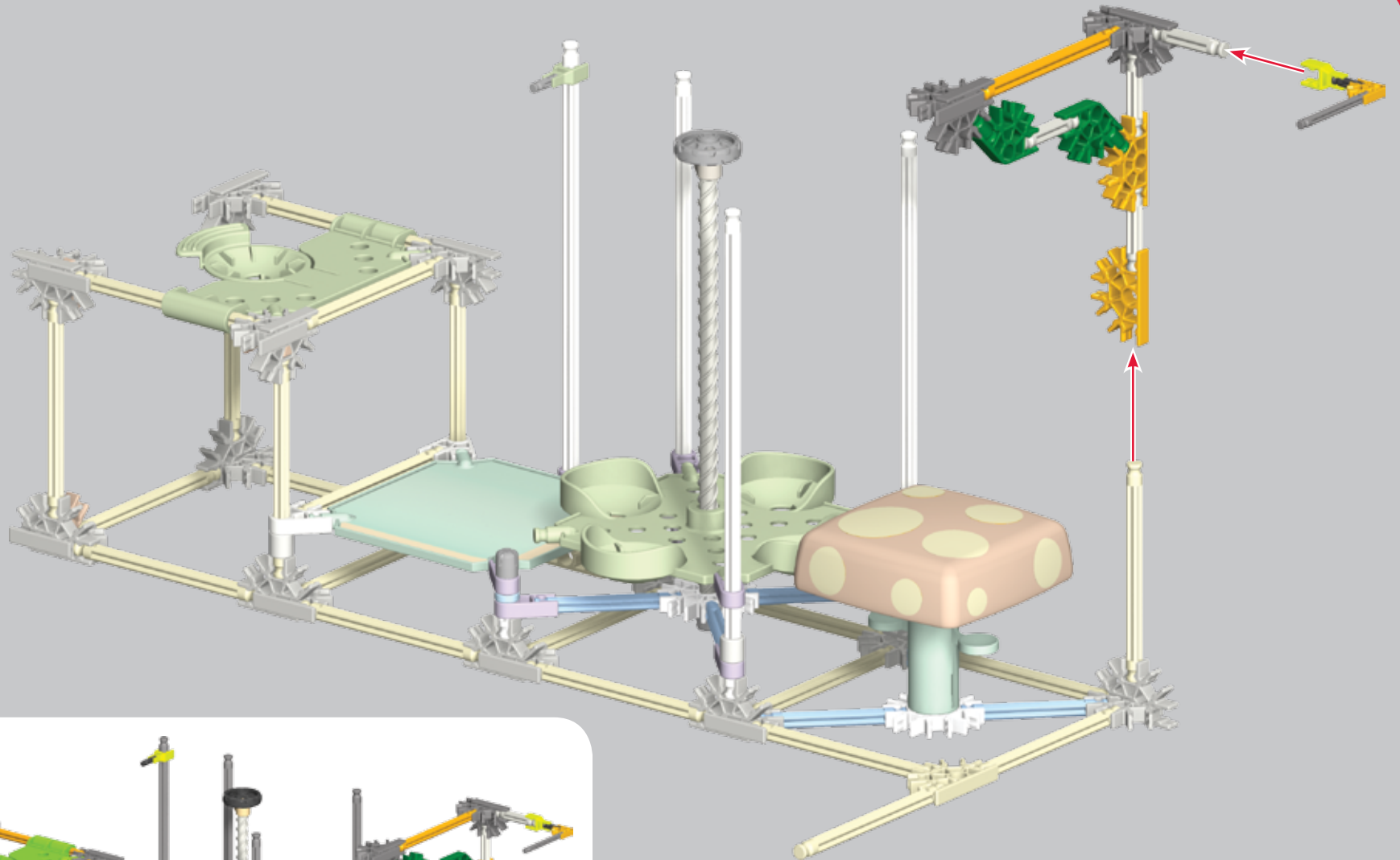

7

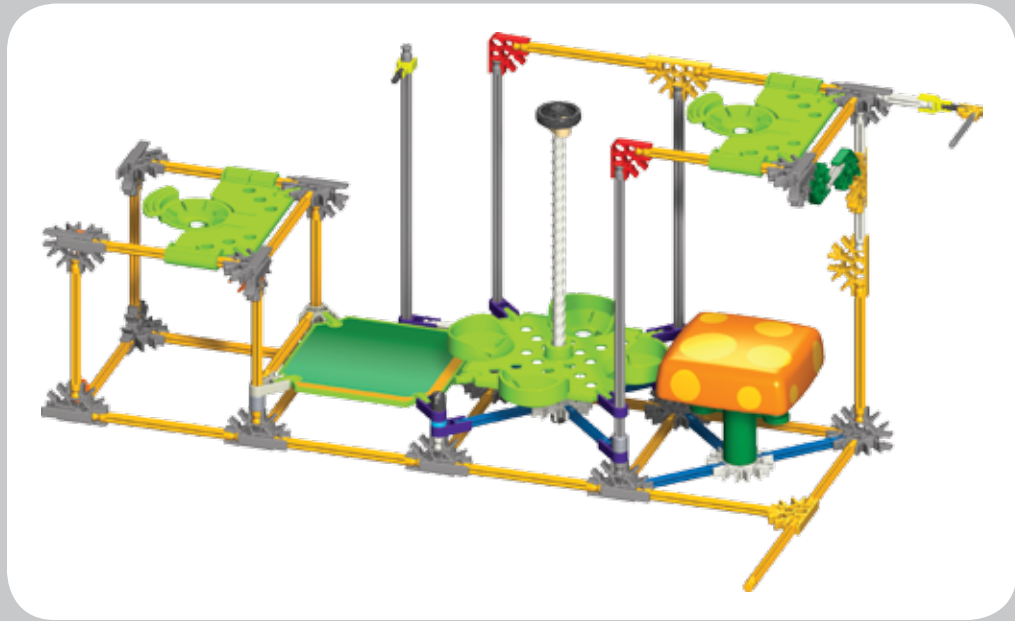
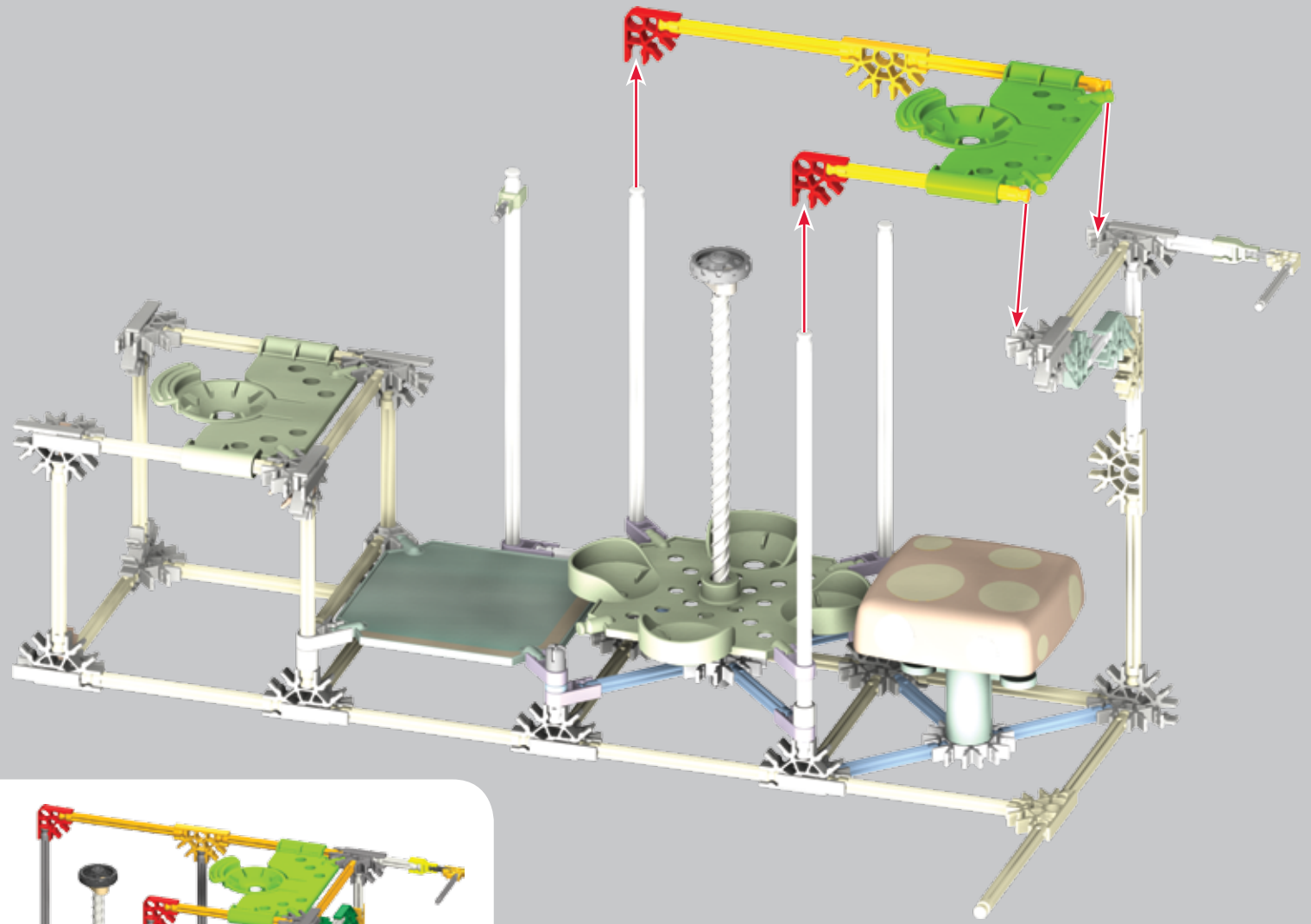

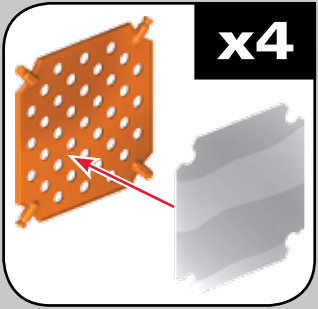

- Apply stickers
- Apposez des autocollants
- Aplicar pegatinas
- Anbringen von Aufklebern
- Applicare gli adesivi
- Aplicar adhesivos
- Aanbrengen stickers

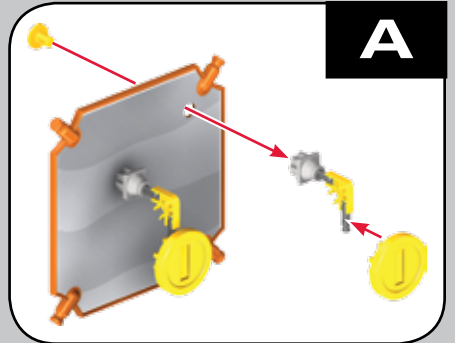
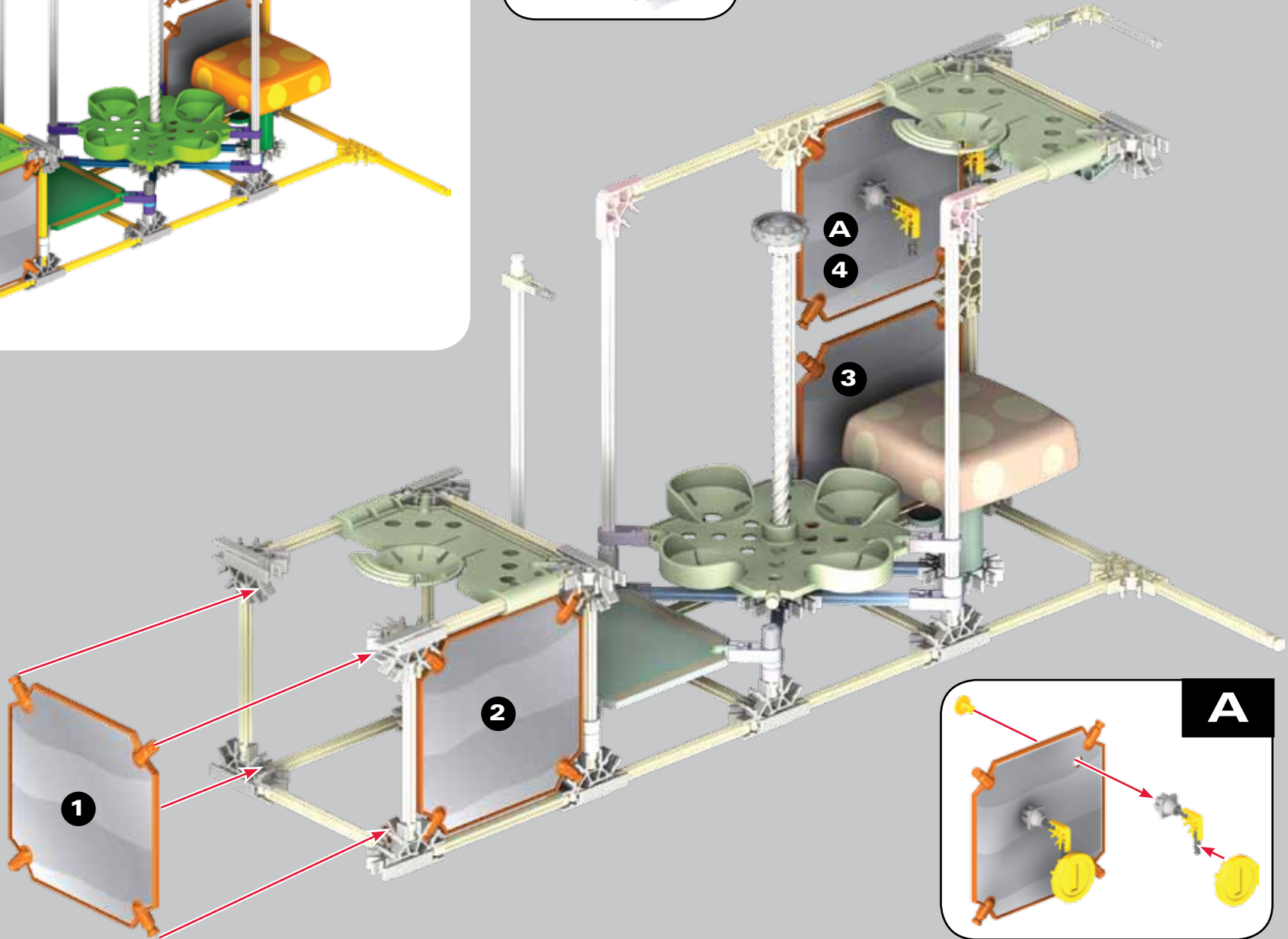
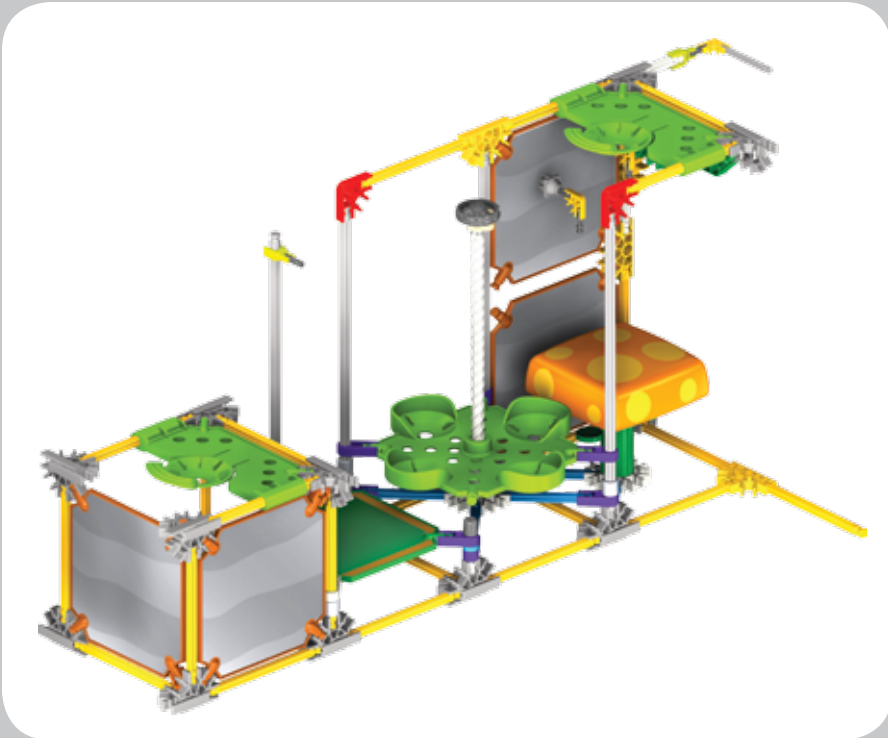

9

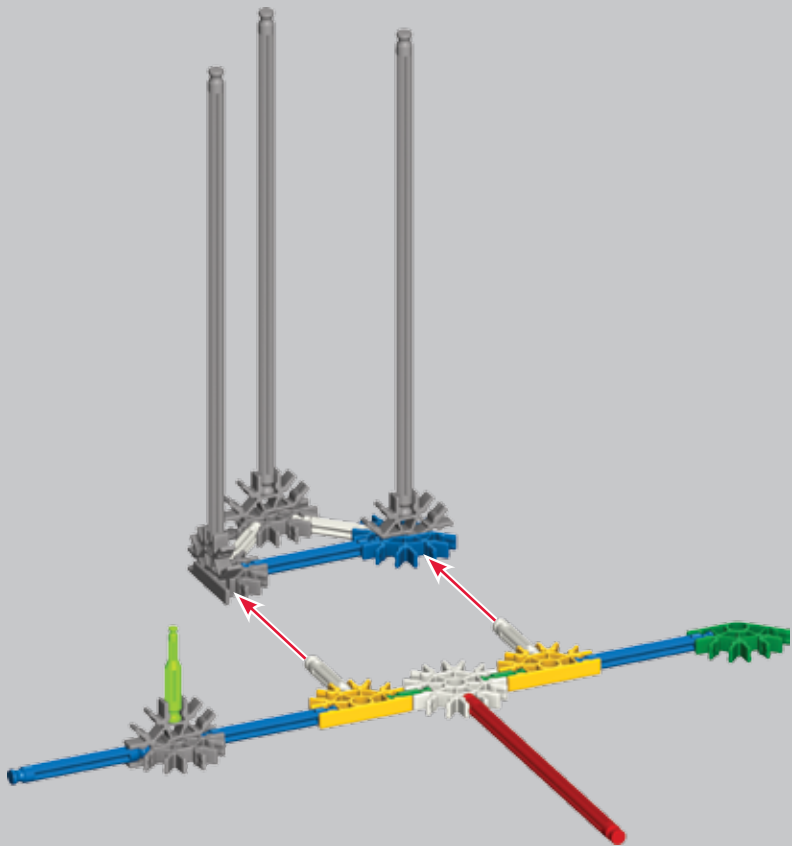
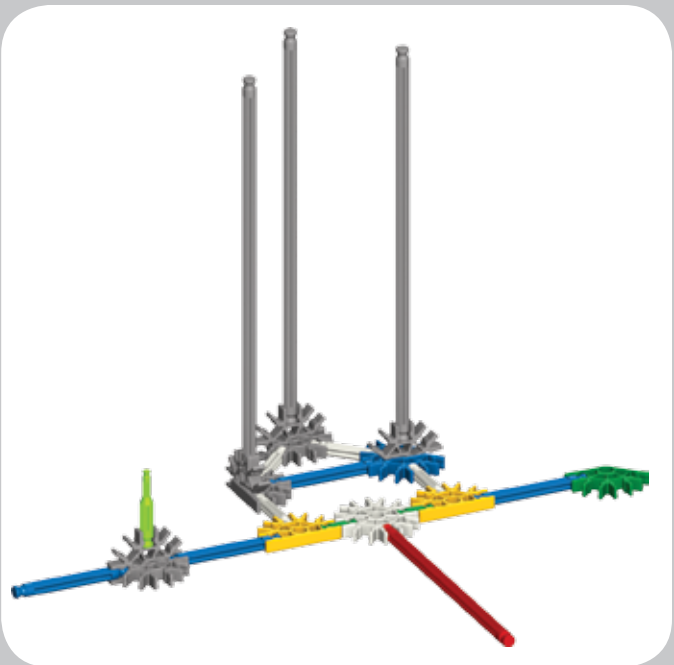

10

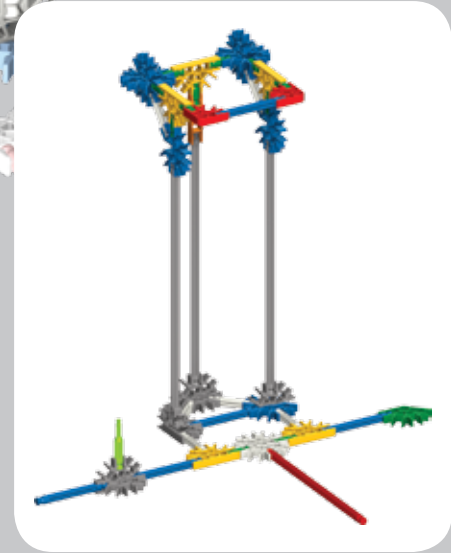
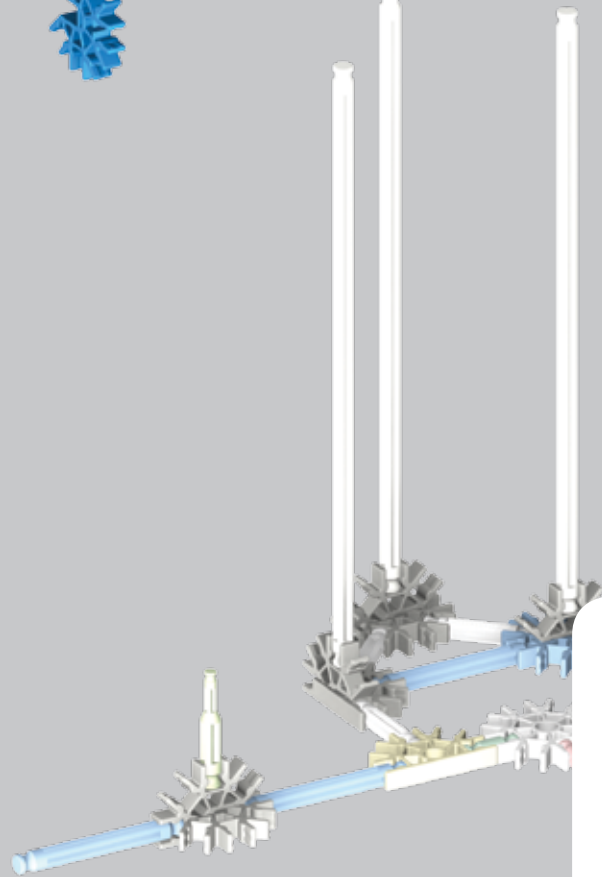
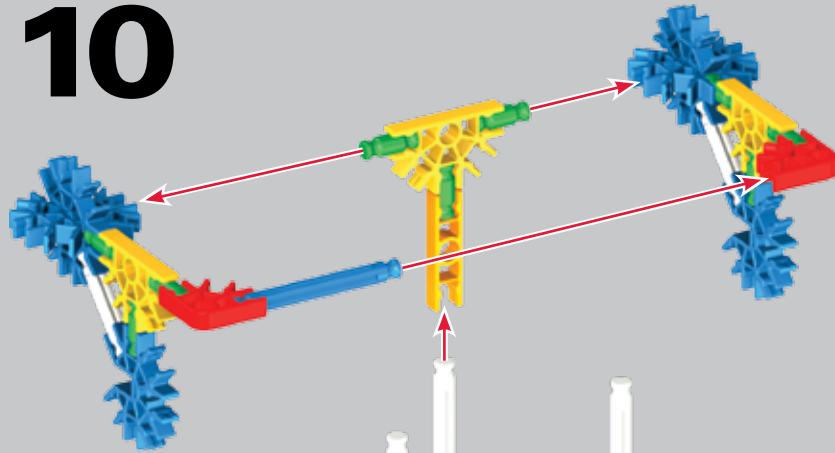

11

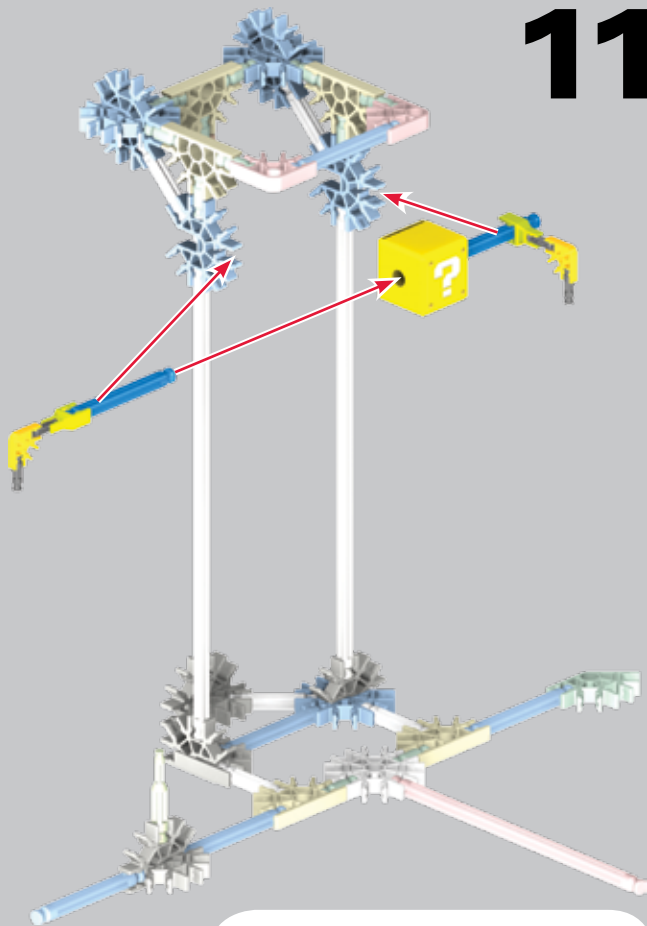

12

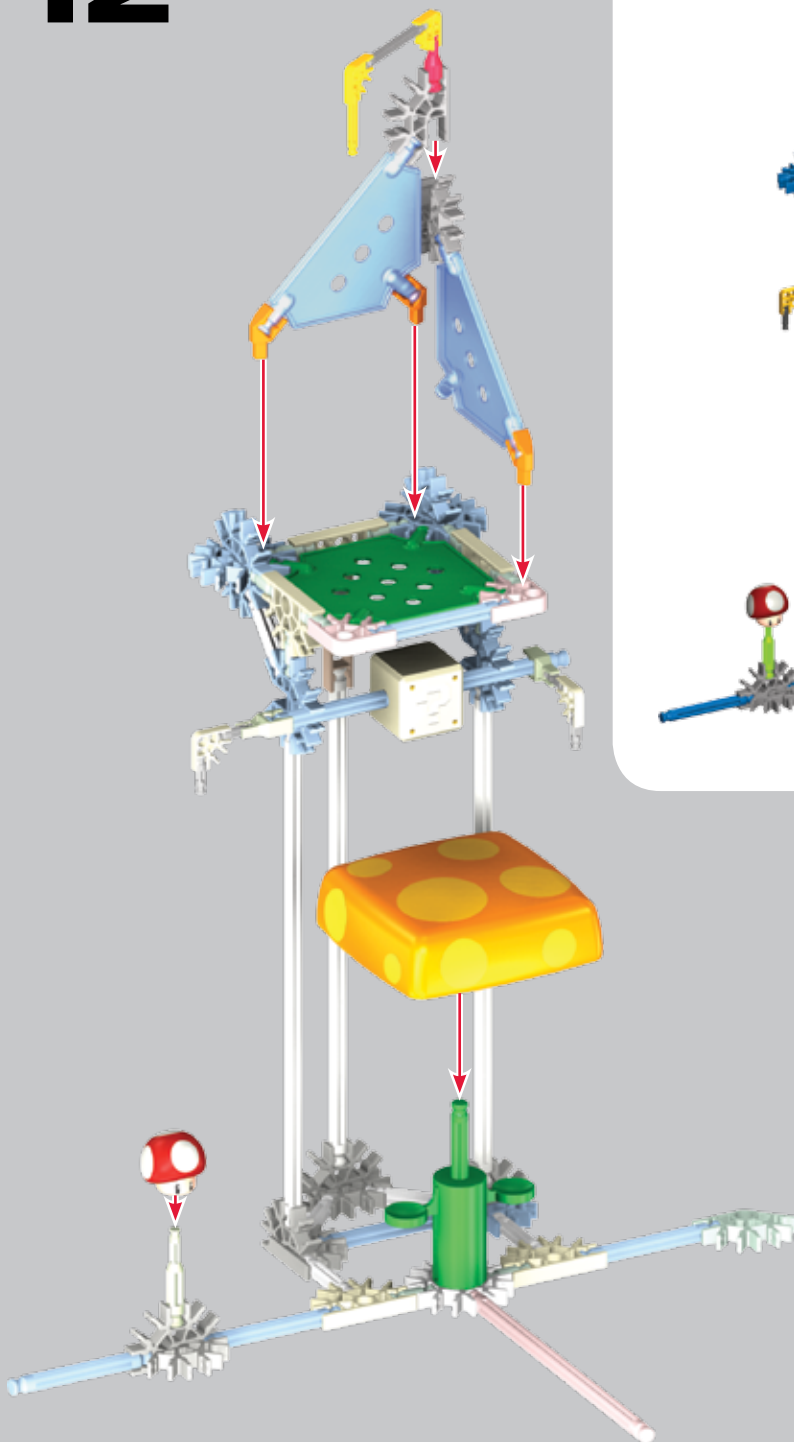

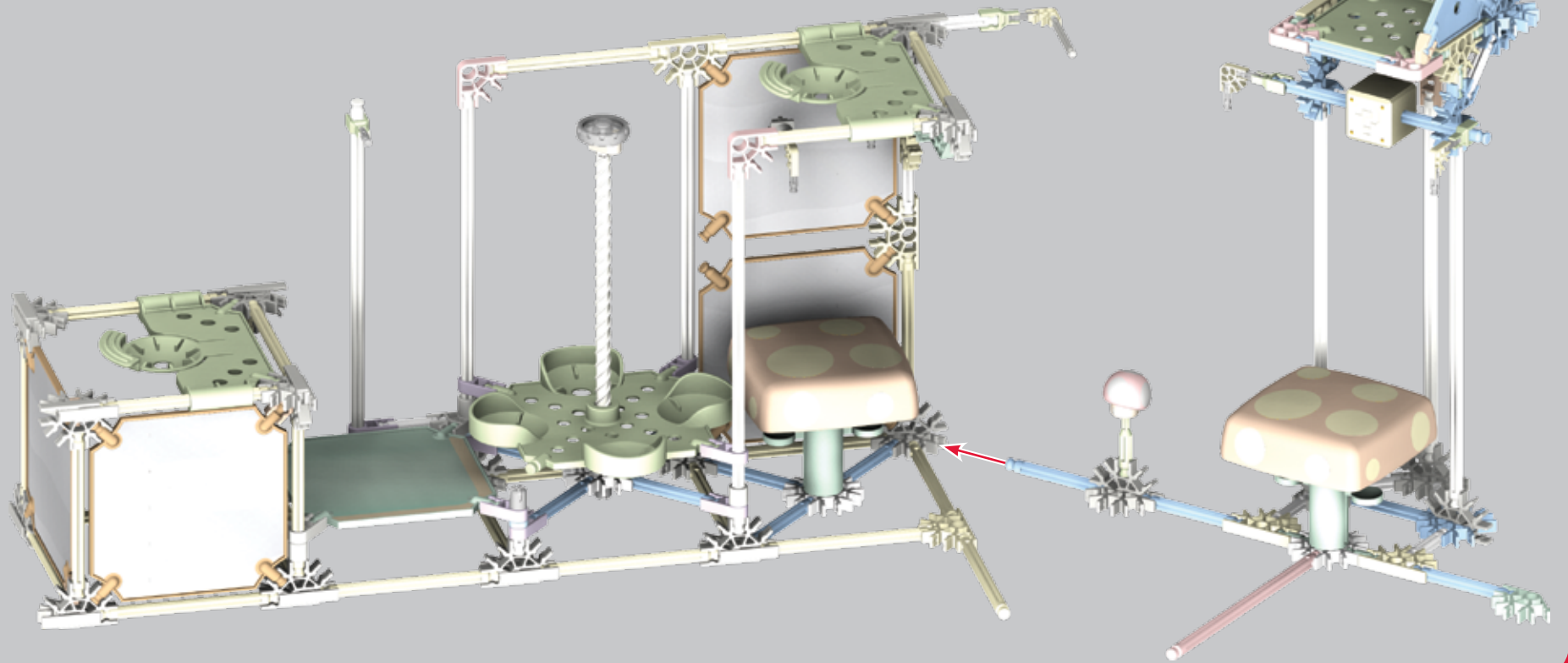

16

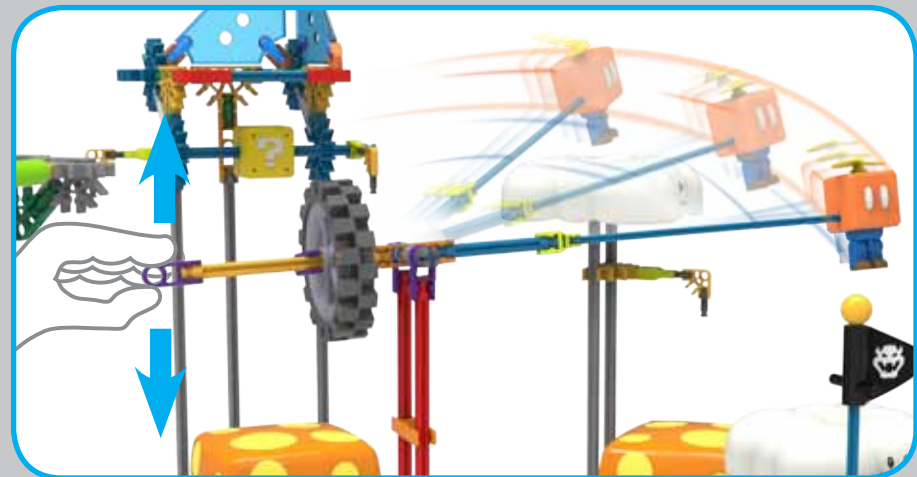
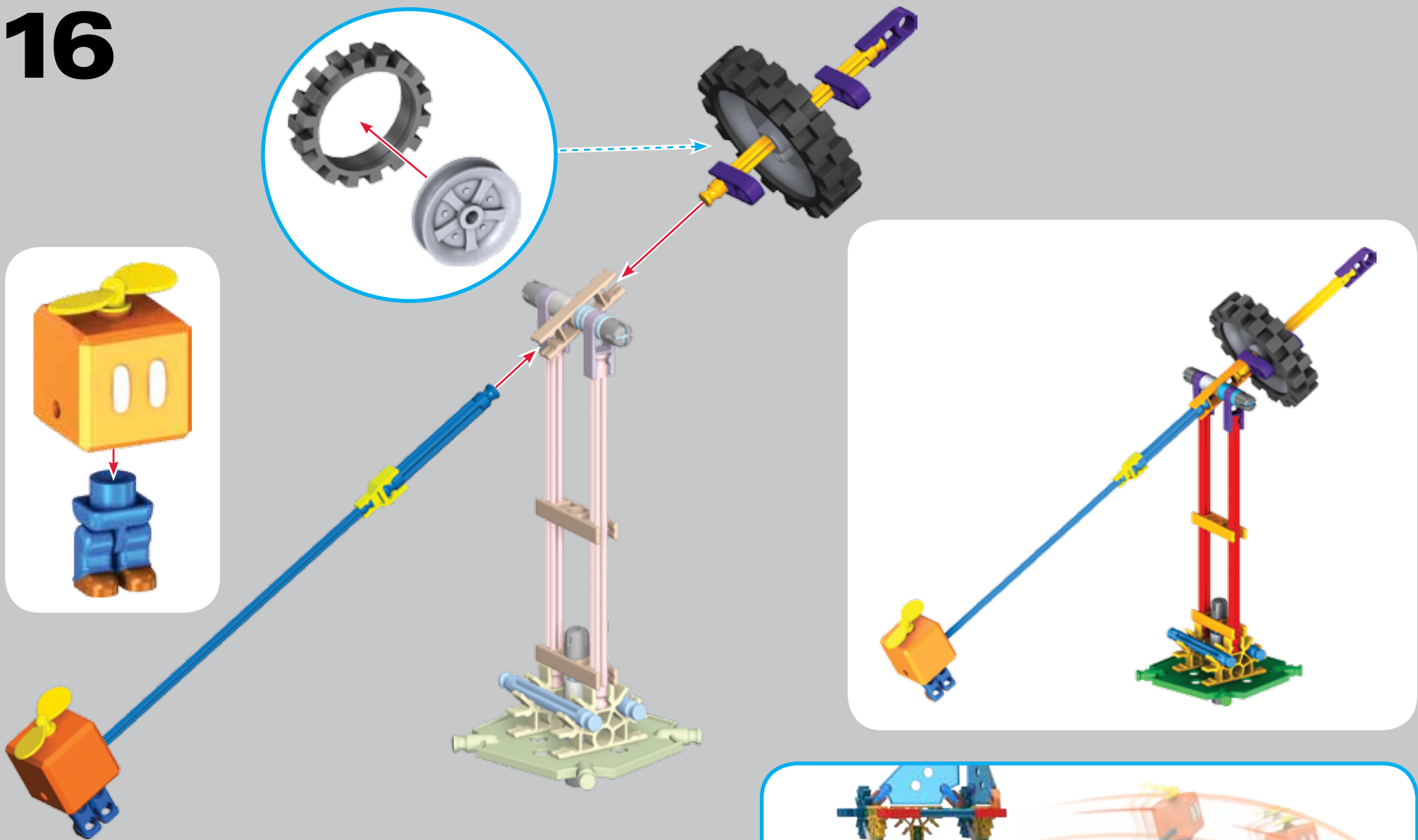

17

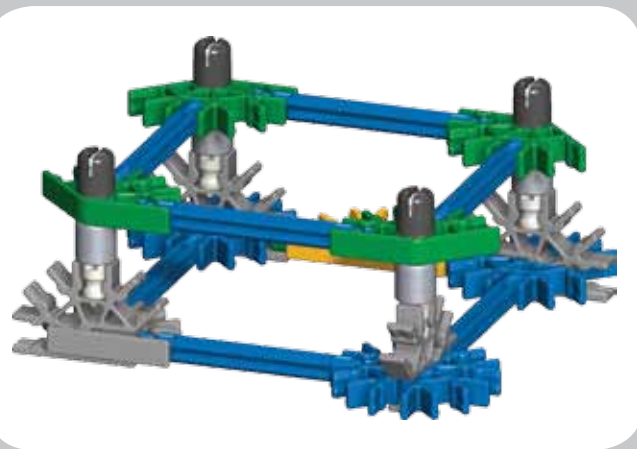
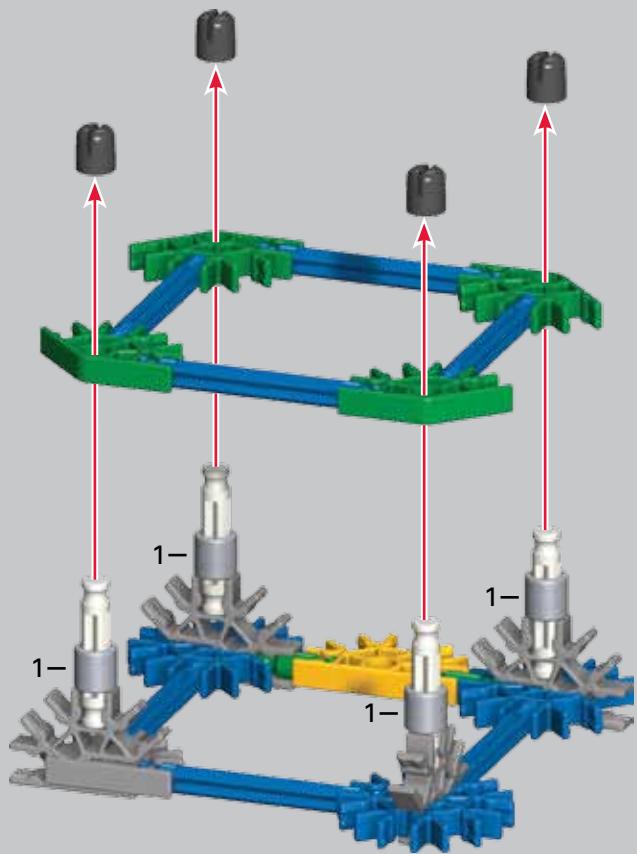

18

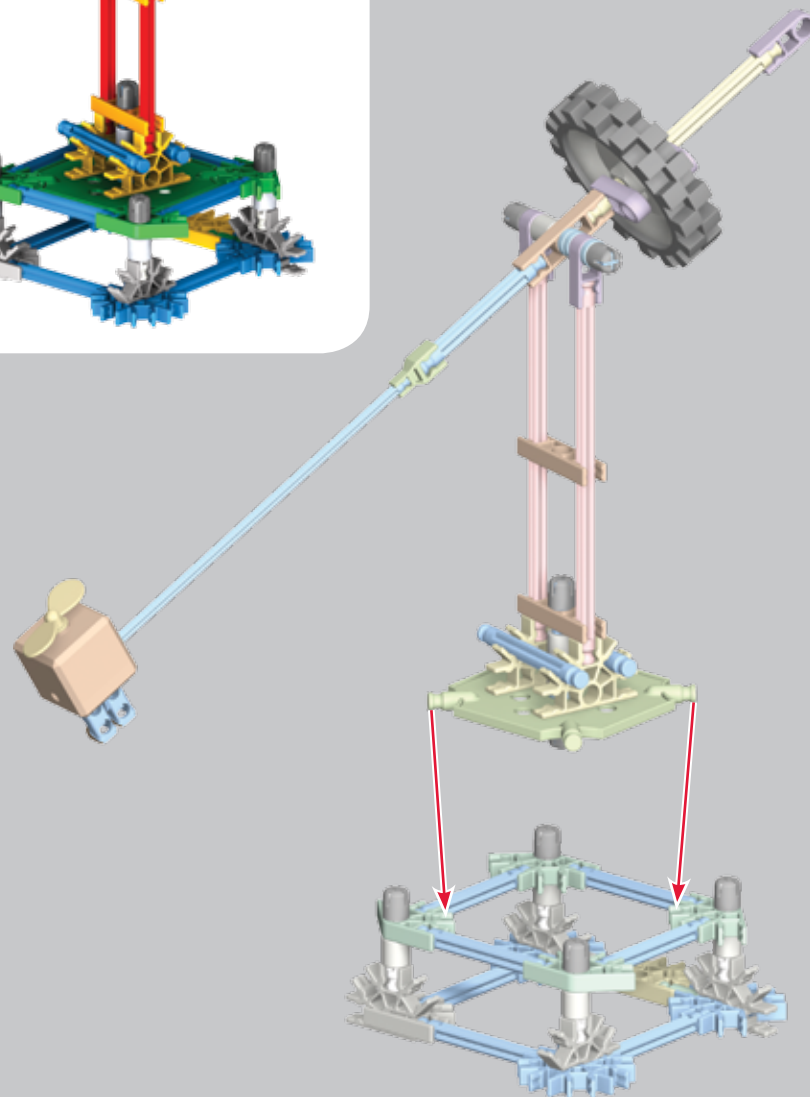

19

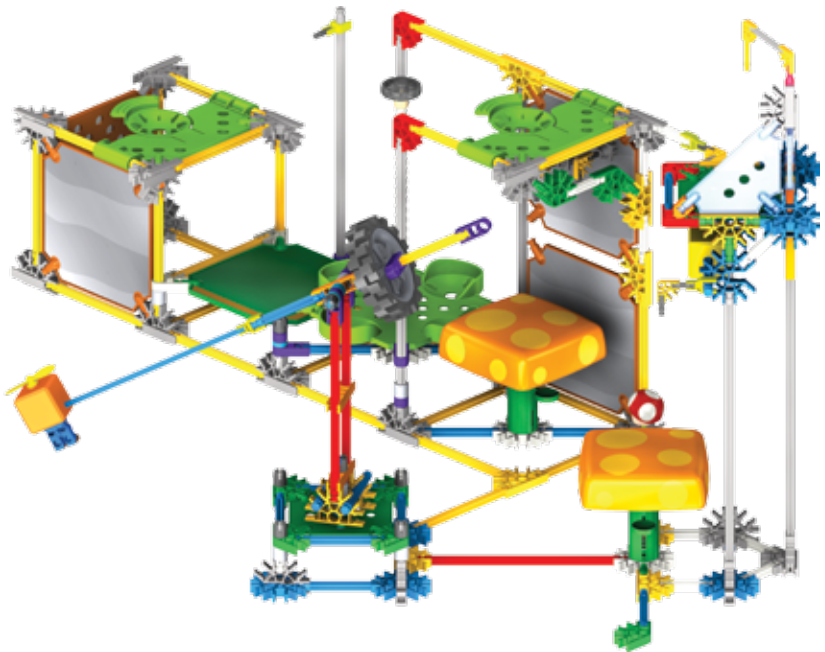
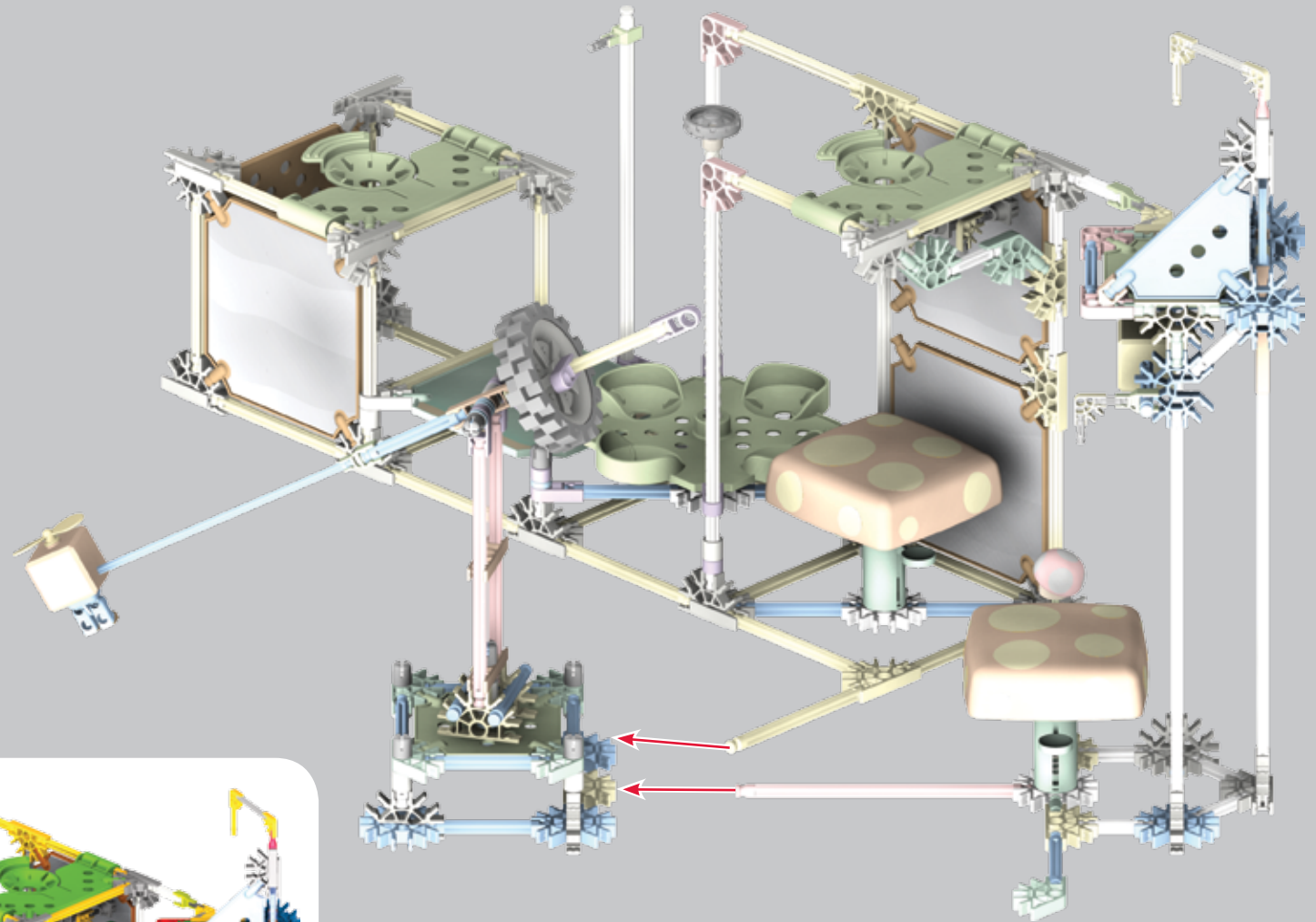

20

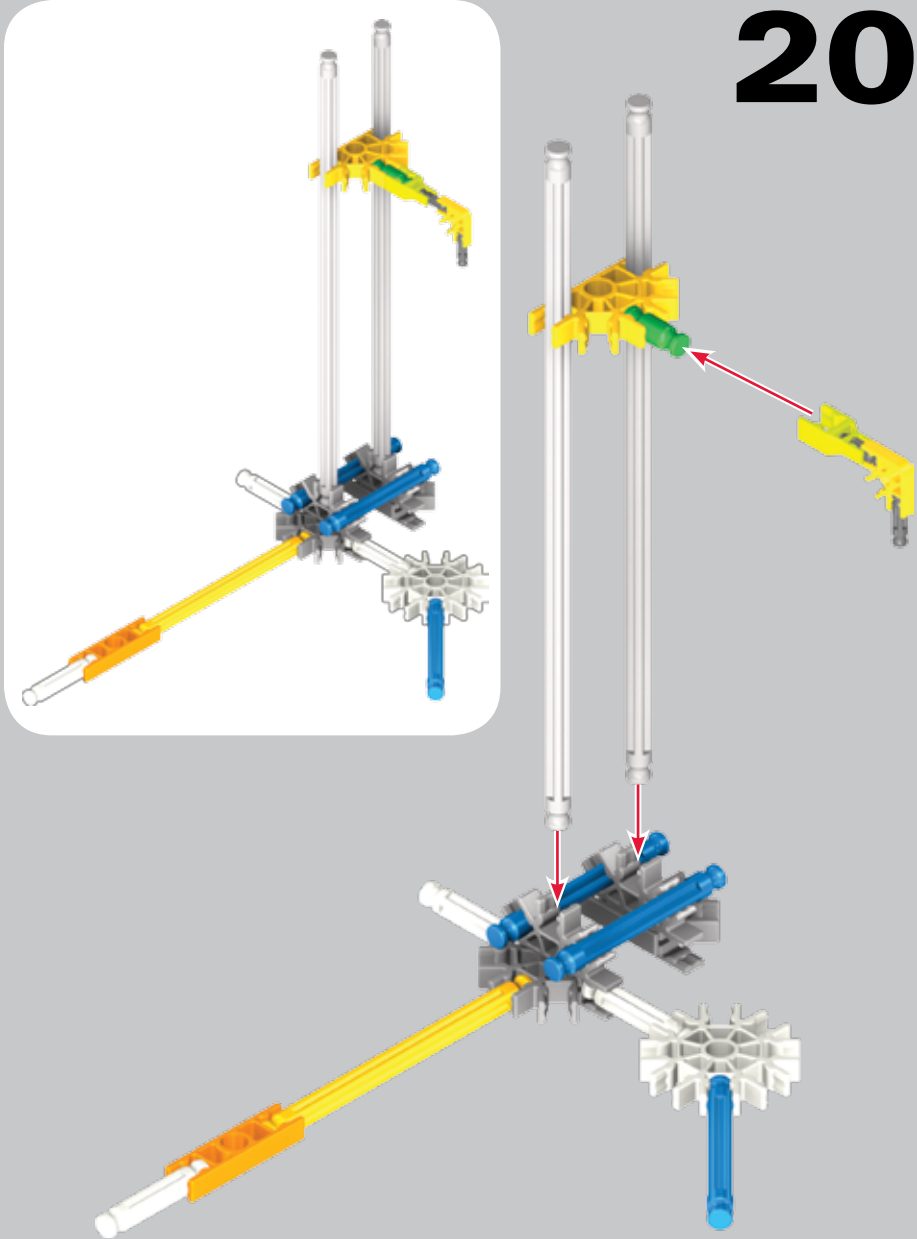

21

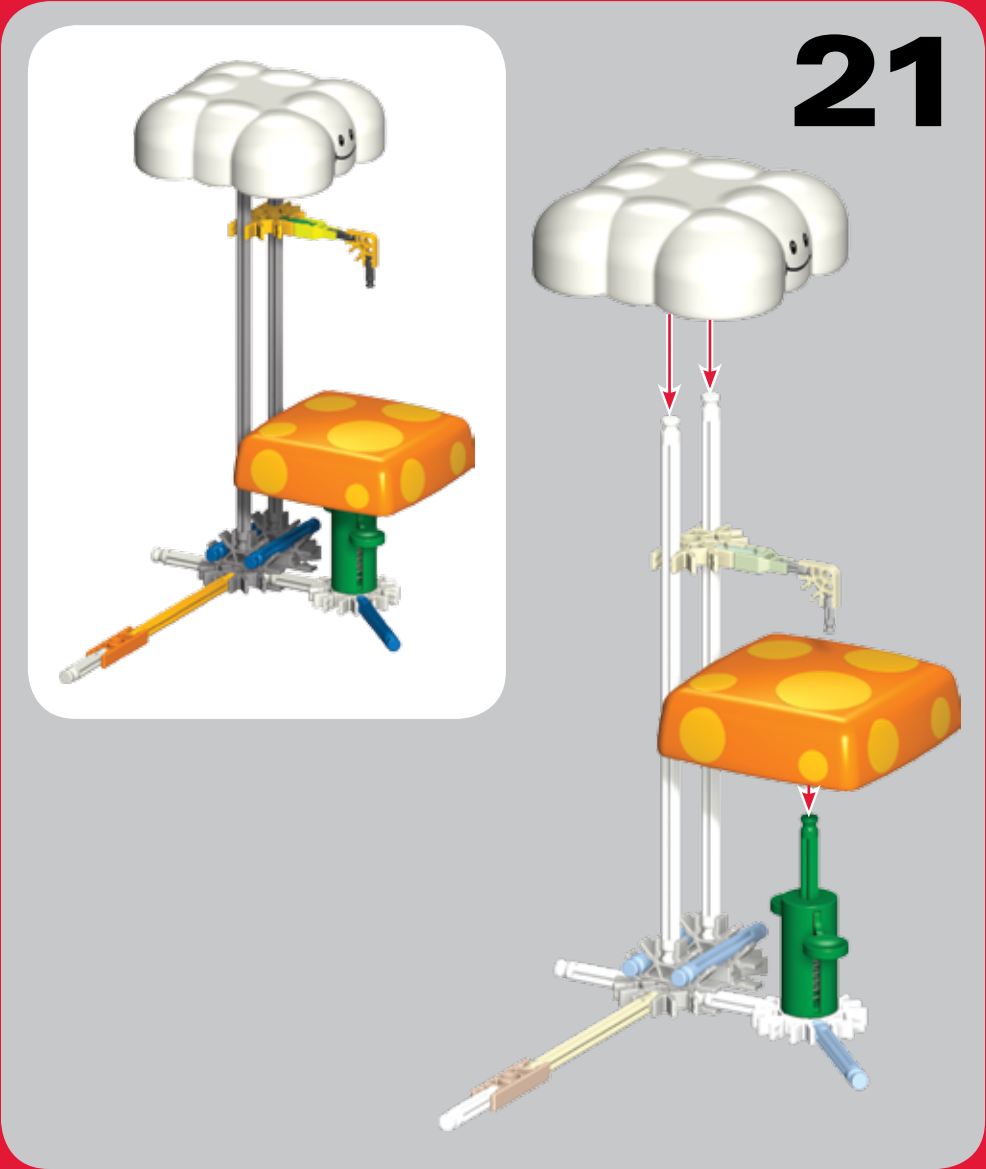

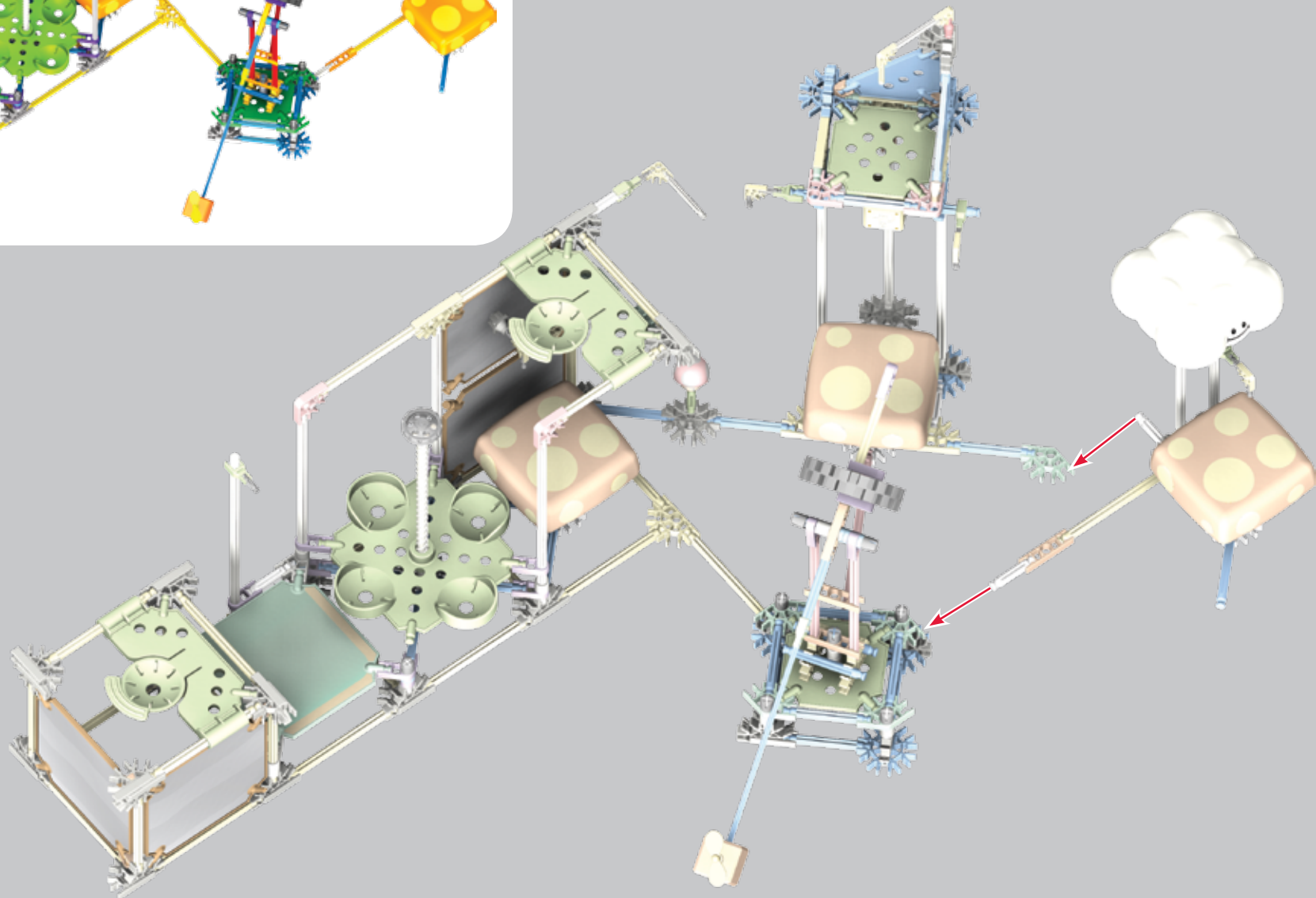

23

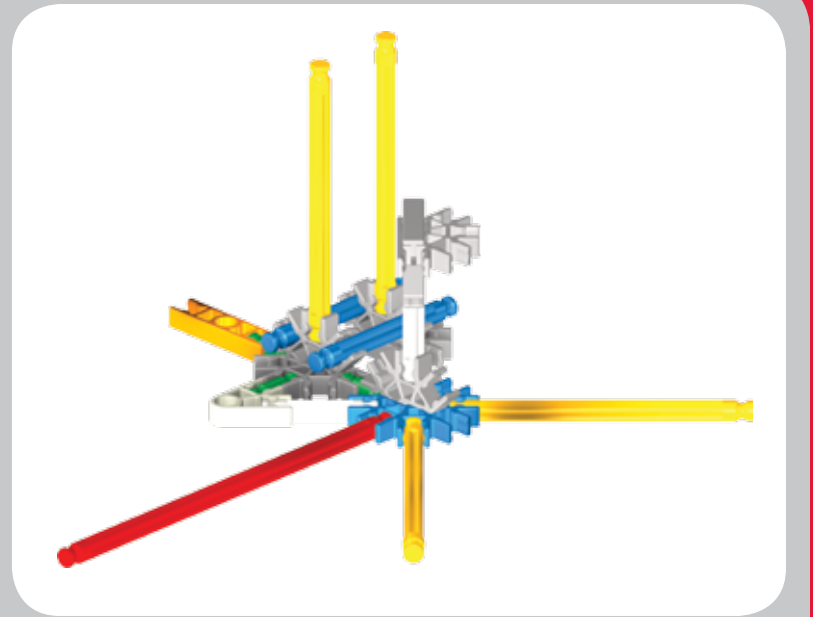
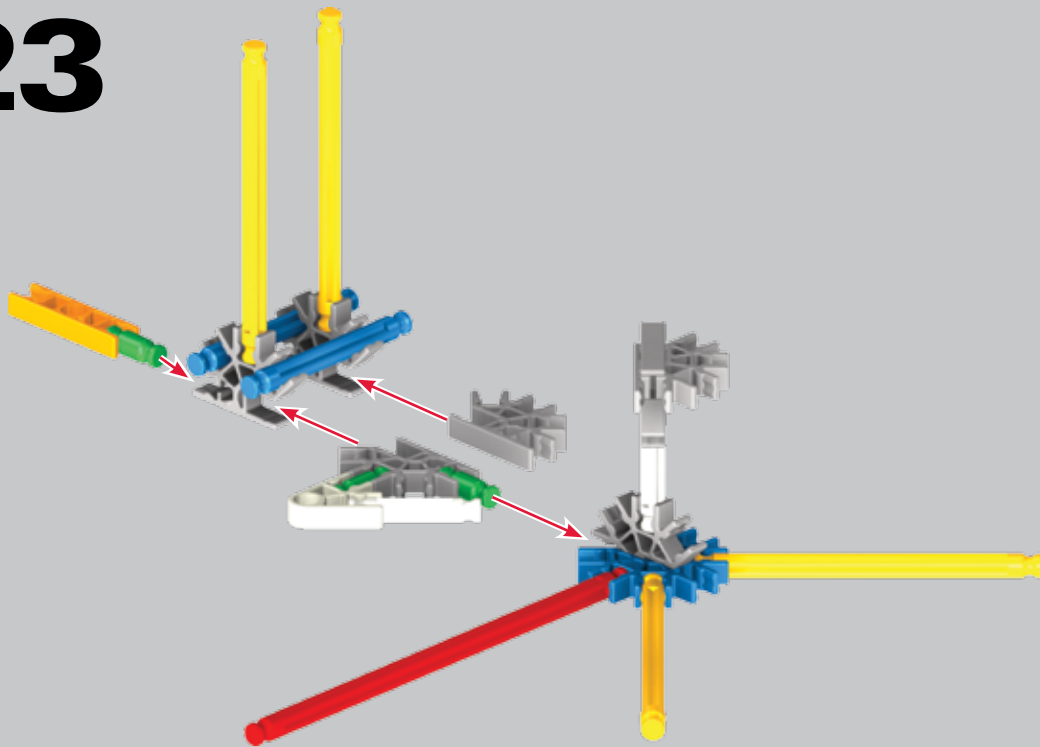

24

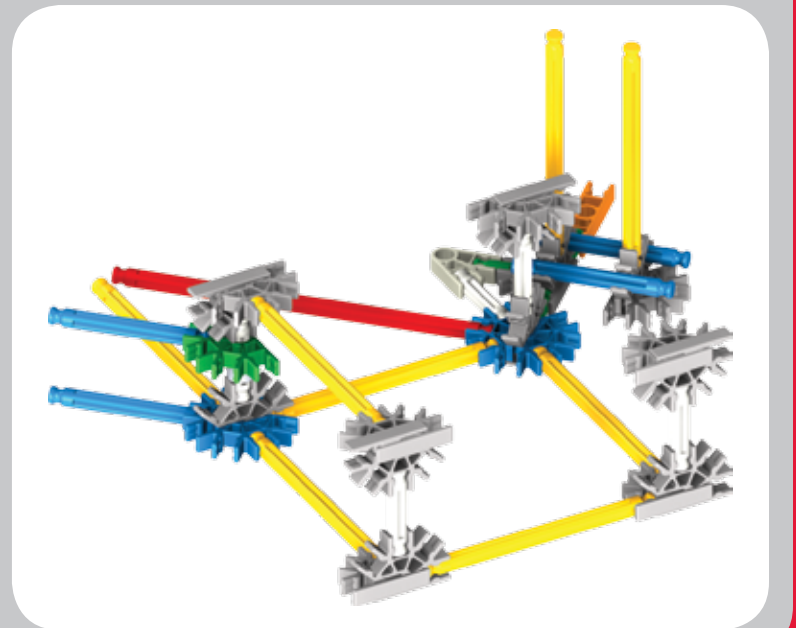
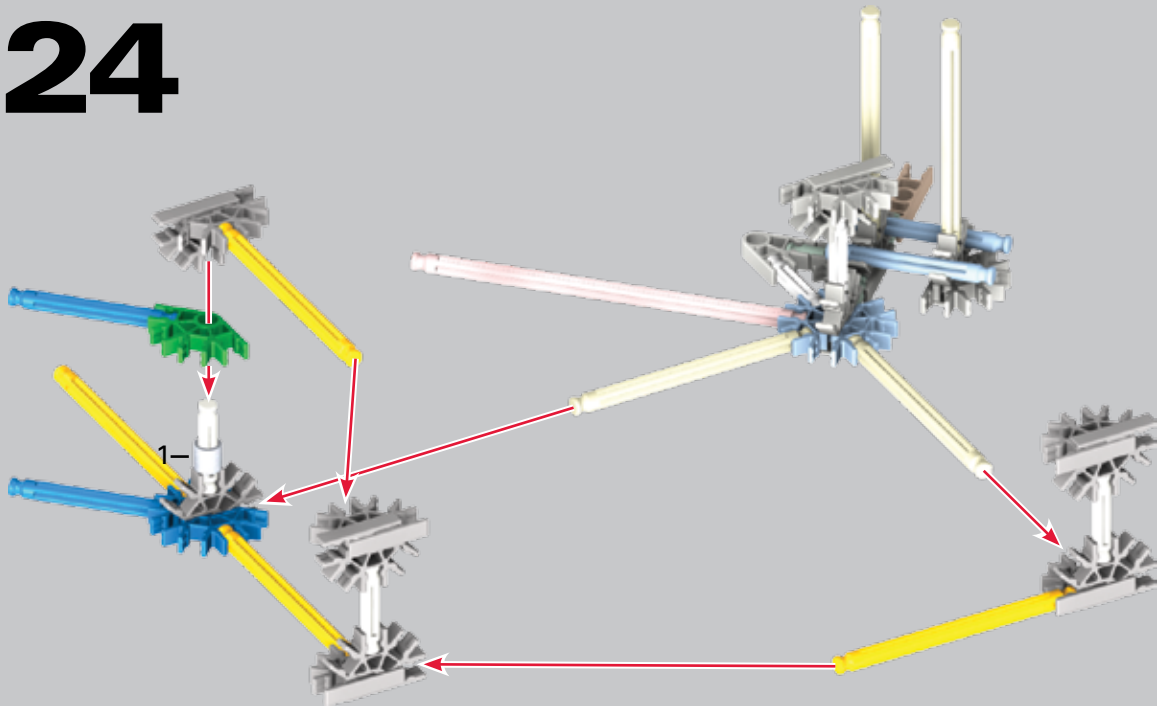

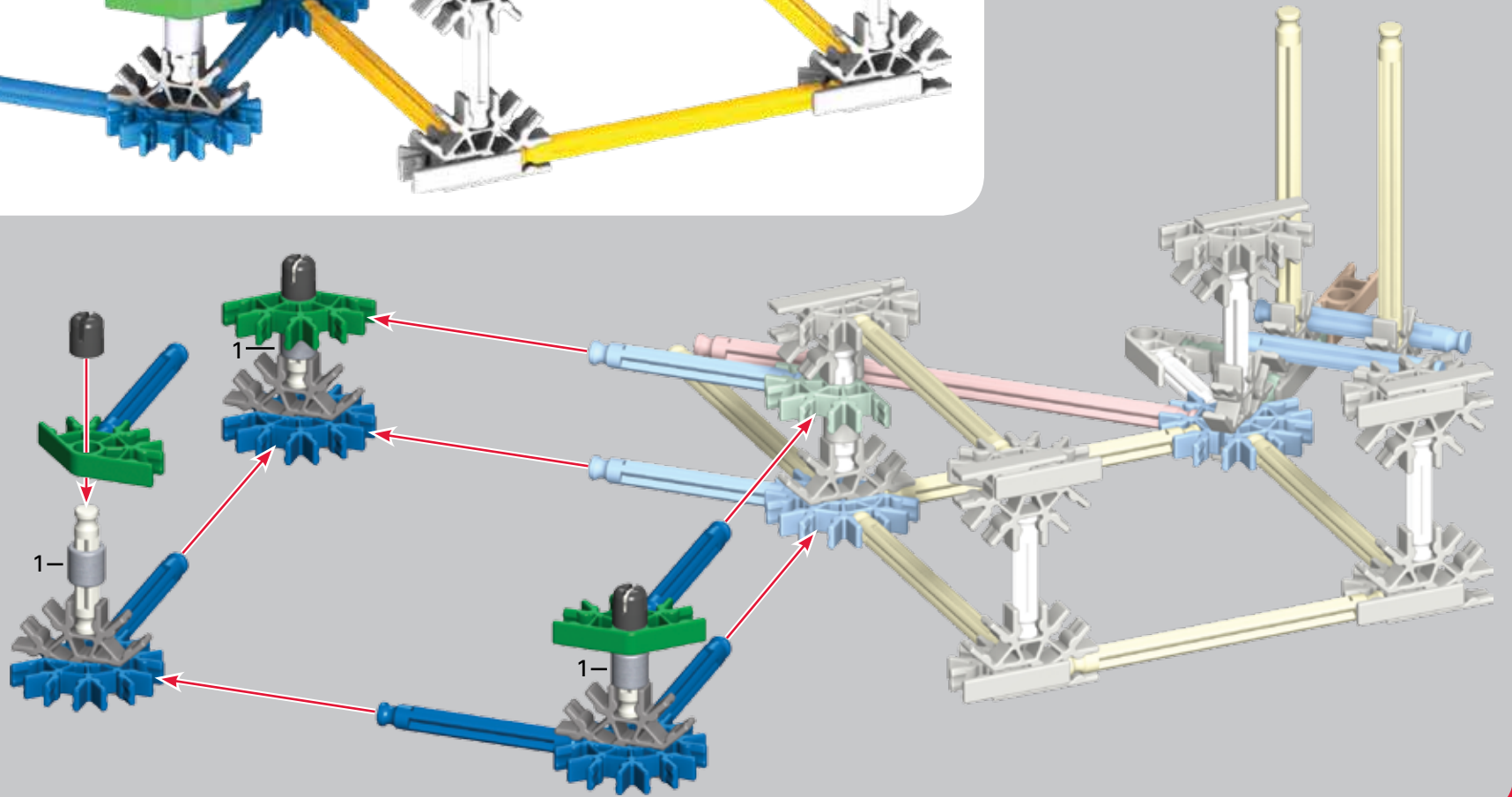
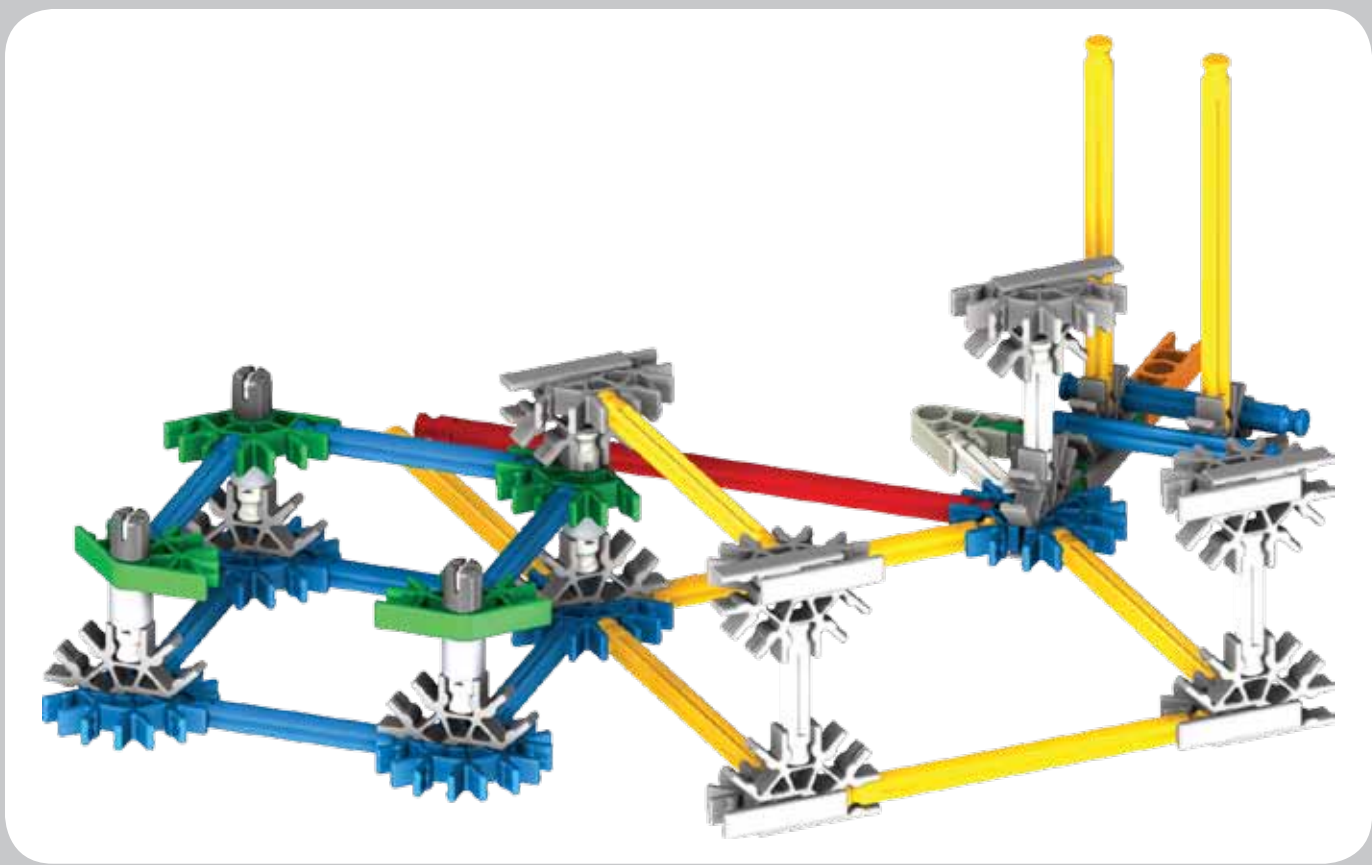

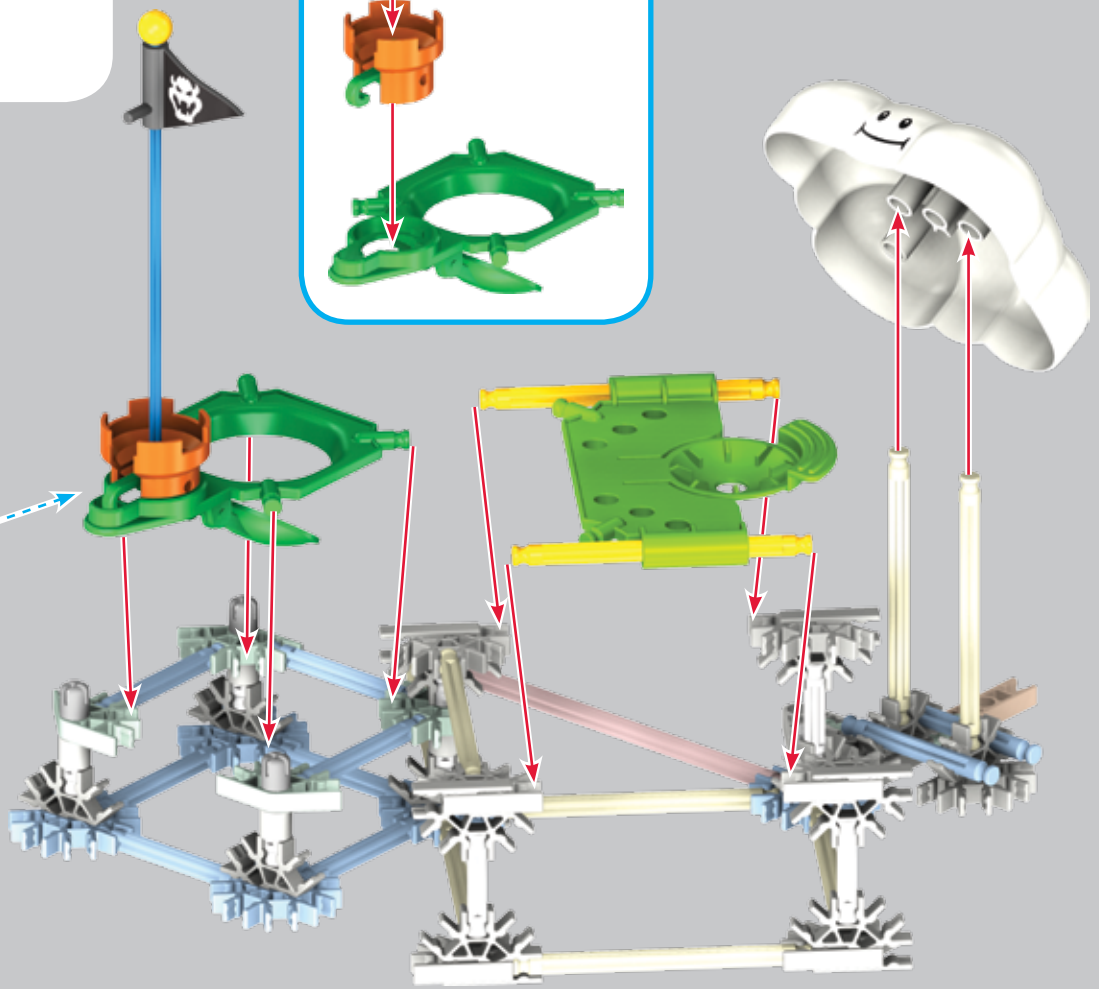
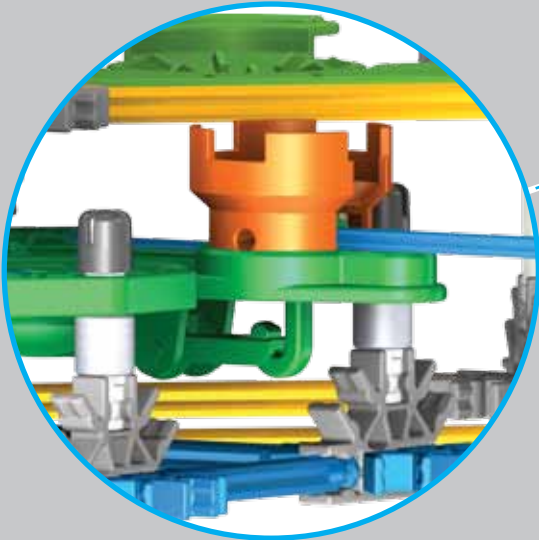
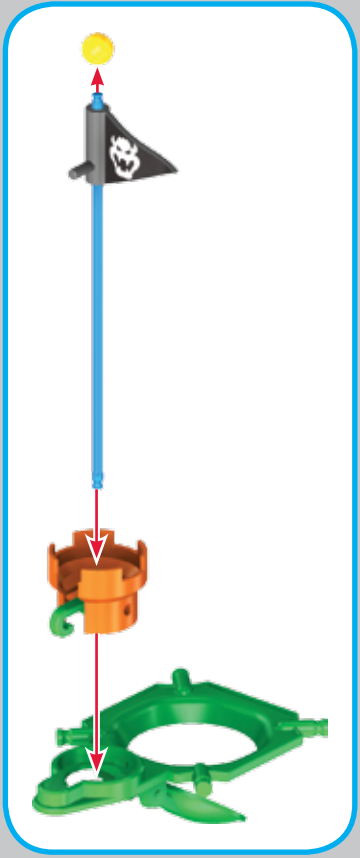
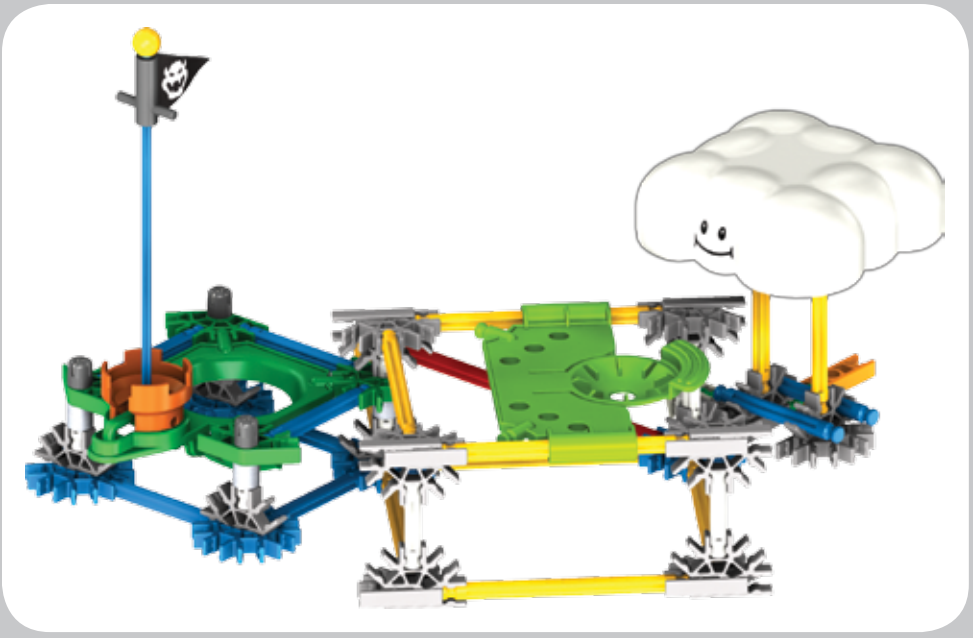

27

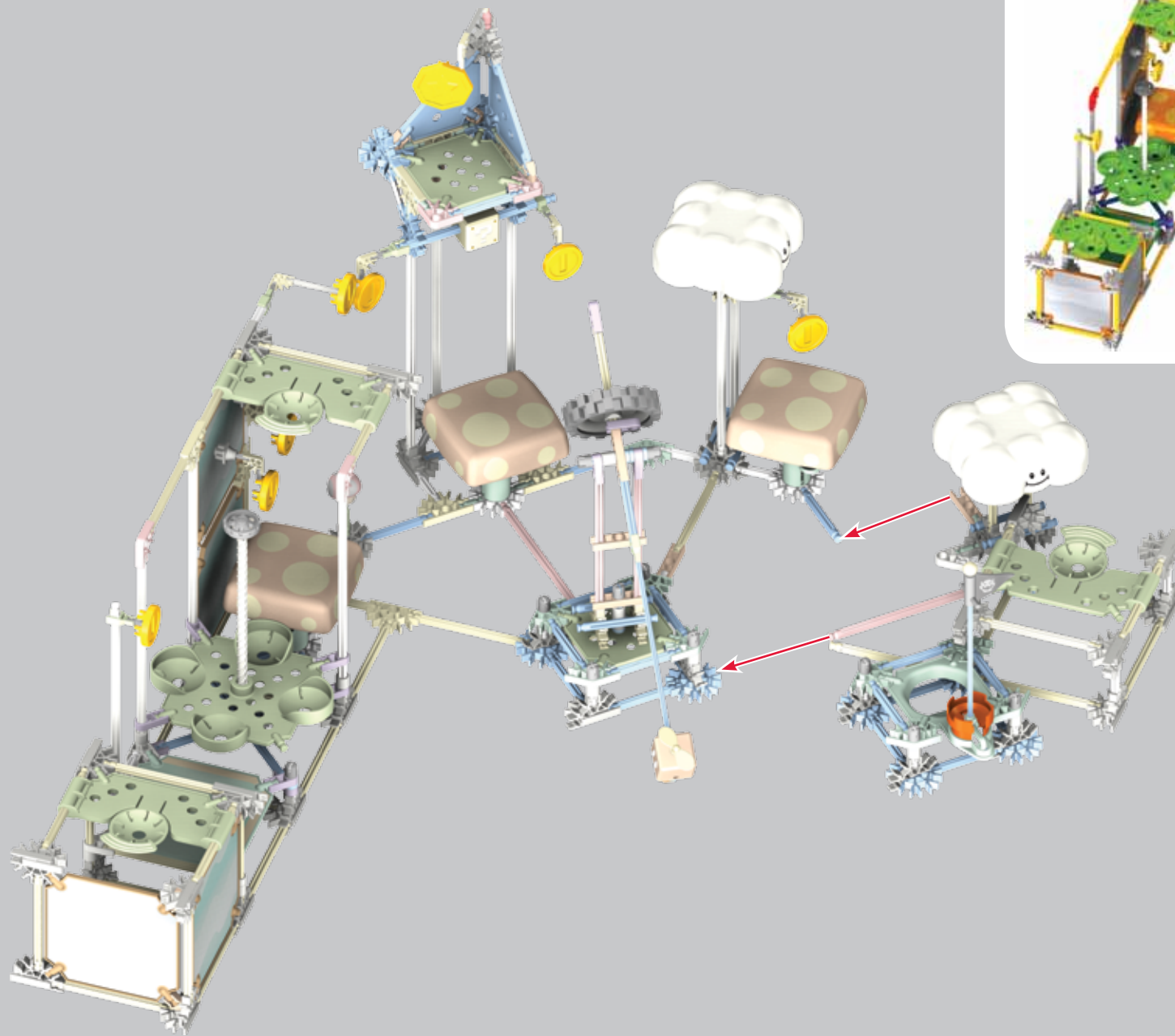

1

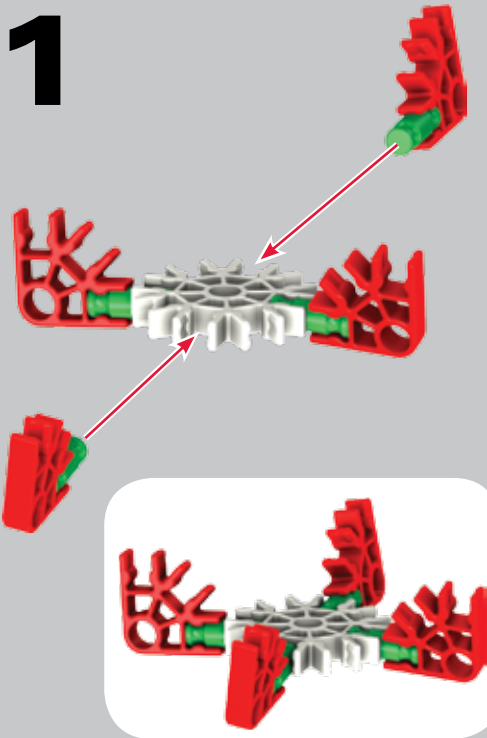

2

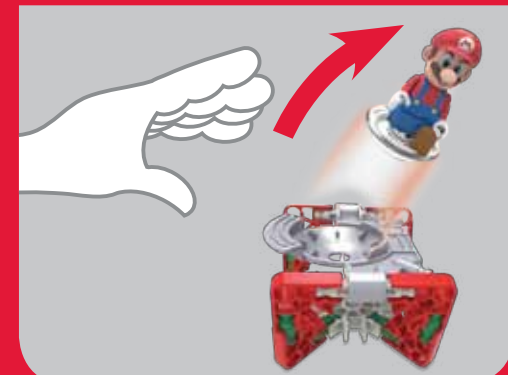
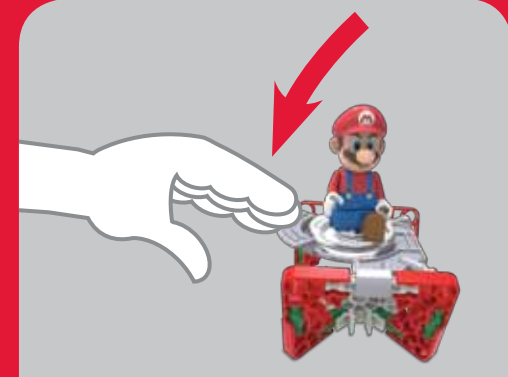
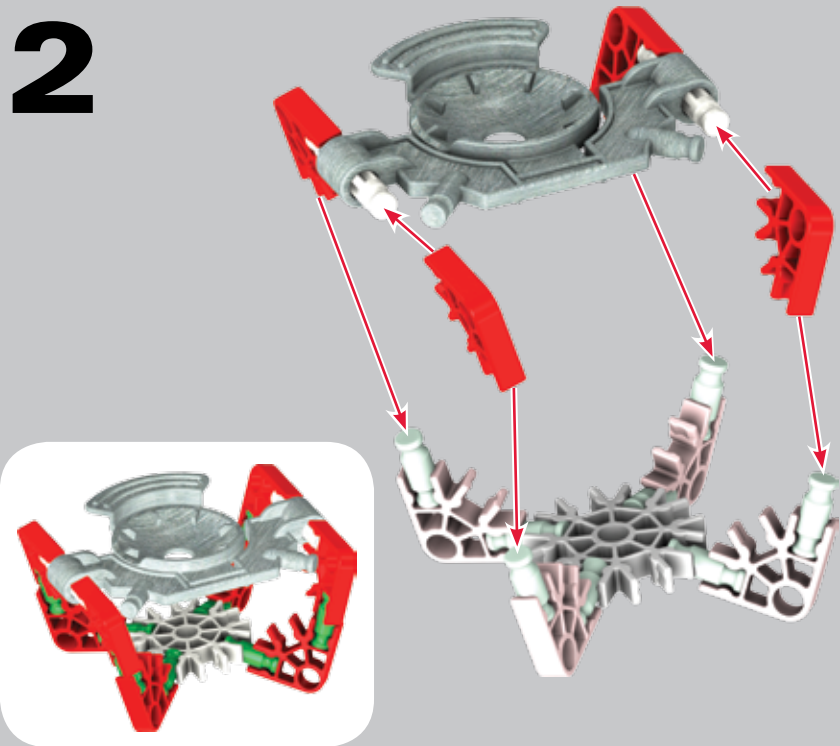

KNEX.COM

Sold separately
 Vendus séparément
 Se venden por separado
 Separat erhältlich
 Venduti separatamente
 Vendidos separadamente
 Afzonderlijk verkocht



EN CAUTION: Rubber Bands can cause injury from snap-back, breaking, or loss of control. While assembling models shown in instructions, hold rubber band tightly, and do not overstretch. Use Rubber Bands only as shown in these instructions. **DO NOT USE FRAYED OR TORN RUBBER BANDS. CAUTION:** Keep Rubber Bands away from face and eyes.

FR ATTENTION : Les élastiques peuvent causer des blessures en claquant, en se cassant ou quand on les manipule imprudemment. Tenez fermement l'élastique lors de l'assemblage du modèle en veillant à ne pas trop le tendre. N'utilisez les élastiques que selon les instructions. **N'UTILISEZ PAS D'ÉLASTIQUES ÉRAILLÉS OU DÉCHIRÉS. ATTENTION :** Tenez les élastiques en caoutchouc à l'écart du visage et des yeux.

ES PRECAUCIÓN: Las gomas pueden causar daños si se sueltan con fuerza, se rompen o se pierde su control. Al construir los modelos que se muestran en las instrucciones, sujetar bien la goma y no estirarla demasiado. Las gomas deben usarse únicamente como se indica en las instrucciones. **NO USAR GOMAS QUE ESTÉN DESGASTADAS NI ASGADAS. PRECAUCIÓN:** Mantenga las gomas elásticas alejadas de la cara y los ojos.

DE VORSICHT: Gummibänder können Verletzungen hervorrufen, wenn sie reißen, zurückspringen oder wenn sie nicht vorsichtig gehandhabt werden. Halten Sie die Gummibänder während des Zusammenbaus der Modelle fest, ohne sie jedoch zu überdehnen. Verwenden Sie die Gummibänder gemäß den Anweisungen. **VERWENDEN SIE NIEMALS AUSGEFRANSTE ODER ZERRISSENE GUMMIBÄNDER. VORSICHT:** Halten Sie Gummibänder weg von Gesicht und Augen.

IT ATTENZIONE: Elastici può causare lesioni da snap-back, rottura, o perdita di controllo. Durante il montaggio dei modelli indicati nelle istruzioni, tenere ben elastico, e non tirare troppo. Utilizzare Elastici solo come indicato in queste istruzioni. **NON USARE SFILACCIATI O STRAPPATI ELASTICI. ATTENZIONE:** Mantenga gli elastici a partire dal fronte e dagli occhi.

PT CUIDADO: As borrachas poderão causar ferimentos ao serem esticadas, ao quebrarem ou ao perderem controlo. Ao montar os modelos mostrados nas instruções, segure bem a borracha e não a estique demasiado. Utilize as borrachas apenas da forma exemplificada nestas instruções. **NÃO UTILIZE BORRACHAS CORRÓIDAS OU QUEBRADAS. CUIDADO:** Mantenha as faixas de borracha longe da cara e dos olhos.

NL OPGEPAST: Gummibånd kan forårsage personskade, hvis de springer tilbage, går i stykker eller springer af. Når modellerne samles efter instruktionerne, skal man holde gummibåndene stramme, men ikke strække dem for meget. Gummibåndene må kun bruges, som anvist. **BRUG ALDRIG SLIDTE ELLER BESKADIGEDE GUMMIBÅND. OPGEPAST:** Houd elastiekjes vanaf gezicht en ogen.



WARNING: CHOKING HAZARD – Toy contains a SMALL BALL and SMALL PARTS.

Not for children under 3 years.

ATTENTION ! RISQUE D'ÉTOUFFEMENT – Jouet contient une petite boule et pièces de petite taille. Ne convient pas aux enfants de moins de 3 ans.

ADVERTENCIA: PELIGRO DE ASFIXIA – Juguete contiene una pequeña bola y piezas pequeñas. No recomendado para niños menores de 3 años.

WARNUNG: ERSTICKUNGSGEFAHR – Spielzeug enthält einen kleinen Ball und Kleinteile. Nicht für Kinder unter 3 Jahren.

AVVISO: PERICOLO DI SOFFOCARE – Giocattolo a una piccola pallina e pezzi piccoli. Non adatto per bambini sotto 3 anni.

AVISO: PERIGO DE SUFOCAÇÃO – Toy contém uma pequena bola e peças pequenas. Não indicado para crianças menores de 3 anos.

WAARSCHUWING: VERSTIKKINGSGEVAAR – Speelgoed bevat een KLEIN BALLETTJE EN KLEINE ONDERDELEN. Niet voor kinderen onder 3 jaar.

©2013 K'NEX Limited Partnership Group, P.O. Box 700, Hatfield, PA 19440-0700; email@knex.com; knex.com 1-800-KID-KNEX (USA/États-Unis/EE.UU./Canada)

For customer outside the USA/Canada please contact your local distributor at www.knex.com/distributors. (FR) Le Service clients hors États-Unis/Canada, s'il vous plaît contacter le distributeur local. L'information de distributeur peut être trouvée à www.knex.com/distributors. (ES) El cliente que no vive en EE.UU./Canadá se pone en contacto con el distribuidor local. Encuentre la información para el distribuidor local en www.knex.com/distributors.

(AU)(BE)(CL)(MX)(NZ) www.knex.com/distributors. (UK) TOMY Careline, PO Box 20, Totton, Hants, SO40 3YF; Tel 023 8066 2600 (FR) ALLO TOMY SAV, Parc d'affaires international, 74166 ARCHAMPS ; Tél 0 820 013 013 (DE)(FR)(NL)(UK) www.tomy.eu

K'NEX and Building Worlds Kids Love are registered trademarks of K'NEX Limited Partnership Group. Product and colors may vary. (FR) K'NEX et Building Worlds Kids Love sont des marques déposées de K'NEX Limited Partnership Group. Produits et couleurs peuvent varier. (ES) K'NEX y Building Worlds Kids Love son marcas registradas de K'NEX Limited Partnership Group. El producto y los colores pueden variar.

CAUTION: Do not launch in the direction of people, animals, or walls; You could cause injury or damage.

ATTENTION : Ne lancez pas dans la direction des personnes, des animaux, ou des murs ; Vous pourriez endommager des dommages ou.

PRECAUCIÓN: No lance en dirección de gente, de animales, o de paredes; Usted podría estropear lesión o.

VORSICHT: Starten Sie nicht in Richtung der Leute, der Tiere oder der Wände; Sie konnten Verletzung oder Schaden verursachen.

AVVERTENZA: Non lanci in direzione della gente, degli animali, o delle pareti; Potreste causare la lesione o il danno.

CUIDADO: Não lanç no sentido dos povos, dos animais, ou das paredes; Você poderia causar ferimento ou dano.

VOORZICHTIGHEID: Lanceer niet in de richting van mensen, dieren, of muren; U kon verwonding of schade veroorzaken.

† Edición limitada
Limited Edition
Edizione limitata
Edição limitada
Beperkt editie



facebook.com/buildknex

TM & © 2013 Nintendo.



- Identifies Genuine K'NEX Bricks.
- Identifie que ce sont d'authentiques briques K'NEX.
- Identifica los ladrillos genuinos de K'NEX.
- Identifiziert echte K'NEX-Bausteine.
- Identifica i veri blocchi K'NEX.
- Identifica que são cubos genuínos da K'NEX.
- Identificeert K'NEX bakstenen voor.

138528-V1-04/13



Tomy UK Ltd.
Totton, Hants
SO40 3SA, England