



# MARIOKART Wii

6+

## MARIO™ AND YOSHI™ FINISH LINE BUILDING SET™



**+2** Motorized Karts  
Karts Motorizado  
Karts Motorisé



38471/71676

301 pc/pza

# K'NEX®



# MARIOKART™ Wii

1

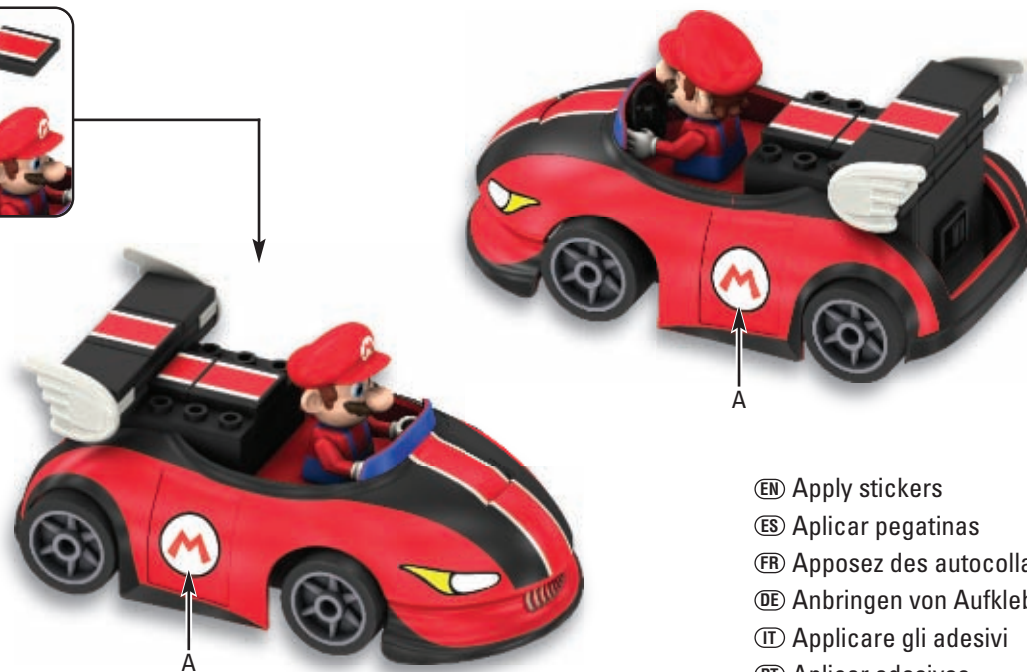
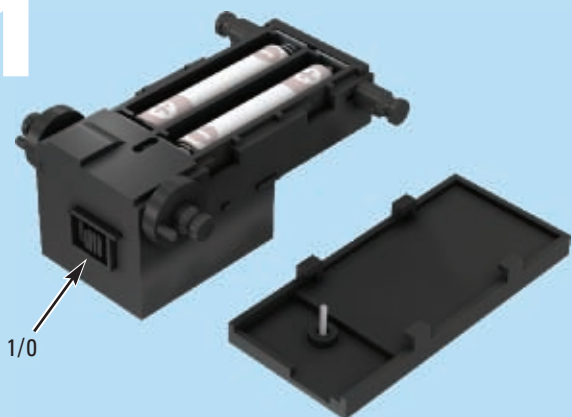

- Ⓔ Apply stickers
- Ⓔ Aplicar pegatinas
- Ⓔ Appelez des autocollants
- Ⓔ Anbringen von Aufklebern
- Ⓔ Applicare gli adesivi
- Ⓔ Aplicar adesivos
- Ⓔ Aanbrengen stickers

2



3

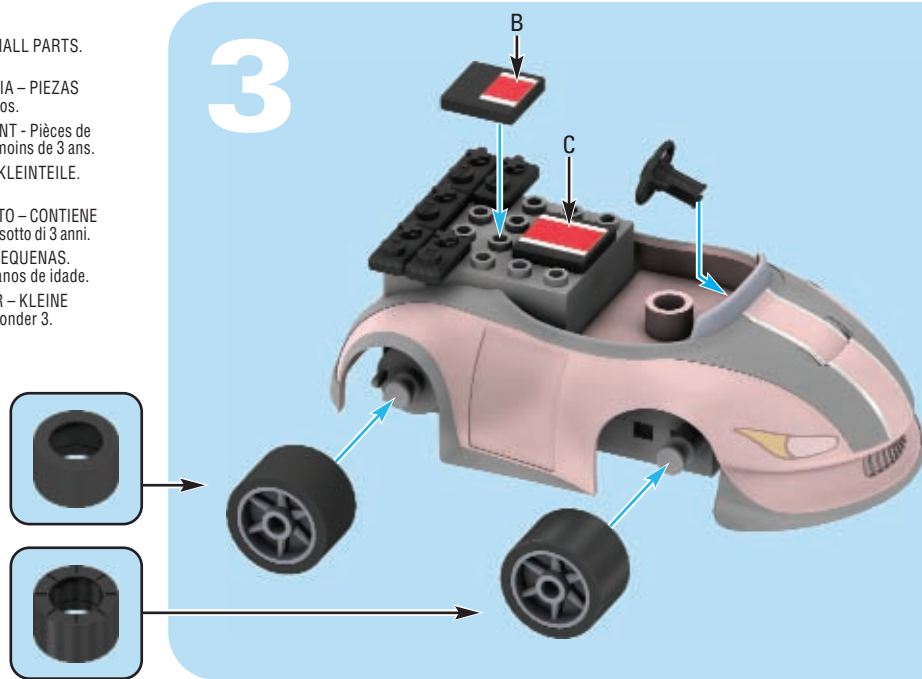

4

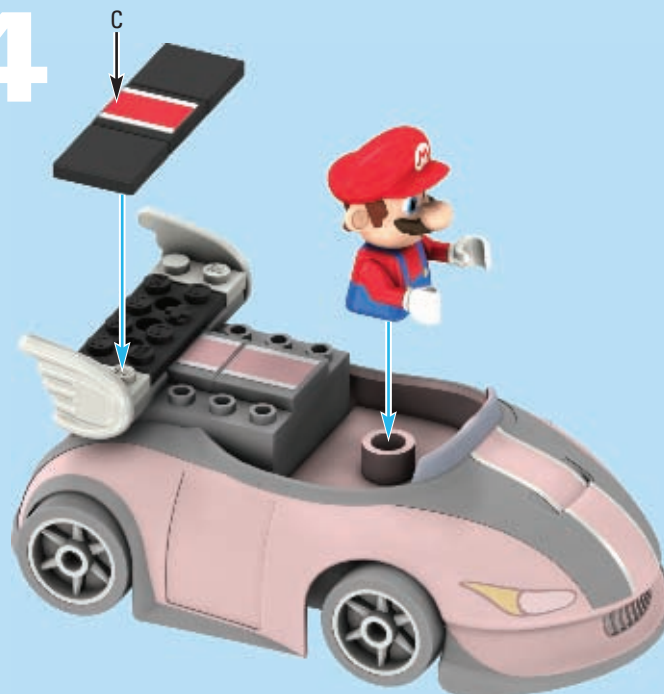

**WARNING: CHOKING HAZARD - SMALL PARTS.**  
Not for children under 3 years.

**ADVERTENCIA: PELIGRO DE ASFIXIA - PIEZAS PEQUEÑAS.** No para niños menores de 3 años.

**AVERTISSEMENT: DANGER D'ÉTOUFFEMENT - Pièces de petite taille.** Ne convient pas aux enfants de moins de 3 ans.

**WARNHINWEIS: ERSTICKUNGSGEFAHR - KLEINTEILE.** Nicht geeignet für Kinder unter 3 Jahren.

**AVVERTENZA: PERICOLO DI SOFFOCAMENTO - CONTIENE PICCOLE PARTI.** Non adatto per bambini al di sotto di 3 anni.

**AVISO: PERIGO DE SUFOCAÇÃO - PEÇAS PEQUENAS.** Não se destina a crianças com menos de 3 anos de idade.

**WAARSCHUWING: VERSTIKKINGSGEVAAR - KLEINE ONDERDELEN.** Niet geschikt voor kinderen onder 3.

# MARIOKART Wii

1

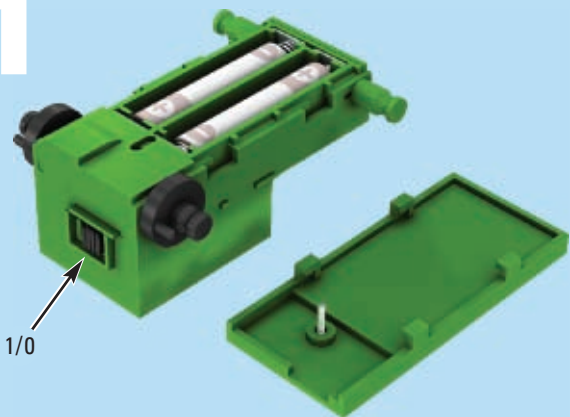

2

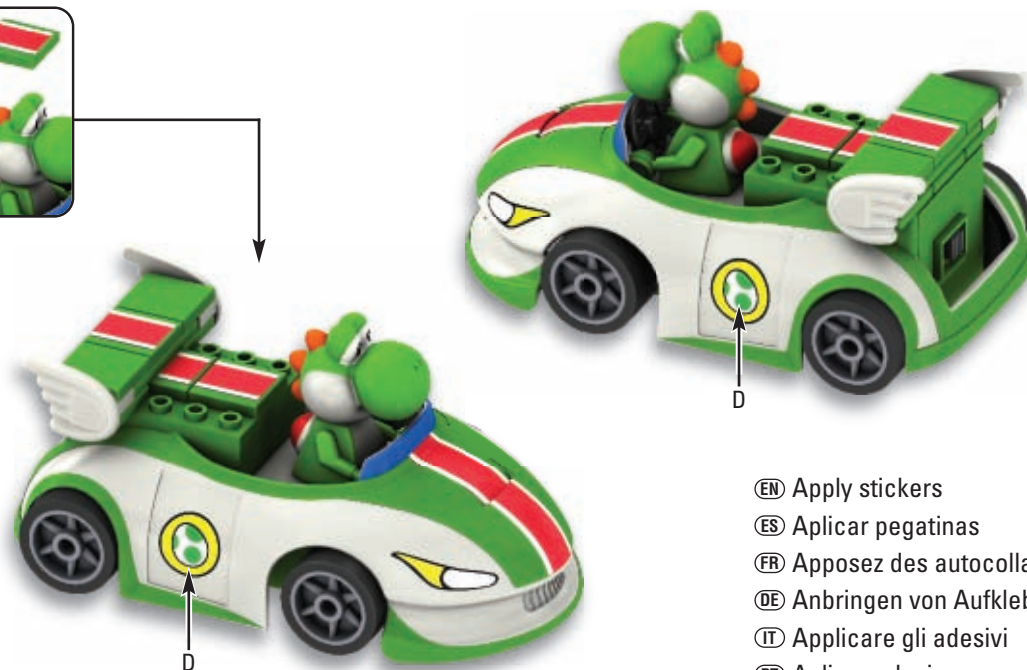

- EN Apply stickers
- ES Aplicar pegatinas
- FR Appelez des autocollants
- DE Anbringen von Aufklebern
- IT Applicare gli adesivi
- PT Aplicar adesivos
- NL Aanbrengen stickers

**WARNING: CHOKING HAZARD - SMALL PARTS.**  
Not for children under 3 years.

**ADVERTENCIA: PELIGRO DE ASFIXIA - PIEZAS PEQUEÑAS.** No para niños menores de 3 años.

**AVERTISSEMENT: DANGER D'ÉTOUFFEMENT - Pièces de petite taille.** Ne convient pas aux enfants de moins de 3 ans.

**WARNHINWEIS: ERSTICKUNGSGEFAHR - KLEINTEILE.** Nicht geeignet für Kinder unter 3 Jahren.

**AVVERTENZA: PERICOLO DI SOFFOCAMENTO - CONTIENE PICCOLE PARTI.** Non adatto per bambini al di sotto di 3 anni.

**AVISO: PERIGO DE SUFOCAÇÃO - PEÇAS PEQUENAS.** Não se destina a crianças com menos de 3 anos de idade.

**WAARSCHUWING: VERSTIKKINGSGEVAAR - KLEINE ONDERDELEN.** Niet geschikt voor kinderen onder 3.

3

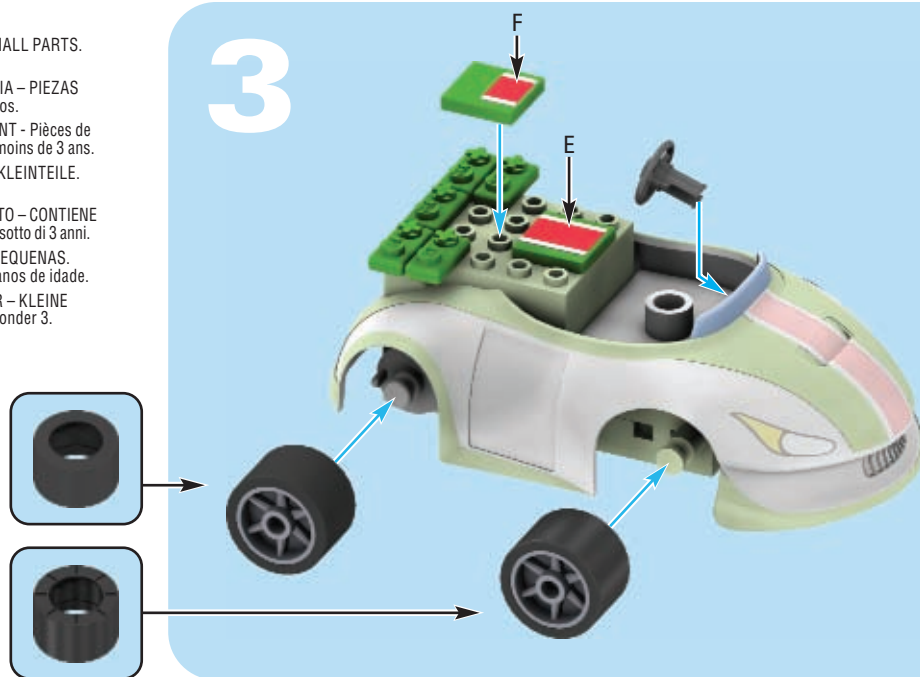

4



# 1

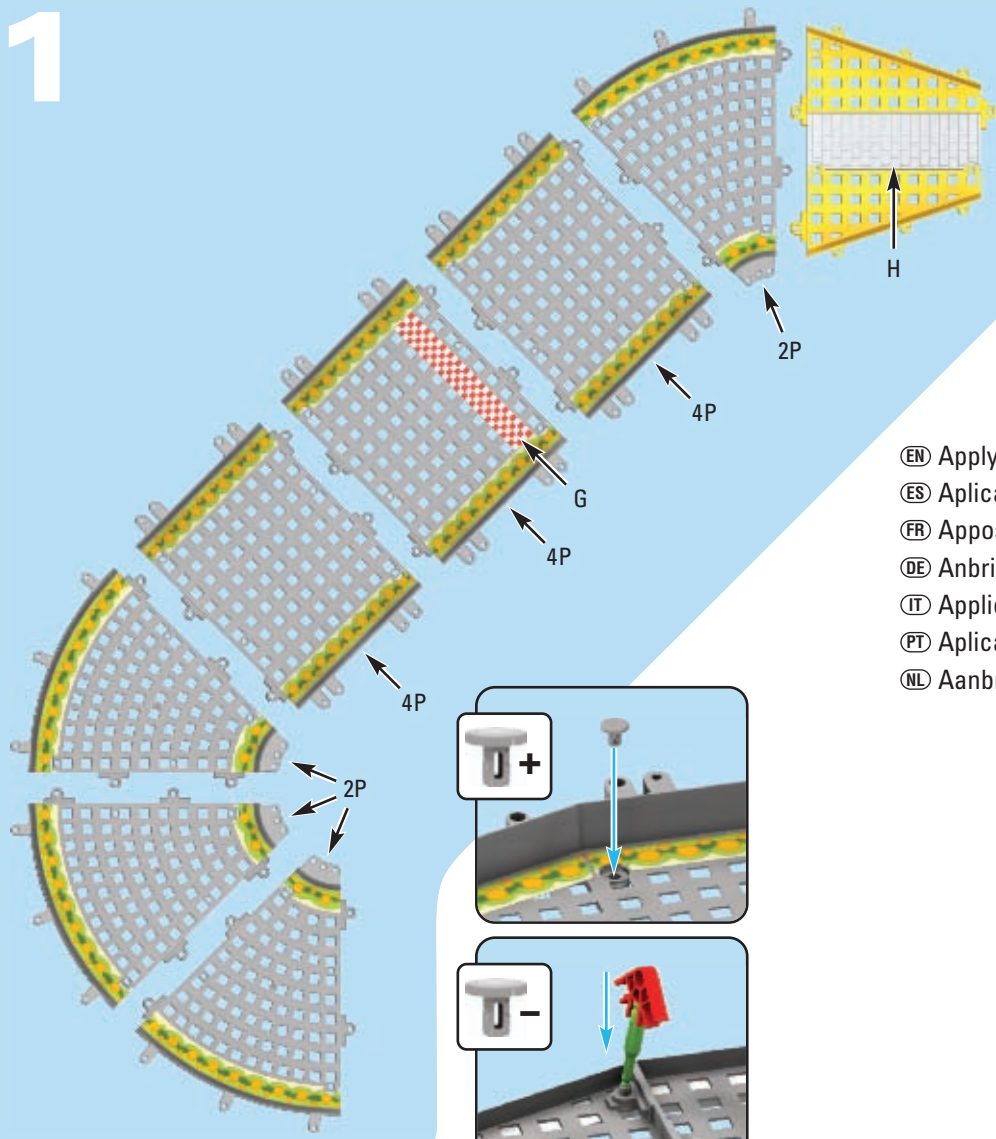

- Ⓔ Apply stickers
- Ⓔ Aplicar pegatinas
- Ⓔ Apposez des autocollants
- Ⓔ Anbringen von Aufklebern
- Ⓔ Applicare gli adesivi
- Ⓔ Aplicar adesivos
- Ⓔ Aanbrengen stickers

# 2

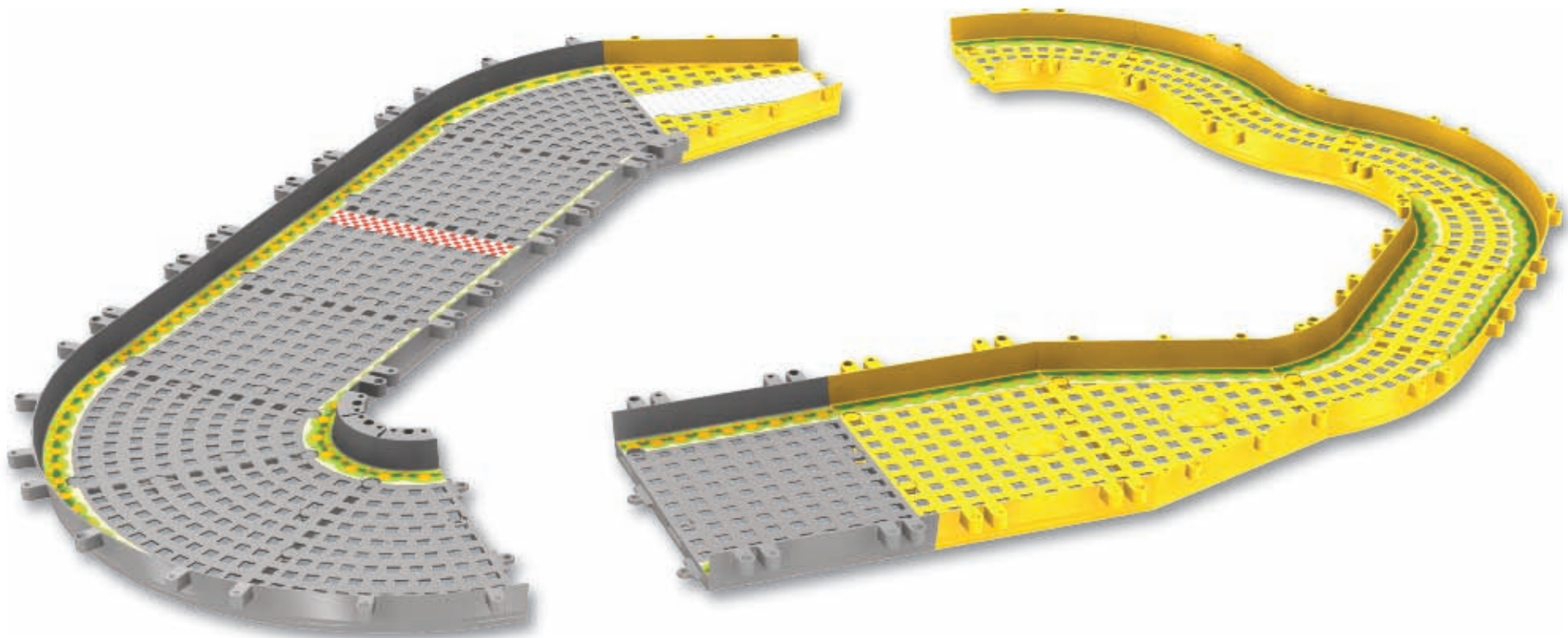
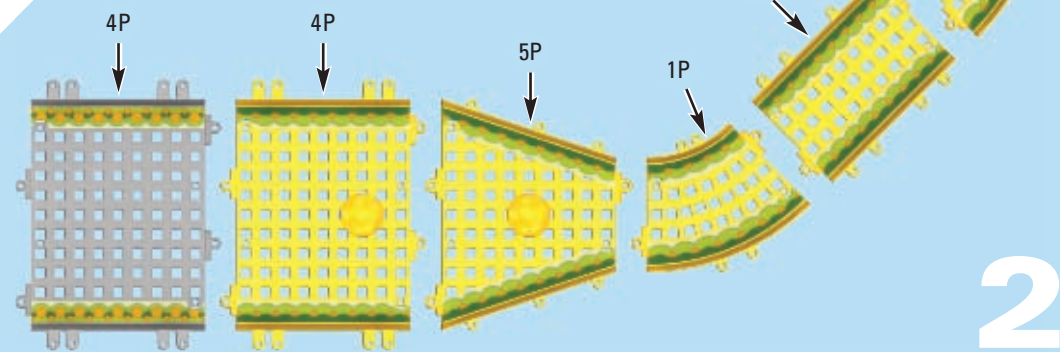
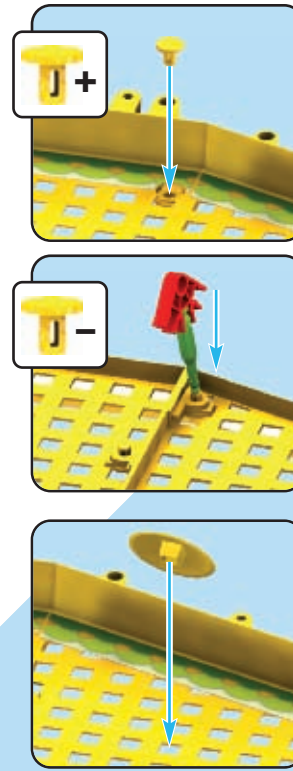

3



4

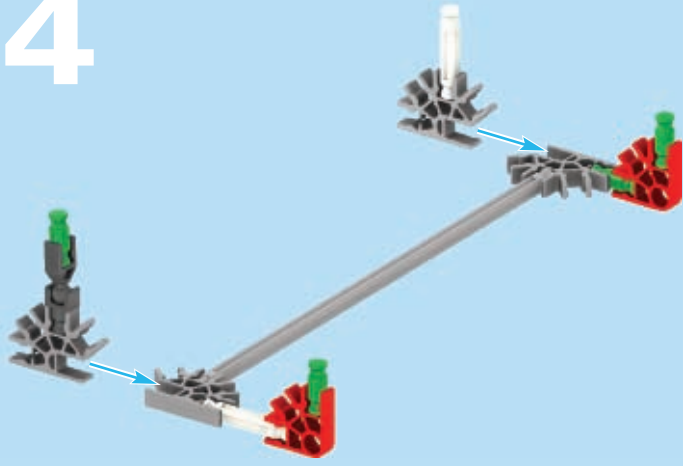

5

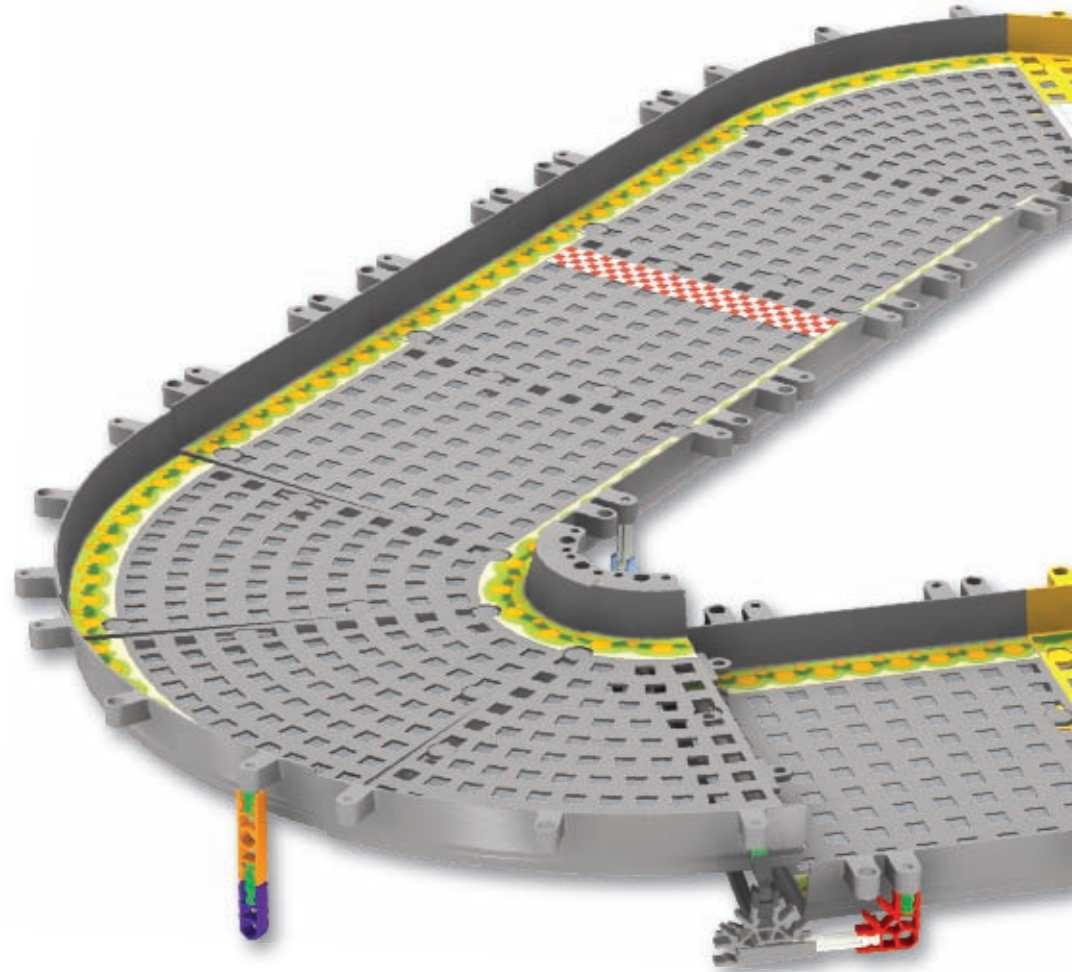
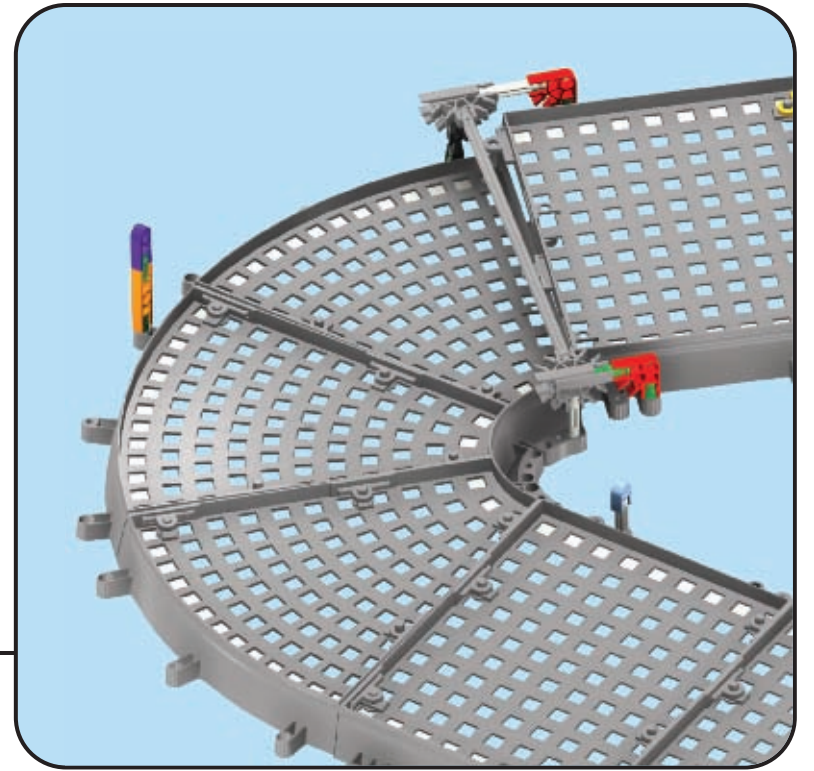
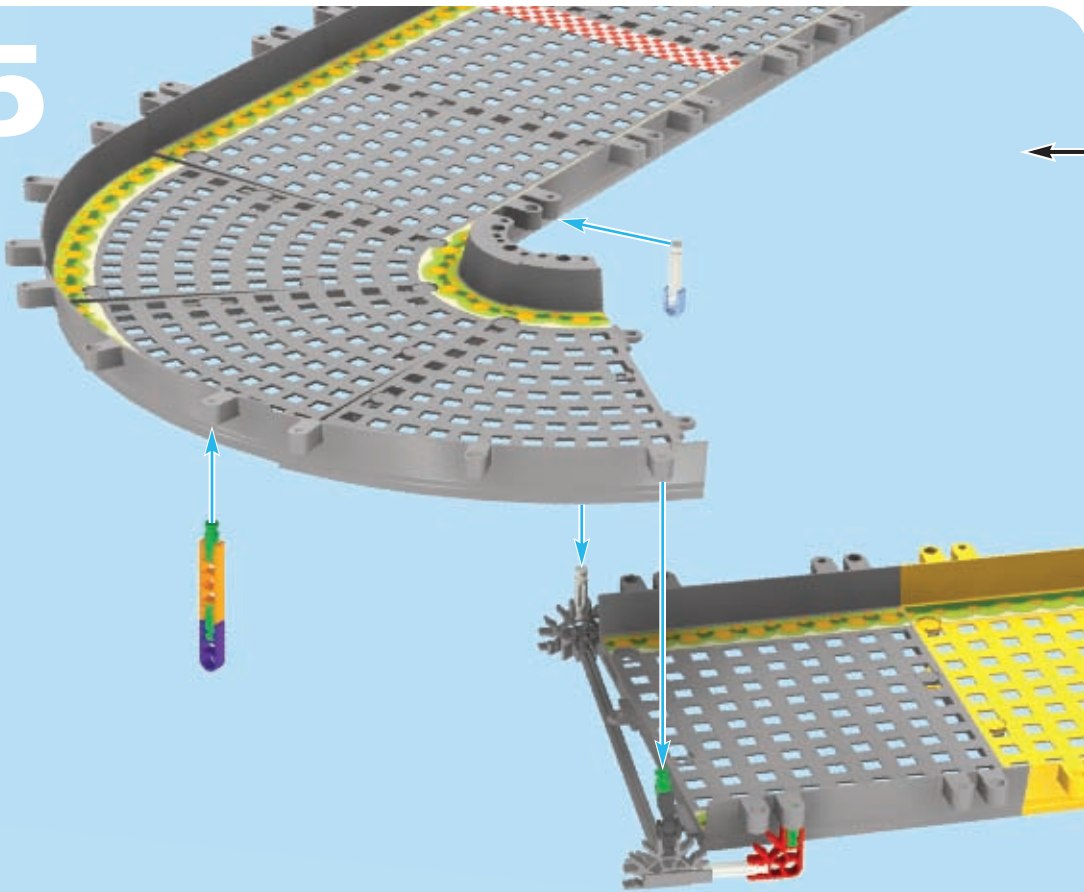

6

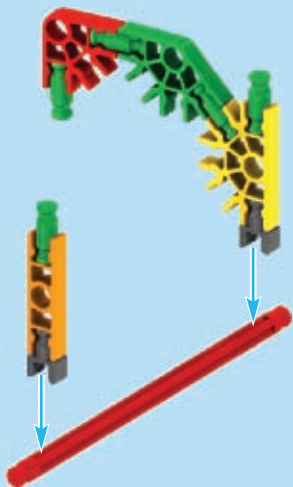

7



8

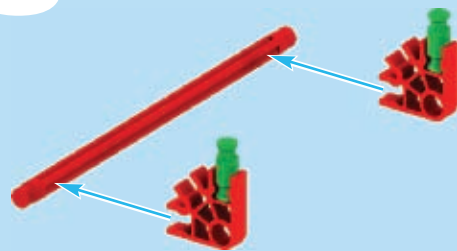

9

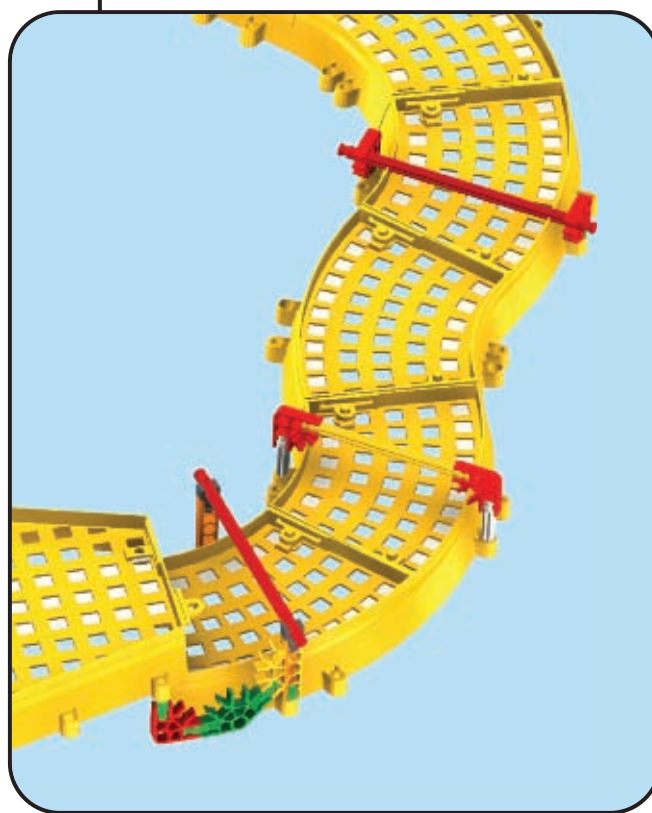
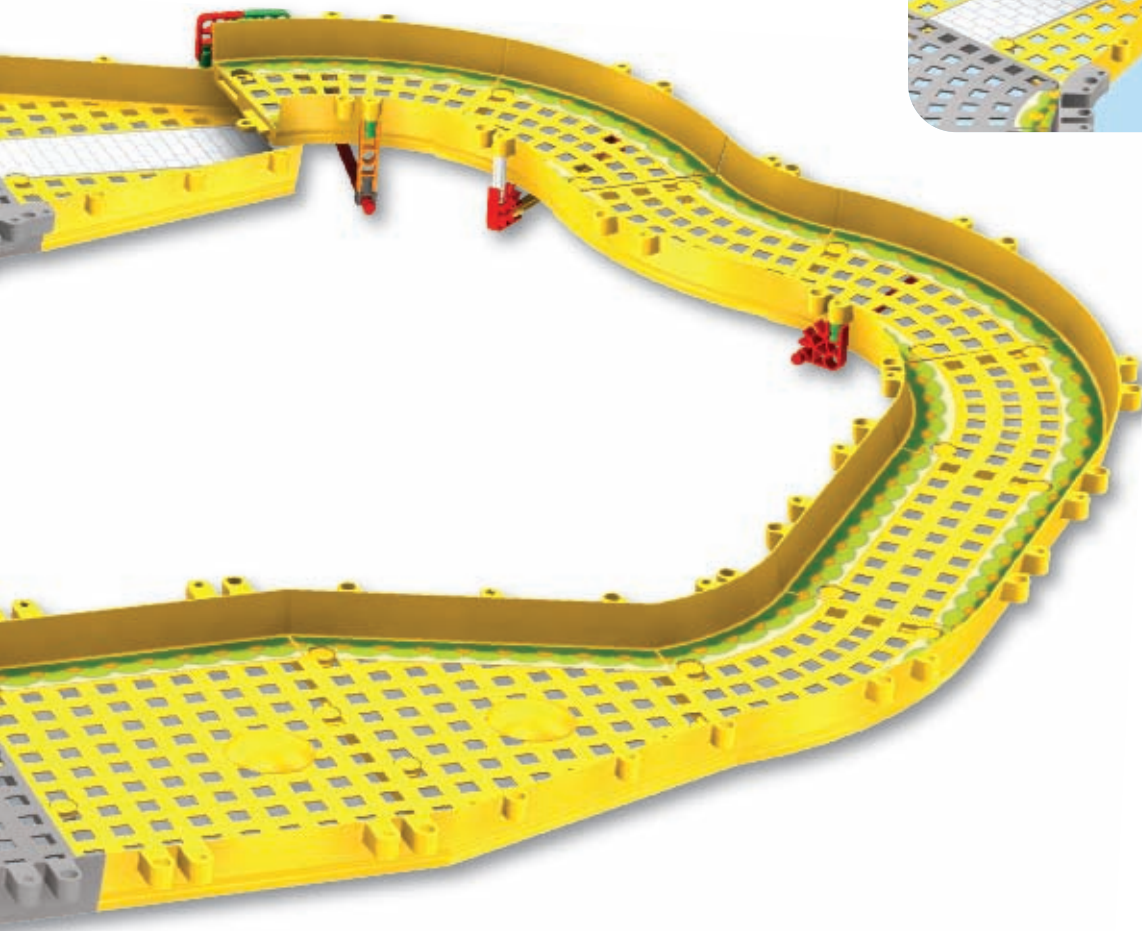
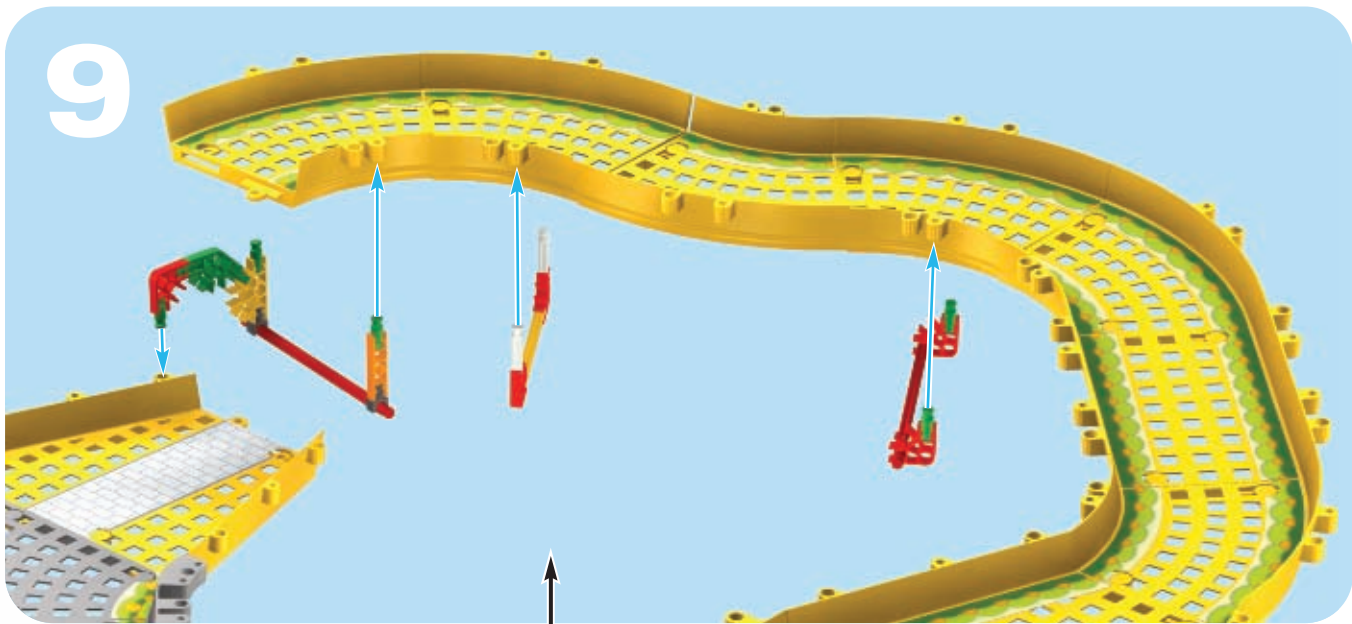

1

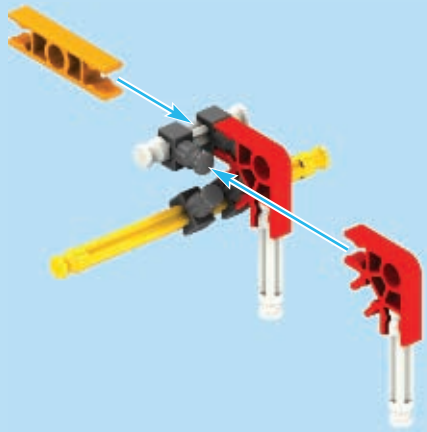

x2

2

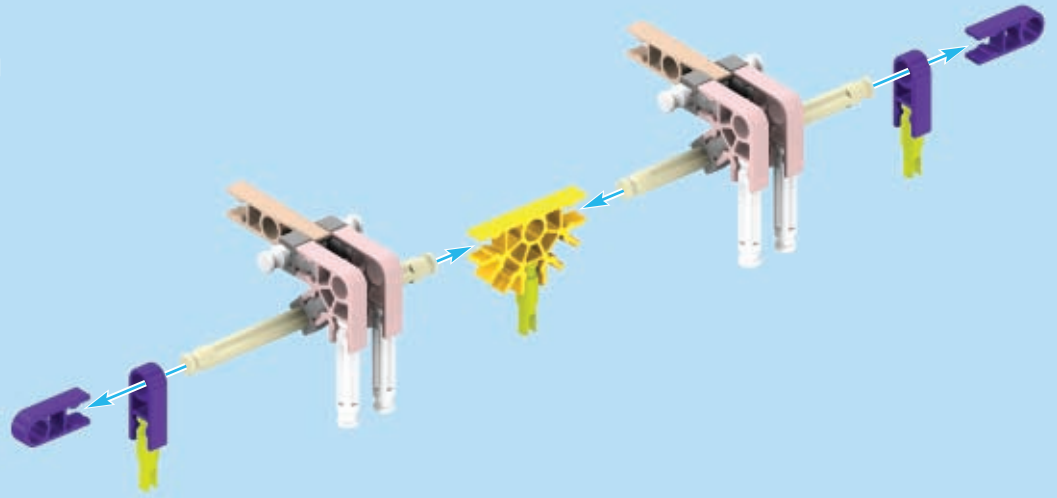

3

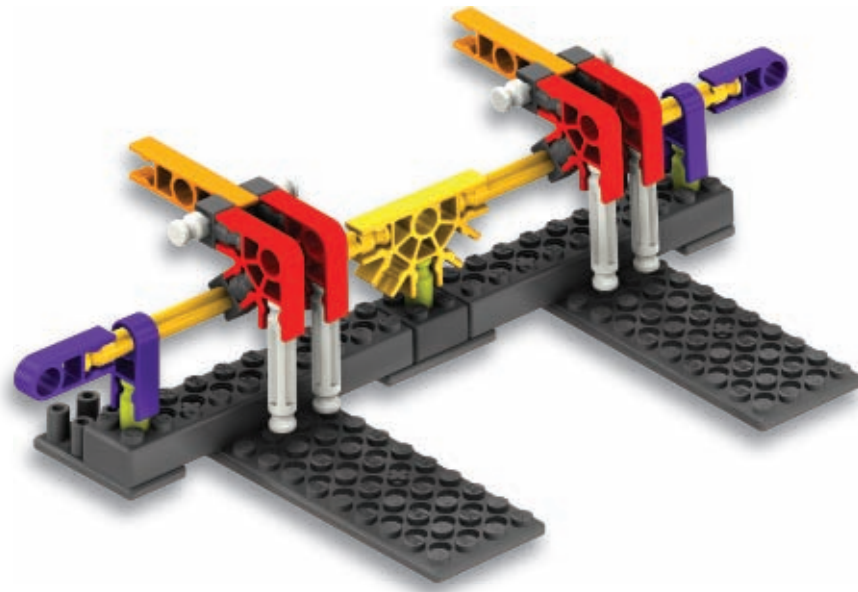
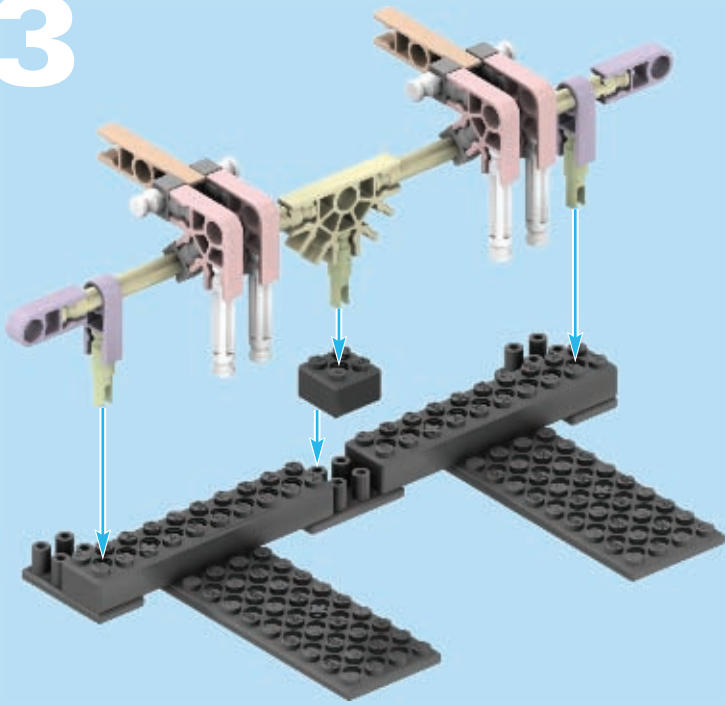

1



2



3



1

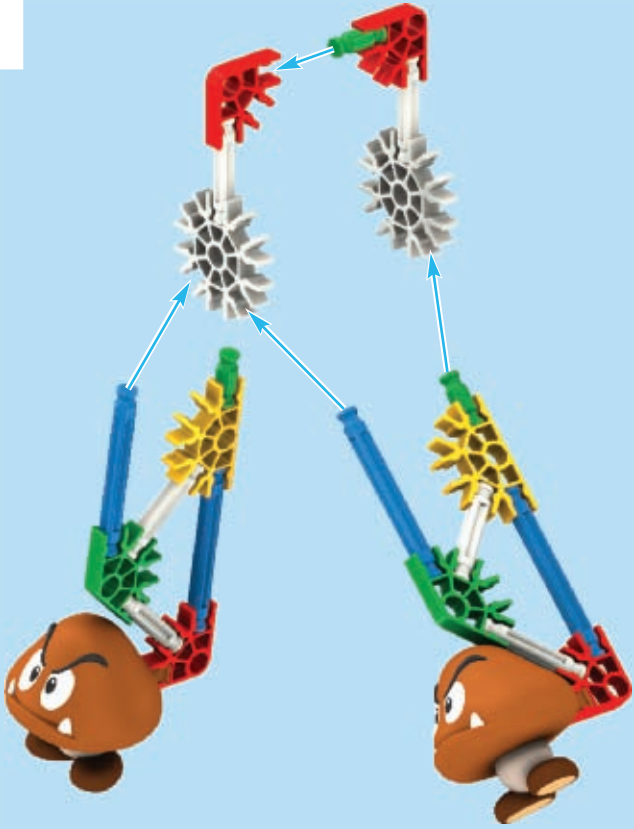

2

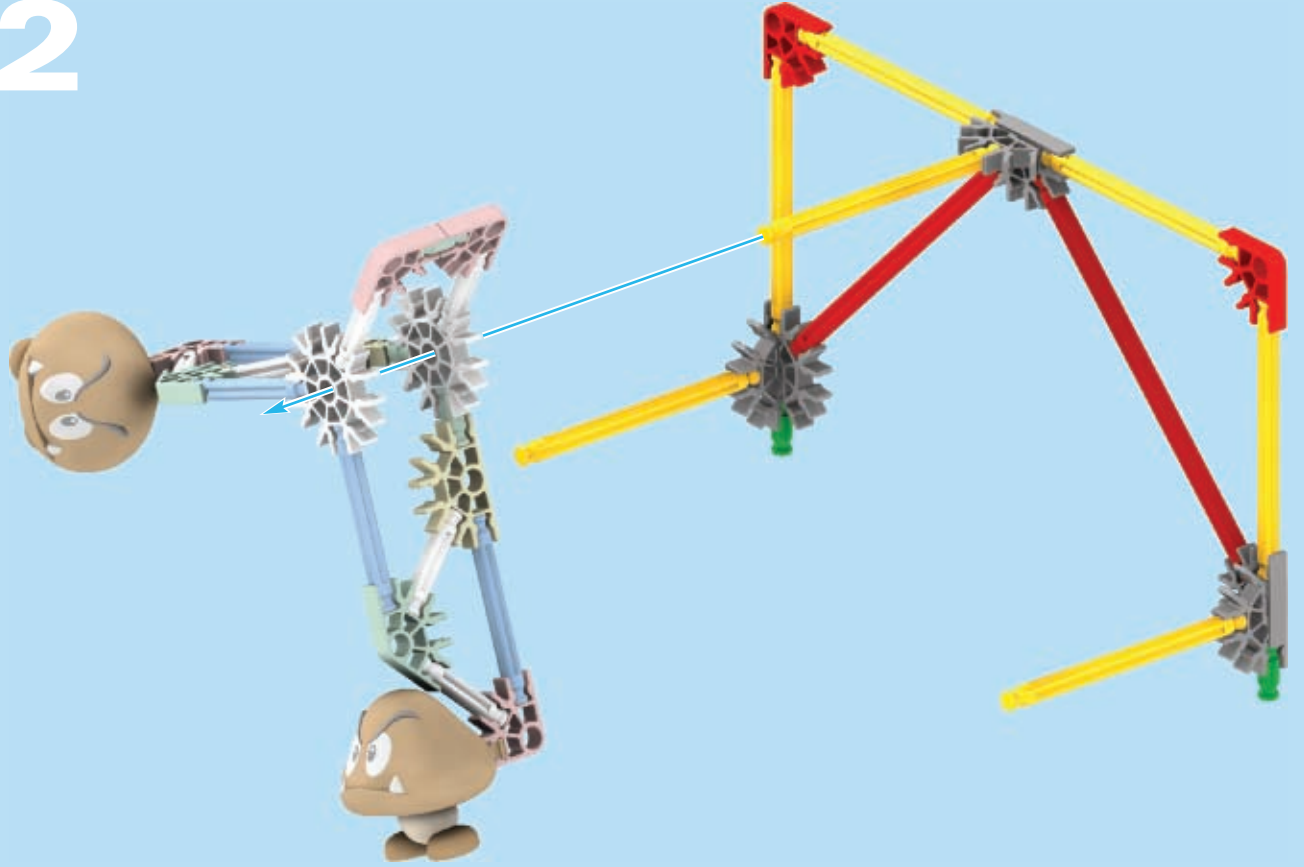

3

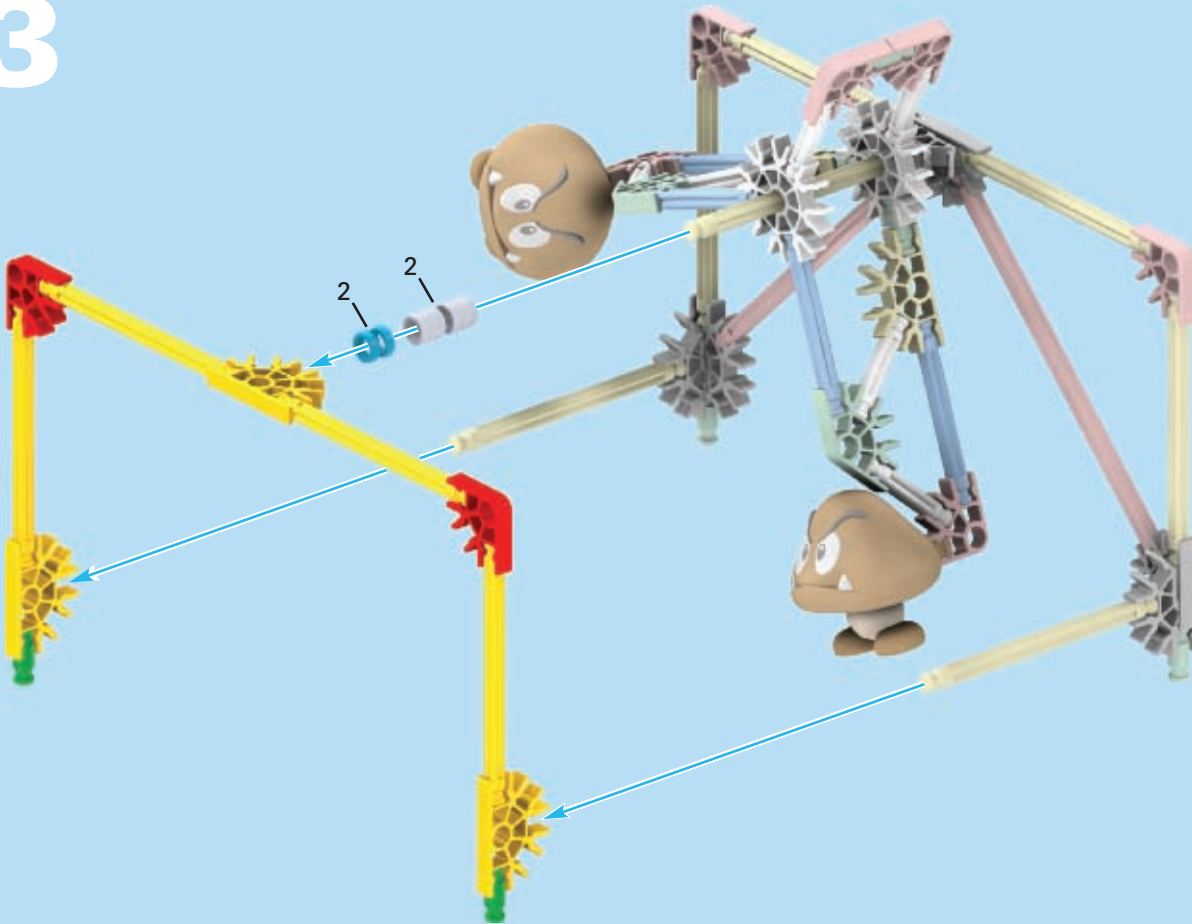

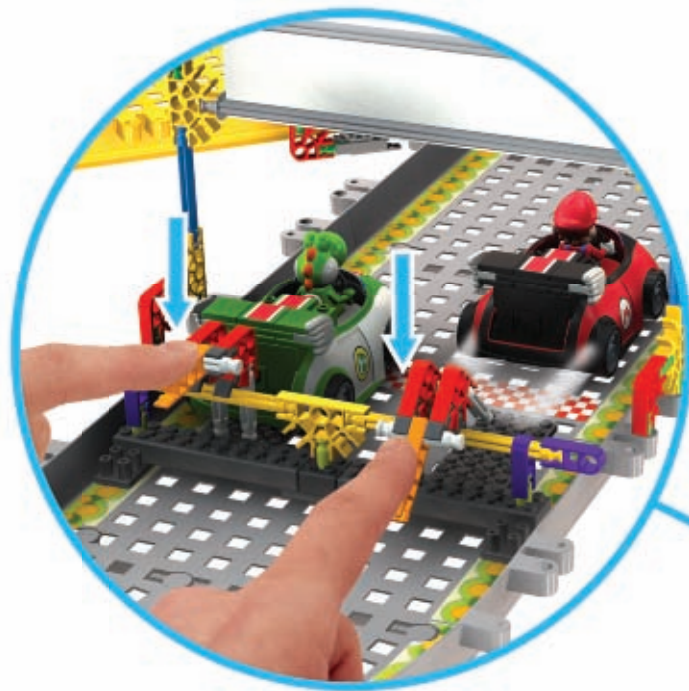

1

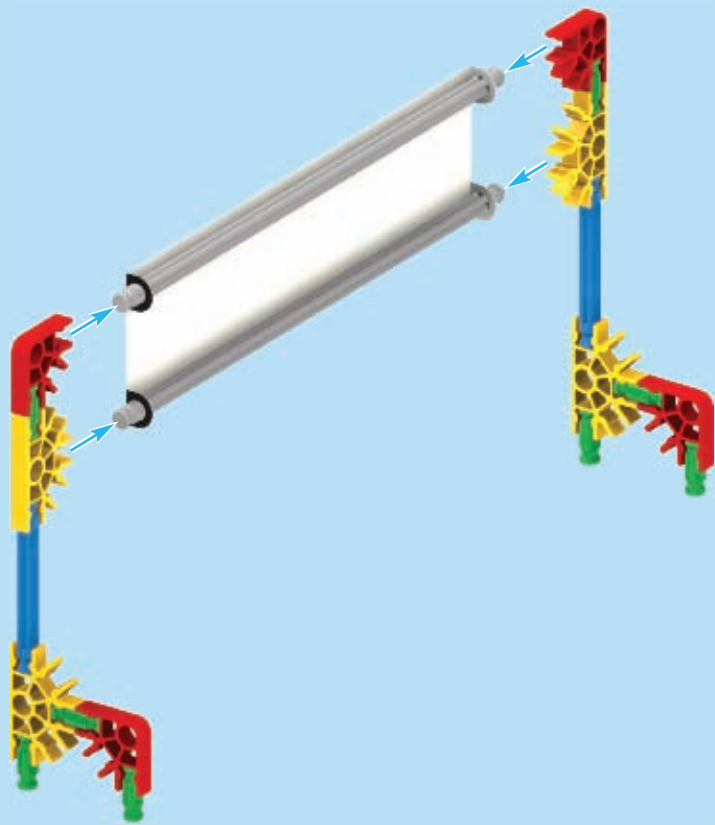

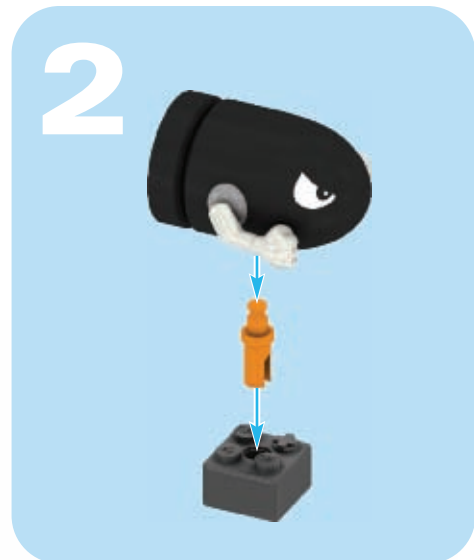
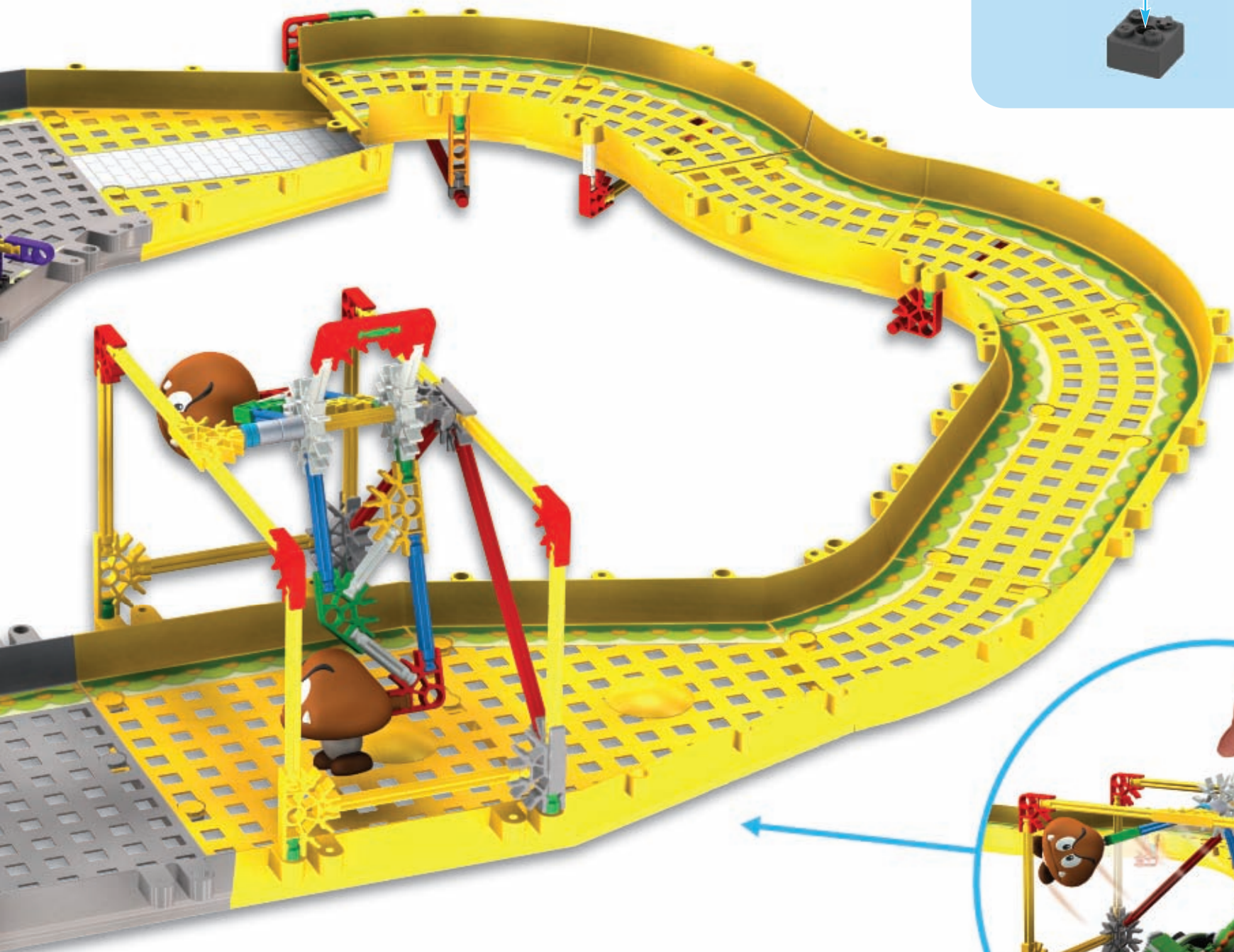

# MARIOKART™ Wii

Collect all the Mario Kart™ Wii building sets to create your own tracks!

¡Recoja todos los sistemas del edificio de Mario Kart™ Wii para crear sus propias pistas!

Rassemblez tous les ensembles de bâtiment de Mario Kart™ Wii pour créer vos propres voies!



[www.knex.com/mariokartwii](http://www.knex.com/mariokartwii)

TM & © 2011 Nintendo.

K'NEX is a registered trademark of K'NEX Limited Partnership Group. Product & colors may vary. Standard K'NEX parts made in the USA. Special components made in China. (ES) K'NEX es una marca registrada de K'NEX Limited Partnership Group. El producto y los colores pueden variar. Piezas estándar de K'NEX hechas en EE.UU. Componentes especiales hechos en China. (FR) K'NEX est une marque déposée de K'NEX Limited Partnership Group. Produits et couleurs peuvent varier. Pièces K'NEX courantes fabriqués aux États-Unis. Éléments spéciaux fabriqués en Chine.

©2011 K'NEX Limited Partnership Group, P.O. Box 700, Hatfield, PA 19440-0700; [www.knex.com](http://www.knex.com); 1-800-KID-KNEX (USA/EE.UU./États-Unis/Canada); [email@knex.com](mailto:email@knex.com). Customers outside USA/Canada contact your local distributor at [www.knex.com/distributors](http://www.knex.com/distributors). (ES) El cliente que no vive en EE.UU./Canadá se pone en contacto con el distribuidor local. Encuentre la información para el distribuidor local en [www.knex.com/distributors](http://www.knex.com/distributors). (FR) Le Service clients hors États-Unis/Canada, s'il vous plaît contacter le distributeur local. L'information de distributeur peut être trouvée à [www.knex.com/distributors](http://www.knex.com/distributors). (UK) Tel 023 8066 2600; [www.tomy.co.uk](http://www.tomy.co.uk) (FR) Tél 0 820 013 013 ; [www.tomy.fr](http://www.tomy.fr) (DE) [www.tomy.de](http://www.tomy.de) (AZ) (NZ) (NL) (BE) (CH) (CL) (PE) [www.knex.com/distributors](http://www.knex.com/distributors)

- Identifies Genuine K'NEX Bricks.
- Identifica los ladrillos genuinos de K'NEX.
- Identifie que ce sont d'authentiques briques K'NEX.
- Identifiziert echte K'NEX-Bausteine.
- Edentifica i veri blocchi K'NEX.
- Identifica que são cubos genuinos da K'NEX.
- Identificeert K'NEX bakstenen voor.

[facebook.com/buildknex](https://facebook.com/buildknex)

TOMY S040  
3SA England

138471-V1-06/11

