

K'NEX

Building Worlds Kids Love

SUPER MARIO



CAT MARIO™
BUILDING SET

MARIO CHAT
JEU DE CONSTRUCTION

KATZE MARIO
BAUSATZ

KAT MARIO
BOUWSET



CLEAR WARP PIPE!
TUYAU TRANSLUCIDE !
DURCHSICHTIGE WARP-RÖHRE!
TRANSPARANTE WARPBUIS!‡



CAT MARIO™
MARIO CHAT

MOUSE
SOURIS

LIMITED EDITION!
ÉDITION LIMITÉE !
LIMITED EDITION!
BEPERKTE UITGAVE!‡



8+

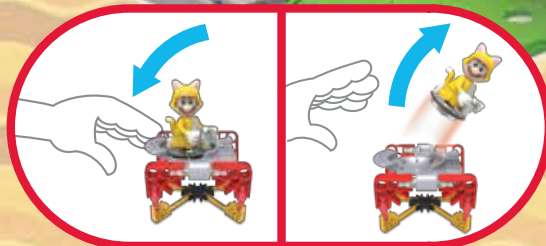

38635/38635ML



1

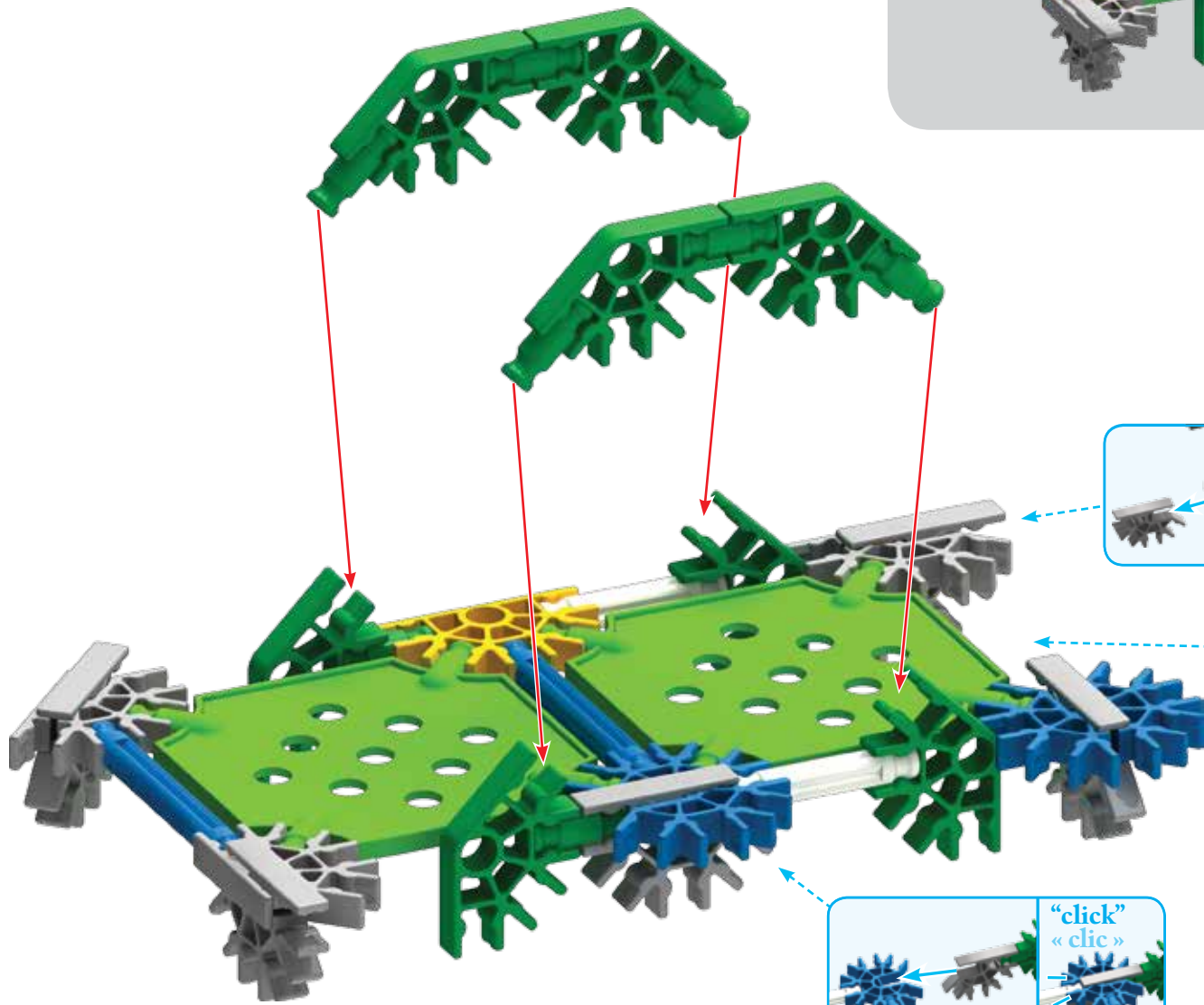
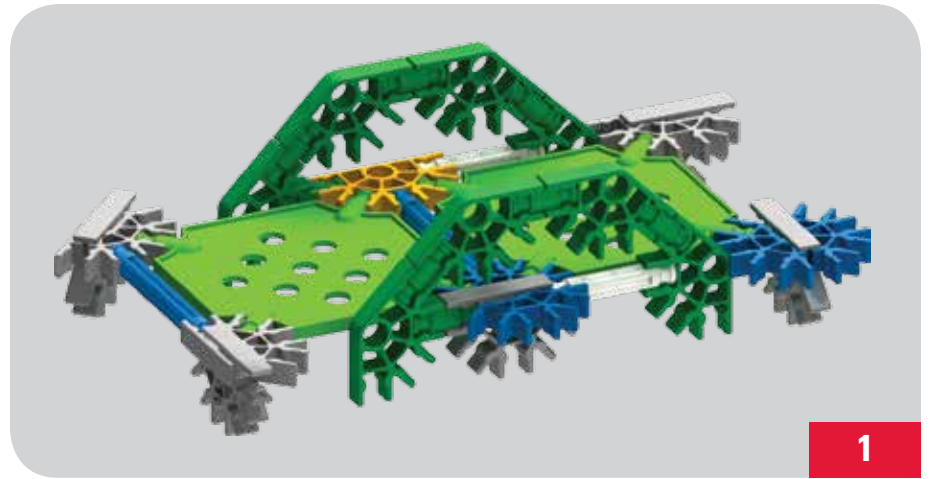

- 2 Green perforated plate
- 2 Blue axle
- 2 Grey axle
- 8 Grey gear
- 8 Green gear
- 8 Yellow gear
- 2 Blue gear
- 1 Yellow gear

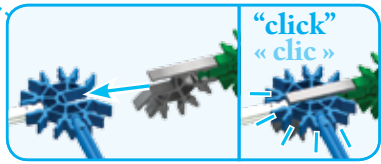
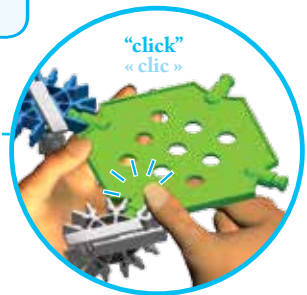

2

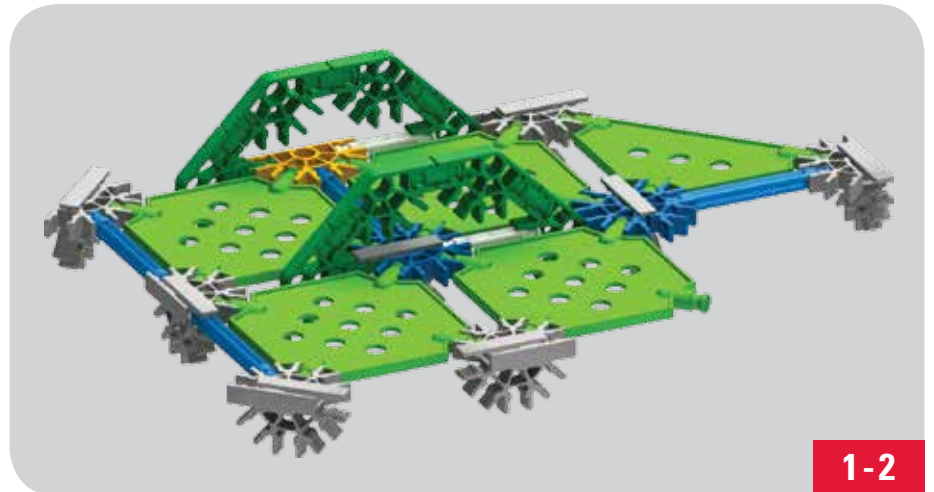
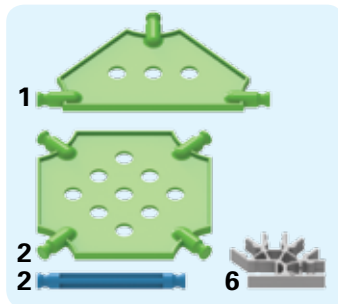
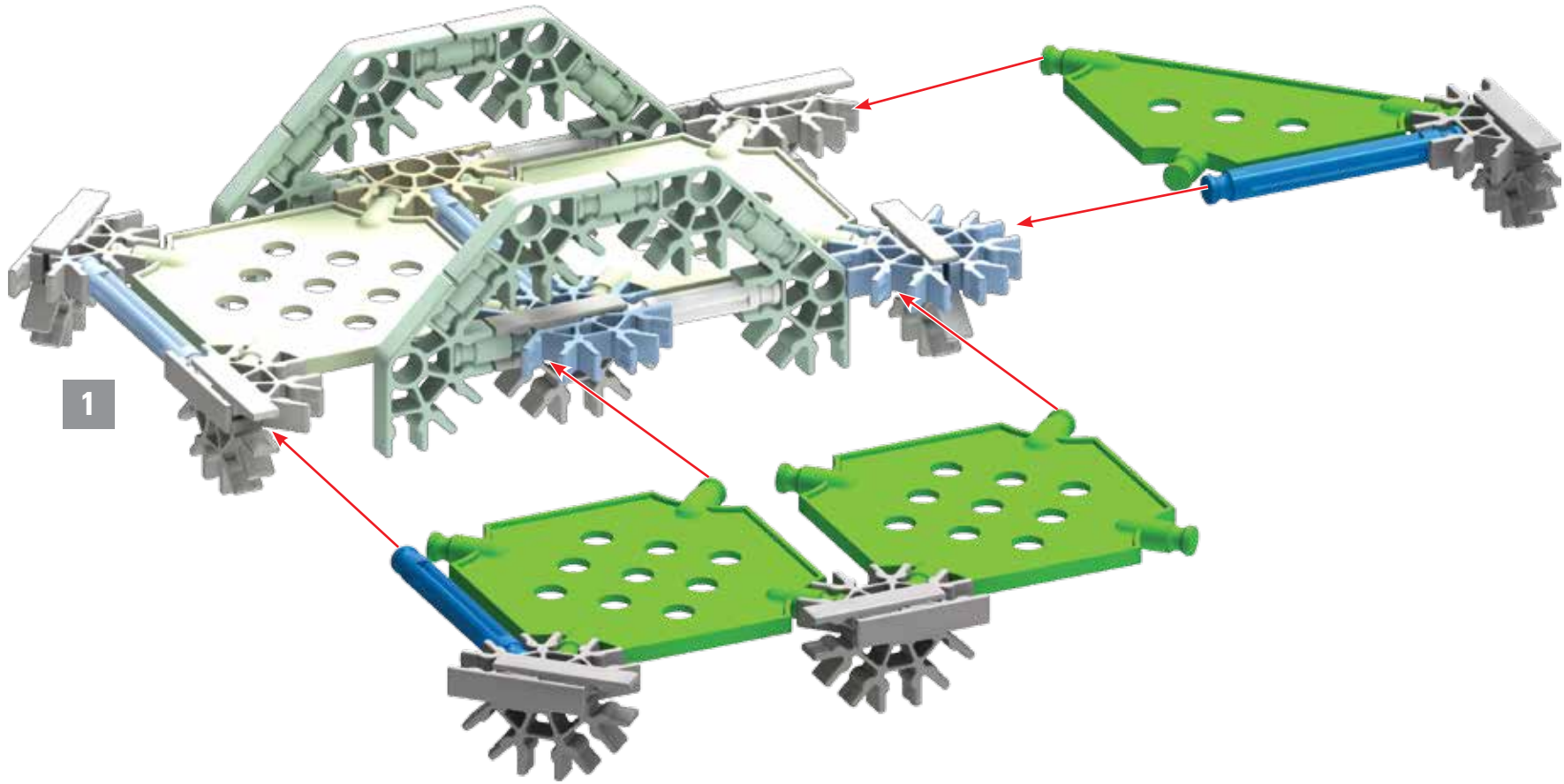

1-2

3

12 
6  4  12 
2 

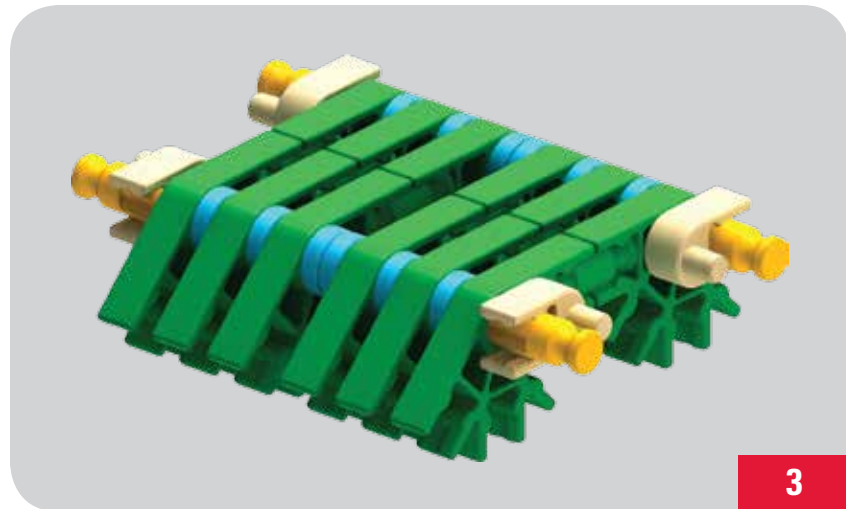

3

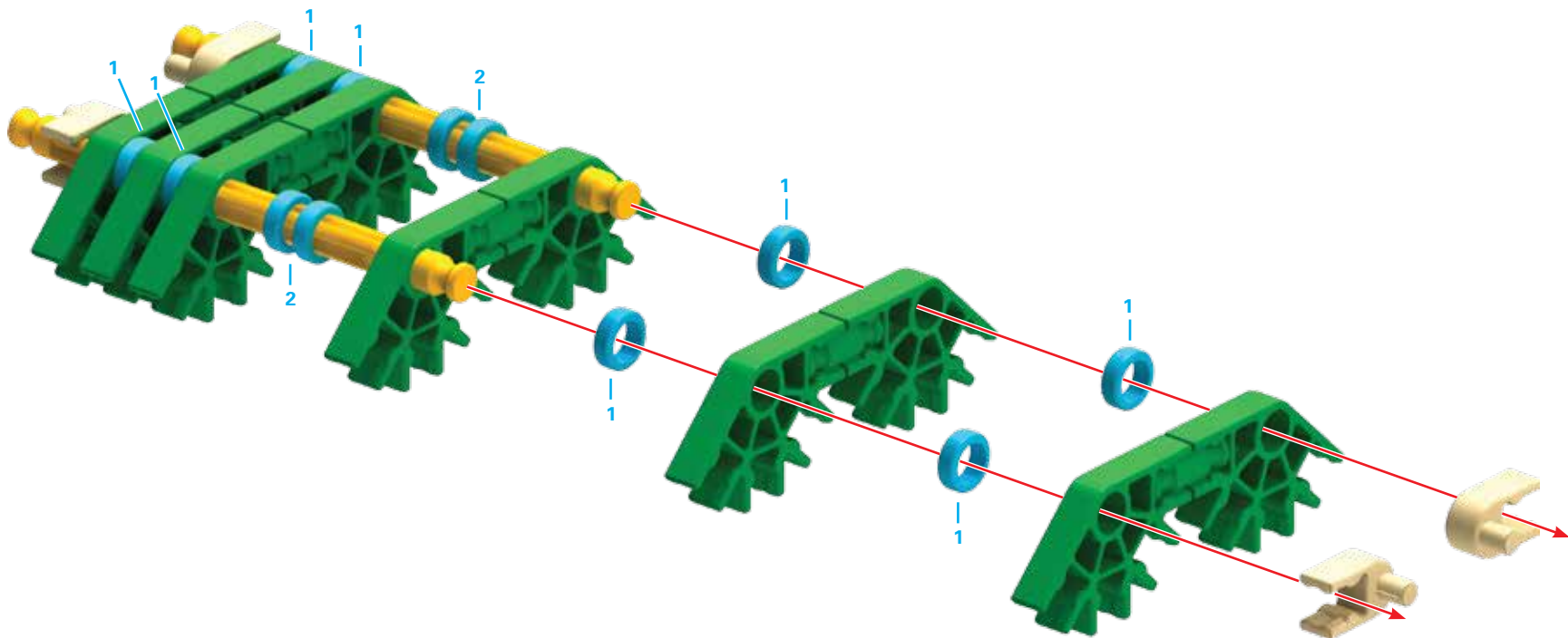

4

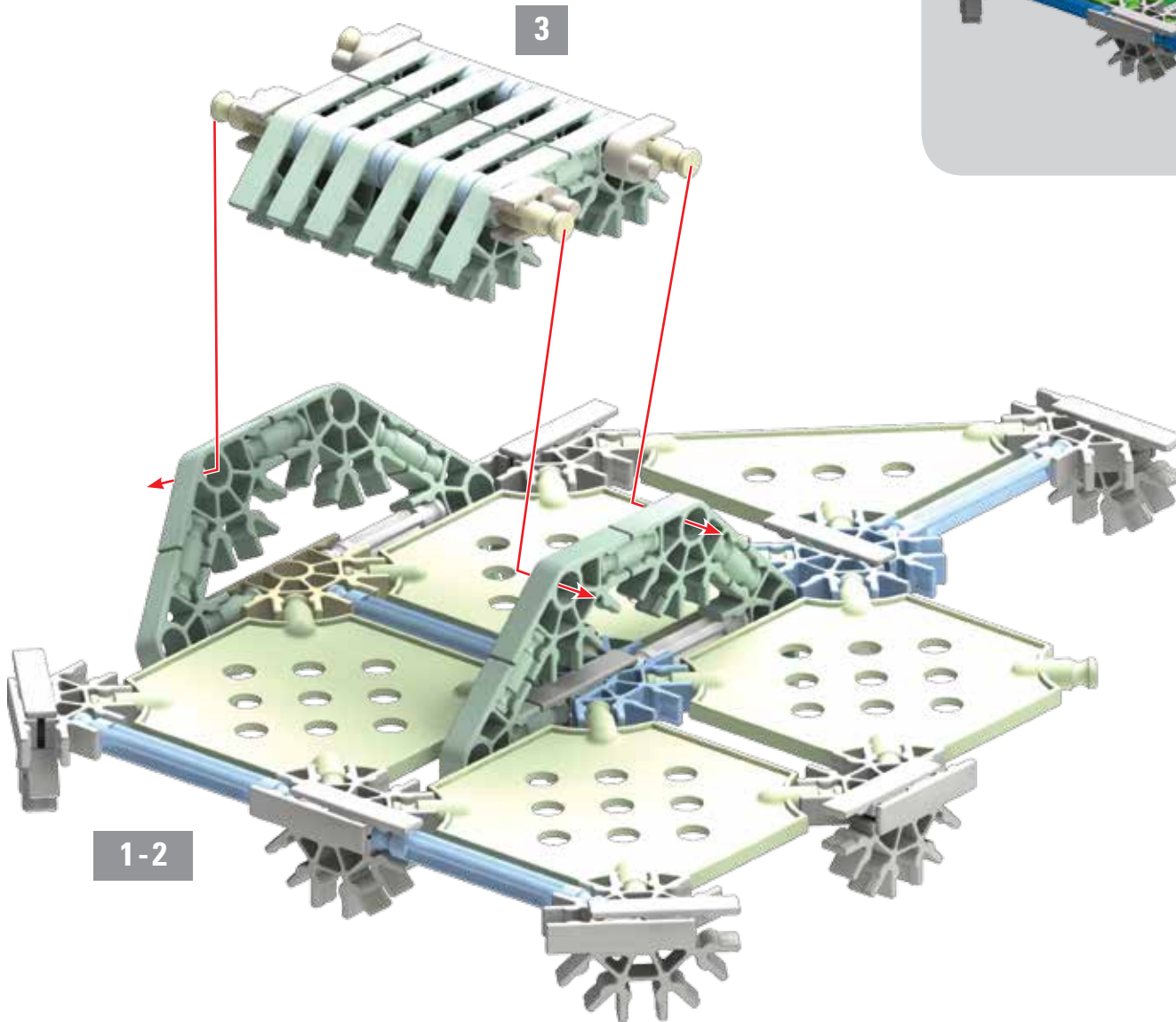

5

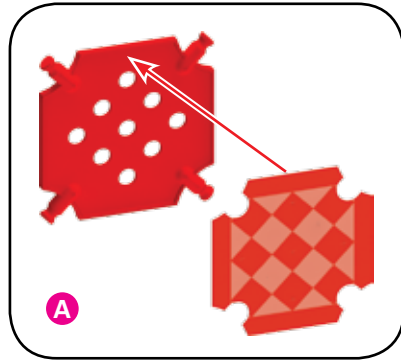

A

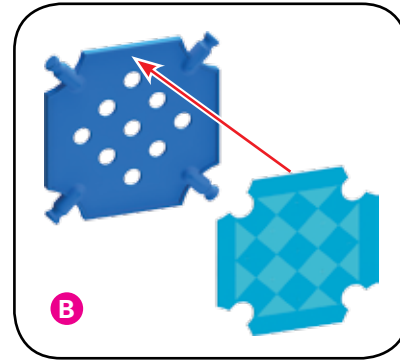

B

- ☒ Apply stickers
- ☒ Appez des autocollants
- ☒ Aplicar pegatinas
- ☒ Bringe die Aufkleber an
- ☒ Applicare gli adesivi
- ☒ Aplicar adhesivos
- ☒ Stickers plakken



5

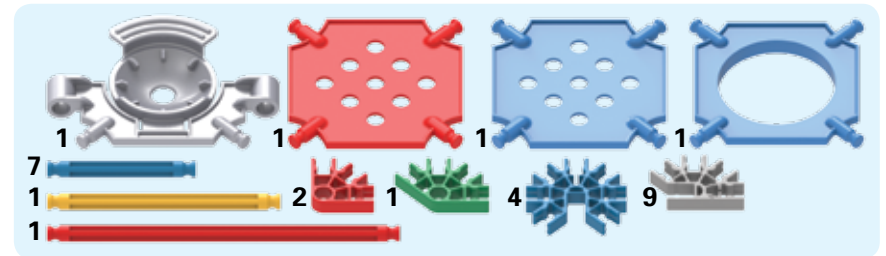
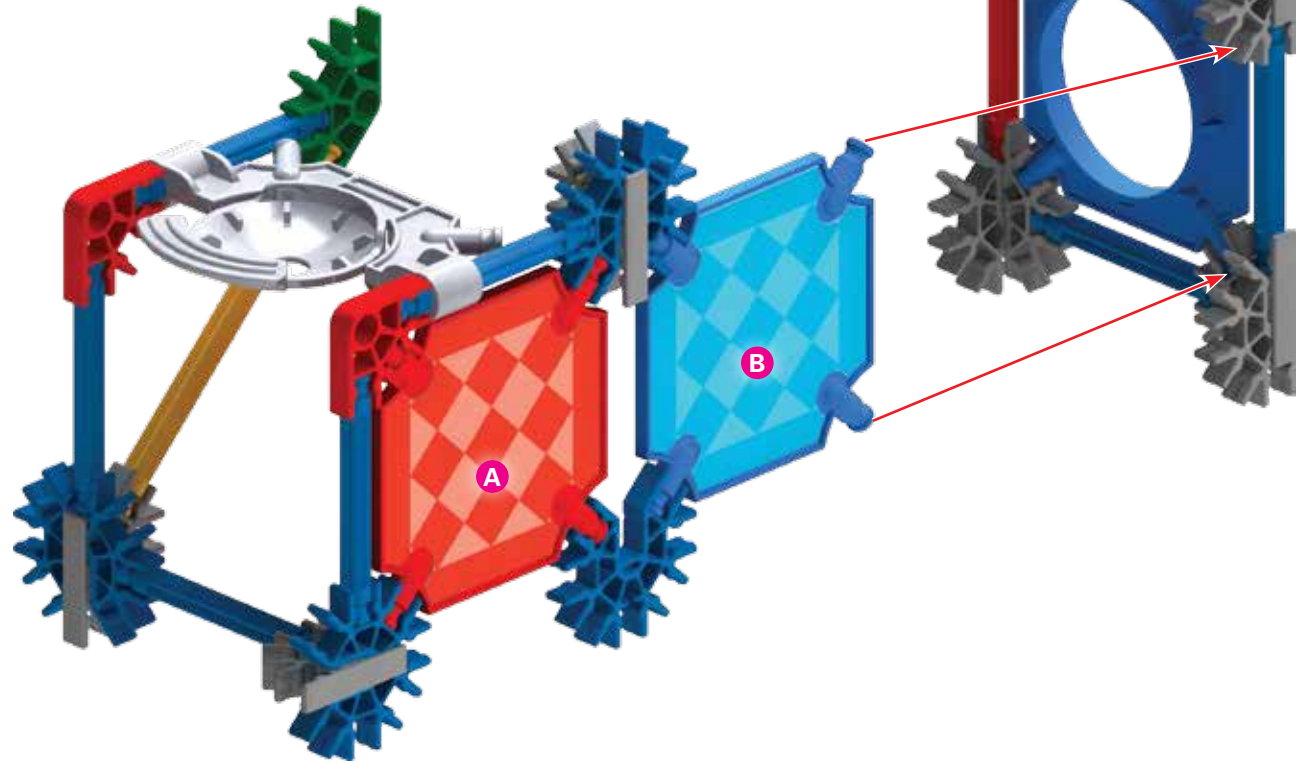

7

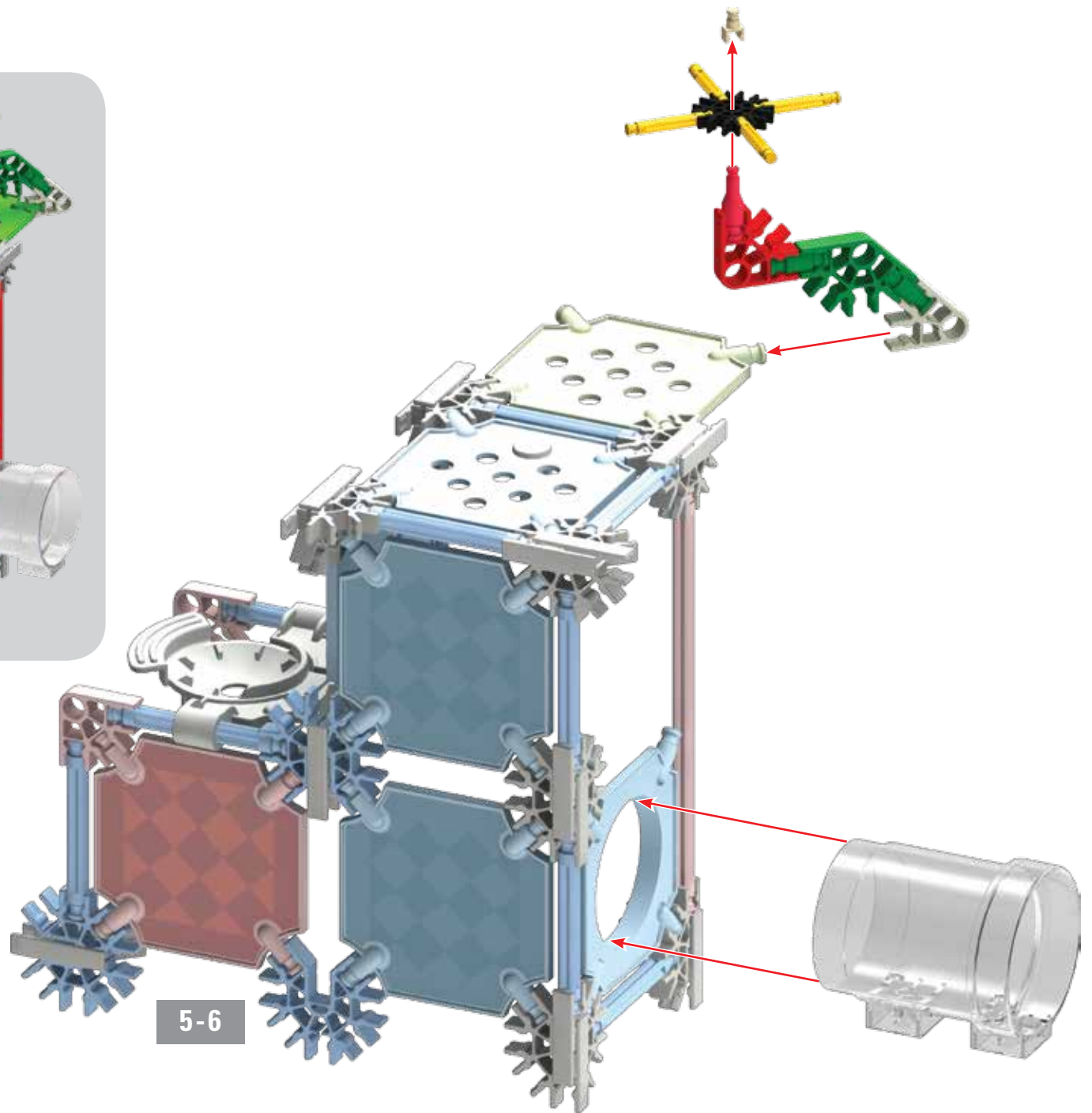
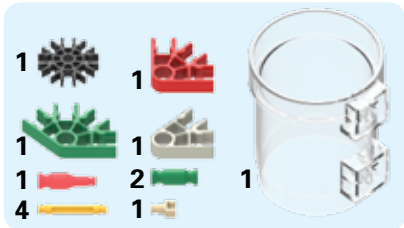

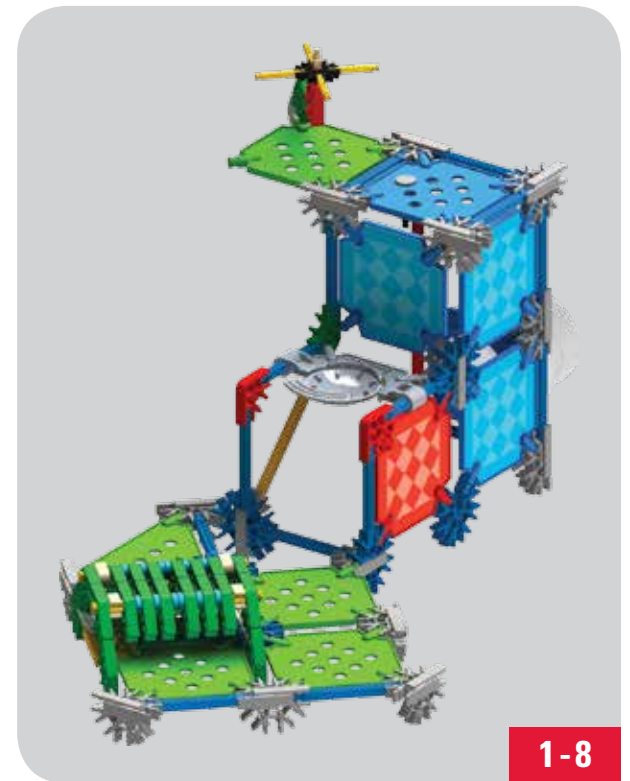
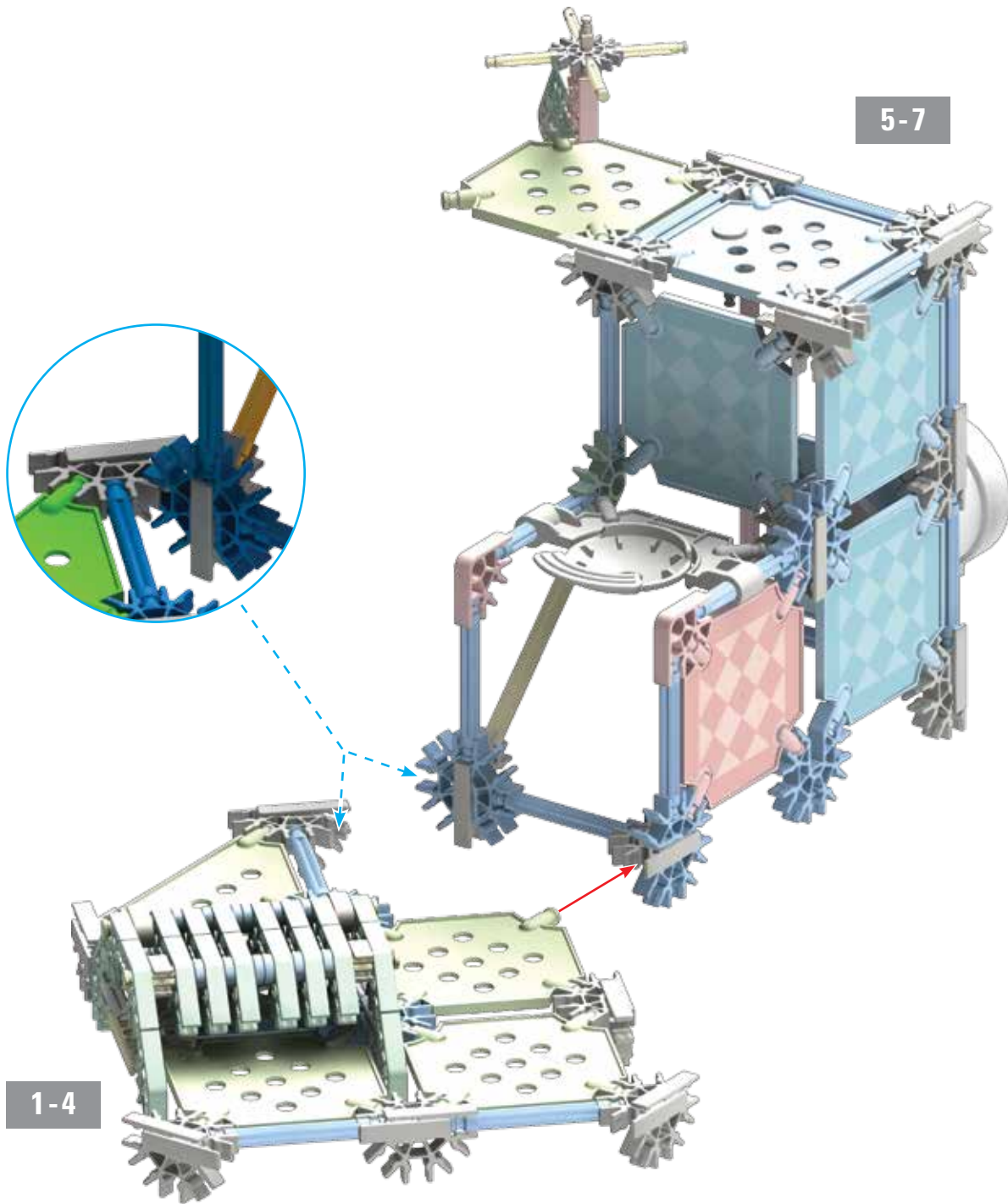

9

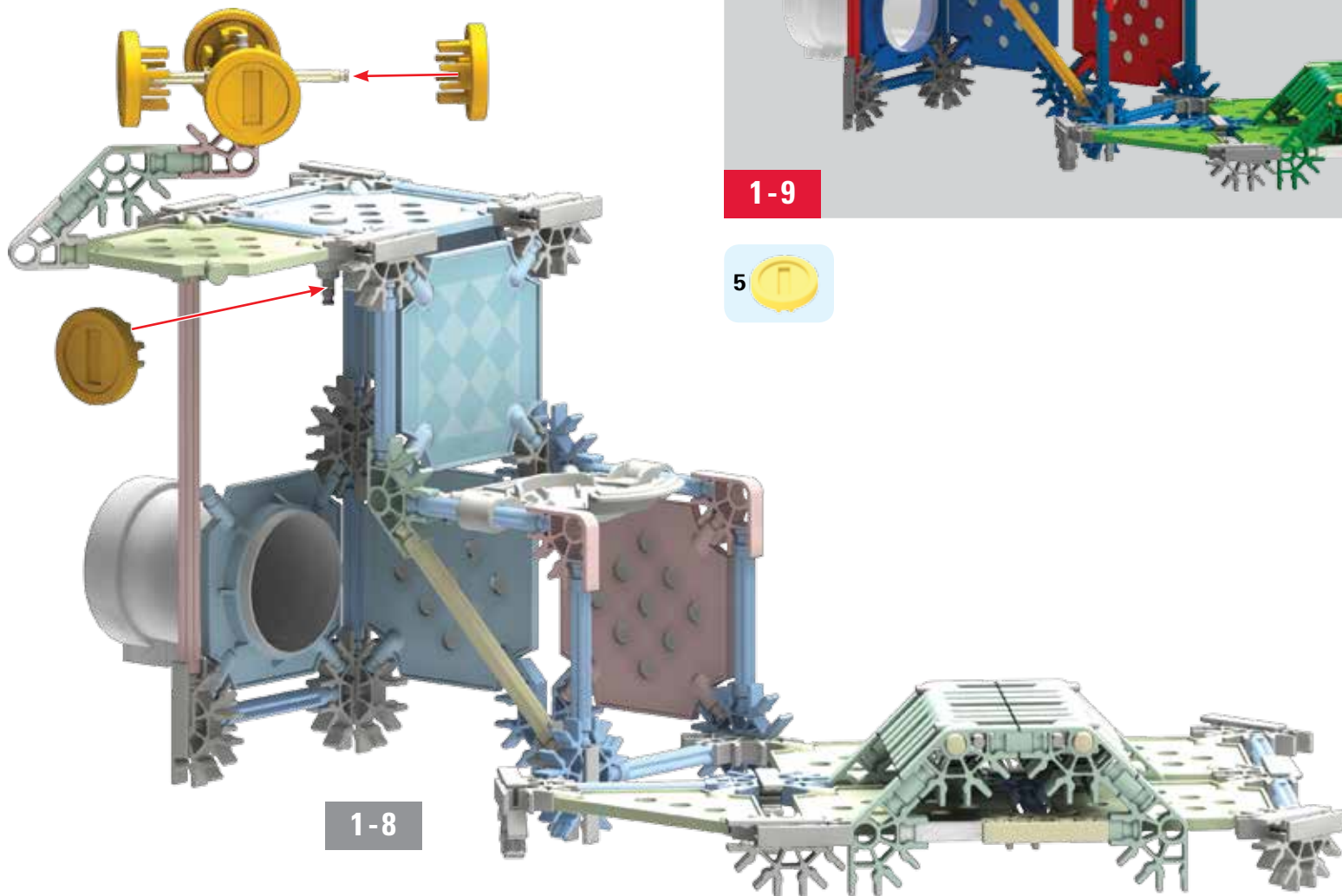

10

- 6
- 5
- 4
- 2
- 2
- 3
- 7

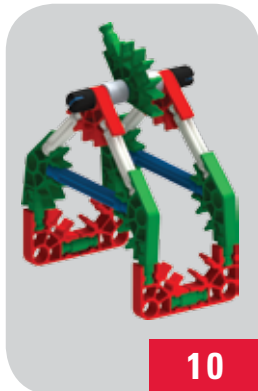
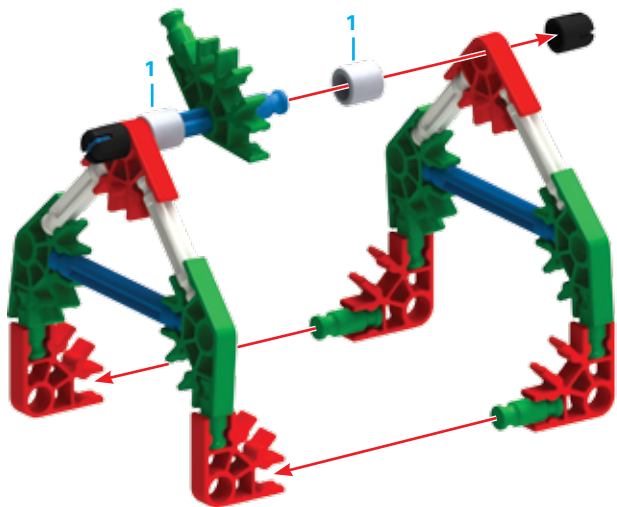

10

11



10-11

- 1
- 1
- 1
- 1
- 1
- 1

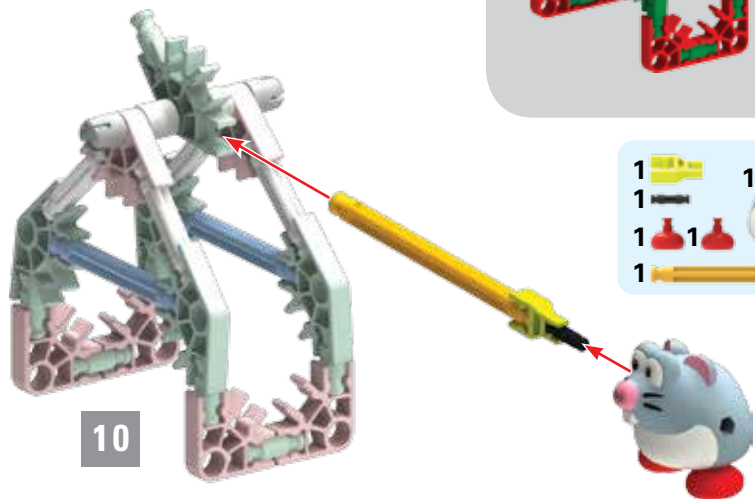

10



10-11

1-9

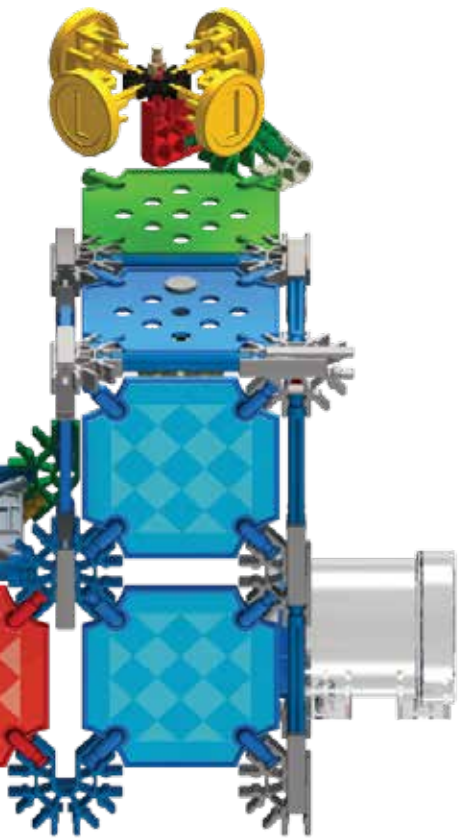

12

12

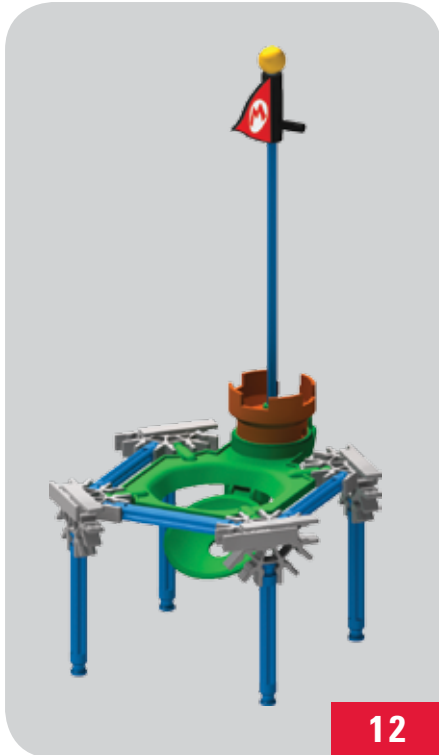

12

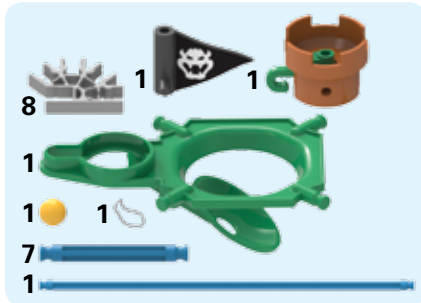
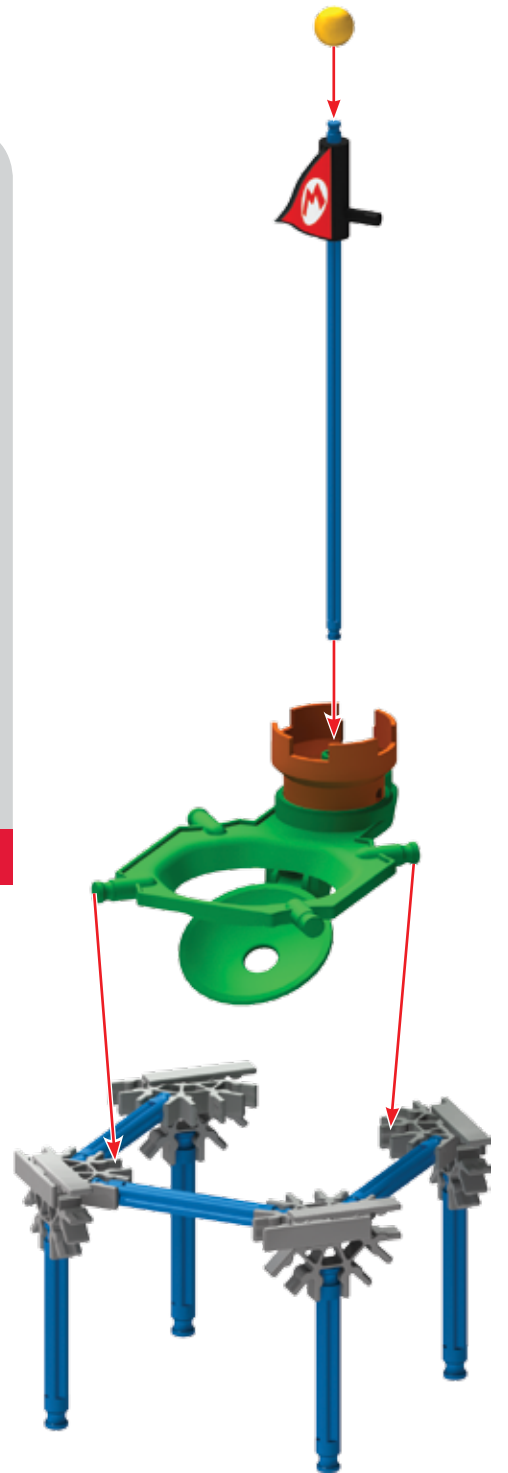



KNEX.COM

Sold separately
Vendus séparément
Se venden por separado
Separat erhältlich
Venduti separatamente
Vendidos separadamente
Afzonderlijk verkrijgbaar



13

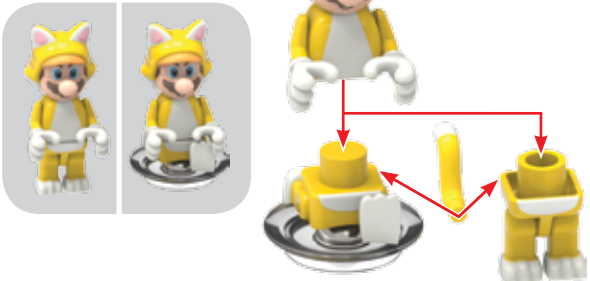

14

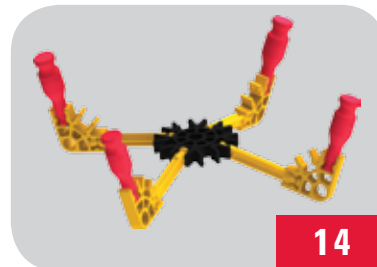
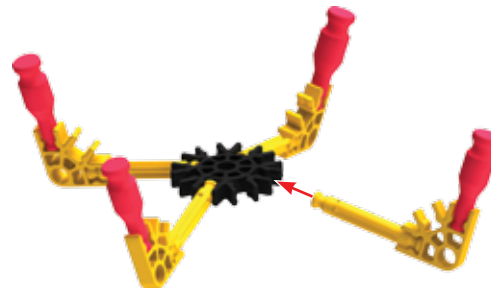

15

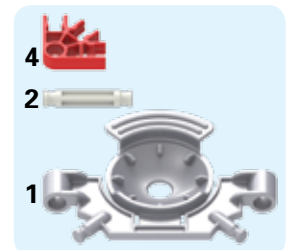
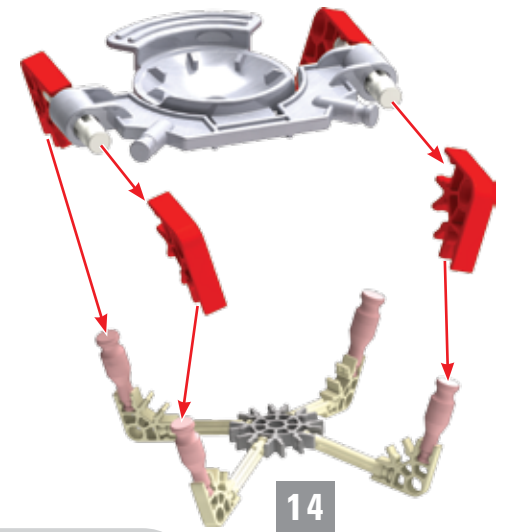

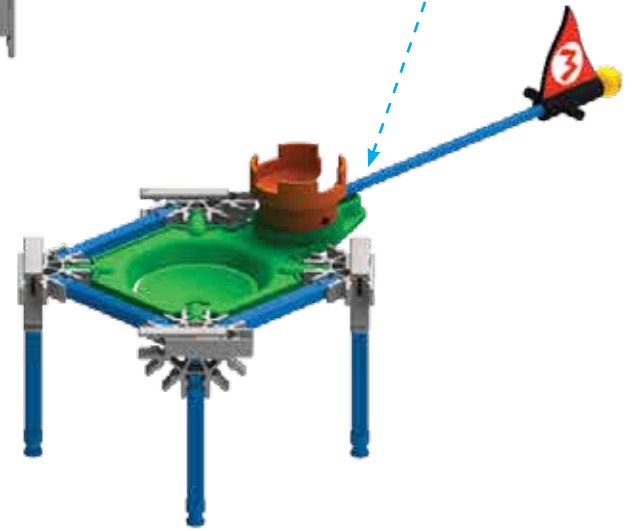
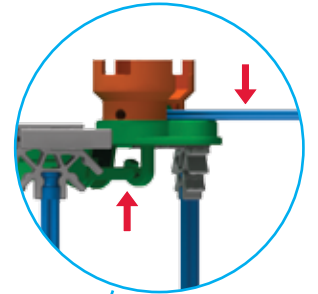
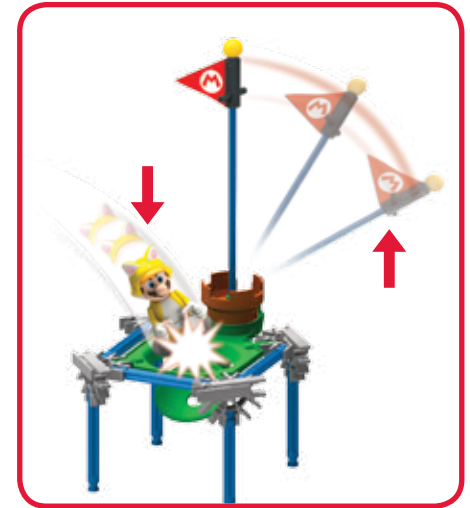

(EN) Keep this important information for future reference.

(FR) Gardez précieusement cette notice pour t'y référer ultérieurement.

(ES) Guarde esta información importante para futuras referencias.

(DE) Informationen für später aufbewahren.

(IT) Conservare queste importanti informazioni per riferimento futuro.

(PT) Manter esta informação importante para referência futura.

(NL) Bewaar deze belangrijke informatie, zodat u deze in de toekomst opnieuw kunt raadplegen..

(EN) **CAUTION:** Rubber Bands can cause injury from snap-back, breaking, or loss of control. While assembling models shown in instructions, hold rubber band tightly, and do not overstretch. Use Rubber Bands only as shown in these instructions. **DO NOT USE FRAYED OR TORN RUBBER BANDS. CAUTION:** Keep Rubber Bands away from face and eyes.

(FR) **ATTENTION :** Les élastiques peuvent causer des blessures en claquant, en se brisant ou quand on les manipule imprudemment. Tenez fermement les élastiques lors de l'assemblage du modèle en veillant à ne pas trop les tendre. Utilisez les élastiques que selon les instructions comme indiqué. **N'UTILISEZ PAS D'ÉLASTIQUES DISTENDUS OU ABIMÉS. ATTENTION :** Tenez les élastiques à l'écart du visage et des yeux.

(ES) **PRECAUCIÓN:** Las gomas pueden causar daños si se sueltan con fuerza, se rompen o se pierde su control. Al construir los modelos que se muestran en las instrucciones, sujetar bien la goma y no estirarla demasiado. Las gomas deben usarse únicamente como se indica en las instrucciones. **NO USAR GOMAS QUE ESTÉN DESGASTADAS NI ASGADAS. PRECAUCIÓN:** Mantenga las gomas elásticas alejadas de la cara y los ojos.

(DE) **VORSICHT:** Gummibänder können Verletzungen hervorrufen, wenn sie reißen, zurückspringen oder wenn sie nicht vorsichtig gehandhabt werden. Halten Sie die Gummibänder während des Zusammenbaus der Modelle fest, ohne sie jedoch zu überdehnen. Verwenden Sie die Gummibänder gemäß den Anweisungen. **VERWENDEN SIE NIEMALS AUSGEFRANSTE ODER ZERRISSENE GUMMIBÄNDER. VORSICHT:** Halten Sie Gummibänder weg von Gesicht und Augen.

(IT) **ATTENZIONE:** Elastici può causare lesioni da snap-back, rottura, o perdita di controllo. Durante il montaggio dei modelli indicati nelle istruzioni, tenere ben elastico, e non tirare troppo. Utilizzare Elastici solo come indicato in queste istruzioni. **NON USARE SFILACCIATI O STRAPPATI ELASTICI. ATTENZIONE:** Mantenga gli elastici a partire dal fronte e dagli occhi.

(PT) **CUIDADO:** As borrachas poderão causar ferimentos ao serem esticadas, ao quebrarem ou ao perderem controlo. Ao montar os modelos mostrados nas instruções, segure bem a borracha e não a estique demasiado. Utilize as borrachas apenas da forma exemplificada nestas instruções. **NÃO UTILIZE BORRACHAS CORROÍDAS OU QUEBRADAS. CUIDADO:** Mantenha as faixas de borracha longe da cara e dos olhos.

(NL) **LET OP:** Elastiekjes kunnen letsel veroorzaken als ze wegschieten, kapotgaan of als er achteloos mee wordt omgegaan. Houd elastiekjes goed vast als je modellen bouwt volgens de instructies. Rek ze niet te ver uit. Gebruik elastiekjes uitsluitend zoals in de instructies beschreven staat. **GEBRUIK GEEN GERAFFELDE OF GESCHEURDE ELASTIEKJES. LET OP:** Houd elastiekjes uit de buurt van het gezicht en de ogen.



WARNING: CHOKING HAZARD – Toy contains a small ball and small parts. Not for children under 3 years.

ATTENTION : RISQUE D'ÉTOUFFEMENT – Ce jouet contient une bille en plastique et des pièces de petite taille. Ne convient pas aux enfants de moins de 3 ans.

ADVERTENCIA: PELIGRO DE ASFIXIA – Juguete contiene una pequeña bola y piezas pequeñas. No recomendado para niños menores de 3 años.

ACHTUNG: ERSTICKUNGSGEFAHR – Spielzeug enthält einen kleinen Ball und Kleinteile. Nicht für Kinder unter 3 Jahren.

AVVISO: PERICOLO DI SOFFOCARE – Giocattolo ha una pallina piccola e pezzi piccoli. Non adatto per bambini sotto 3 anni.

AVISO: PERIGO DE SUFOCAÇÃO – Toy contém uma pequena bola e peças pequenas. Não indicado para crianças menores de 3 anos.

WAARSCHUWING: INSLIKKINGSGEVAAR – Dit speelgoed bevat een balletje en kleine onderdelen. Niet geschikt voor kinderen jonger dan 3 jaar.

©2016 K'NEX Limited Partnership Group, P.O. Box 700, Hatfield, PA 19440-0700; email@knex.com; knex.com 1-800-KID-KNEX (USA/Canada/États-Unis/EE.UU.)

K'NEX UK Ltd., P.O. Box 3083, Reading RG1 9YQ, England

(EN) K'NEX and Building Worlds Kids Love are registered trademarks of K'NEX Limited Partnership Group. Customers outside the USA and Canada contact your local distributor at www.knex.com/distributors.

(FR) K'NEX et Building Worlds Kids Love sont des marques déposées de K'NEX Limited Partnership Group. Pour les clients en dehors du Canada et des États-Unis, veuillez contacter votre distributeur local que vous pouvez trouver sur www.knex.com/distributors.

(ES) K'NEX y Building Worlds Kids Love son marcas registradas de K'NEX Limited Partnership Group. El cliente que no vive en EE.UU. y Canadá se pone en contacto con el distribuidor local en www.knex.com/distributors.

(DE) K'NEX und Building Worlds Kids Love sind eingetragene Warenzeichen der K'NEX Limited Partnership Group. Kunden außerhalb der USA/Kanada wenden sich bitte an Ihren lokalen Distributor bei www.knex.com/distributors.

(IT) K'NEX è Building Worlds Kids Love sono marchi registrati di K'NEX Limitato Gruppo di Partenariato. I clienti al di fuori degli Stati Uniti e del Canada contattare il vostro distributore locale a www.knex.com/distributors.

(PT) K'NEX e construir mundos filhos amor são marcas registradas da K'NEX Parceria Limitada Grupo. Os clientes fora dos EUA/Canadá contate seu distribuidor local em www.knex.com/distributors.

(NL) K'NEX en gebouw werelden Kids Love zijn geregistreerde handelsmerken van K'Nex Commanditaire vennootschap groep. Klanten buiten de VS en Canada kunnen contact opnemen met de plaatselijke distributeur op www.knex.com/distributors.

CAUTION: Do not launch in the direction of people, animals, or walls; You could cause injury or damage.

ATTENTION : Ne lancez pas dans la direction des personnes, des animaux, ou des murs ; Vous pourriez endommager des dommages ou.

PRECAUCIÓN: No lance en dirección de gente, de animales, o de paredes; Usted podría estropear lesión o.

VORSICHT: Starten Sie nicht in Richtung der Leute, der Tiere oder der Wände; Sie konnten Verletzung oder Schaden verursachen.

AVVERTENZA: Non lanci in direzione della gente, degli animali, o delle pareti; Potreste causare la lesione o il danno.

CUIDADO: Não lanç no sentido dos povos, dos animais, ou das paredes; Você poderia causar ferimento ou dano.

VOORZICHTIGHEID: Lanceer niet in de richting van mensen, dieren, of muren; U kon verwonding of schade veroorzaken.

‡ Clear Warp Pipe!
Tuyau translucide !
¡Tubo Warp Claro!
Durchsichtige Warp-Röhre!
Trasparente condotto spazio-temporale!
Claro tubo de urdidura!
Transparante warpbuis!

† Limited Edition!
Édition Limitée !
Edición Limitada!
Limited Edition!
Edizione Limitata!
Edição Limitada!
Beperkte Uitgave!

(EN) Product & colors may vary.

(FR) Le produit et ses couleurs peuvent varier.

(ES) El producto y los colores pueden variar.

(DE) Produkte und Farben können abweichen.

(IT) Prodotti e colori possono differire.

(PT) O produto e as cores podem variar.

(NL) Product en kleuren kunnen variëren.



[facebook.com/buildknex](https://www.facebook.com/buildknex)



[@knexbrands](https://www.instagram.com/knexbrands)

TM & © 2016 Nintendo.

138635-V2-10/16