

**K'NEX building basics:**  
To begin your model, start here at step 1 and follow the numbers. It helps to face your model in the same direction as the instructions while you build. The arrows show you where the parts connect. The faded color parts are the ones you have already put together.

**Notions de base K'NEX pour le montage:**  
Pour commencer ton modèle, trouve l'étape numéro 1 et suis les numéros. Pour t'aider pendant que tu construis, oriente ton modèle dans le même sens que les instructions. Les flèches t'indiquent où les pièces s'assemblent, mais les points de raccordement n'ont pas tous des flèches. Les pièces de couleur délavée sont celles que tu as déjà assemblées.

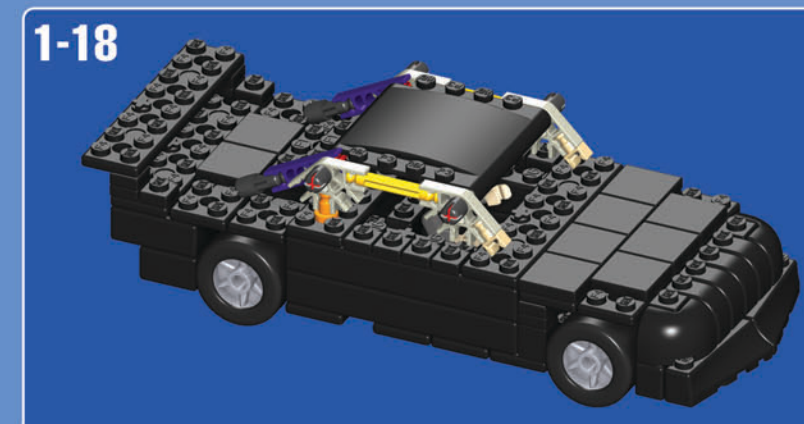
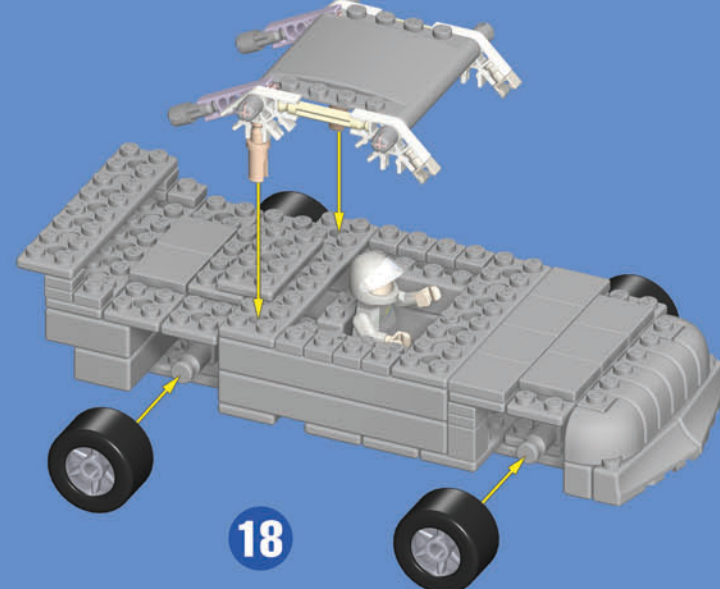
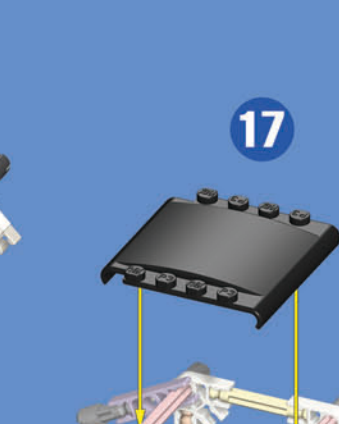
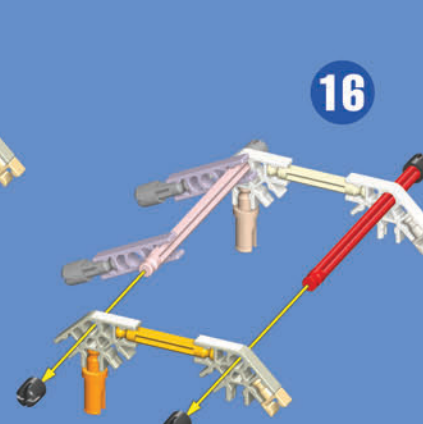
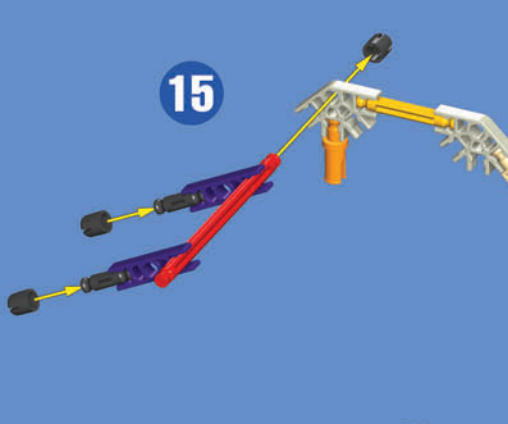
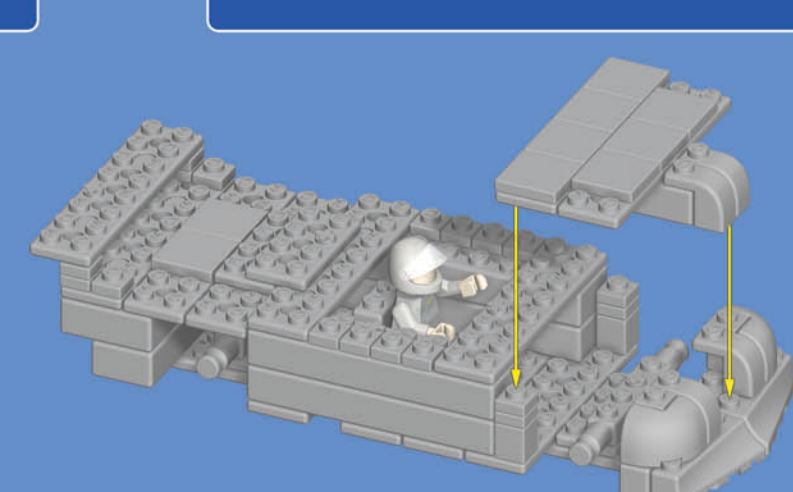
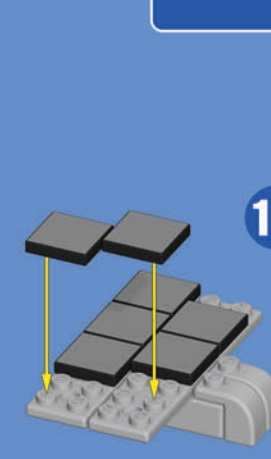
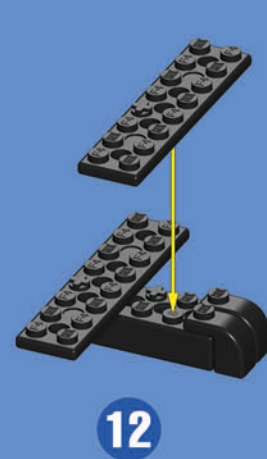
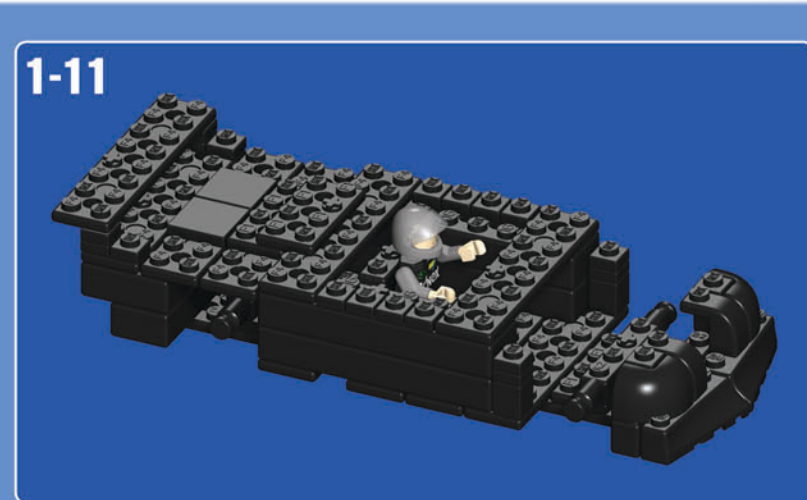
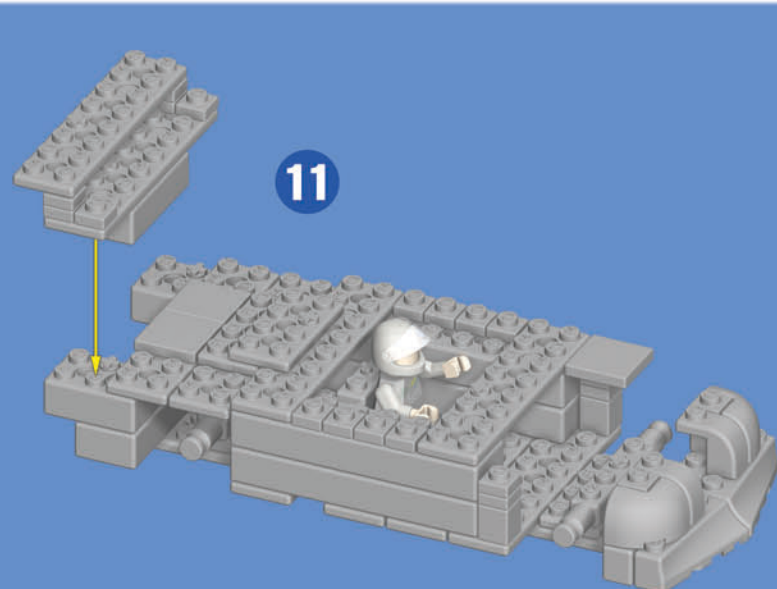
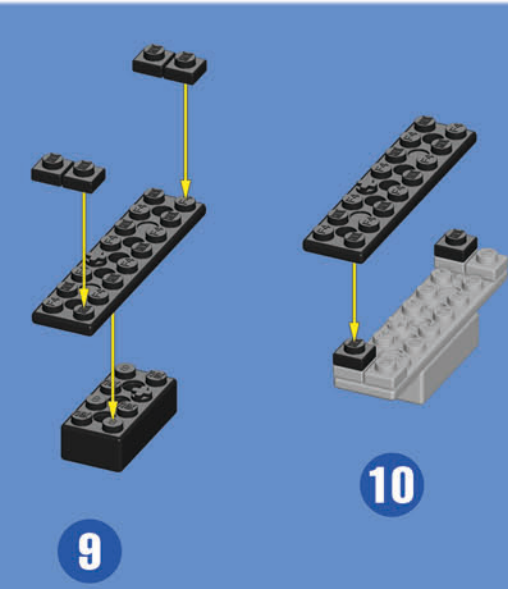
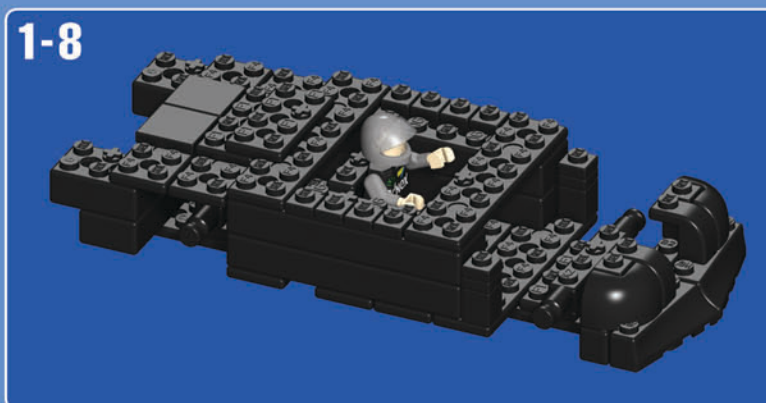
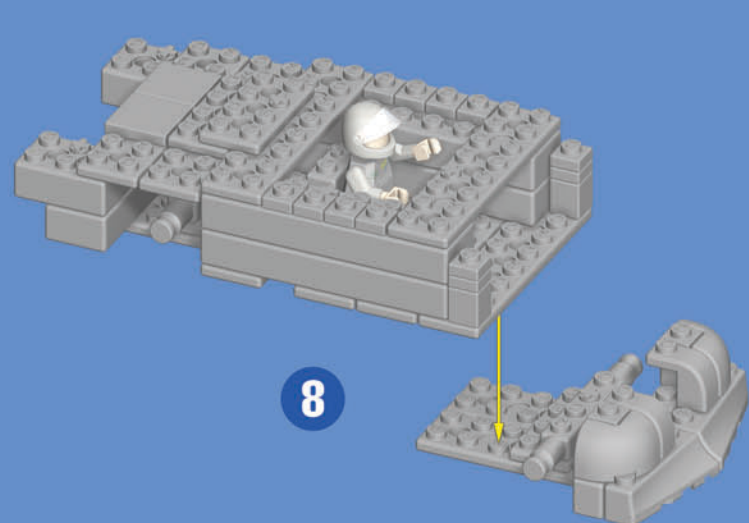
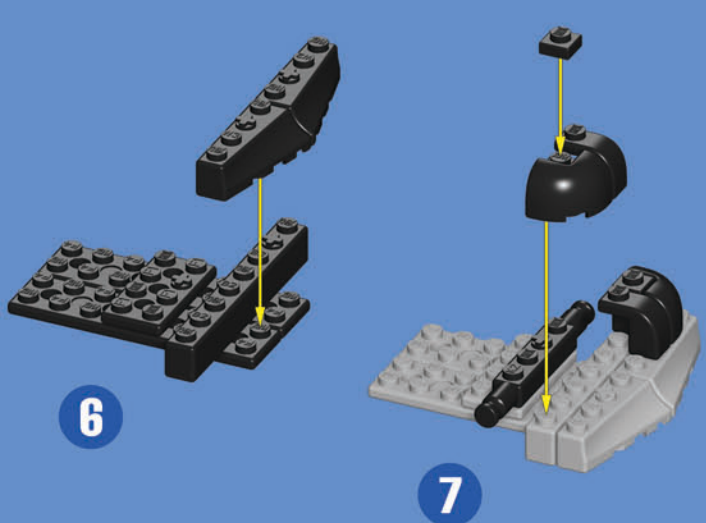
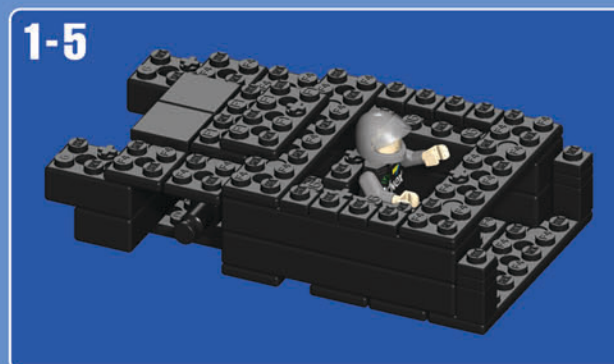
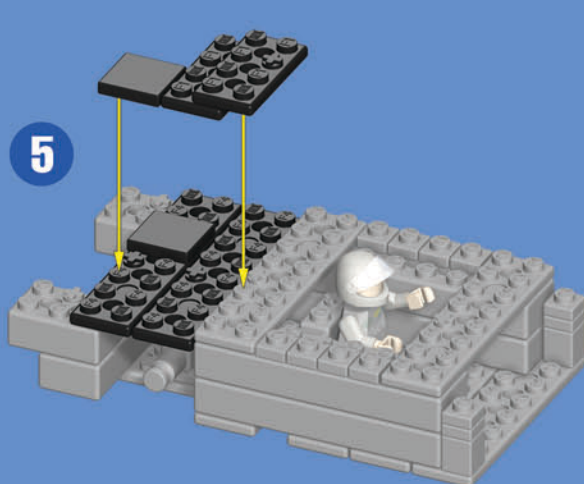
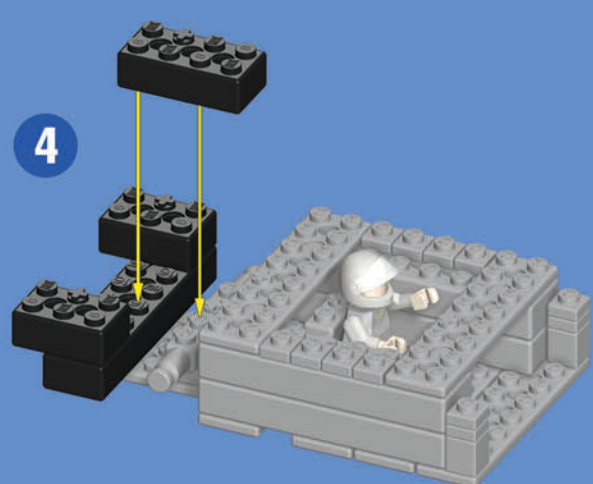
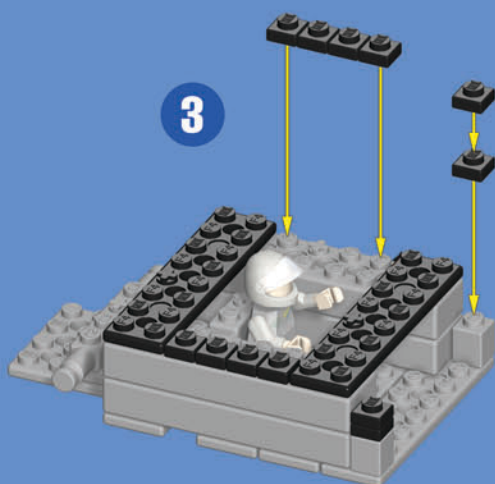
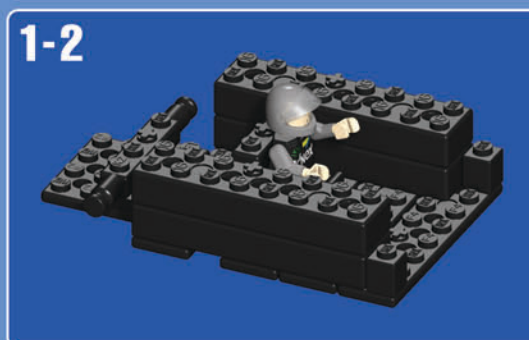
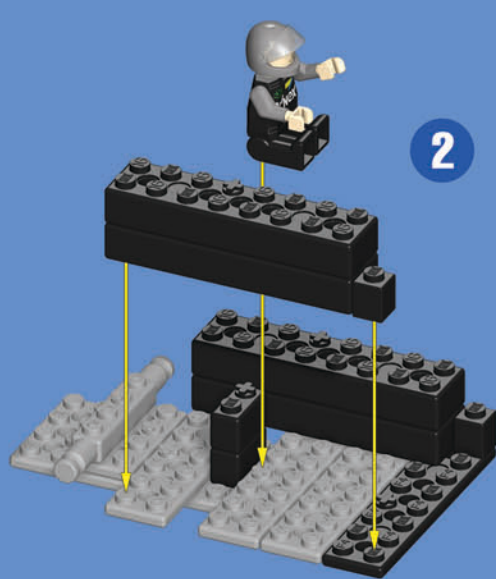
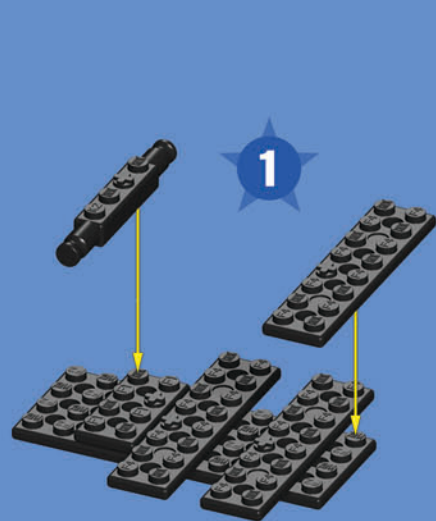

**WARNING:** CHOKING HAZARD - Small parts. Not for children under 3 years.

**AVERTISSEMENT:** DANGER D'ÉTOUFFEMENT - Pièces de petite taille. Ne pas donner aux enfants de moins de 3 ans.

1-800-KID-KNEX (USA/États-Unis/Canada) - email@knex.com - http://www.knex.com/distributors  
K'NEX is a registered trademark of K'NEX Limited Partnership Group. Product & colors may vary. Most models can be built one at a time. Standard K'NEX parts made in the U.S.A. Special components made in China.  
(FR) K'NEX est une marque déposée de K'NEX Limited Partnership Group. Produits et couleurs peuvent varier. La plupart des modèles ne peuvent être construits qu'un à un. Pièces K'NEX courantes fabriquées aux États-Unis. Éléments spéciaux fabriqués en Chine.  
(ES) K'NEX es una marca registrada de K'NEX Limited Partnership Group. El producto y los colores pueden variar. La mayoría de los modelos se pueden construir uno a la vez. Otras patentes de EE.UU. y países extranjeros pendientes. Piezas estándar de K'NEX hechas en EE.UU. Componentes especiales hechos en China.

©2010 K'NEX Limited Partnership Group  
P.O. Box 700  
Hatfield, PA 19440-0700

136004-V1-04/10

Identifies Genuine K'NEX Bricks.  
Identifie ce qui sont d'authentiques briques K'NEX.  
Identifica los ladrillos genuinos de K'NEX.  
Identifiziert echte K'NEX-Bausteine.  
Identifica i veri blocchi K'NEX.  
Identifica que são cubos genuinos da K'NEX.  
Identificeert K'NEX bakstenen voor.

© 2010 Hendrick Motorsports, LLC. The name, likeness and signature of Dale Earnhardt, Jr. and the likeness of the #88 Amp Energy/National Guard Chevrolet are used with the permission of Hendrick Motorsports, LLC and JRM Licensing, LLC. NASCAR® is a registered trademark of the National Association for Stock Car Auto Racing, Inc. © 2010 Hendrick Motorsports, LLC. Le nom, la similitude et la signature de Dale Earnhardt, Jr. et la similitude du #88 Amp Energy/National Guard Chevrolet sont employés avec la permission de Hendrick Motorsports, LLC and JRM Licensing, LLC. NASCAR® est une marque inscrite de l'Association nationale pour Stock Car Auto Racing, Inc.



Sold separately. May not be available in all markets. Vendus séparément. Certains produits ne sont pas disponibles pour tous les marchés. Se venden por separado. Algunos productos no pueden estar disponibles en todos mercados.

