

K'NEX building basics:
To begin your model, start here at step 1 and follow the numbers. It helps to face your model in the same direction as the instructions while you build. The arrows show you where the parts connect. The faded color parts are the ones you have already put together.

Notions de base K'NEX pour le montage:
Pour commencer ton modèle, trouve l'étape numéro 1 et suis les numéros. Pour t'aider pendant que tu construis, oriente ton modèle dans le même sens que les instructions. Les flèches t'indiquent où les pièces s'assemblent, mais les points de raccordement n'ont pas tous des flèches. Les pièces de couleur délavée sont celles que tu as déjà assemblées.

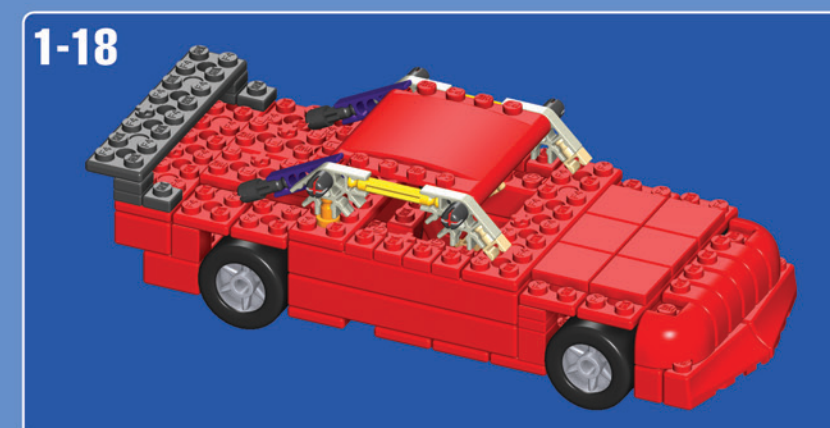
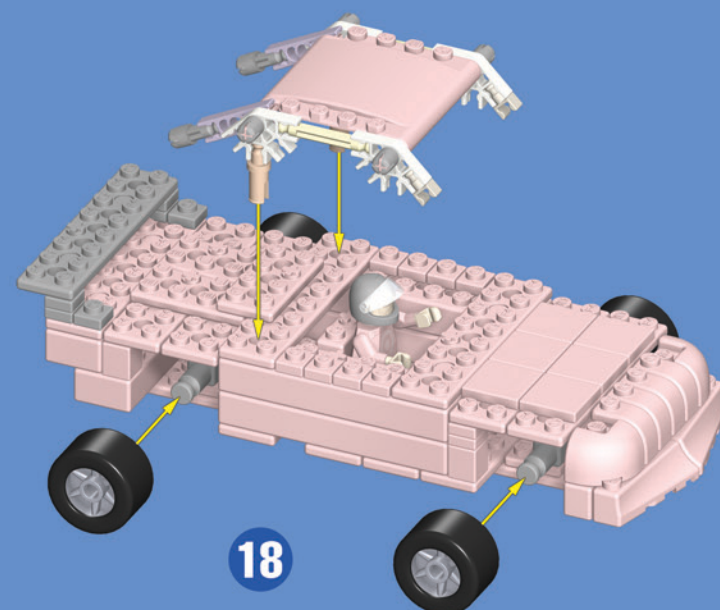
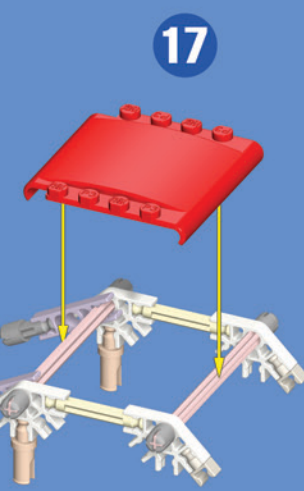
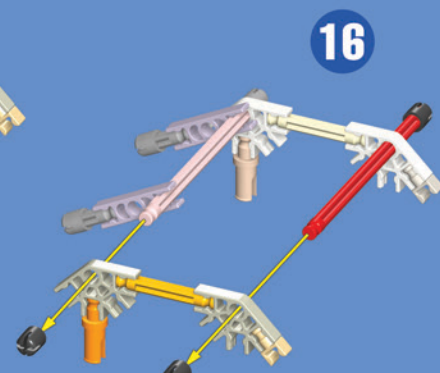
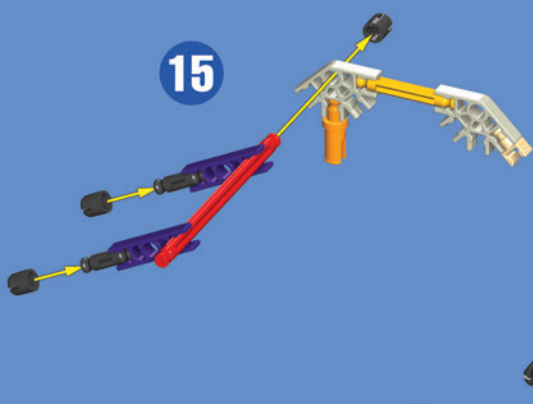
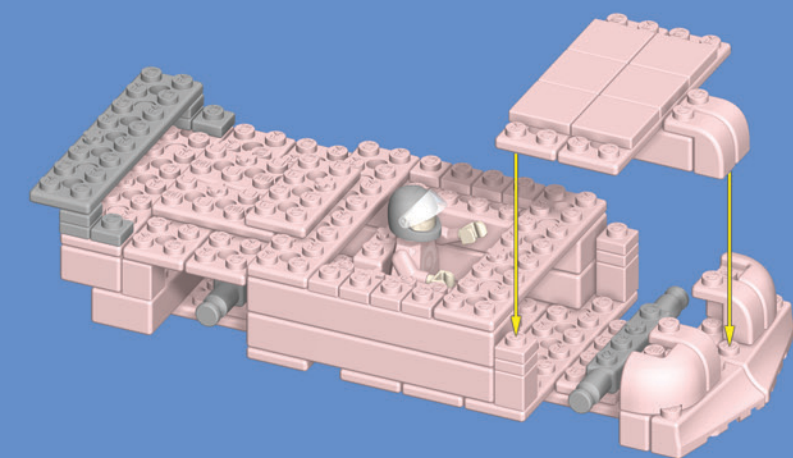
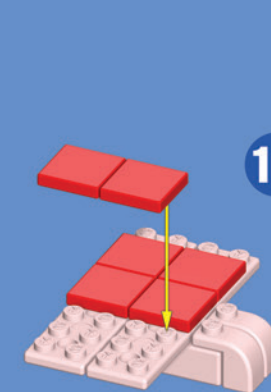
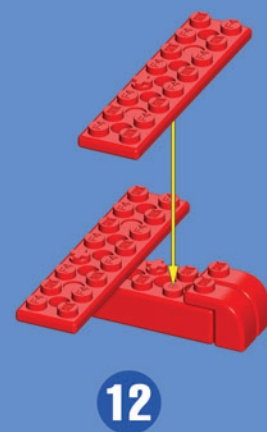
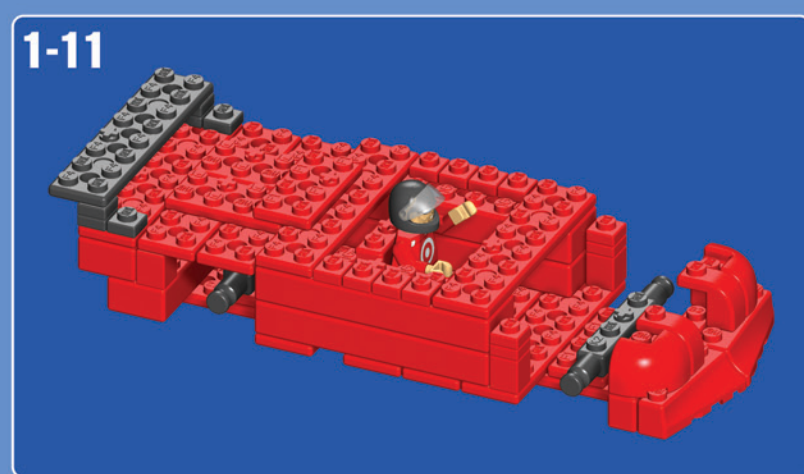
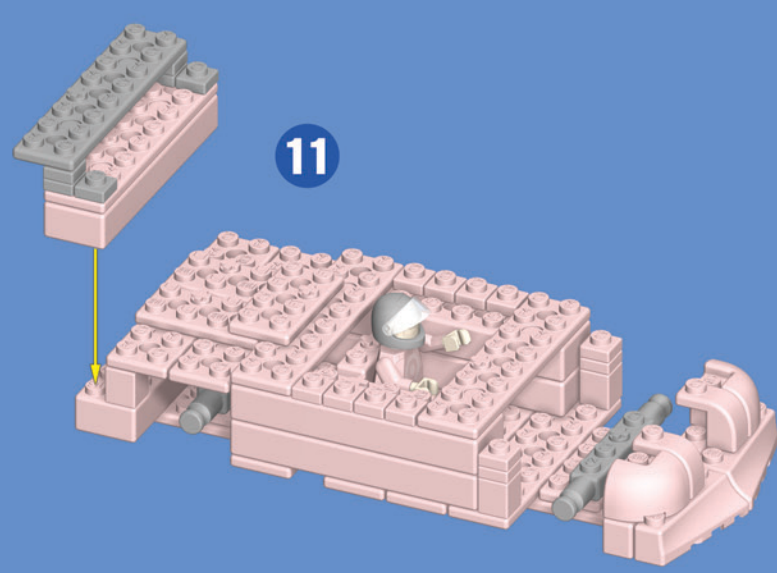
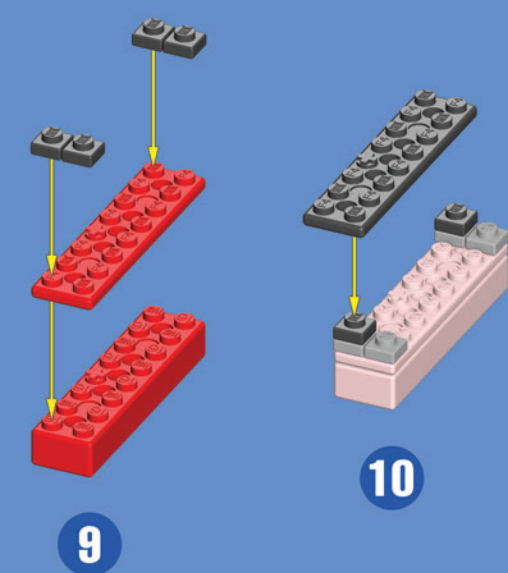
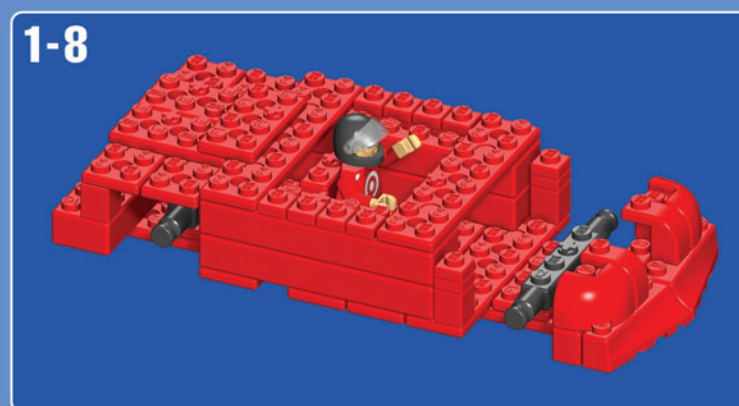
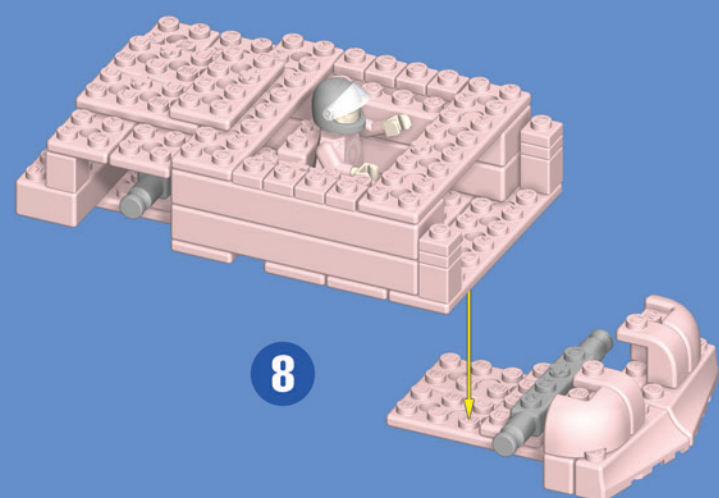
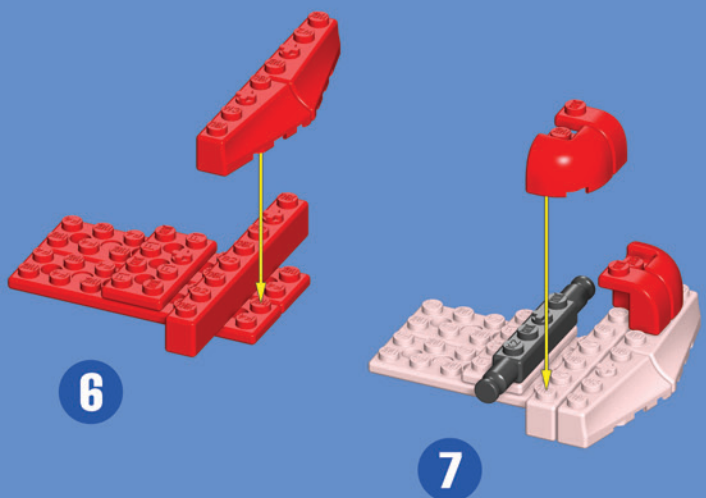
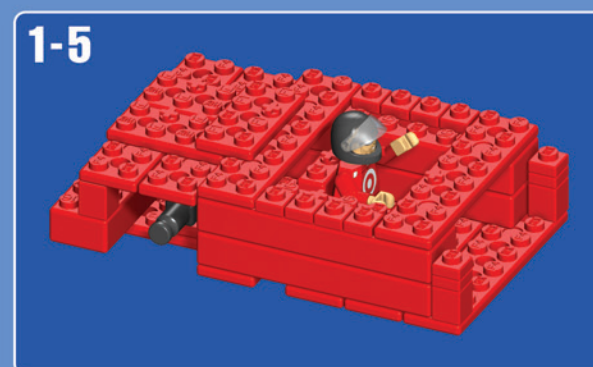
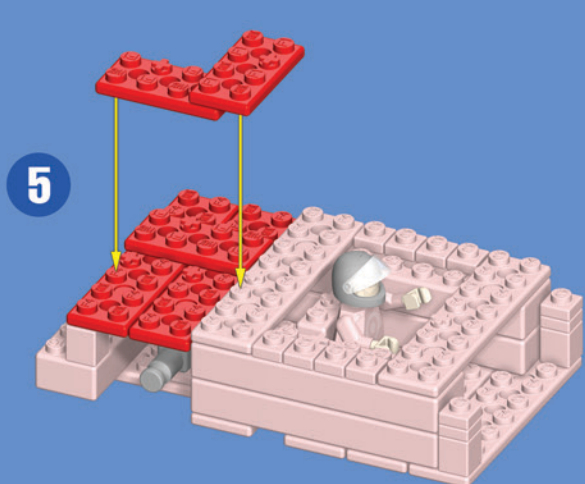
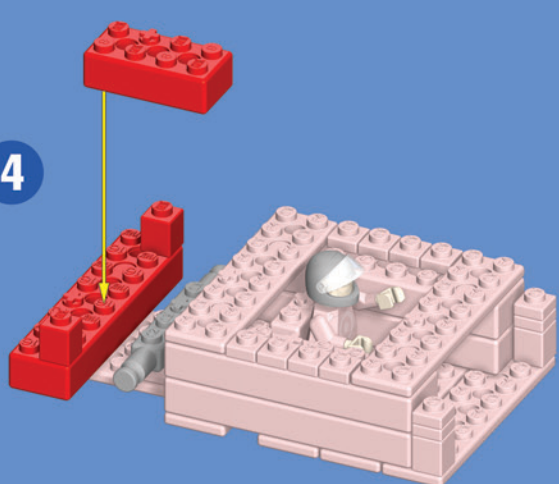
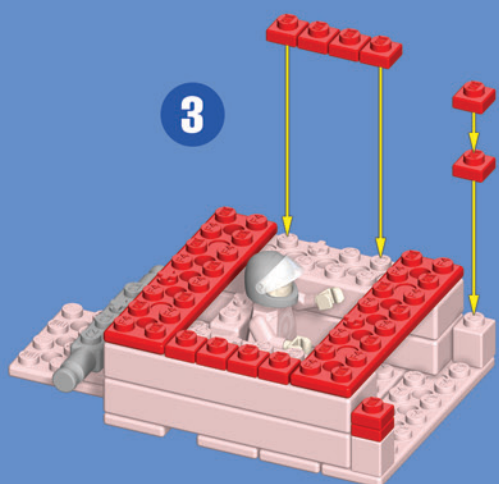
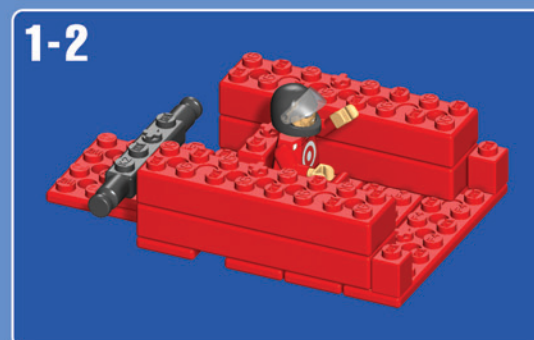
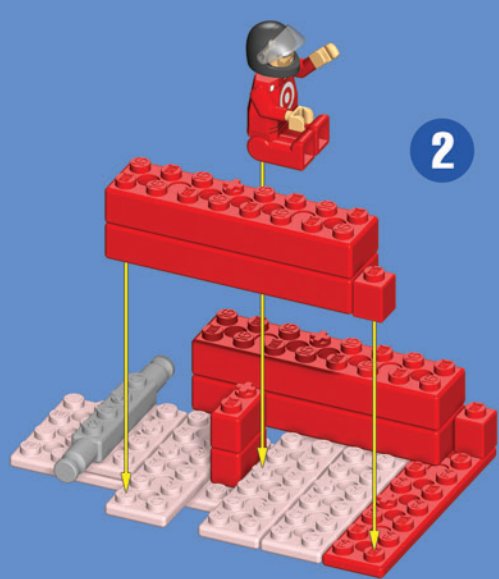
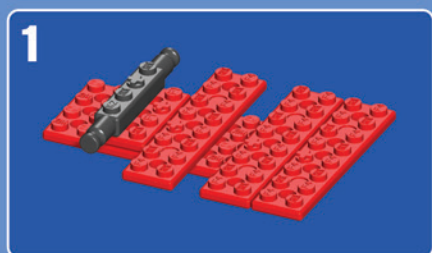
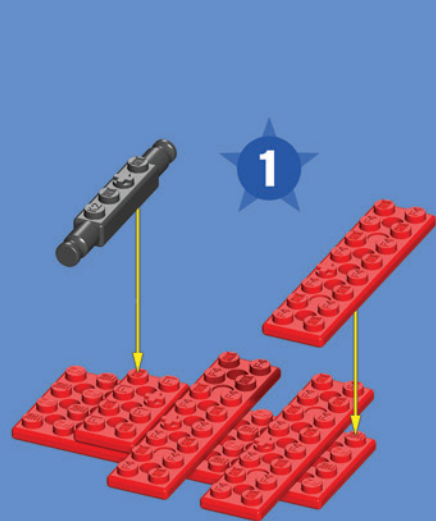

WARNING: CHOKING HAZARD - Small parts. Not for children under 3 years.

AVERTISSEMENT: DANGER D'ÉTOUFFEMENT - Pièces de petite taille. Ne pas donner aux enfants de moins de 3 ans.

1-800-KID-KNEX (USA/Etats-Unis/Canada) - email@knex.com - http://www.knex.com/distributors
K'NEX is a registered trademark of K'NEX Limited Partnership Group. Product & colors may vary. Most models can be built one at a time. Standard K'NEX parts made in the U.S.A. Special components made in China.
(FR) K'NEX est une marque déposée de K'NEX Limited Partnership Group. Produits et couleurs peuvent varier. La plupart des modèles ne peuvent être construits que un à un. Pièces K'NEX courantes fabriquées aux États-Unis. Éléments spéciaux fabriqués en Chine.
(ES) K'NEX es una marca registrada de K'NEX Limited Partnership Group. El producto y los colores pueden variar. La mayoría de los modelos se puede construir uno a la vez. Otras patentes de EE.UU. y países extranjeros pendientes. Piezas estándar de K'NEX hechas en EE.UU. Componentes especiales hechos en China.

©2010 K'NEX Limited Partnership Group
P.O. Box 700
Hatfield, PA 19440-0700

136006-V1-03/10



Sold separately. Vendus séparément. Certains produits ne sont pas disponibles pour tous les marchés. Se venden por separado. Algunos productos no pueden estar disponibles en todos los mercados.

Identifies Genuine K'NEX Bricks.
Identifie que ce sont d'authentiques briques K'NEX.
Identifica los ladrillos genuinos de K'NEX.
Identifiziert echte K'NEX-Bausteine.
Identifica i veri blocchi K'NEX.
Identifica que são cubos genuinos da K'NEX.
Identificeert K'NEX bakstenen voor.



©2010 Earnhardt Ganassi Racing with Felix Sabates, LLC. All rights reserved. The stylized #42 is a registered trademark of Chip Ganassi Racing with Felix Sabates, Inc. ©2010 Target Stores. The Bullseye Design and Target are registered trademarks of Target Brands, Inc. All rights reserved. NASCAR® is a registered trademark of the National Association for Stock Car Auto Racing, Inc. ©2010 Earnhardt Ganassi Racing with Felix Sabates, LLC. Tous droits réservés. Le #42 stylisé est une marque déposée de Chip Ganassi Racing with Felix Sabates, Inc. ©2010 magasins Target. La conception et la cible de bouddine sont des marques déposées de Target Brands, Inc. Tous droits réservés. NASCAR® est une marque inscrite de l'Association nationale pour Stock Car Auto Racing, Inc.

NASCAR®

42

TARGET CAR BUILDING SET™



Jimmie Johnson



Follow these pictures when you are ready to put the stickers on the car.

Utilisez ces graphiques quand vous êtes prêts à appuyer sur ces designs sur votre modèle.

Use estos cuadros cuando usted está listo a presionar estos diseños a los lados del modelo.

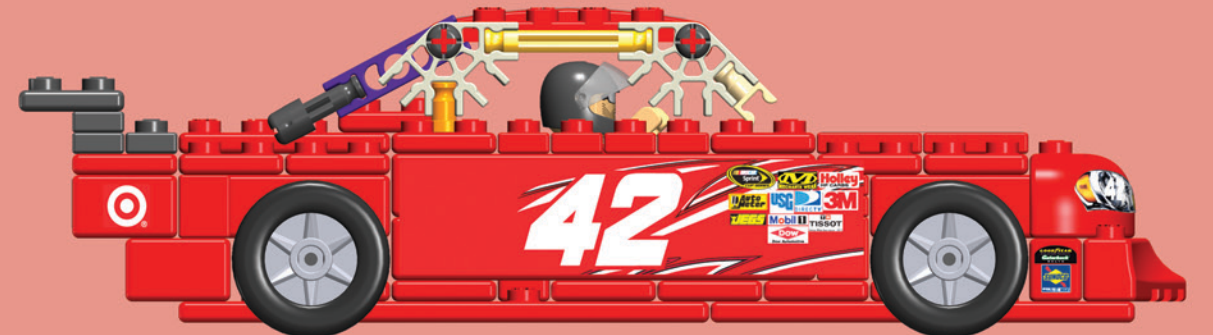
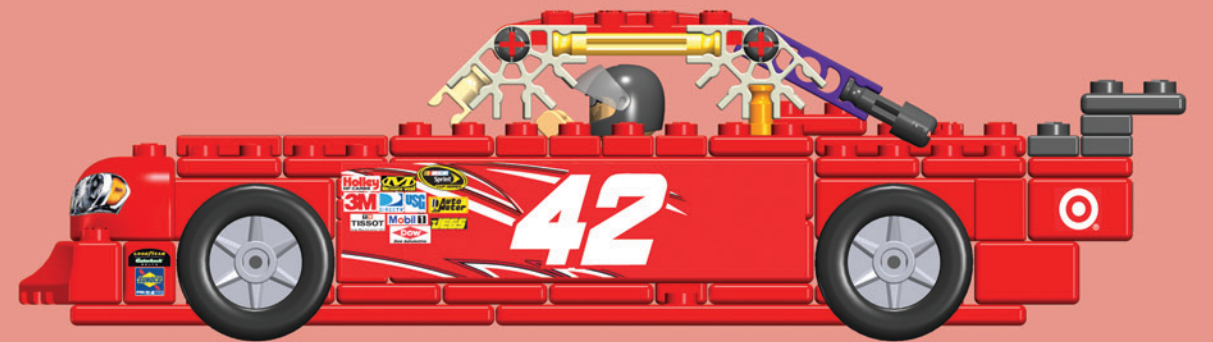
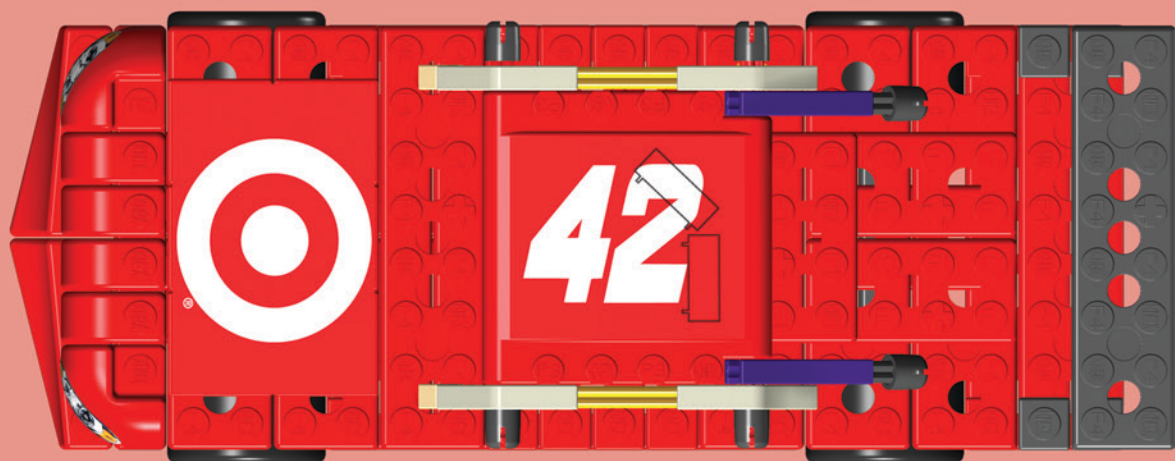

Parts List. Liste des pièces. Lista de piezas.

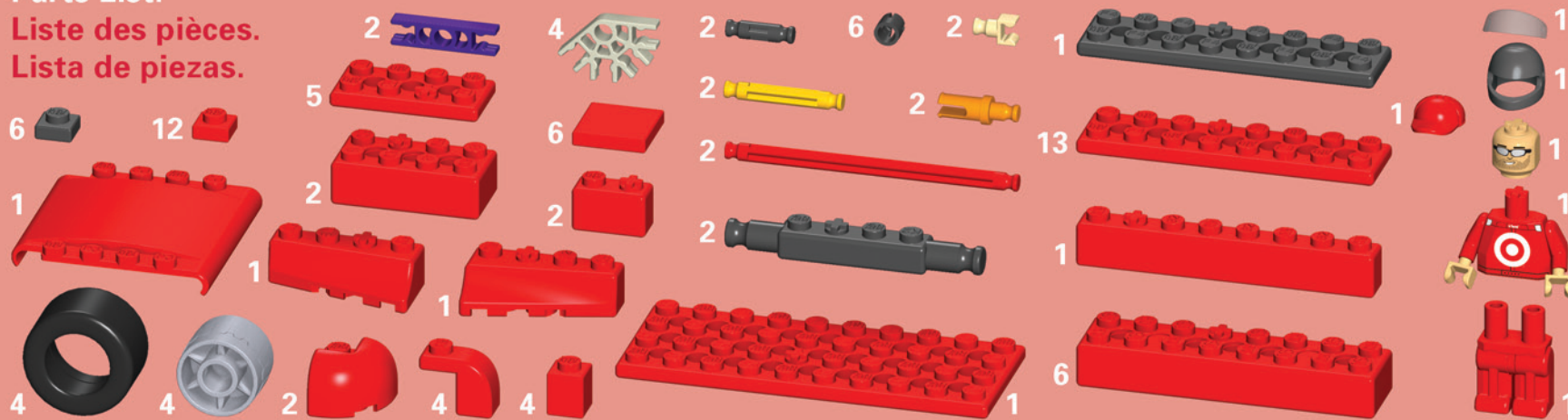

KNEX.COM

For building help, updates to instructions or other great building ideas log on to www.knex.com/racing.
Pour l'aide, les mises à jour aux instructions ou à d'autres jouets vont à www.knex.com/racing.
Para la ayuda, las actualizaciones a instrucciones u otros juguetes van a www.knex.com/racing.

