

K'NEX®

Building Worlds Kids Love®

Mini Golf

BUILDING SET

JEU DE CONSTRUCTION



8+

88447



WARNING:

CHOKING HAZARD – Small parts.
Not for children under 3 years.



ATTENTION :

RISQUE D'ÉTOUFFEMENT – Pièces de petite taille.
Ne convient pas aux enfants de moins de 3 ans.



9
HOLES!
TROUS!

Mini Golf

(EN) Keep this important information for future reference.

(FR) Gardez précieusement cette notice pour t'y référer ultérieurement.

(ES) Guarde esta información importante para futuras referencias.

(DE) Informationen für später aufbewahren.

(IT) Conservare queste importanti informazioni per riferimento futuro.

(PT) Manter esta informação importante para referência futura.

(NL) Bewaar deze belangrijke informatie, zodat u deze in de toekomst opnieuw kunt raadplegen.

(EN) **CAUTION:** USE CLUB WITH CARE. DO NOT HIT BALL OR SWING CLUB IN THE DIRECTION OF PEOPLE, ANIMALS, OR WALLS. YOU COULD CAUSE INJURY OR DAMAGE.

(FR) **ATTENTION :** UTILISER CLUB AVEC SOIN. NE PAS PIVOTER LA BOULE OU LE CLUB EN DIRECTION DES GENS, DES ANIMAUX, NI LES MURS. VOUS POURRIEZ VOUS BLESSER OU ENDOMMAGER.

(ES) **PRECAUCIÓN:** USE CLUB CON CUIDADO. NO GOLPEAR BOLAS O CLUB GIRO EN LA DIRECCIÓN DE LAS PERSONAS, LOS ANIMALES O LAS PAREDES. PUEDE CAUSAR LESIONES O DAÑOS.

(DE) **VORSICHT:** VERWENDEN SIE DEN SCHLÄGER MIT VORSICHT. SCHLAGEN SIE DEN BALL ODER SCHWINGEN SIE DEN SCHLÄGER NICHT IN RICHTUNG VON MENSCHEN, TIEREN, ODER WÄNDE. SIE KÖNNTEN VERLETZUNGEN ODER SACHSCHÄDEN VERURSACHEN.

(IT) **AVVISO:** USATE LA MAZZA DI GOLF CON CURA. NON COLPIRE LA PALLINA DI GOLF NELLA DIREZIONE DI PERSONE, ANIMALI, O LE PARETI. SI PUÒ CAUSARE FERITE O DANNI.

(PT) **CUIDADO:** O USO CLUB COM CUIDADO. NÃO BATA NA BOLA OU SWING CLUB NO SENTIDO DAS PESSOAS, DOS ANIMAIS, OU PAREDES. VOCÊ PODE CAUSAR FERIMENTOS OU DANOS.

(NL) **VOORZICHTIG:** GEBRUIK CLUB MET ZORG. GEEN HIT BALL OF SWING CLUB IN DE RICHTING VAN MENSEN, DIEREN, OF MUREN. U KAN LEIDEN TOT LETSEL OF SCHADE.

(EN) **CAUTION:** Rubber Bands can cause injury from snap-back, breaking, or loss of control. While assembling models shown in instructions, hold rubber band tightly, and do not overstretch. Use Rubber Bands only as shown in these instructions. **DO NOT USE FRAYED OR TORN RUBBER BANDS. CAUTION:** Keep Rubber Bands away from face and eyes.

(FR) **ATTENTION :** Les élastiques peuvent causer des blessures en claquant, en se brisant ou quand on les manipule imprudemment. Tenez fermement les élastiques lors de l'assemblage du modèle en veillant à ne pas trop les tendre. Utilisez les élastiques que selon les instructions comme indique. **N'UTILISEZ PAS D'ÉLASTIQUES DISTENDUS OU ABIMÉS. ATTENTION :** Tenez les élastiques à l'écart du visage et des yeux.

(ES) **PRECAUCIÓN:** Las gomas pueden causar daños si se sueltan con fuerza, se rompen o se pierde su control. Al construir los modelos que se muestran en las instrucciones, sujetar bien la goma y no estirla demasiado. Las gomas deben usarse únicamente como se indica en las instrucciones. **NO USAR GOMAS QUE ESTÉN DESGASTADAS NI ASGADAS. PRECAUCIÓN:** Mantenga las gomas elásticas alejadas de la cara y los ojos.

(DE) **VORSICHT:** Gummibänder können Verletzungen hervorrufen, wenn sie reißen, zurückspringen oder wenn sie nicht vorsichtig gehandhabt werden. Halten Sie die Gummibänder während des Zusammenbaus der Modelle fest, ohne sie jedoch

zu überdehnen. Verwenden Sie die Gummibänder gemäß den Anweisungen. **VERWENDEN SIE NIEMALS AUSGEFRANSTE ODER ZERRISSENE GUMMIBÄNDER. VORSICHT:** Halten Sie Gummibänder weg von Gesicht und Augen.

(IT) **ATTENZIONE:** Elastici può causare lesioni da snap-back, rottura, o perdita di controllo. Durante il montaggio dei modelli indicati nelle istruzioni, tenere ben elastico, e non tirare troppo. Utilizzare Elastici solo come indicato in queste istruzioni. **NON USARE SFILACCIATI O STRAPPATI ELASTICI. ATTENZIONE:** Mantenga gli elastici a partire dal fronte e dagli occhi.

(PT) **CUIDADO:** As borrachas poderão causar ferimentos ao serem esticadas, ao quebrarem ou ao perderem controlo. Ao montar os modelos mostrados nas instruções, segure bem a borracha e não a estique demasiado. Utilize as borrachas apenas da forma exemplificada nestas instruções. **NÃO UTILIZE BORRACHAS CORROÍDAS OU QUEBRADAS. CUIDADO:** Mantenha as faixas de borracha longe da cara e dos olhos.

(NL) **LET OP:** Elastiekjes kunnen letsel veroorzaken als ze wegschieten, kapotgaan of als er achteloos mee wordt omgegaan. Houd elastiekjes goed vast als je modellen bouwt volgens de instructies. Rek ze niet te ver uit. Gebruik elastiekjes uitsluitend zoals in de instructies beschreven staat. **GEBRUIK GEEN GERAFELDE OF GESCHEURDE ELASTIEKJES. LET OP:** houd elastiekjes uit de buurt van het gezicht en de ogen.

(EN) Use care where you use these models. Models could damage furniture or walls, or injure people or pets.

(FR) Utilisez des soins là où vous utilisez ce modèles. Modèles pourrait endommager les meubles ou les murs, ou blesser des personnes ou des animaux domestiques.

(ES) Tenga mucho cuidado cuando se utiliza este modelos. Modelos podría dañar los muebles las paredes, o lesionar a personas o animales.

(DE) Seien Sie vorsichtig, wo Sie diese Modelle zu verwenden. Die Modelle könnten Möbel und Wände beschädigen oder Personen und Haustiere verletzen.

(IT) Fare attenzione dove usi questi Modeli. Questi modelli potrebbero fare danno a pareti, o far male a persone o animali.

(PT) Tenha cuidado onde você usa esses modelos. Modelos podem danificar móveis ou paredes, ou ferir pessoas ou animais de estimação.

(NL) Wees voorzichtig waar u deze modellen te gebruiken. Modellen kunnen meubels of muren beschadigen of verwonden mensen of dieren.

HOLE:	1	2	3	4	5	6	7	8	9	TOTAL
NAME										
NAME										
NAME										
NAME										

Need more scorecards? Head to <http://www.knex.com/scorecard/> to download and print more!

HOLE:	1	2	3	4	5	6	7	8	9	TOTAL
NAME										
NAME										
NAME										
NAME										

Need more scorecards? Head to <http://www.knex.com/scorecard/> to download and print more!

HOLE:	1	2	3	4	5	6	7	8	9	TOTAL
NAME										
NAME										
NAME										
NAME										

Need more scorecards? Head to <http://www.knex.com/scorecard/> to download and print more!

TROU :	1	2	3	4	5	6	7	8	9	TOTAL
NOM										
NOM										
NOM										
NOM										

Besoin de plus des tableaux ? Tête de <http://www.knex.com/scorecard/> de télécharger et d'imprimer plus !

TROU :	1	2	3	4	5	6	7	8	9	TOTAL
NOM										
NOM										
NOM										
NOM										

Besoin de plus des tableaux ? Tête de <http://www.knex.com/scorecard/> de télécharger et d'imprimer plus !

TROU :	1	2	3	4	5	6	7	8	9	TOTAL
NOM										
NOM										
NOM										
NOM										

Besoin de plus des tableaux ? Tête de <http://www.knex.com/scorecard/> de télécharger et d'imprimer plus !

K'NEX Building Basics

Esenciales de construcción K'NEX

Start Building

To begin your model, find the **1** and follow the numbers. Each piece has its own shape and color. Just look at the pictures, find the pieces in your set that match and then connect them together. Try to face your model in the same direction as the instructions while you build. The arrows show you where the parts connect, but not all connections points have arrows. Faded colors show you this section is already built.

Démarrer la Construction

Pour commencer le modèle, trouver l'étape numéro **1** trouver les numéros. Chaque pièce a sa propre forme et sa propre couleur. Regarder les illustrations, trouve les pièces qui correspondent à l'illustration et les assembler. Pour vous faciliter la tâche, orienter le modèle dans le même sens que les instructions. Les flèches indiquent où les pièces s'assemblent, mais les points de raccordement n'ont pas tous des flèches. Les pièces de couleur délavées sont celles déjà assemblées.

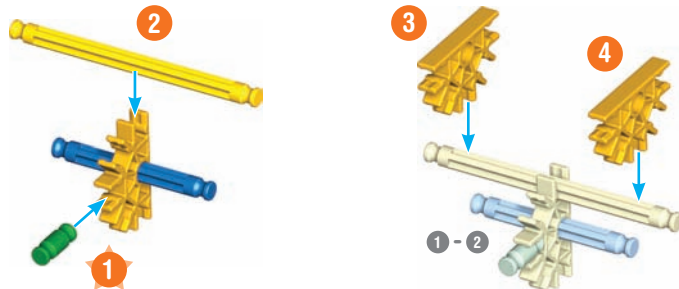

Spacers

There are places in your model where you need to use spacers. Be sure to use the correct number of spacers shown in the instructions.

Espaceurs

Il y a des endroits sur le modèle où des espaceurs sont nécessaires. S'assurer d'utiliser la bonne couleur et le nombre d'espaceurs indiqué sur les instructions.



Building Help

You can find more building help and tips on our website at: knex.com/instructions and enter code **88447**.

You can also find it fast using a tablet or mobile device and scanning this QR Code.

Aide de construire

Vous pouvez trouver plus aide de construire et conseils sur notre site web à : knex.com/instructions et saisissez le code **88447**. Vous pouvez également le trouver rapidement en utilisant d'un tablet pc ou périphérique mobile en faisant une scanographie de ce QR Code.



Connectors

You can slide these special connectors together. Push tightly until you hear a "click". Pay close attention to the instructions and position them horizontally or vertically exactly as they are shown.

Connecteurs

Vous pouvez assembler ces connecteurs tout à fait uniques en les faisant glisser l'un dans l'autre. Pousser fort jusqu'au « clic ». Lire les instructions attentivement et les positionner horizontalement ou verticalement, en suivant exactement les illustrations.

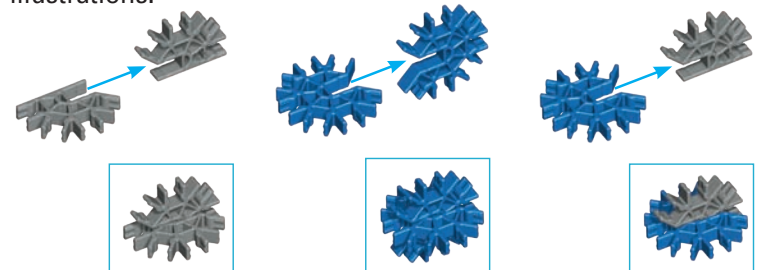

Flexi-rod

A Flexi-rod is a rod that you bend to make curves. It will be easier to attach to your model if you bend it back and forth first.

Tiges Flexibles

Un Tiges Flexibles est une tige que tu peux courber pour faire des courbes. Elle pourra être attachée plus aisément à ton modèle si tu la plies en avant et en arrière plusieurs fois.



⚠ WARNING: CHOKING HAZARD – Small parts. Not for children under 3 years.

ATTENTION : RISQUE D'ÉTOUFFEMENT – Pièces de petite taille. Ne convient pas aux enfants de moins de 3 ans.

ADVERTENCIA: PELIGRO DE ASFIXIA – Piezas pequeñas. No para niños menores de 3 años.

ACHTUNG: ERSTICKUNGSGEFAHR – Kleinteile. Nicht geeignet für Kinder unter 3 Jahren.

AVVISO: PERICOLO DI SOFFOCARE – Pezzi piccoli. Non adatto per bambini sotto 3 anni.

AVISO: PERIGO DE SUFOCAÇÃO – Peças pequenas. Não se destina a crianças com menos de 3 anos de idade.

WAARSCHUWING: VERSTIKKINGSGEVAAR – Kleine onderdelen. Niet geschikt voor kinderen onder 3.

Golf Clubs, Tees and Balls
Clubs de Golf, Tees et Boules

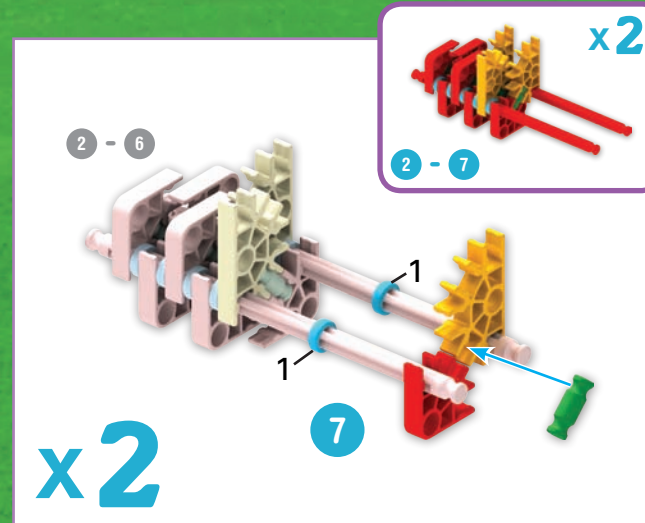
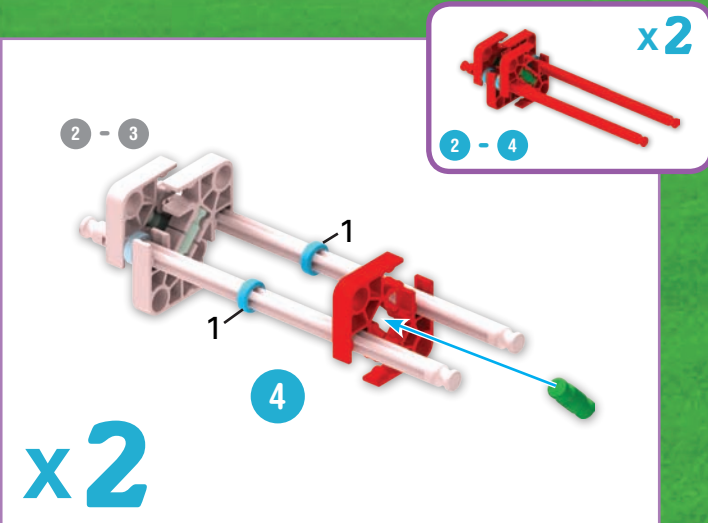
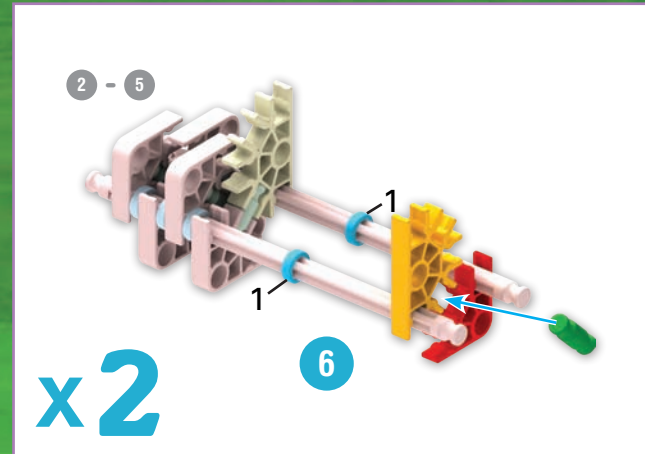
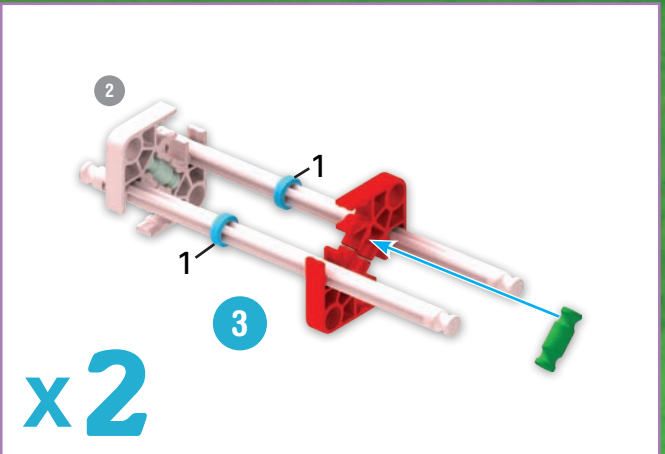
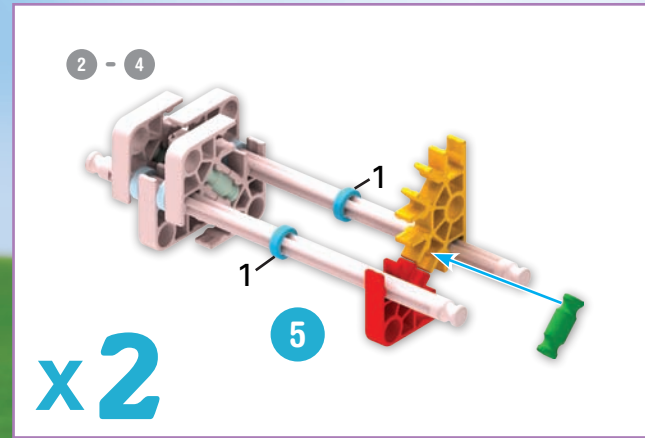
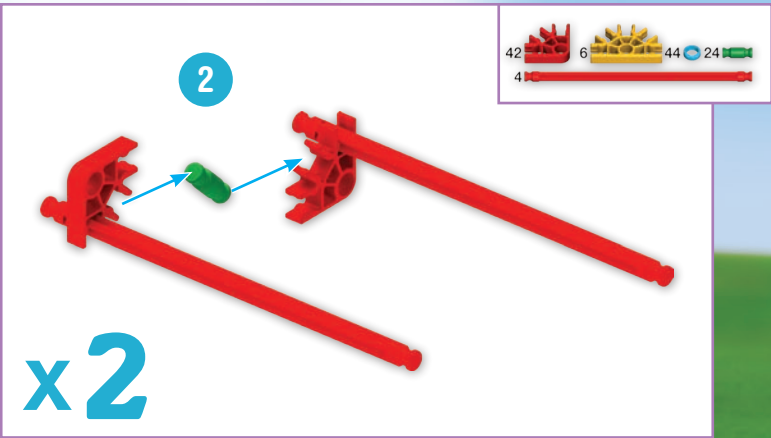
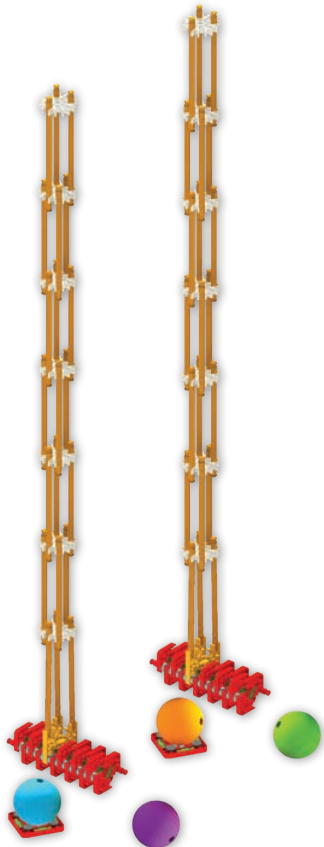

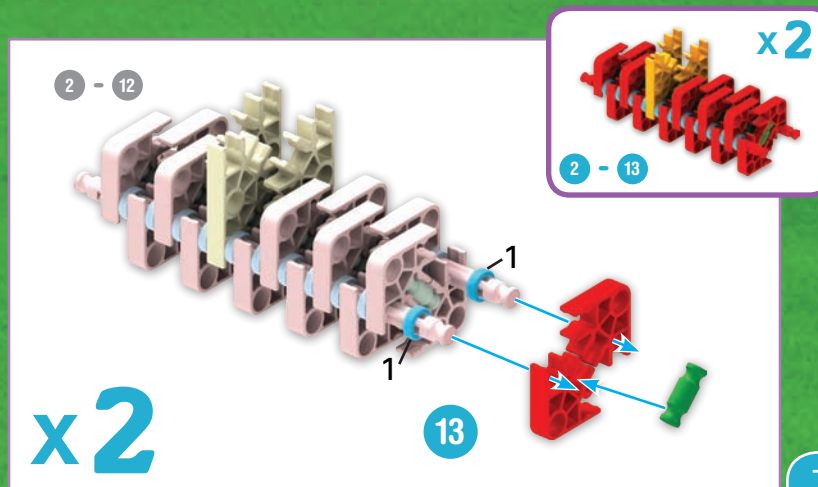
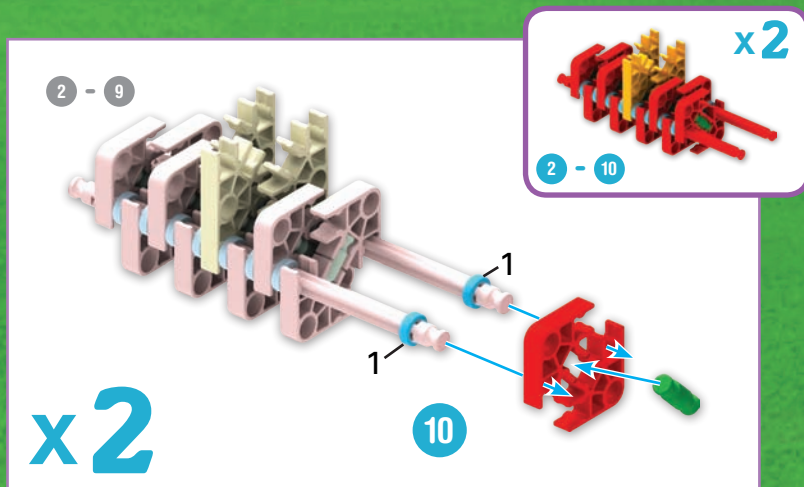
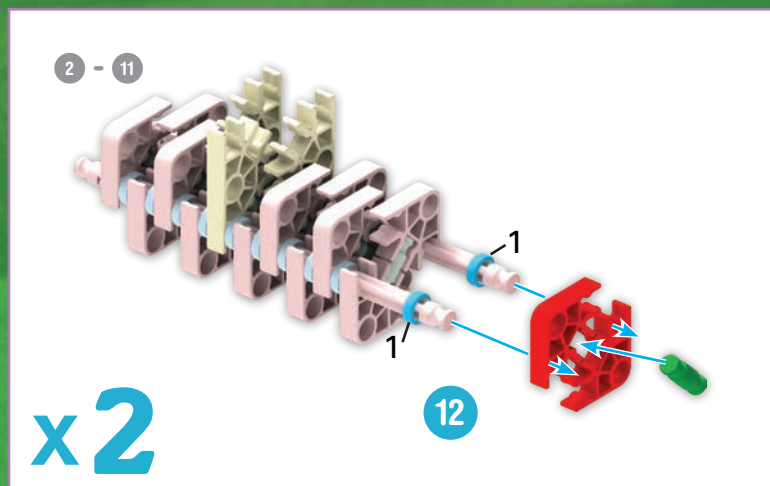
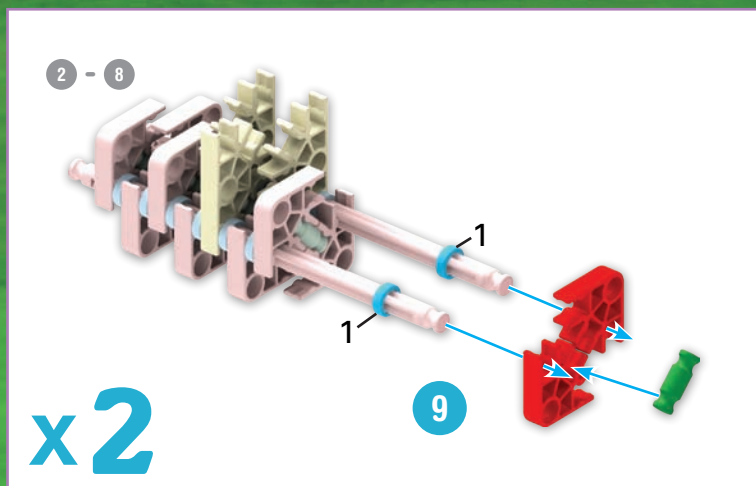
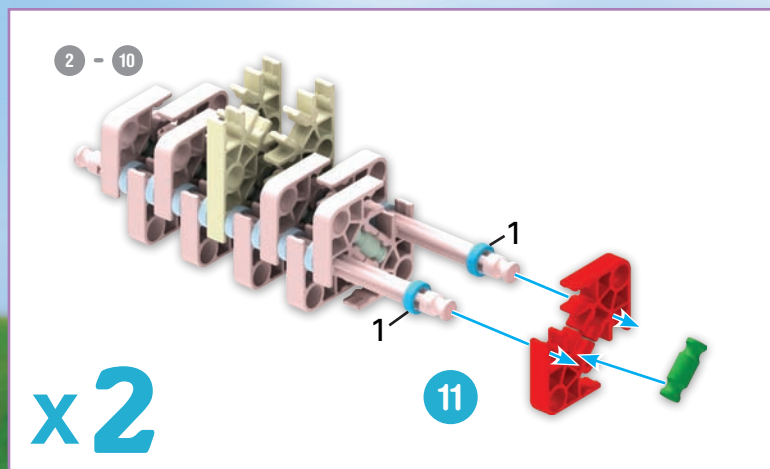
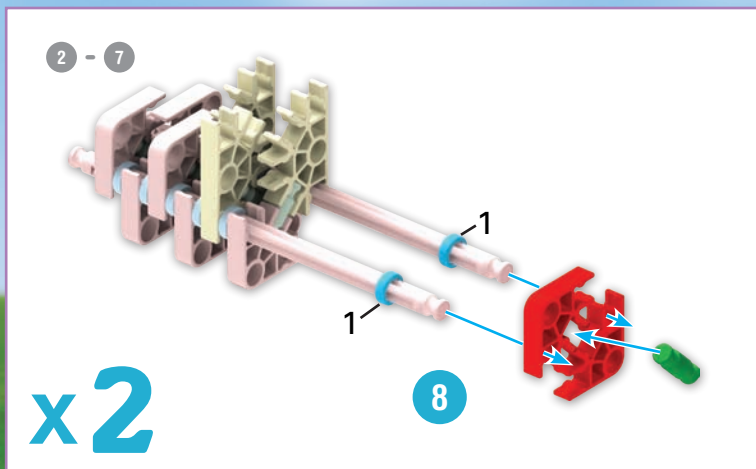

14
42

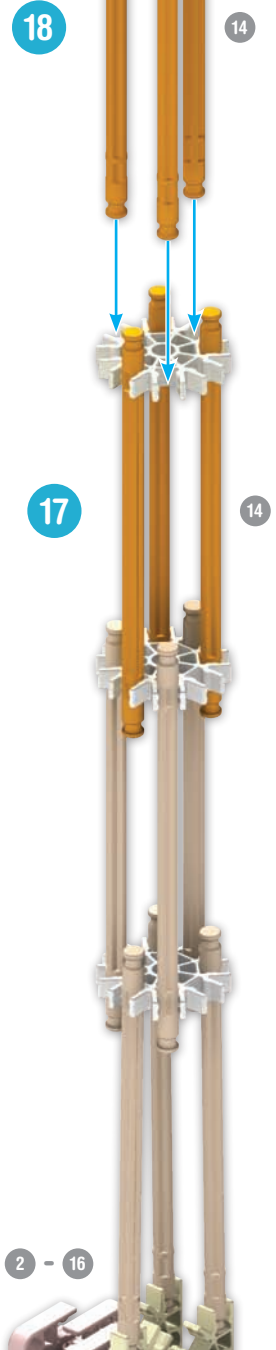
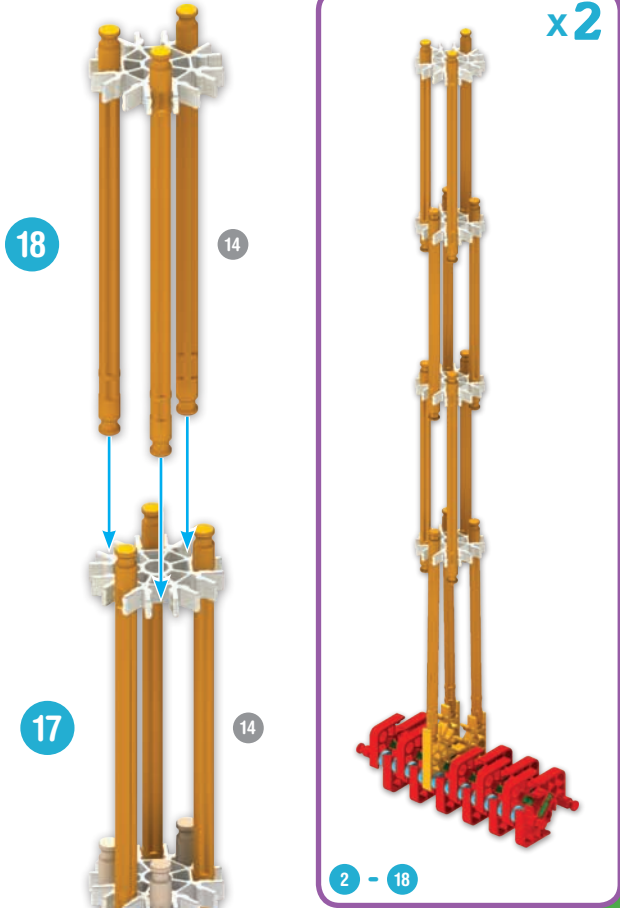
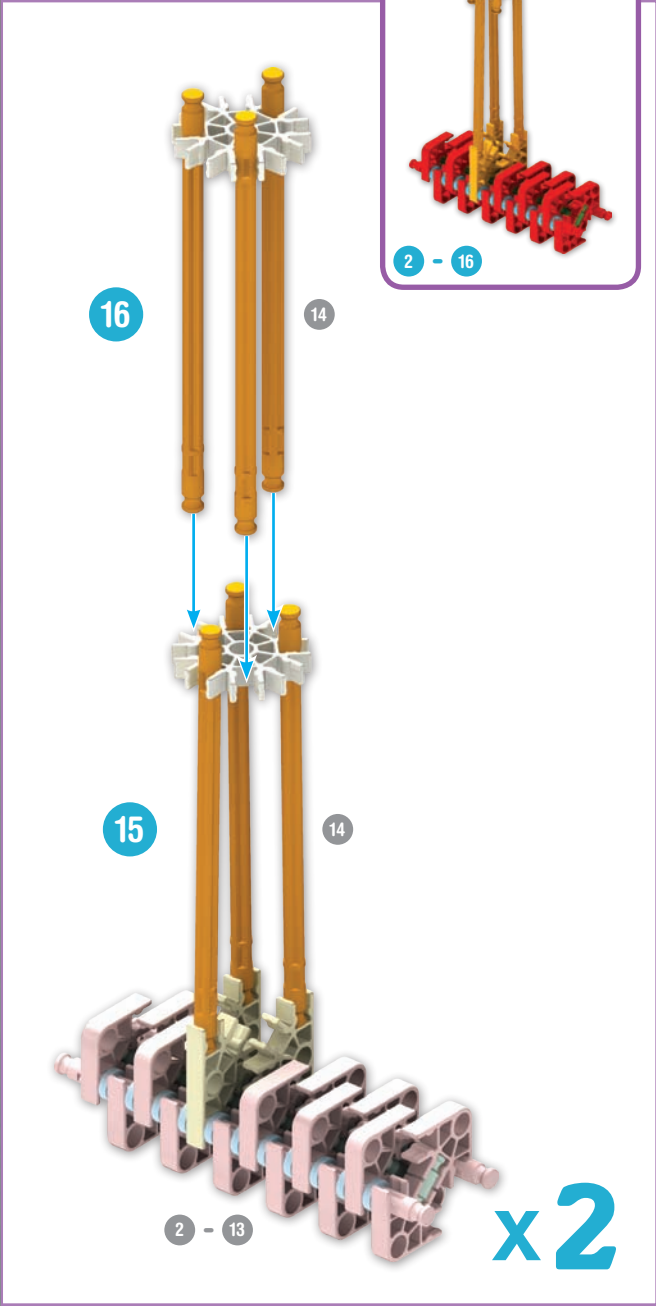
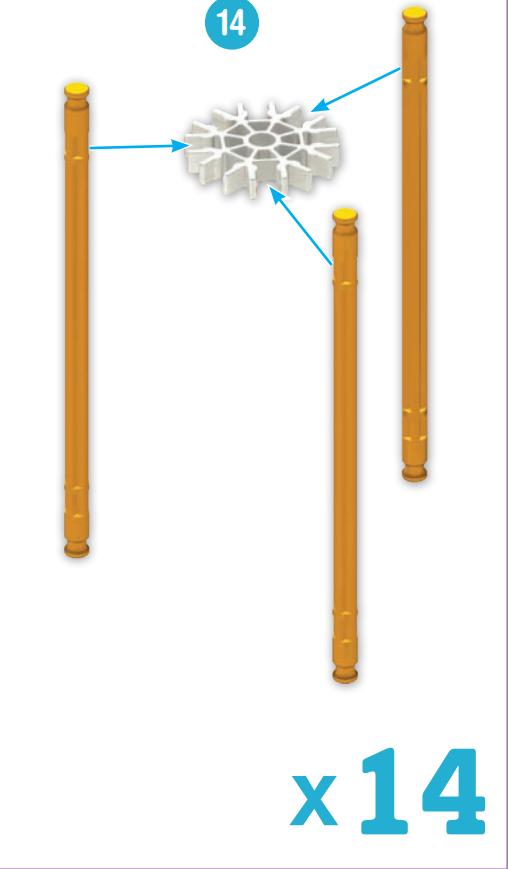
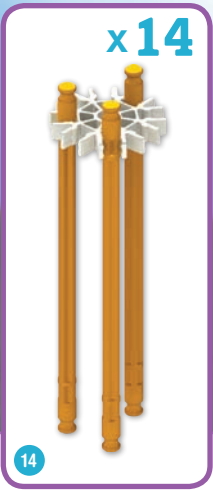

20

14

19

14

2 - 18

x2

x2

2 - 20

21

14

2 - 20

x2

1 - 22



22

x2

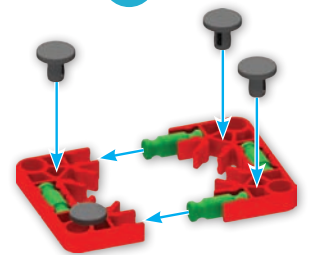

22

HOLE # 1 TROU

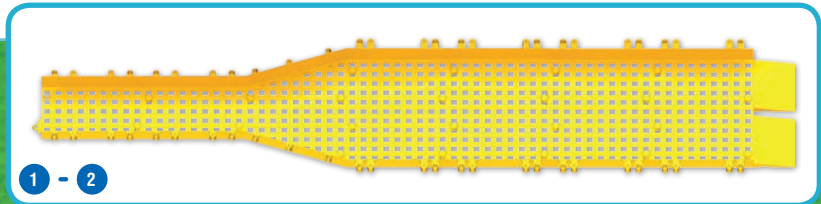
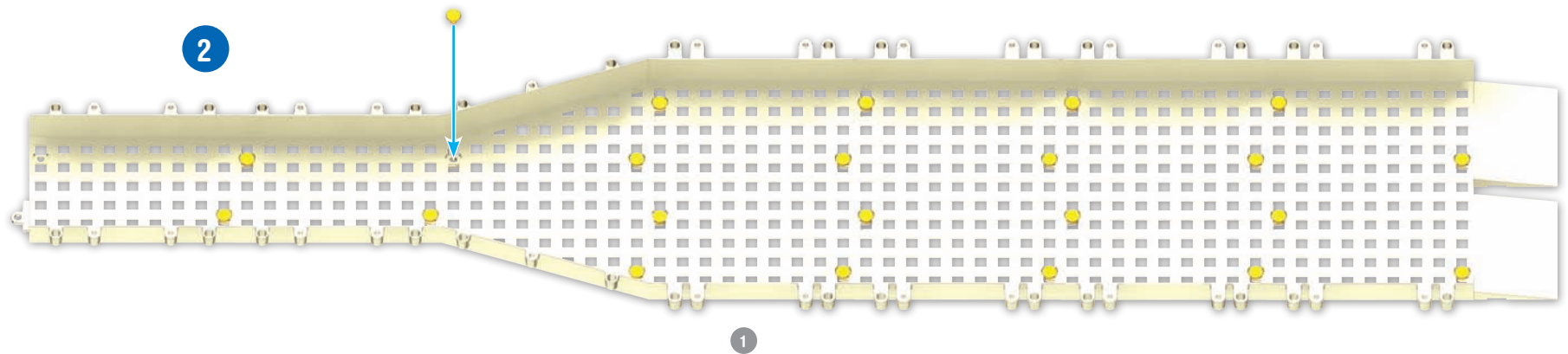
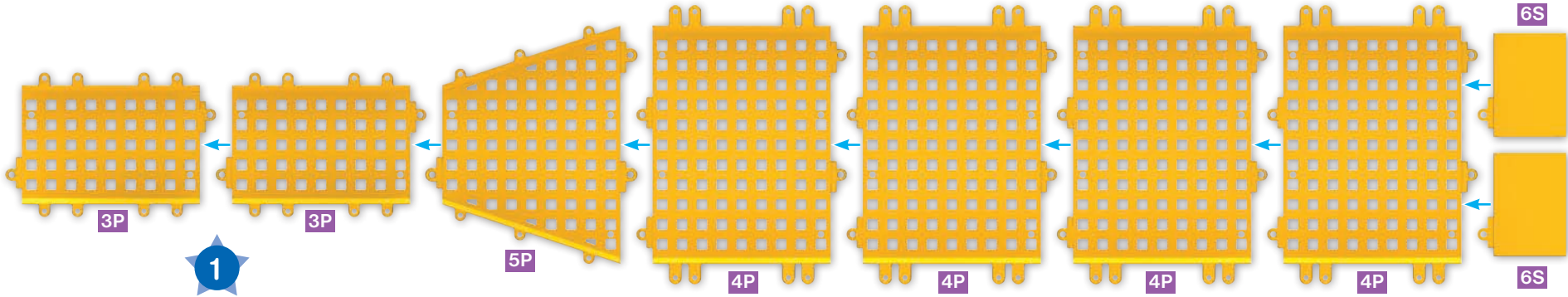
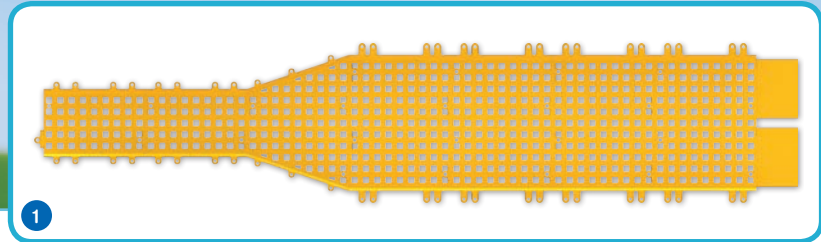

x2

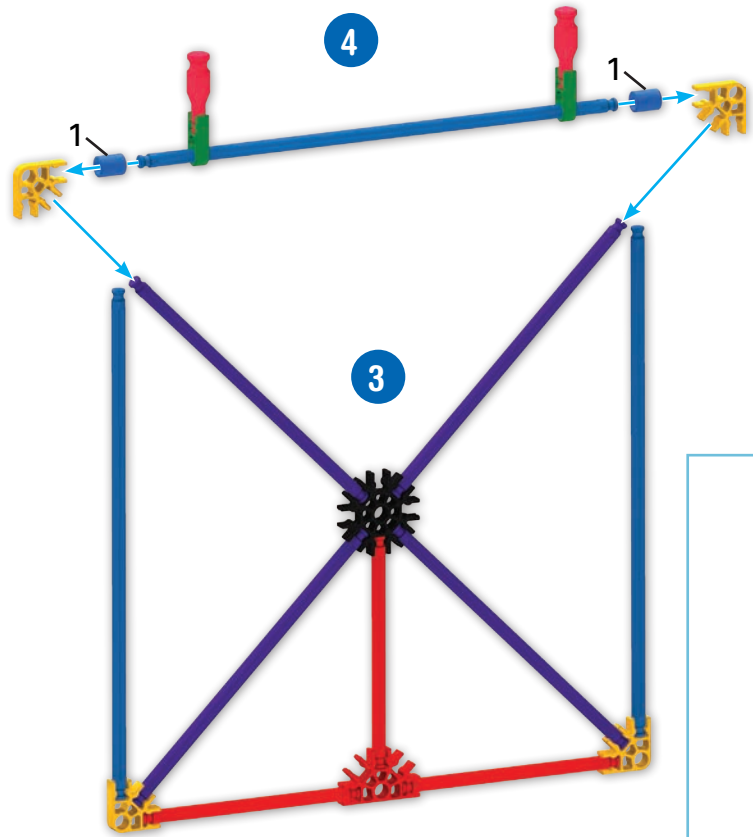

4

3



5 - 7

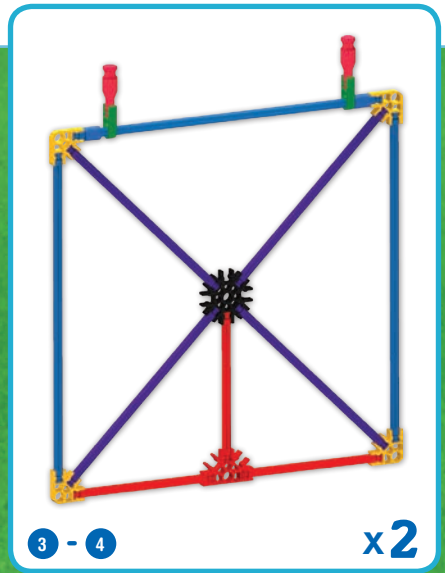
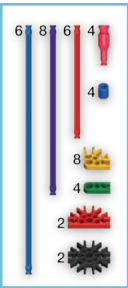

3 - 4

x2

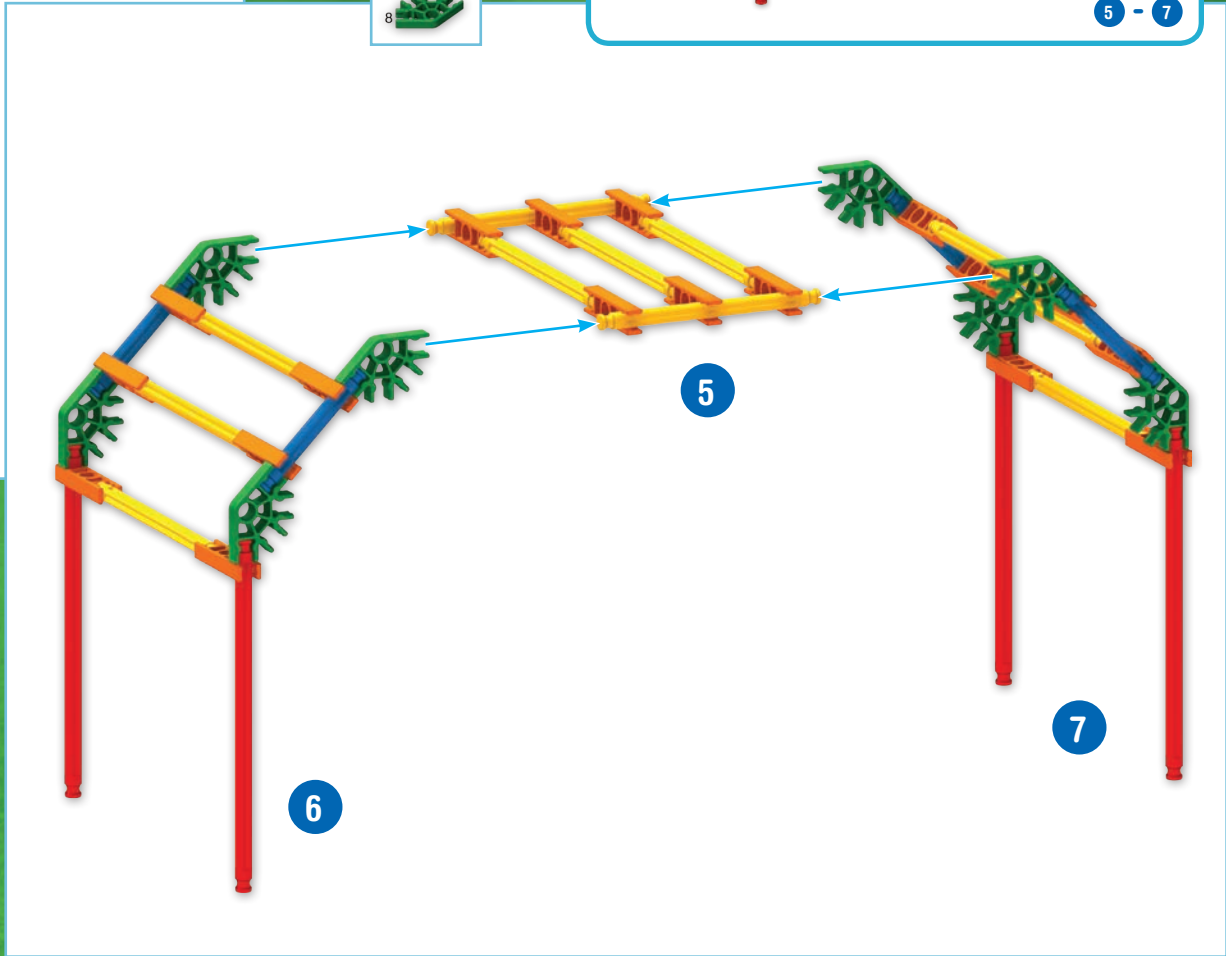

5

6

7

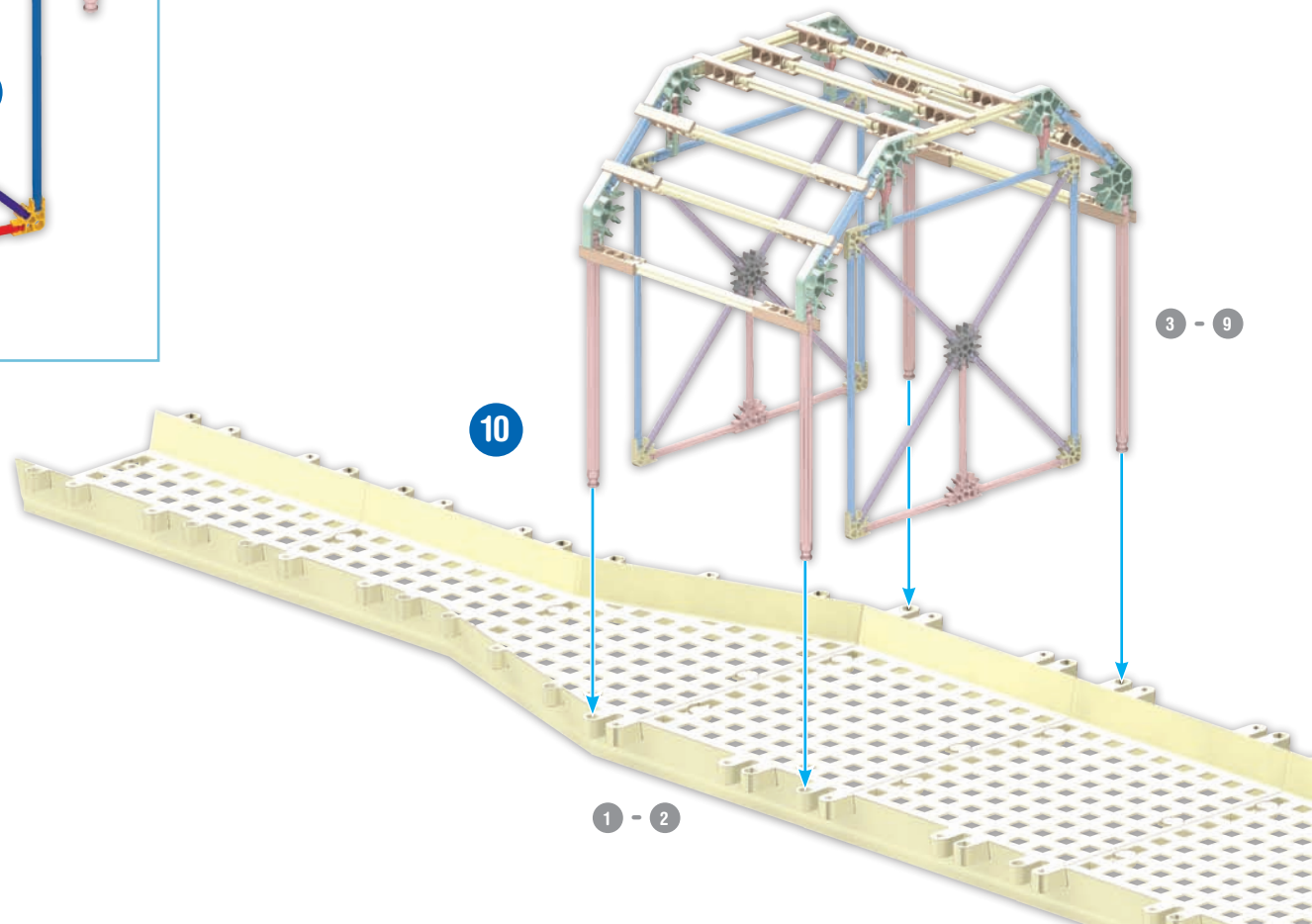
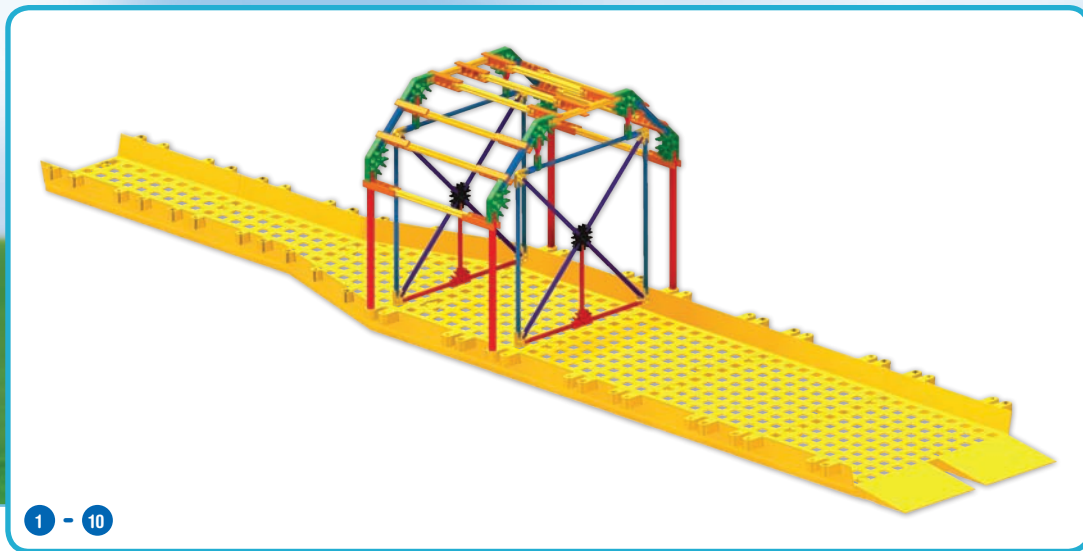
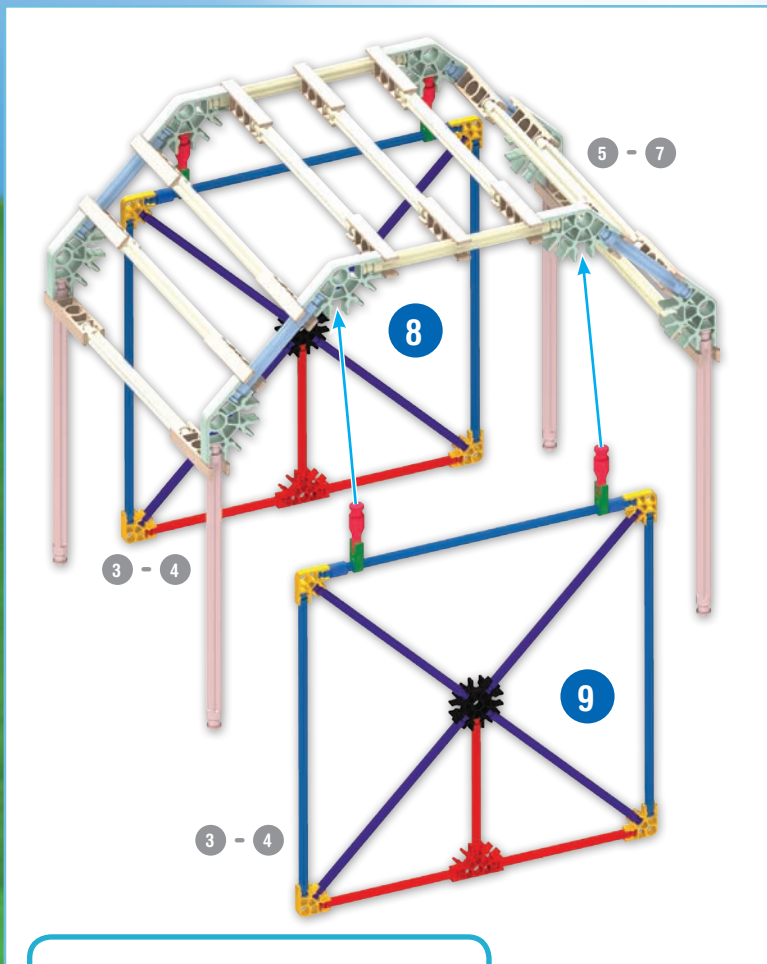

1 - 14

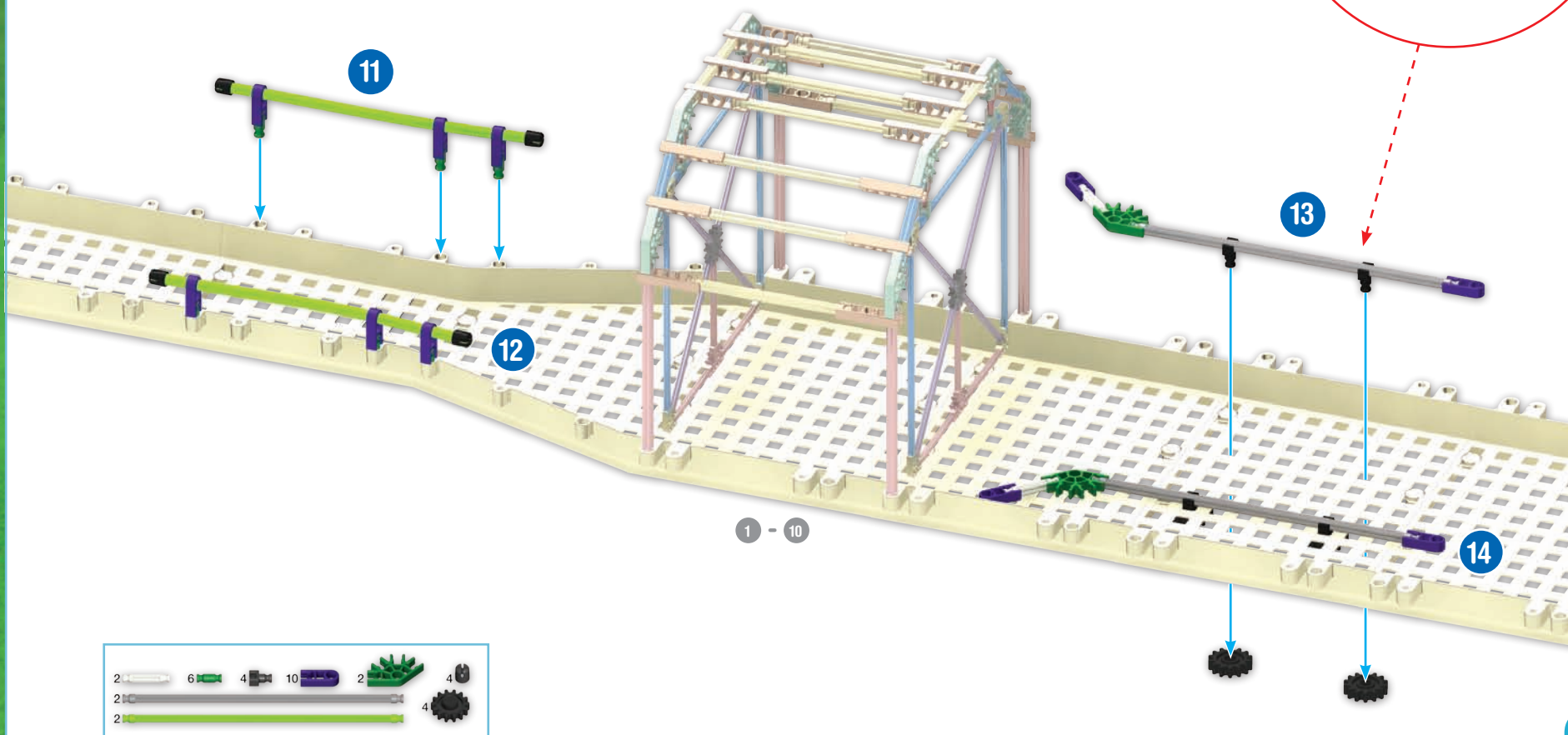
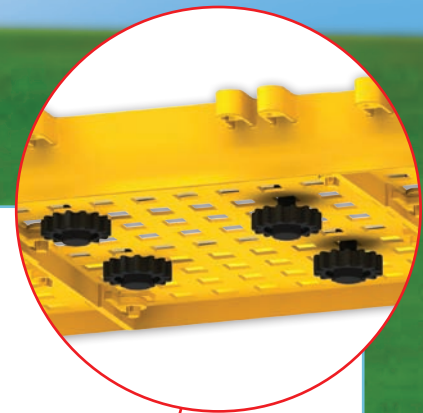

- 2 grey axles
- 6 green axles
- 4 purple pins
- 10 purple pins
- 2 green bushes
- 4 black gears
- 2 grey axles
- 2 green axles

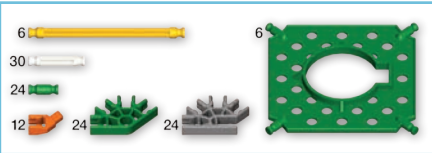
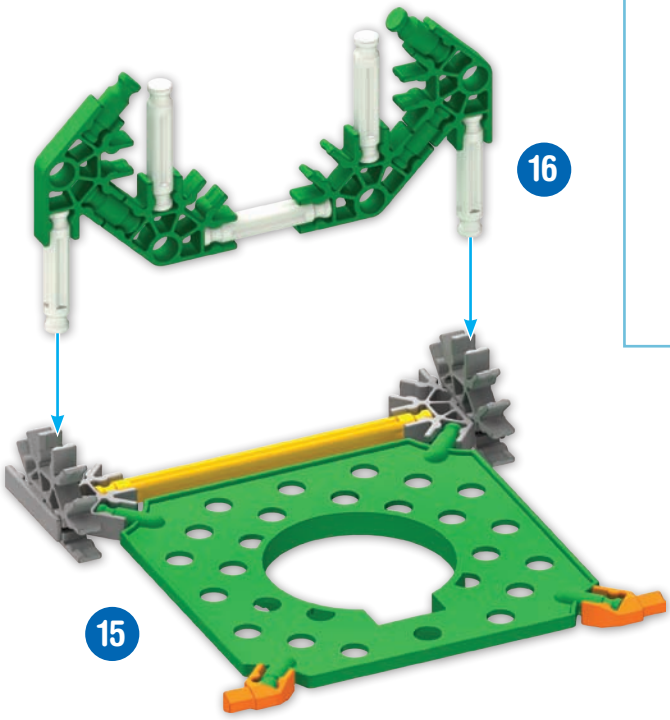
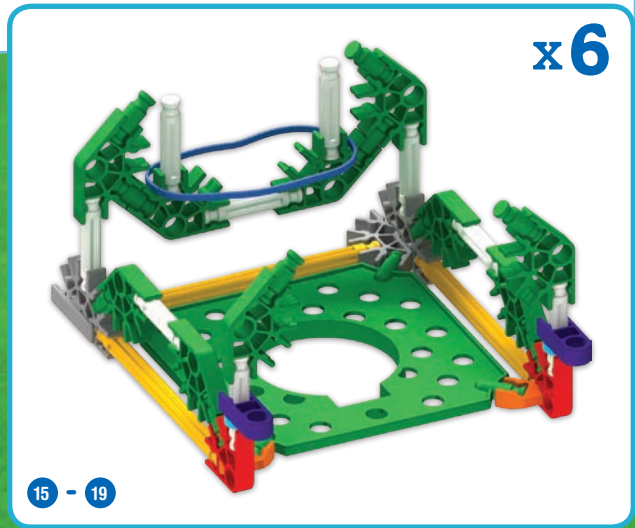
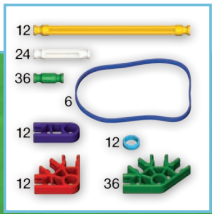
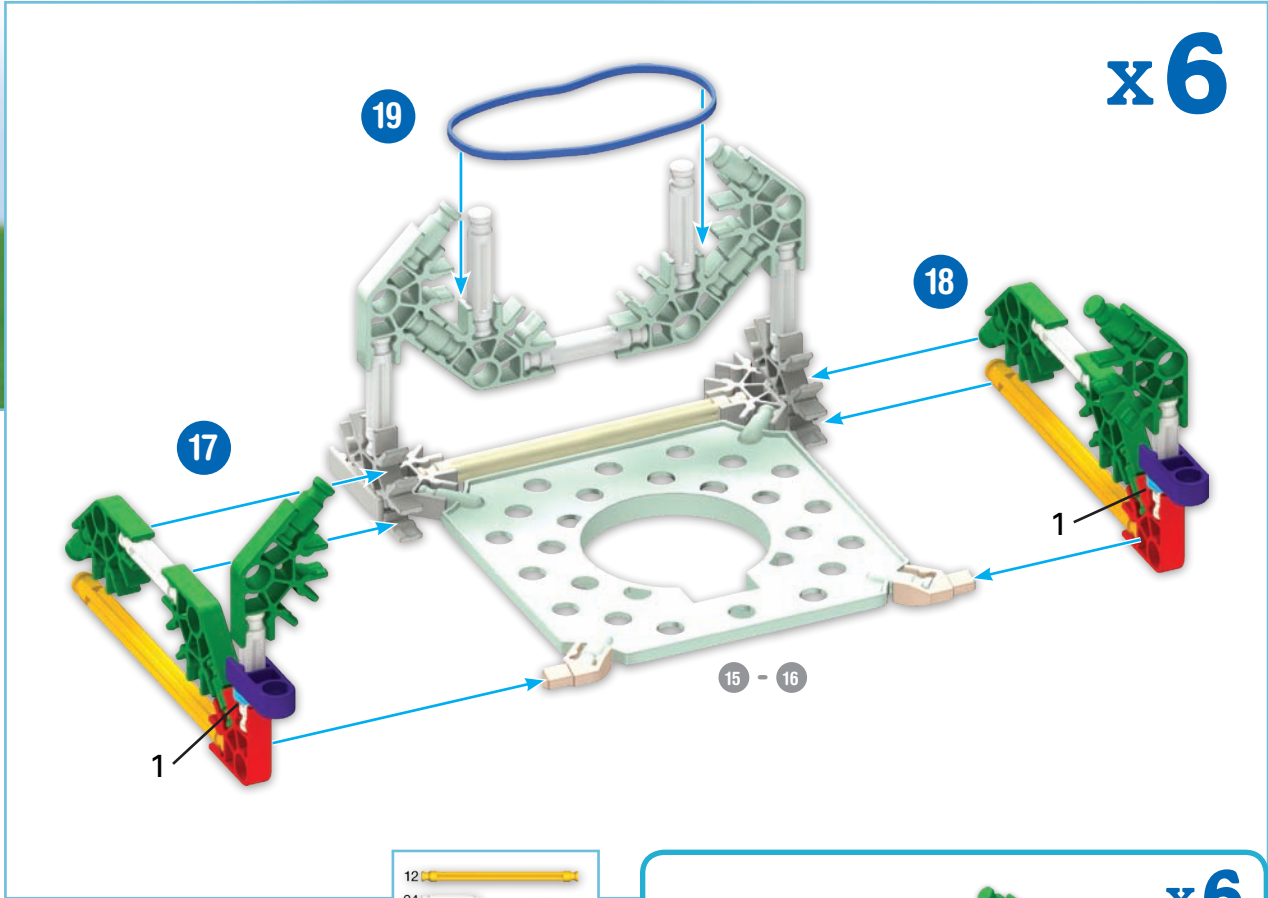
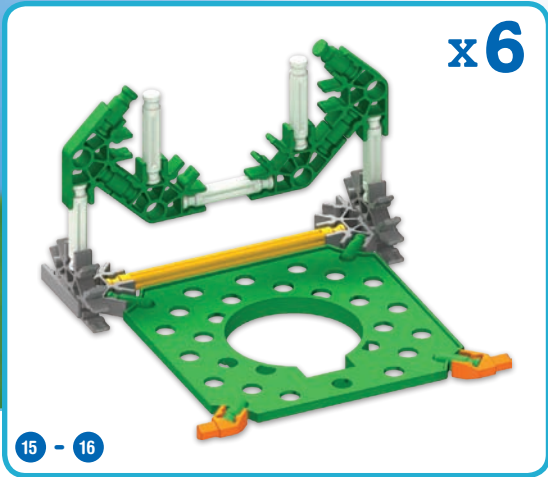

x6

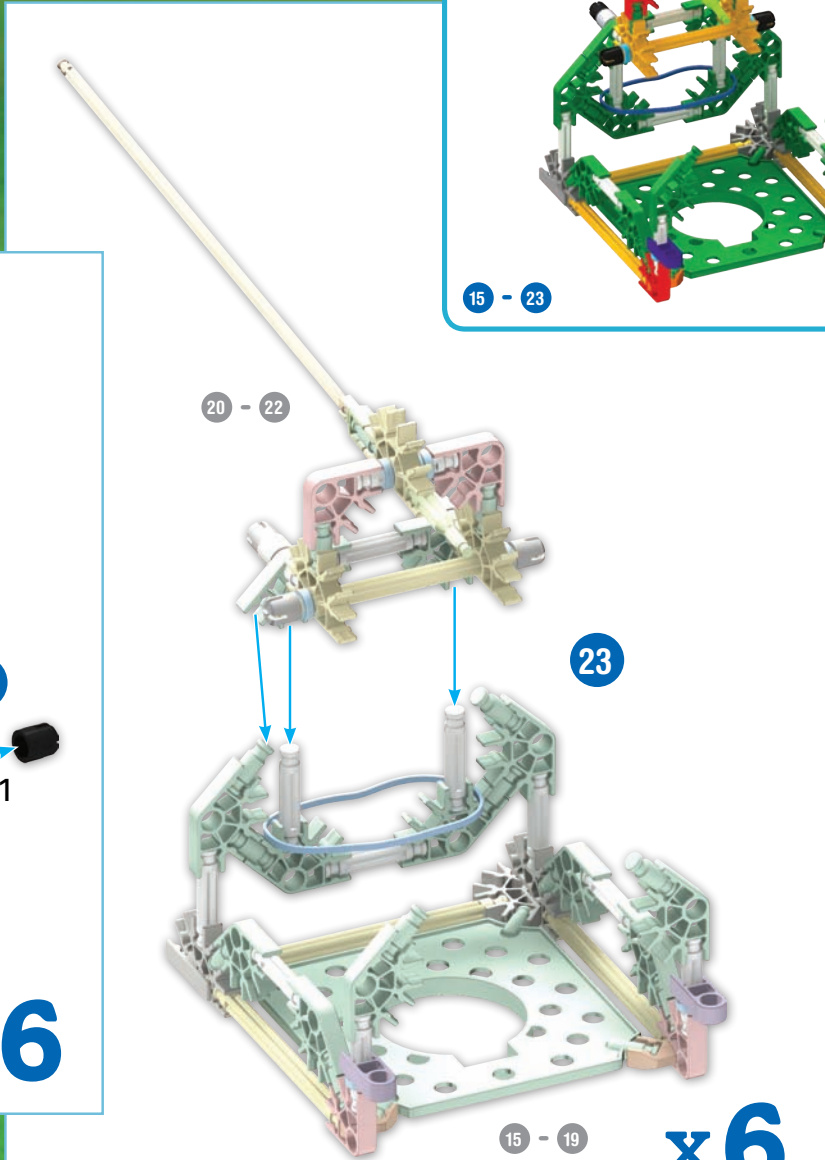
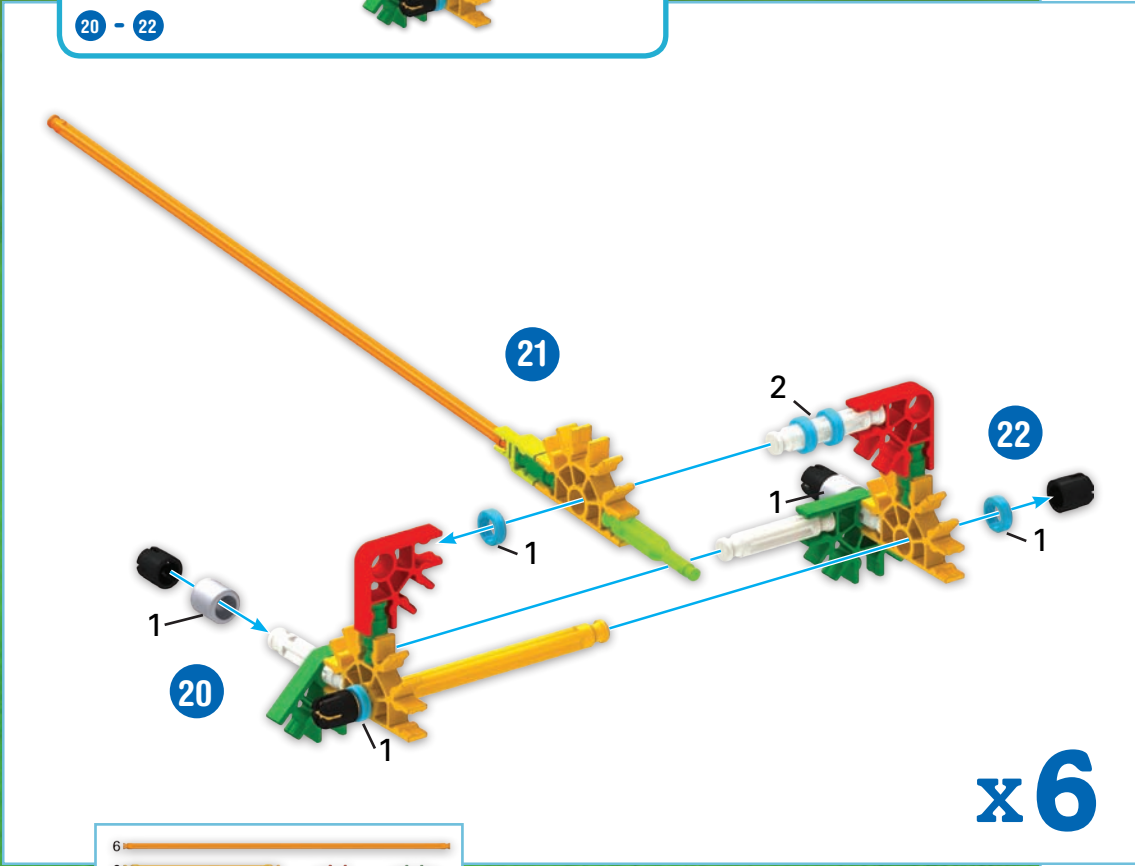
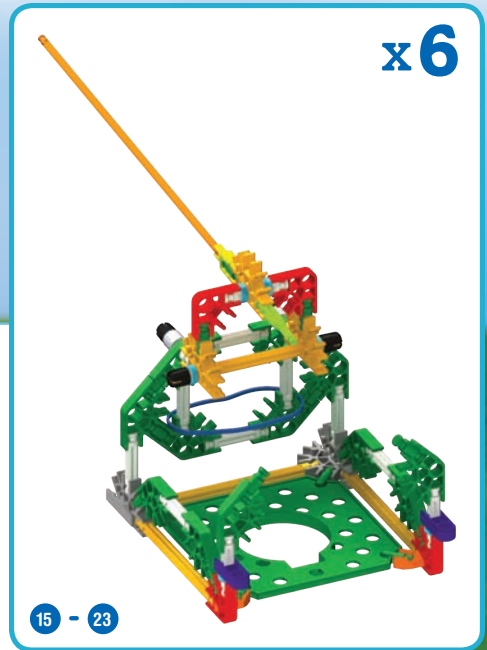

- | | | | | | |
|----|---|----|----|----|----|
| 6 | 6 | 24 | 30 | 12 | 12 |
| 18 | 6 | 12 | 6 | 18 | |

x6

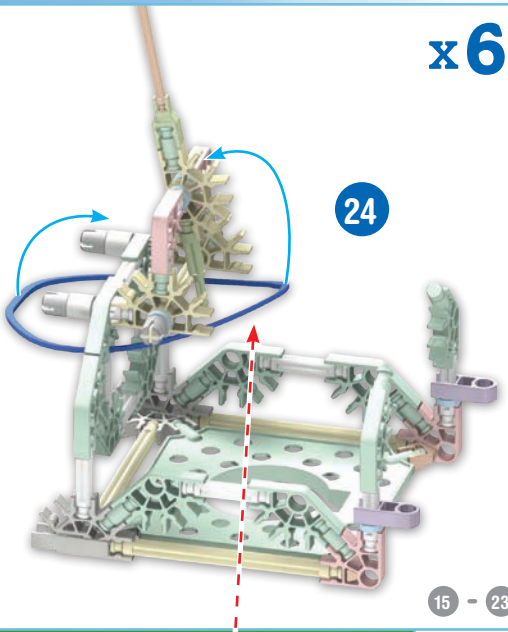

24

15 - 23

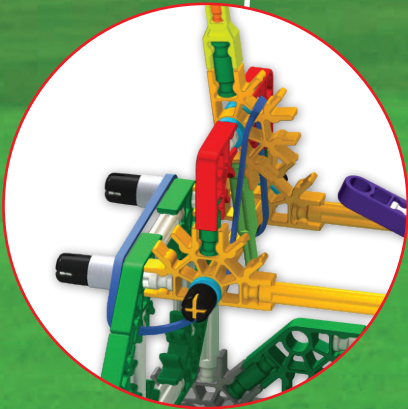

x6



HOLE: #1, #2, #3, #5, #8, #9
 TROU:

15 - 25

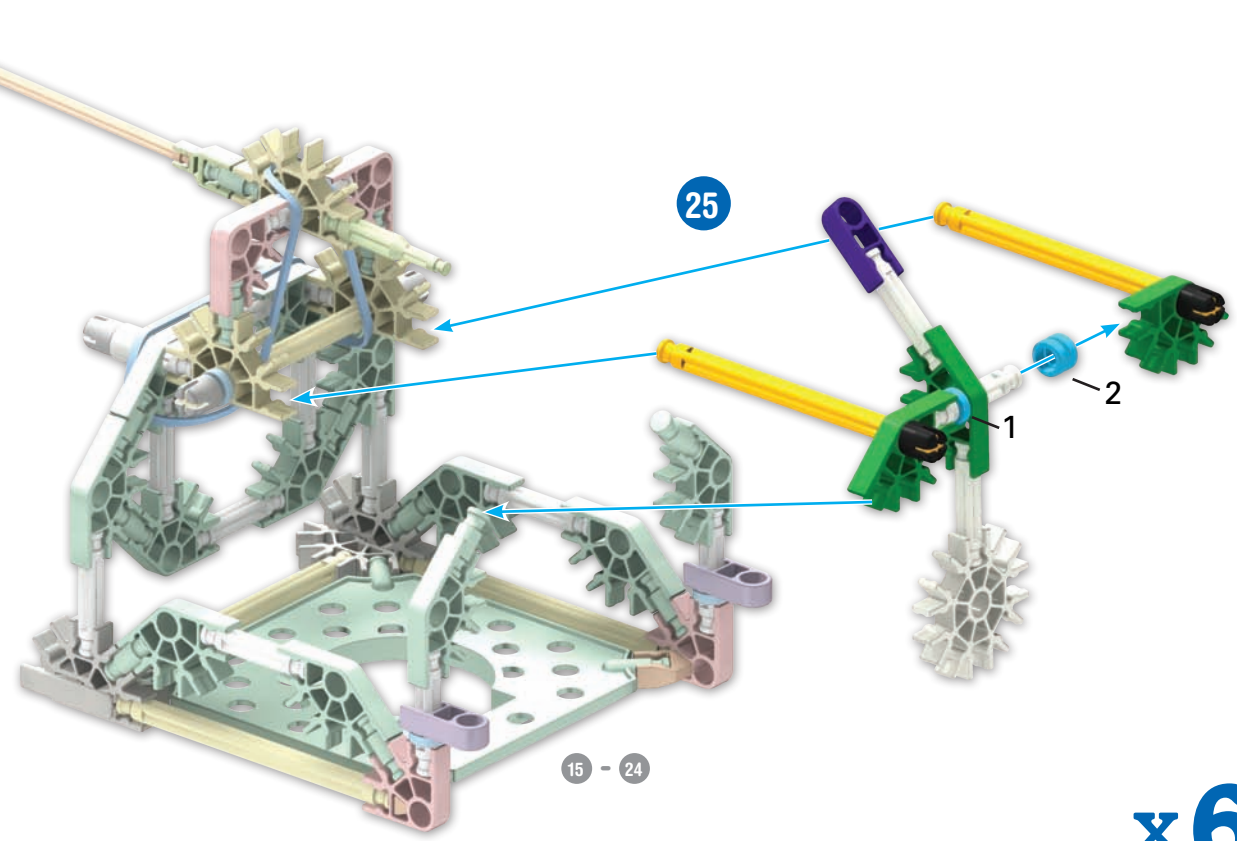

25

15 - 24

- 12
- 18
- 18
- 12
- 6
- 6

x6

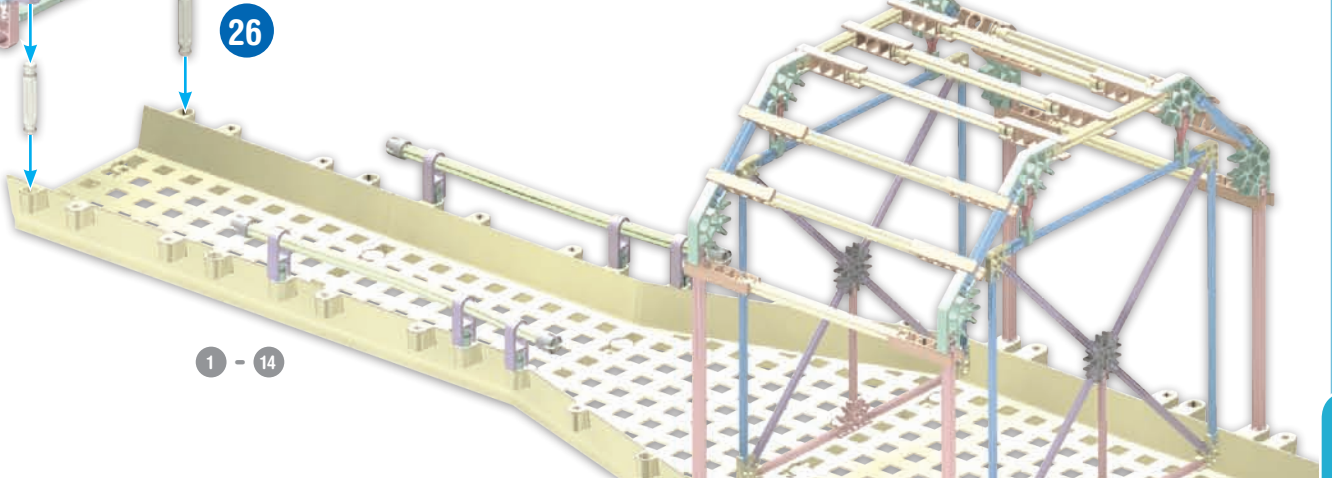
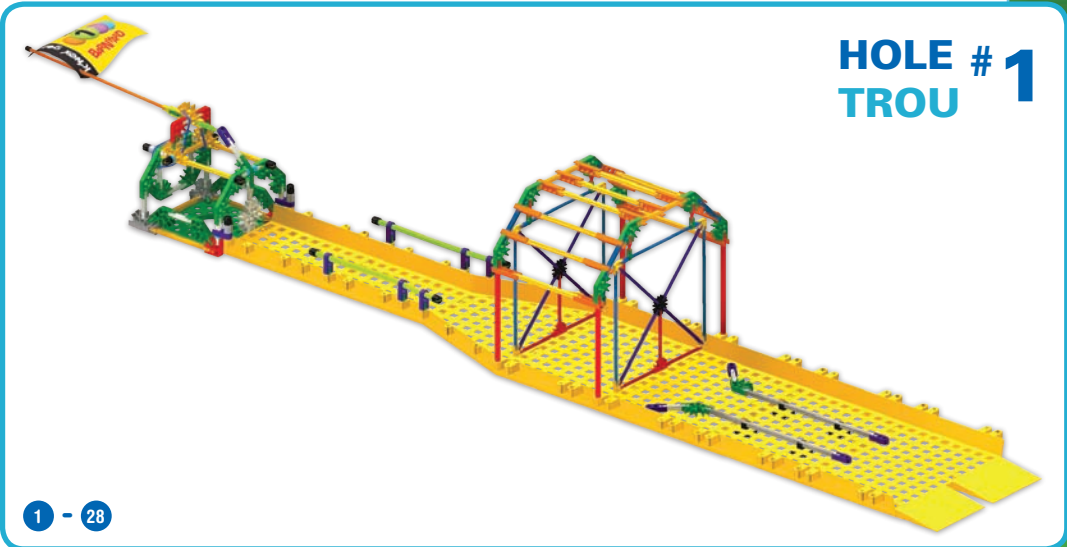
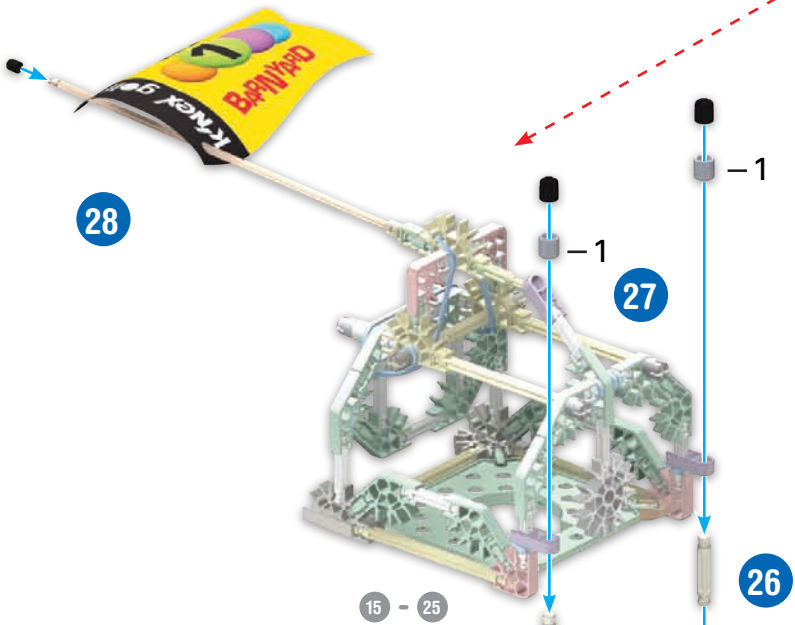
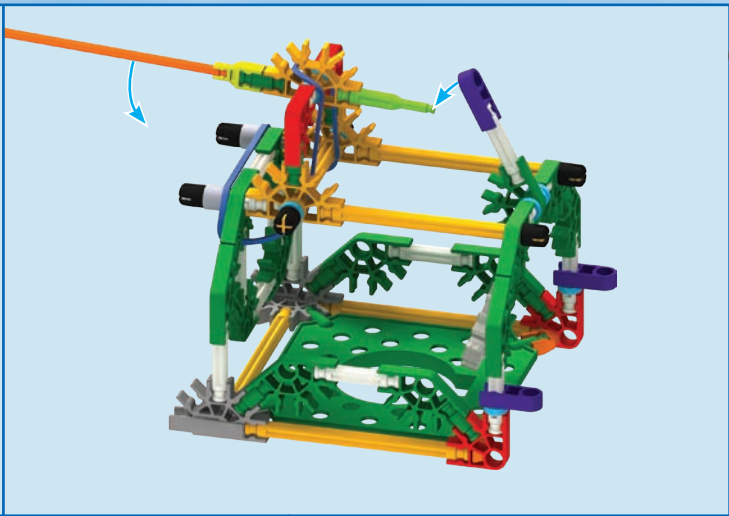

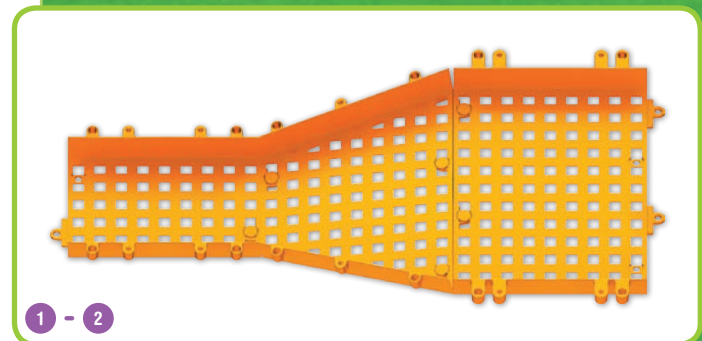
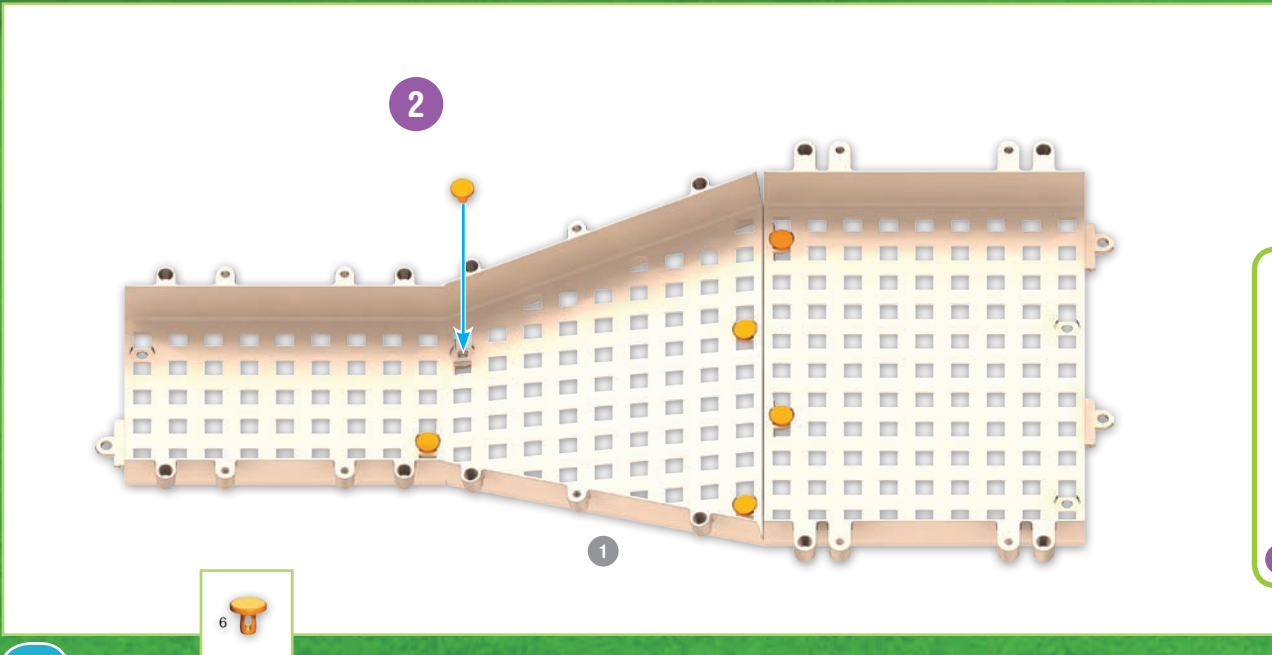
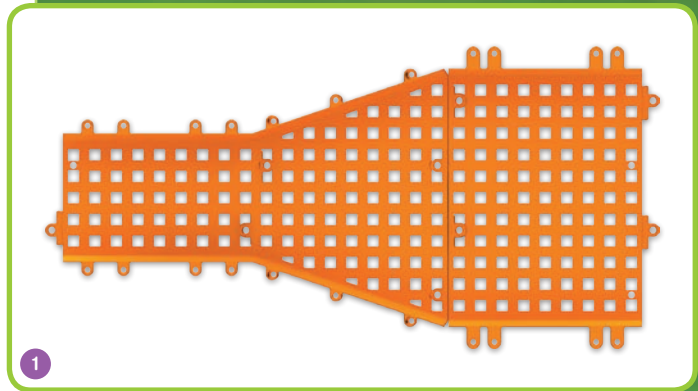
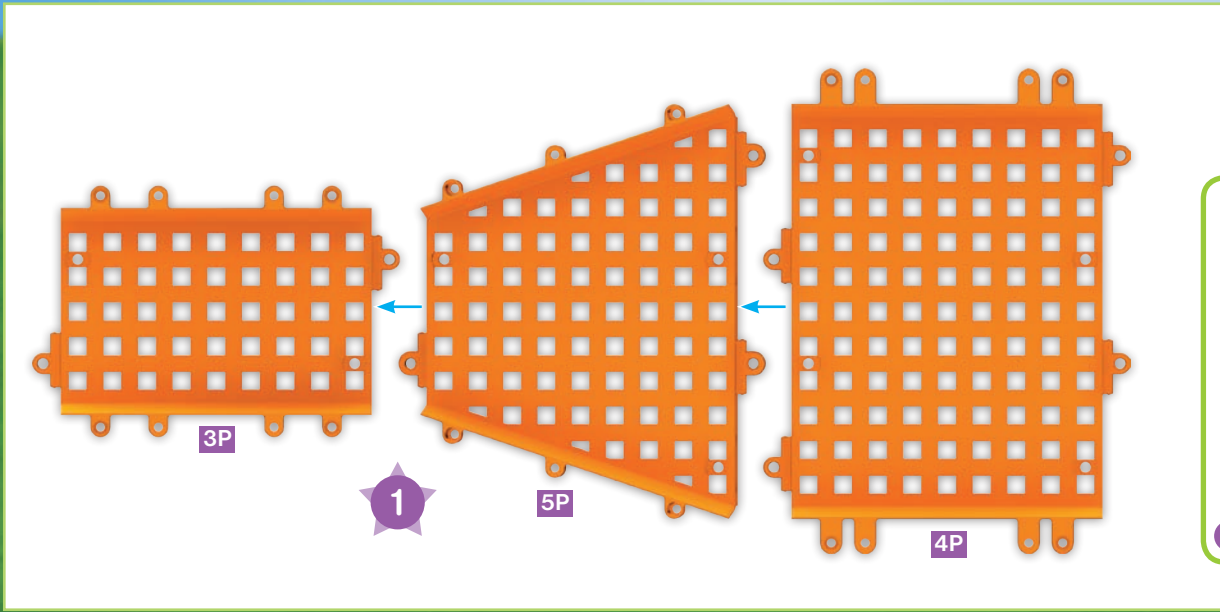

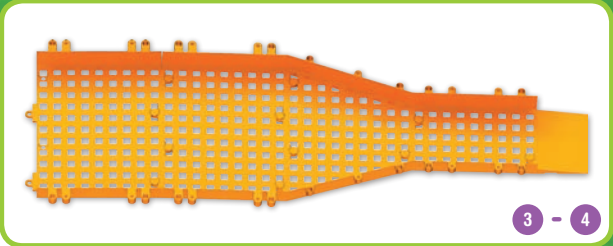
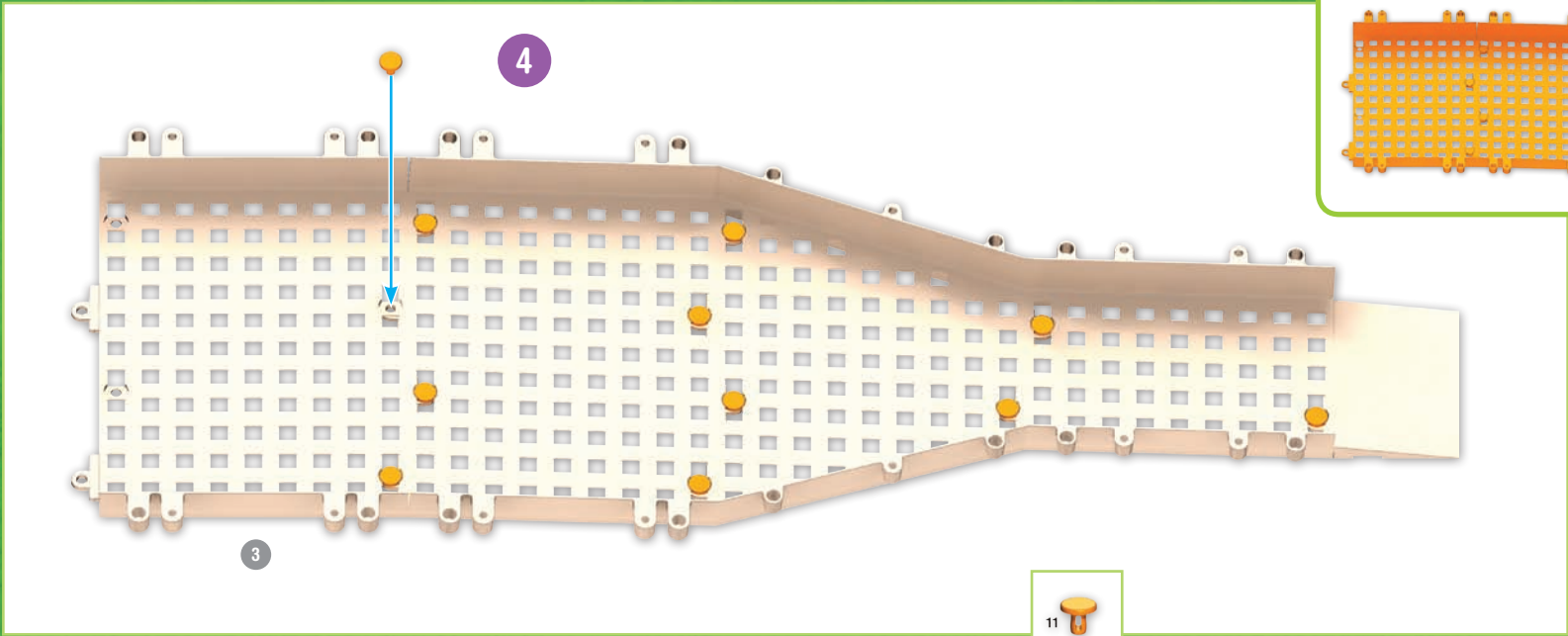
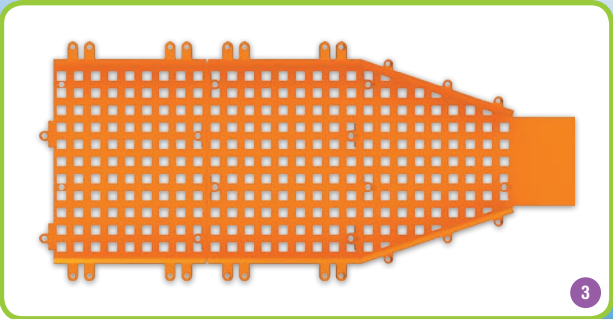
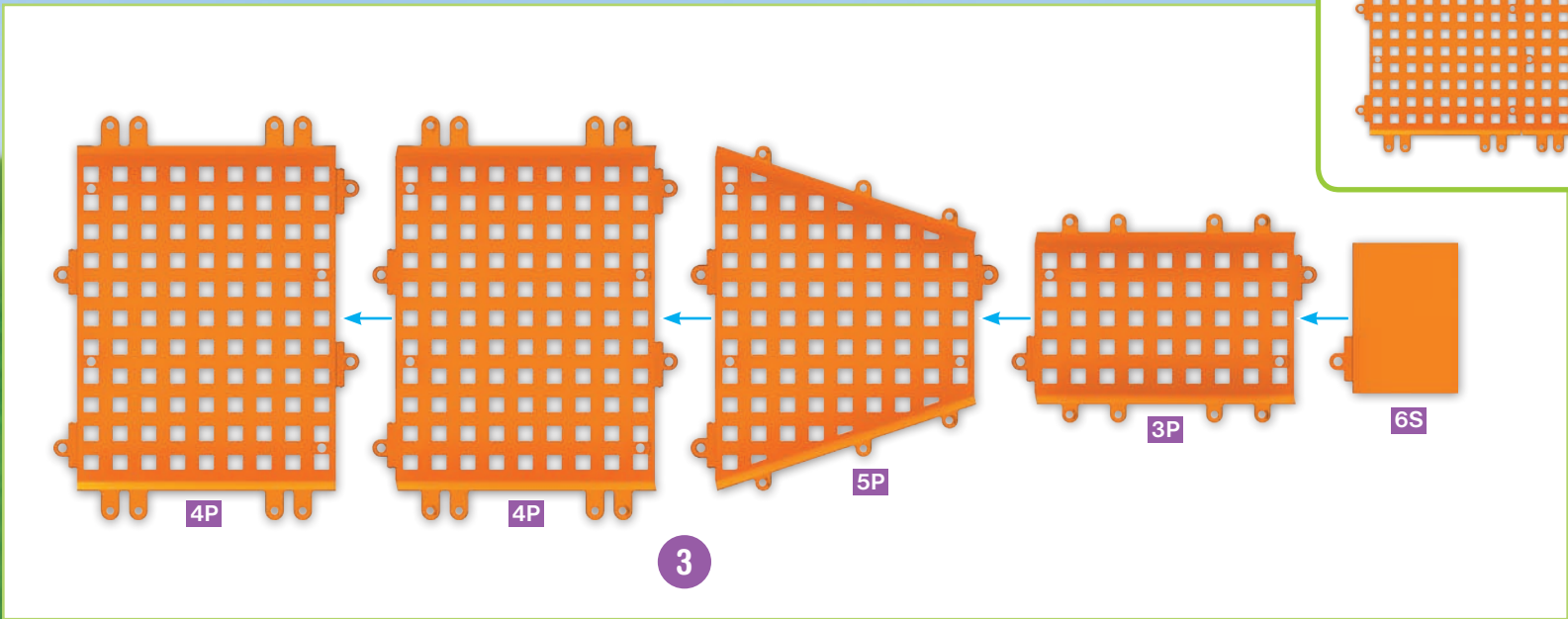

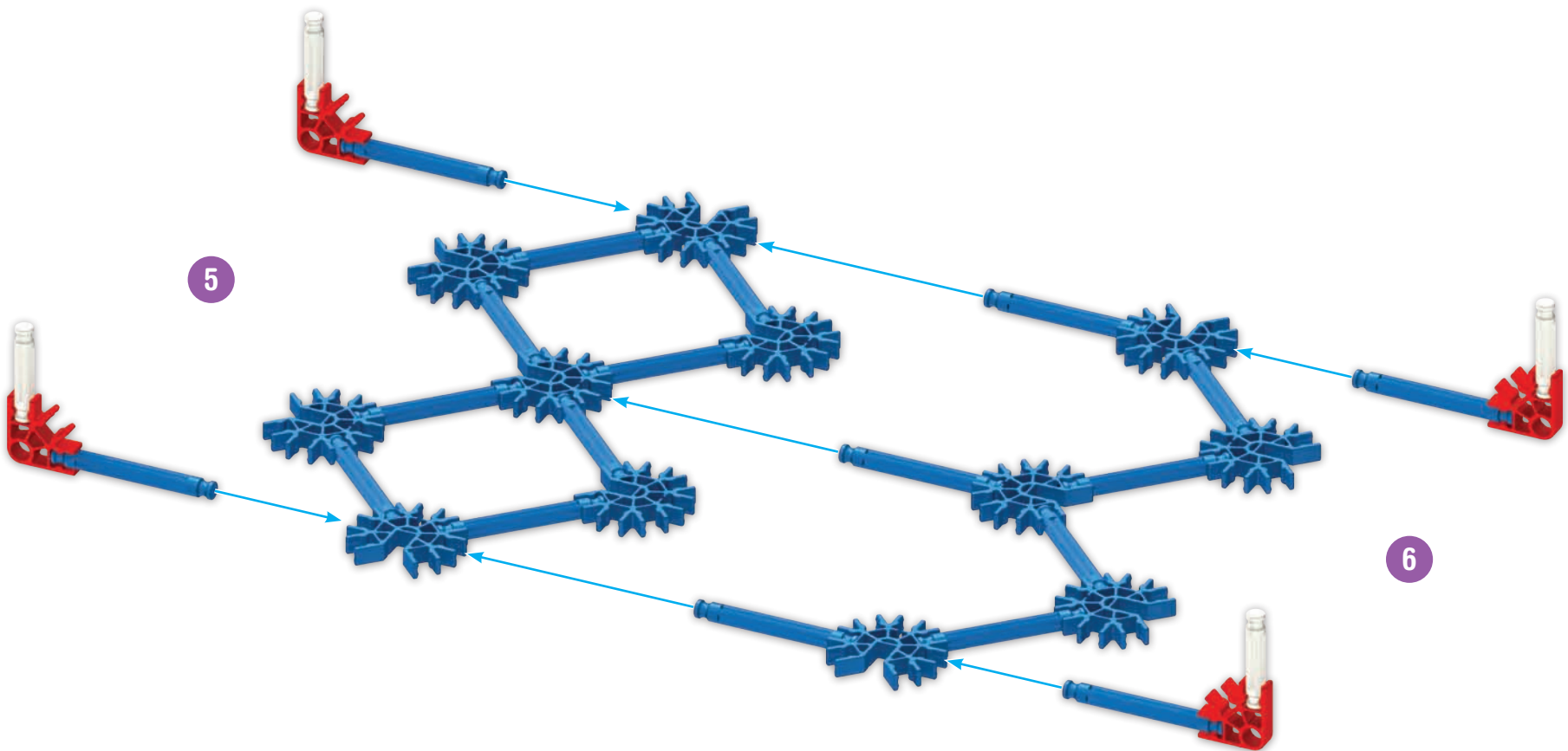
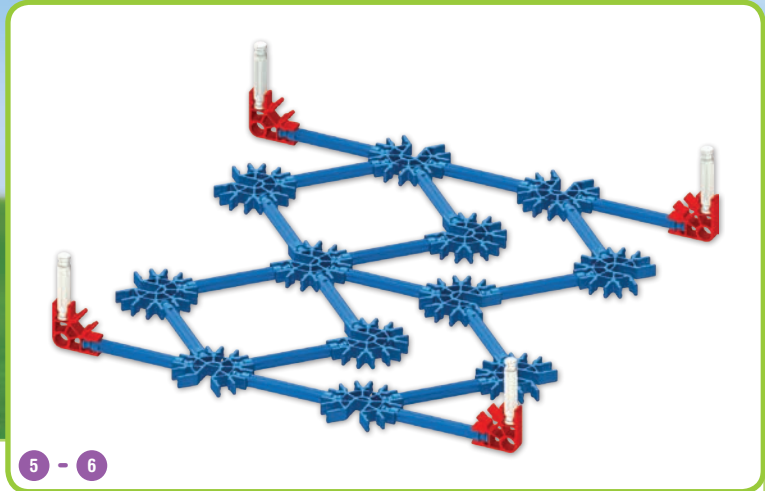
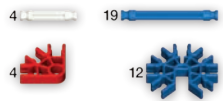

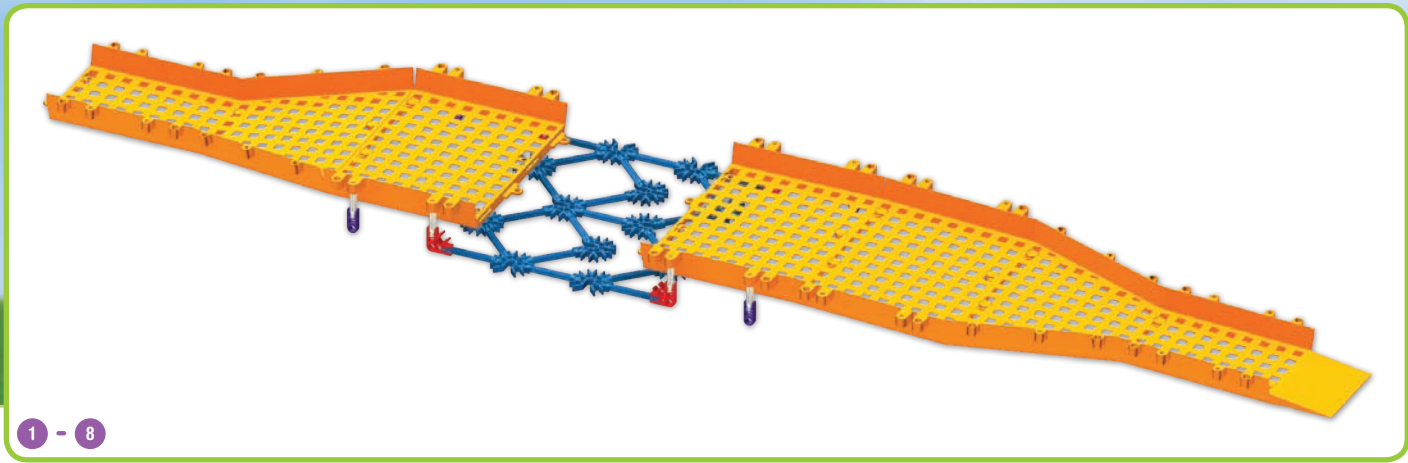

- 4
- 4

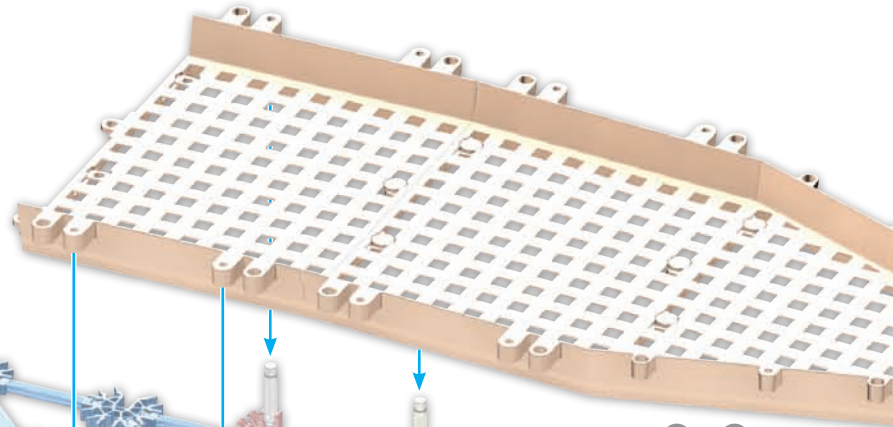
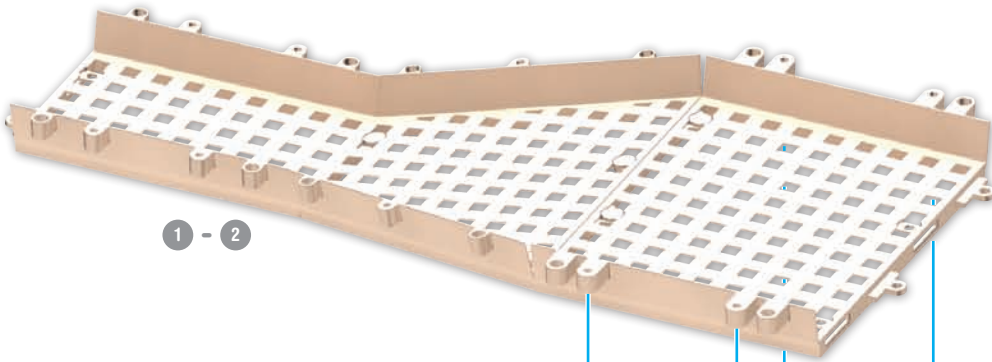

7

8

5 - 6

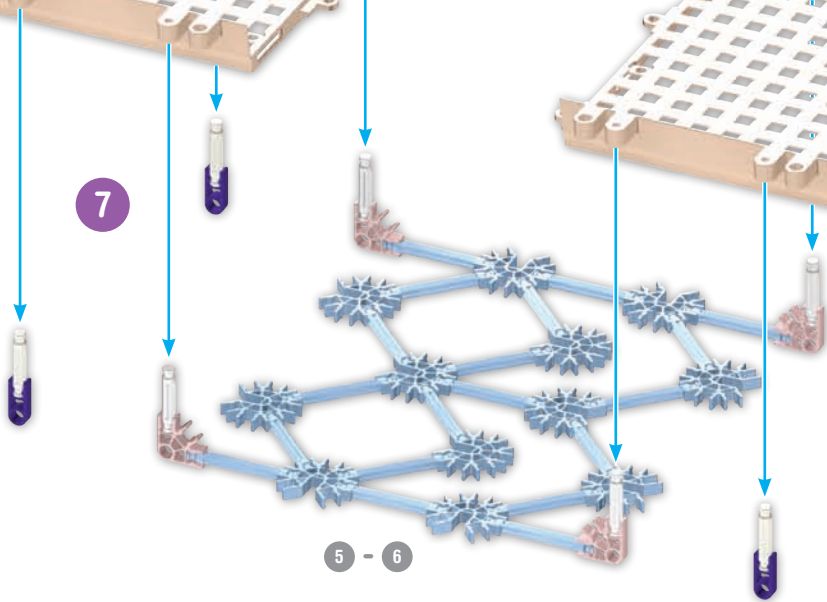

x4

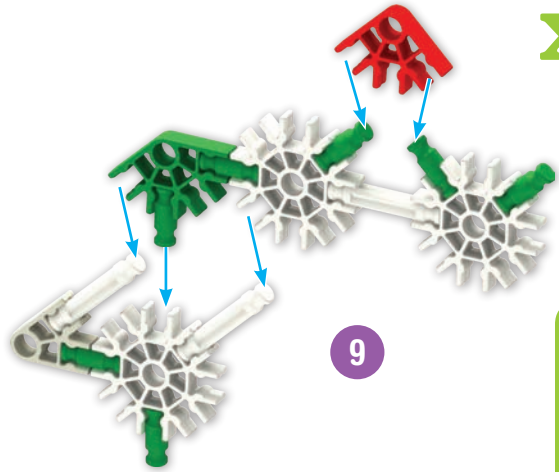

9



x4

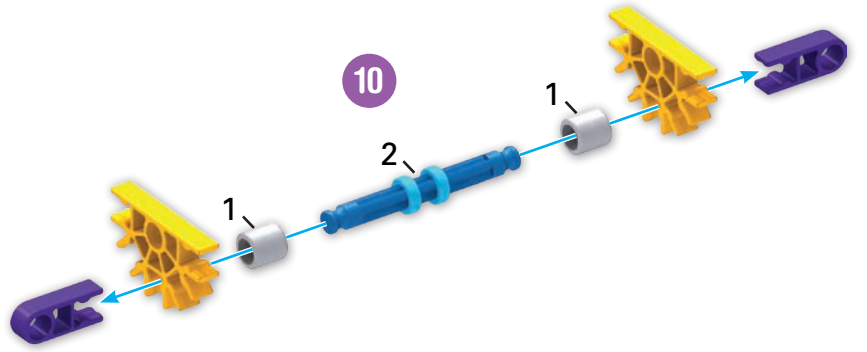
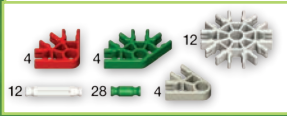

10

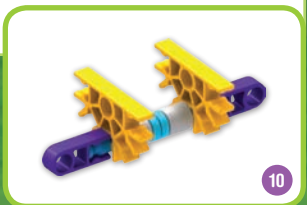
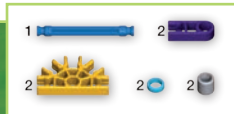

10

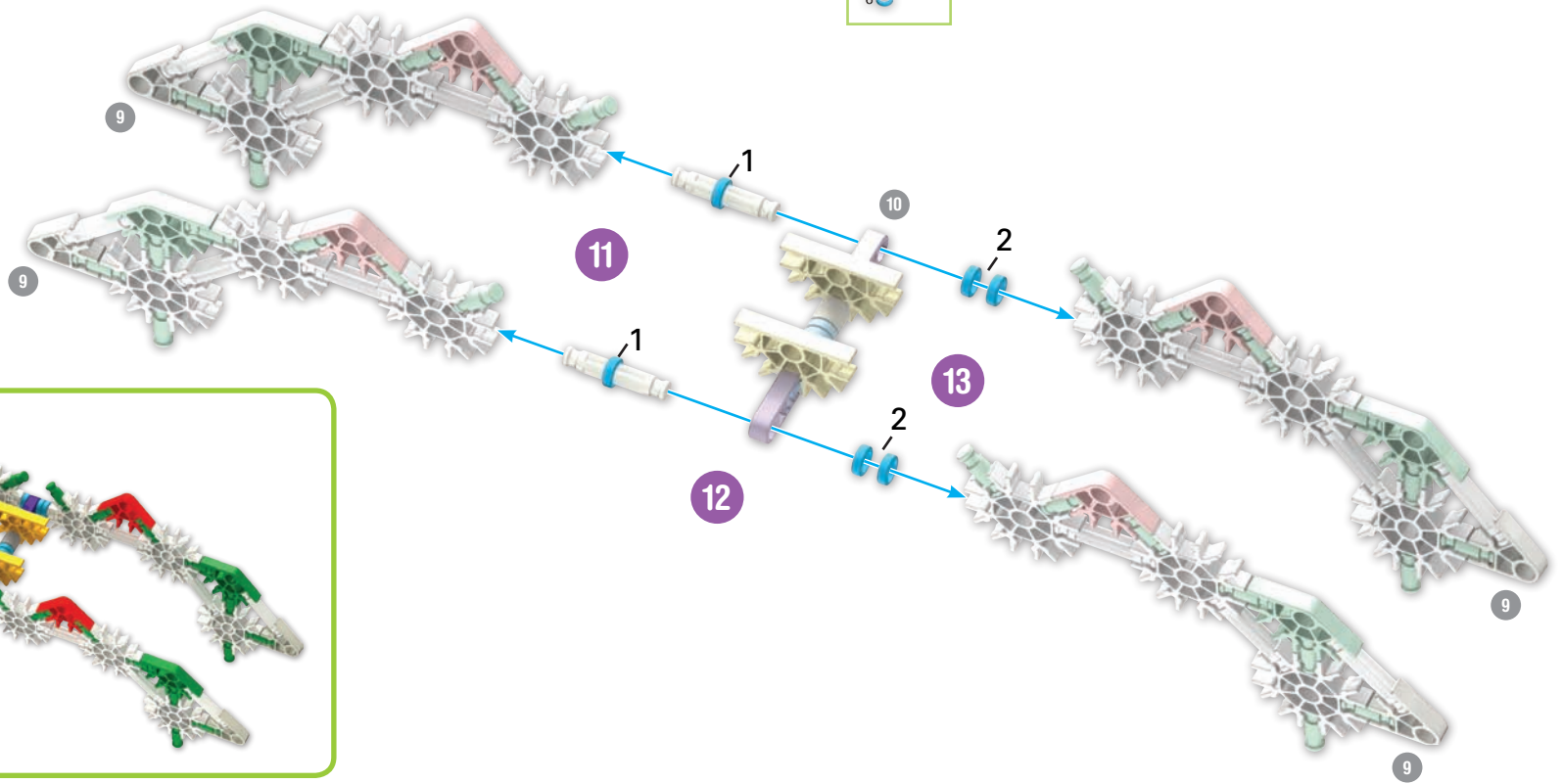

9

11

10

13

12

9

9



9 - 13

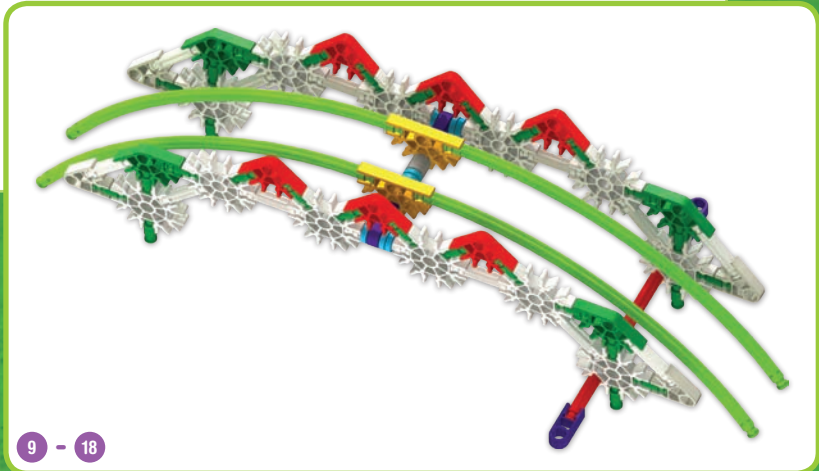
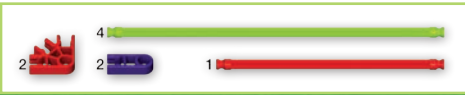
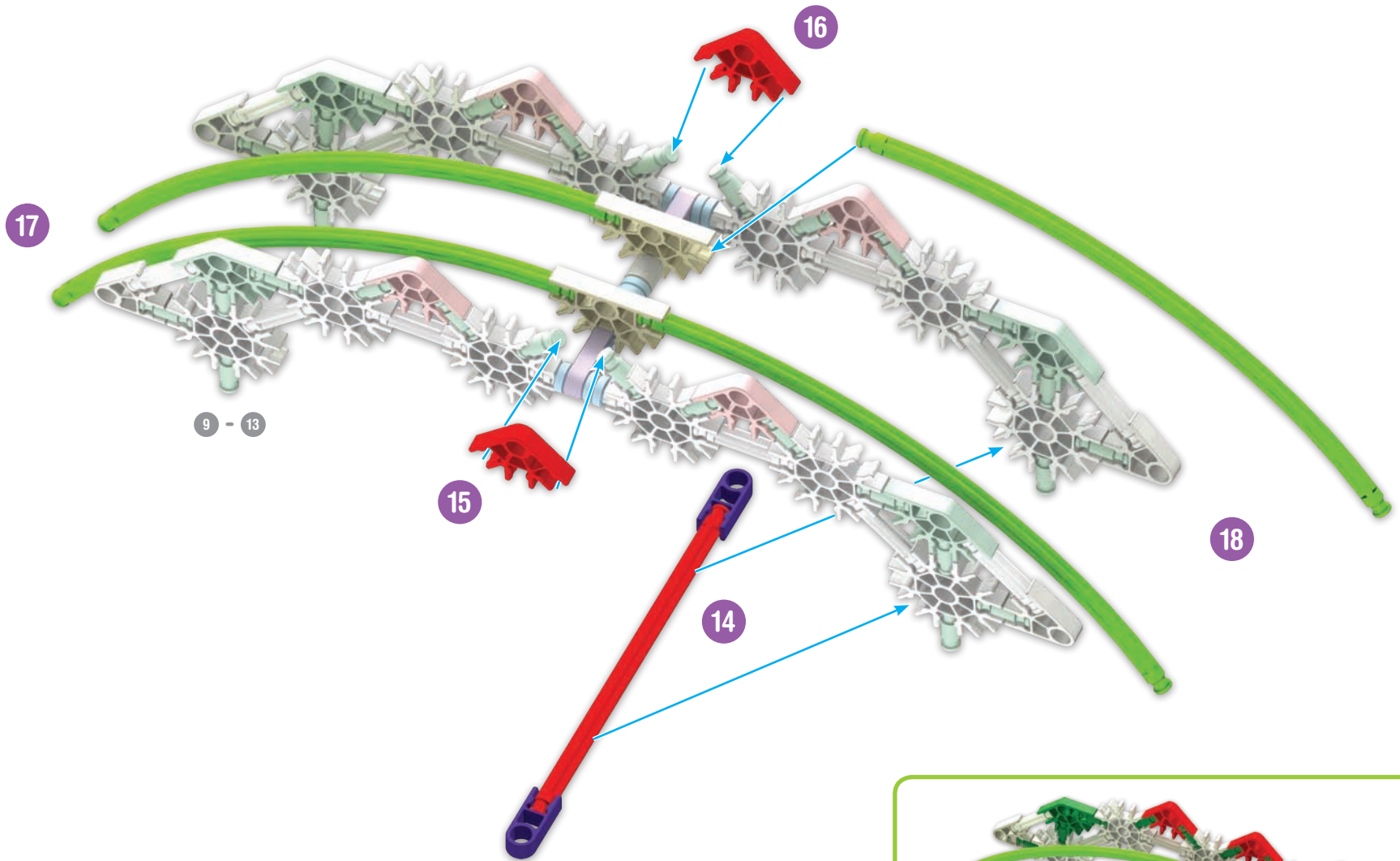

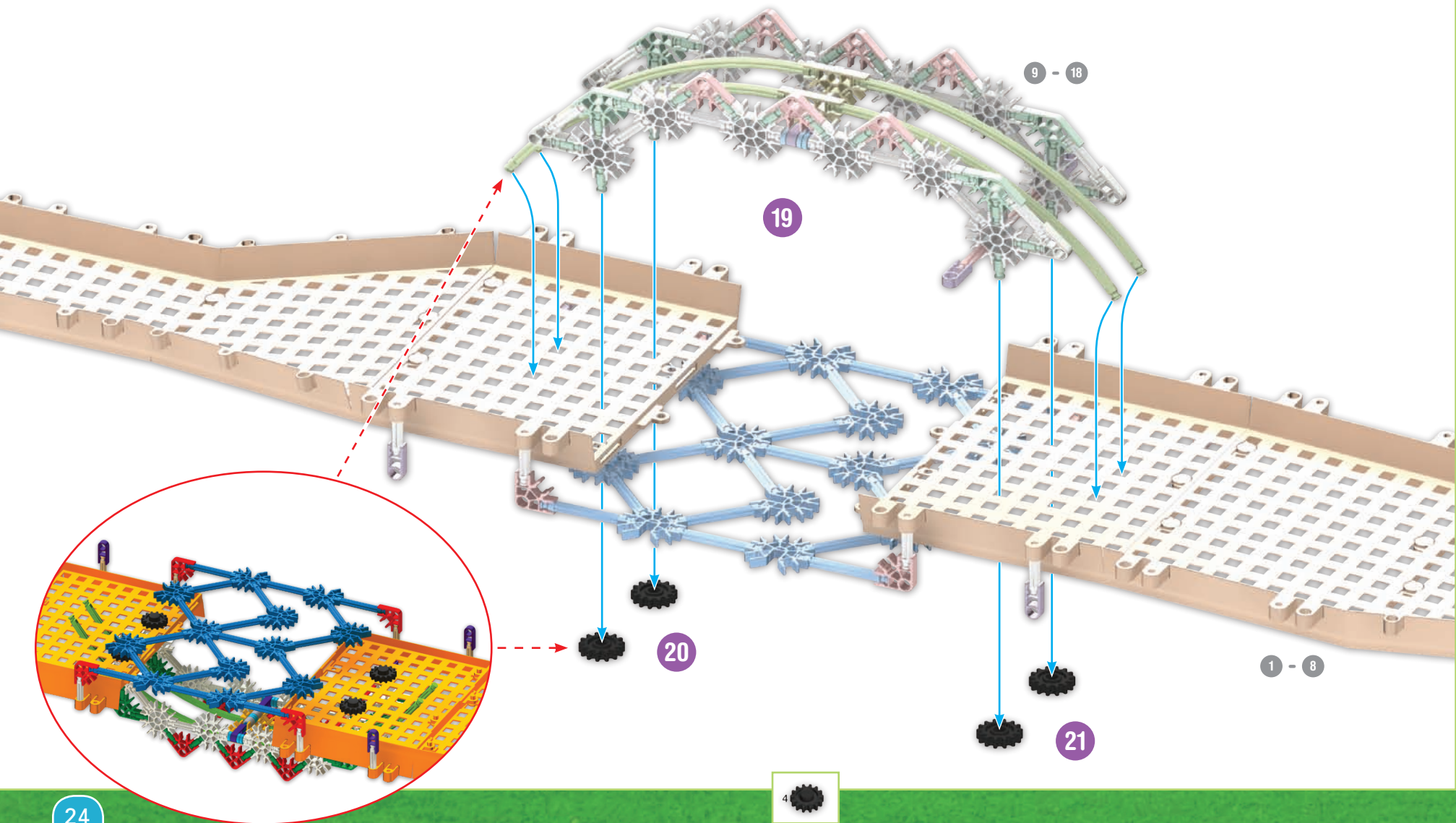

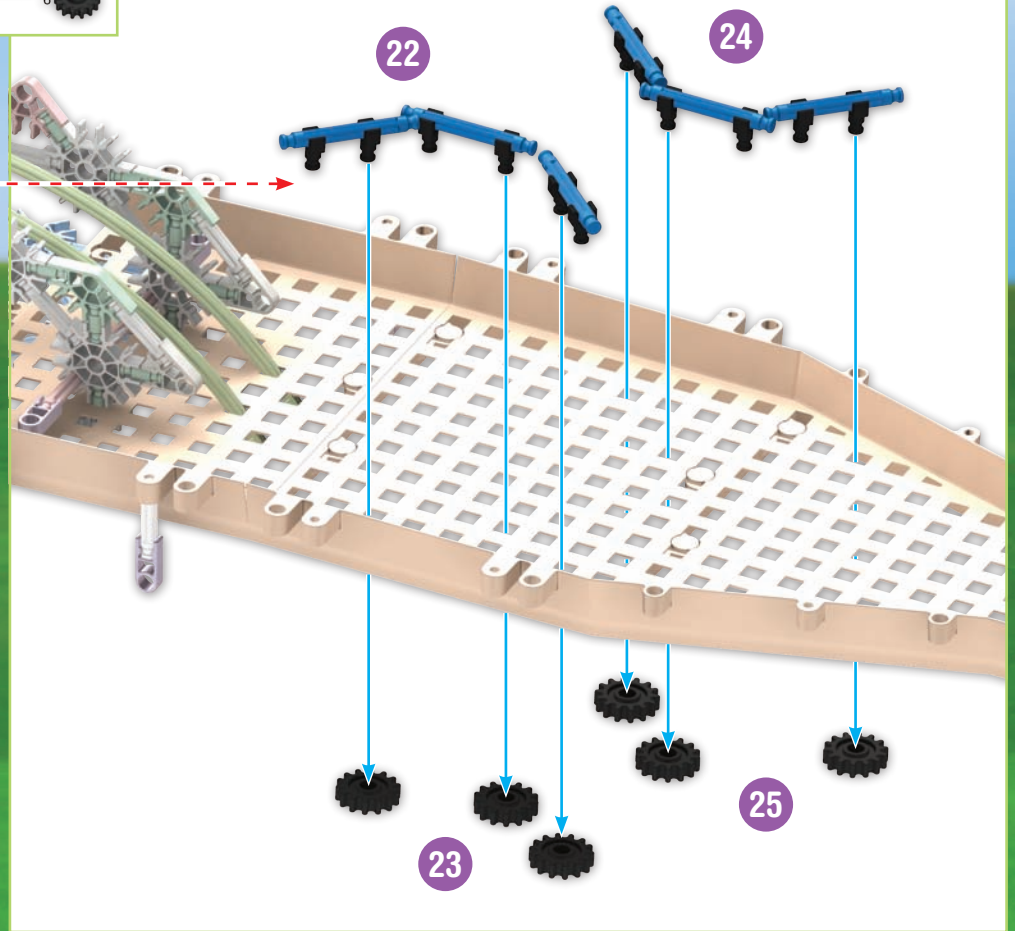
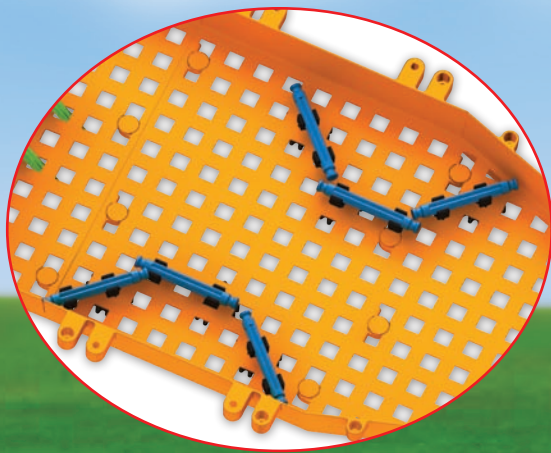

HOLE #3 TROU

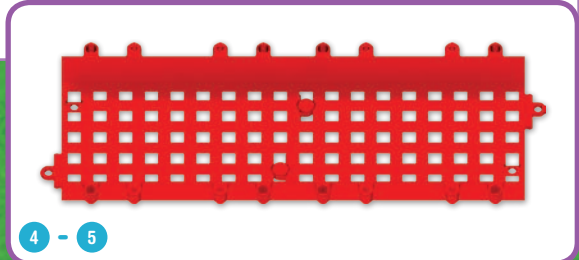
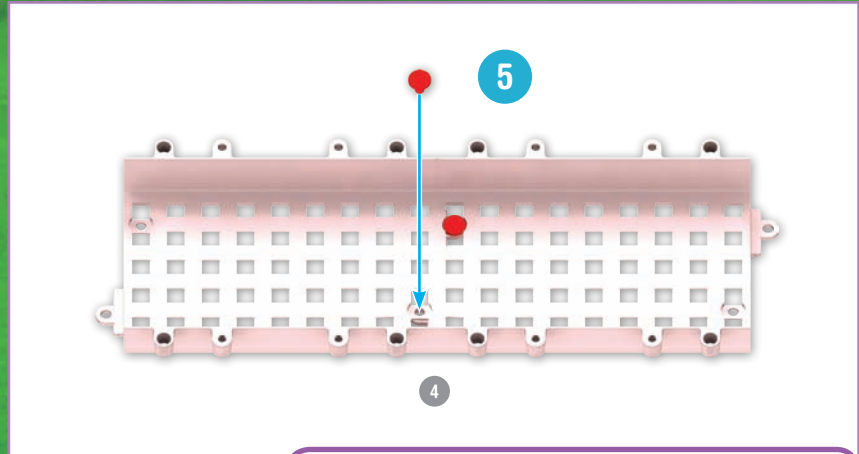
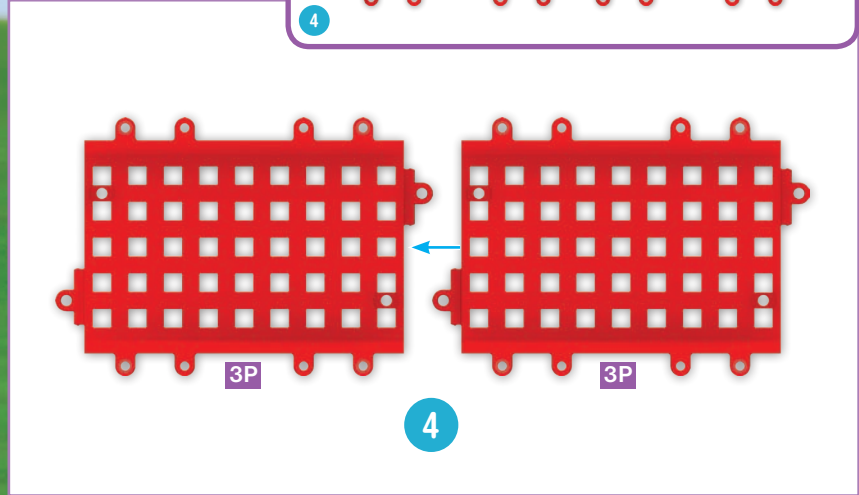
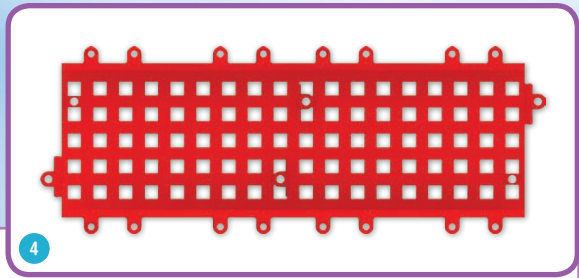
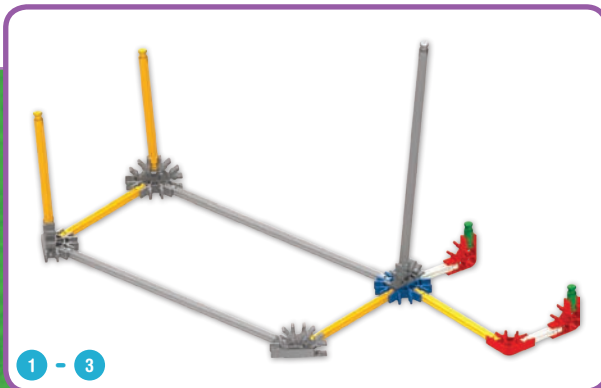
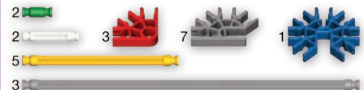
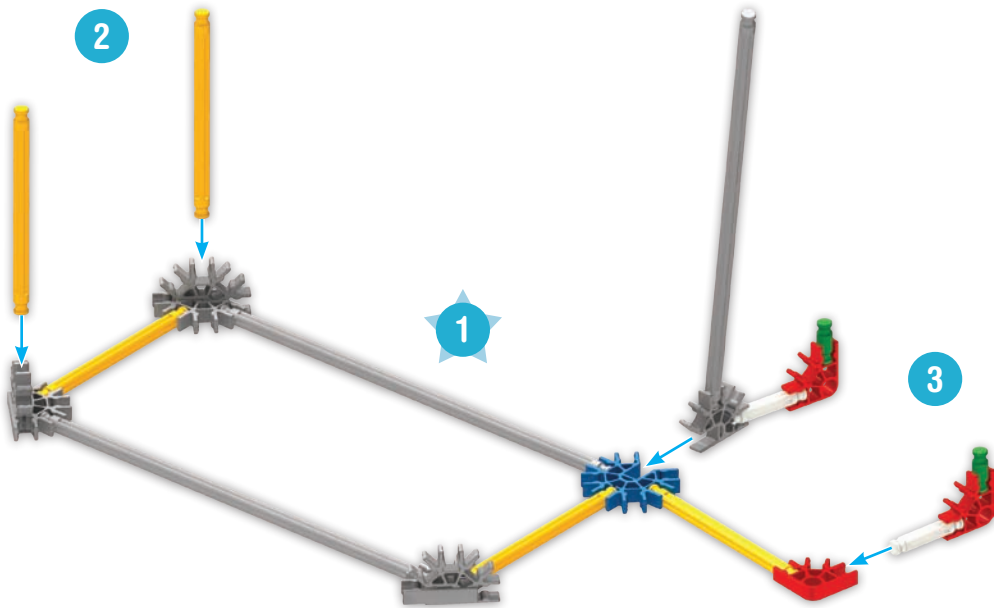

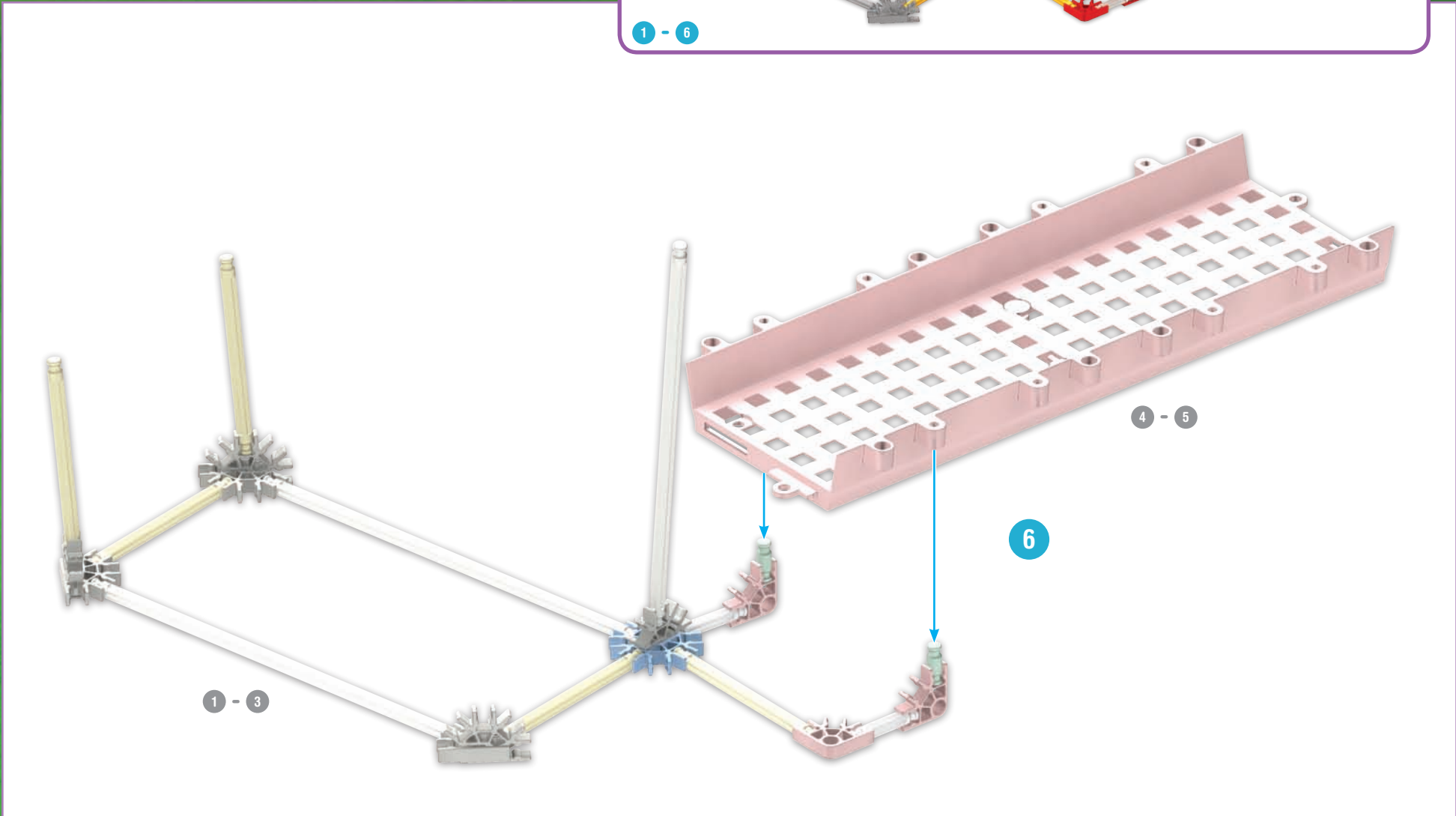
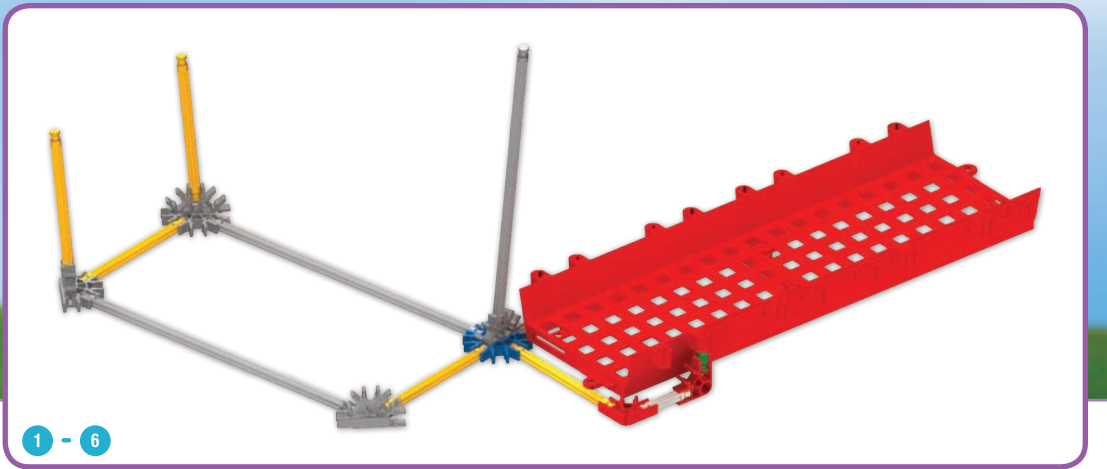

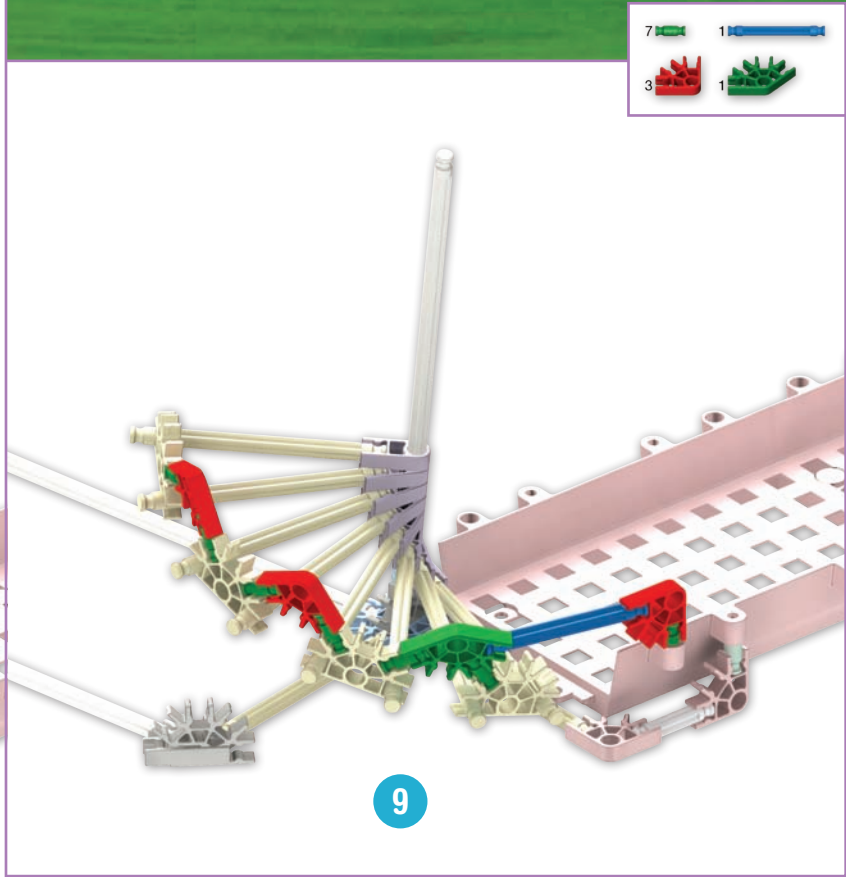
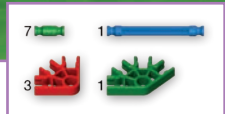
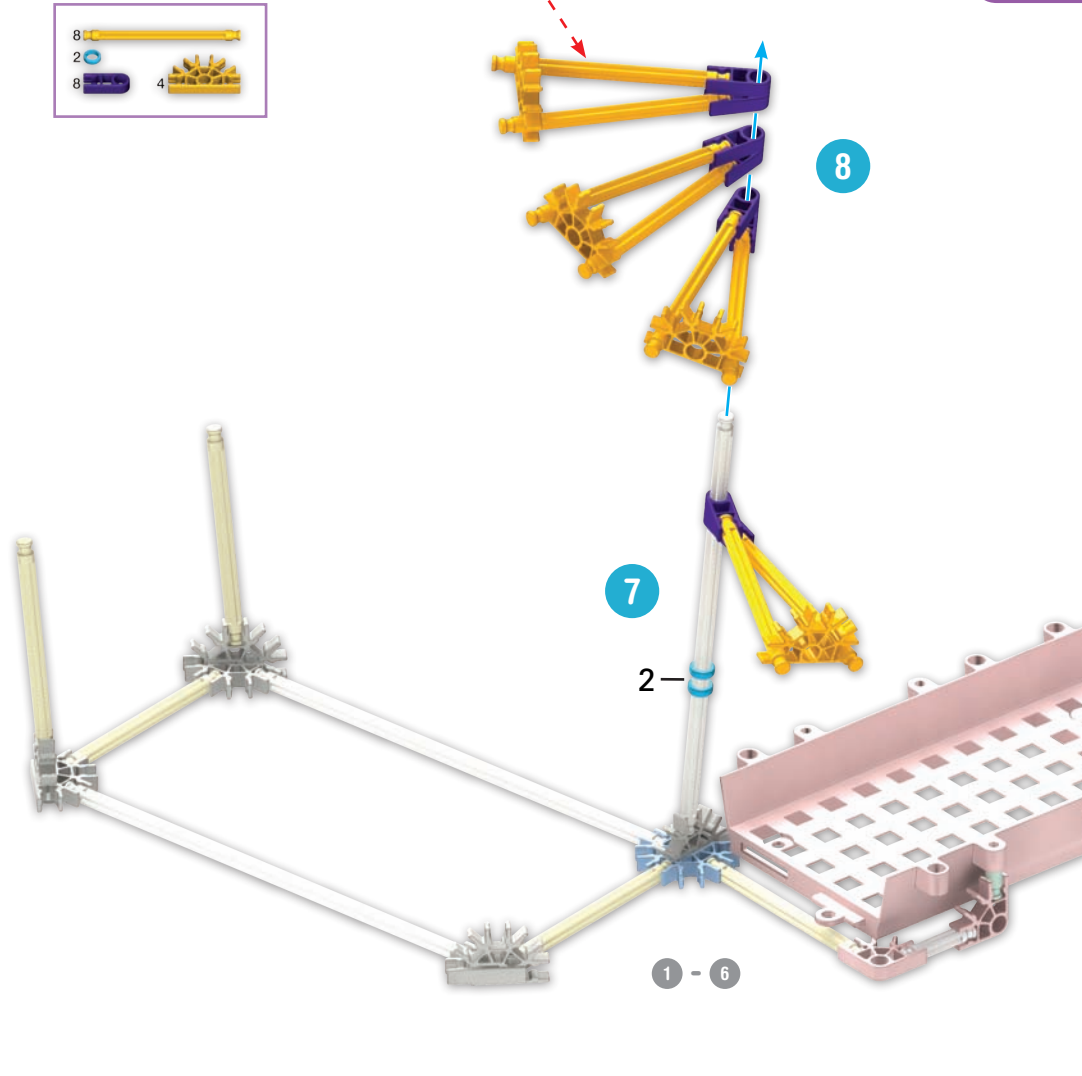
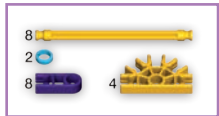
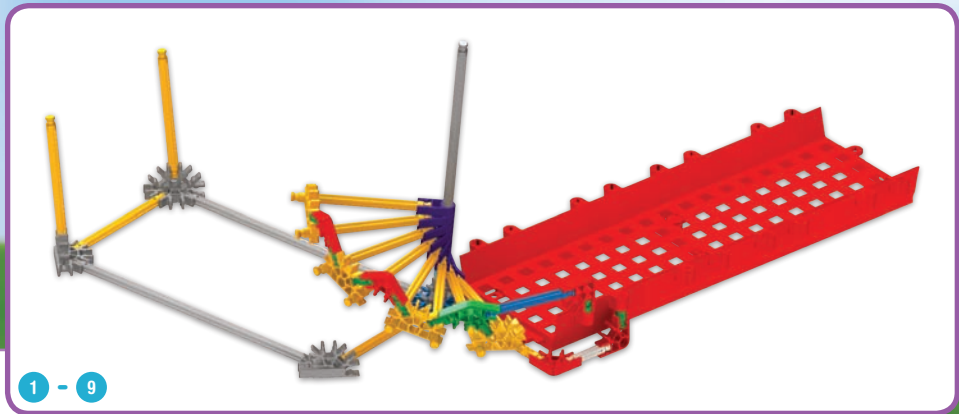

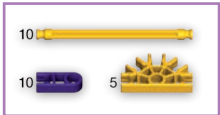

10

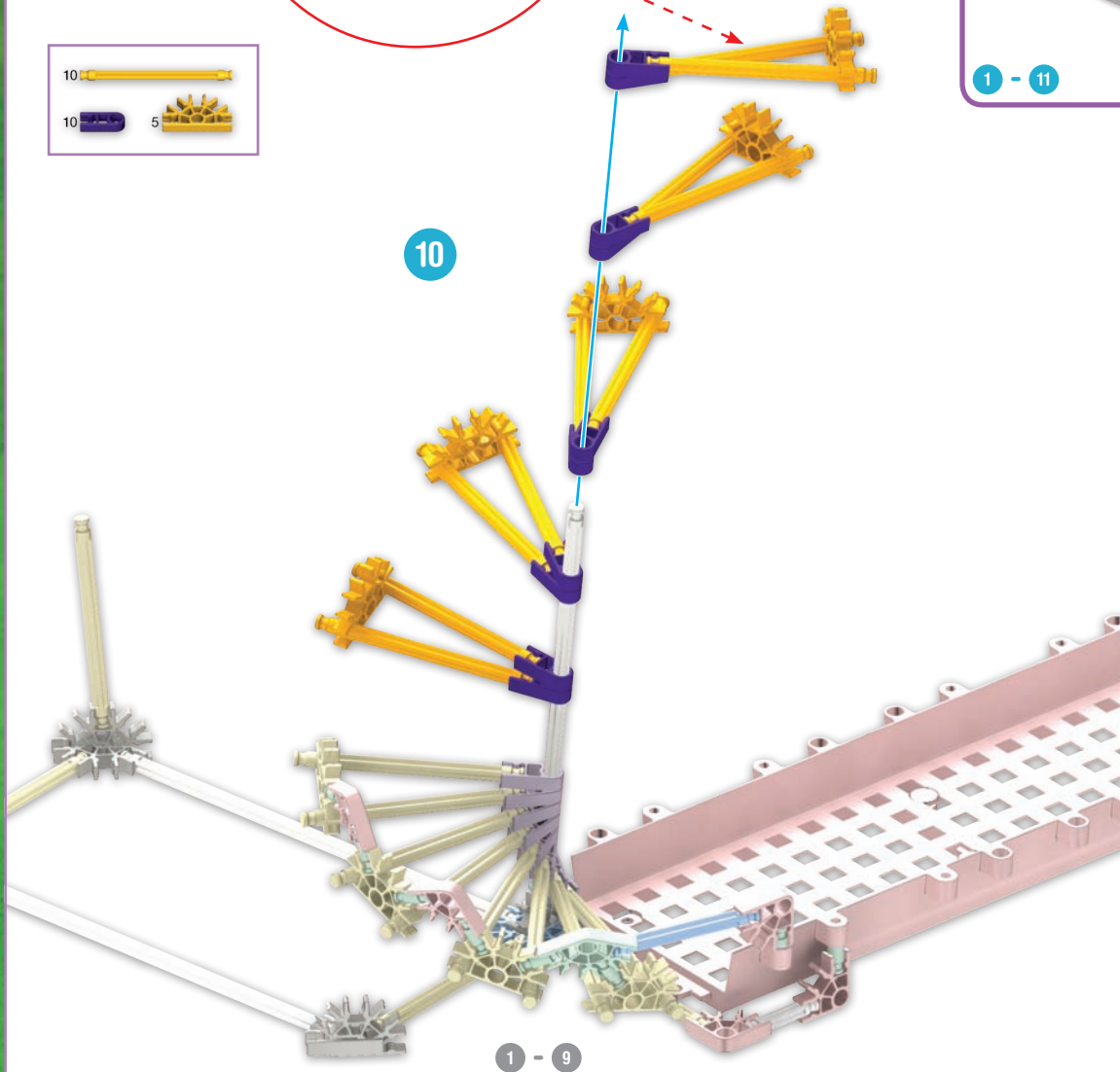

1 - 9



1 - 11

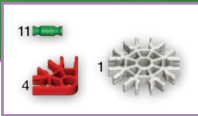

11

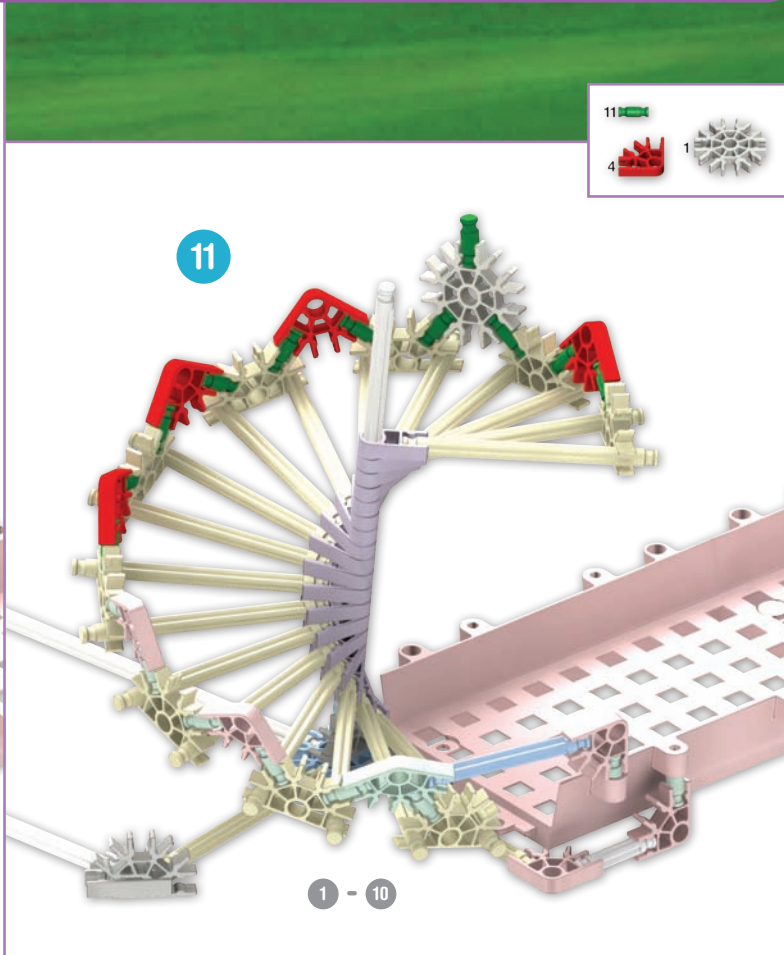

1 - 10

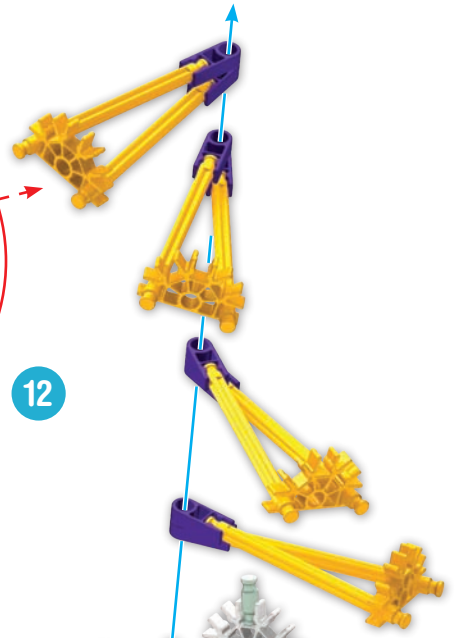

12

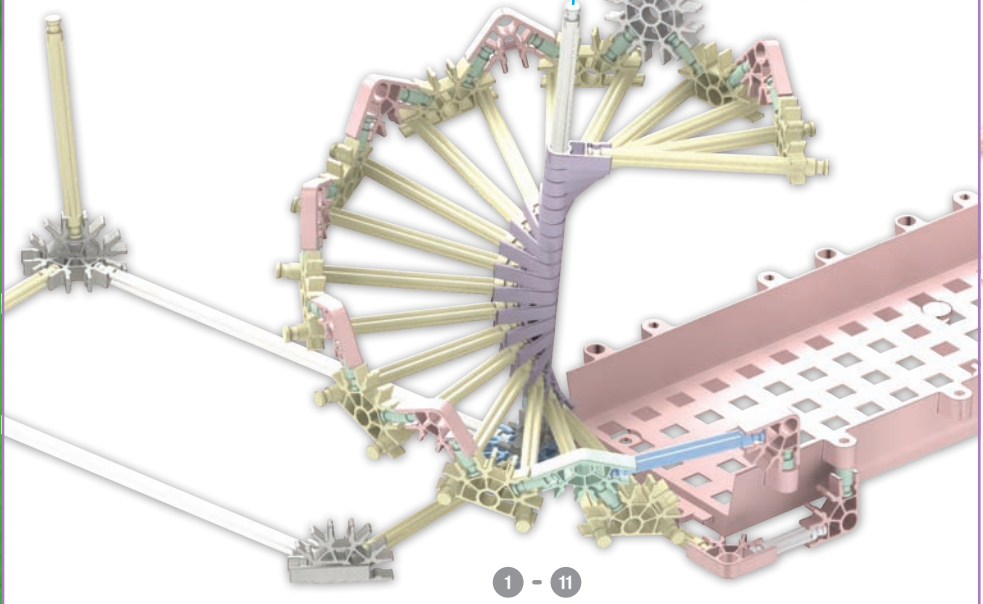

1 - 11



1 - 14

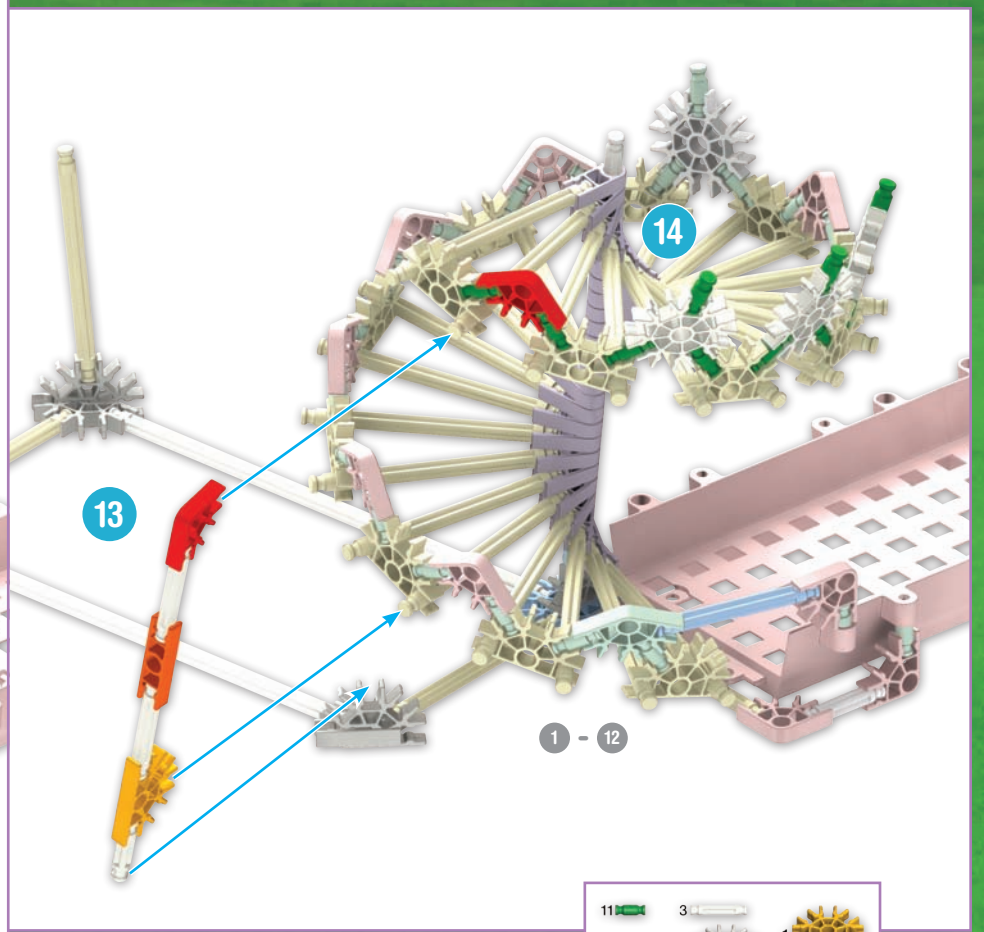

1 - 12

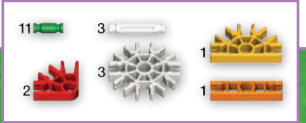

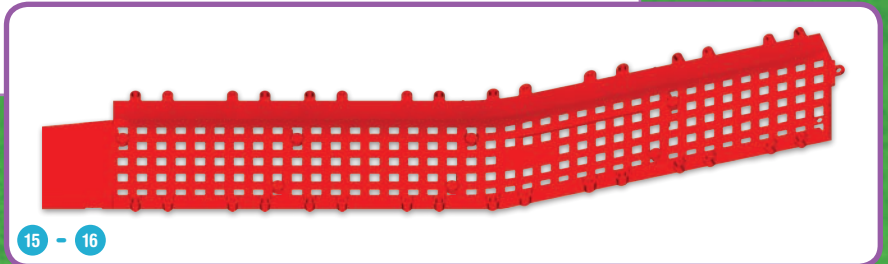
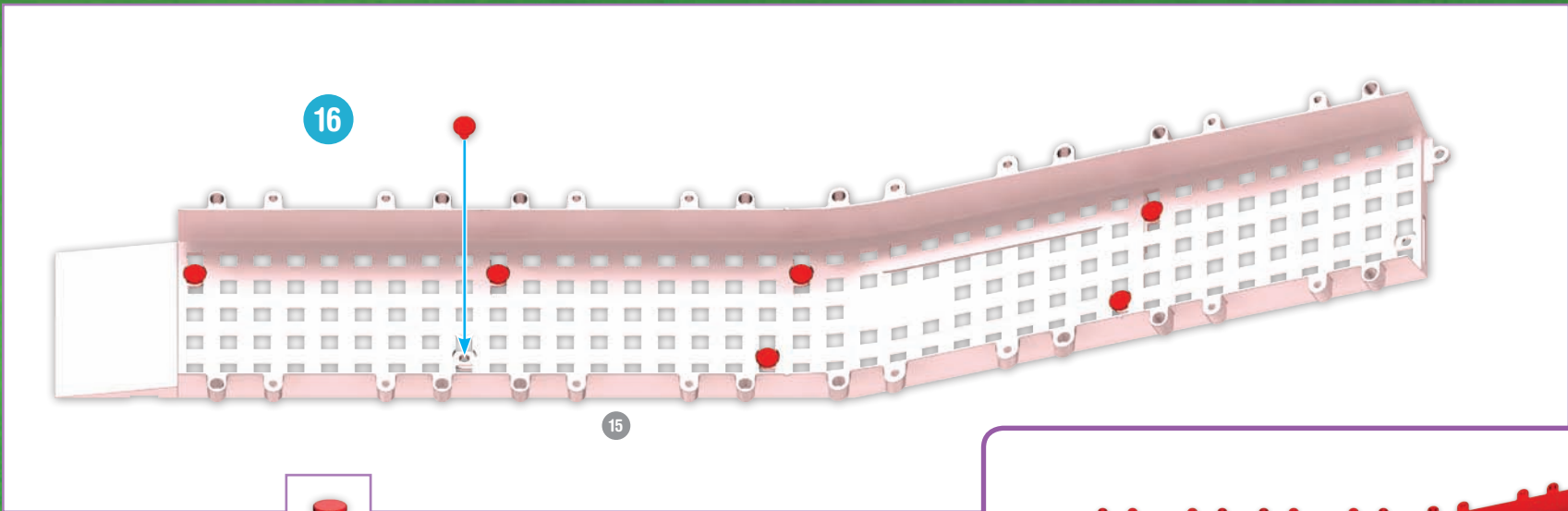
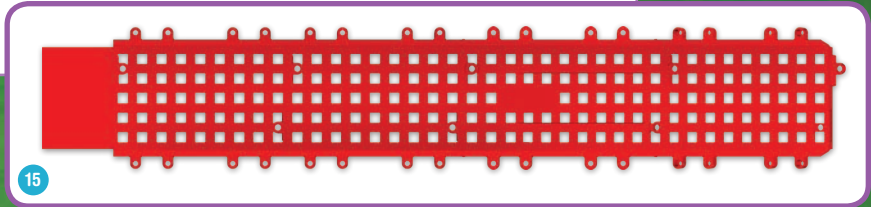
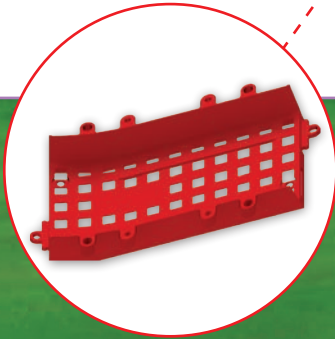
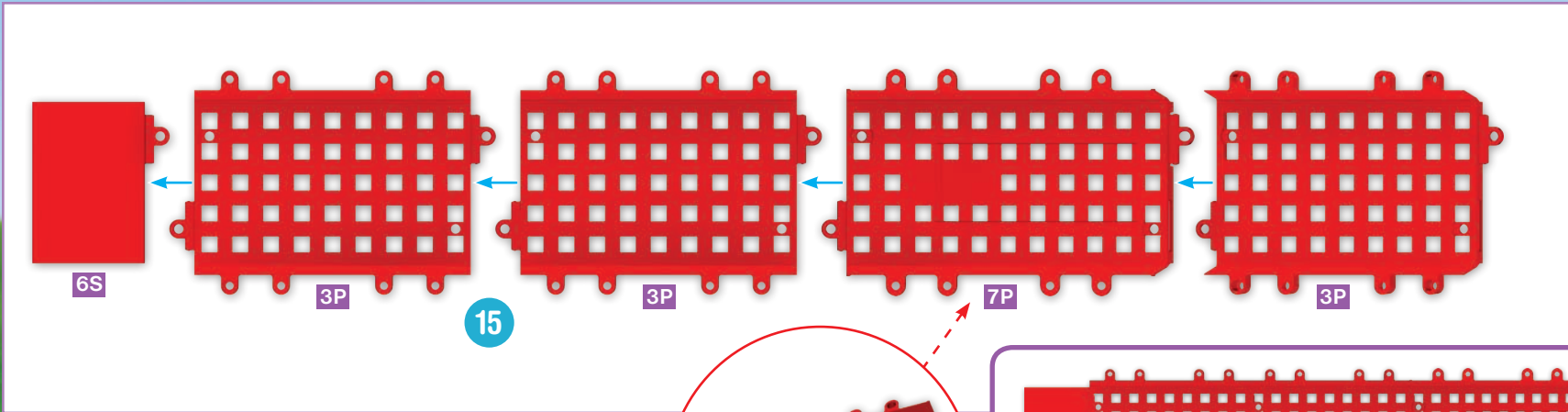

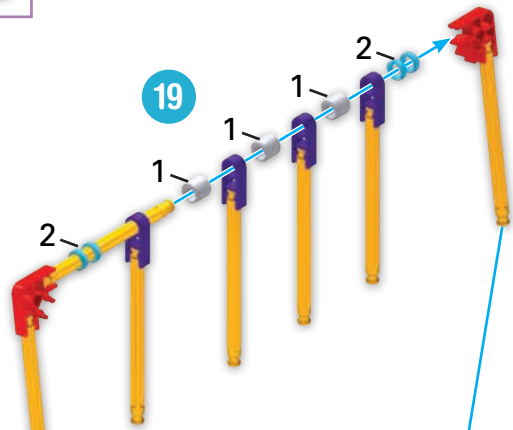
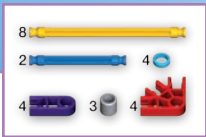

1 - 19

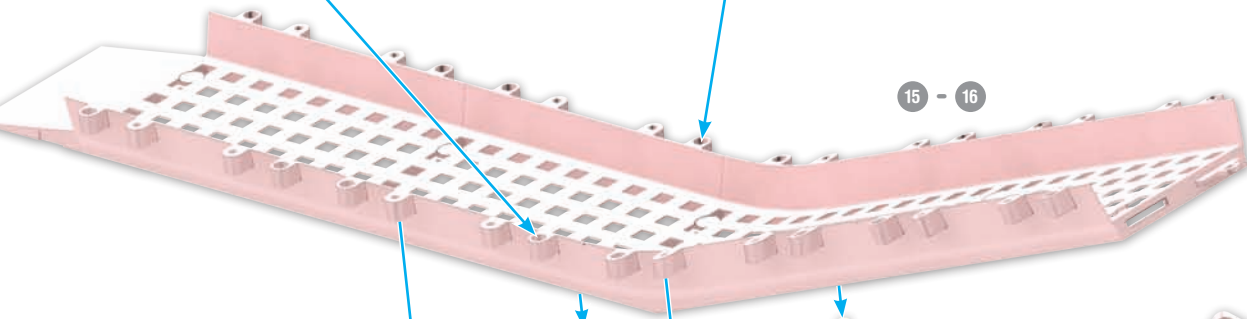

15 - 16

17

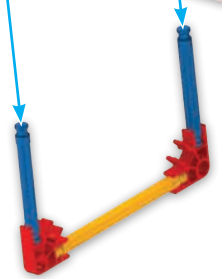

18

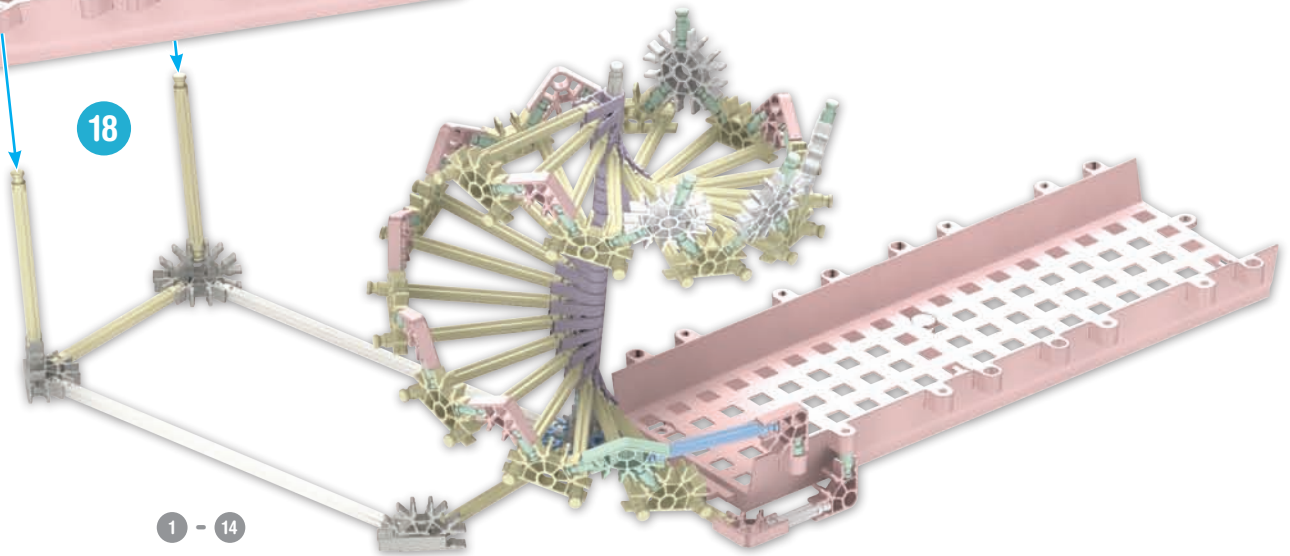

1 - 14

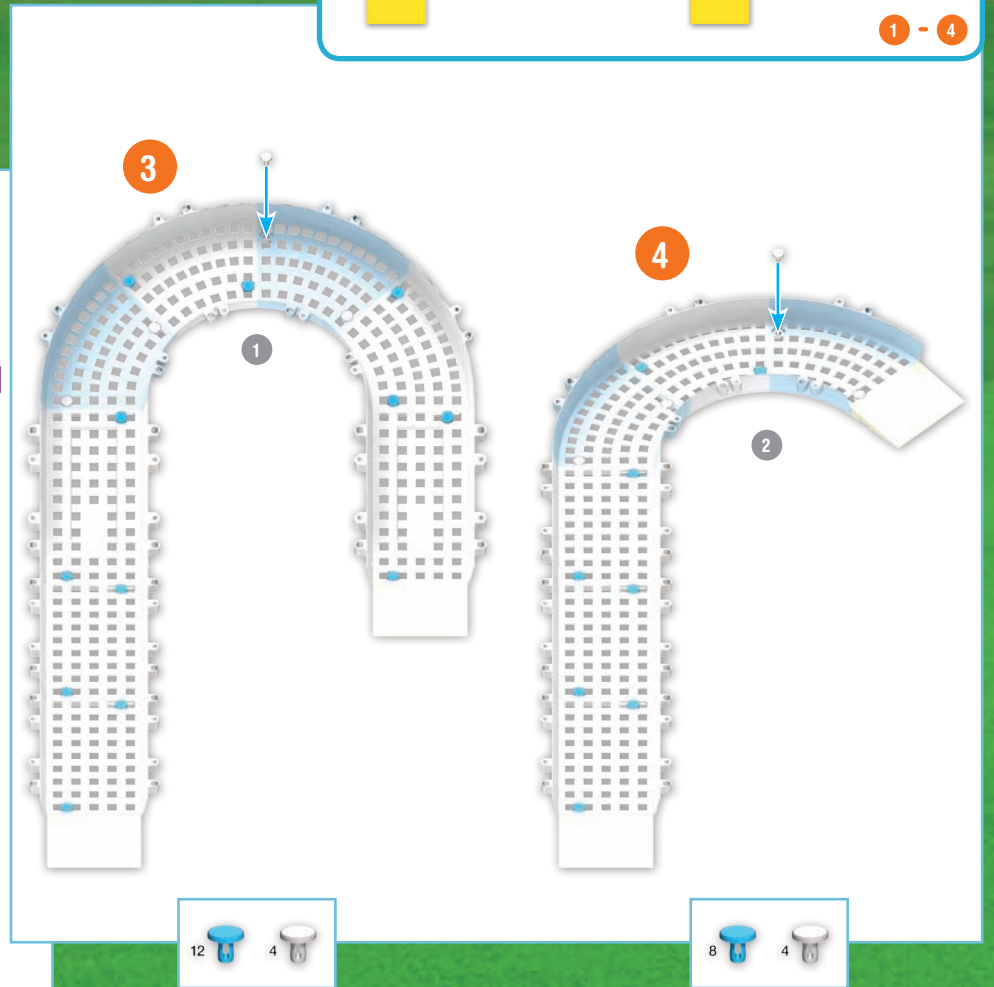
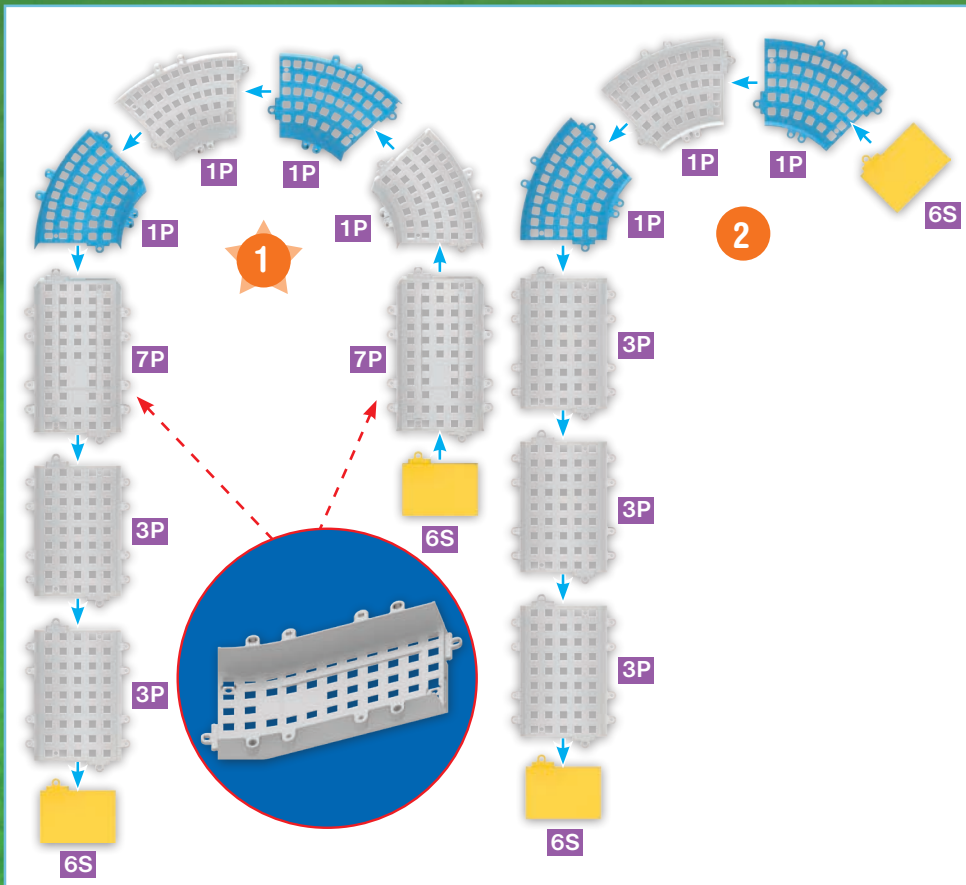
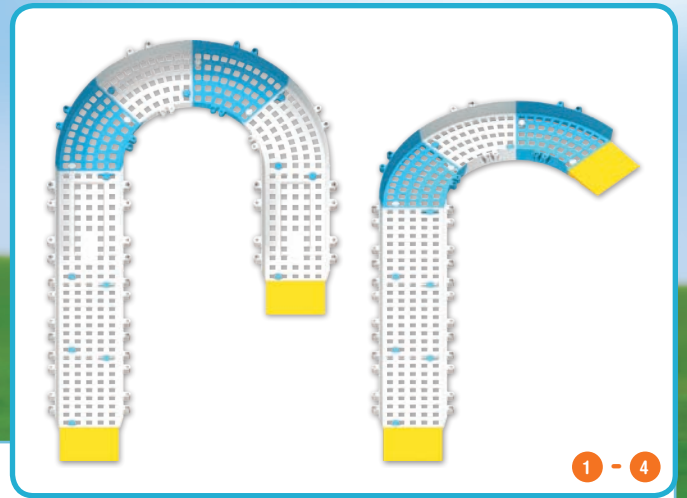
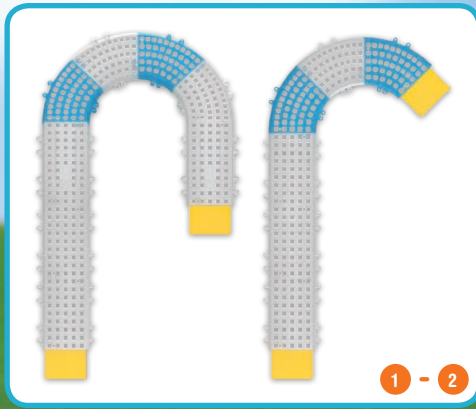

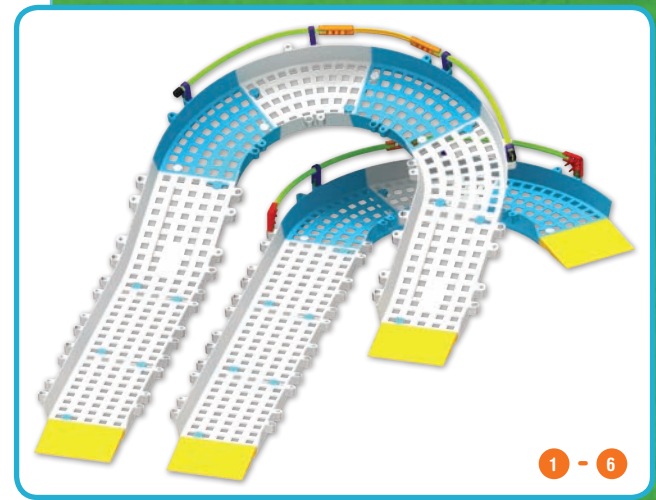
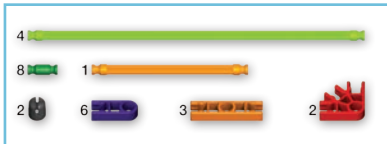
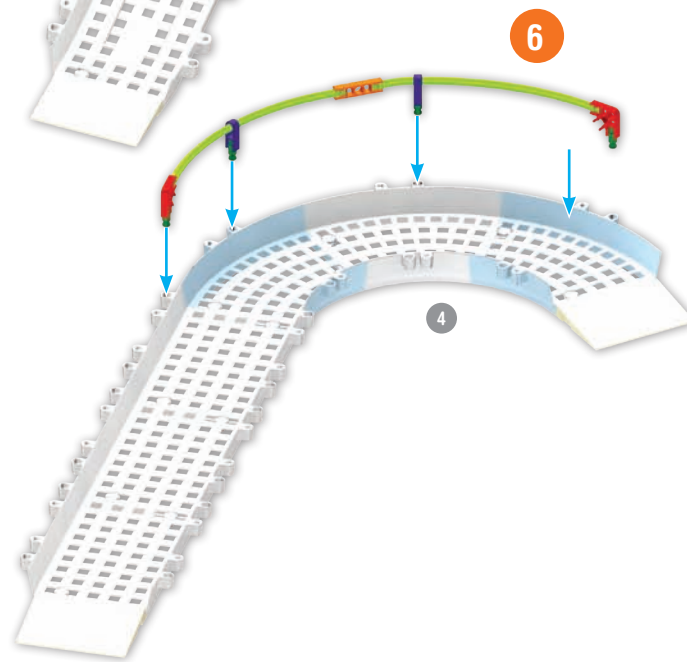
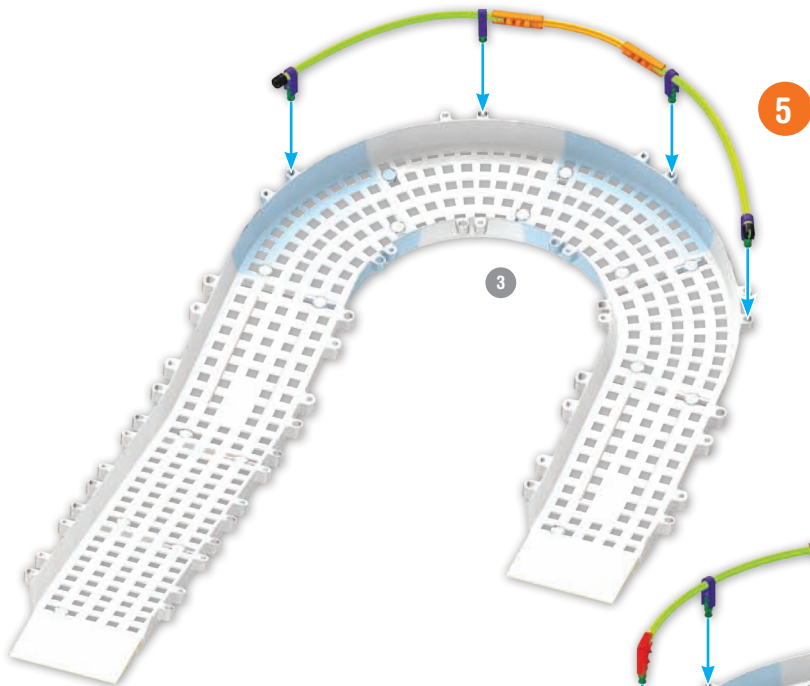
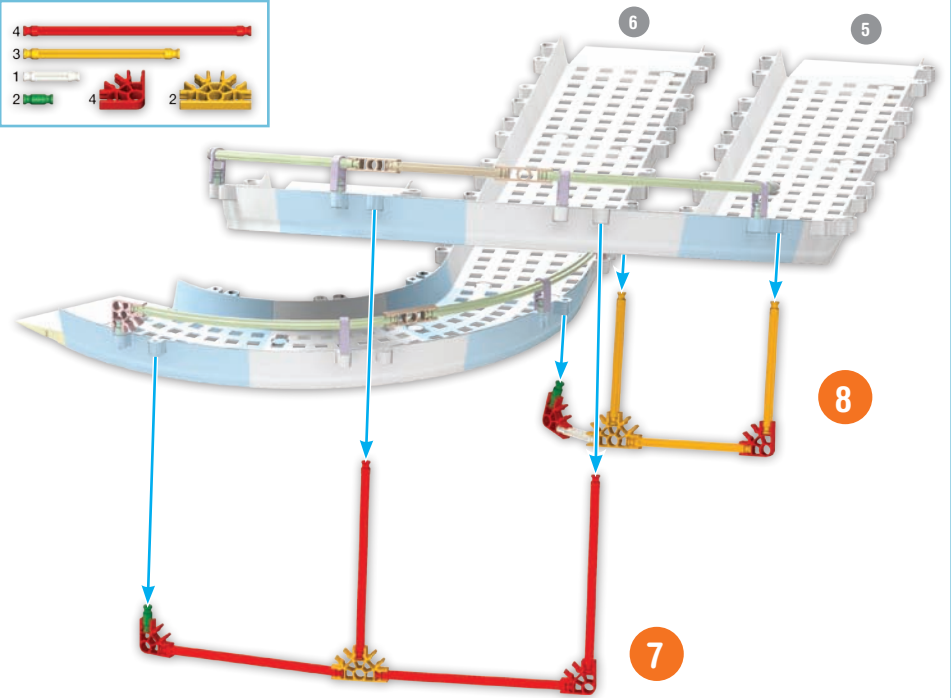
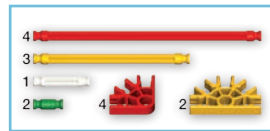
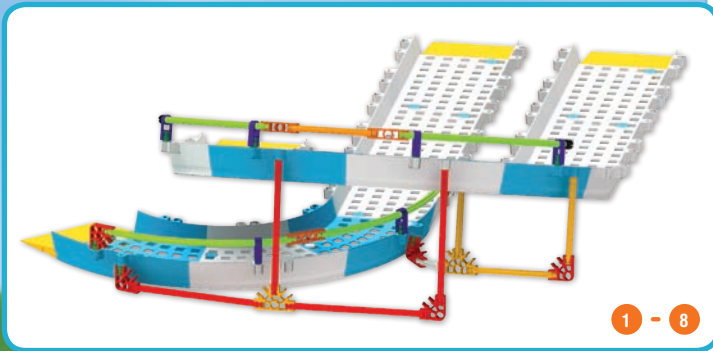

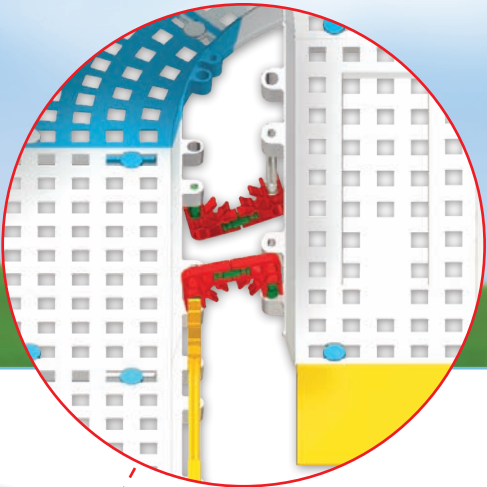
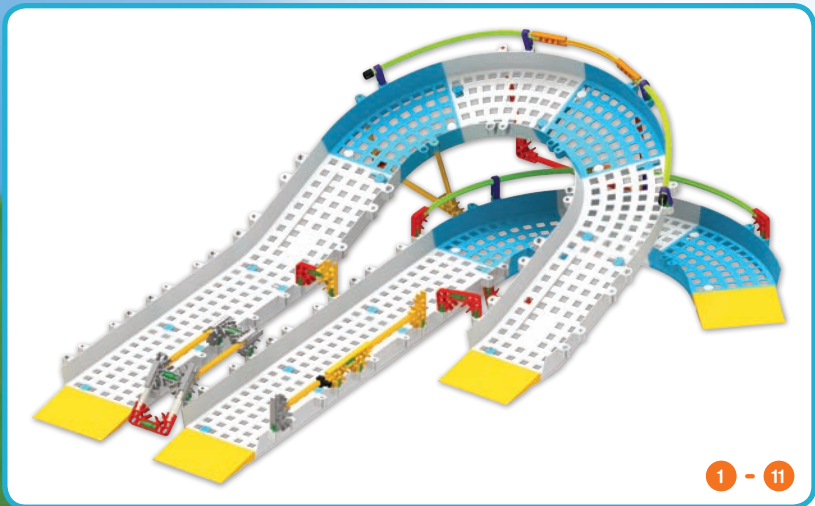

- | | | | |
|----|--|----|--|
| 4 | | 3 | |
| 20 | | 1 | |
| 7 | | 4 | |
| | | 10 | |

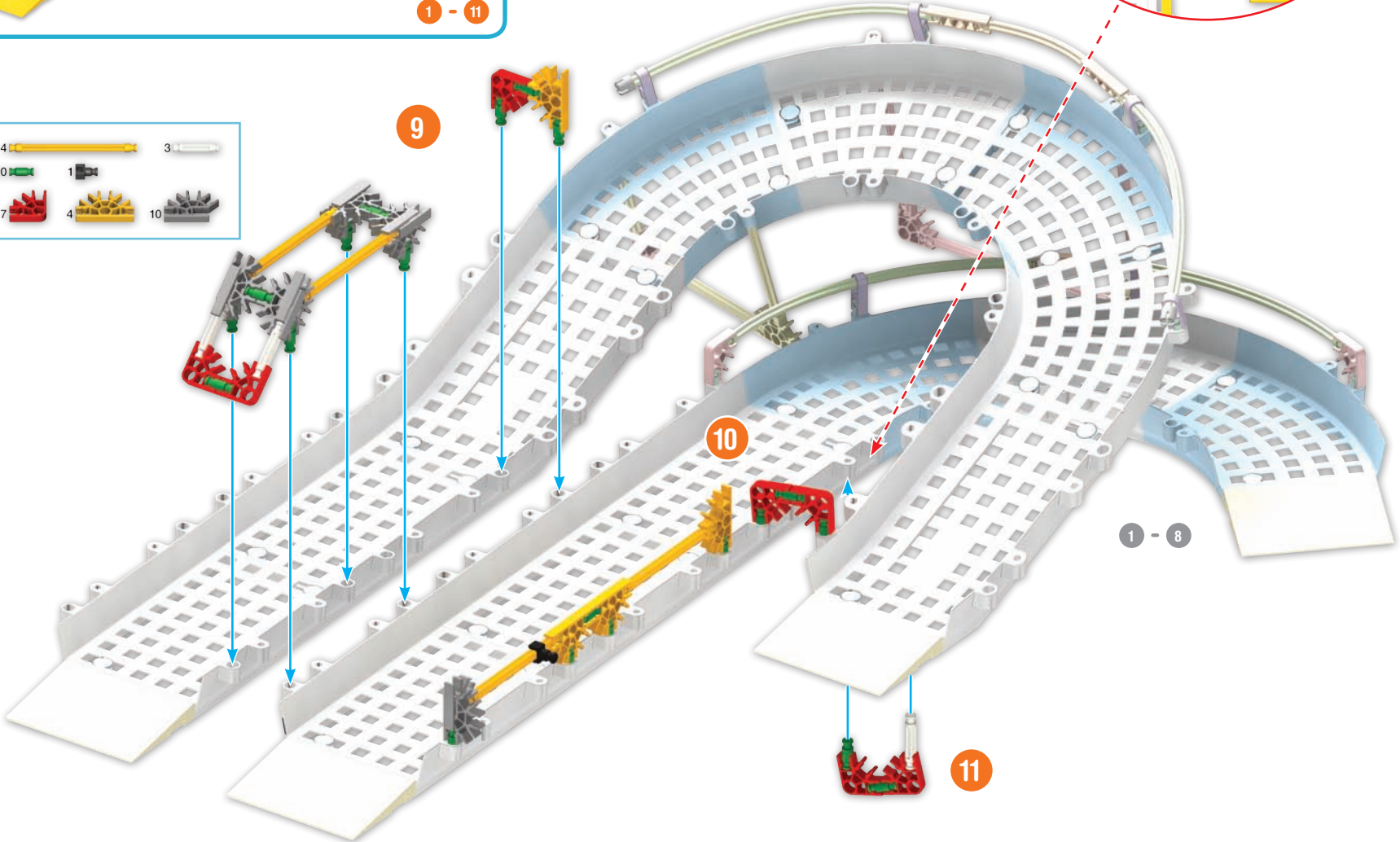

- | | | | |
|----|--|----|--|
| 1 | | 2 | |
| 2 | | 8 | |
| 8 | | 2 | |
| 16 | | 4 | |
| 8 | | 2 | |
| | | 16 | |
| | | 2 | |

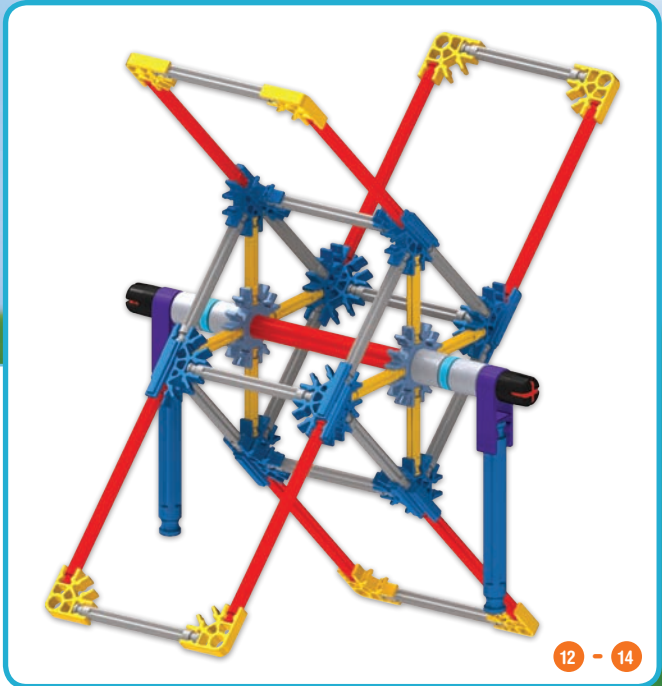

12 - 14

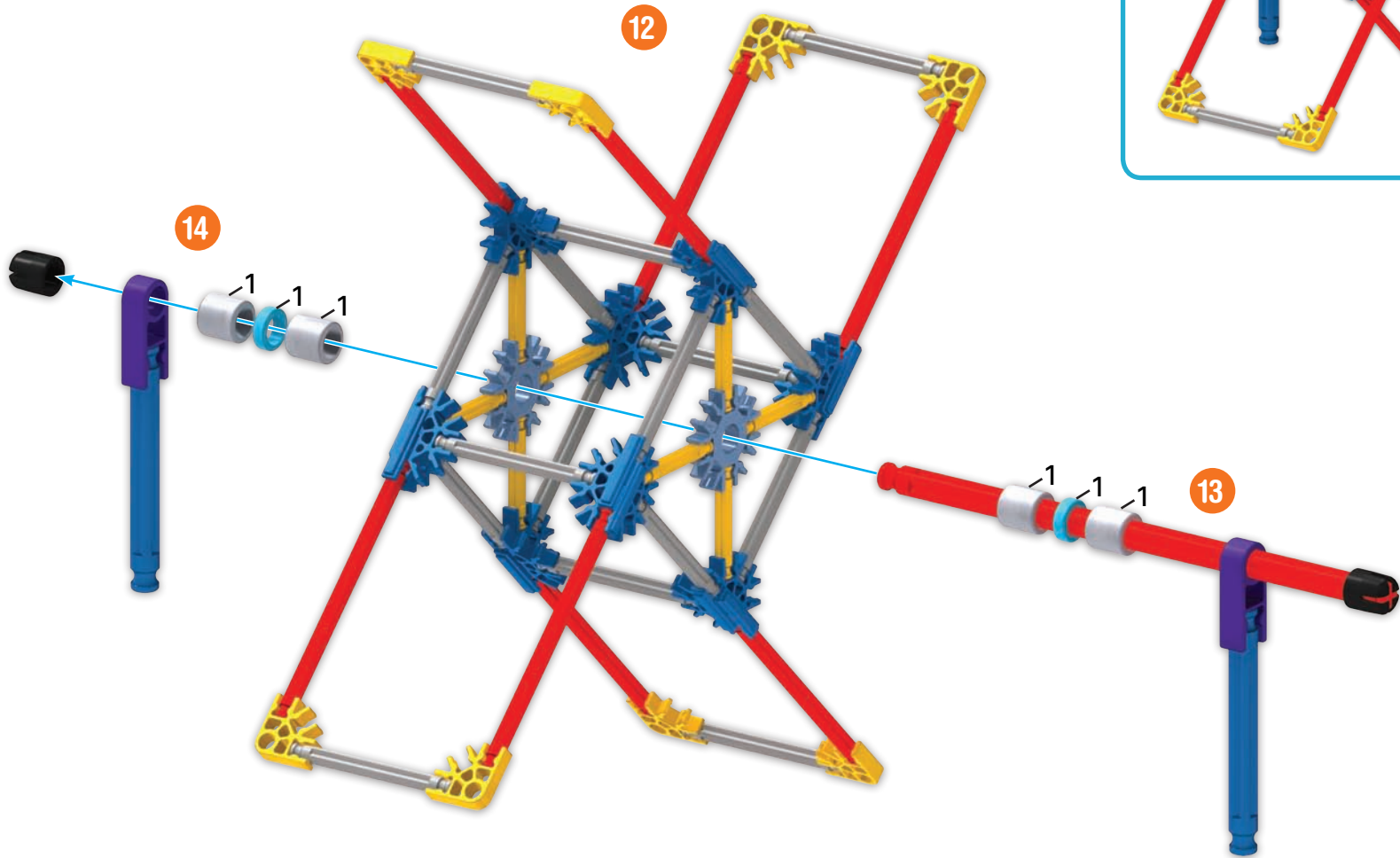

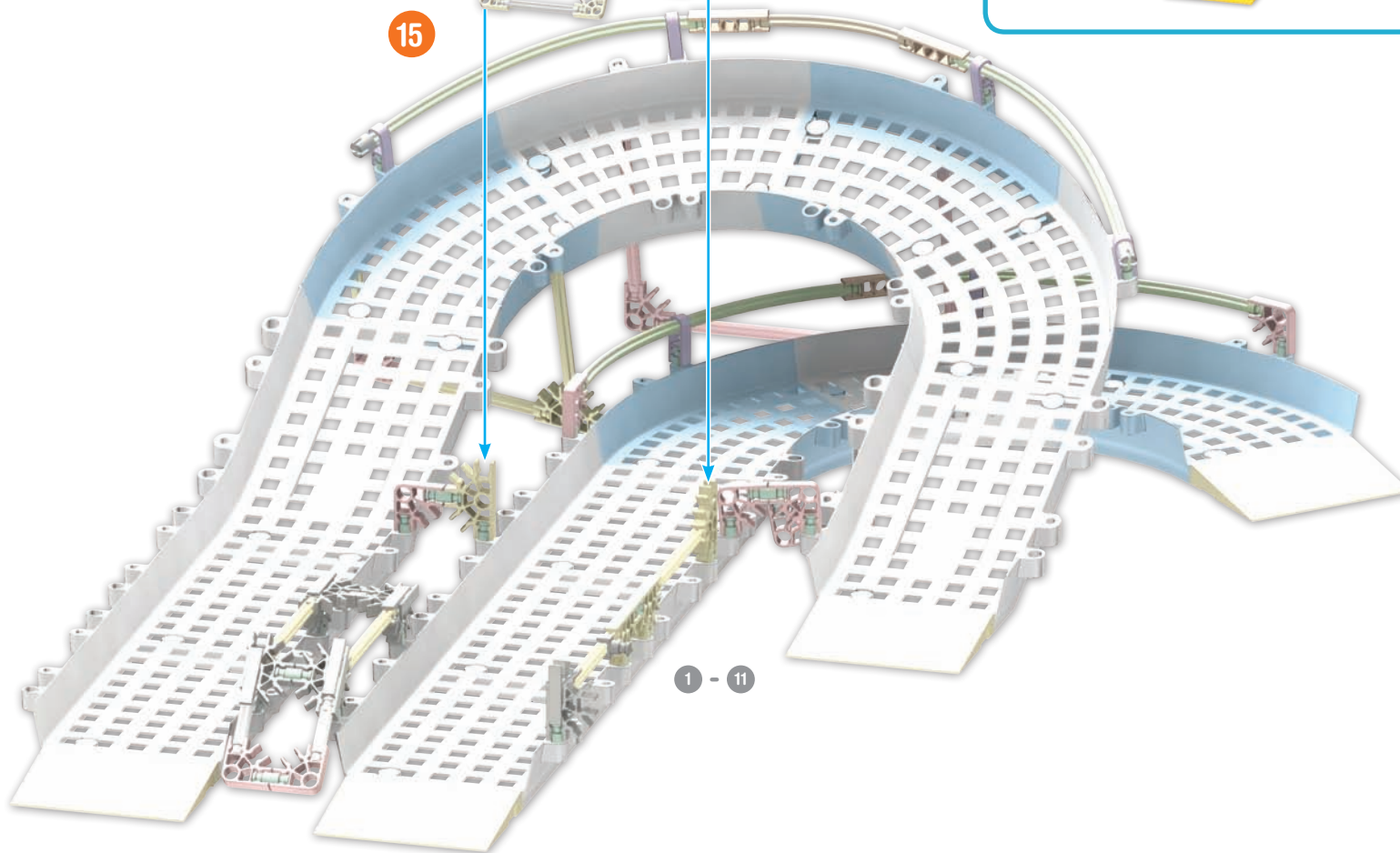
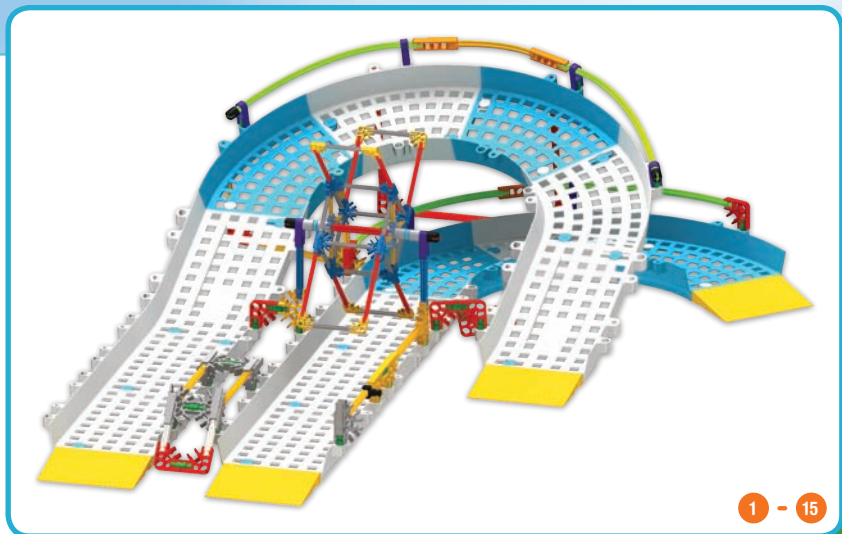
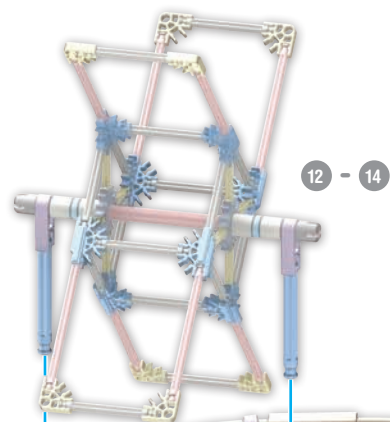

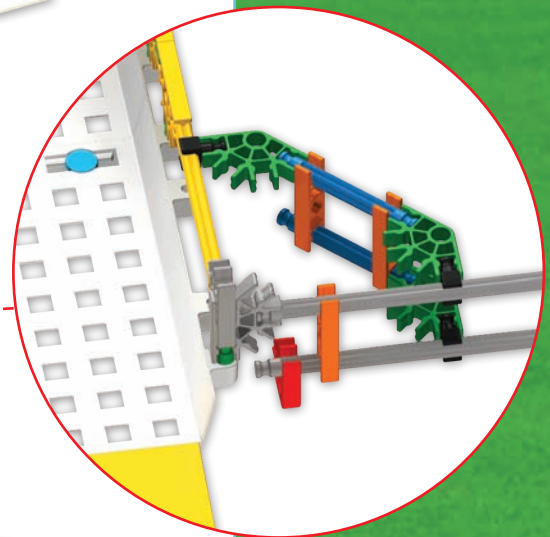
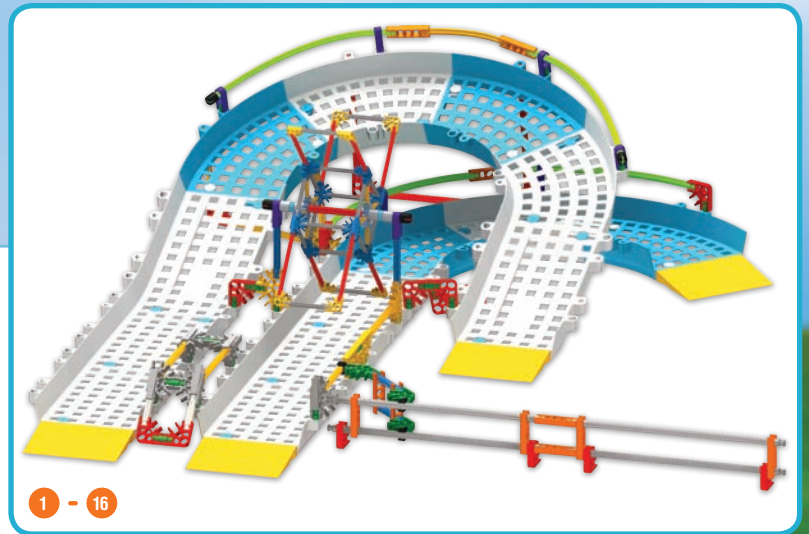
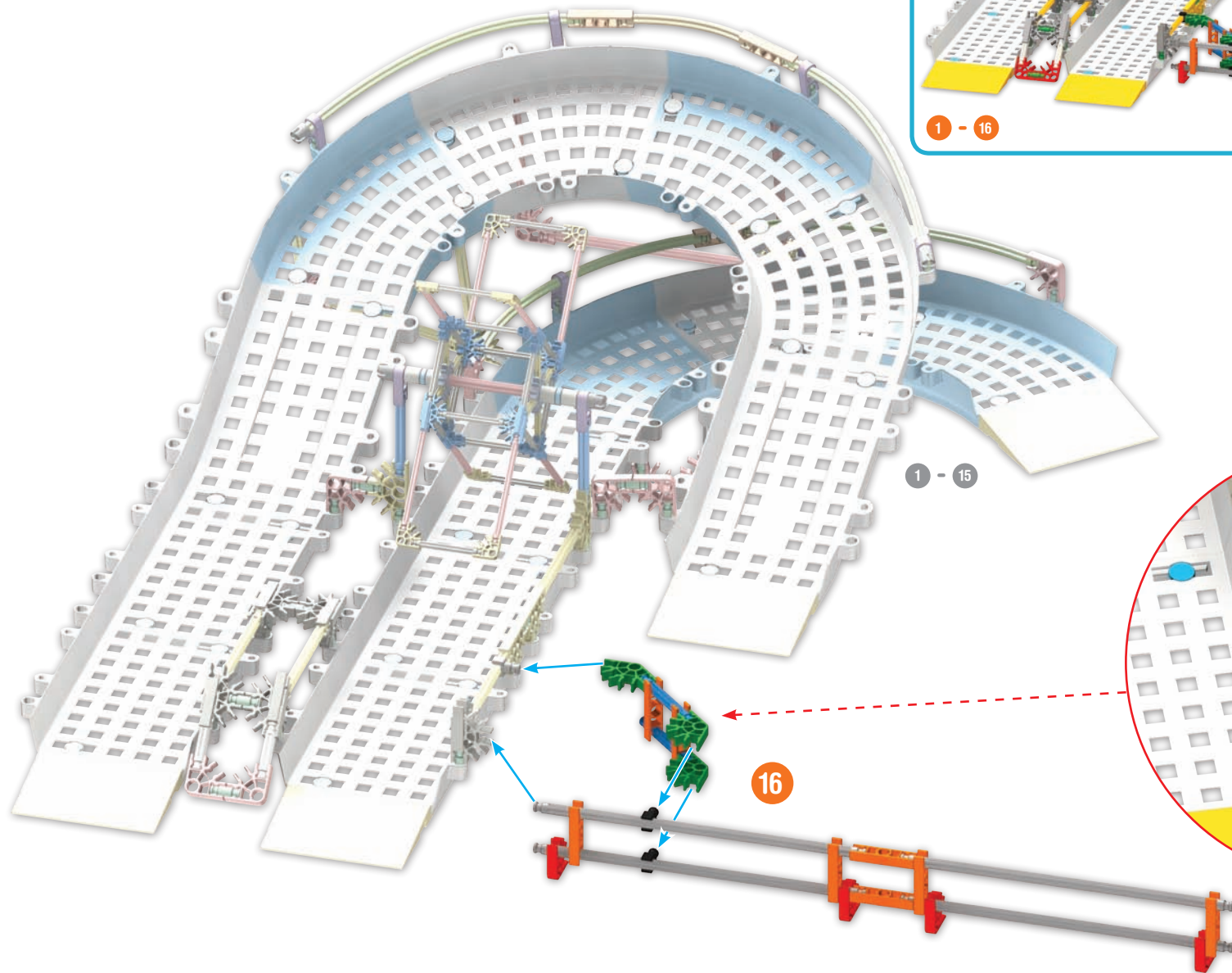
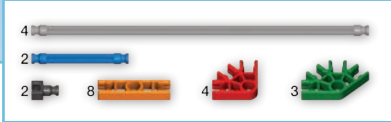

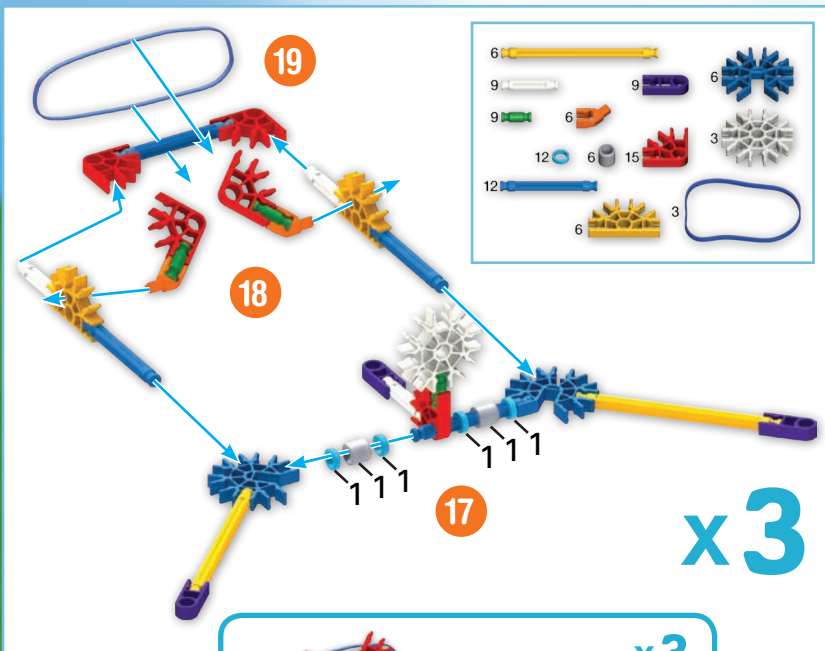

x3

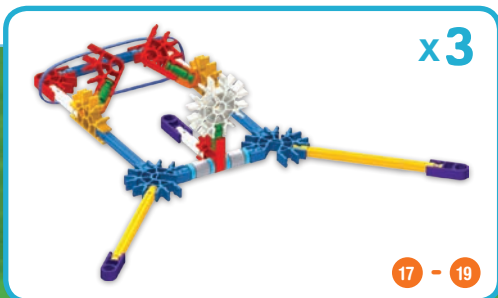

x3

17 - 19

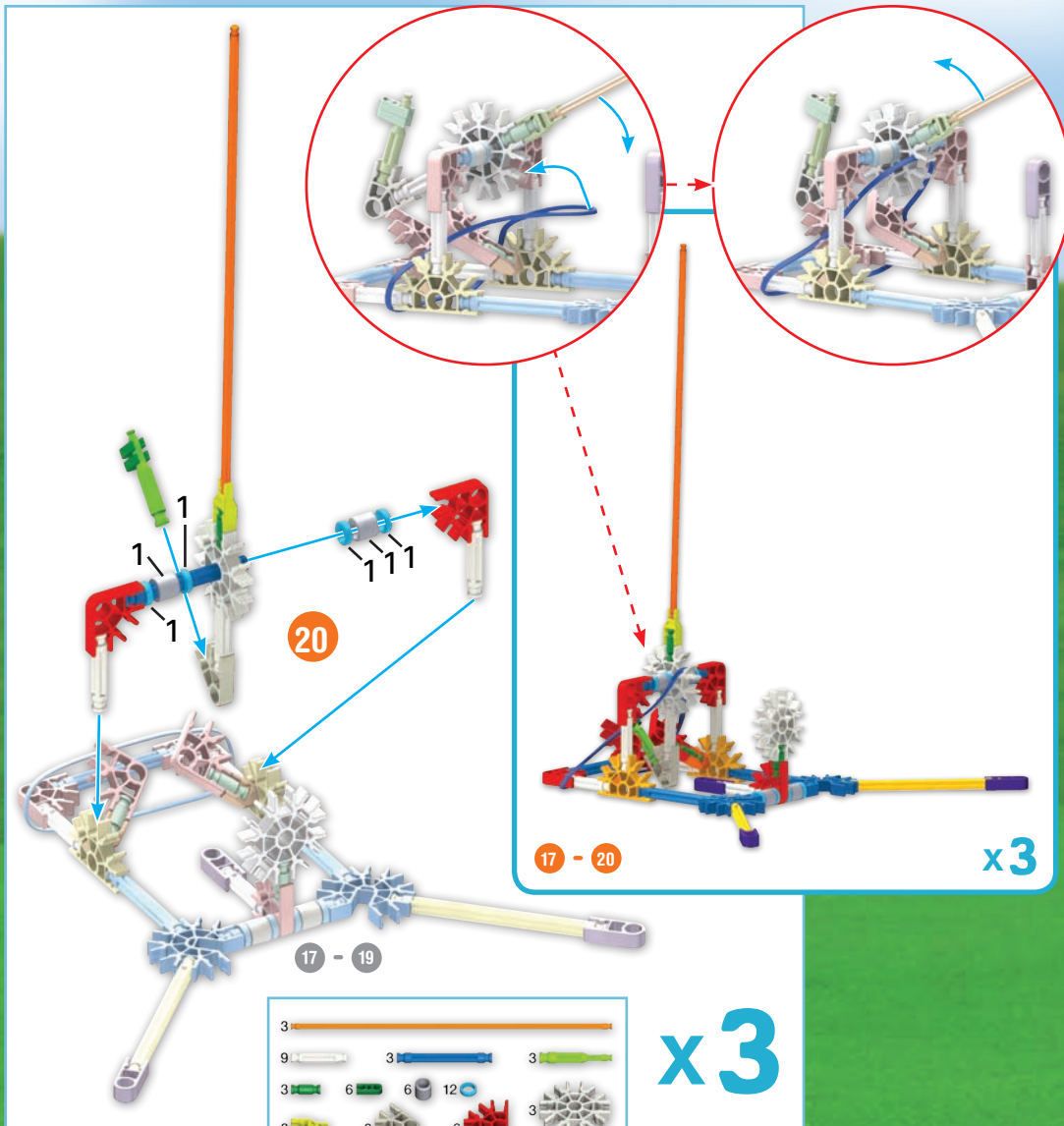

x3

17 - 19

x3

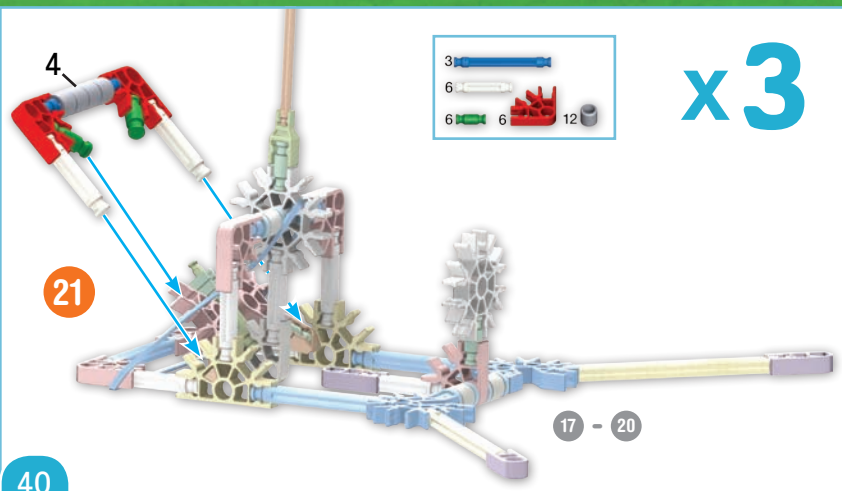

x3

17 - 20



x3

17 - 21

HOLE: #4, #6, #7
TROU: #4, #6, #7

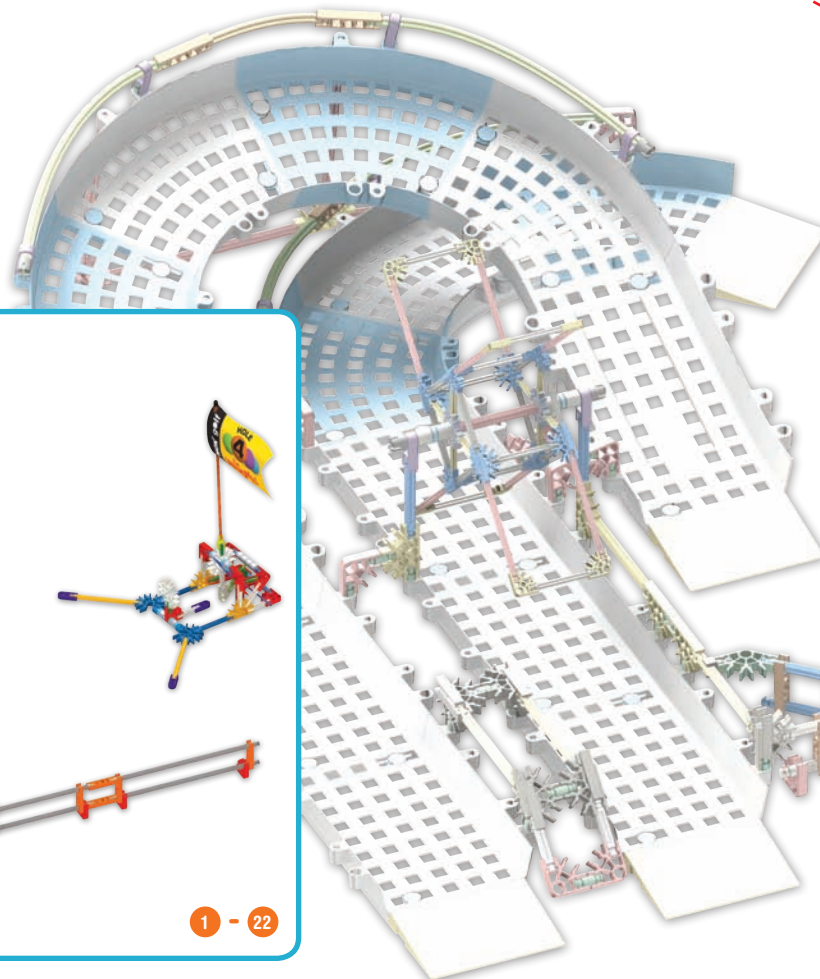
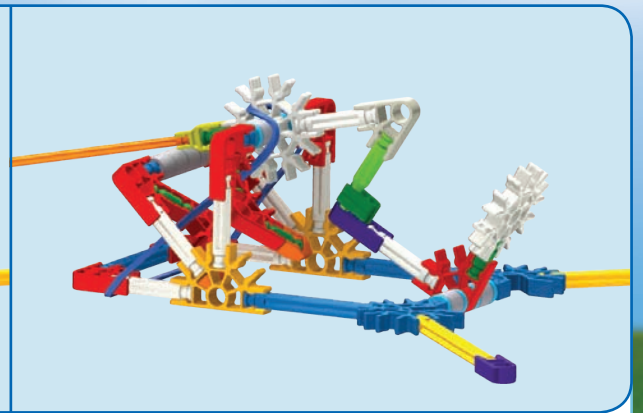

HOLE # 4
TROU

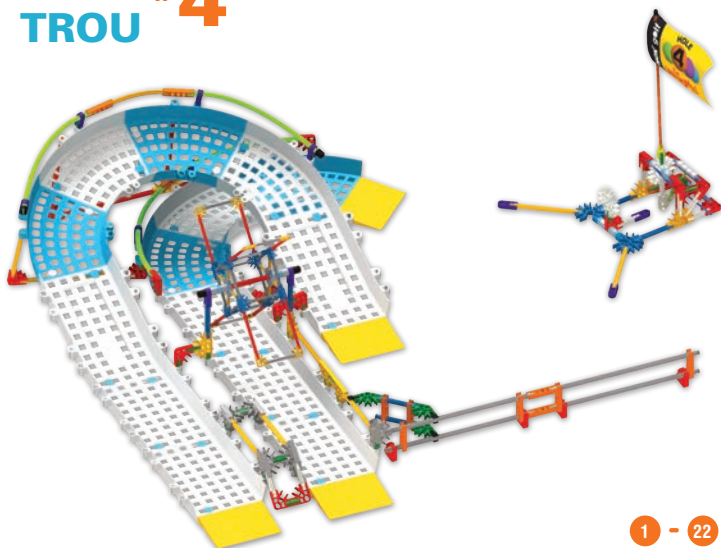

1 - 16



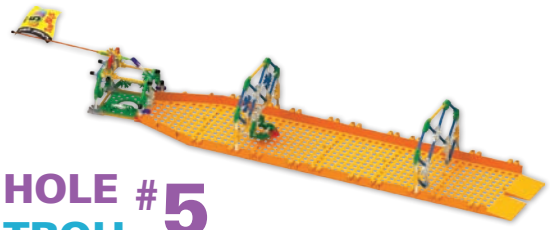

HOLE #5 TROU

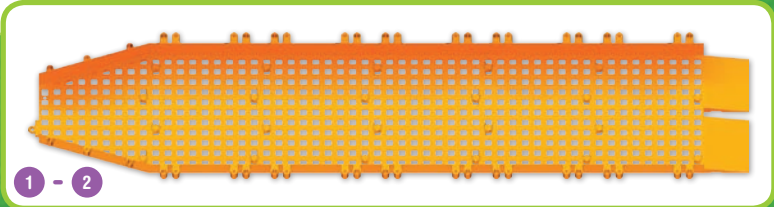
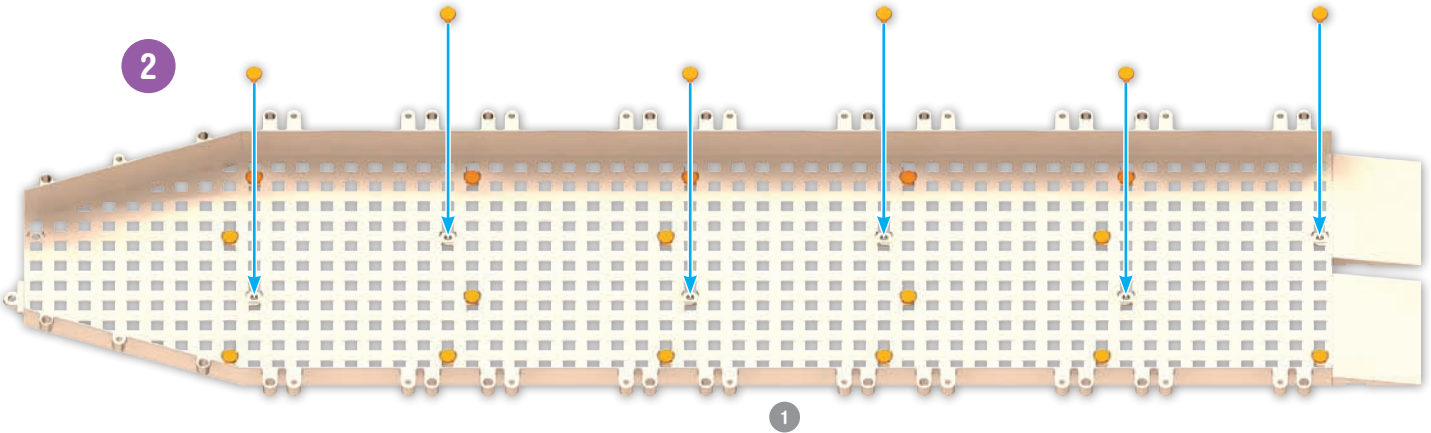
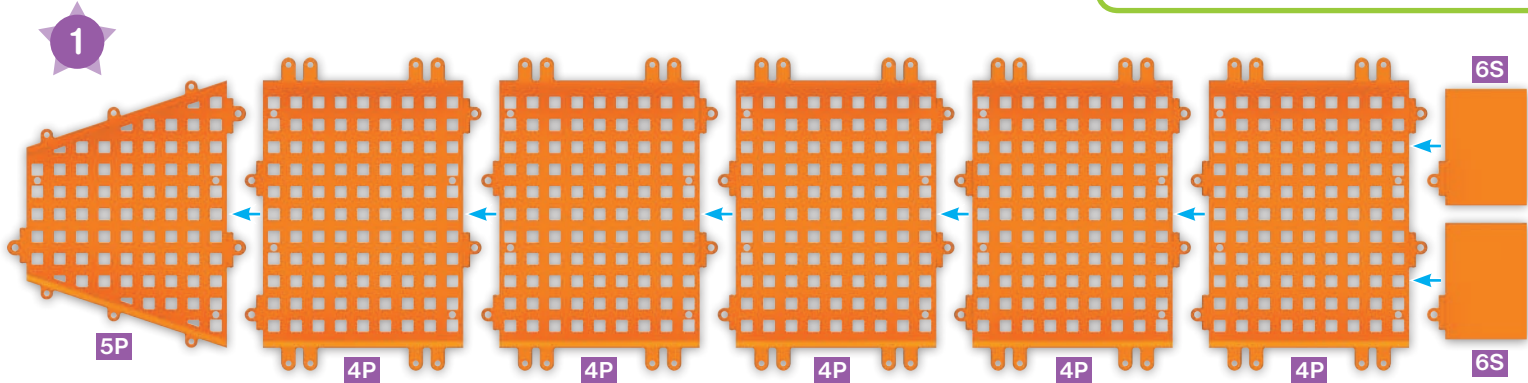
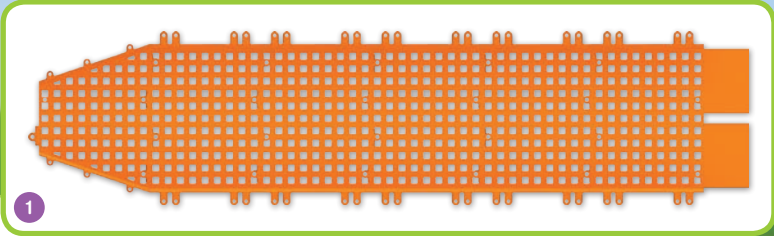

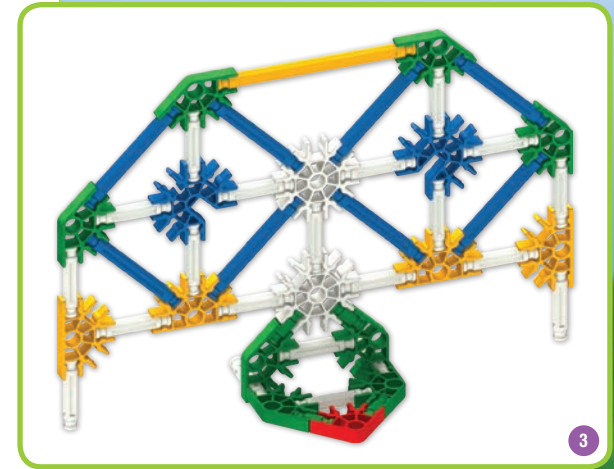
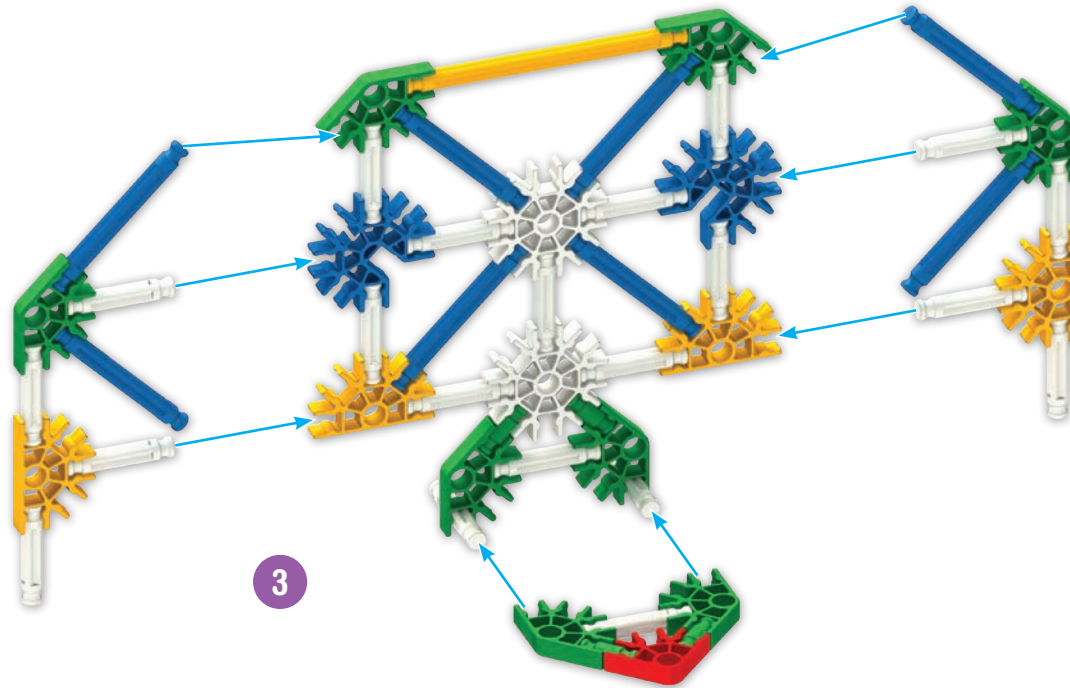

- 2 21 8
- 1
- 4 1 8 2 2

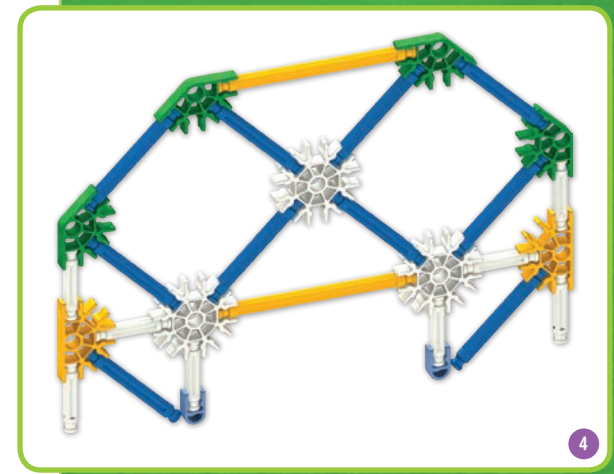
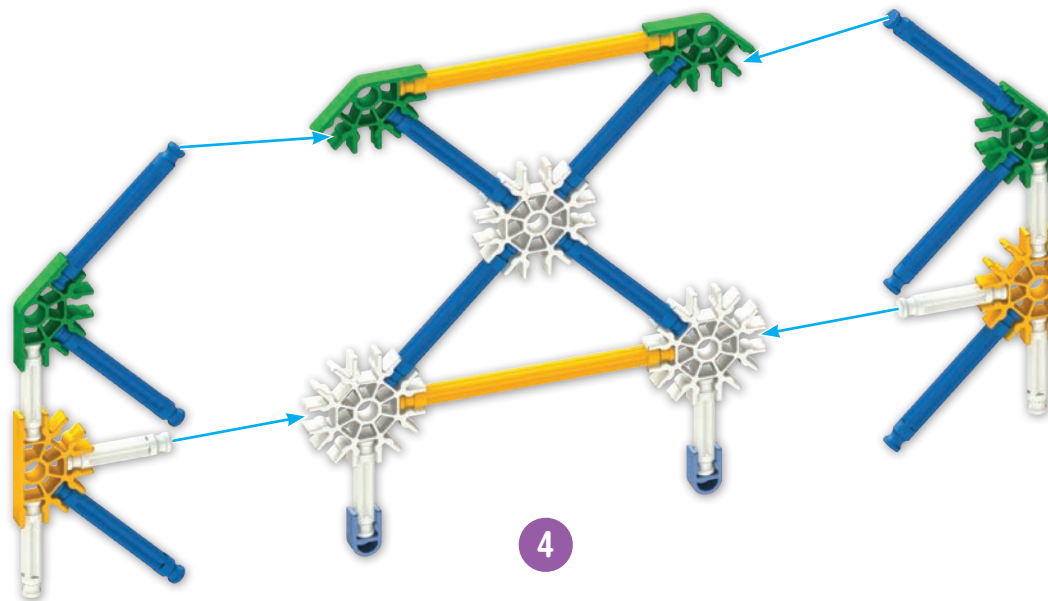

- 8 10
- 2
- 2 2 4 3

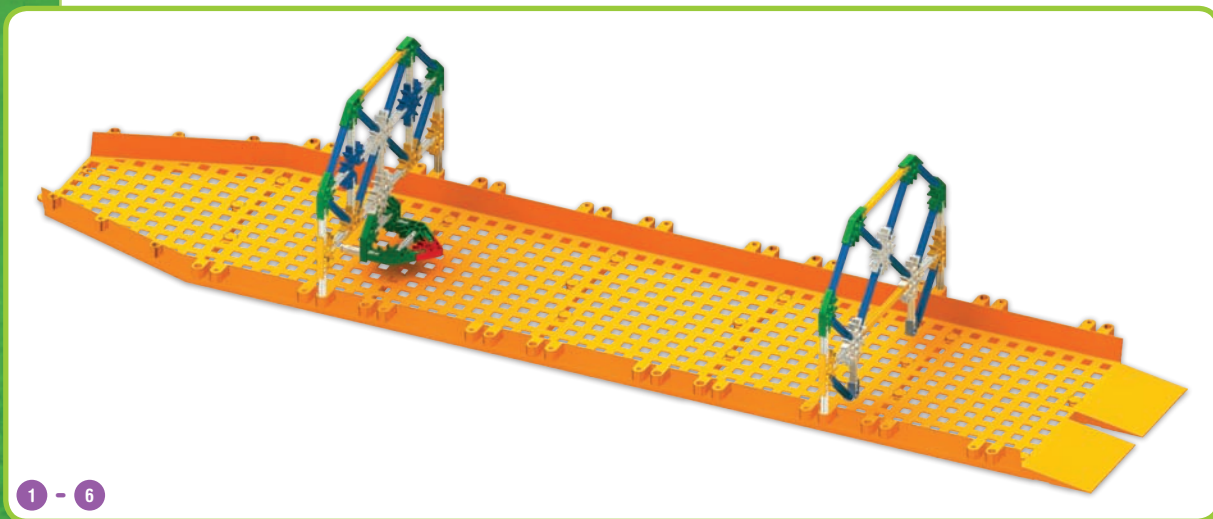
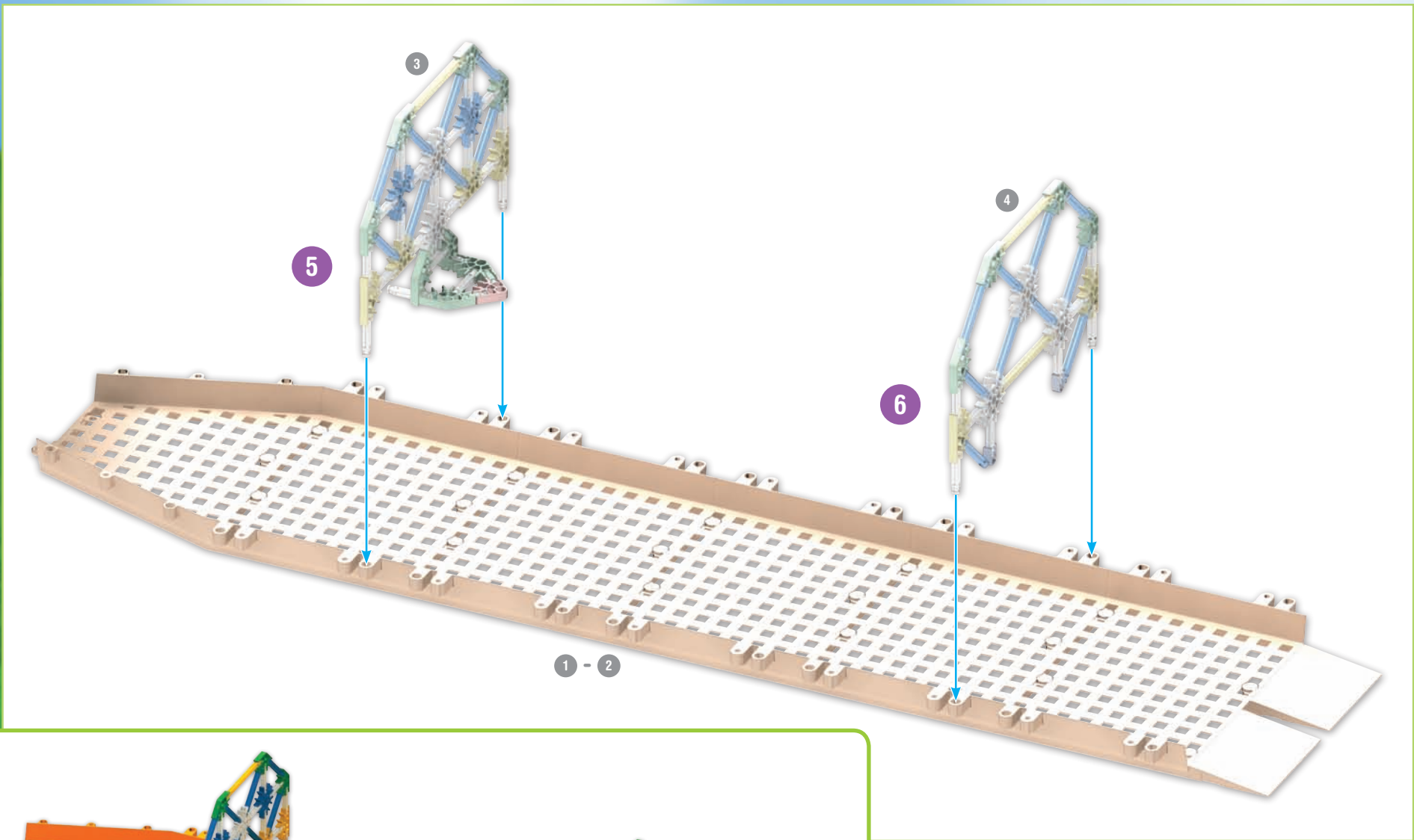

HOLE #5 TROU 5

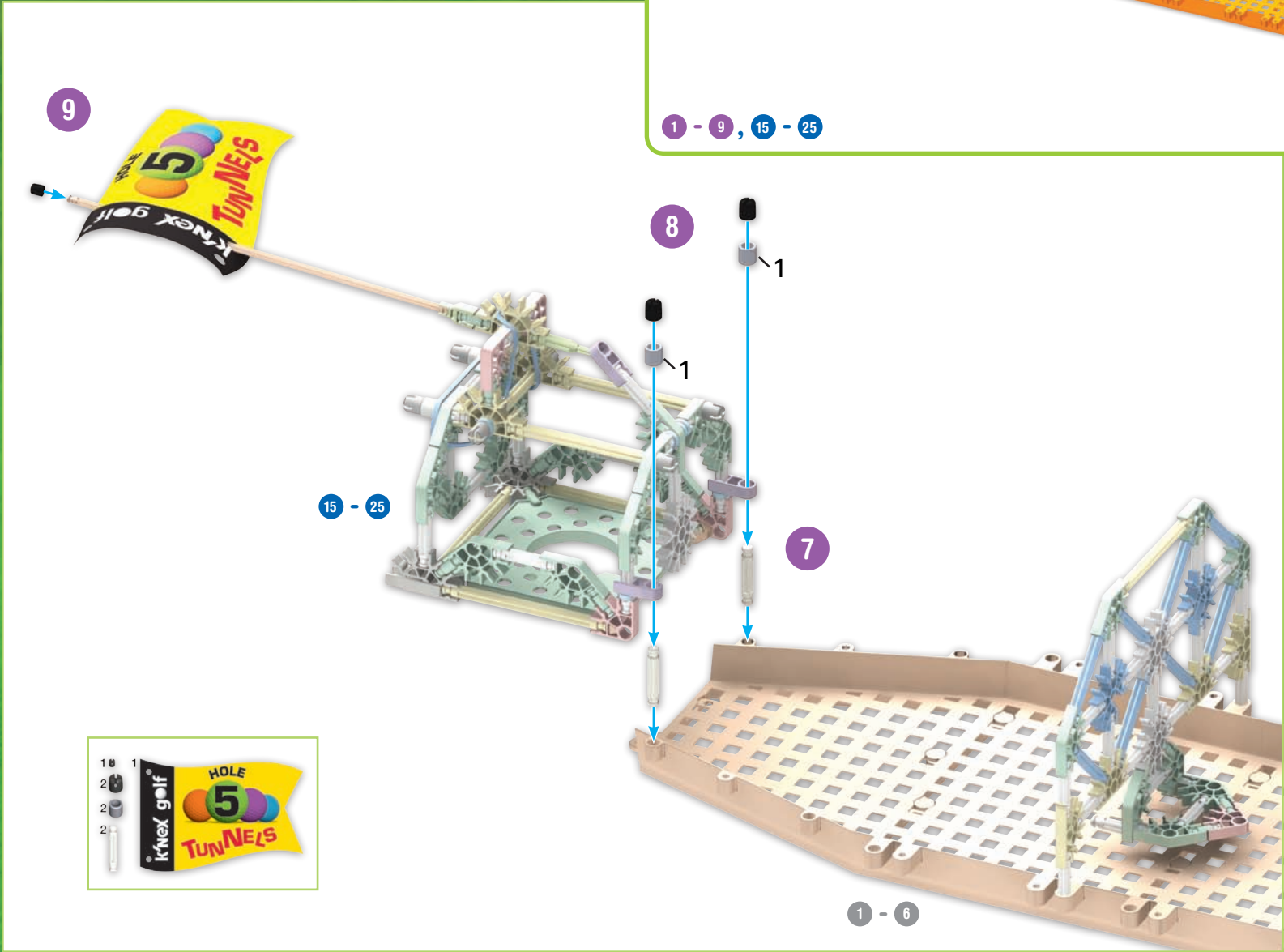

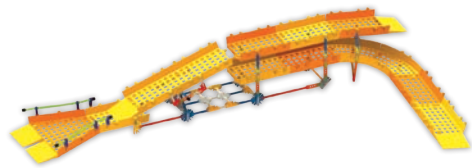

HOLE #6 TROU #6

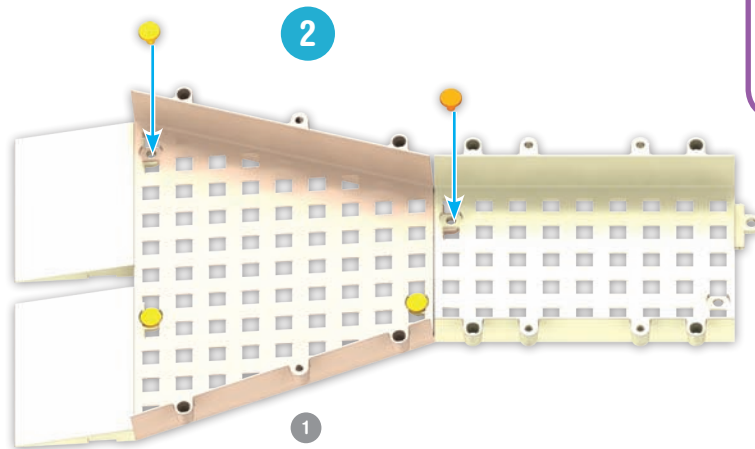
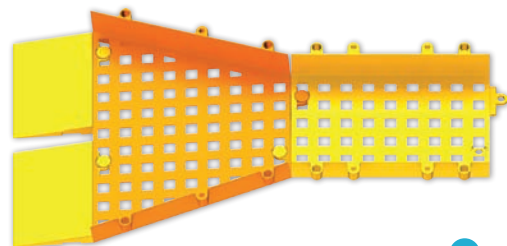
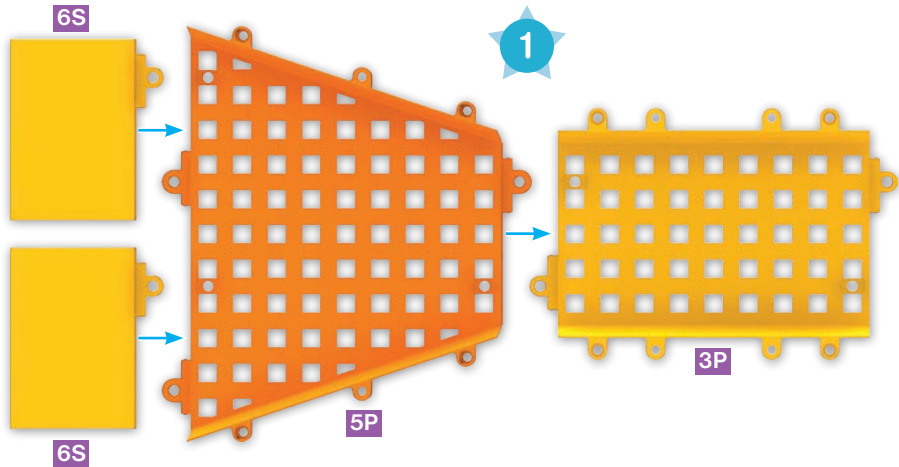
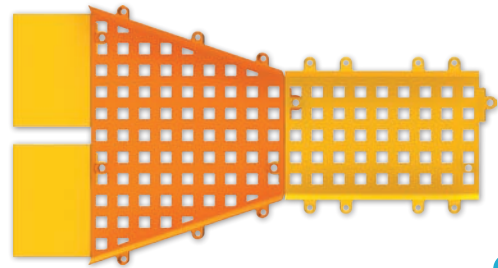

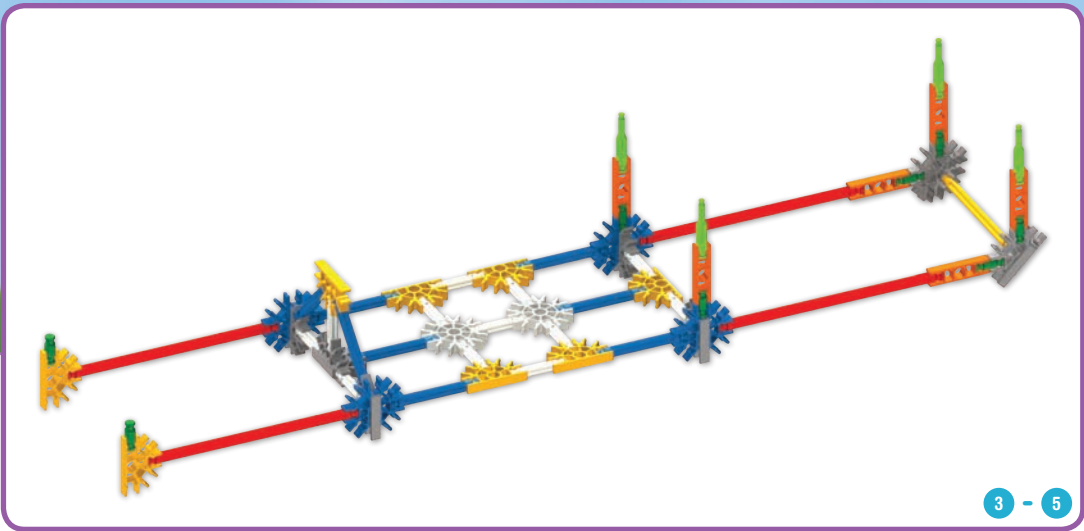

8	12	1
8	4	4
6	4	4
8	10	4
		2

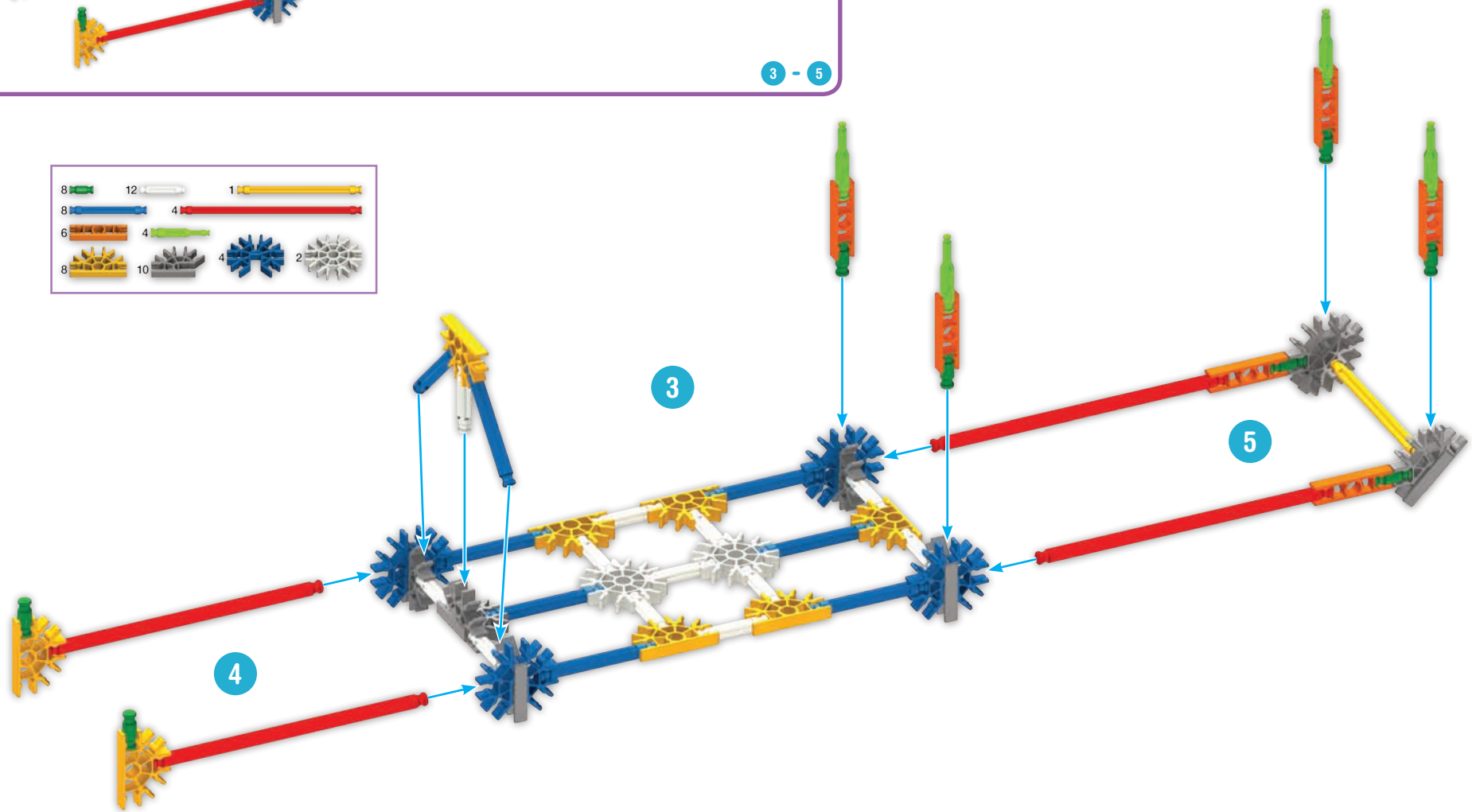

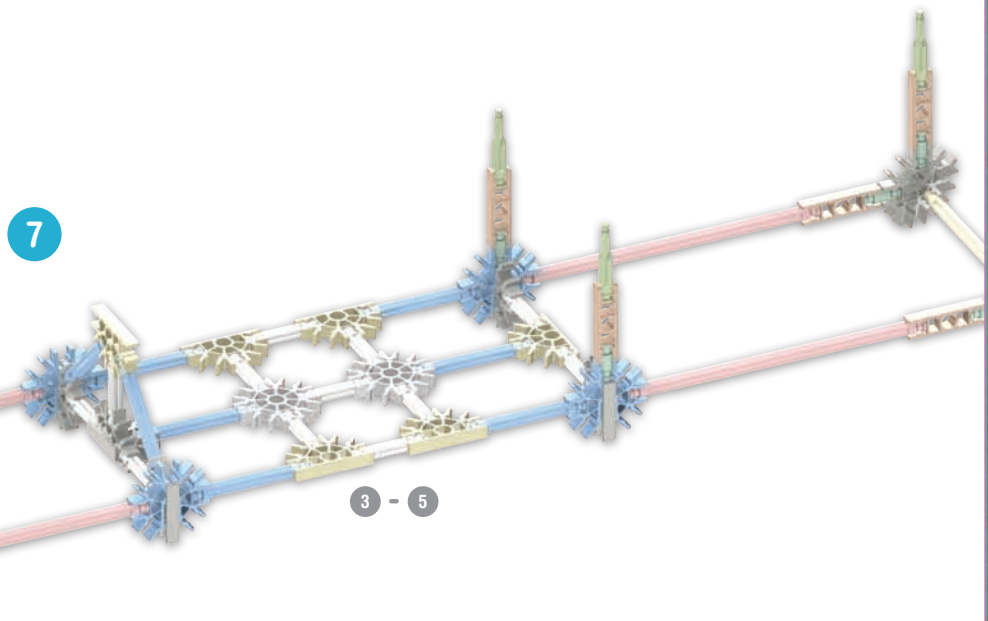
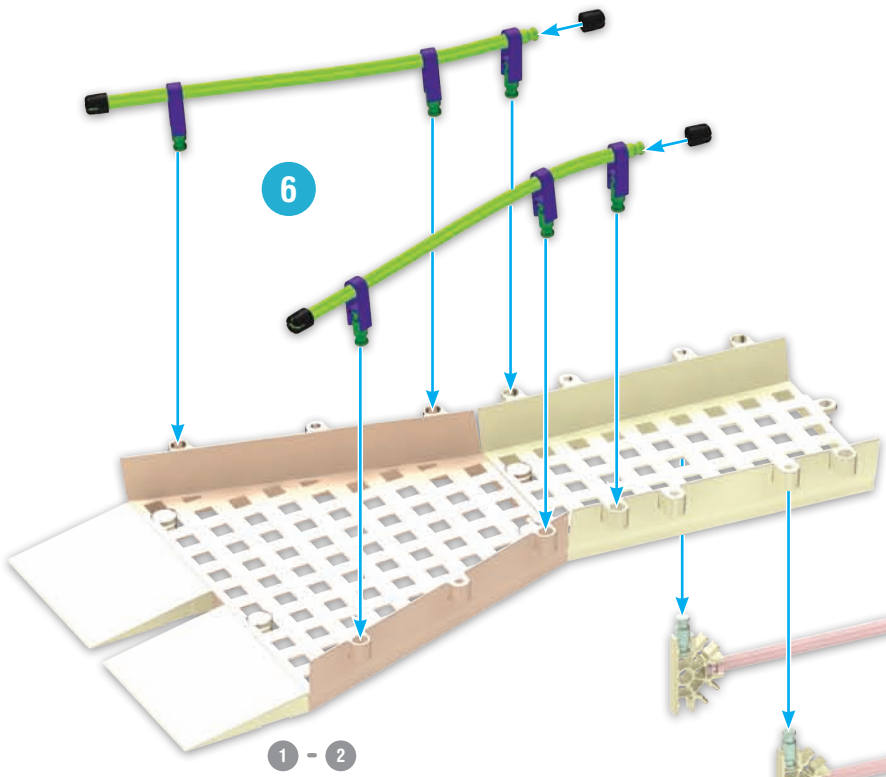
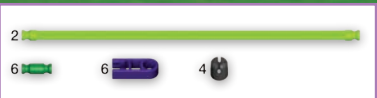
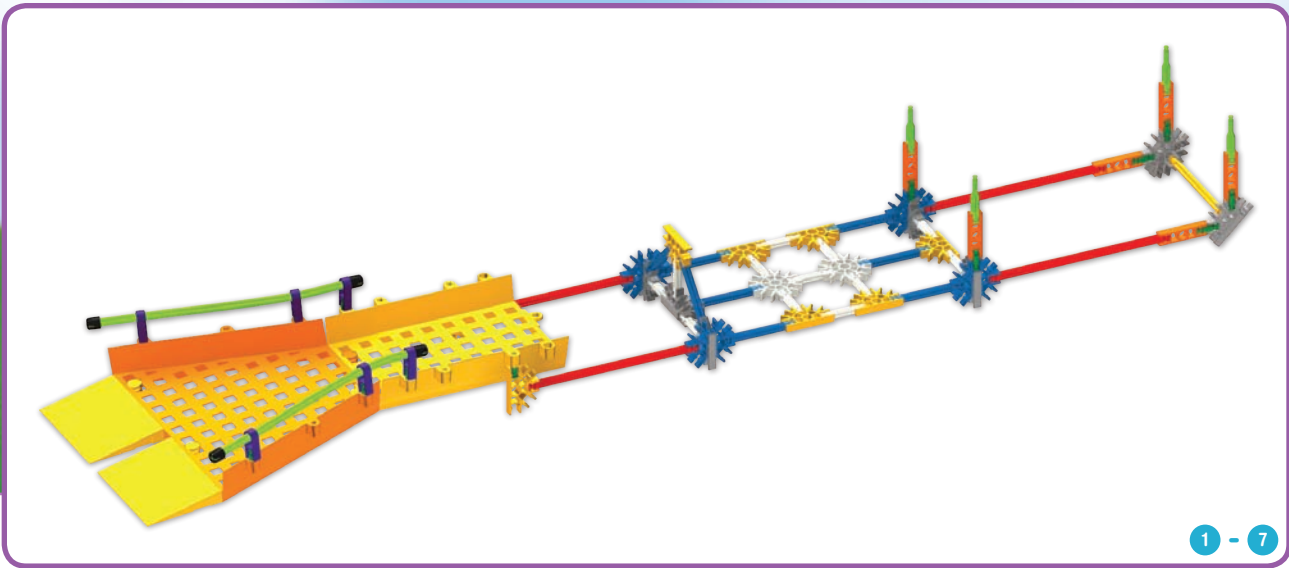

8

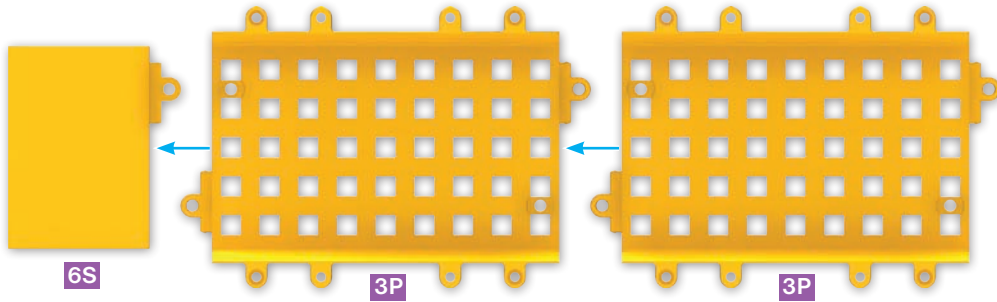

8

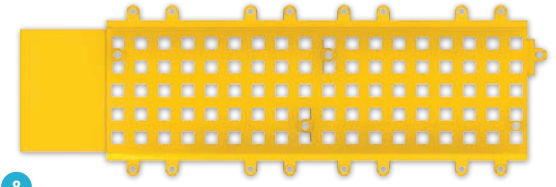

9

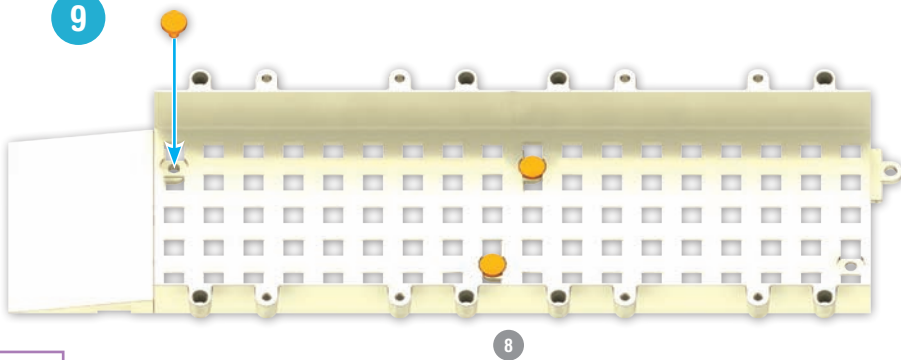

8

3



8 - 9

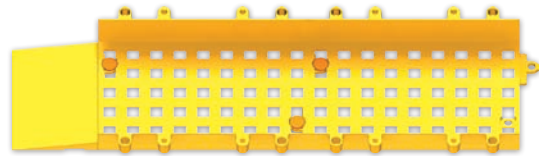

10

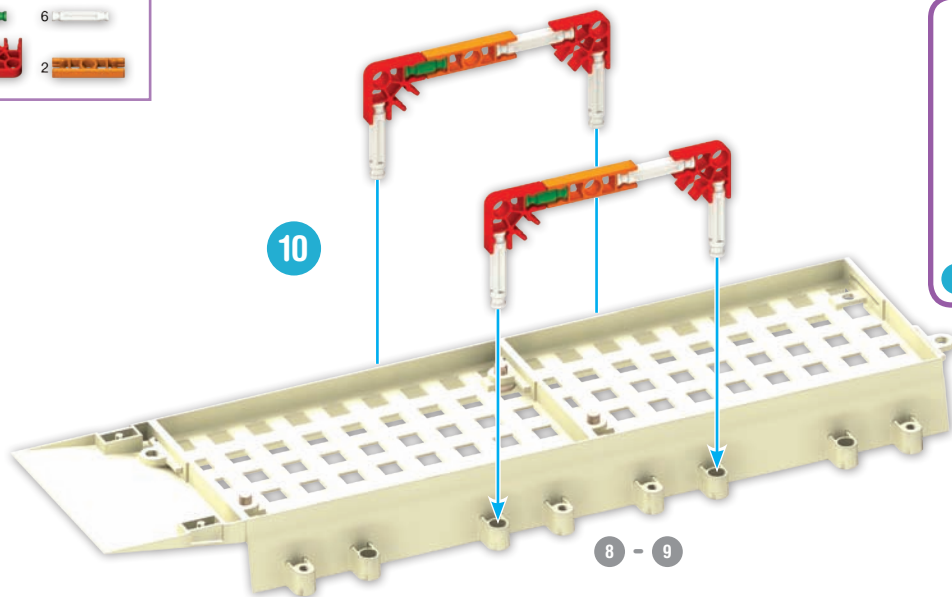
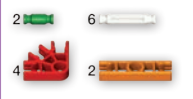

8 - 9

8 - 10

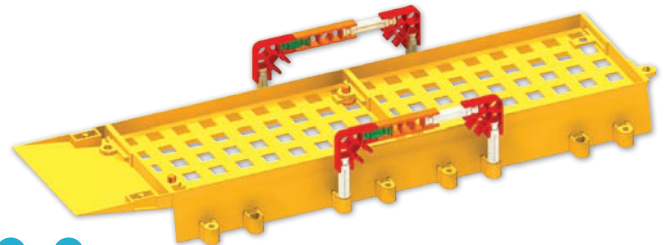

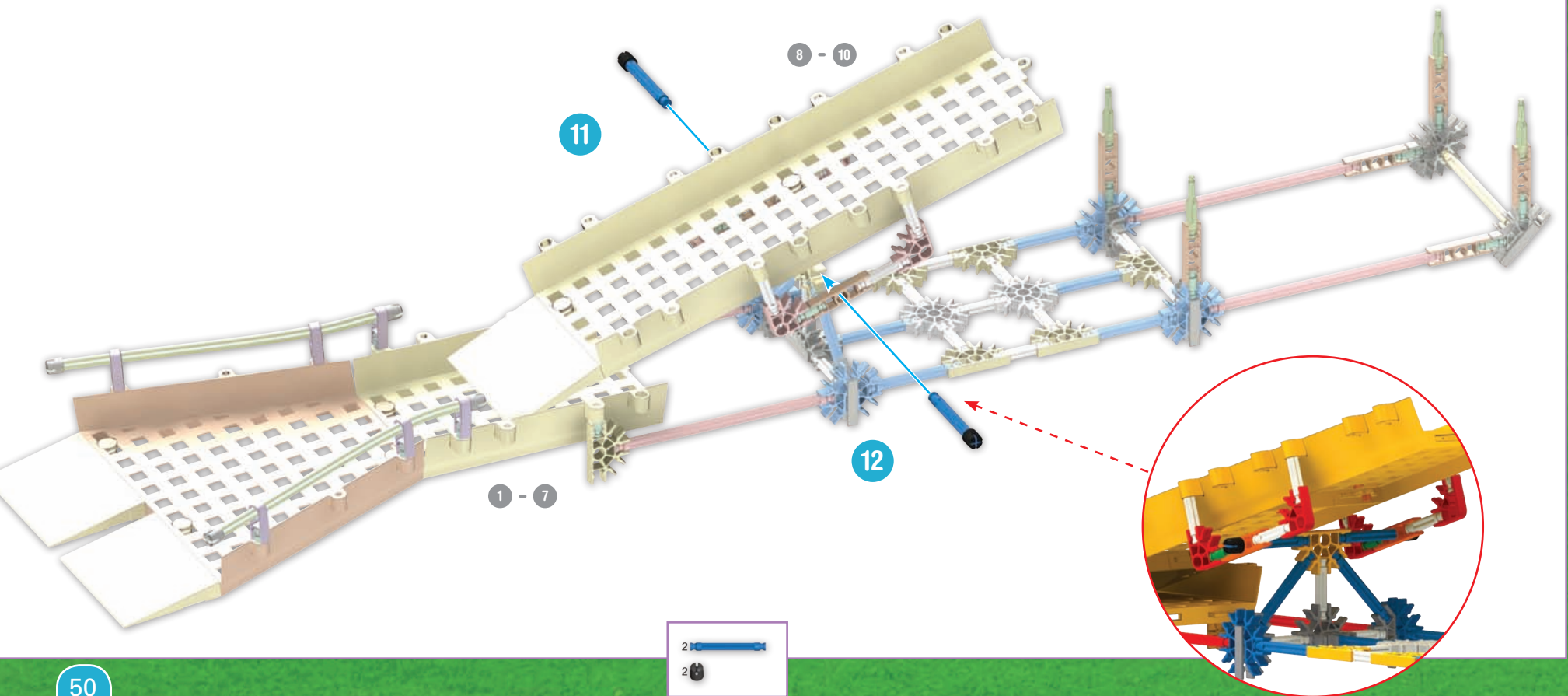
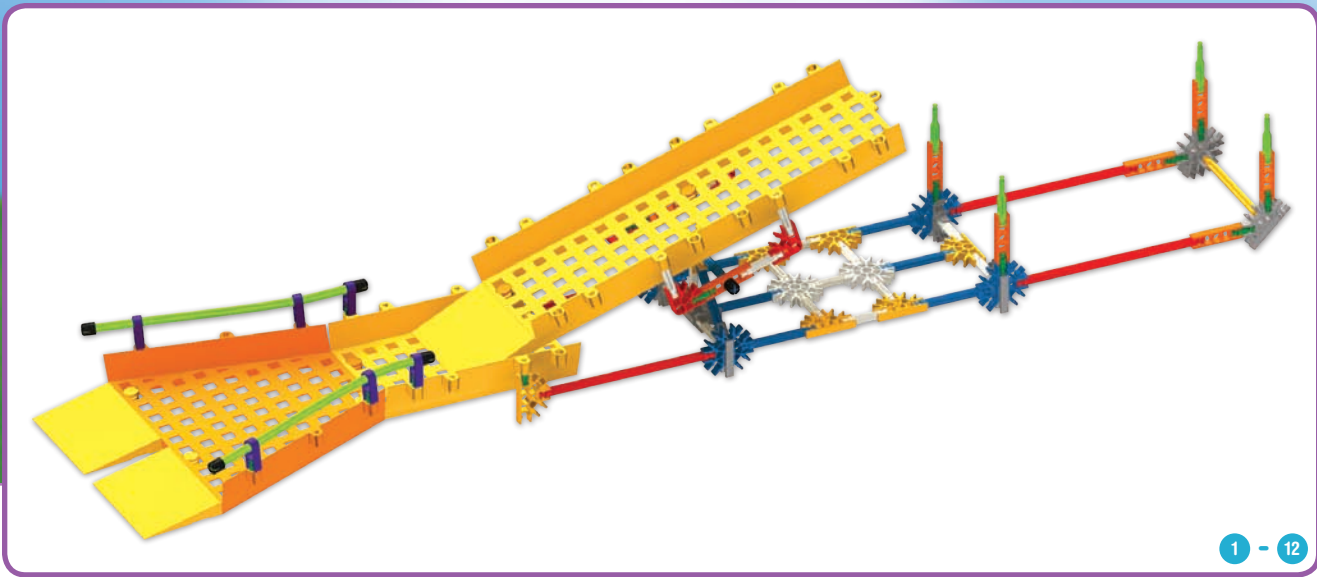

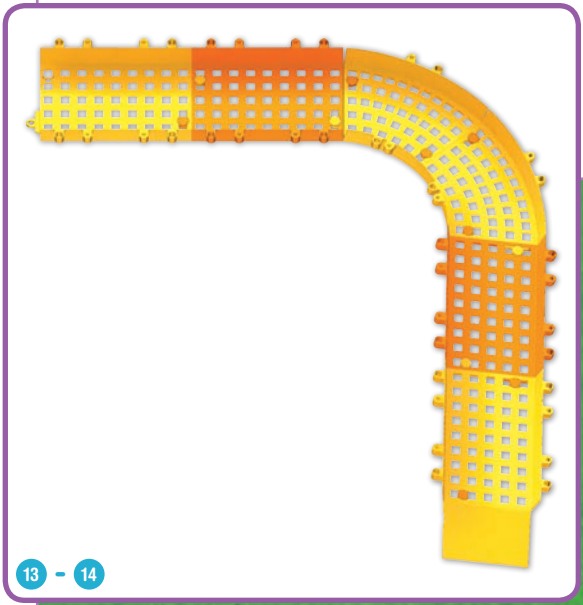
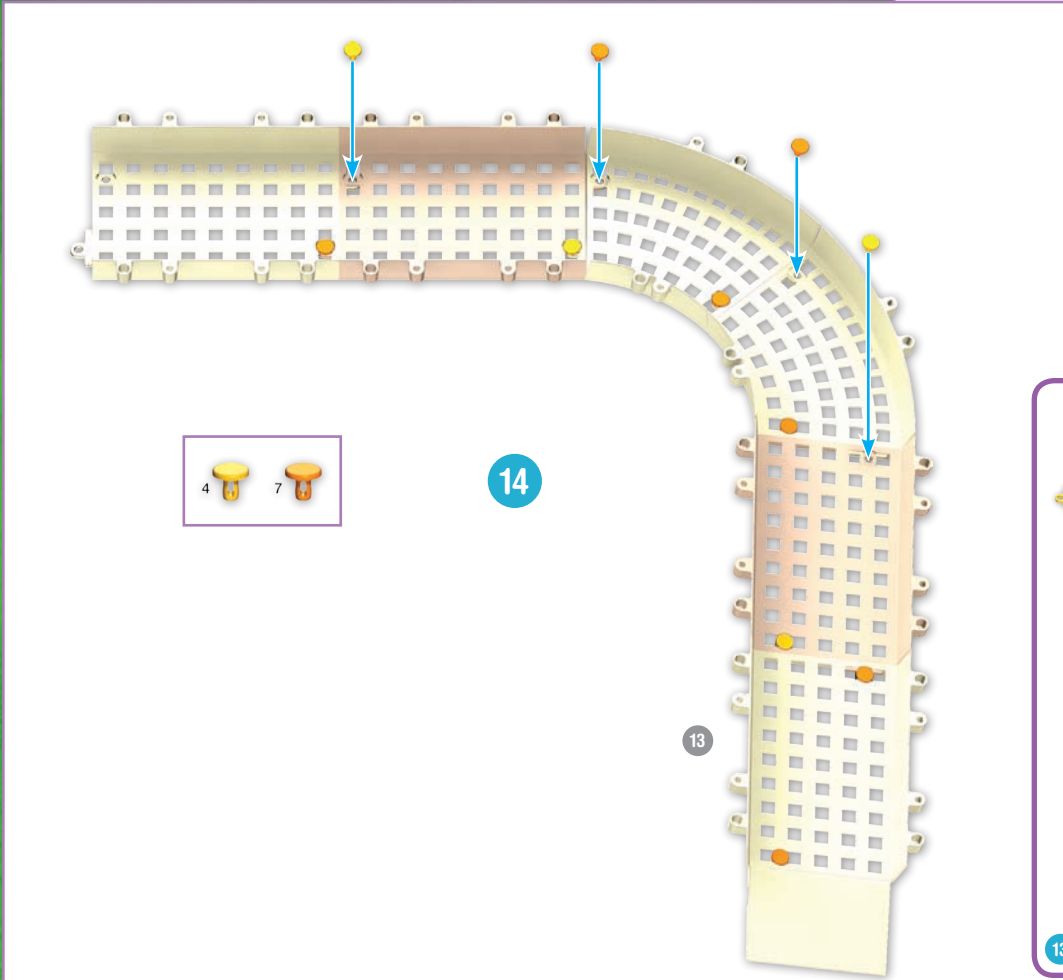
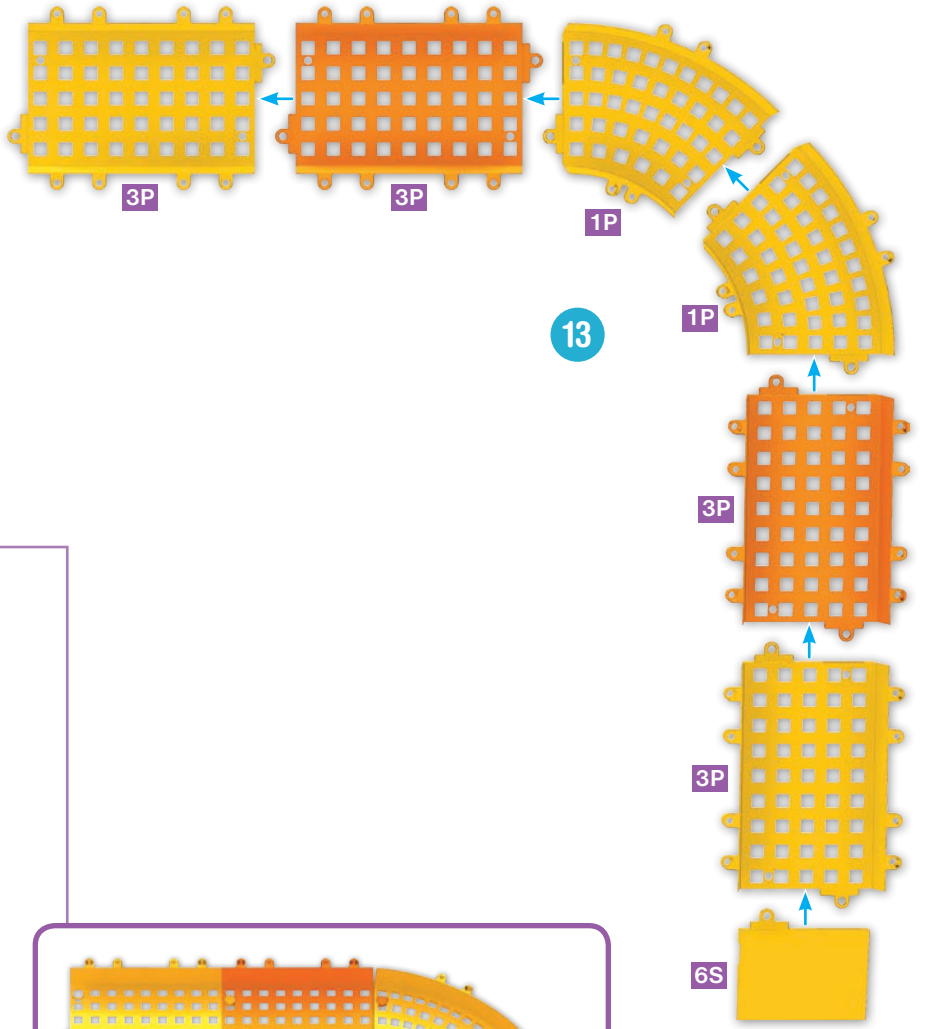
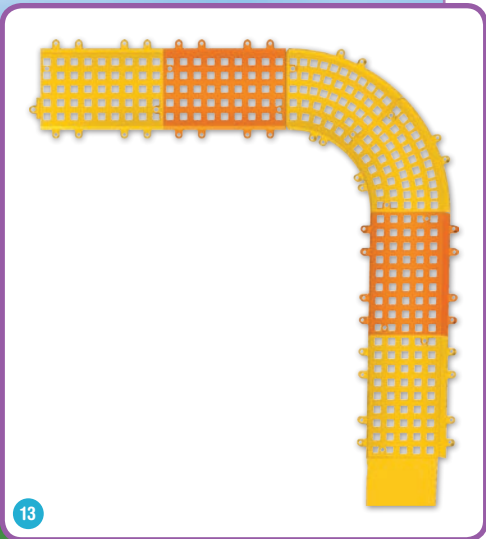

13 - 14

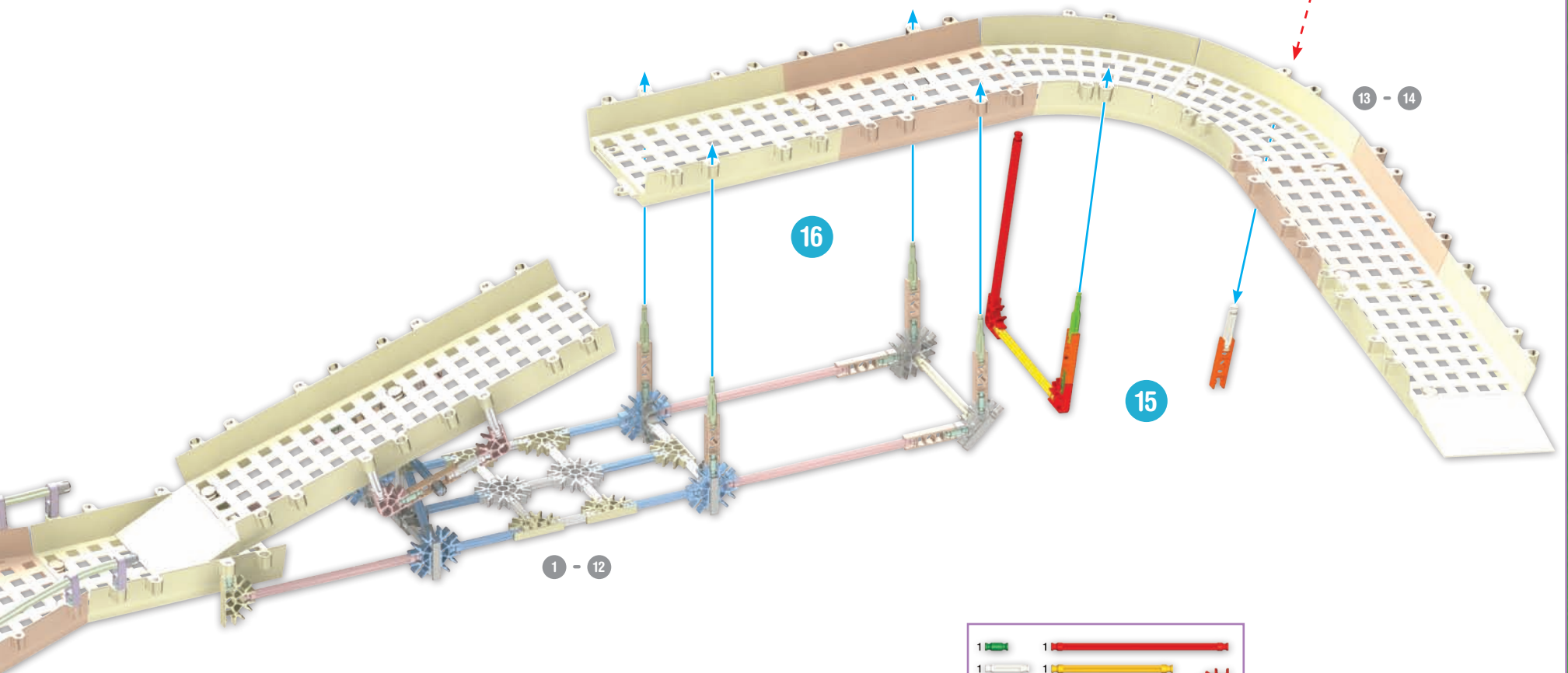
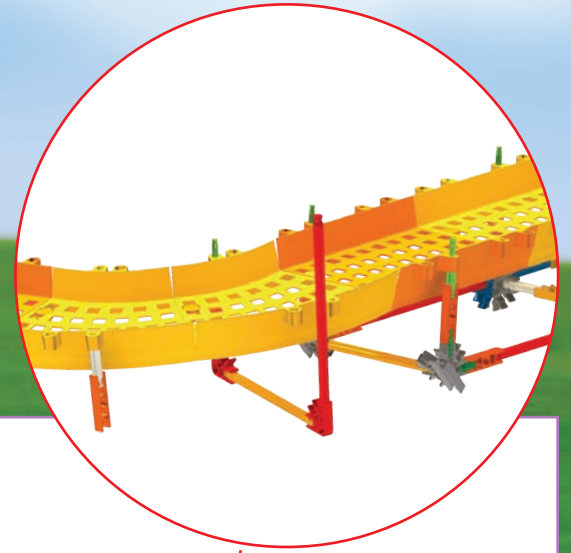
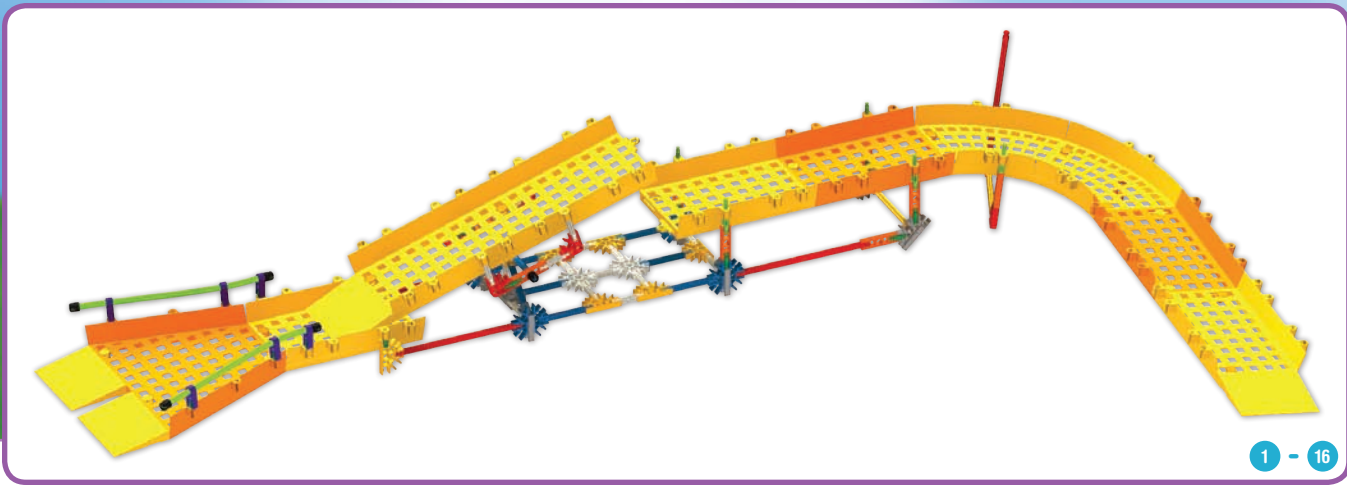

1	1	1	1
1	1	1	1
1	2	2	2

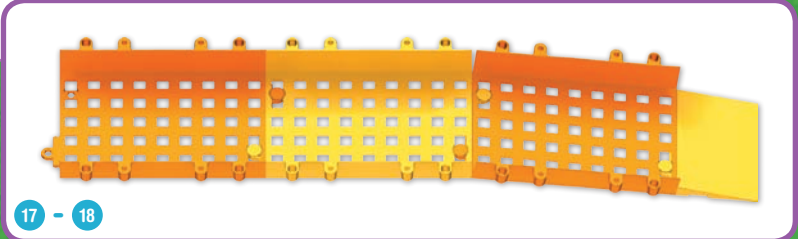
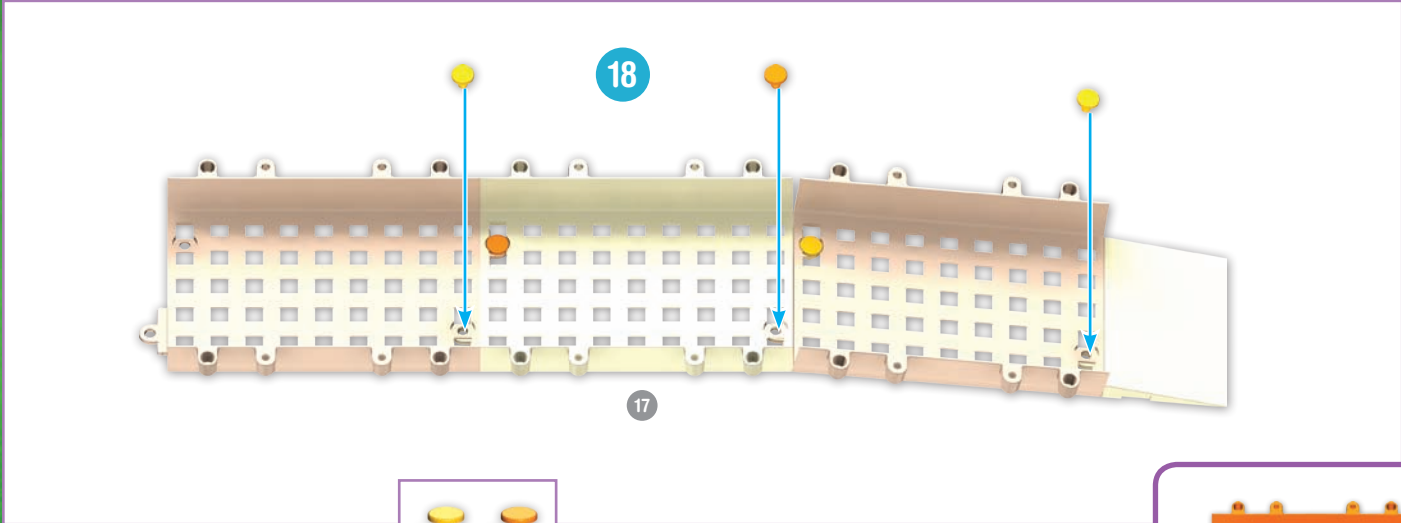
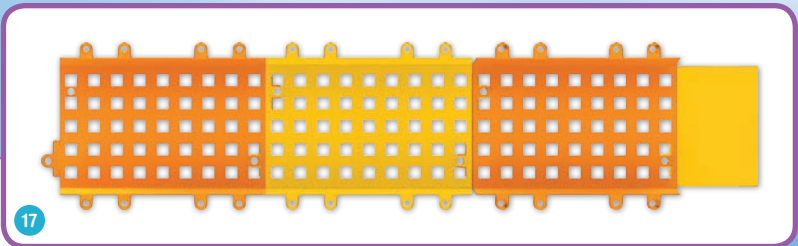
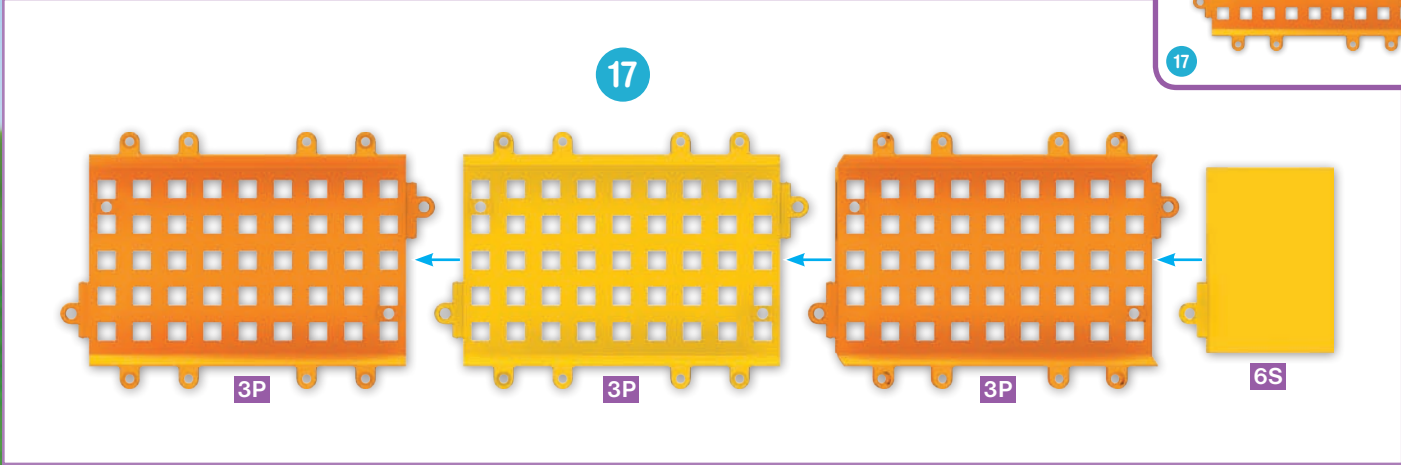

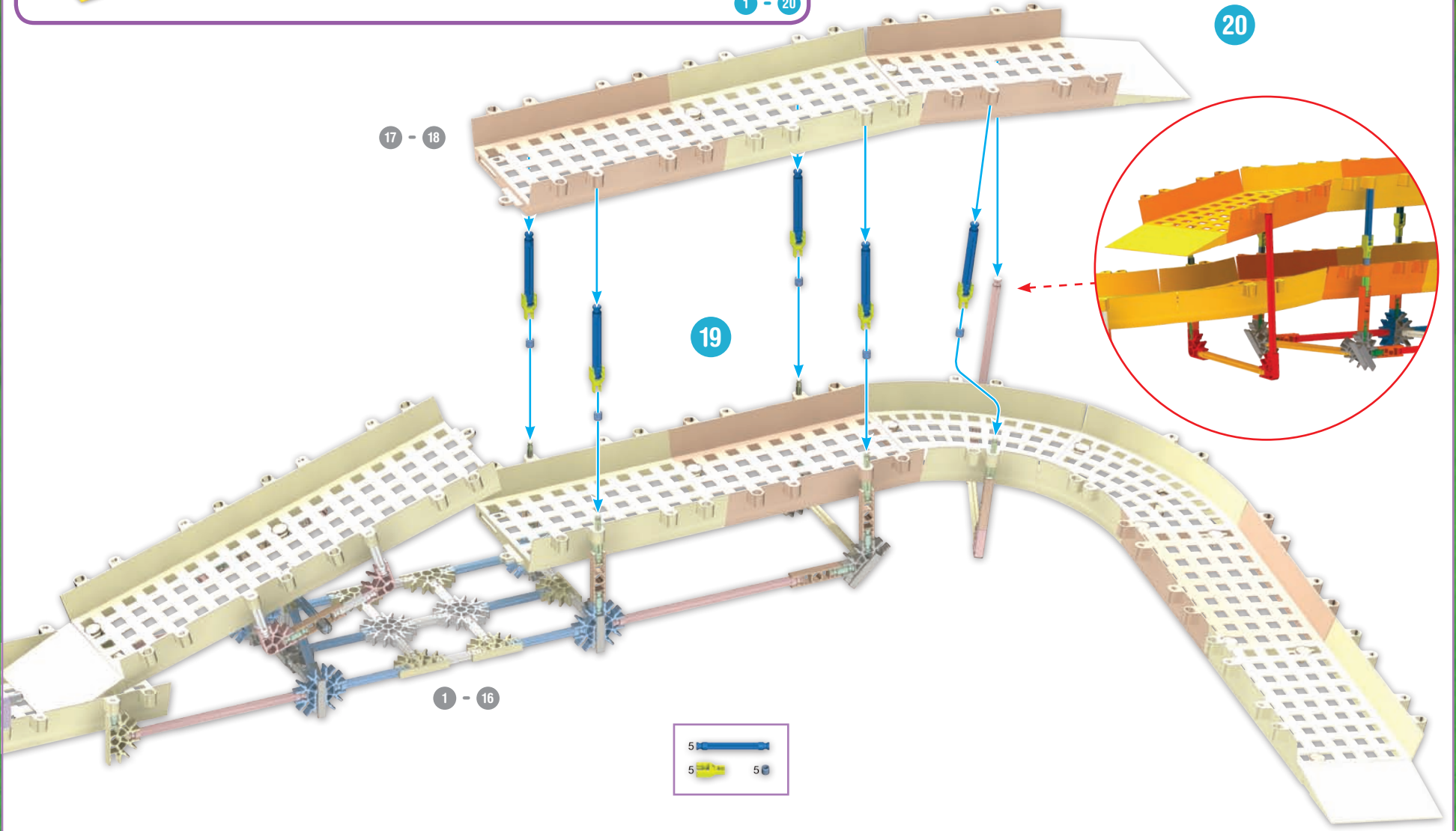
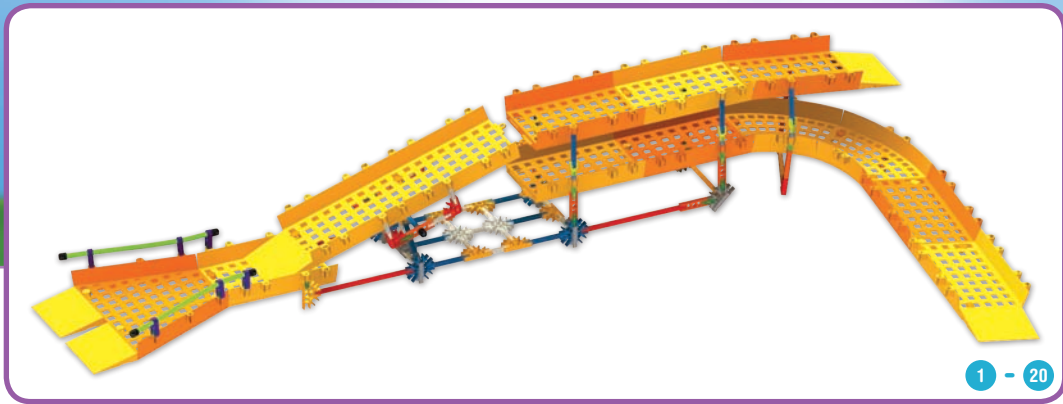

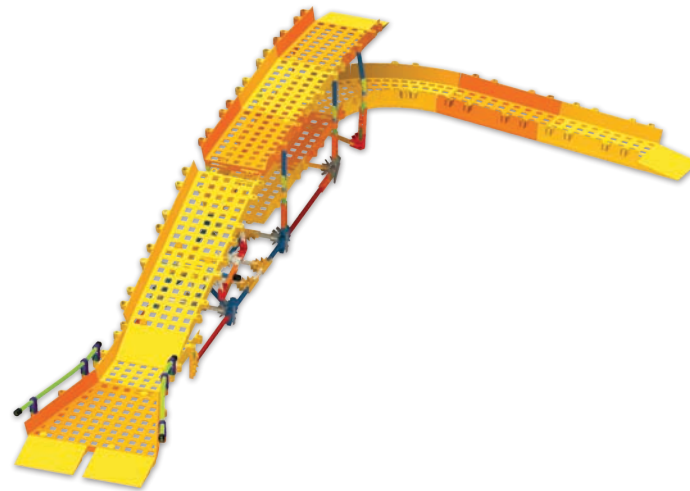

HOLE #6 TROU

1 - 21, 17 - 21

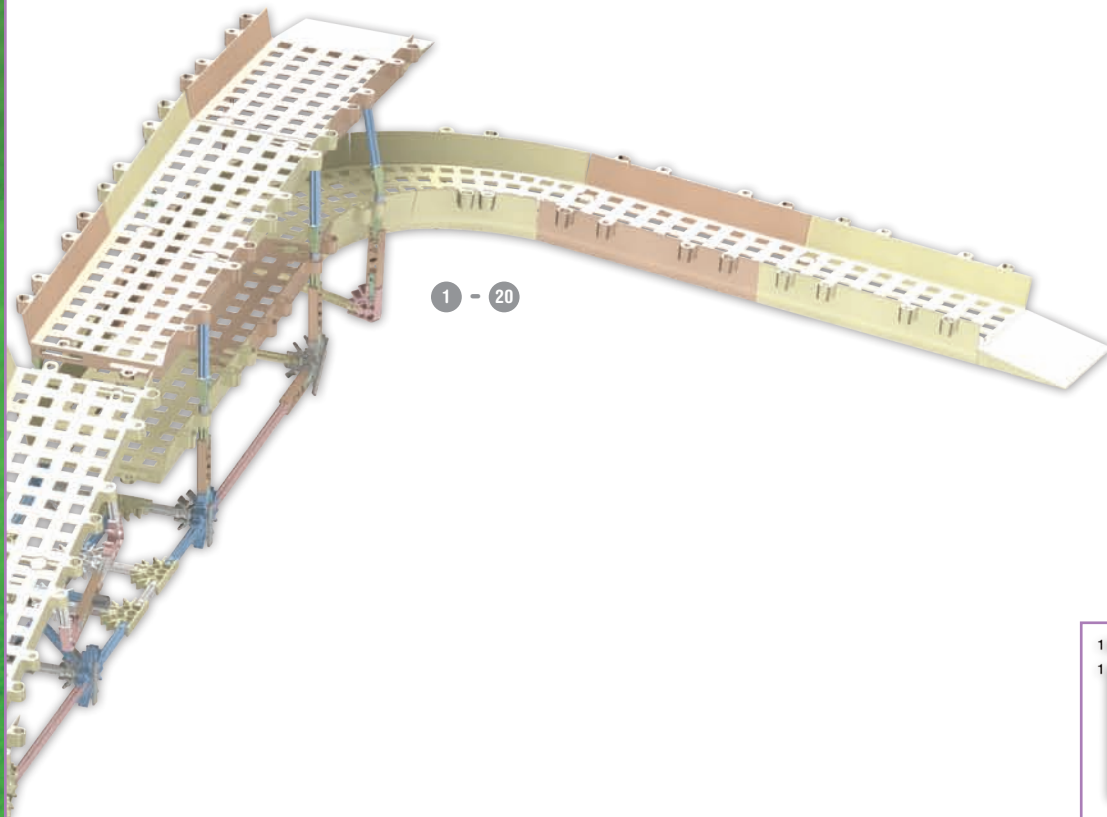

1 - 20



17 - 21

21



HOLE #7 TROU #7



1

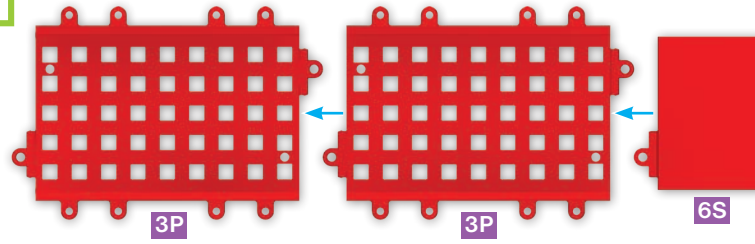

2

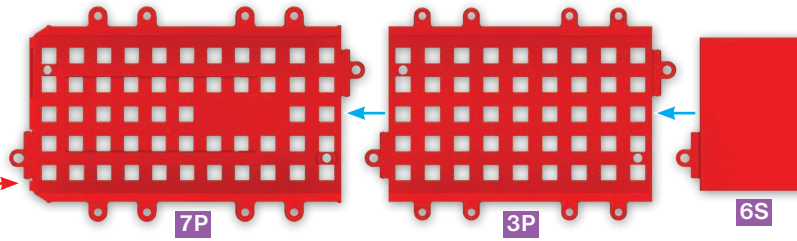

3

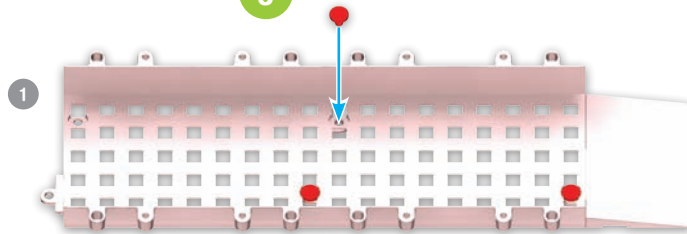

4

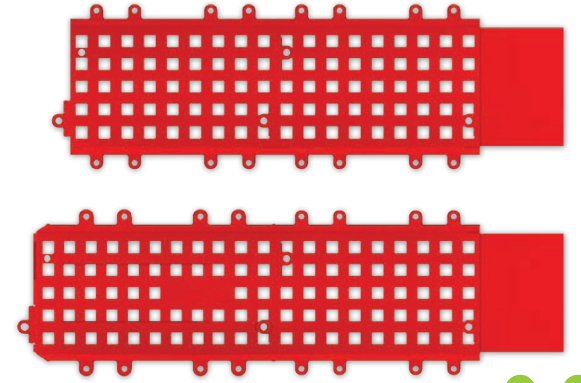
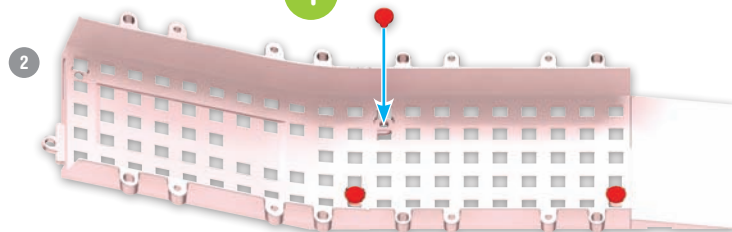

1 - 2

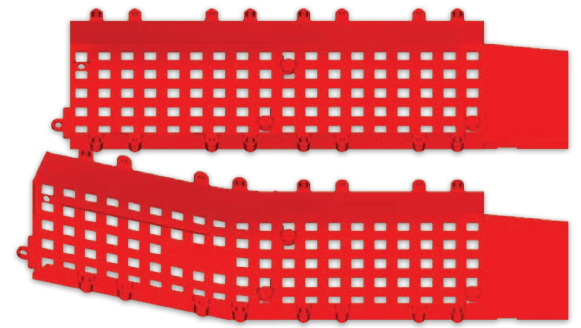

1 - 4

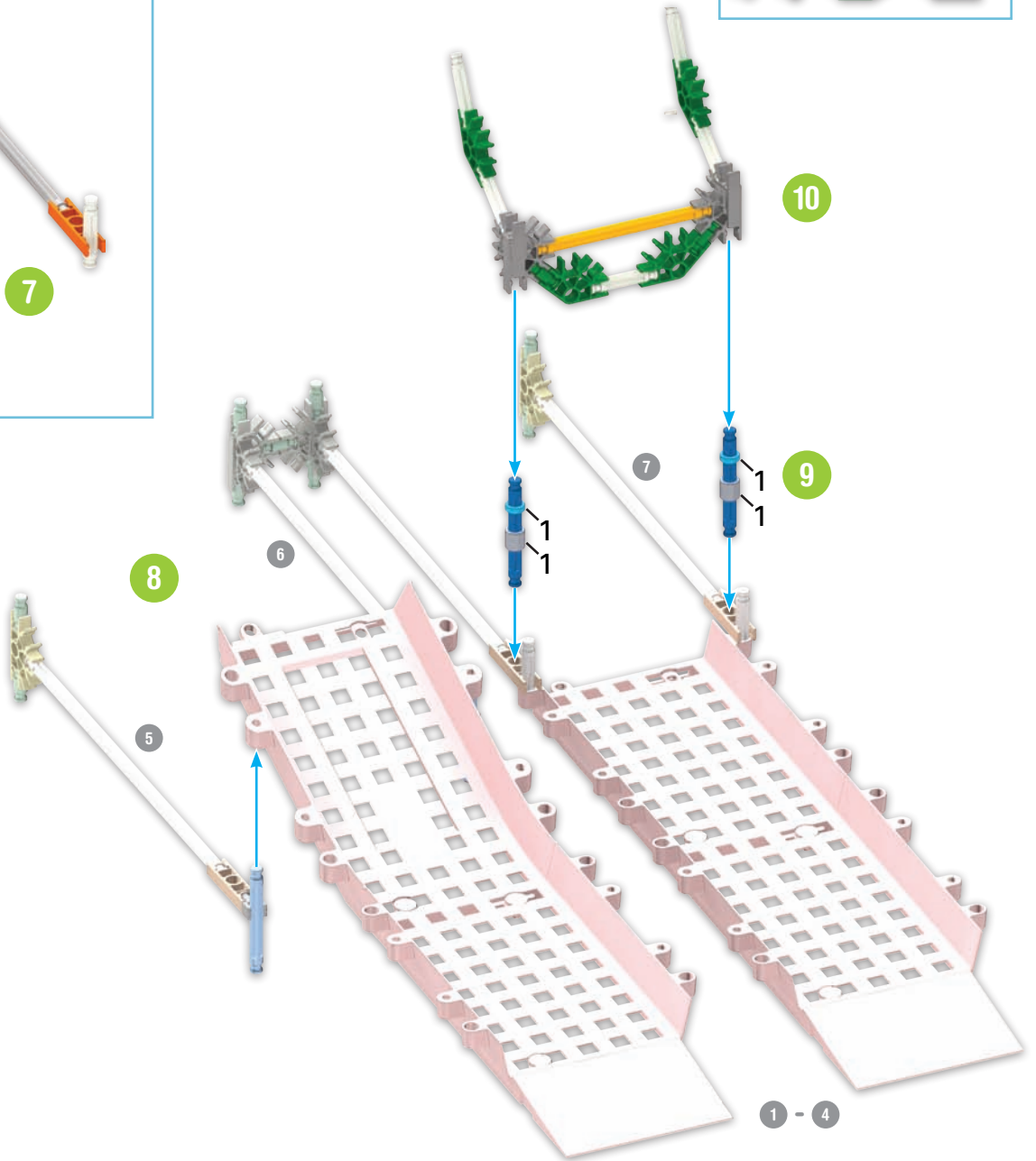
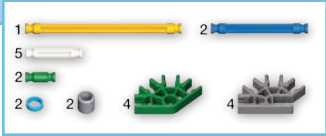
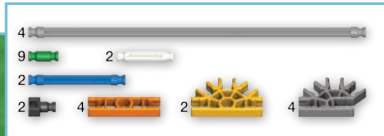

1 - 10

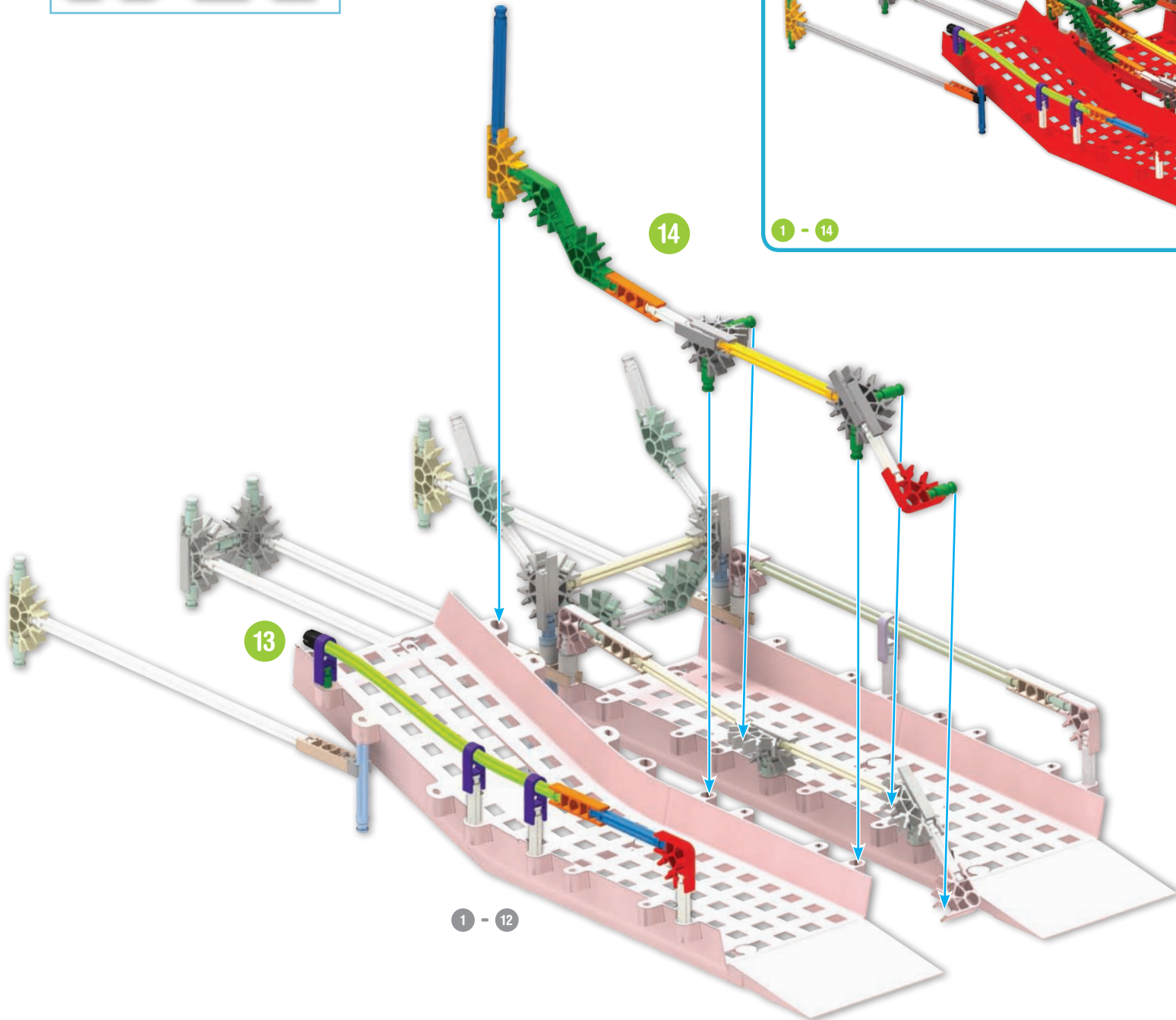
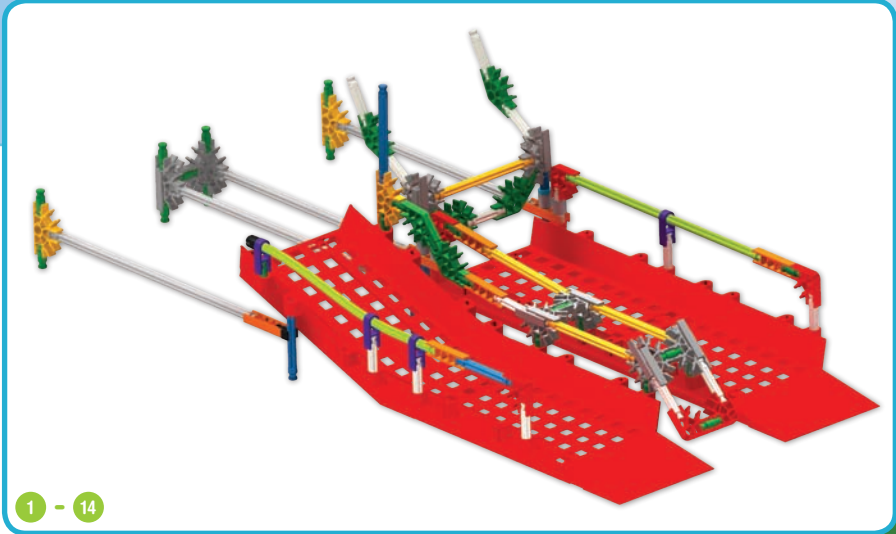
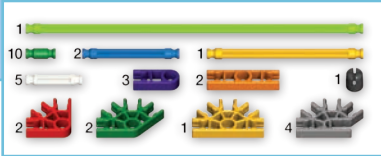

15

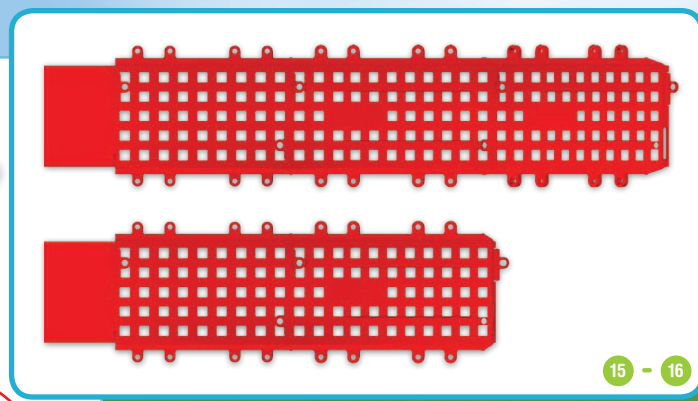
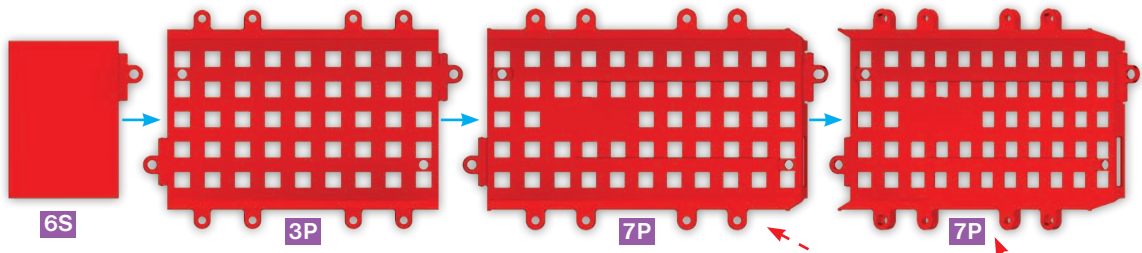

15 - 16

16

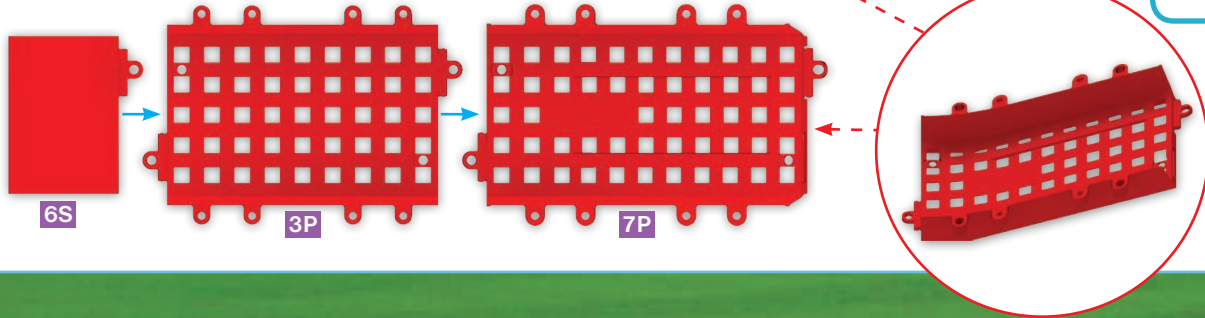

17

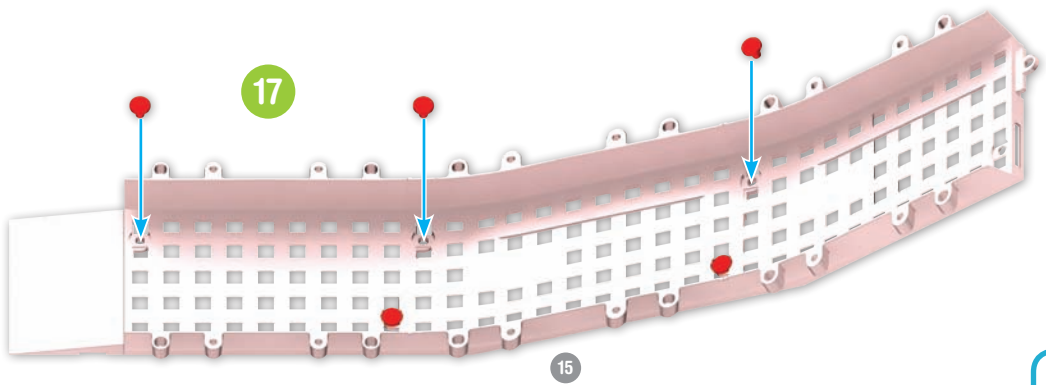

18

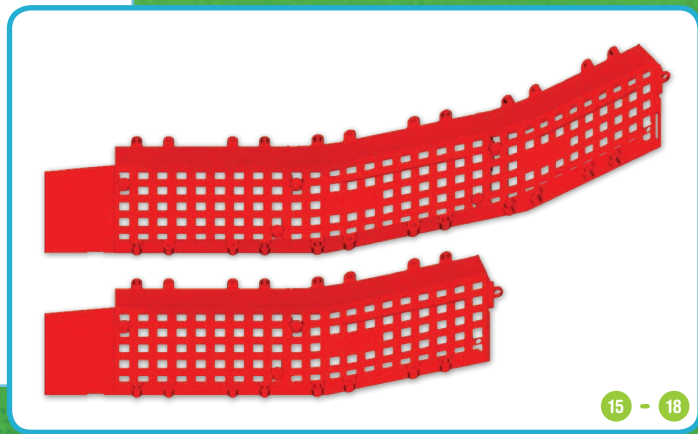
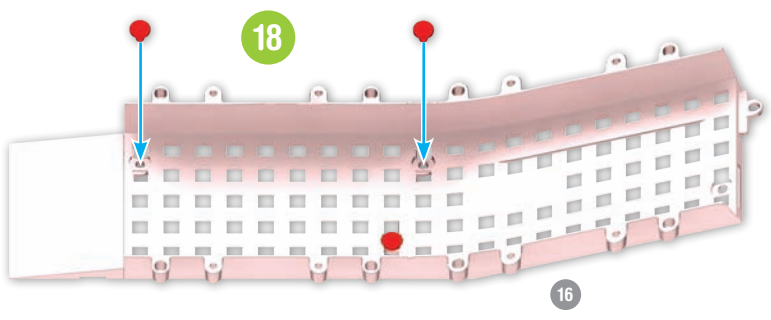

15 - 18

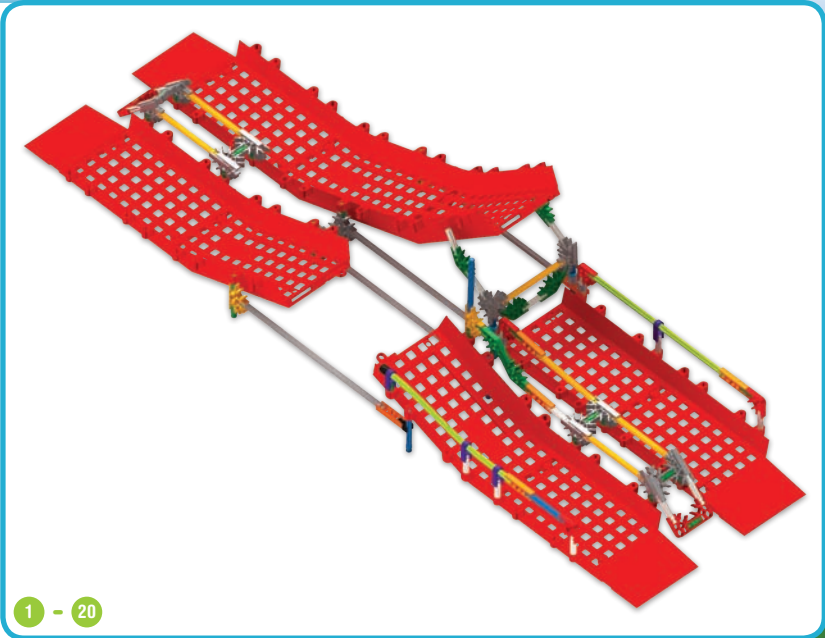
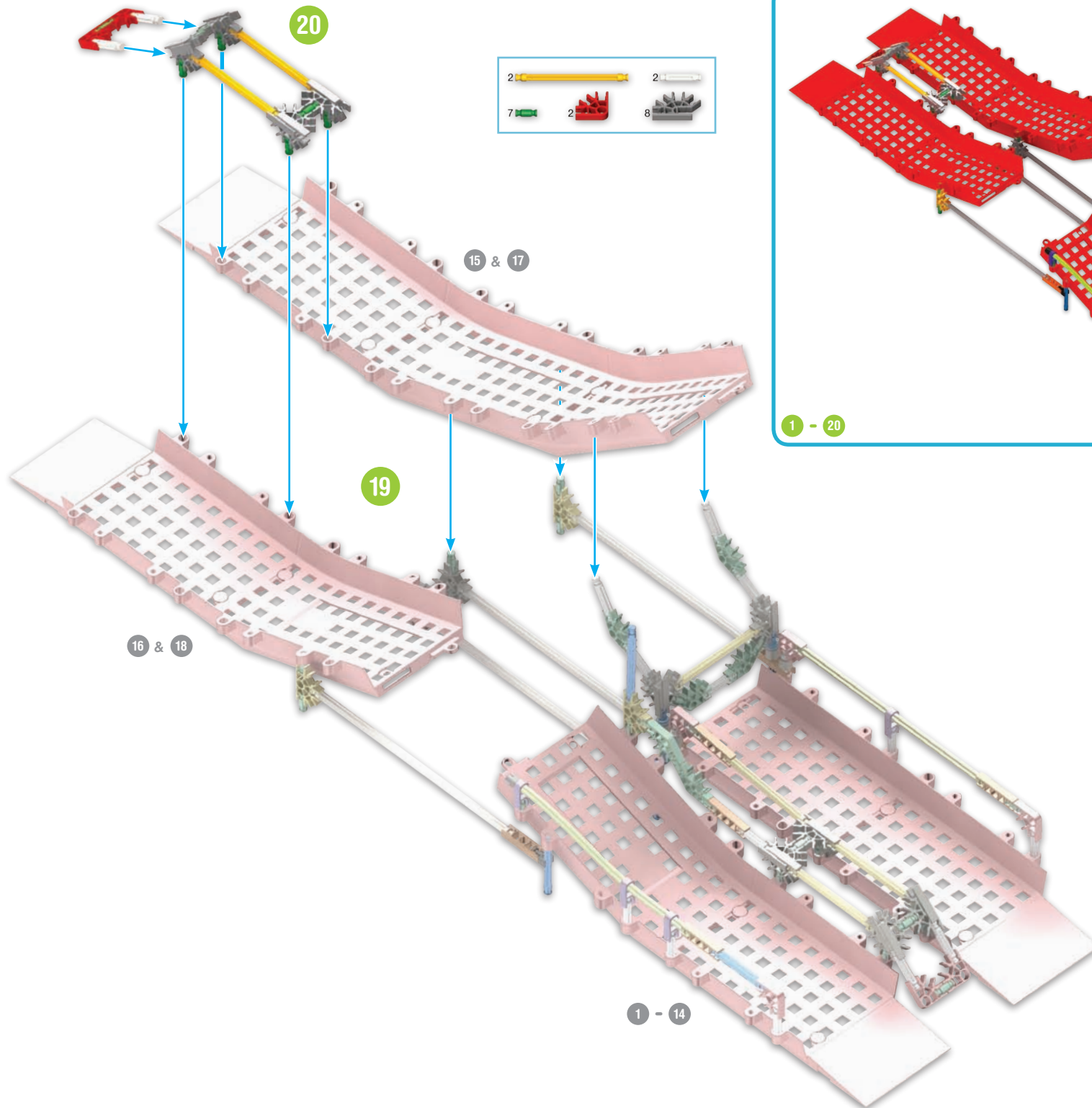

- 2
- 7
- 9
- 2
- 1
- 5
- 5
- 1
- 3
- 5
- 1

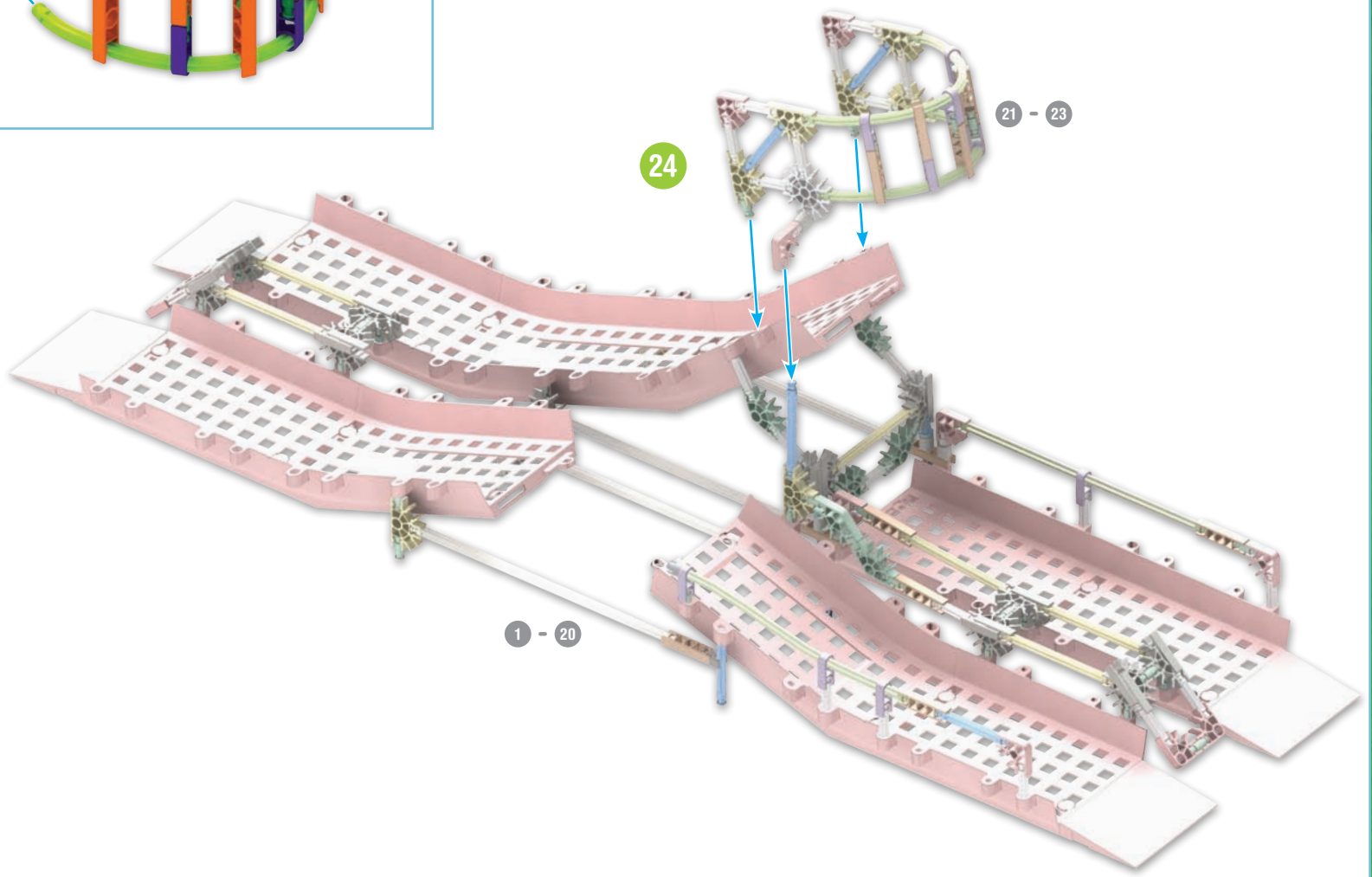
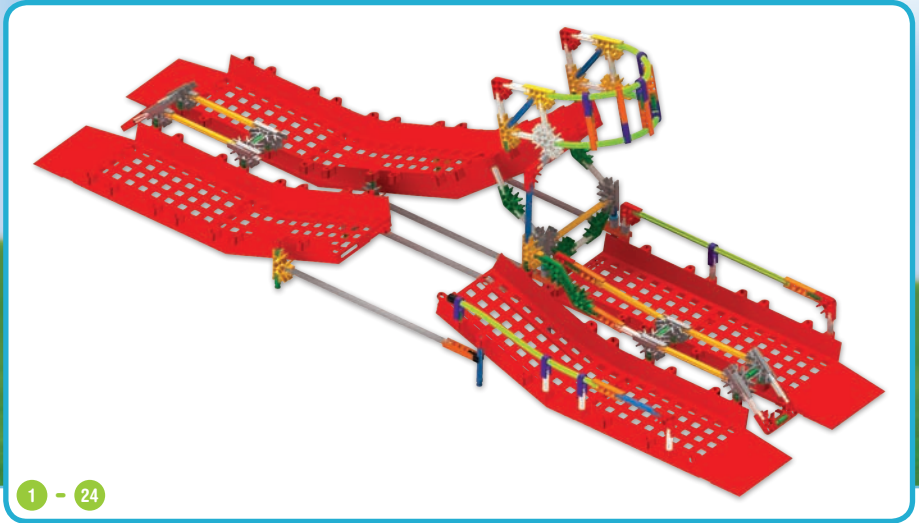
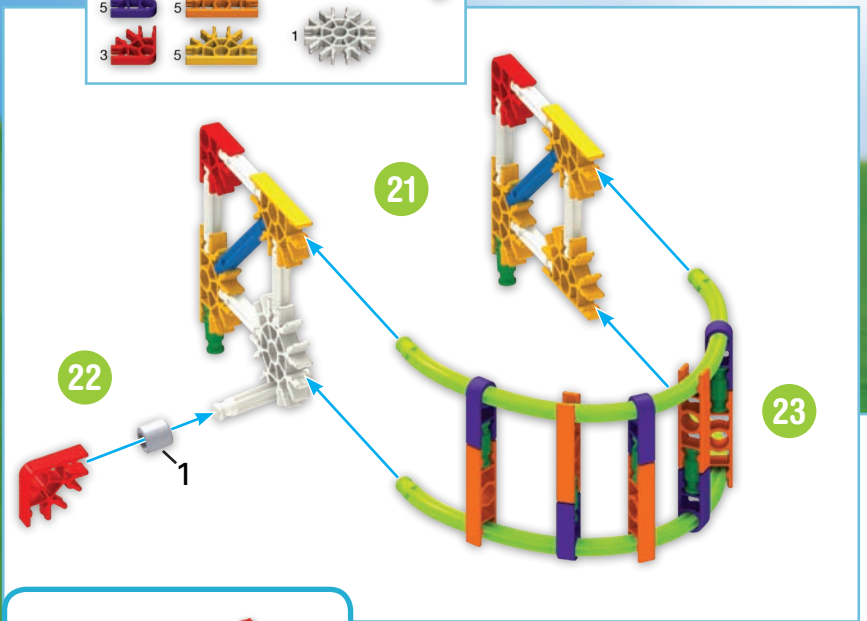

HOLE #7 TROU



1 - 25, 17 - 21

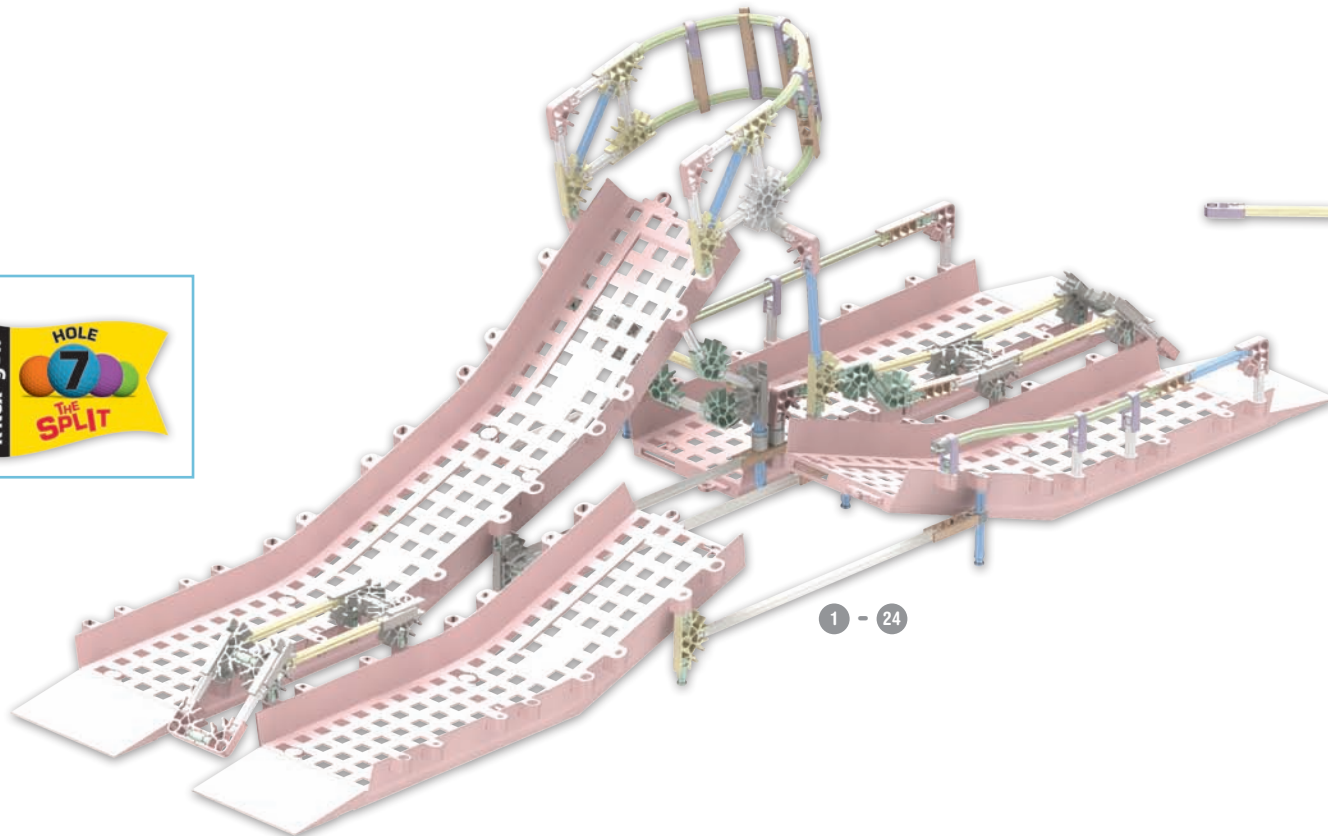

1 - 24

25



17 - 21

HOLE # 8 TROU

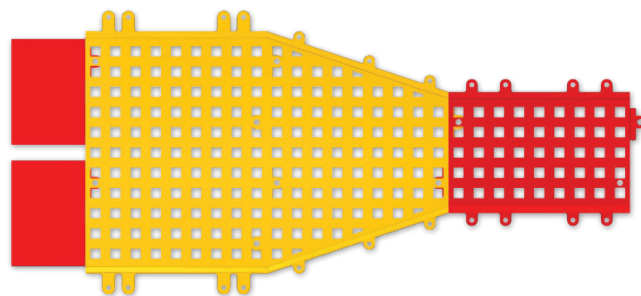

1

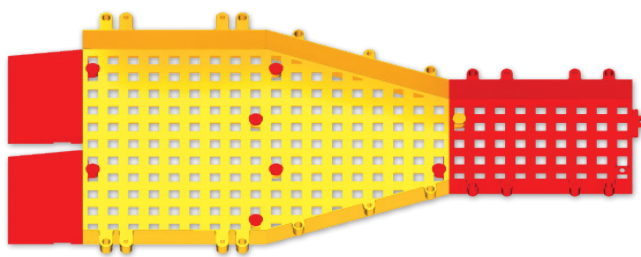
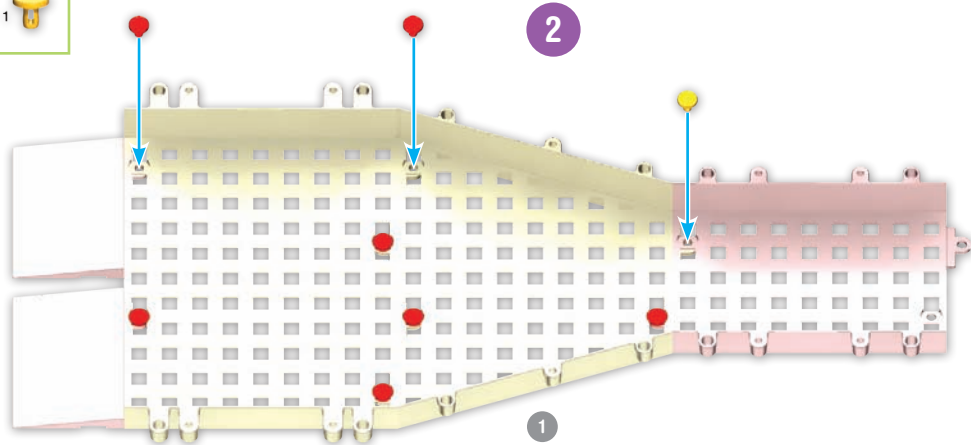
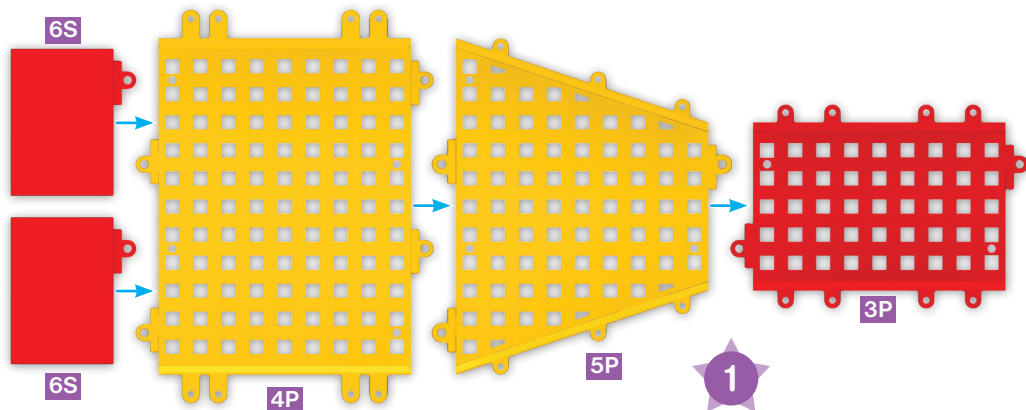

1 - 2

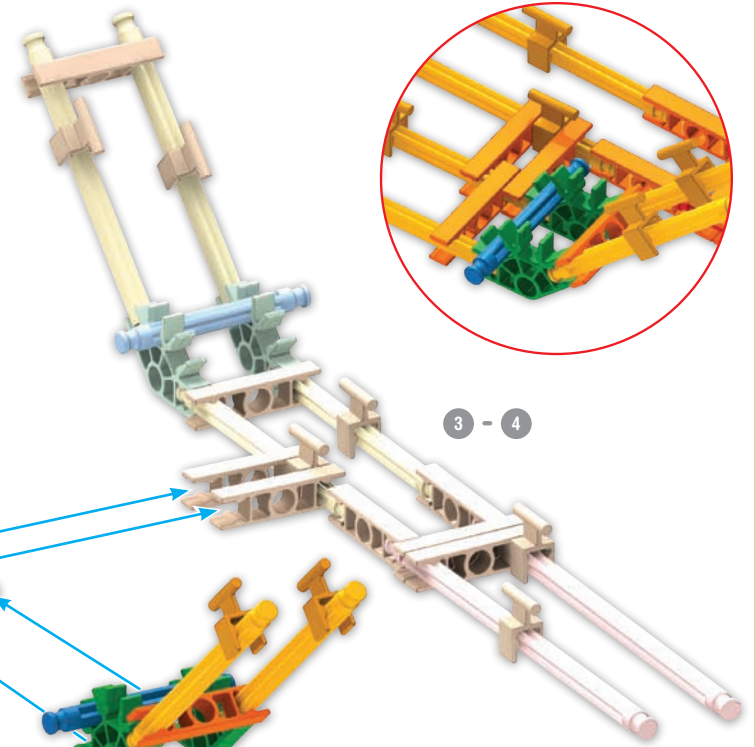
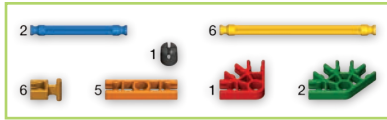

3 - 4

5

6



3 - 4

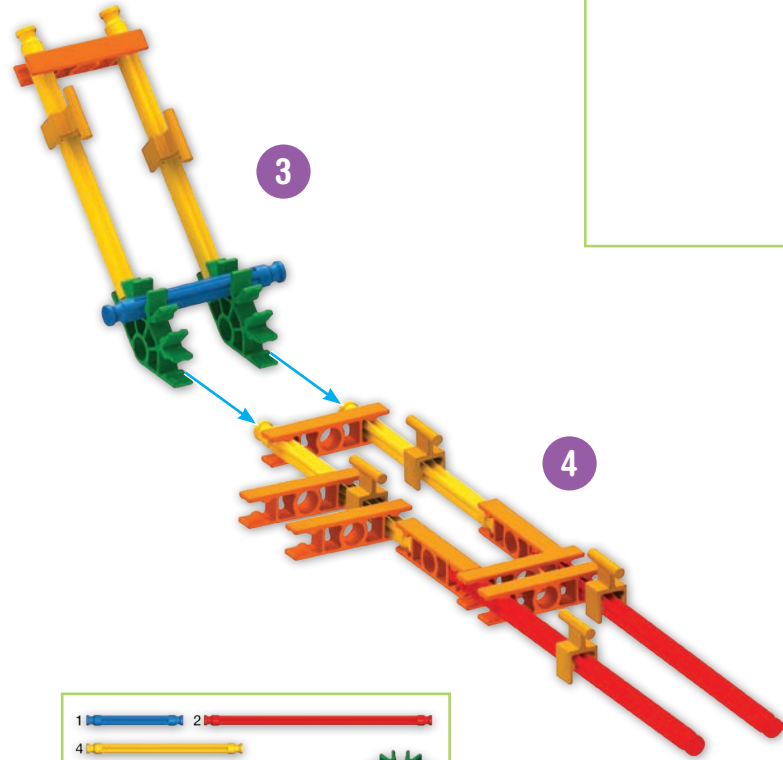

3

4

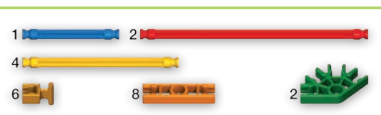

3 - 6

- 4
- 4
- 4
- 2
- 8

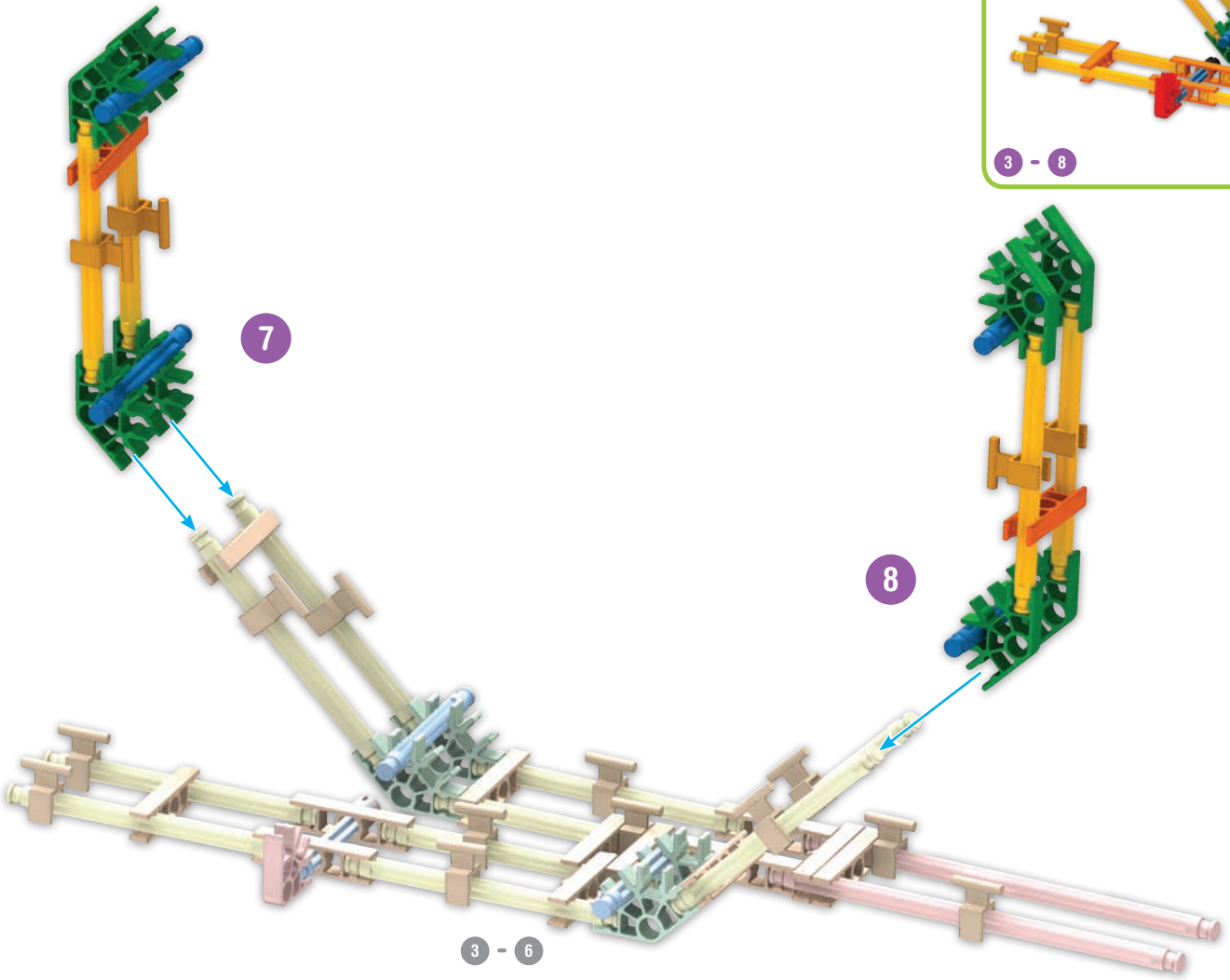

- 2
- 6
- 6
- 3
- 4

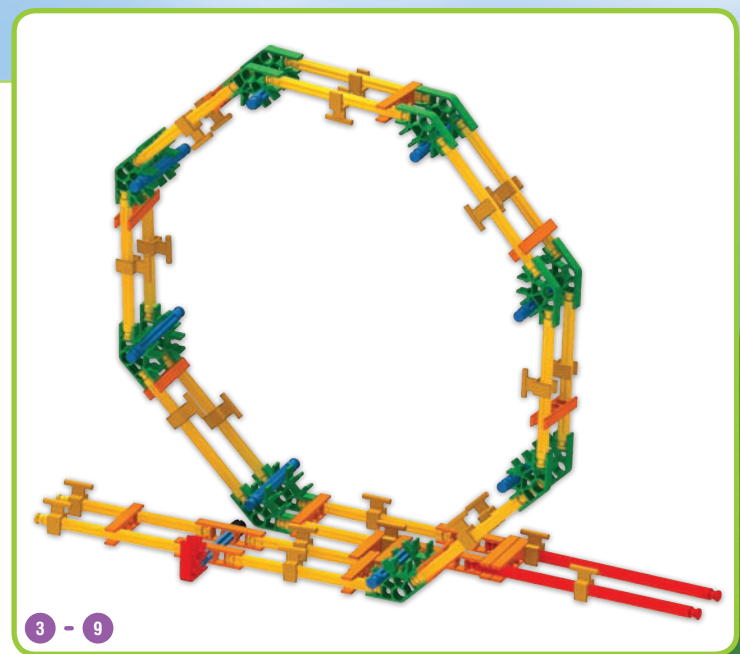
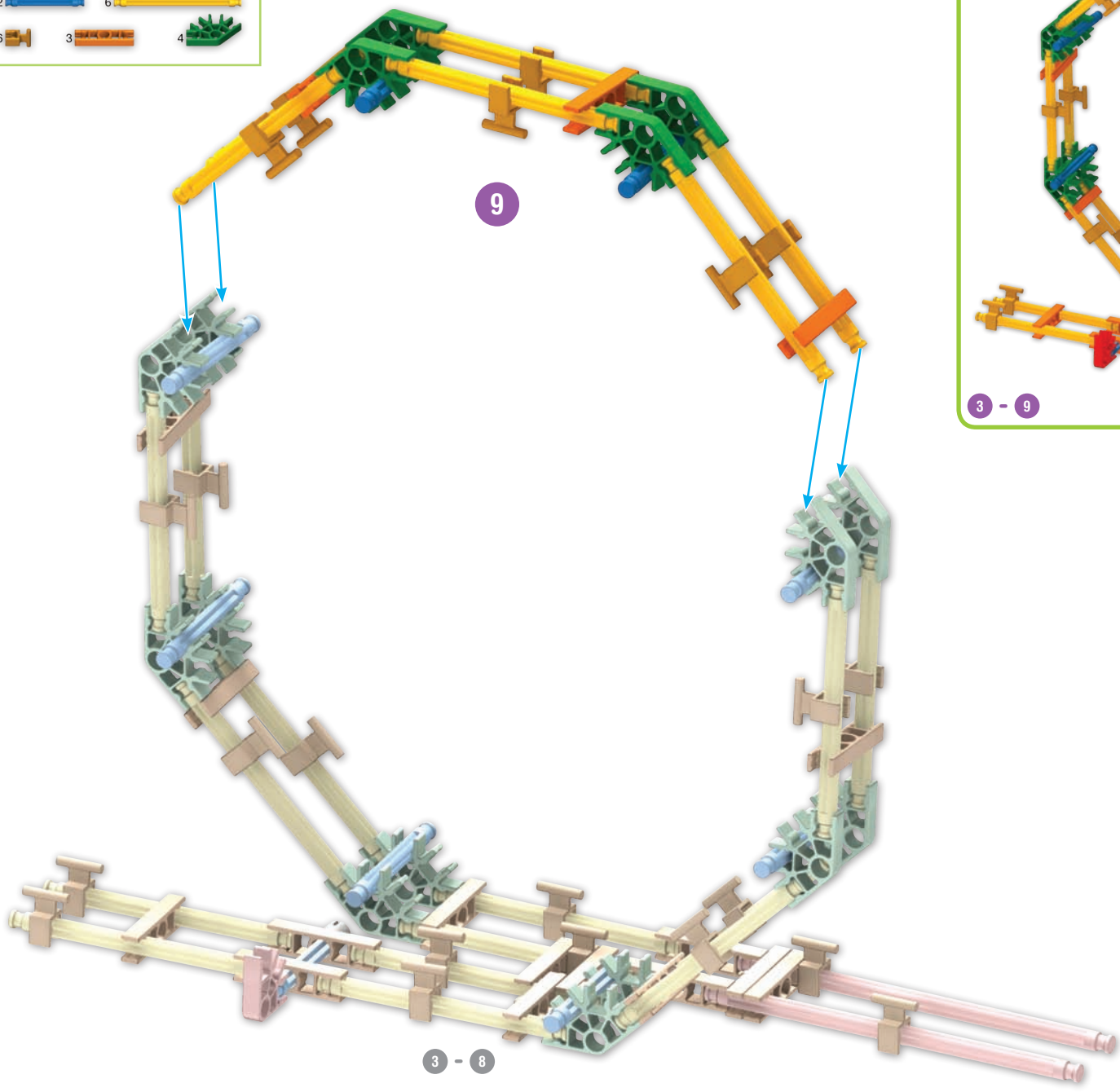

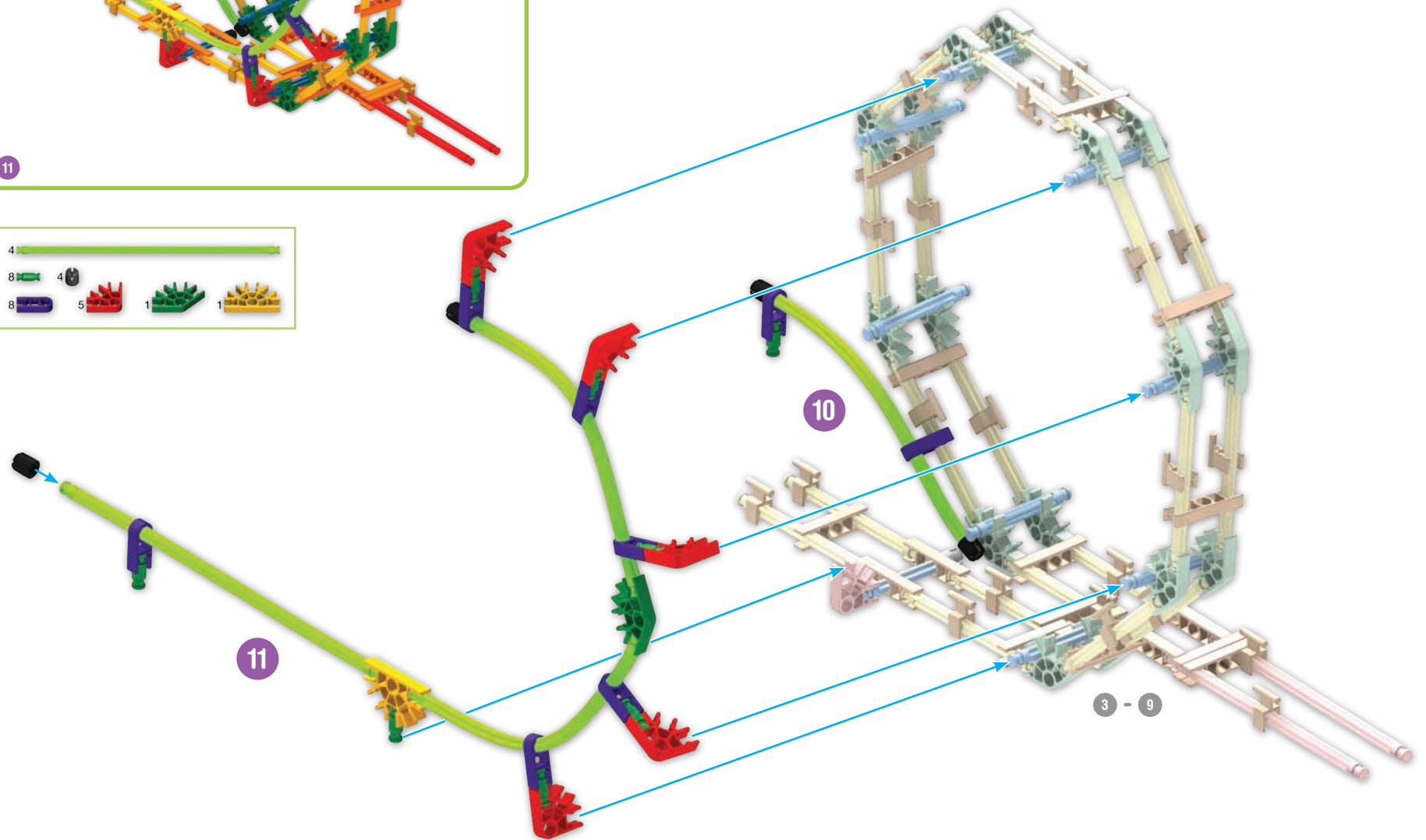
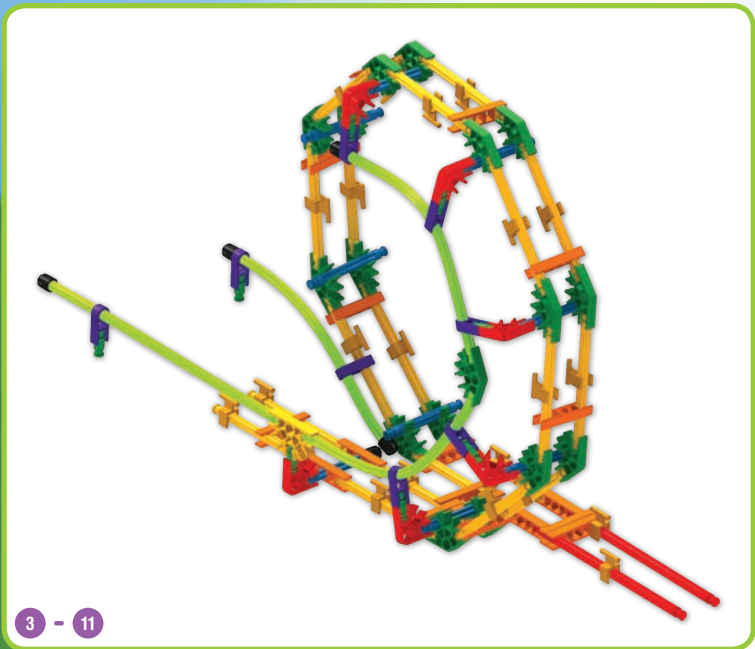



1 - 14

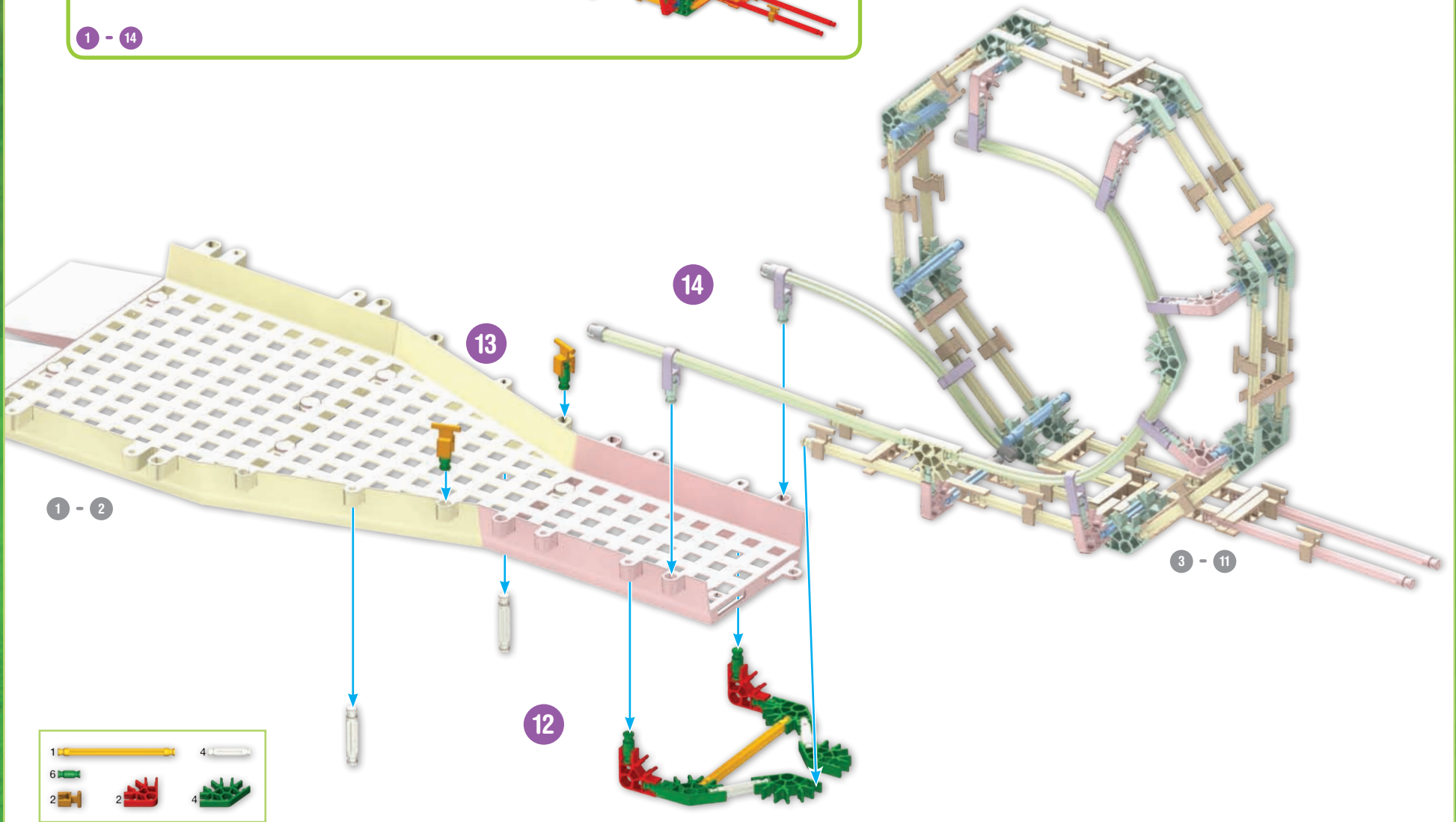

1 - 2

13

14

3 - 11

12

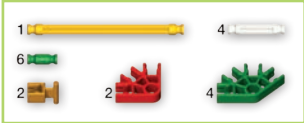

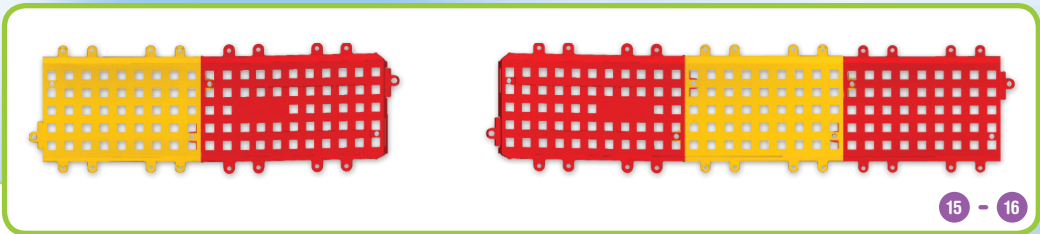

15 - 16

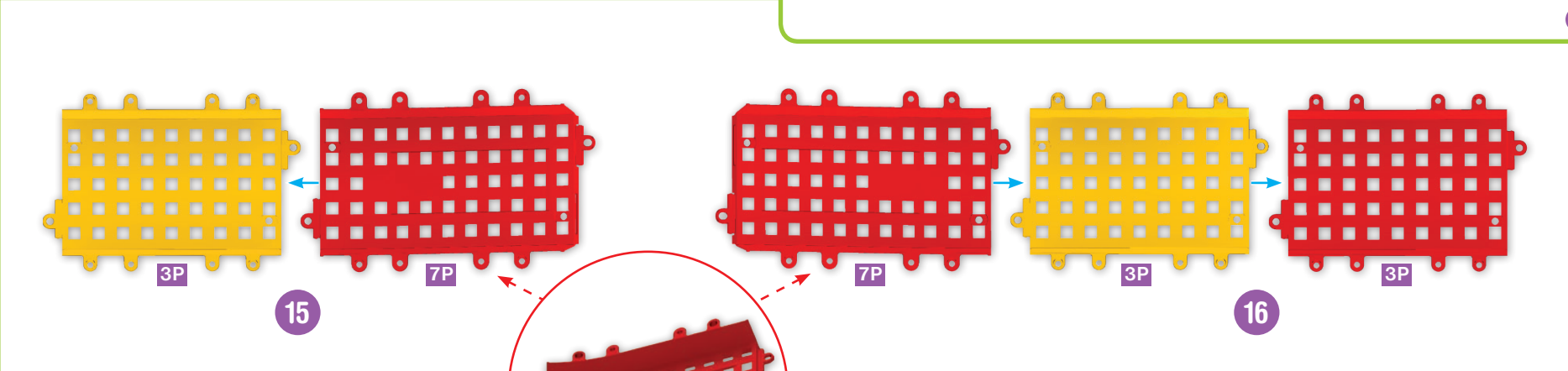

15

3P

7P

7P

3P

16

3P

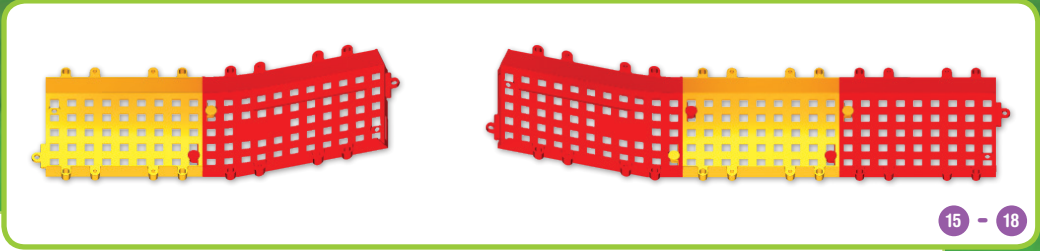

15 - 18

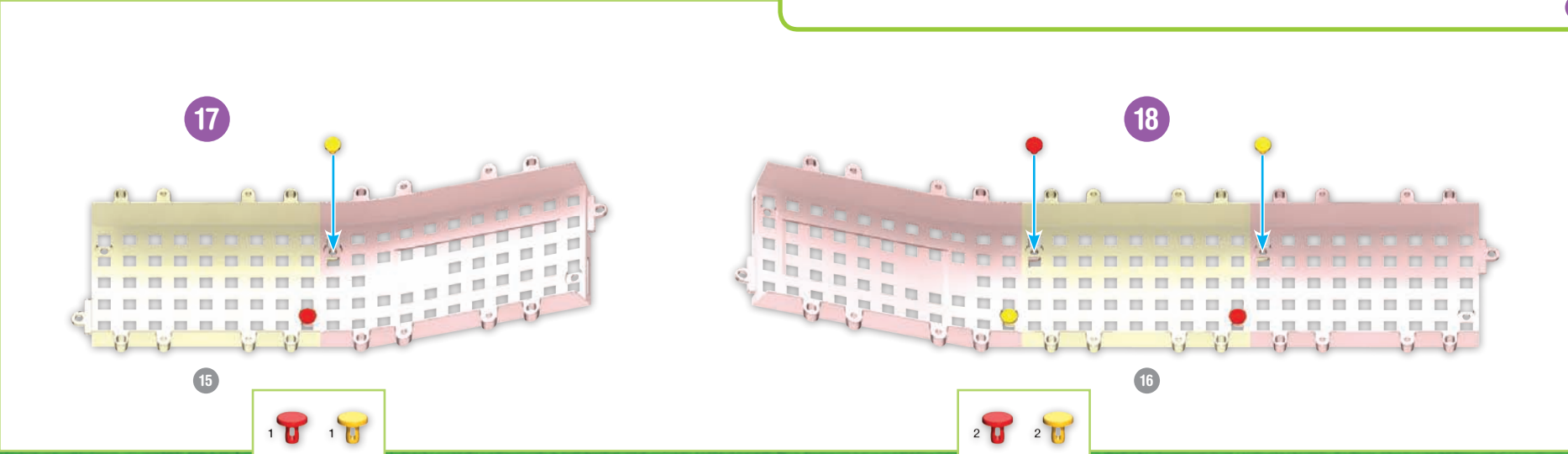

17

15

1

1

18

16

2

2

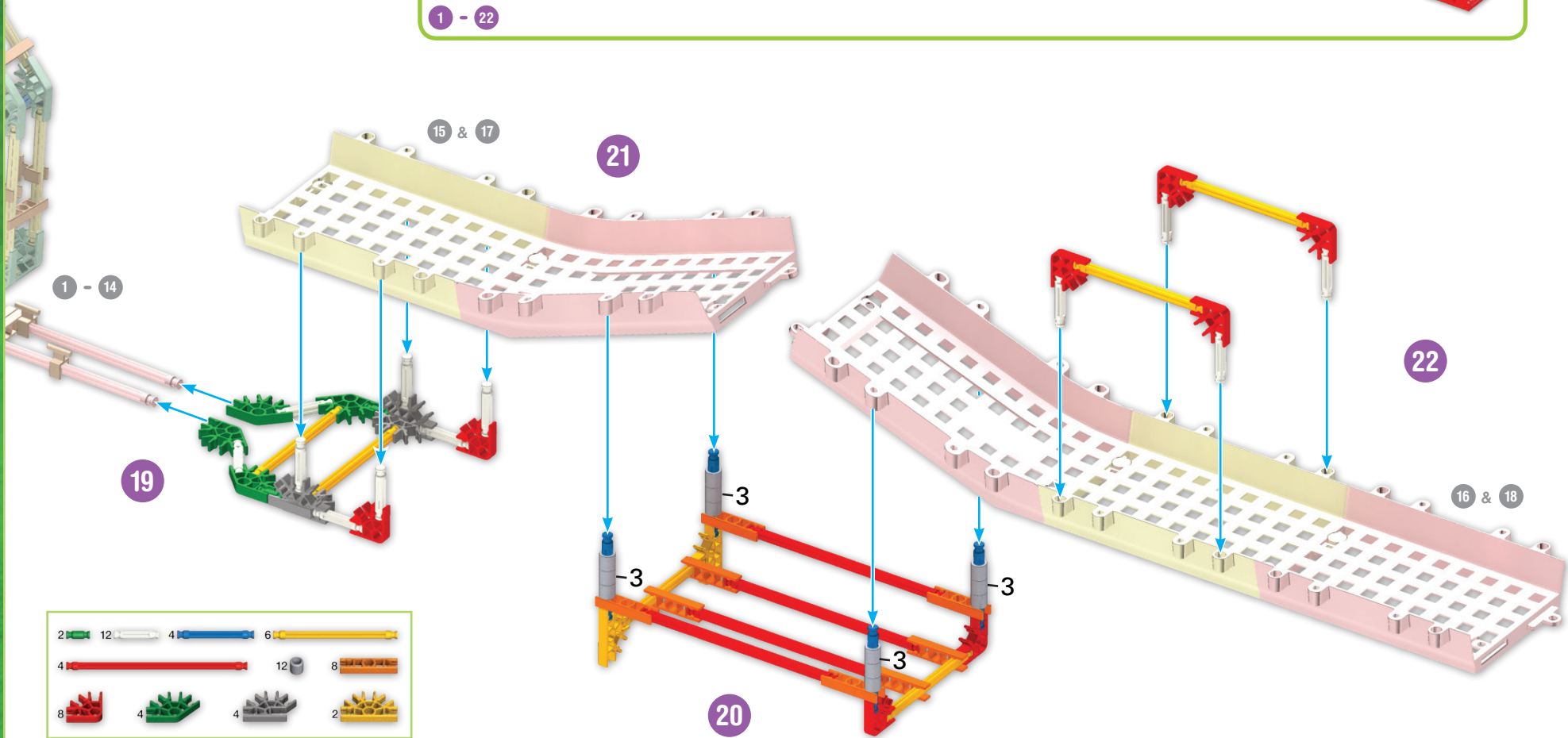



1 - 25

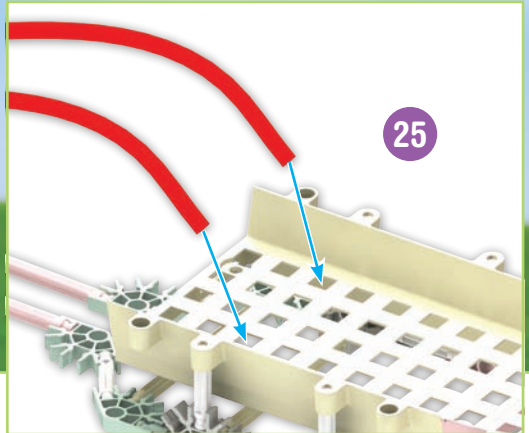

25

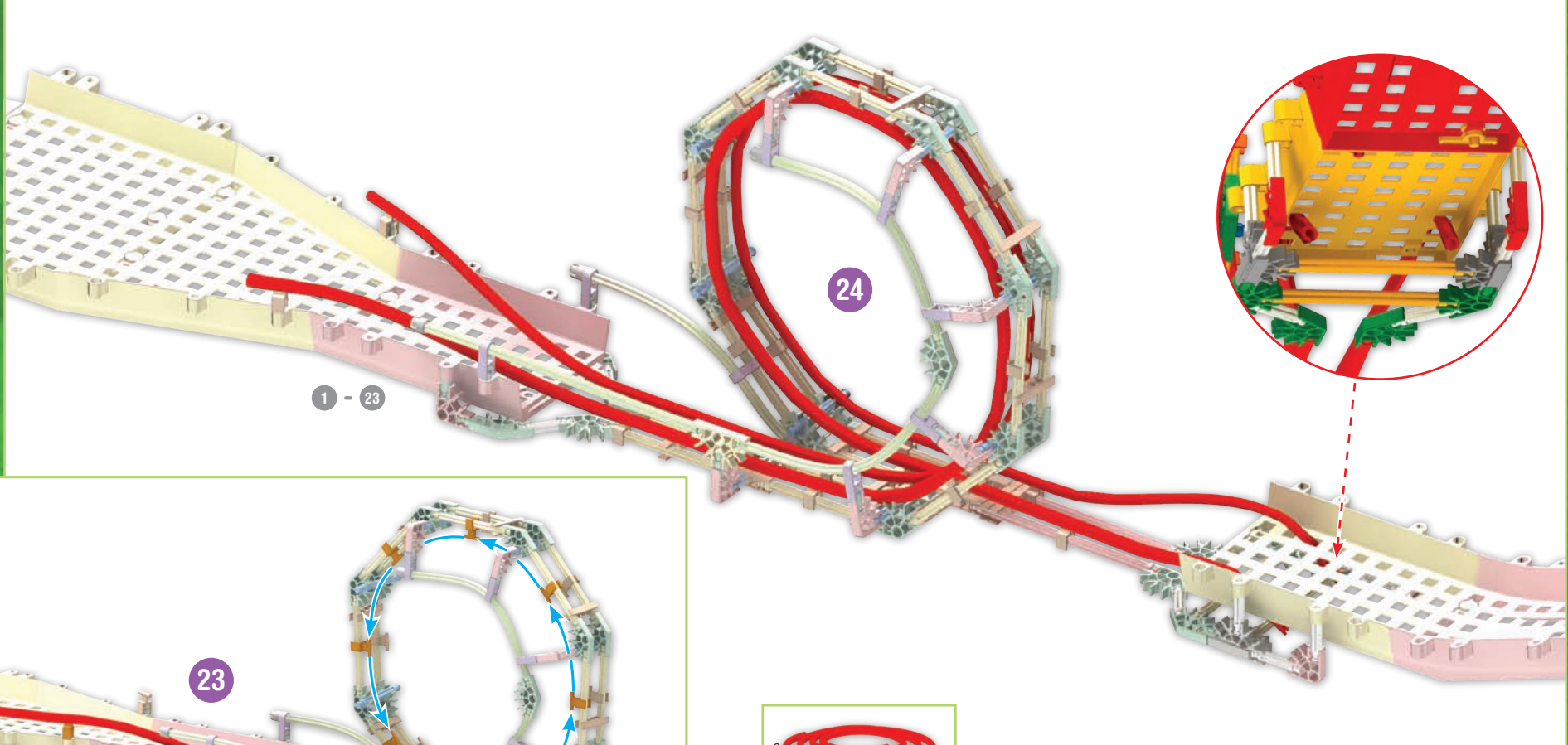

24

1 - 23

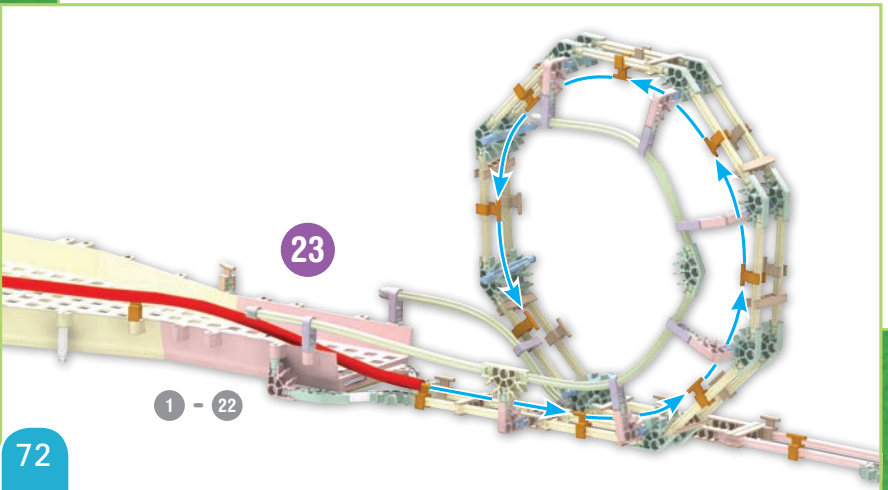

23

1 - 22



2

HOLE #8 TROU



1 - 28, 15 - 25

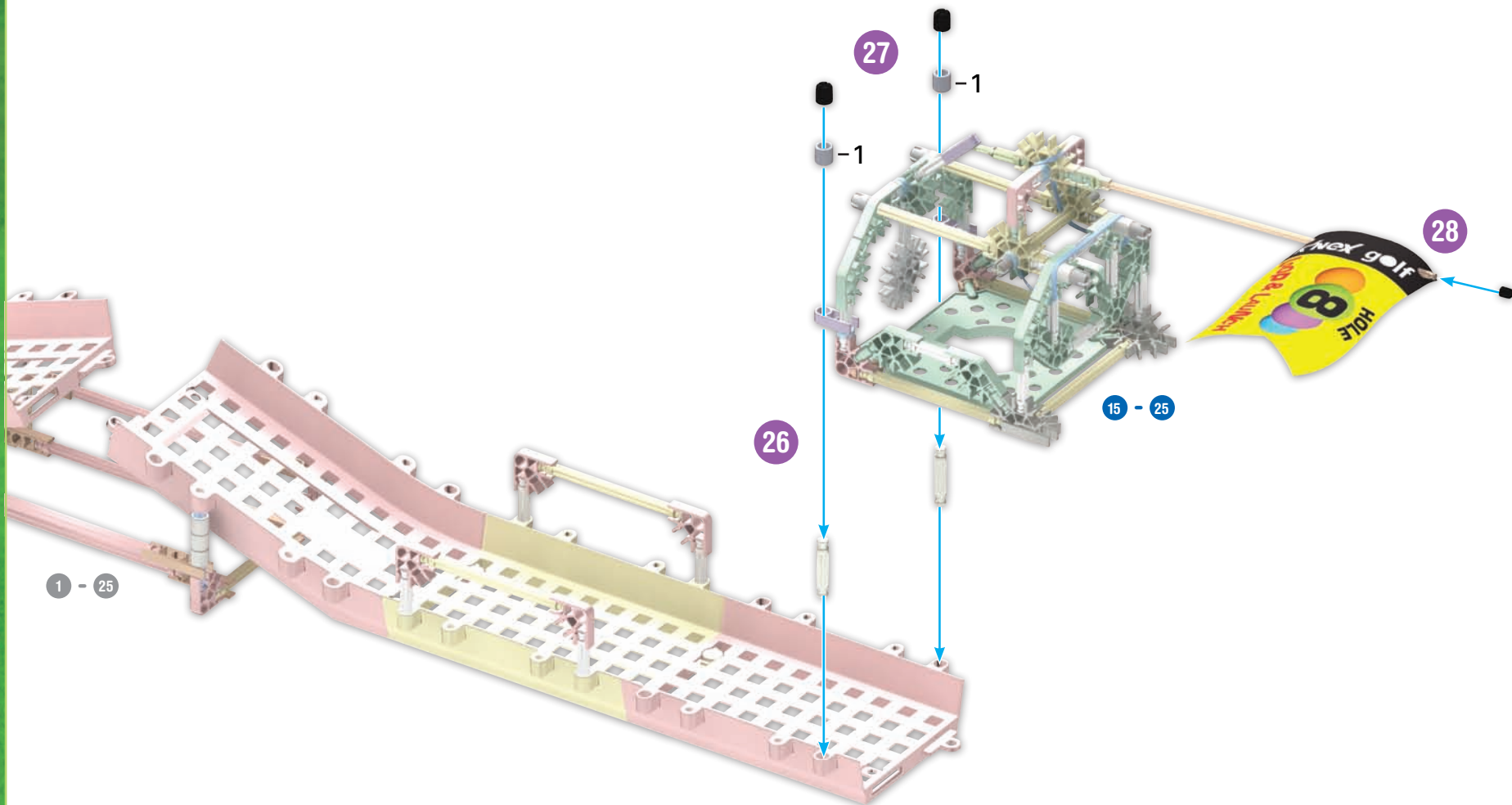

HOLE #9
TROU

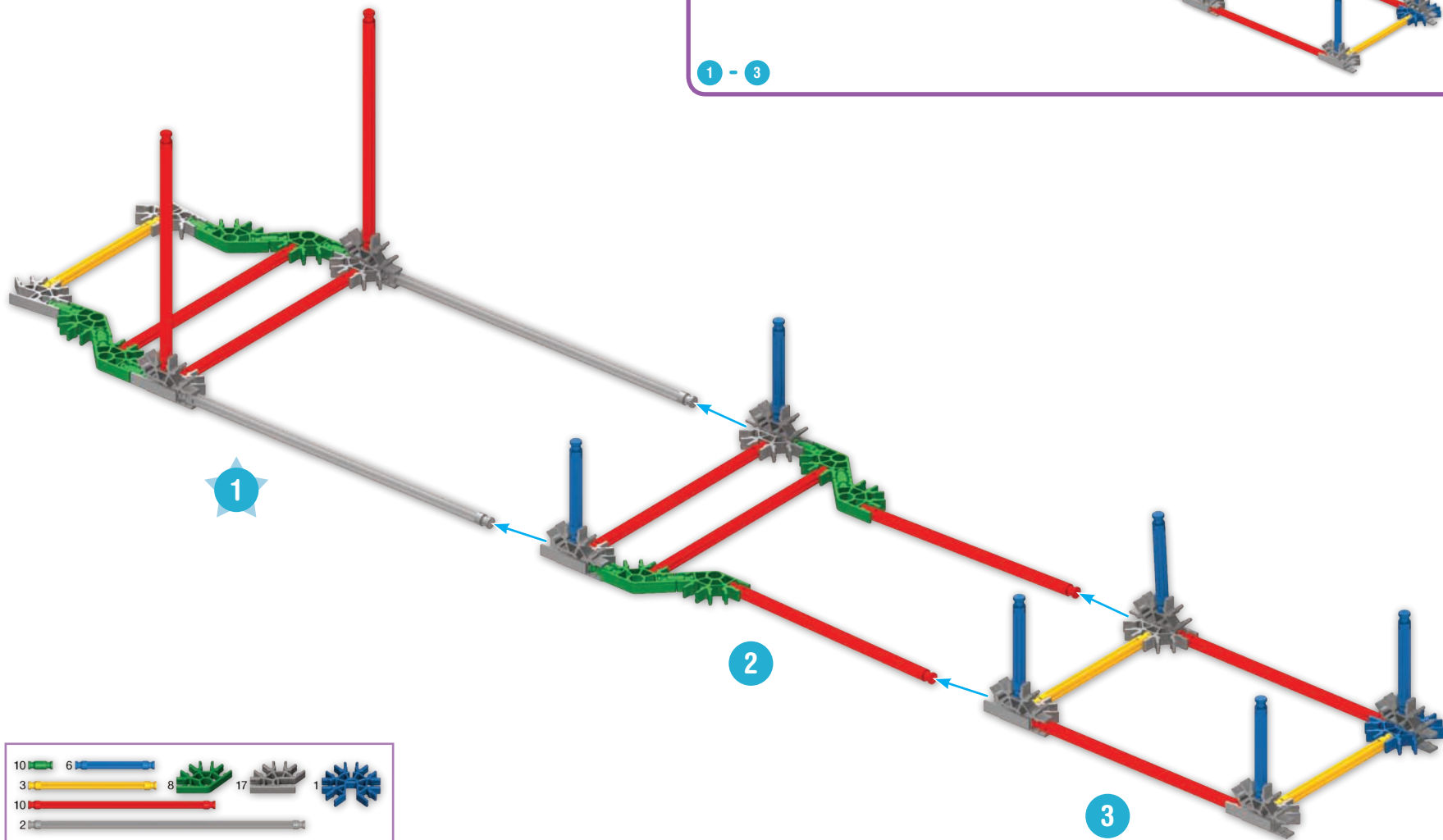
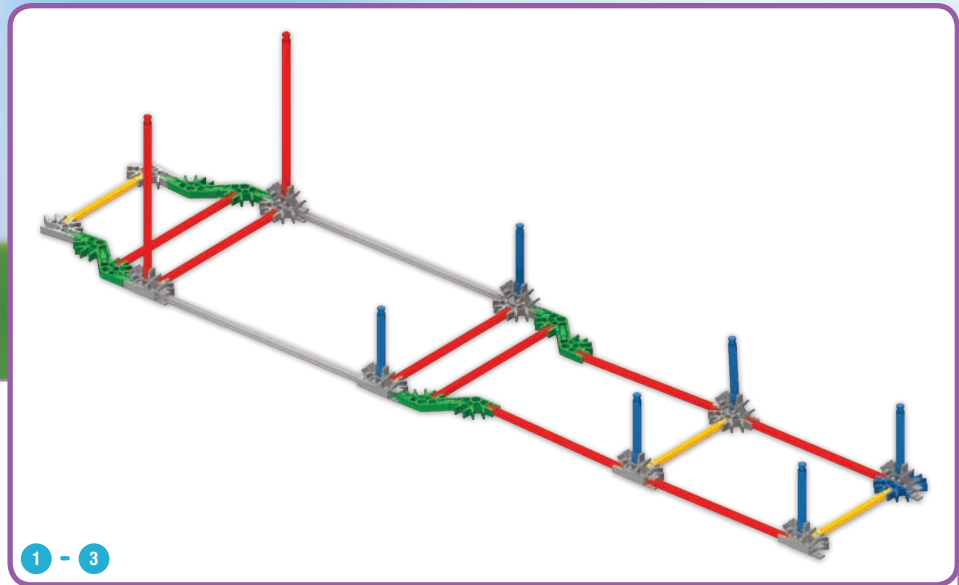
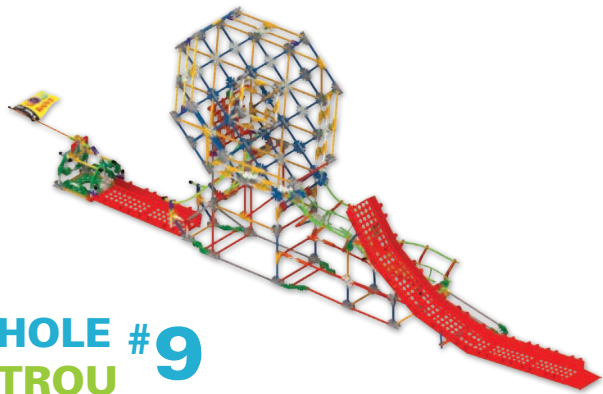

- | | | | |
|----|---|----|---|
| 10 | 6 | 17 | 1 |
| 3 | 8 | | |
| 10 | | | |
| 2 | | | |

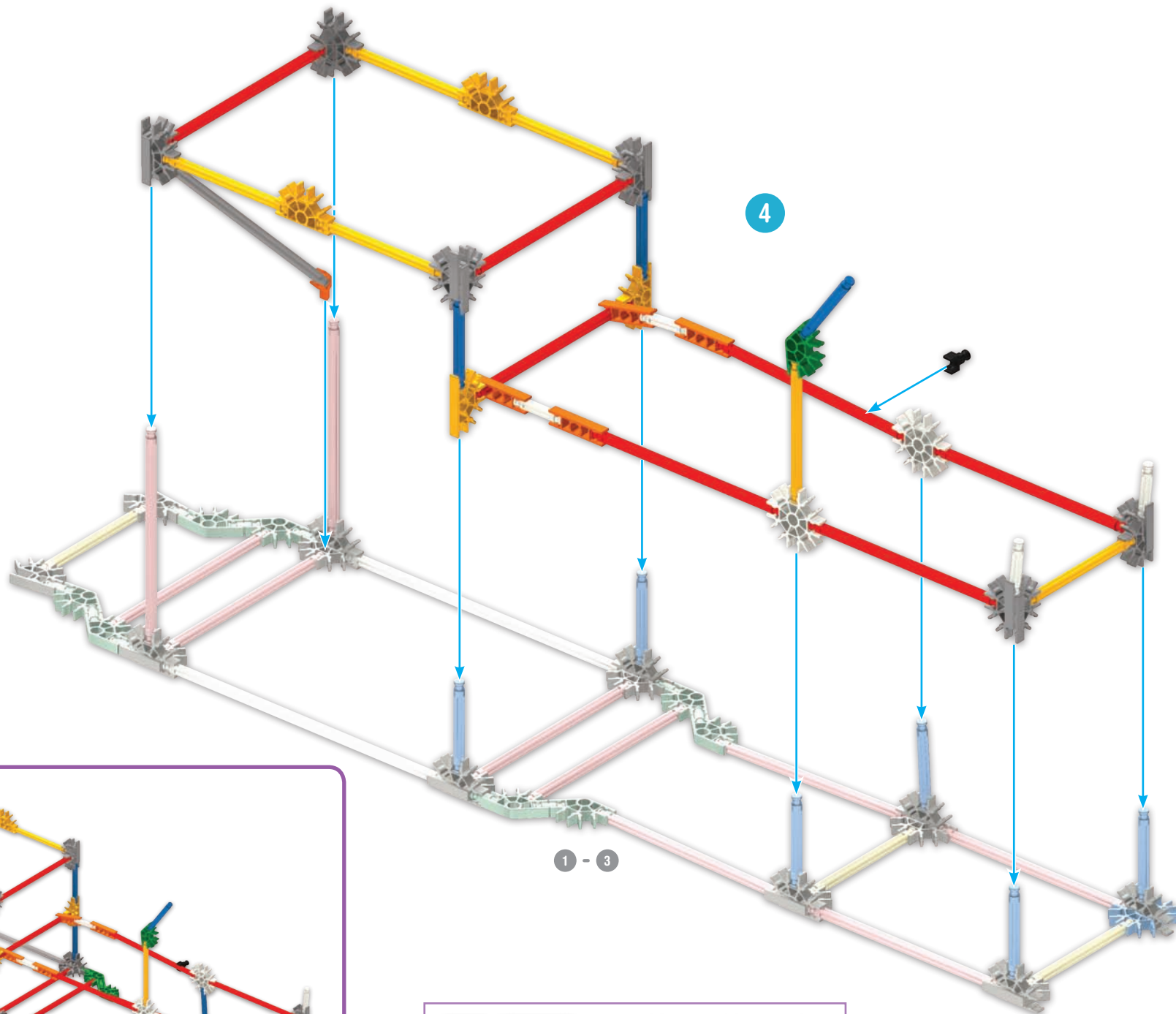

1 - 3

4

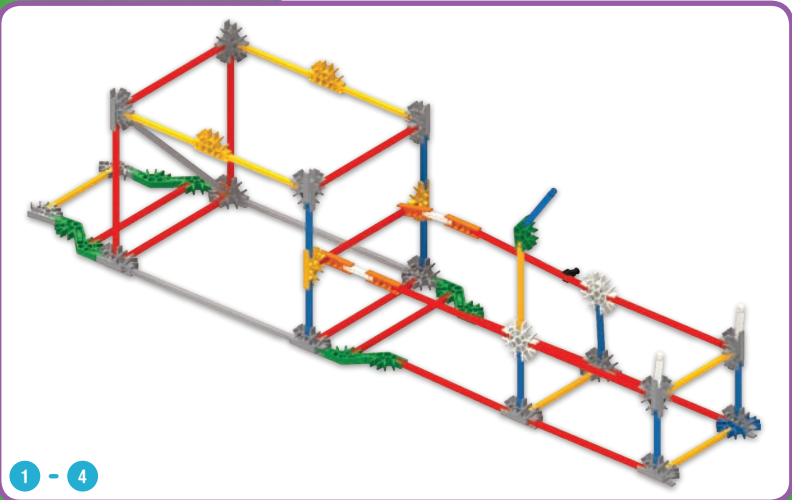

1 - 4

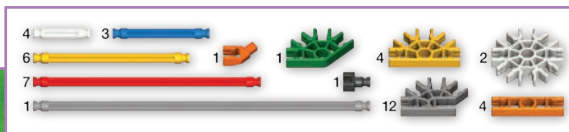

- 2
- 2
- 2
- 2
- 4
- 2
- 2
- 2
- 2

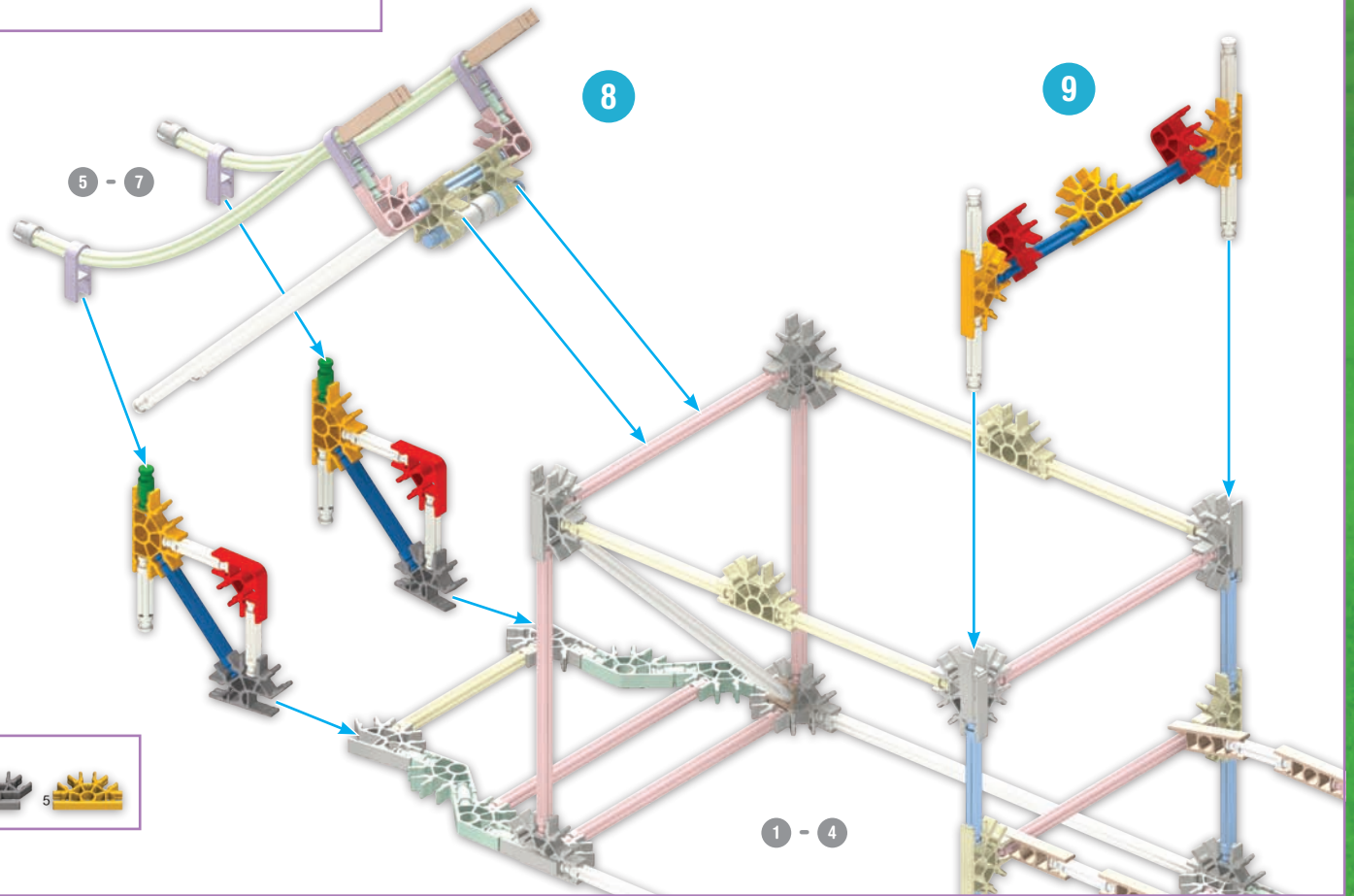
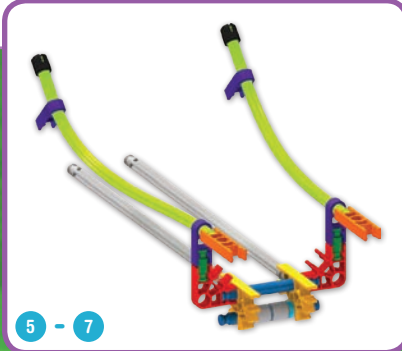
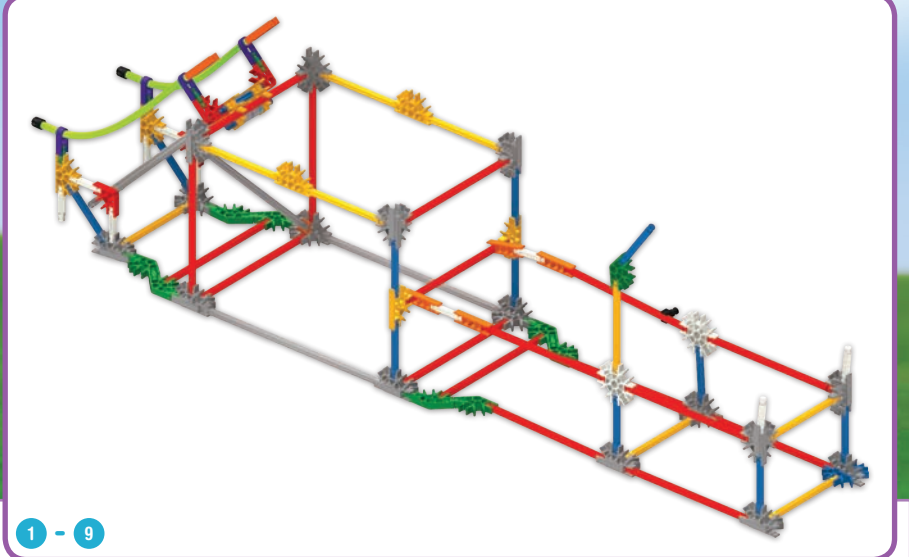
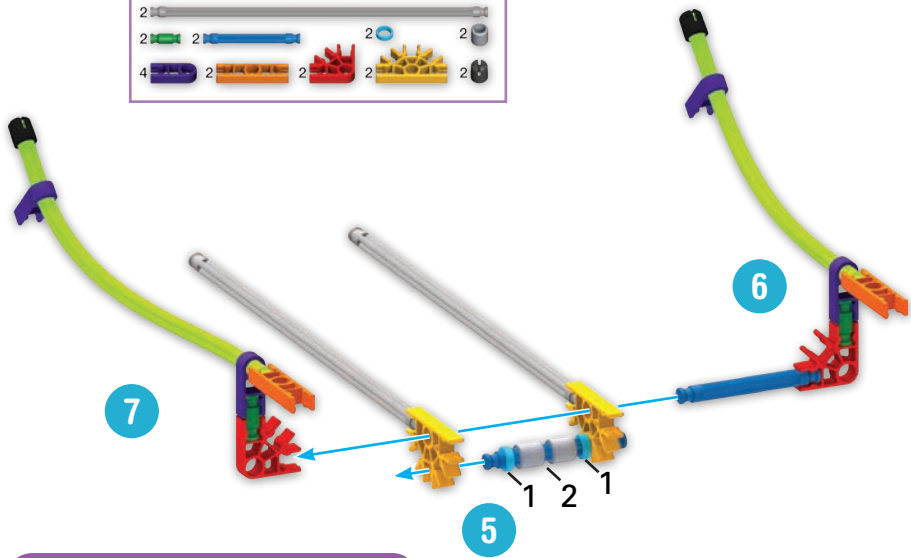

- 2
- 10
- 4
- 4
- 2
- 5

- 2
- 2
- 1
- 1
- 2
- 2
- 2
- 2
- 2

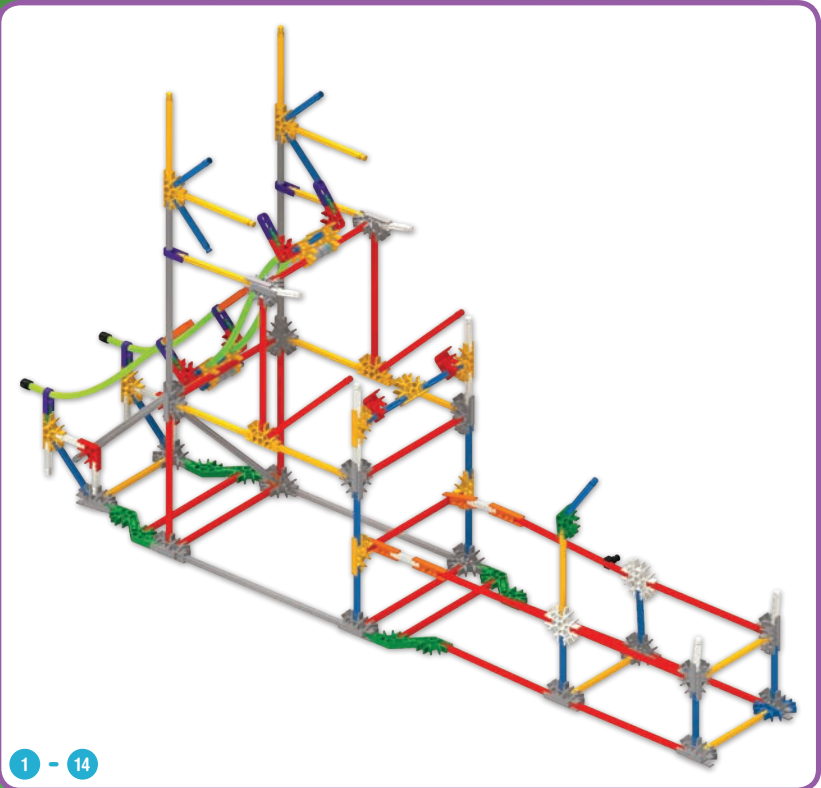
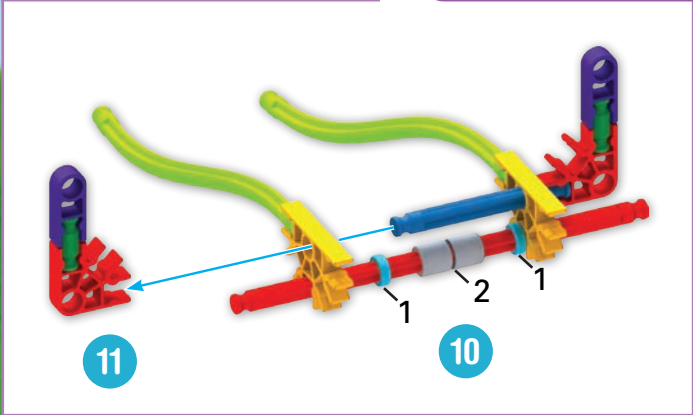

- 2
- 4
- 6
- 4
- 2
- 2

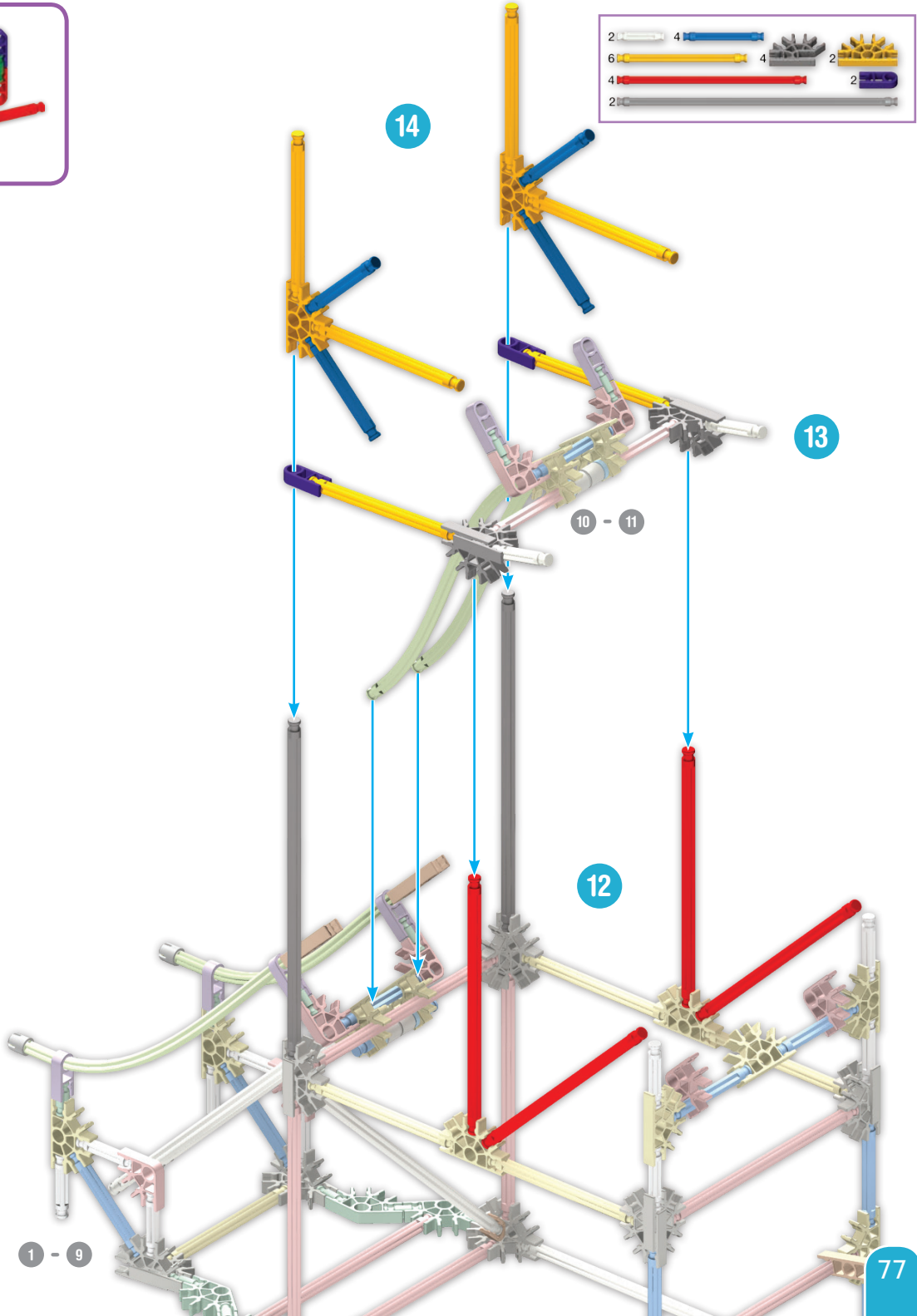



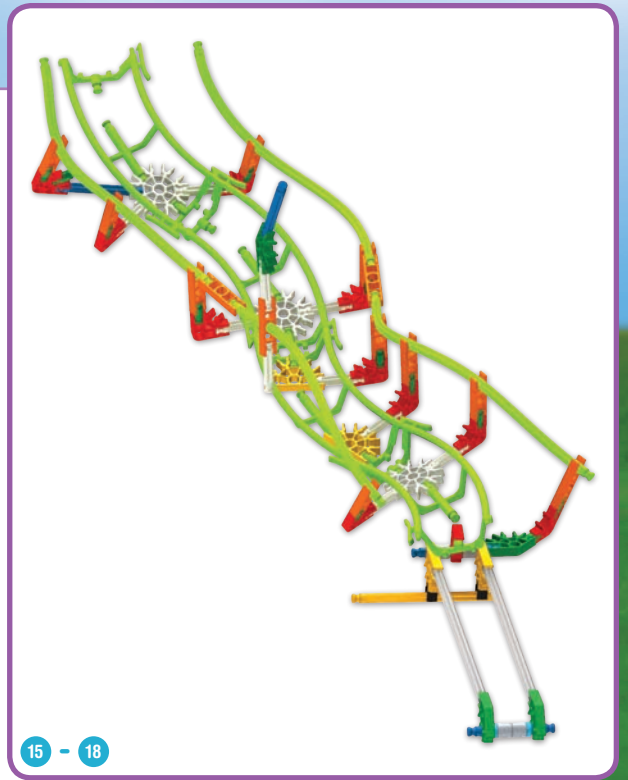
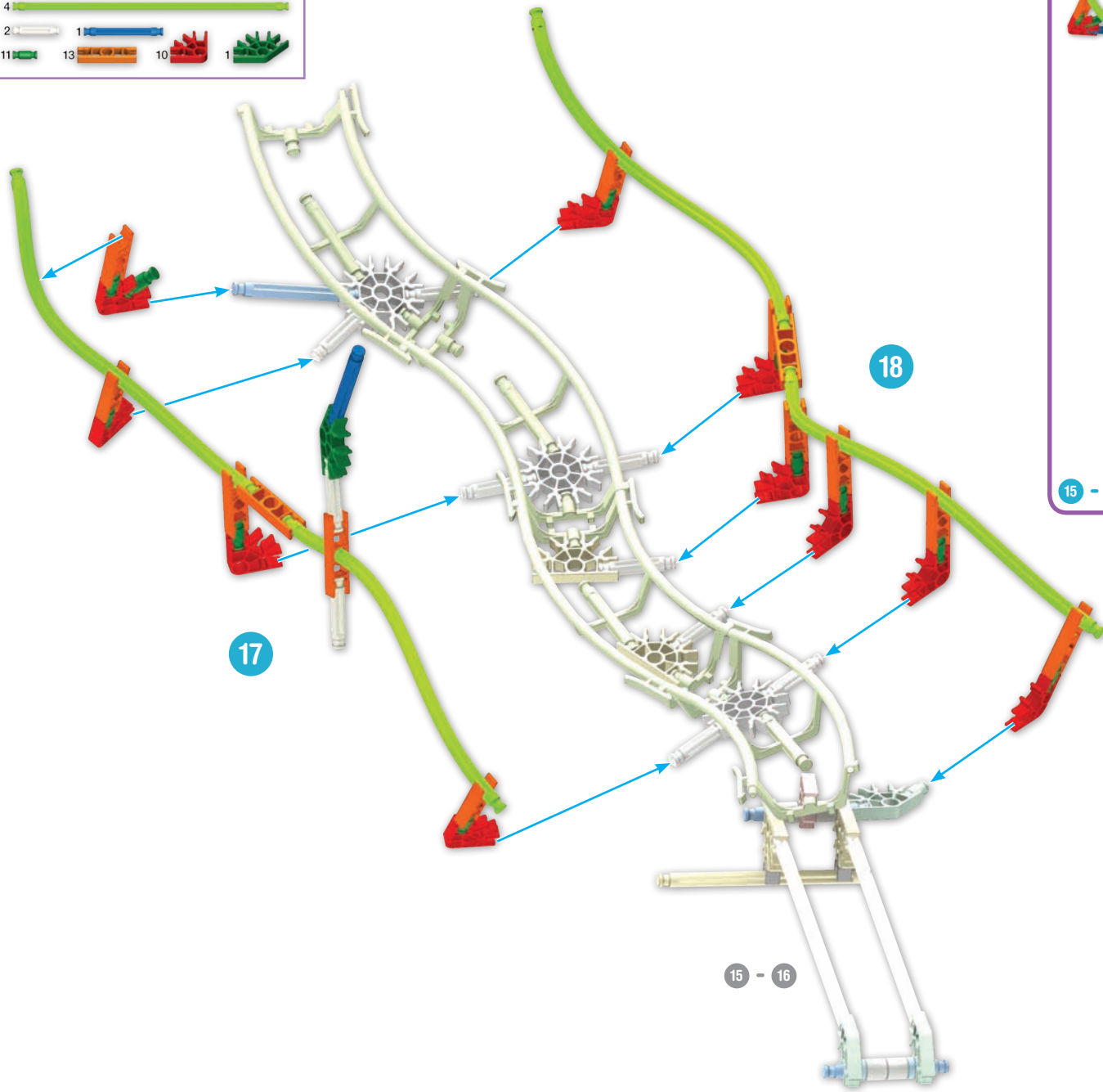
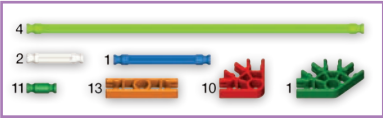

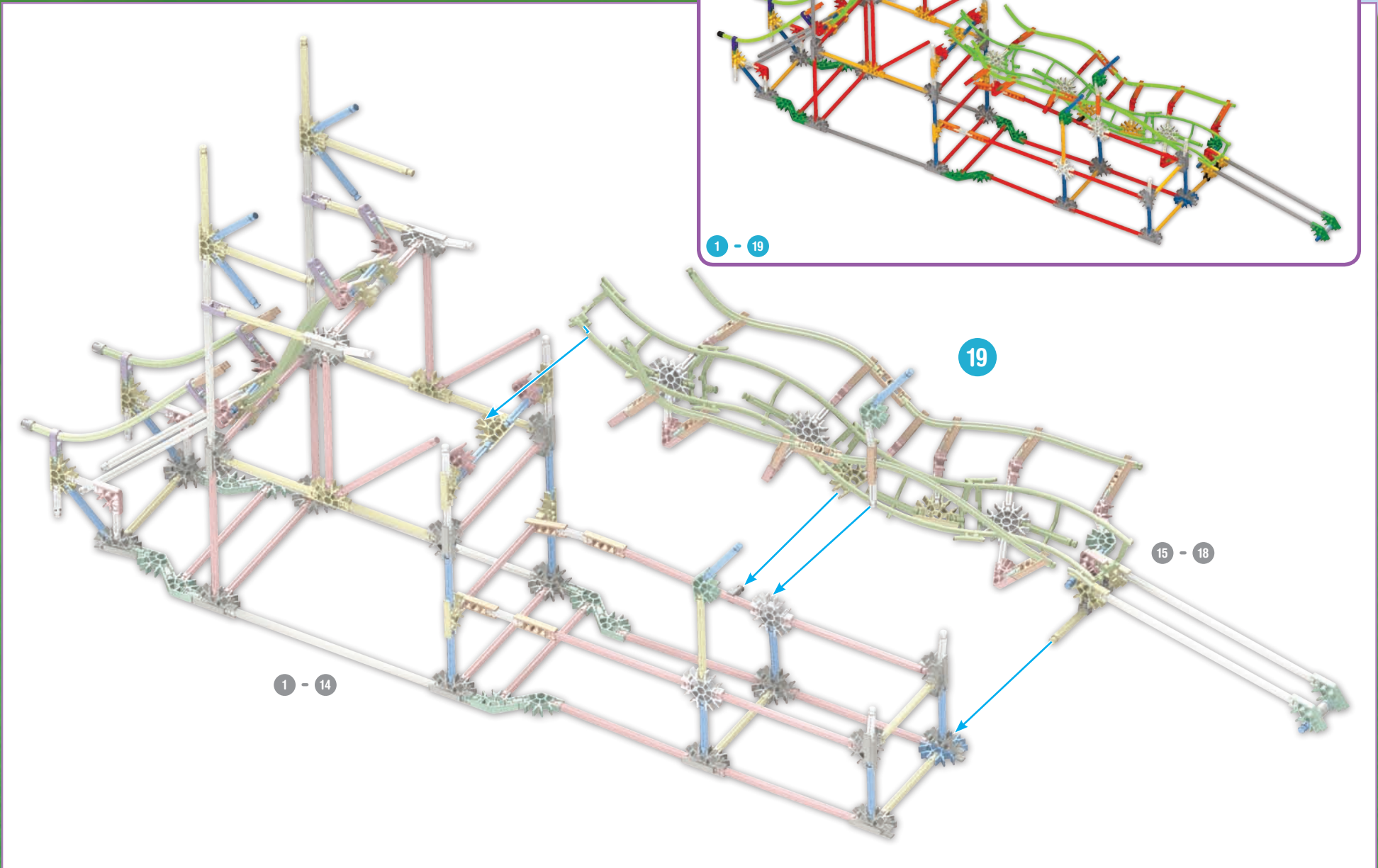

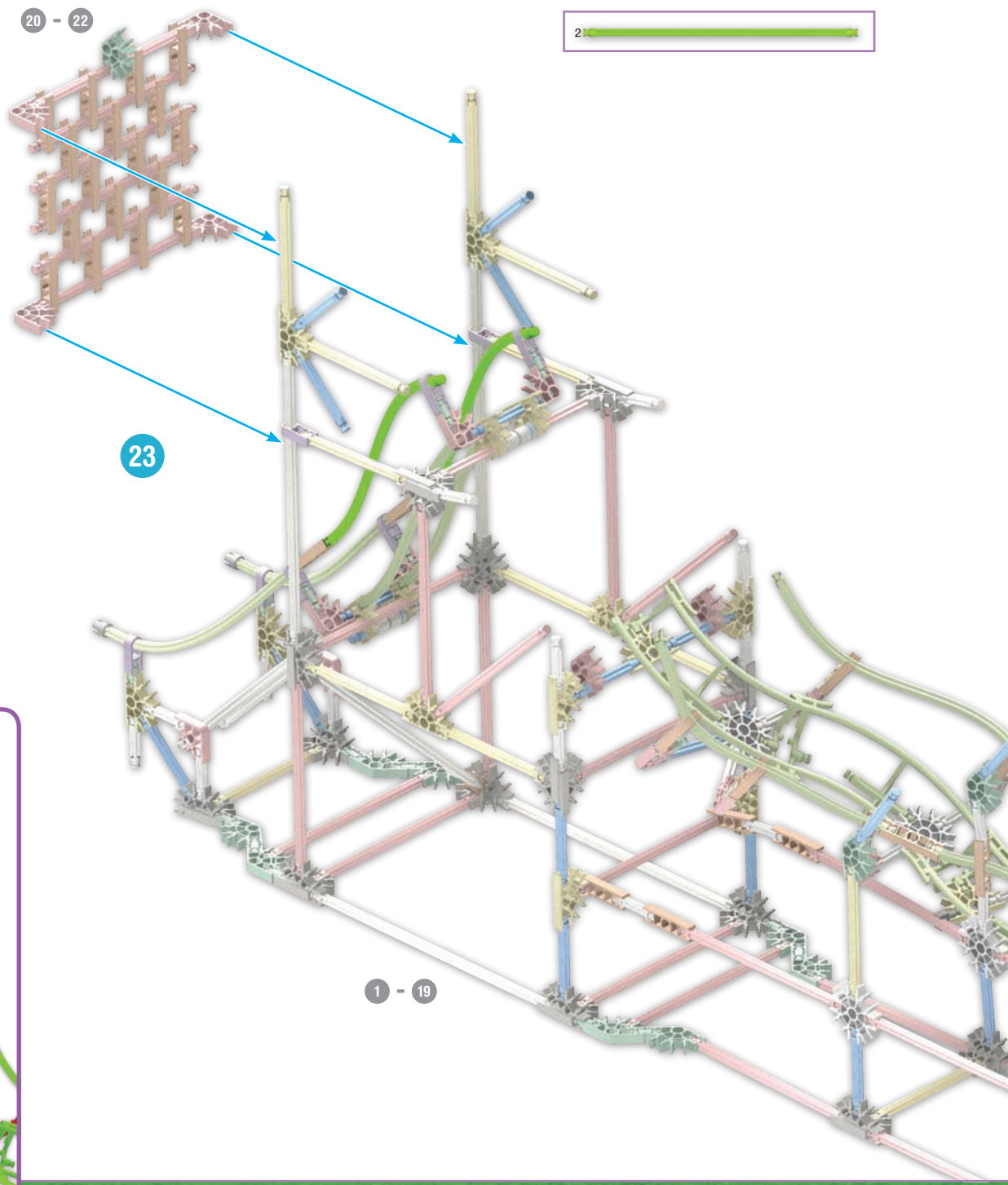
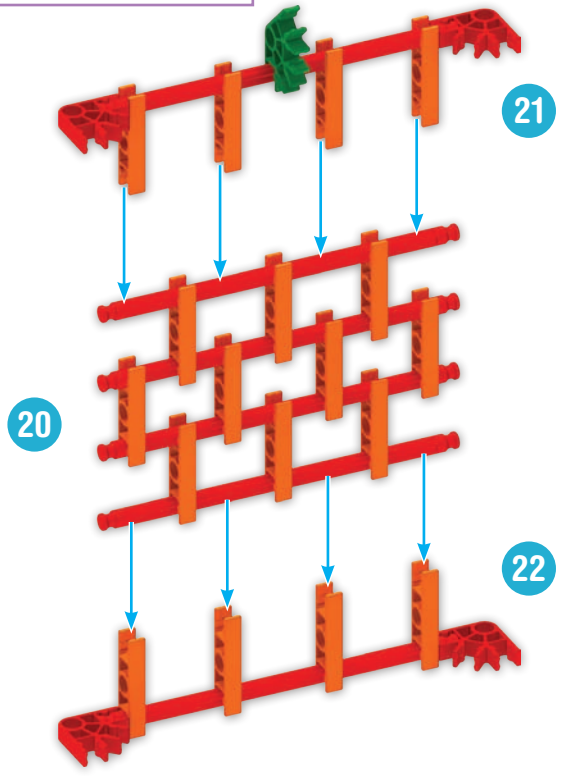

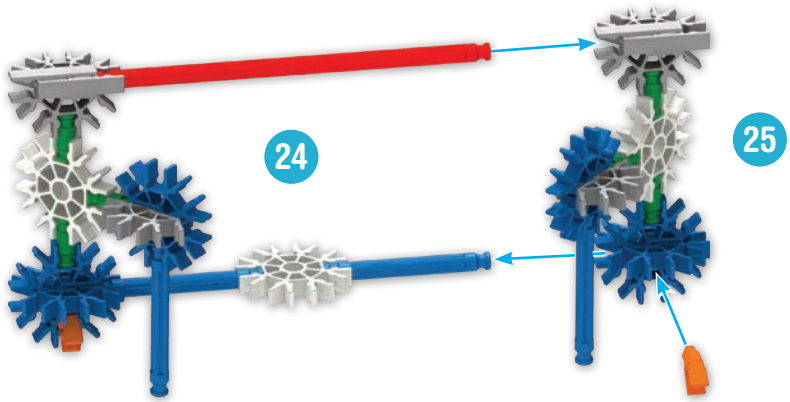

24

25

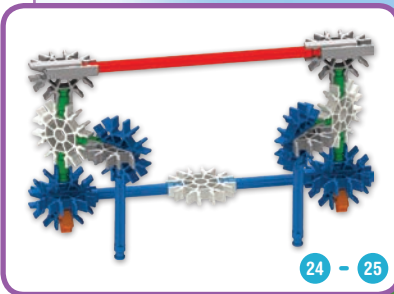

24 - 25

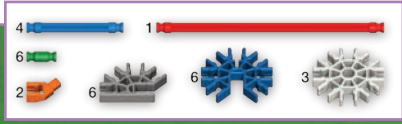

1 - 26

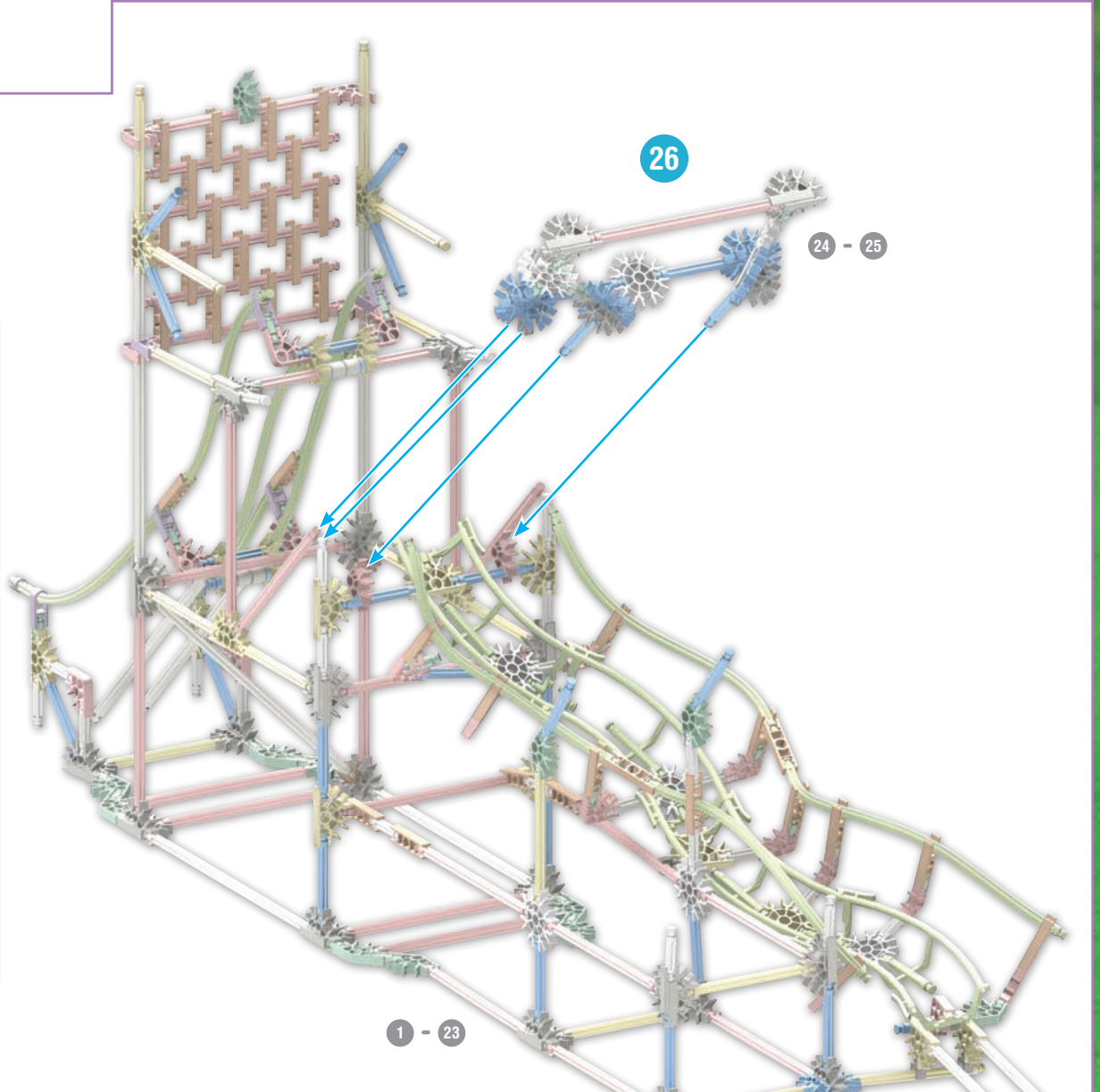

26

24 - 25

1 - 23

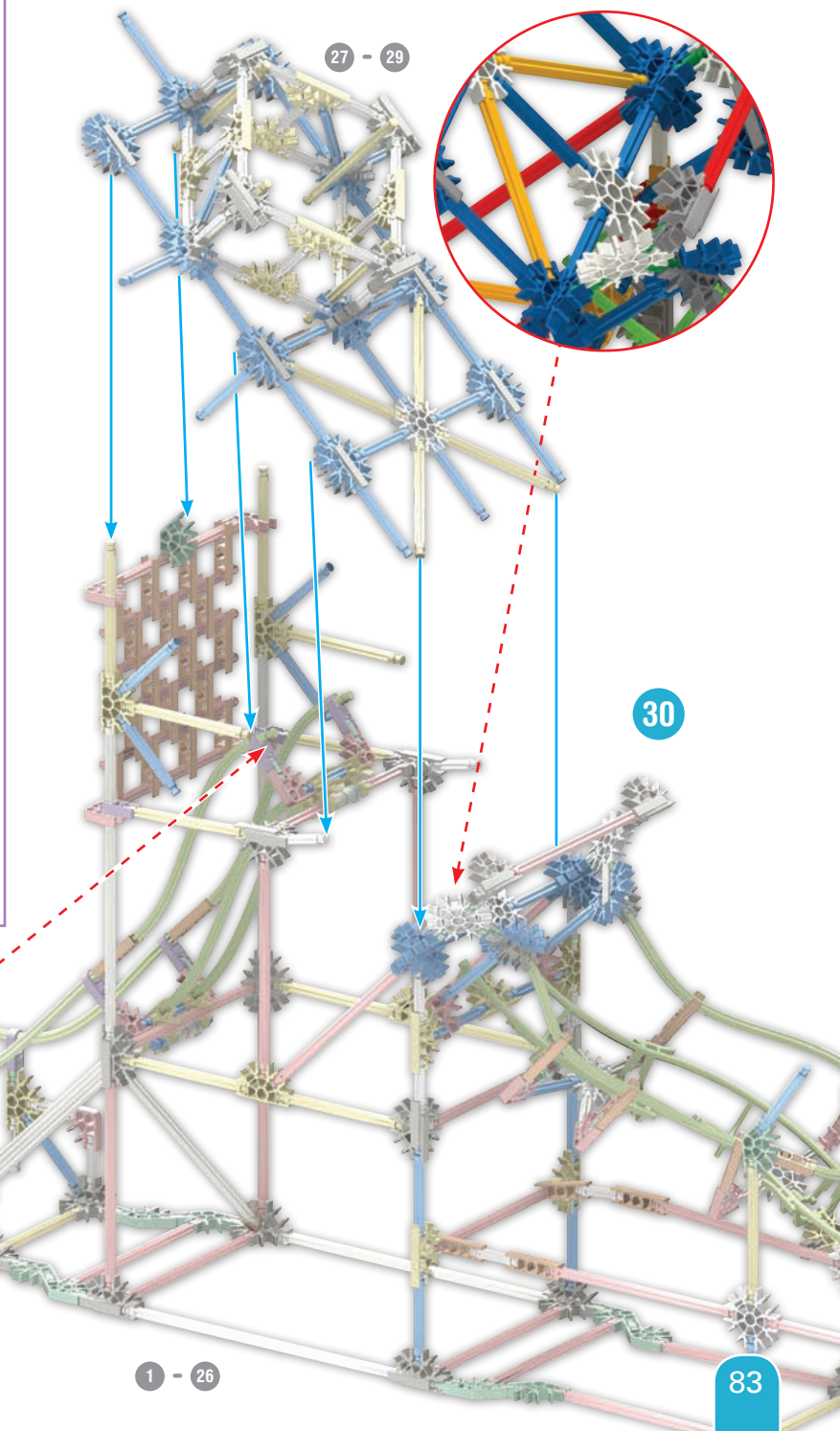
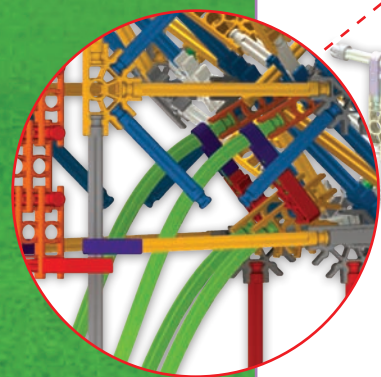
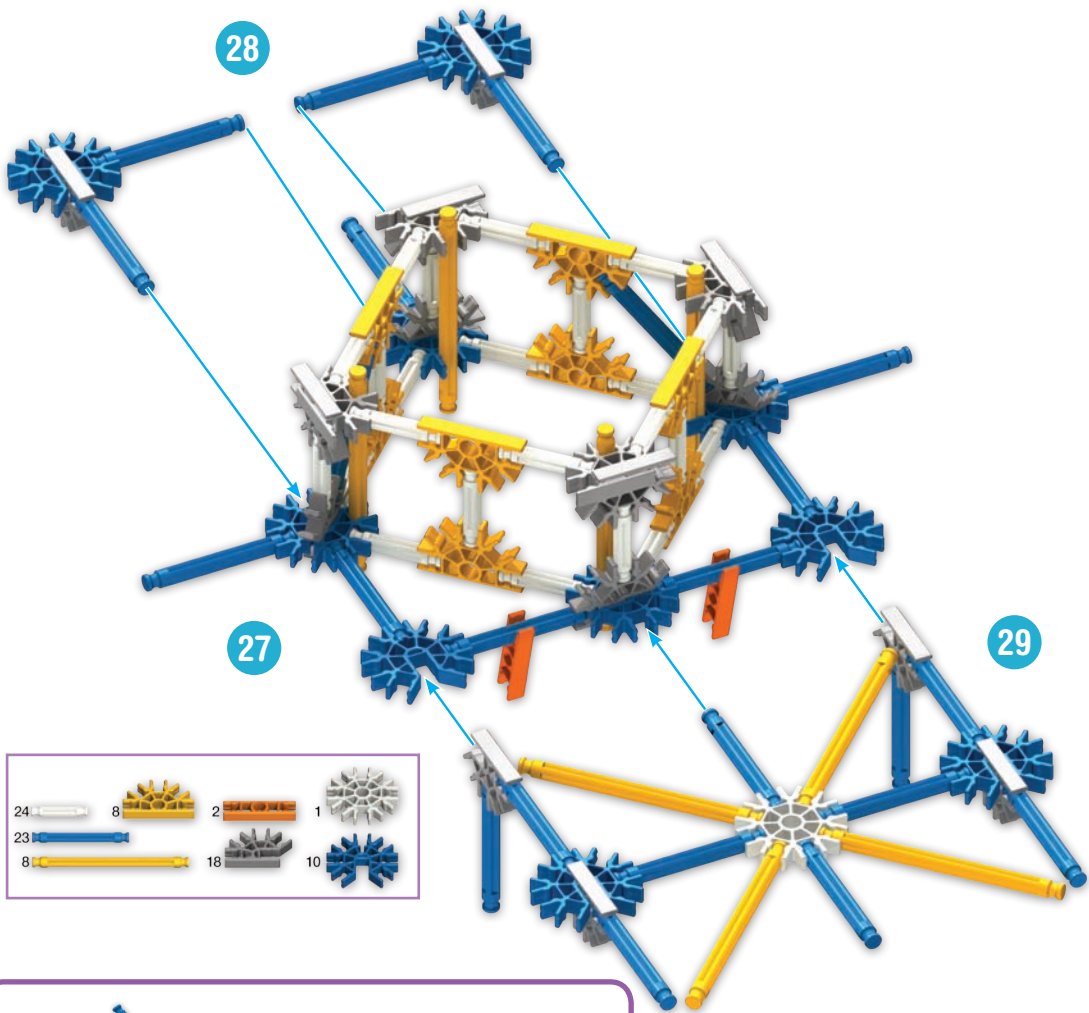

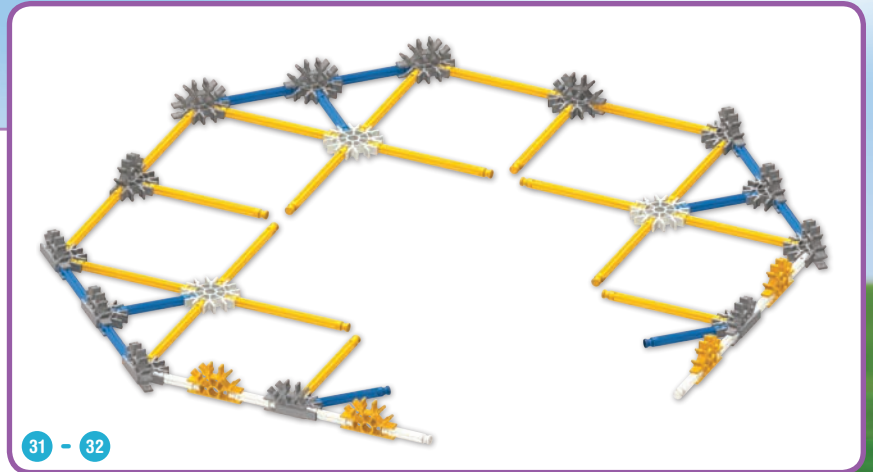
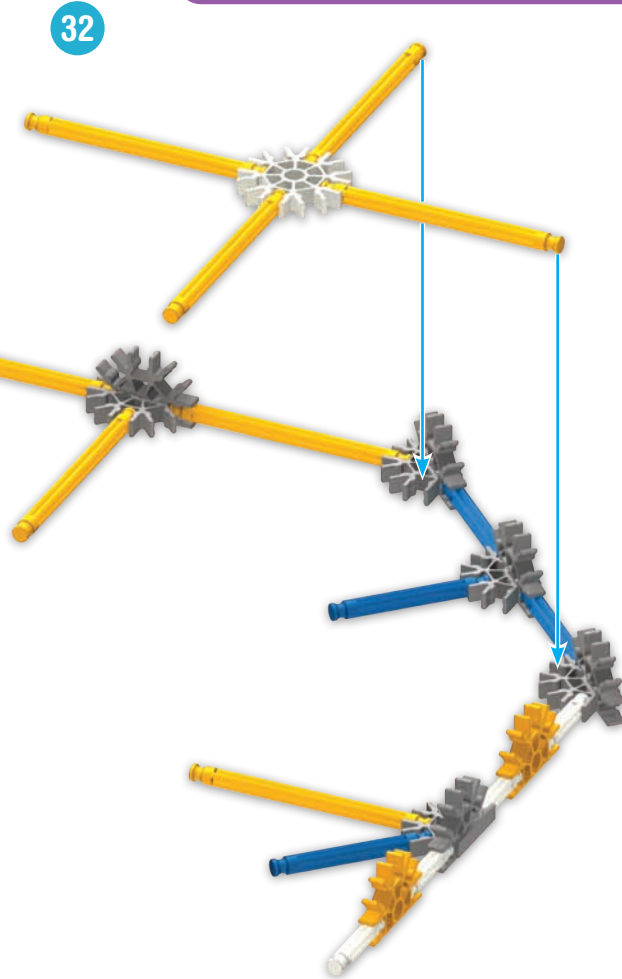
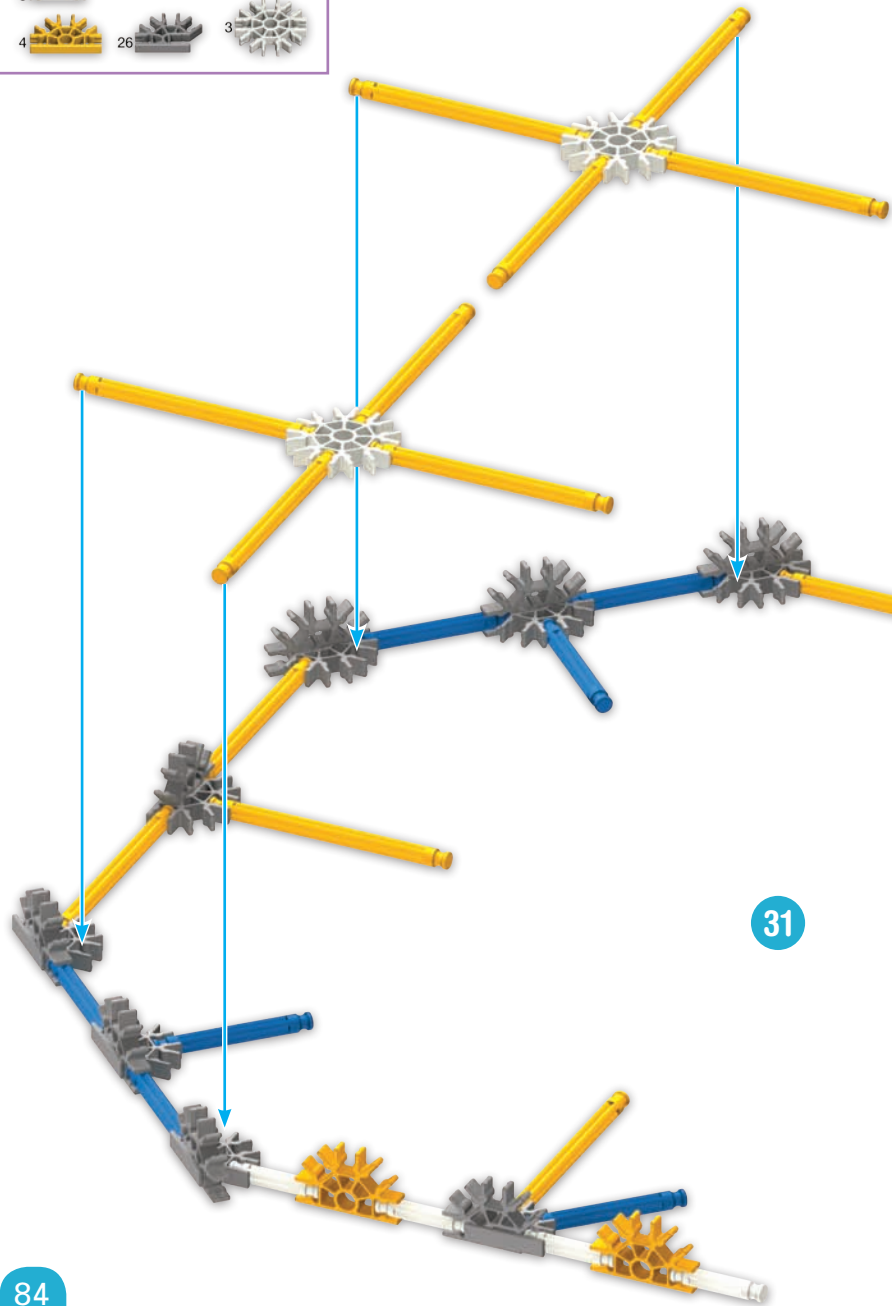
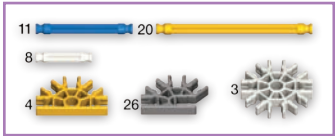

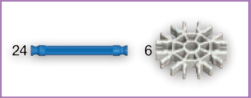

34

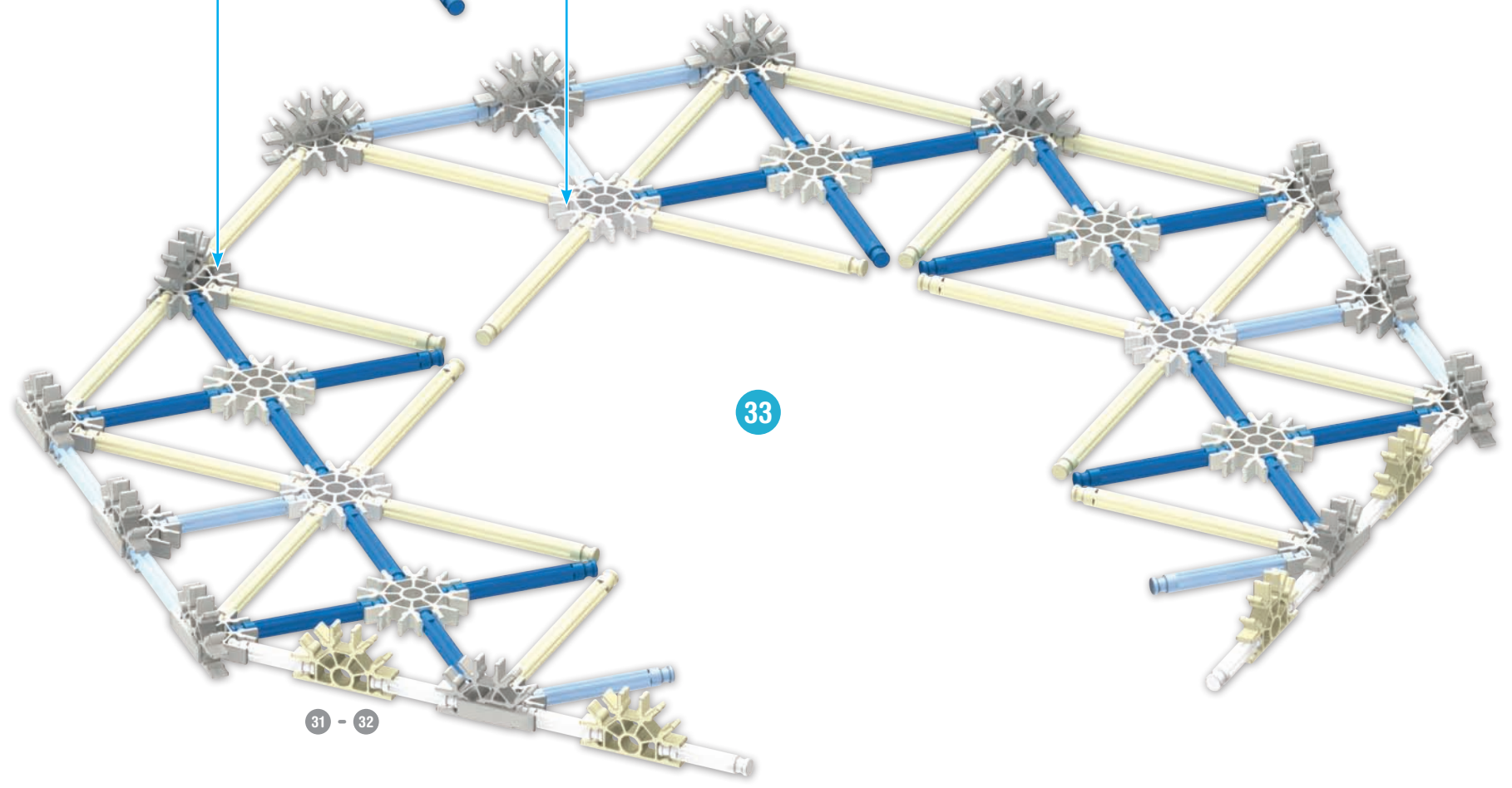
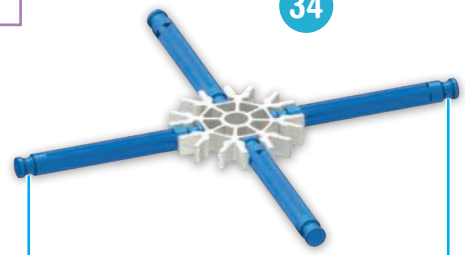

33

31 - 32

31 - 34

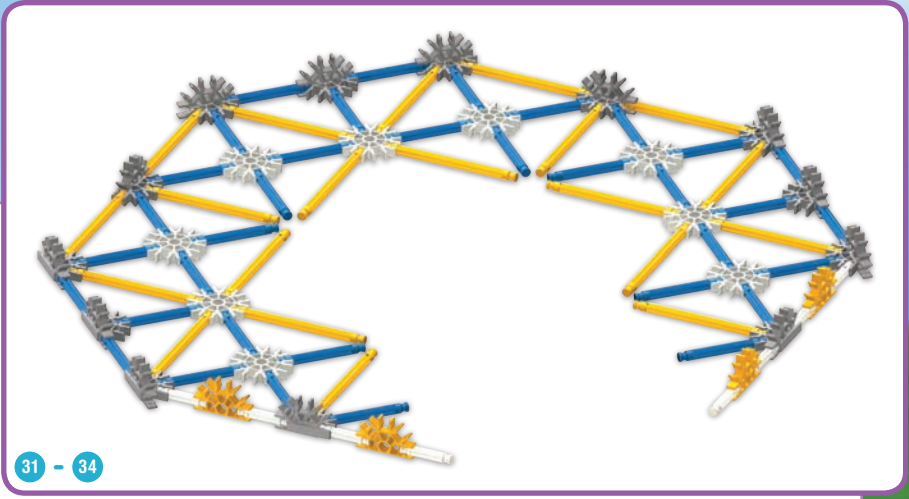

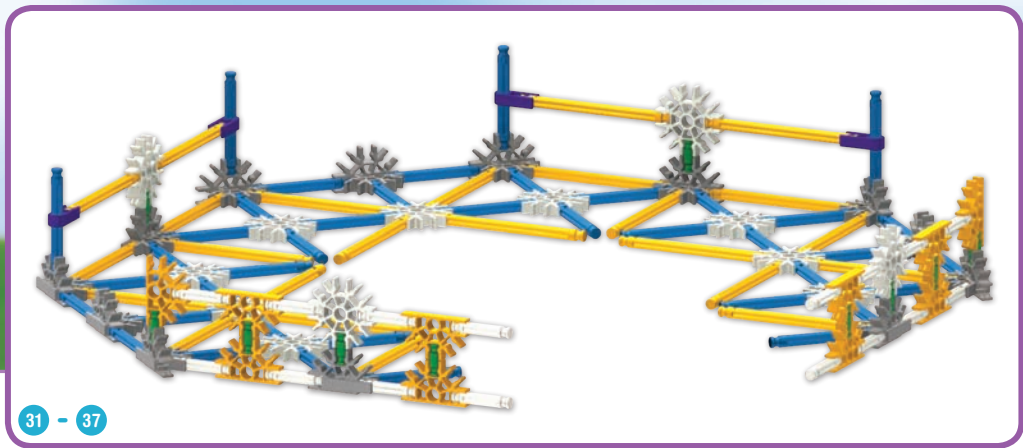

31 - 37

- 10
- 8
- 4
- 4
- 4
- 6
- 4

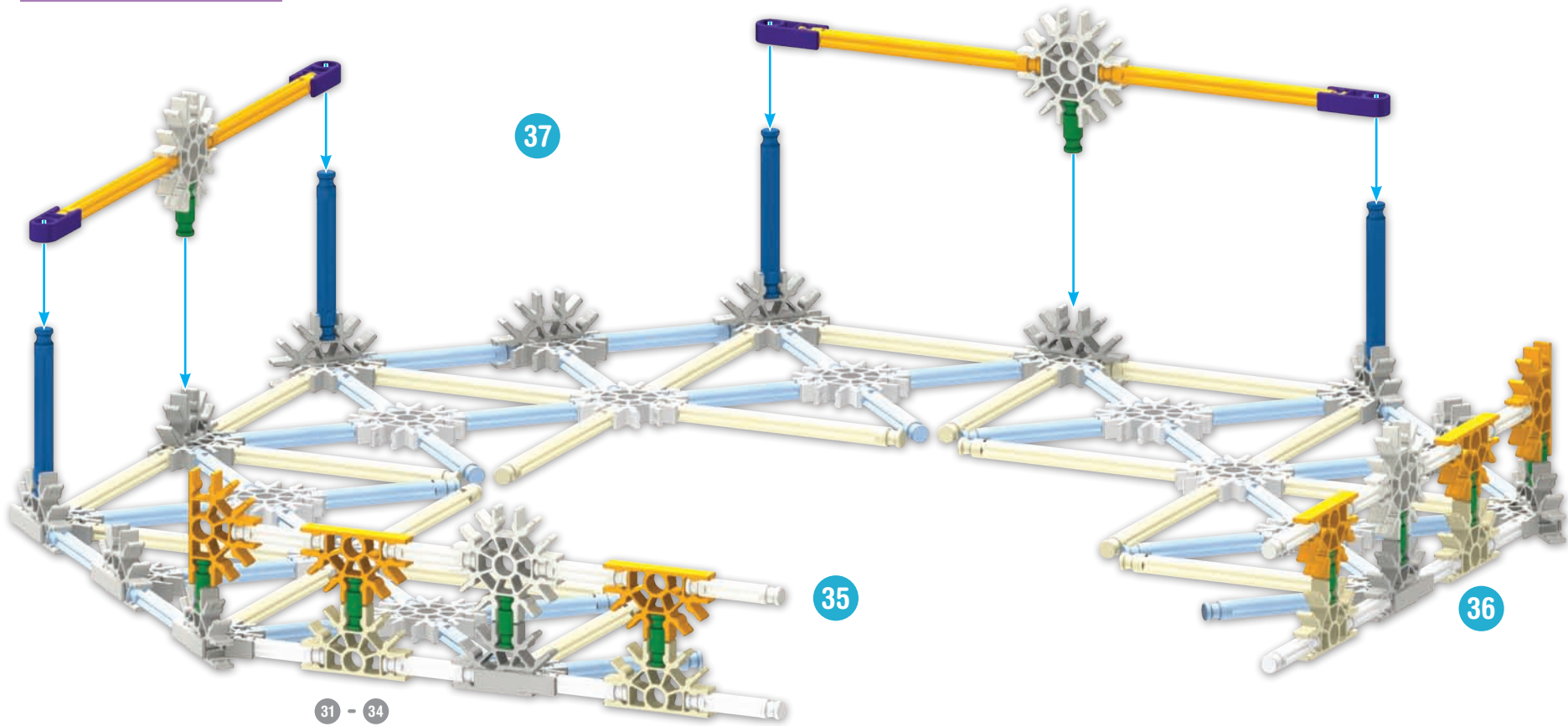

31 - 34

35

36

37

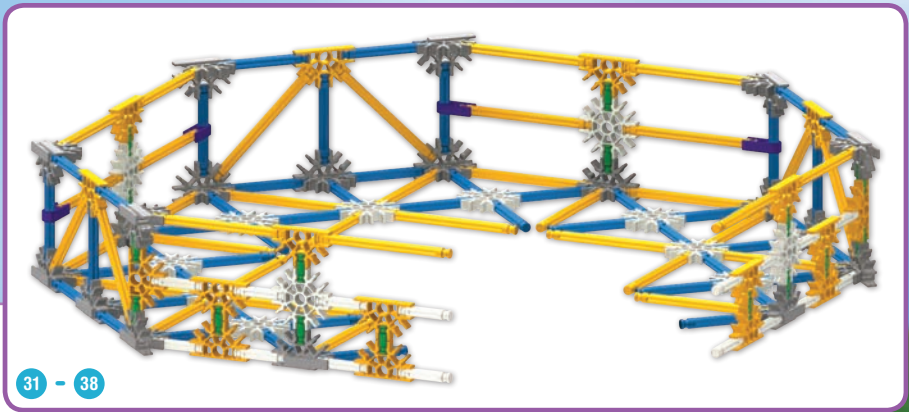

31 - 38

- 6 9
- 14
- 7 12

38

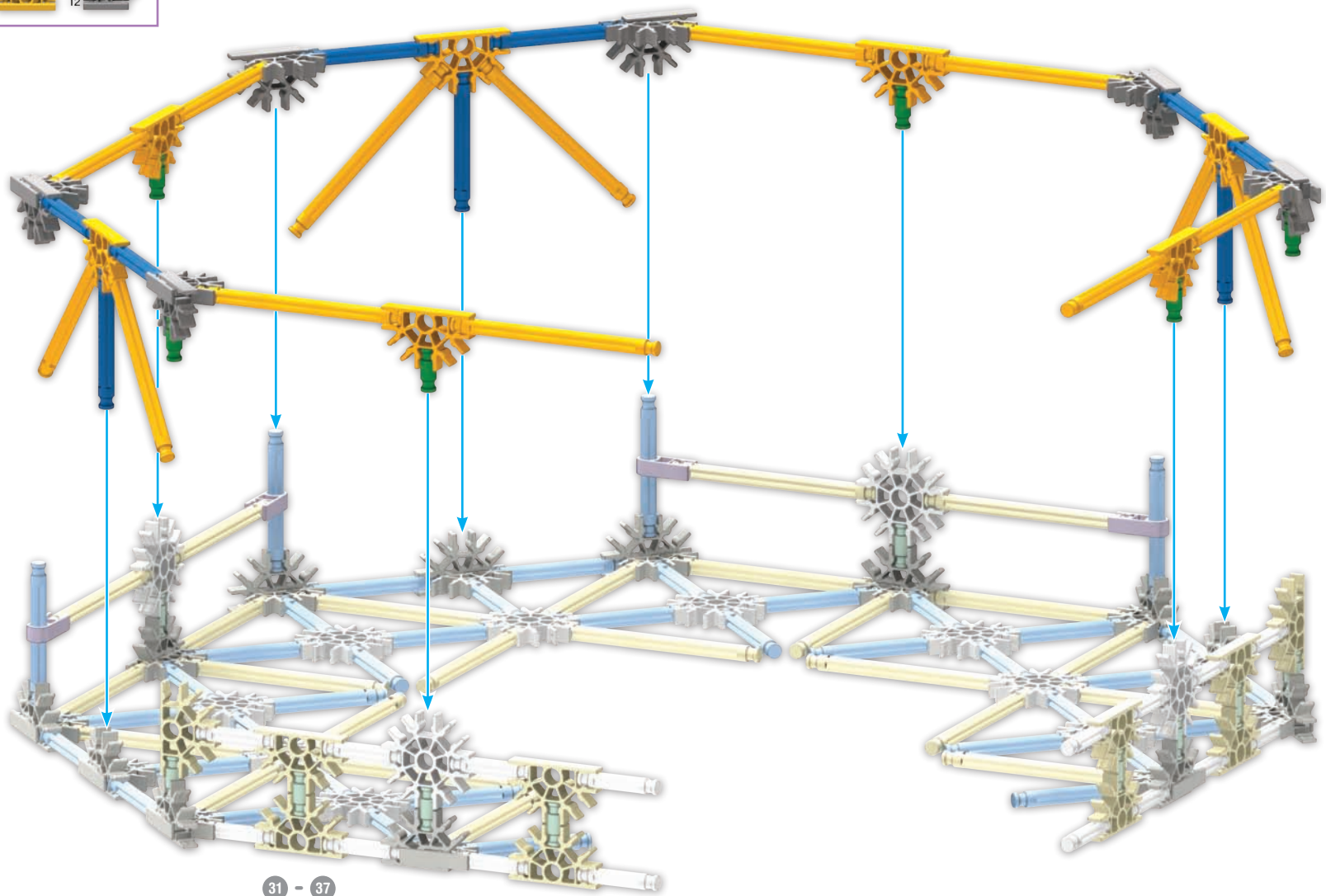

31 - 37

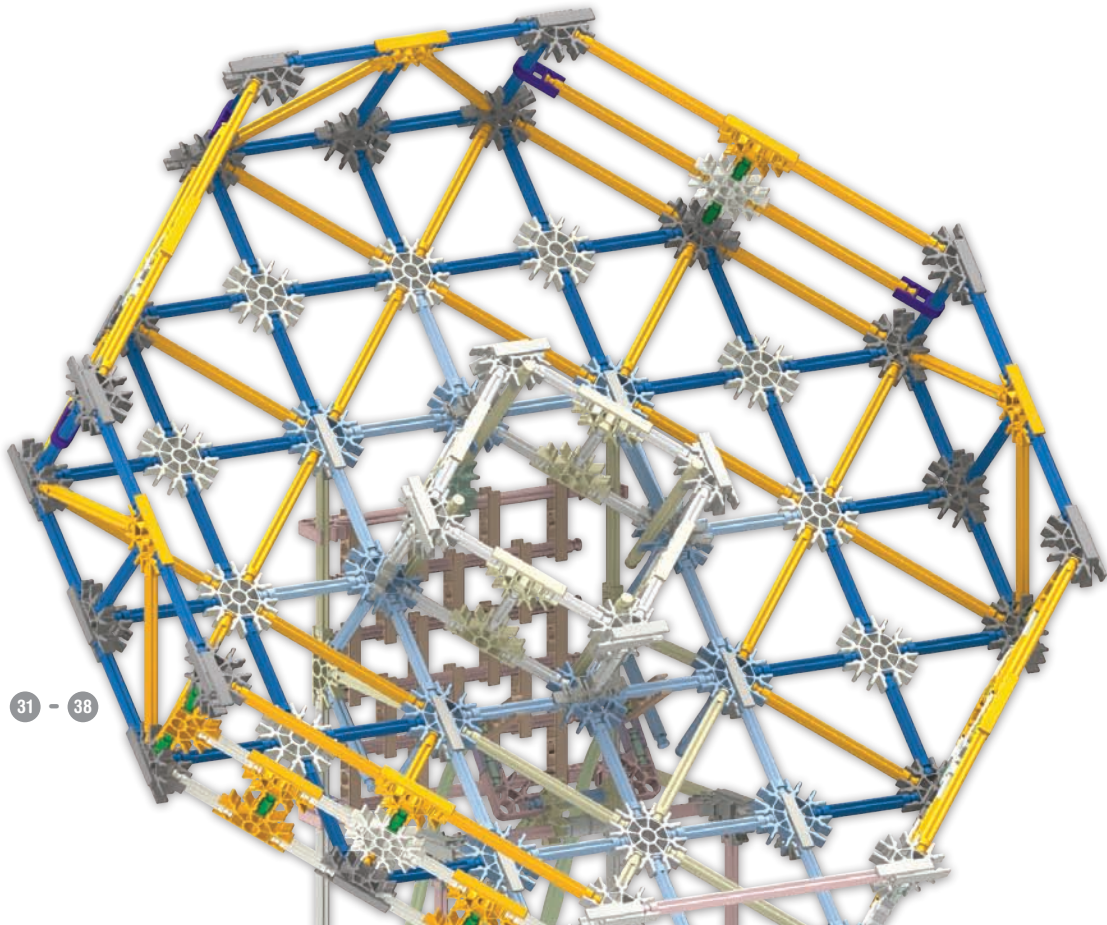

31 - 38

39

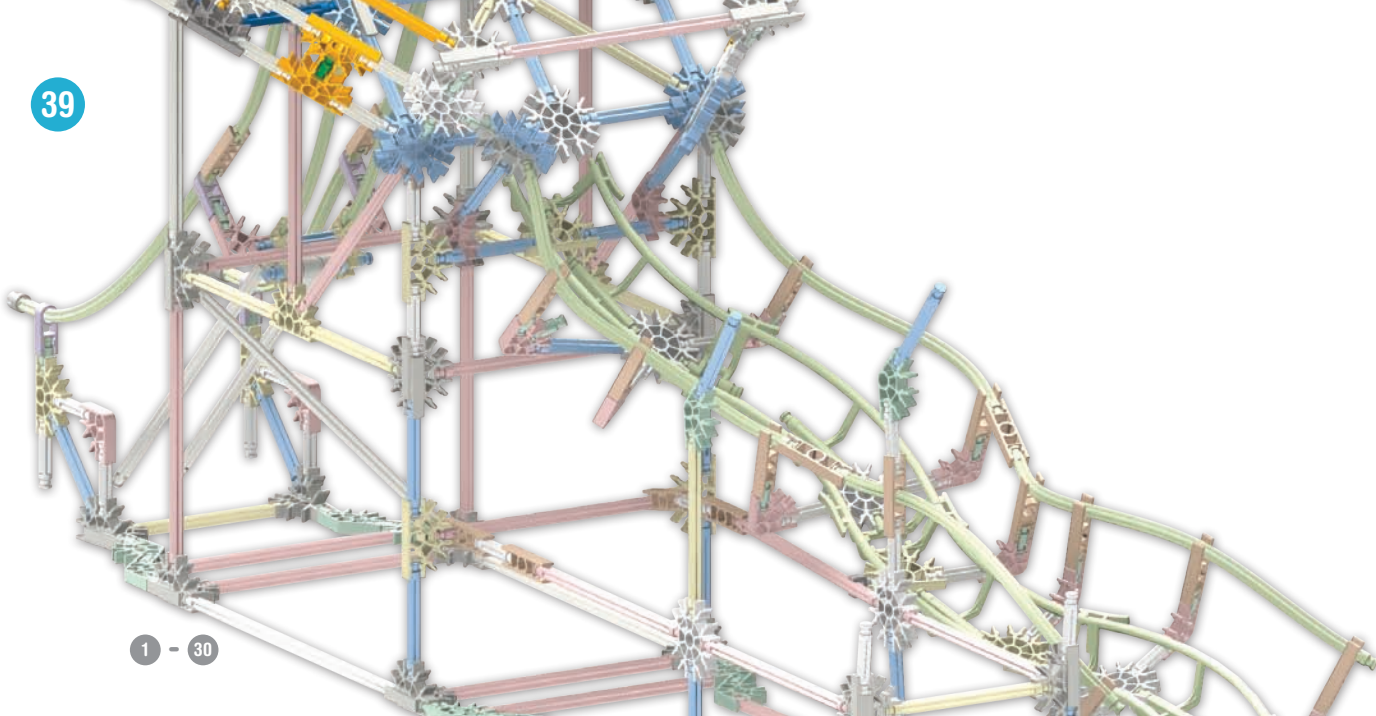

1 - 30

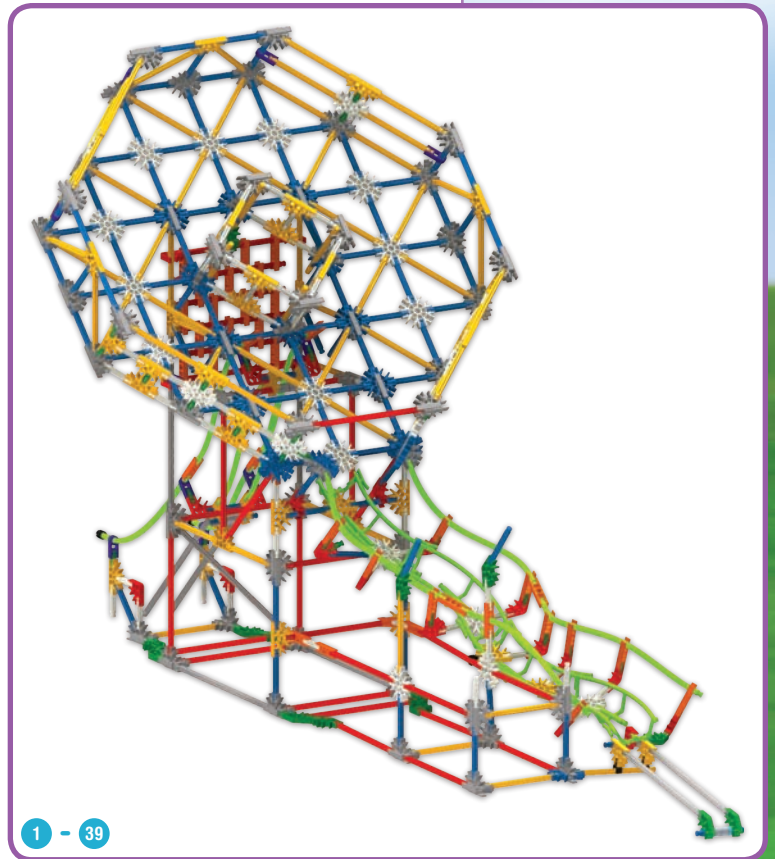

1 - 39

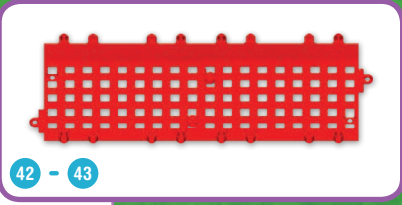
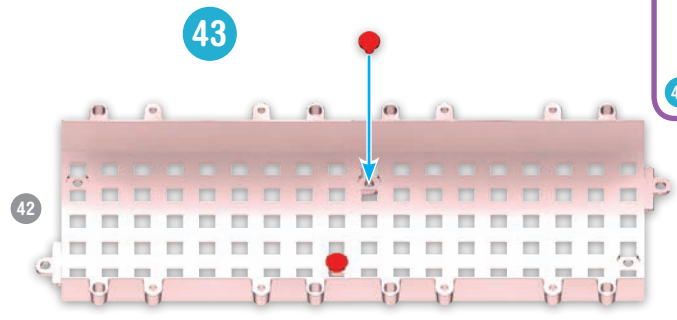
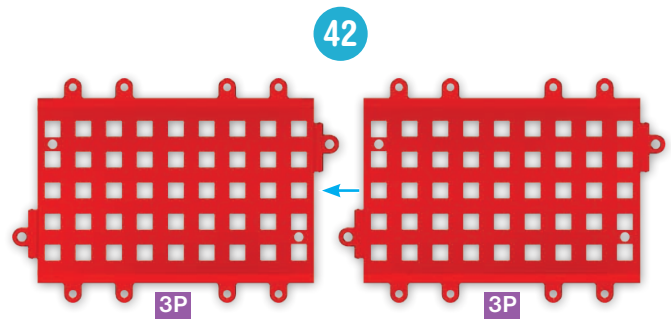
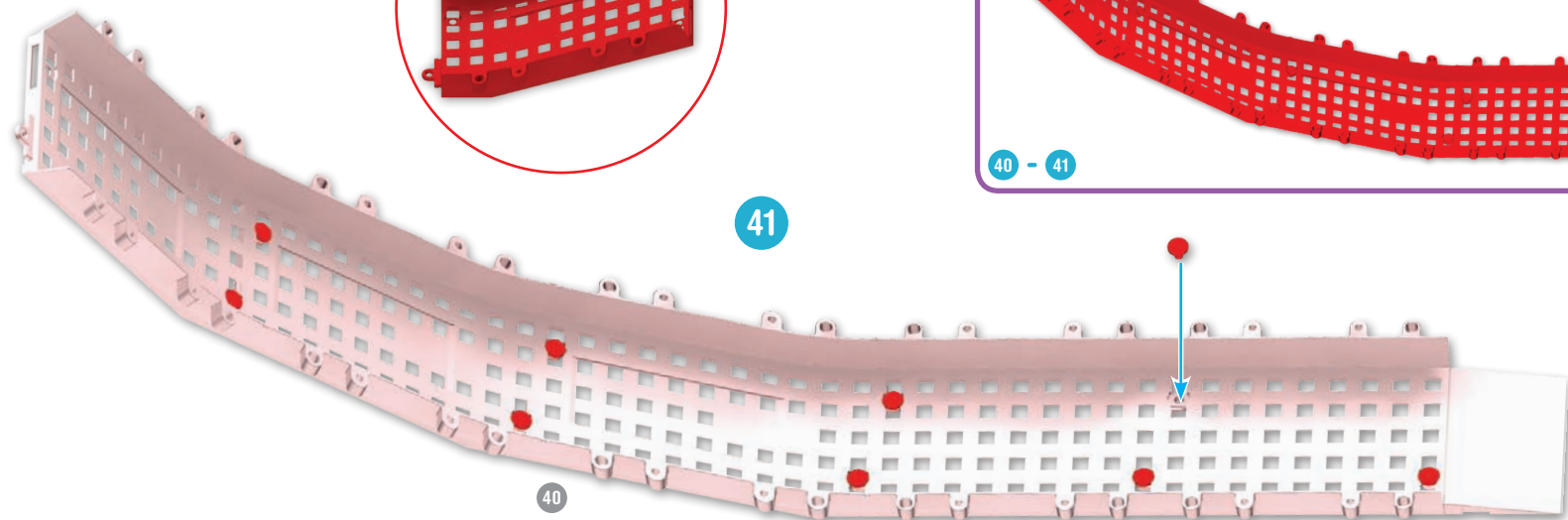
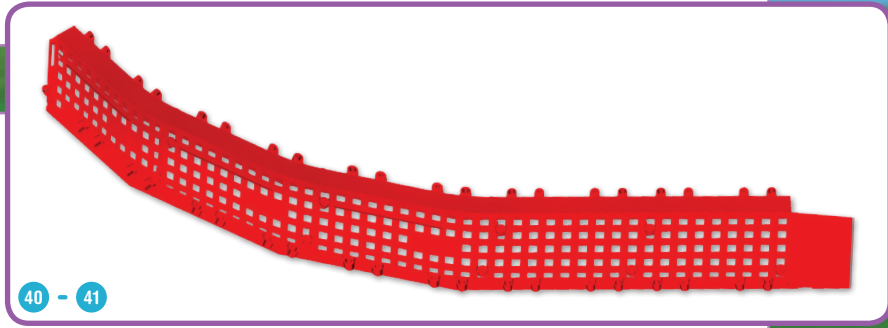
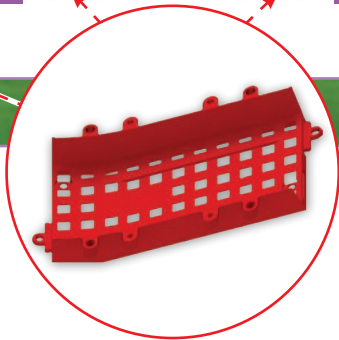
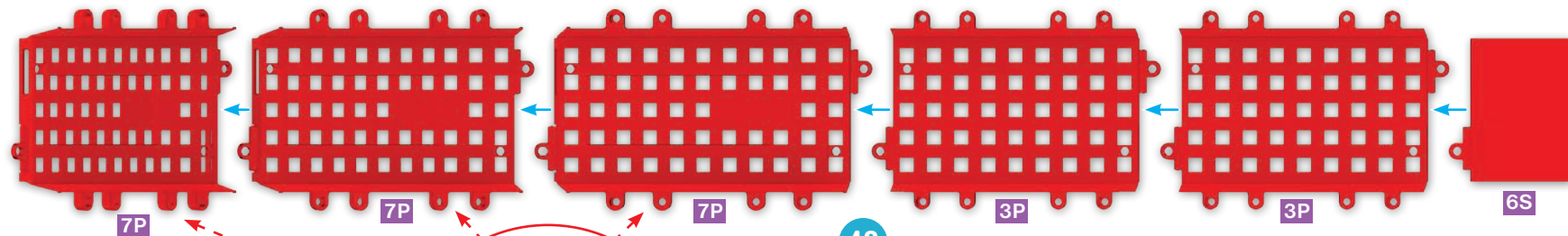

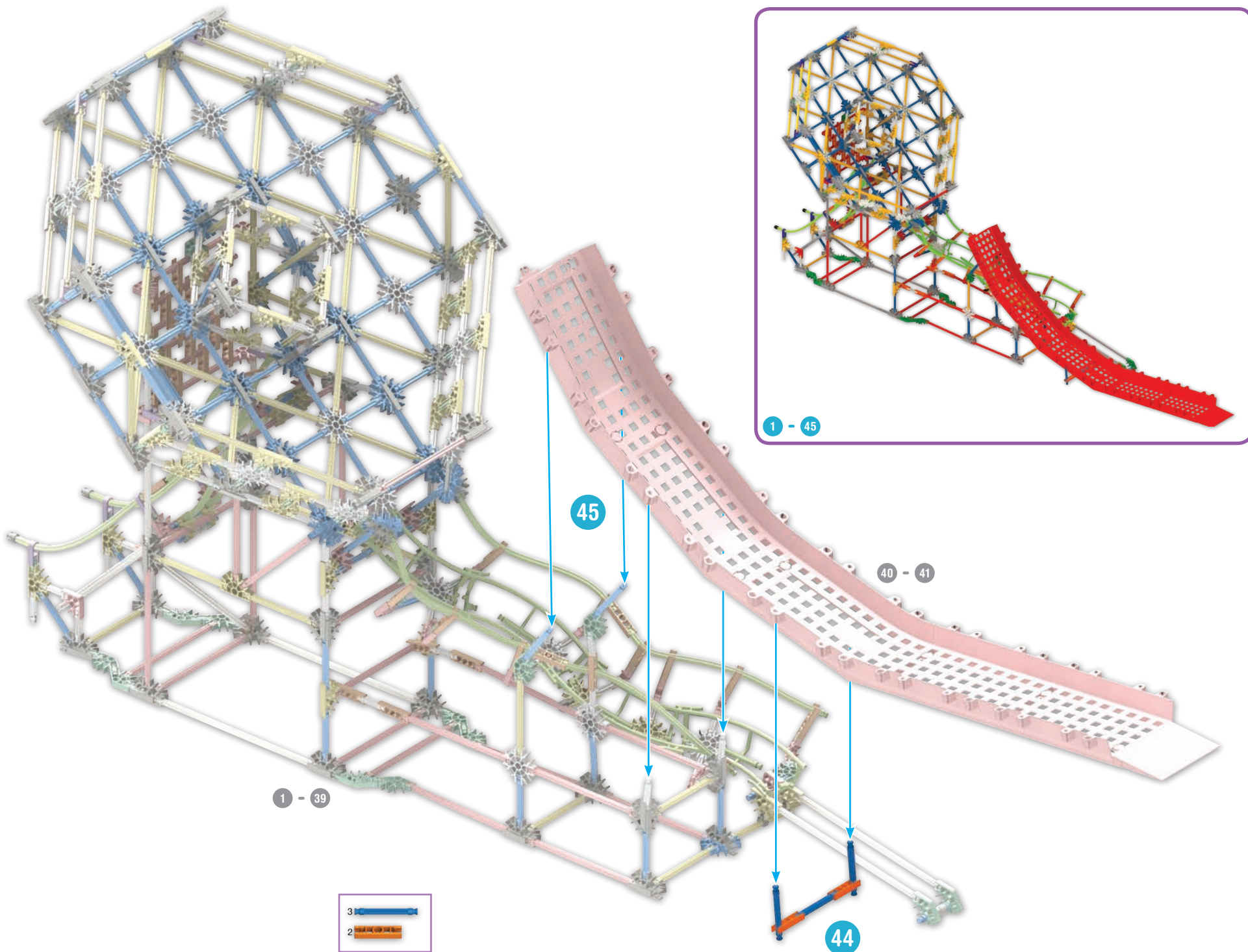

HOLE #9 TROU

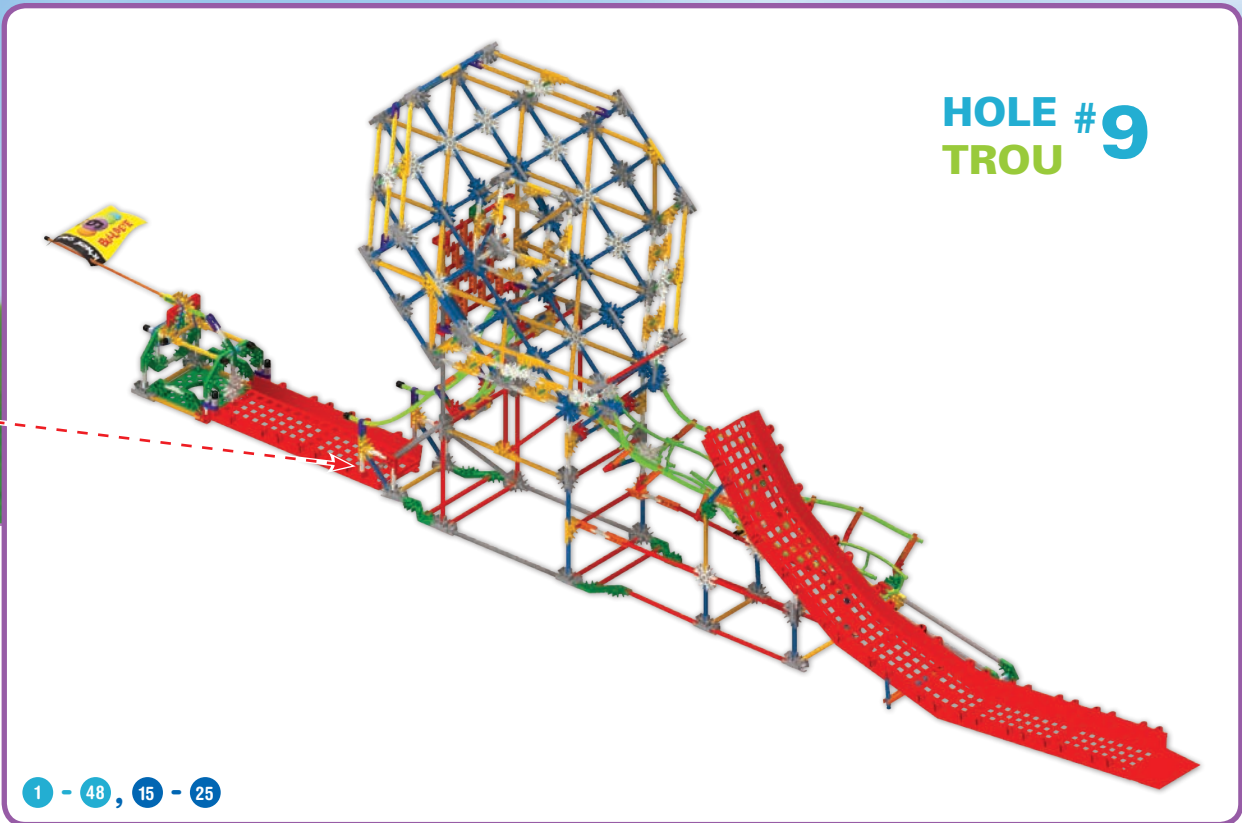

1 - 48, 15 - 25

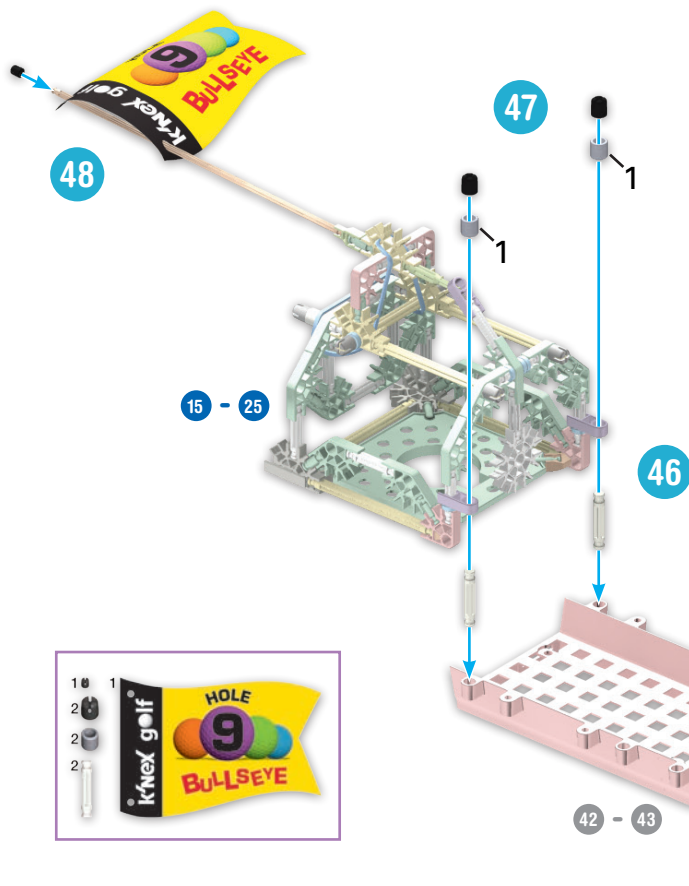

42 - 43

1 - 45

