

43733 Alternate Build

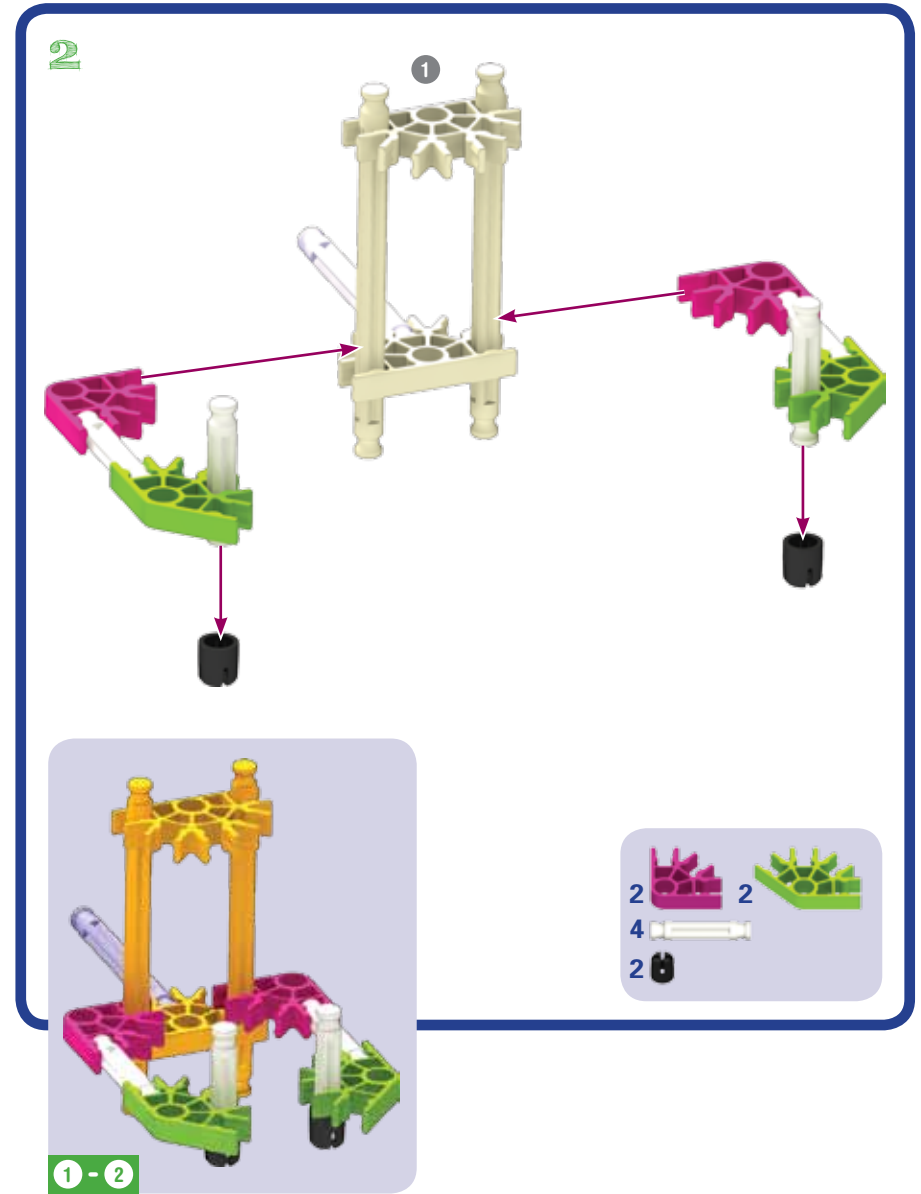

flying contraption

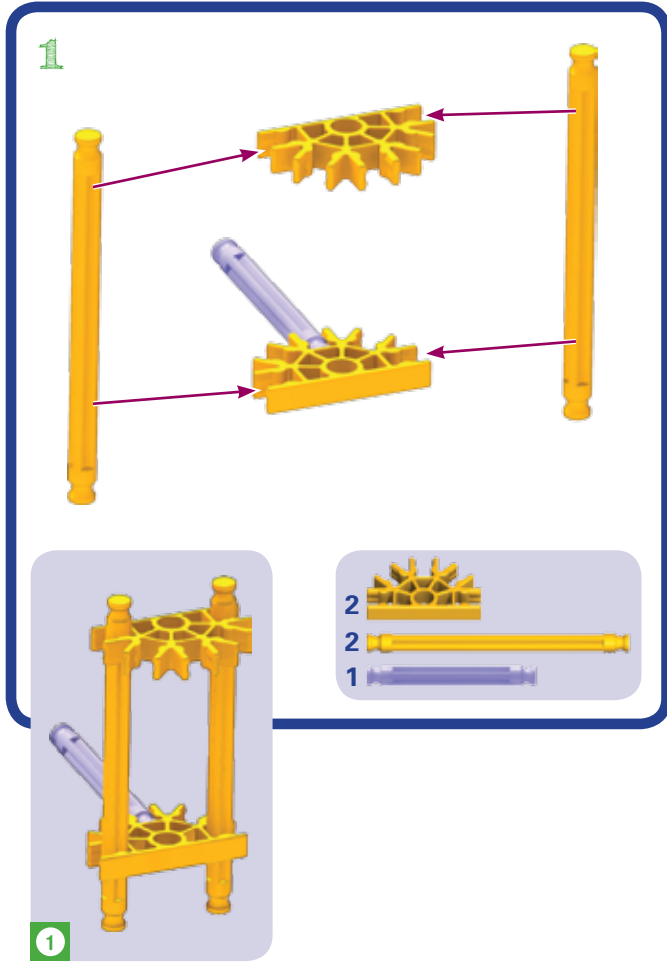

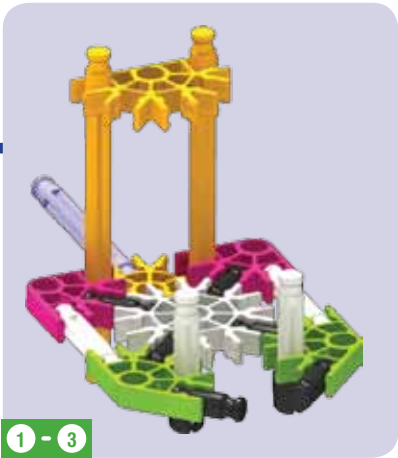
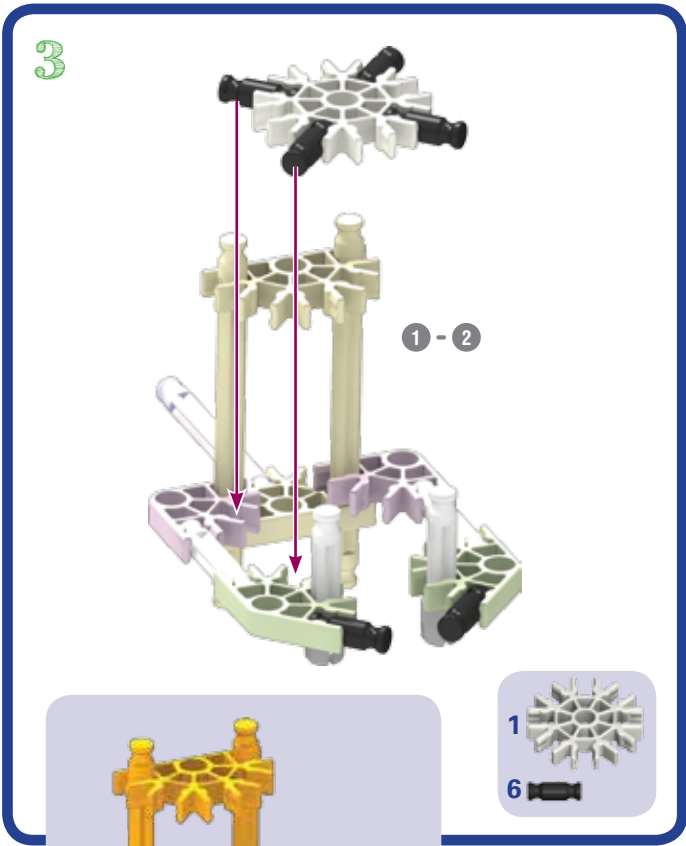

5

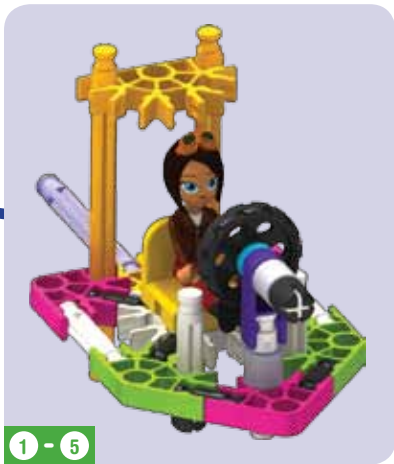
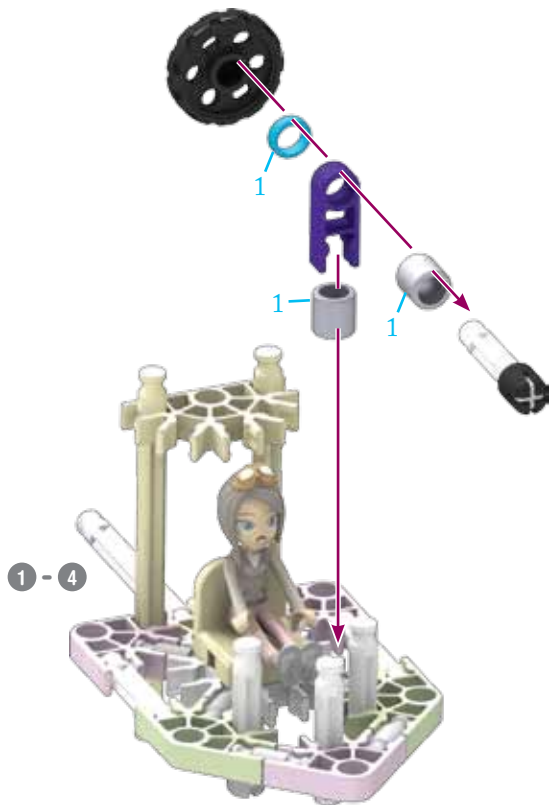

- 1  1 
- 1  1  2 
- 1 

6

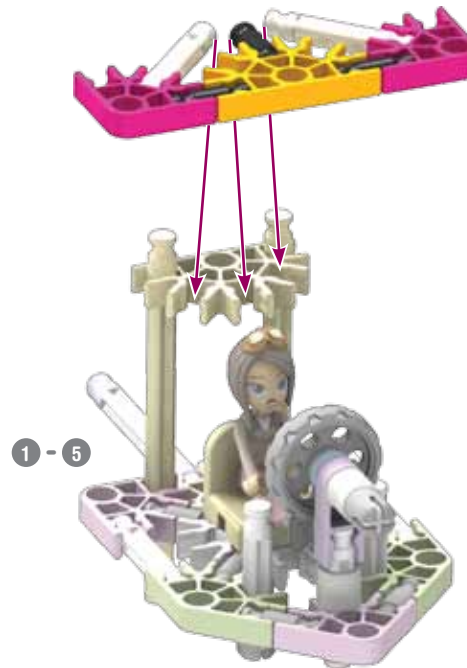

- 1 
- 2 
- 3 

7

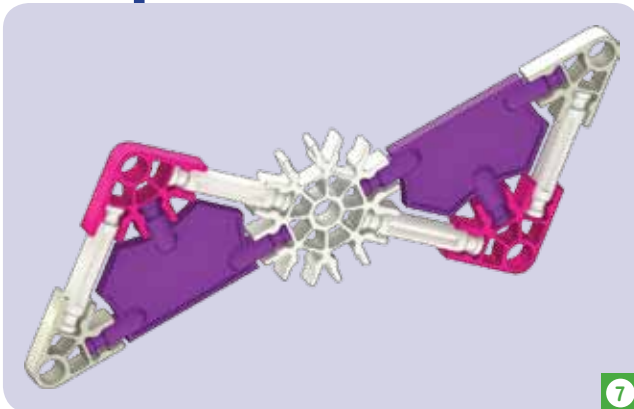
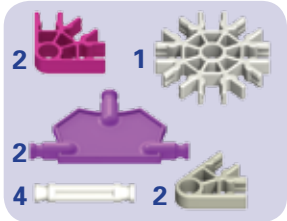
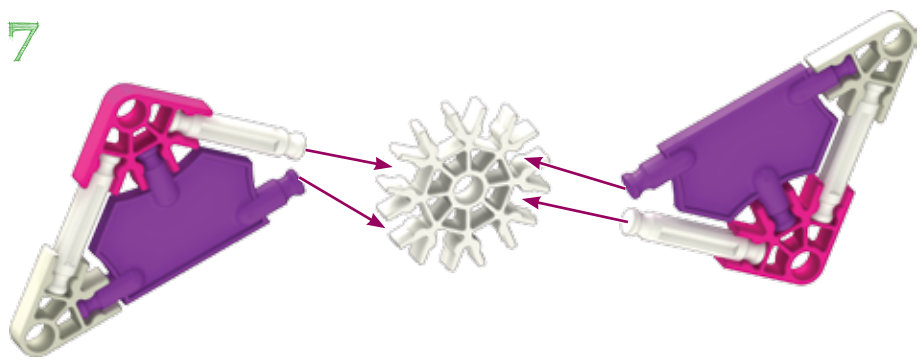

7



8

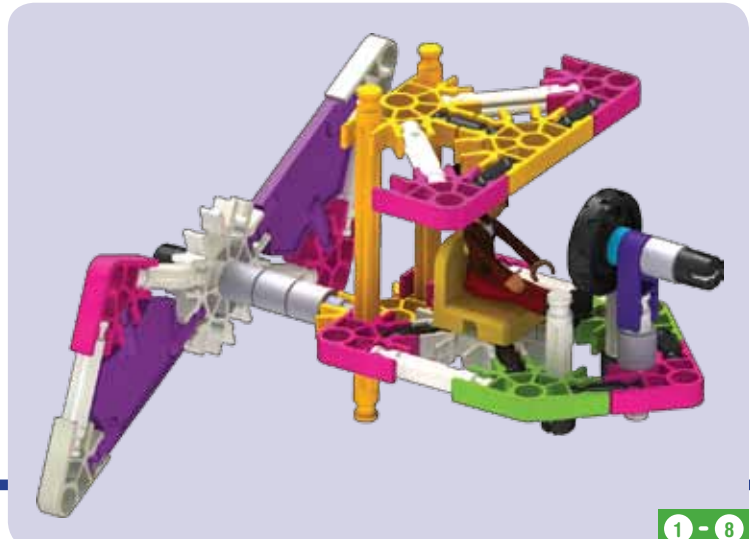
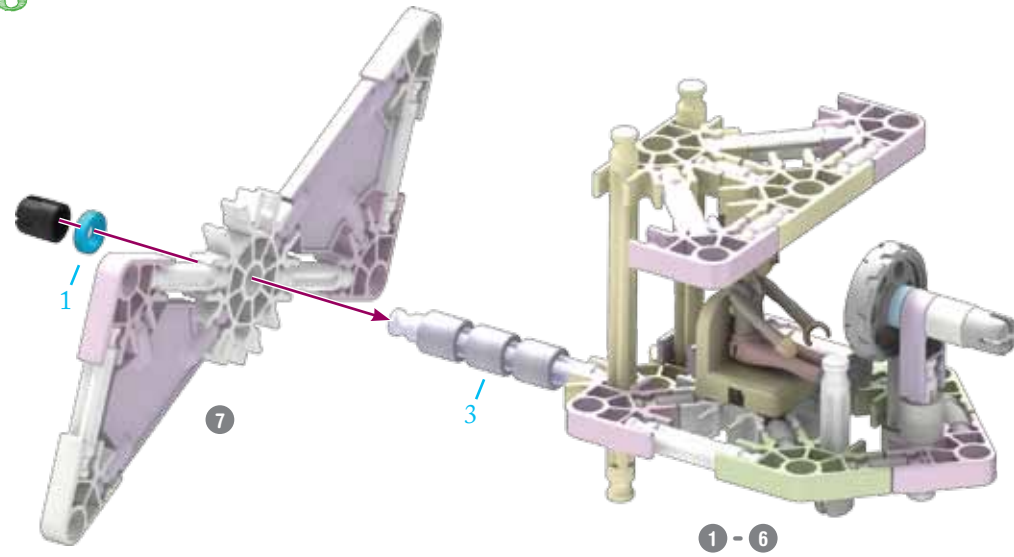

1 - 8

9

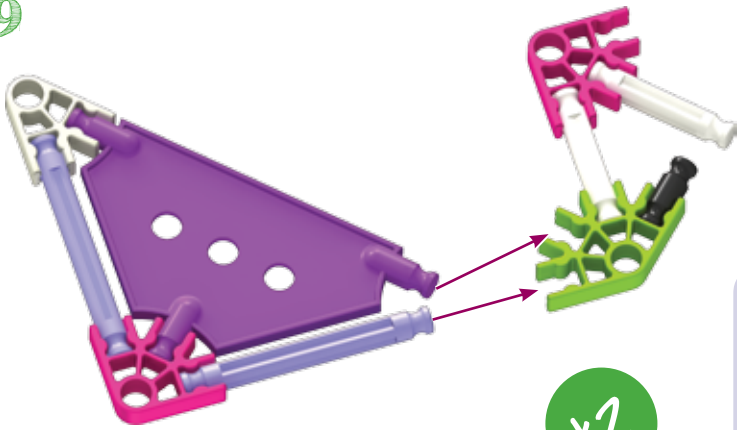

x2

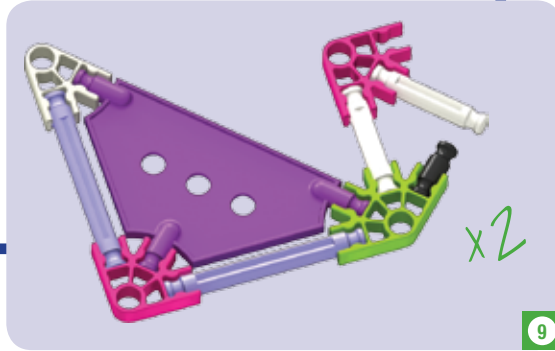
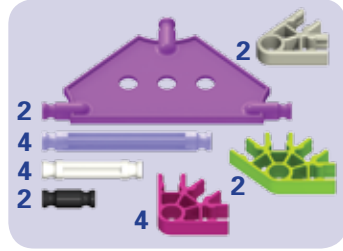

9

10

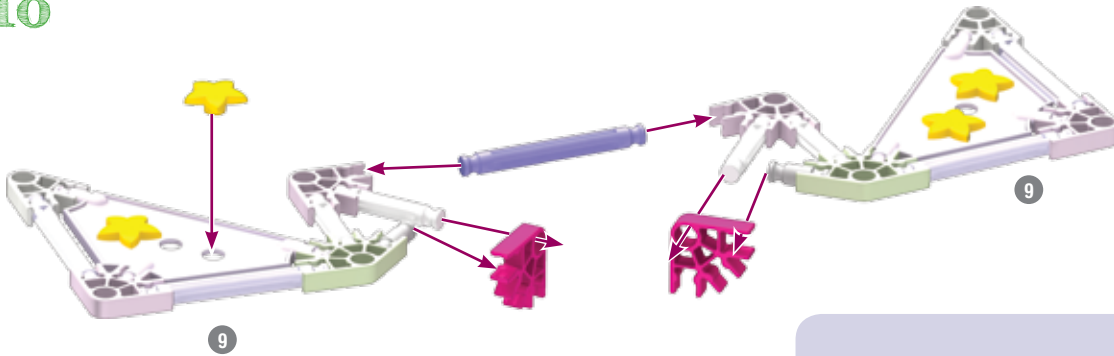

9

9



9 - 10

11

