

# 43533 Alternate Build

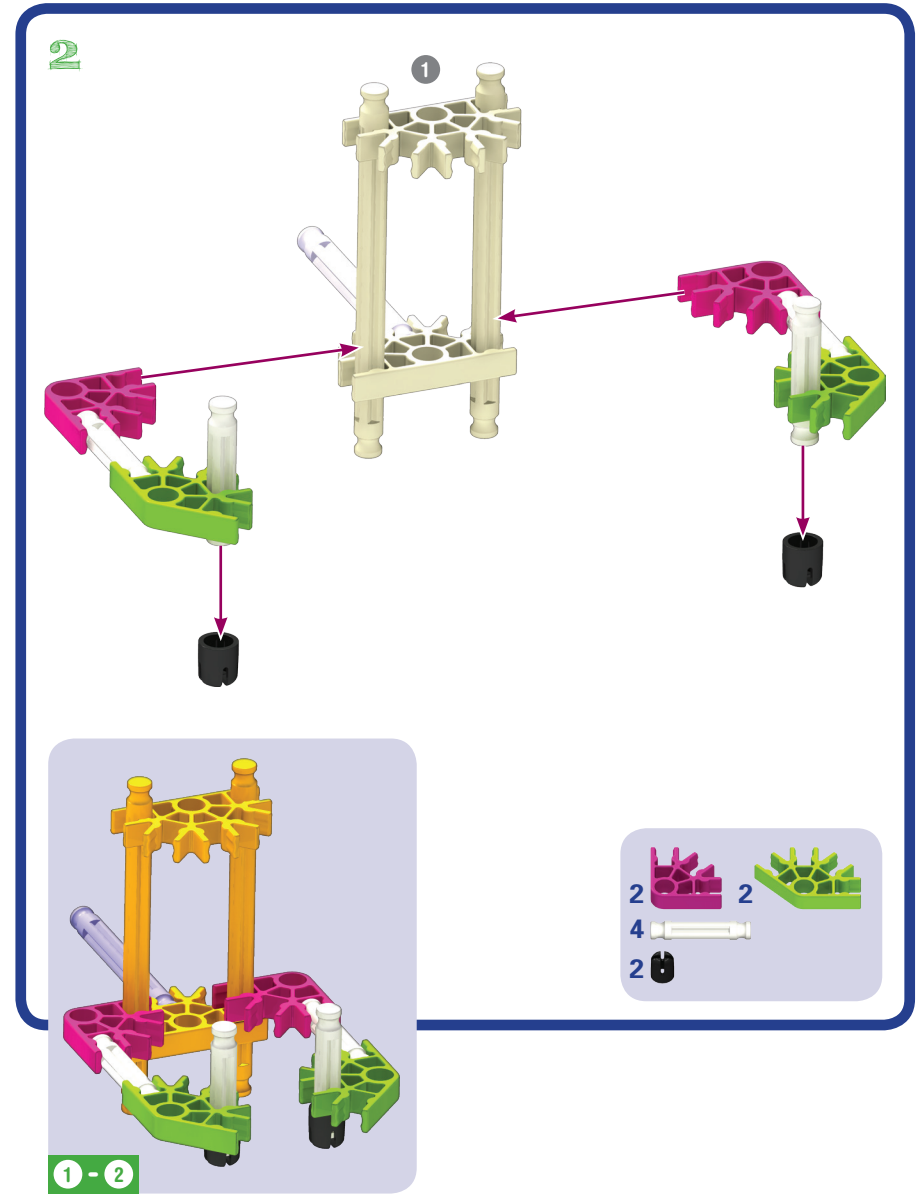

flying contraption

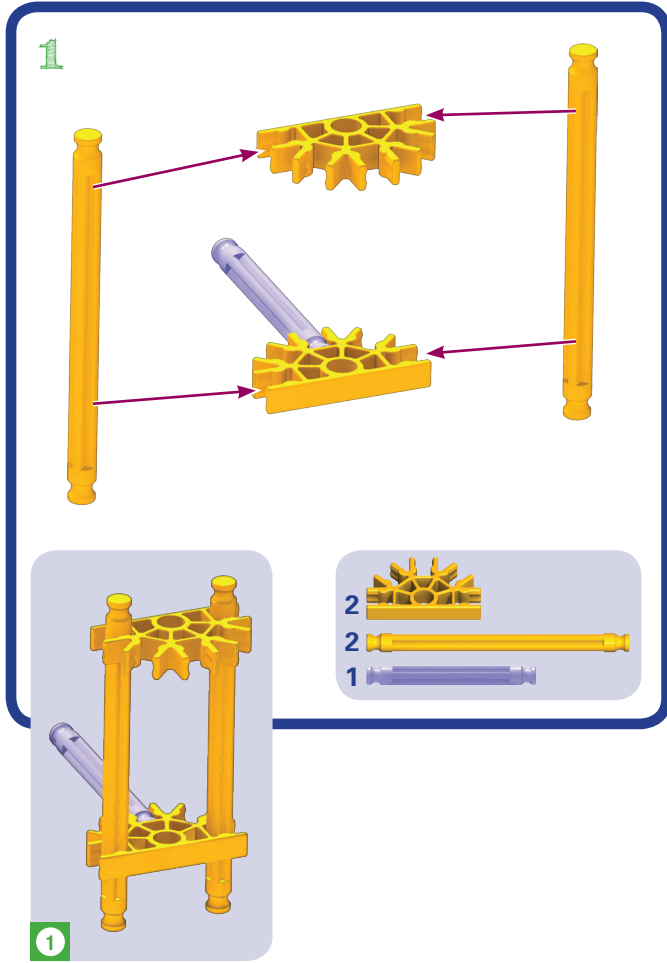

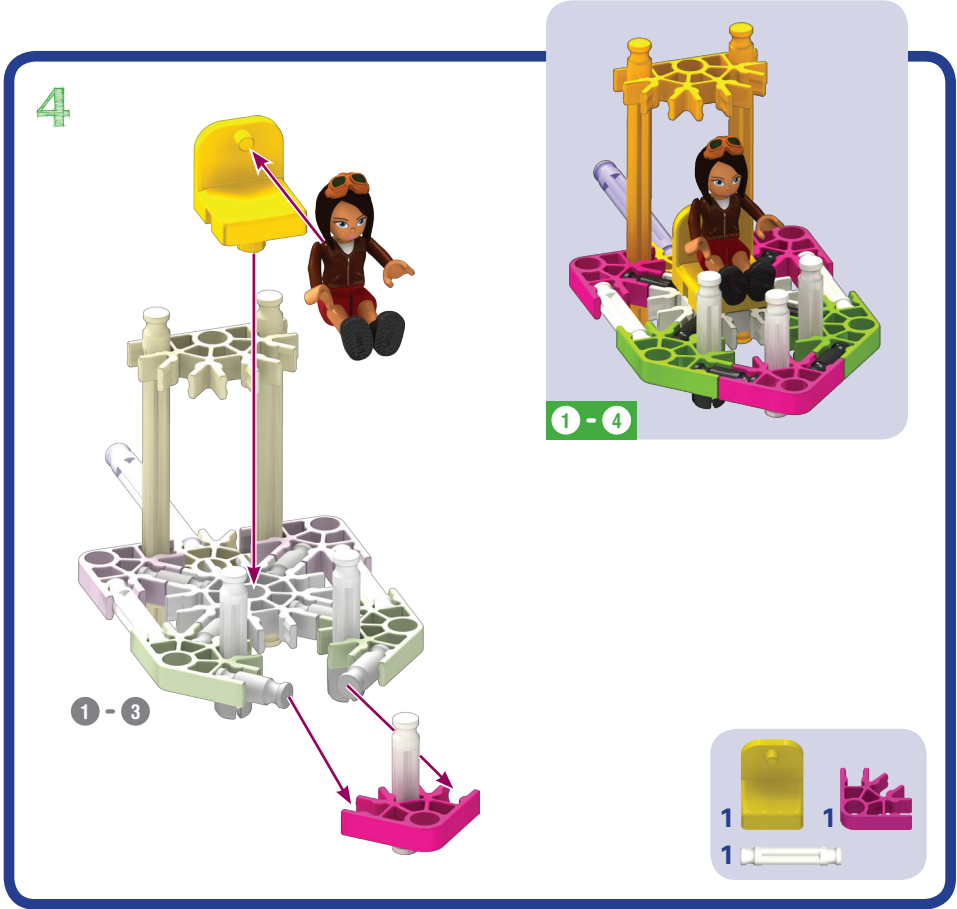
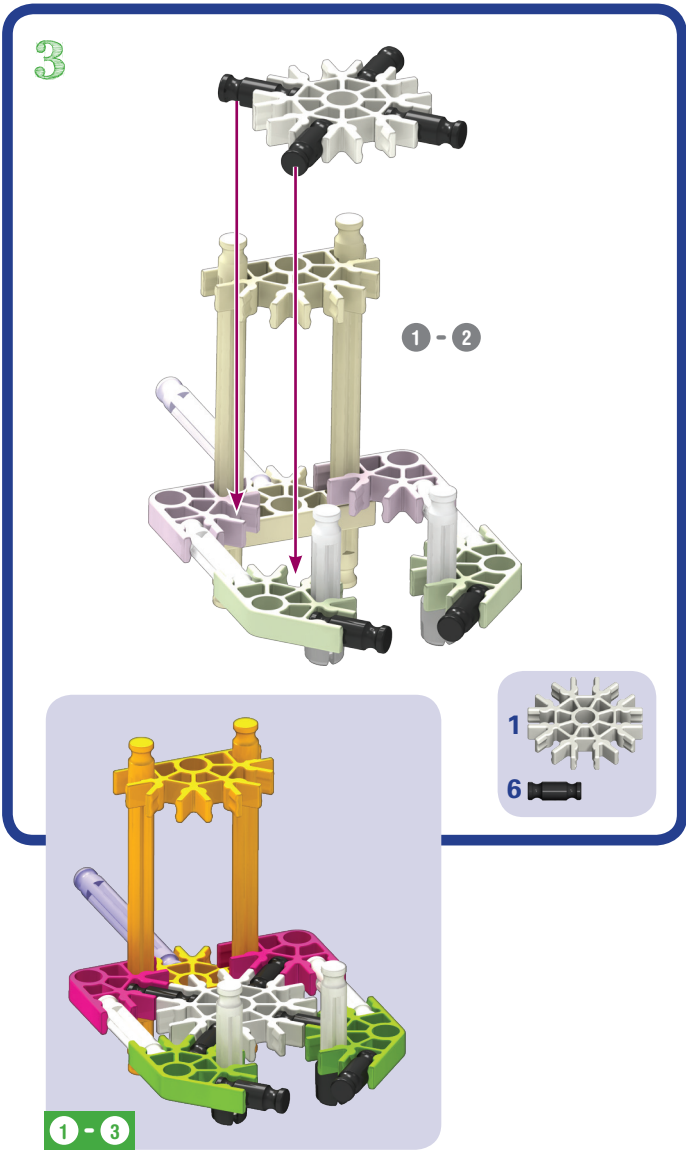

5

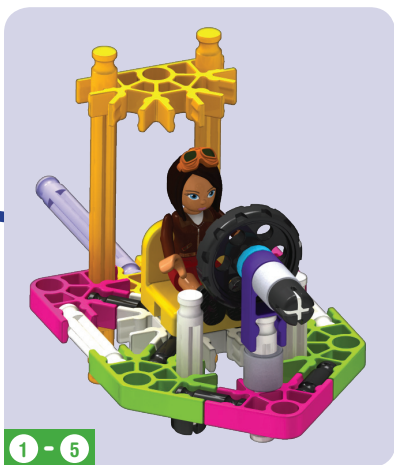
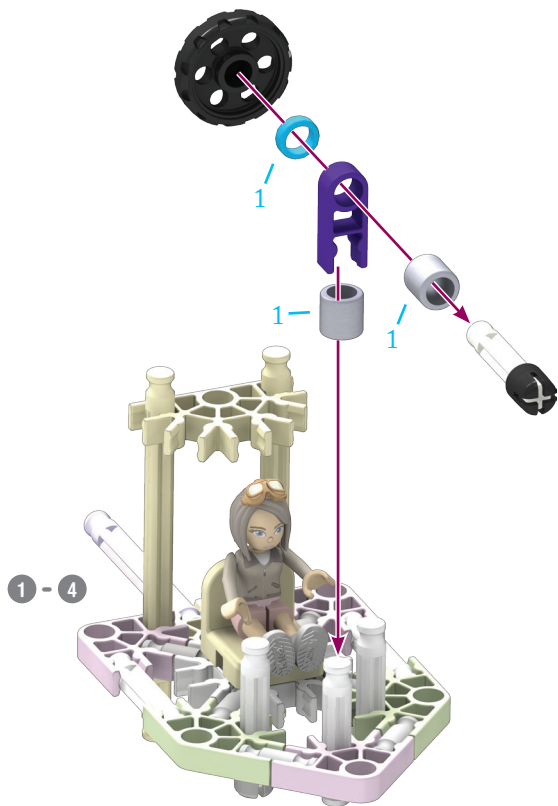

- 1 1
- 1 1 2
- 1

6

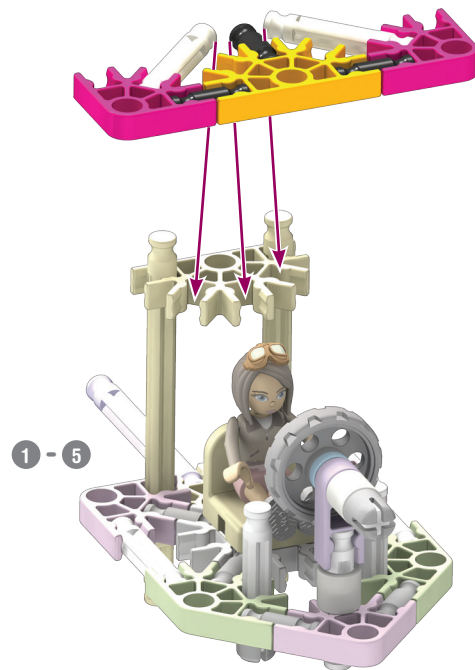

- 1
- 2
- 3

7

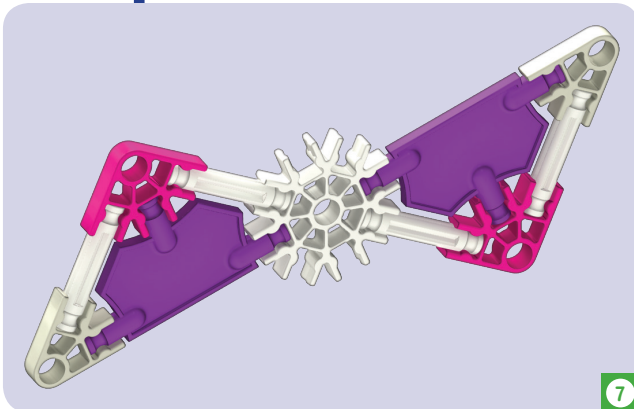
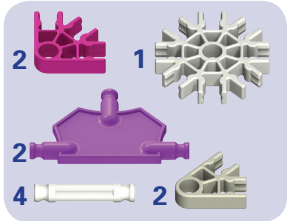
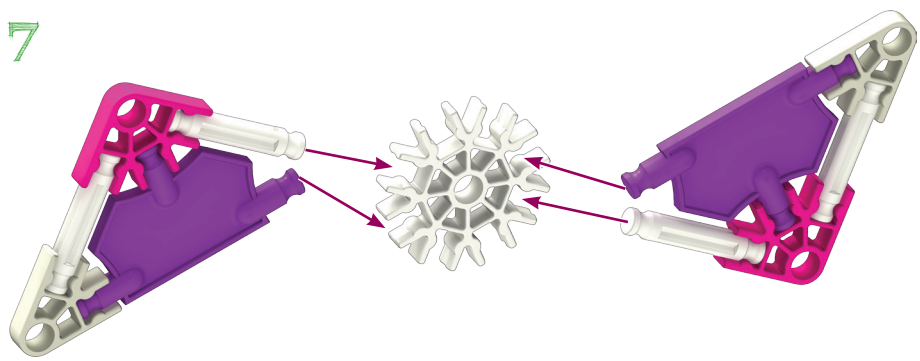

8

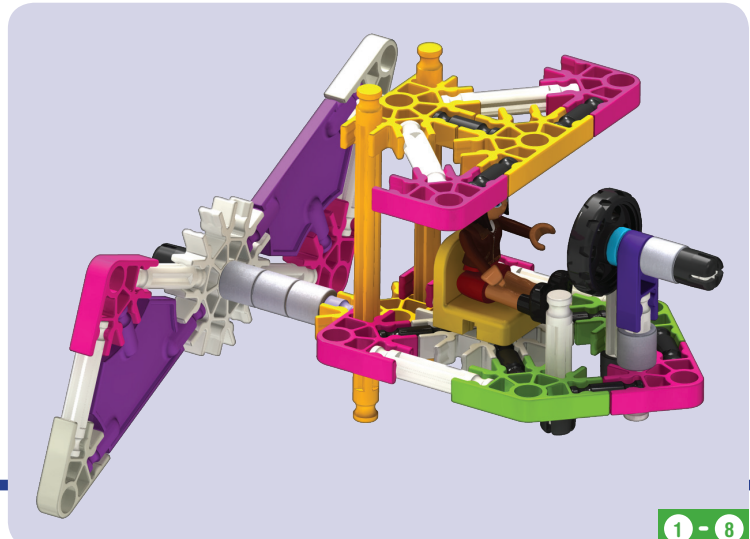
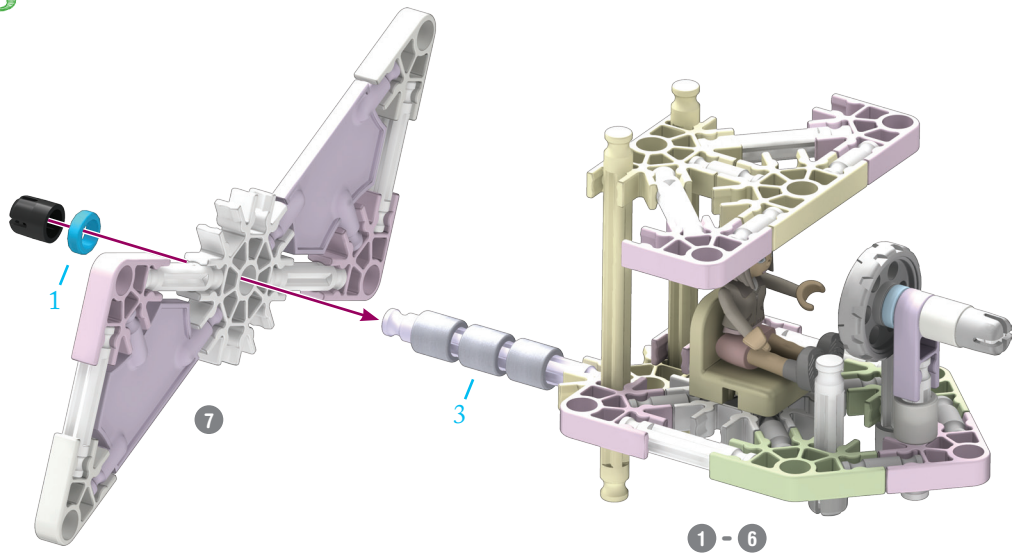

9

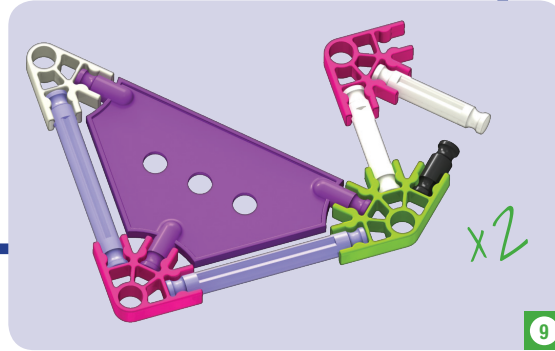
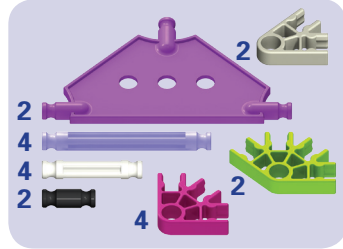
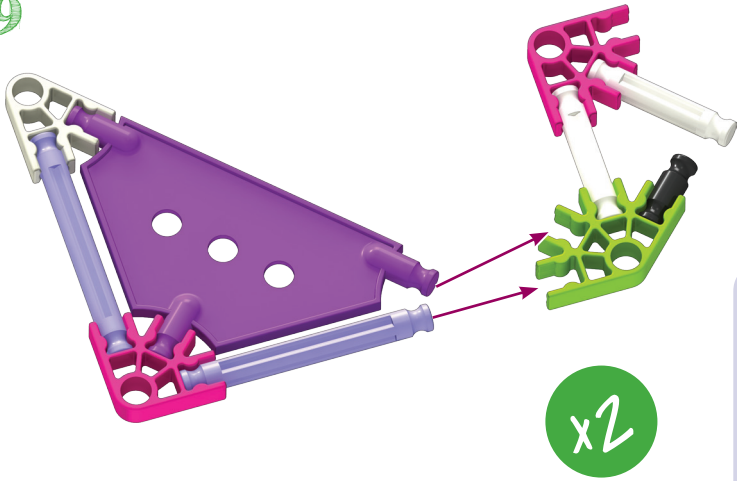

10

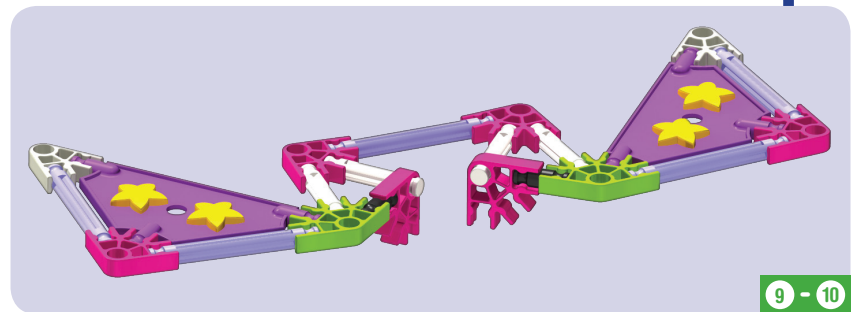
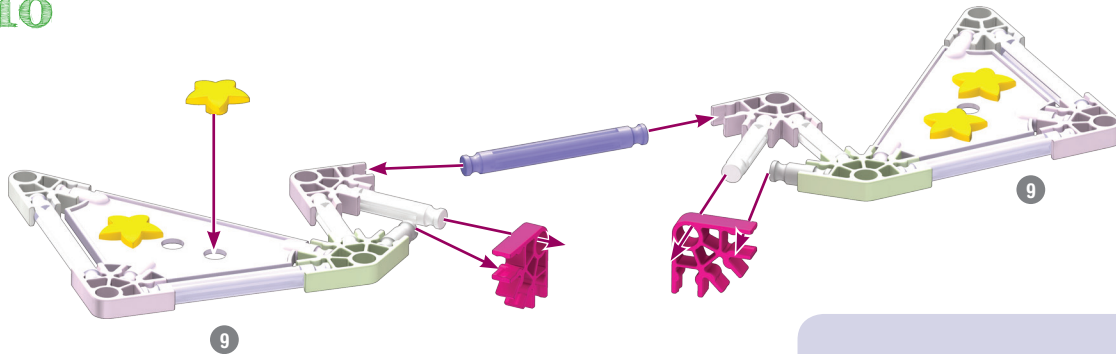

11

