

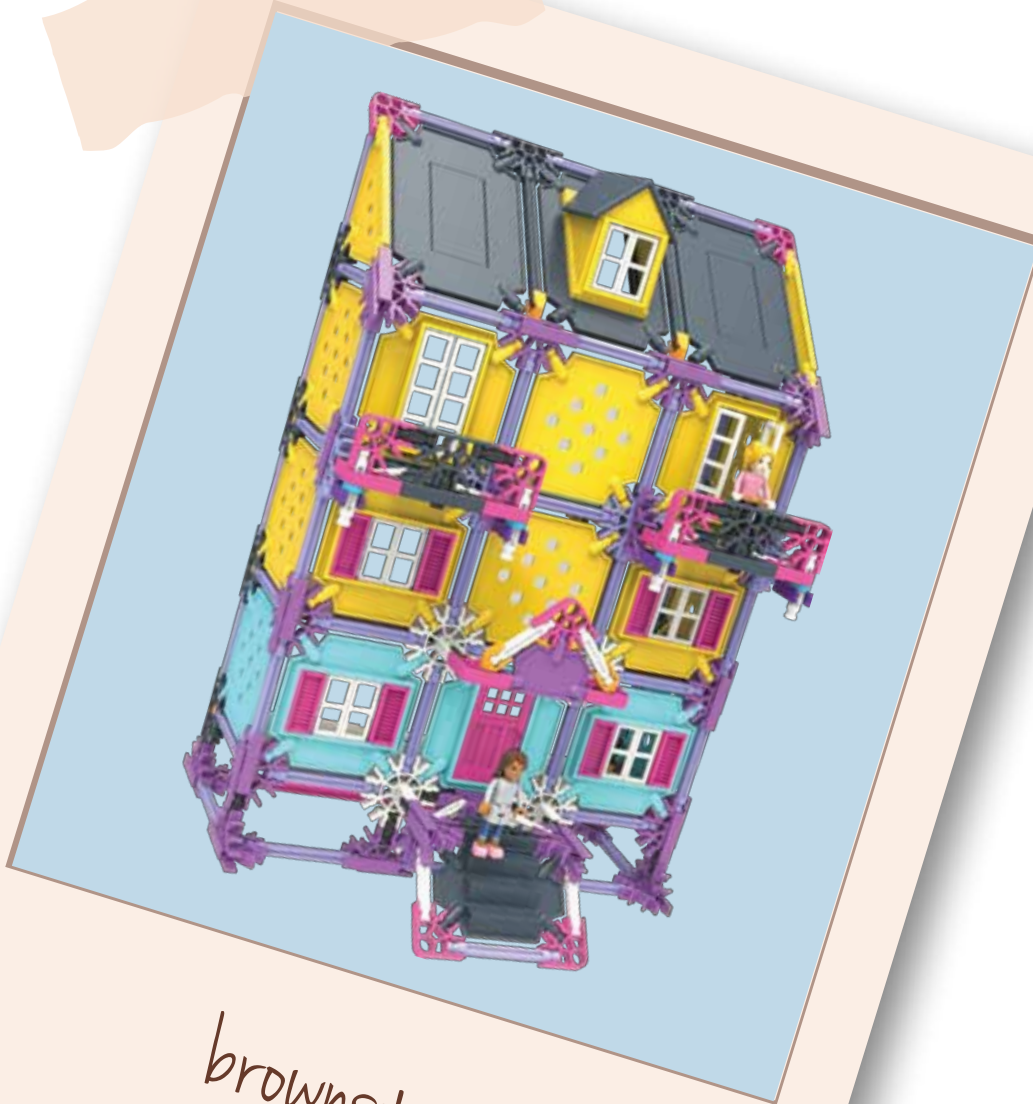

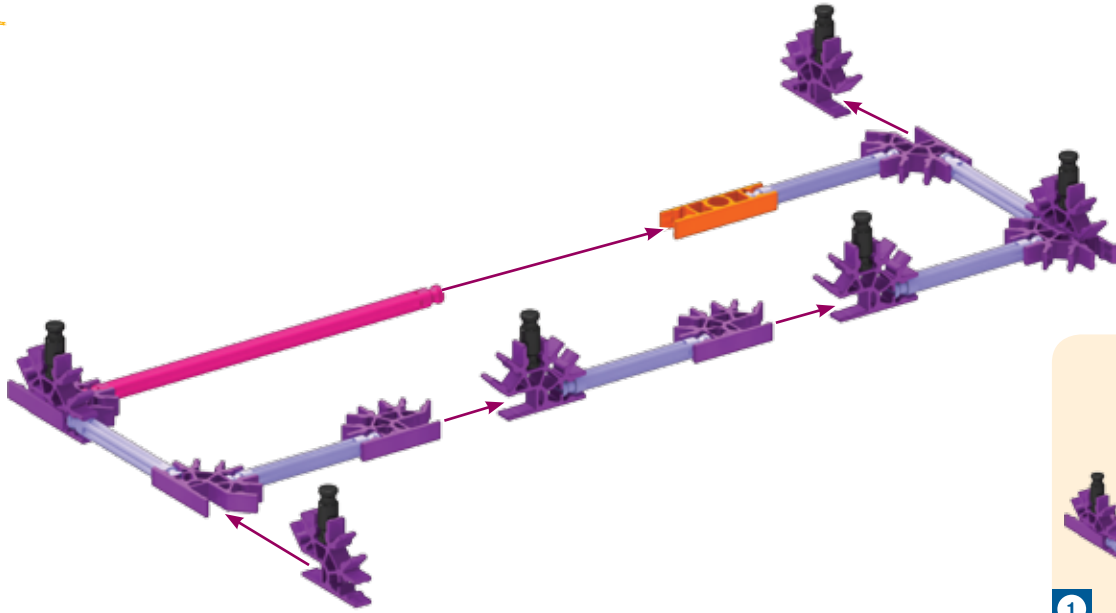



# 43488 Alternate Build



brownstone

1





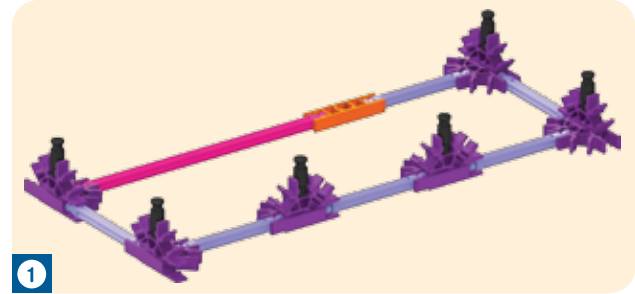



- 6  12 
- 1 
- 1  6 

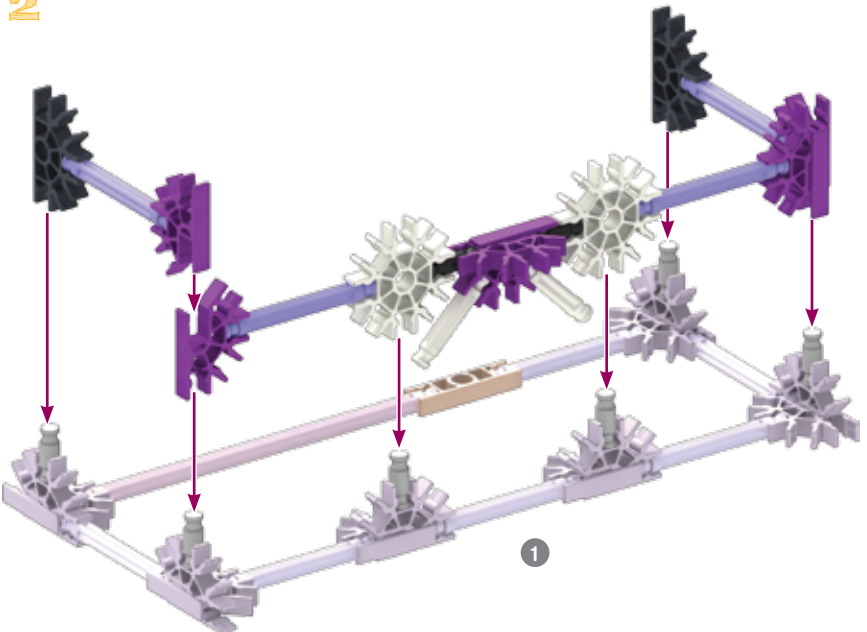

1

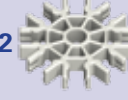
2



- 2  6  2 
- 4 
- 2  2 

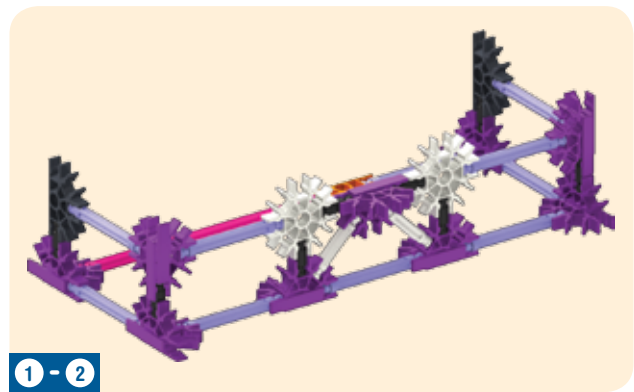

1 - 2

You built a ranch and a colonial style house, now let's build another type of house style called a brownstone.

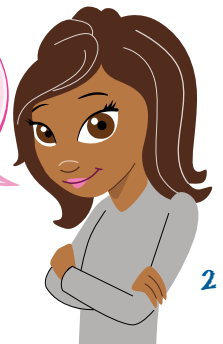

2

3

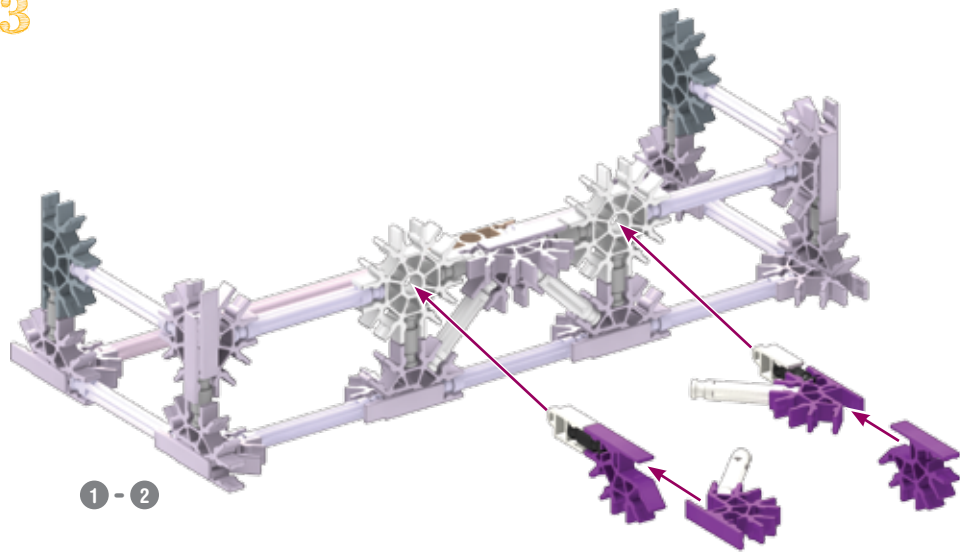

1-2

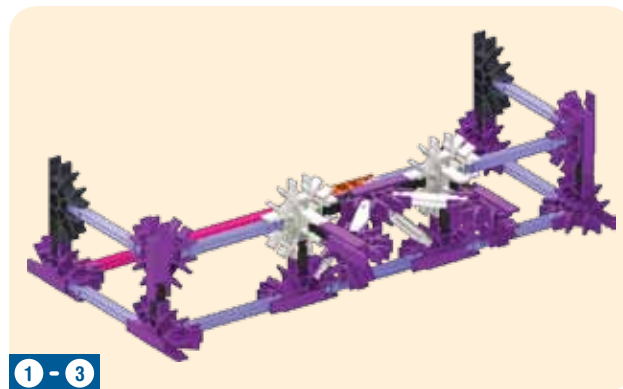

1-3

4

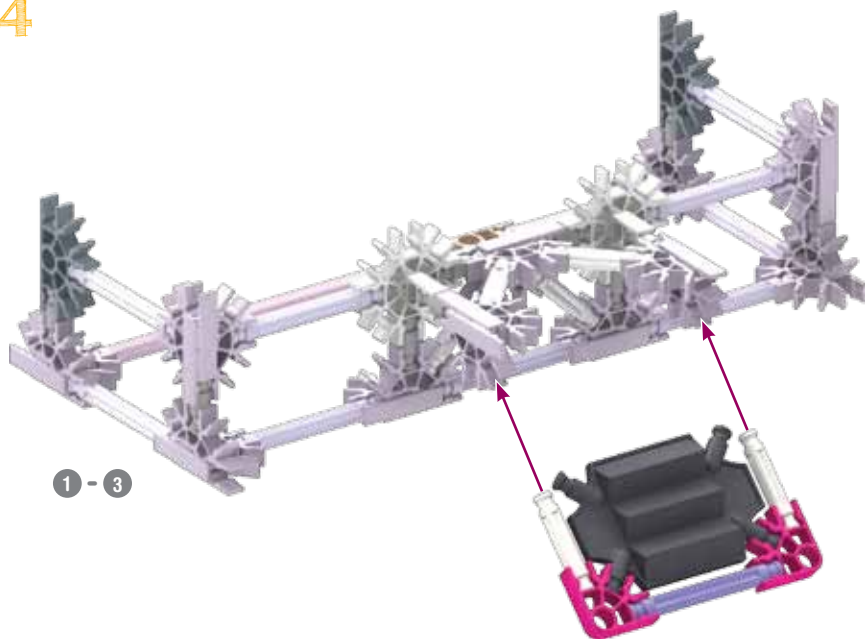

1-3

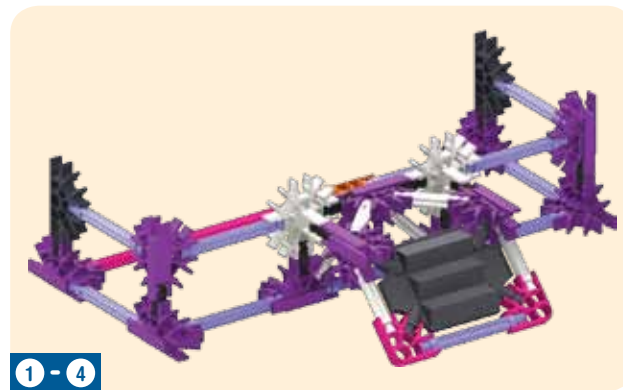
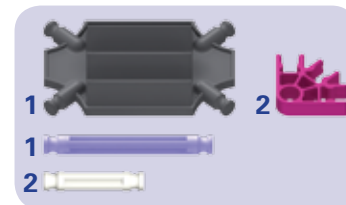

1-4

5

rotate model

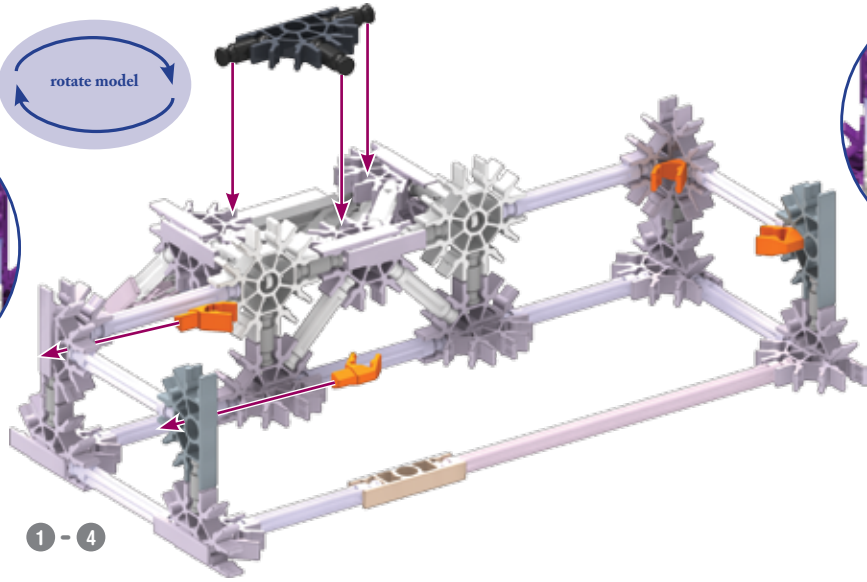
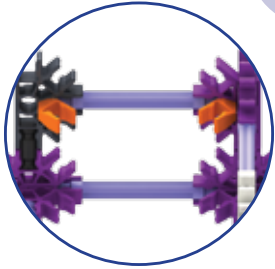

1 - 4

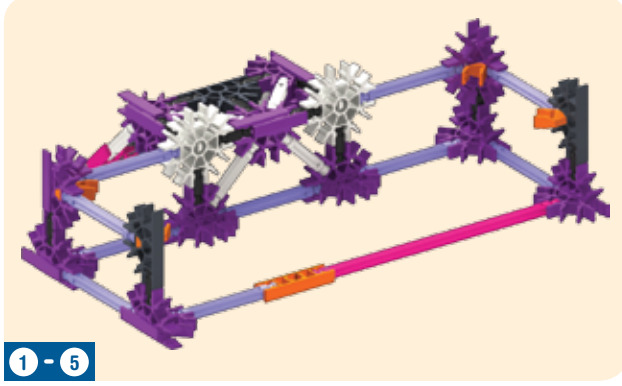
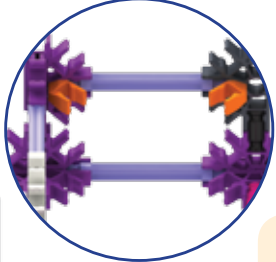

1 - 5

6

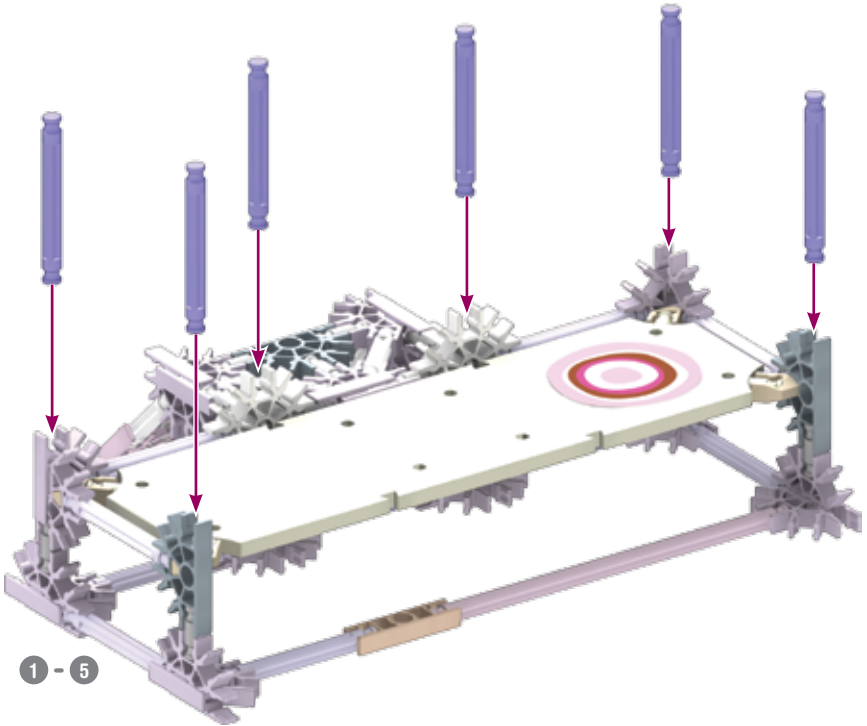

1 - 5

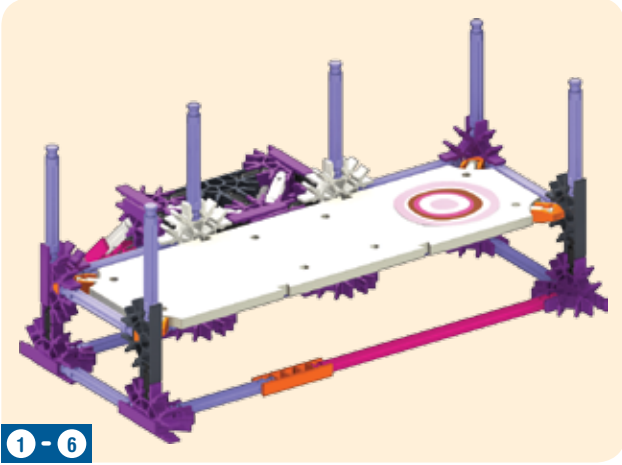

1 - 6

7

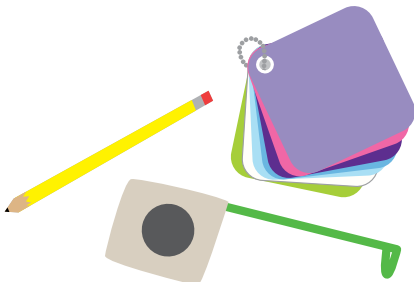
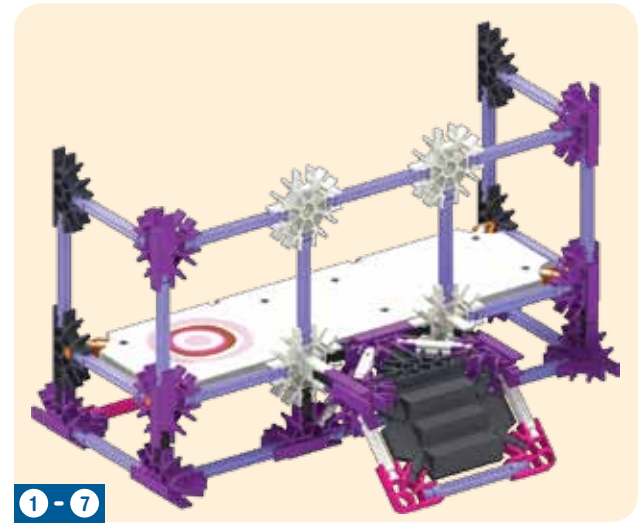
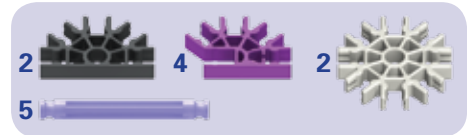
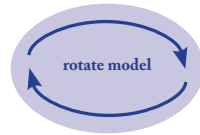
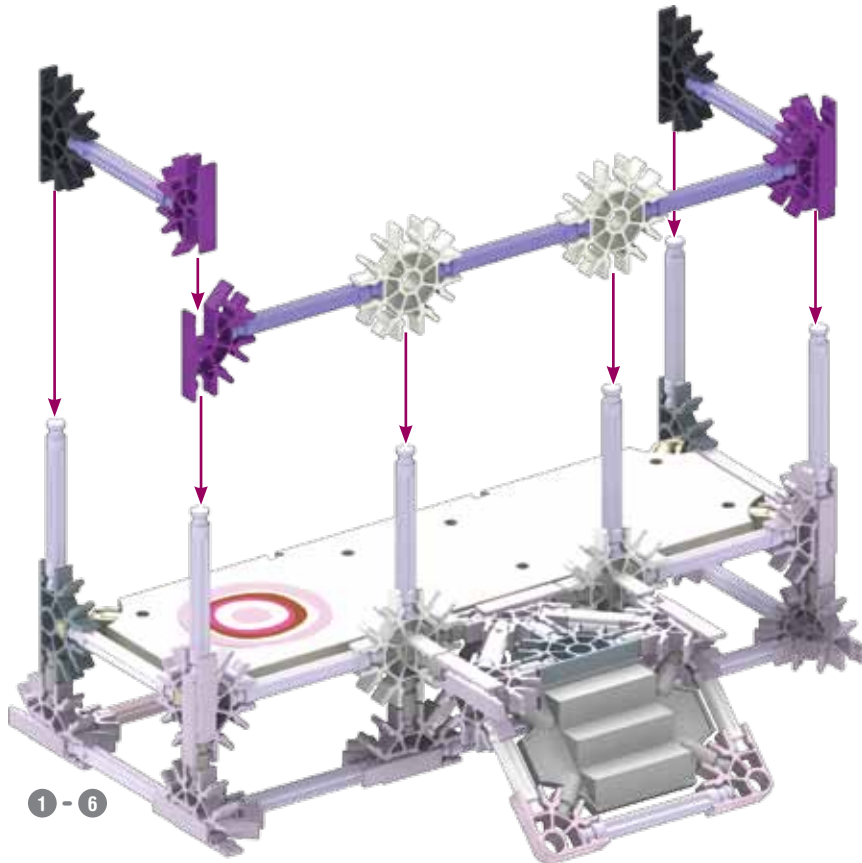

8

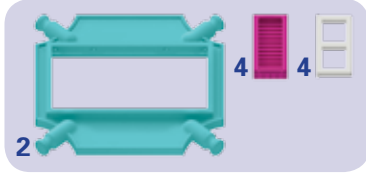
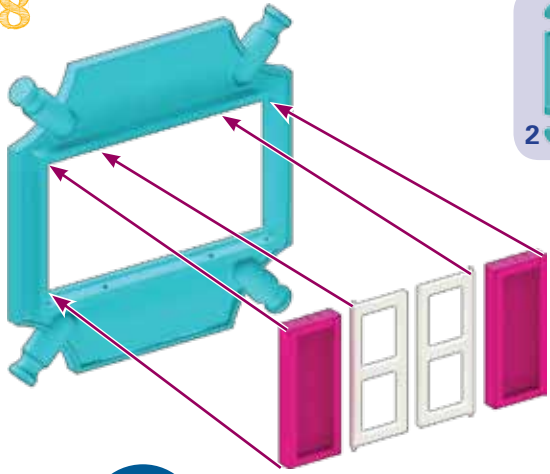

x2

x2

9

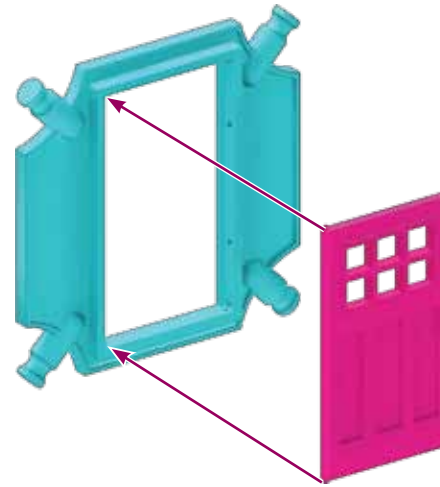

10

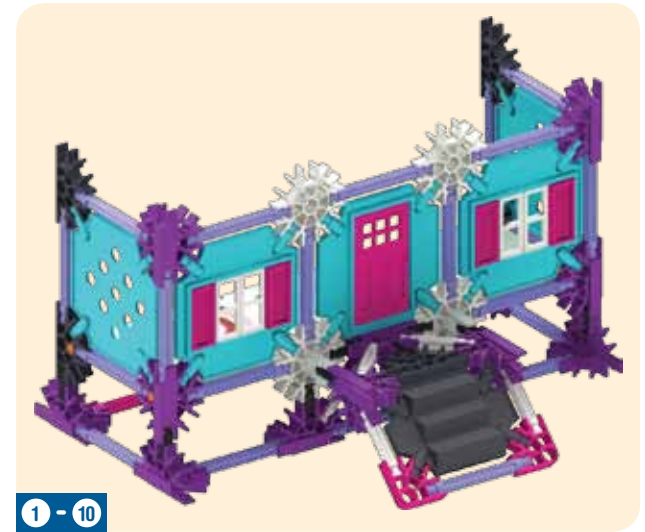
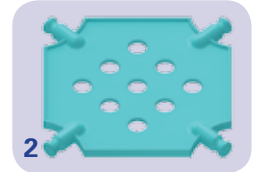
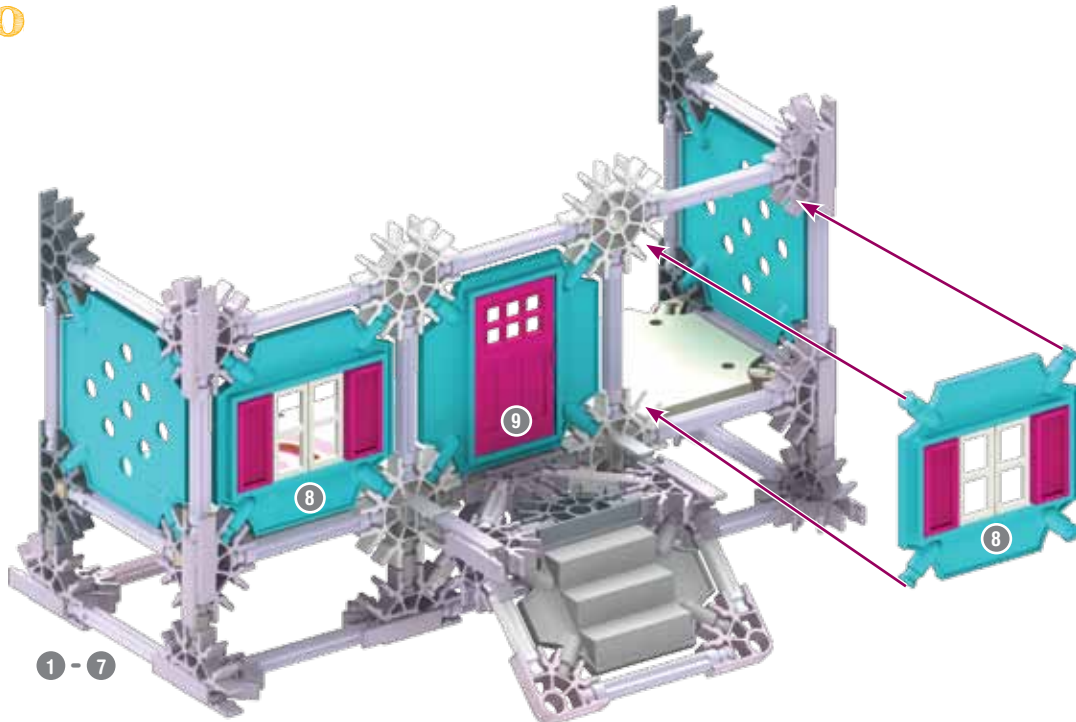

11

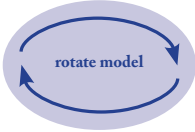

- 1
- 2
- 2
- 4



1 - 10

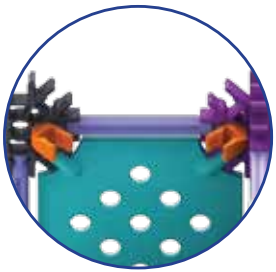

1 - 11

12



- 1
- 2
- 2



1 - 11



1 - 12

13

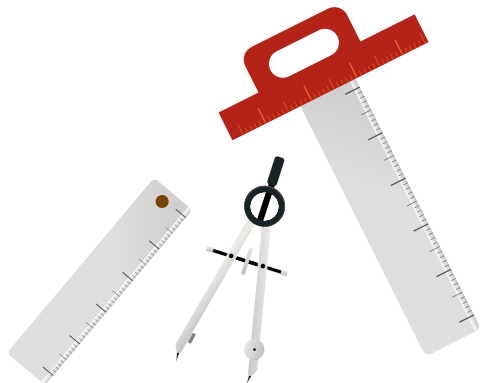
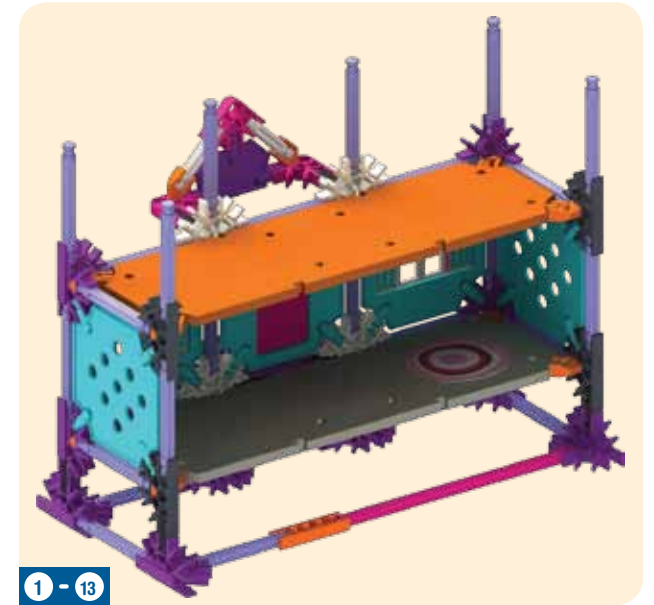
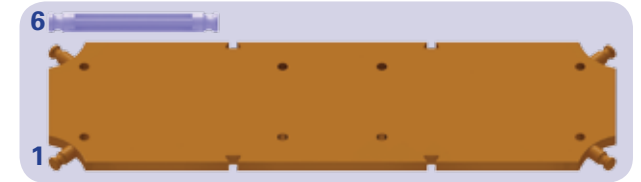
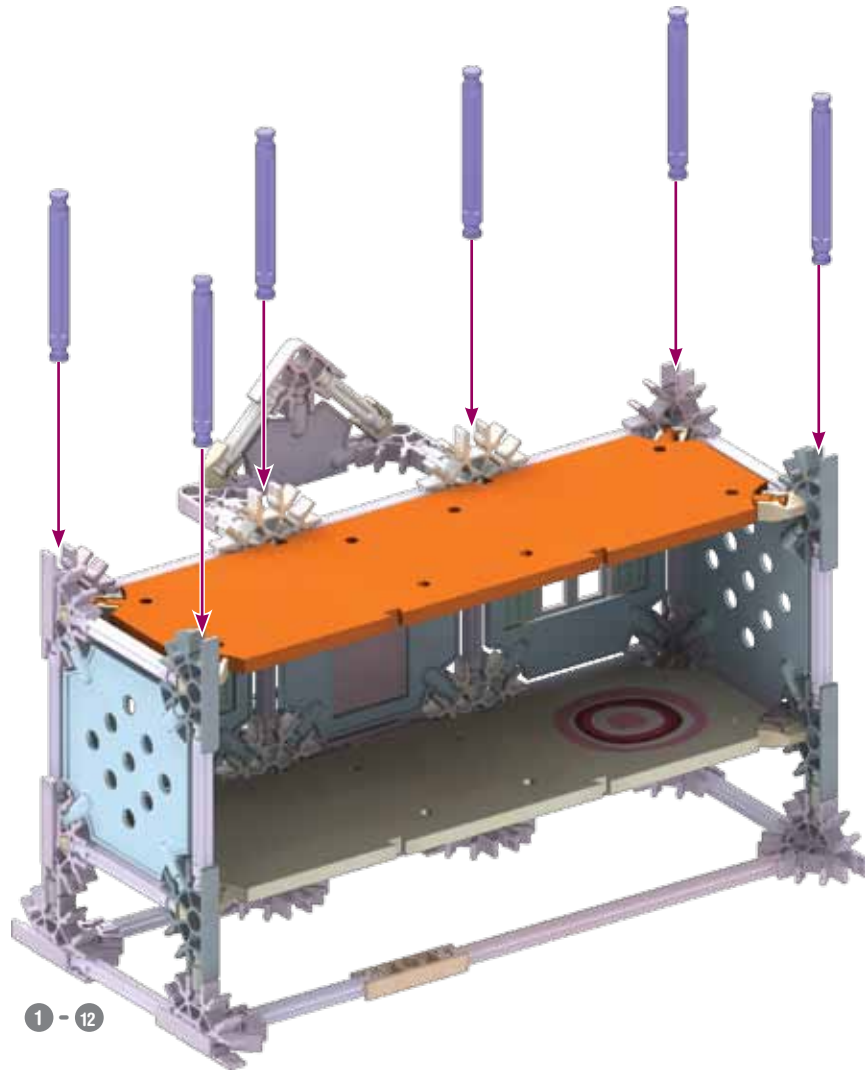

14

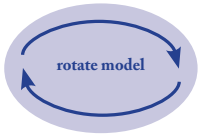

1 - 13

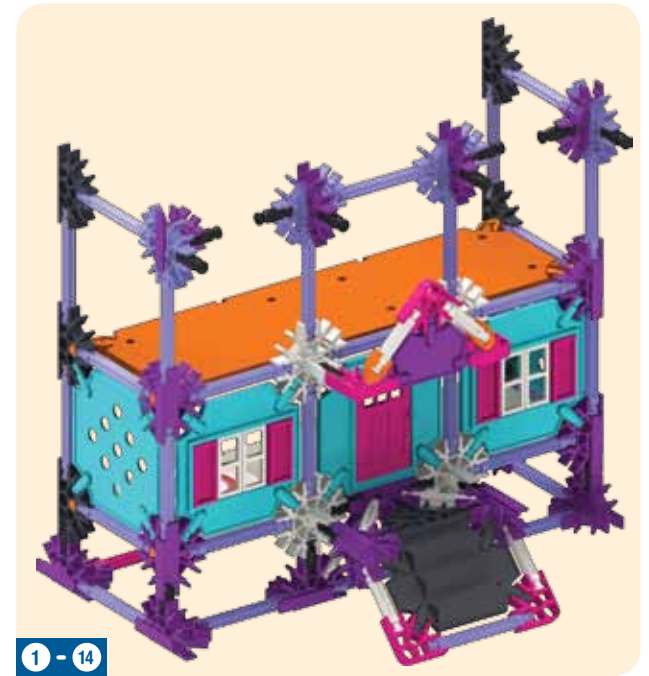
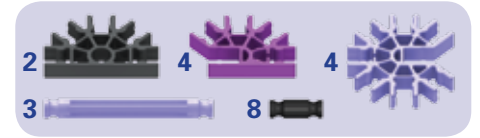
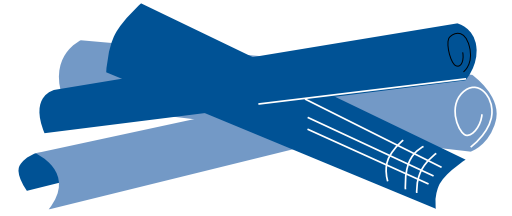

1 - 14

This label goes on the inside of this yellow panel. Go to page 20 for reference.



15

x2

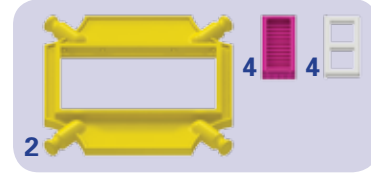
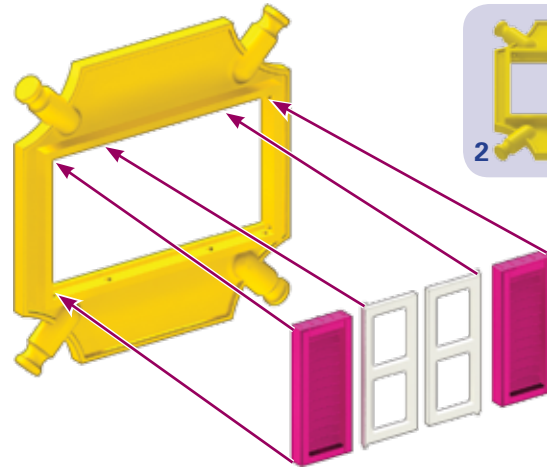

16

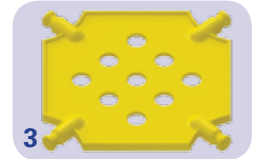
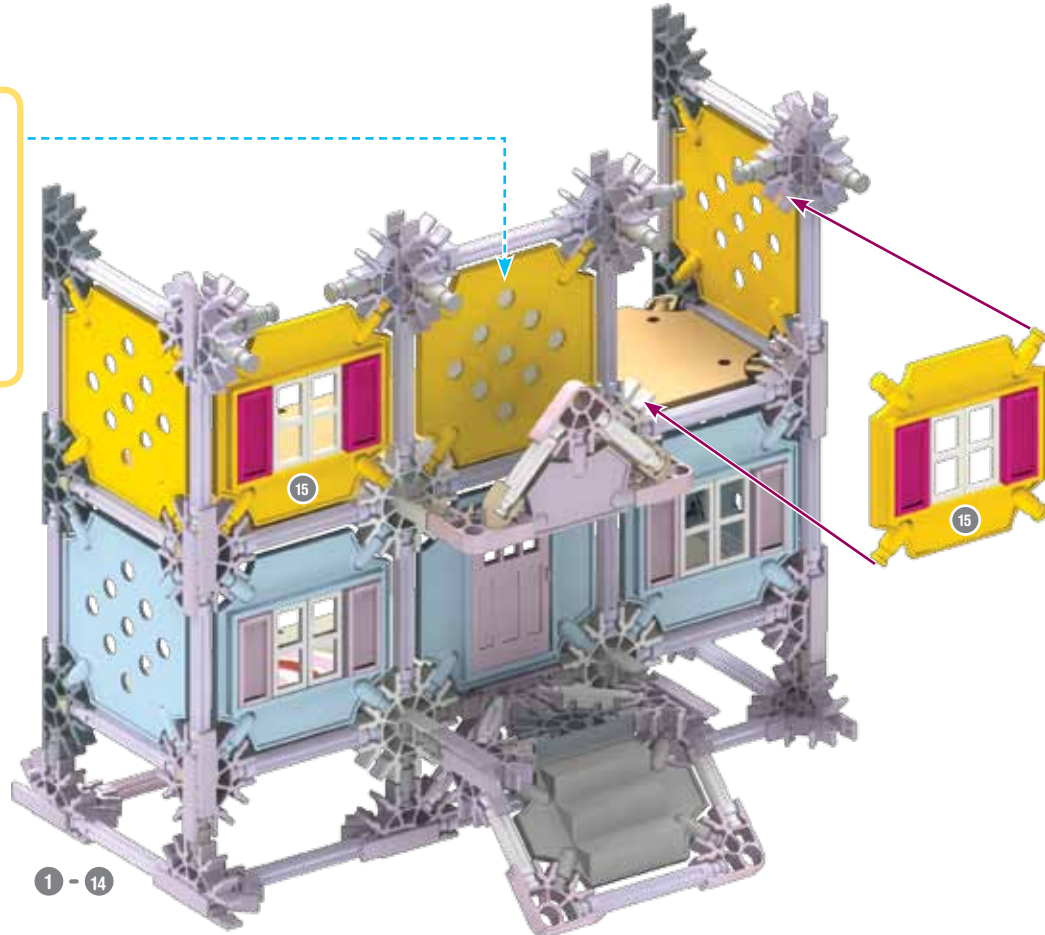
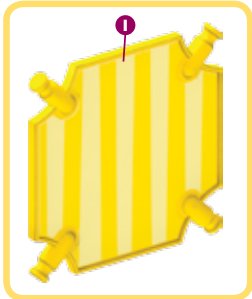

17

rotate model

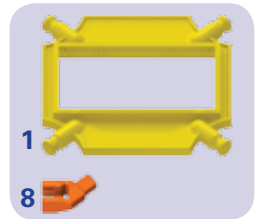
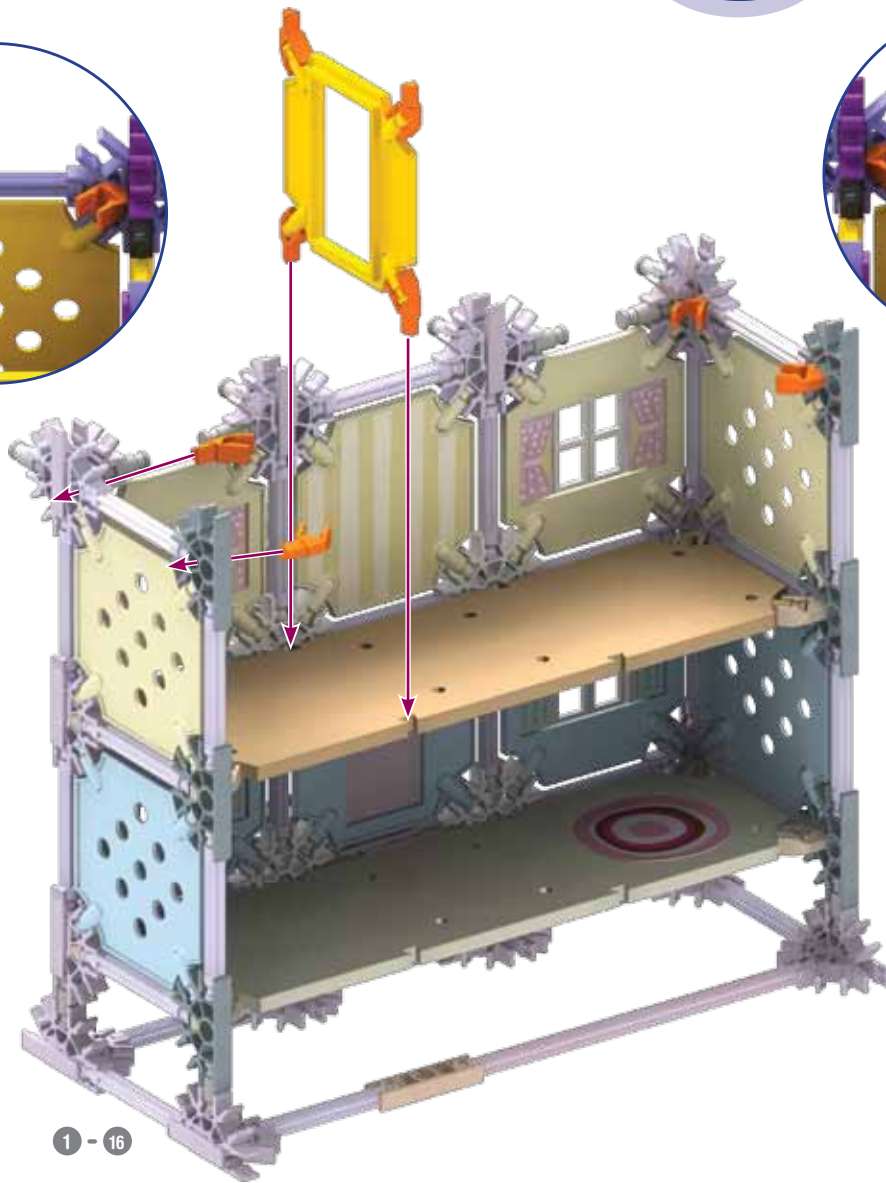
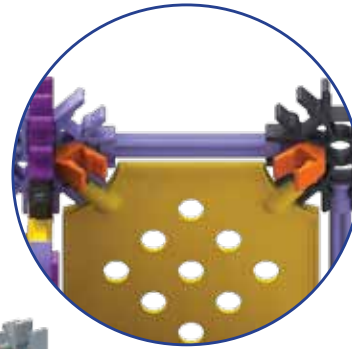
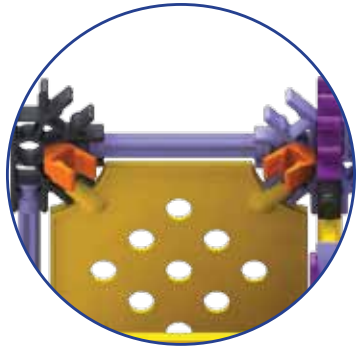

1 - 16



1 - 17

18



- 4
- 4
- 4
- 6



19

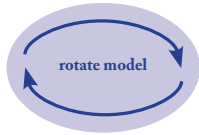

1 - 18



1 - 19



1 - 19

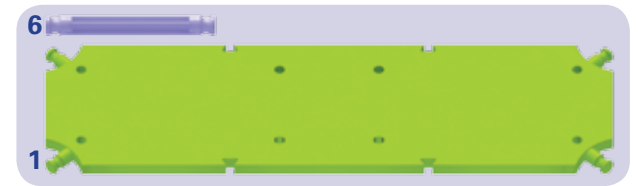

1 - 20

21



1 - 20

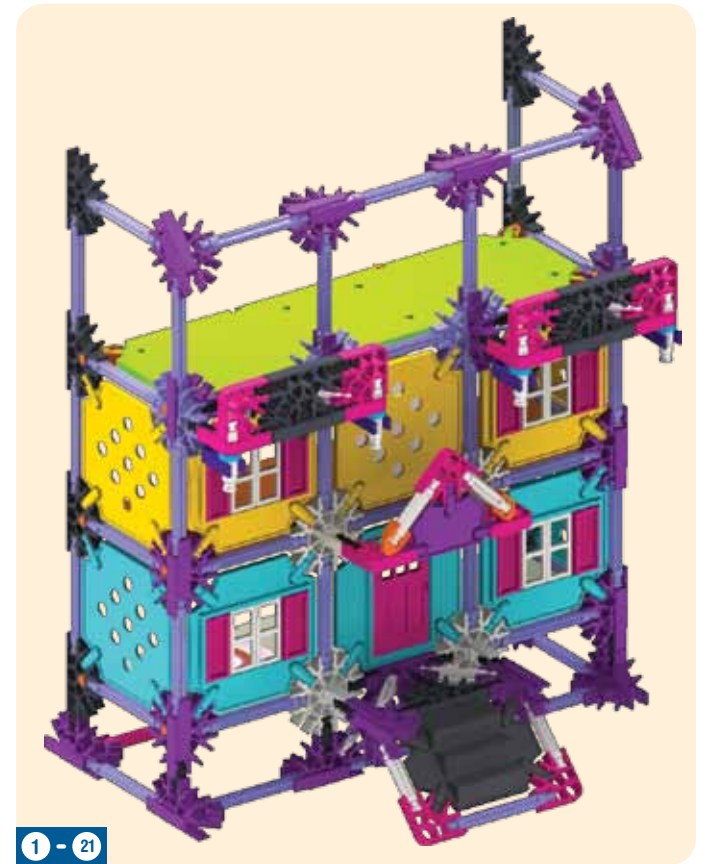
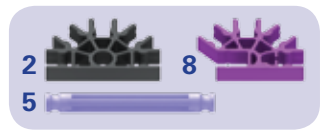

1 - 21

22

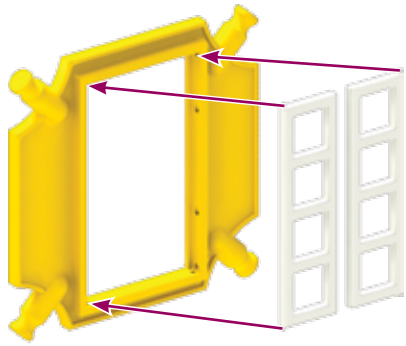

x2

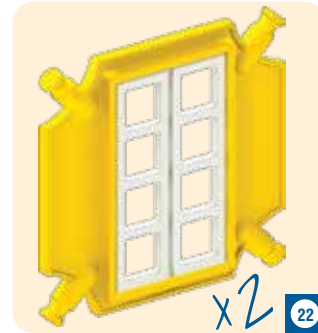
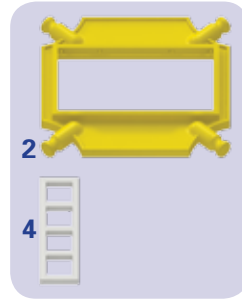

23

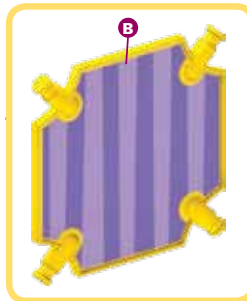
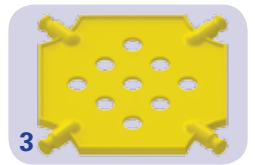
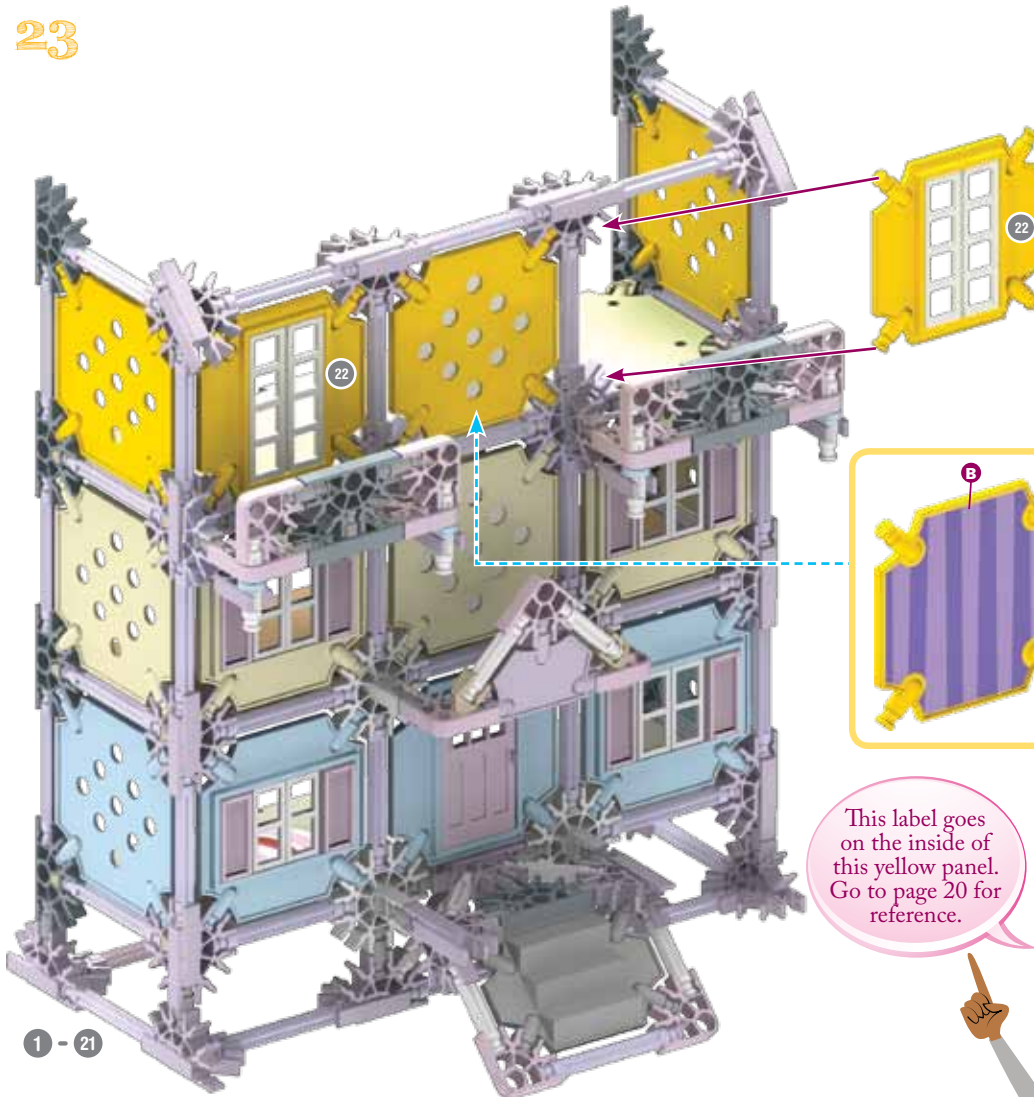

This label goes on the inside of this yellow panel. Go to page 20 for reference.



1 - 21

1 - 23

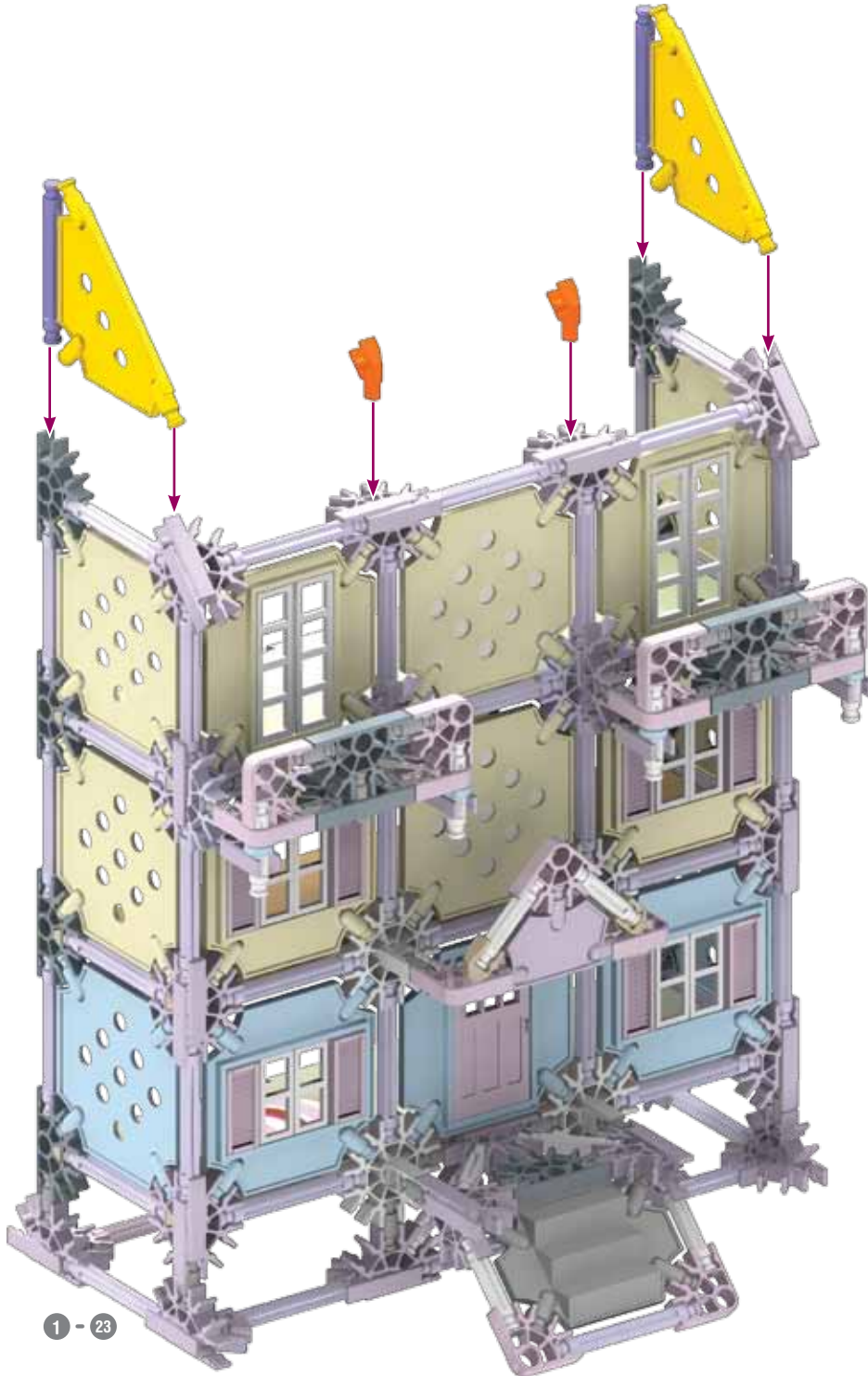

1 - 23

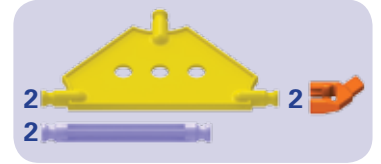
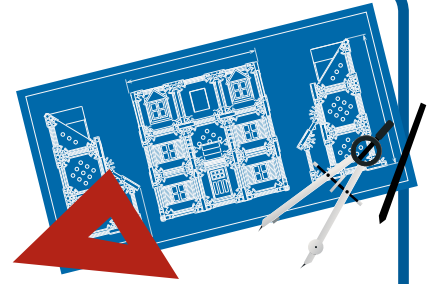
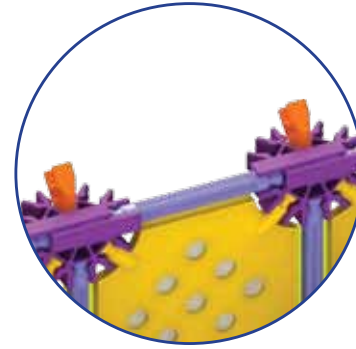

1 - 24

25

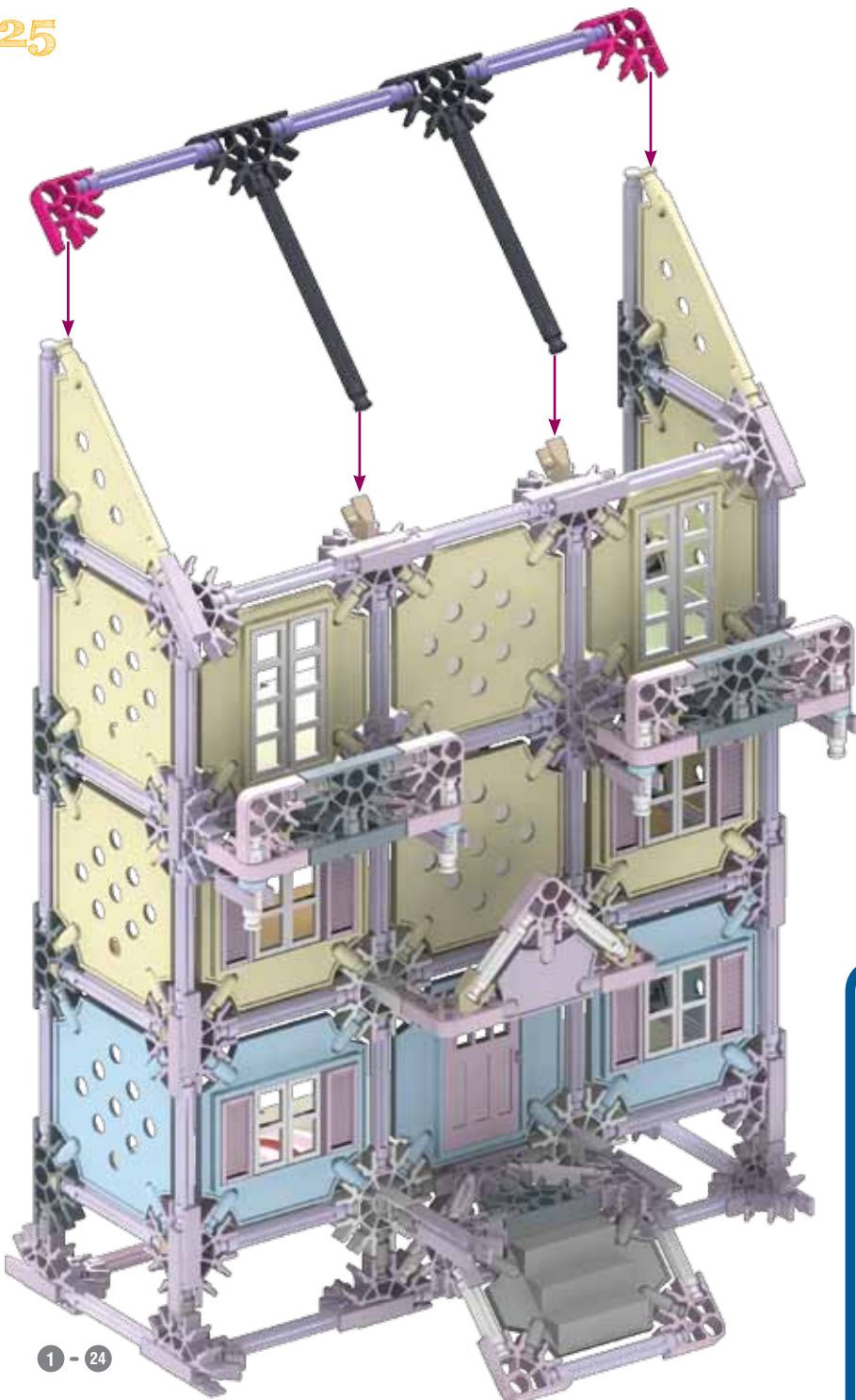
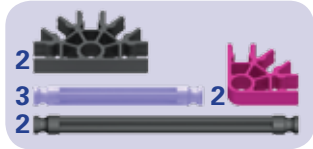

1 - 25

1 - 24

26

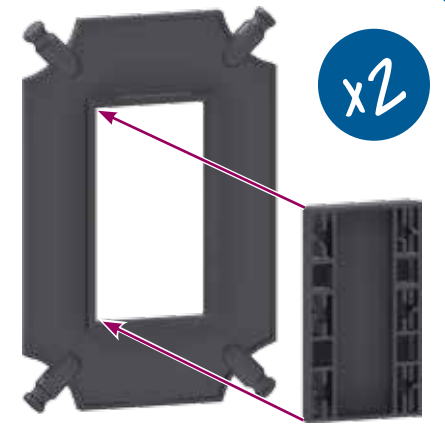
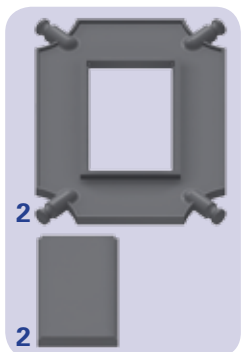

26

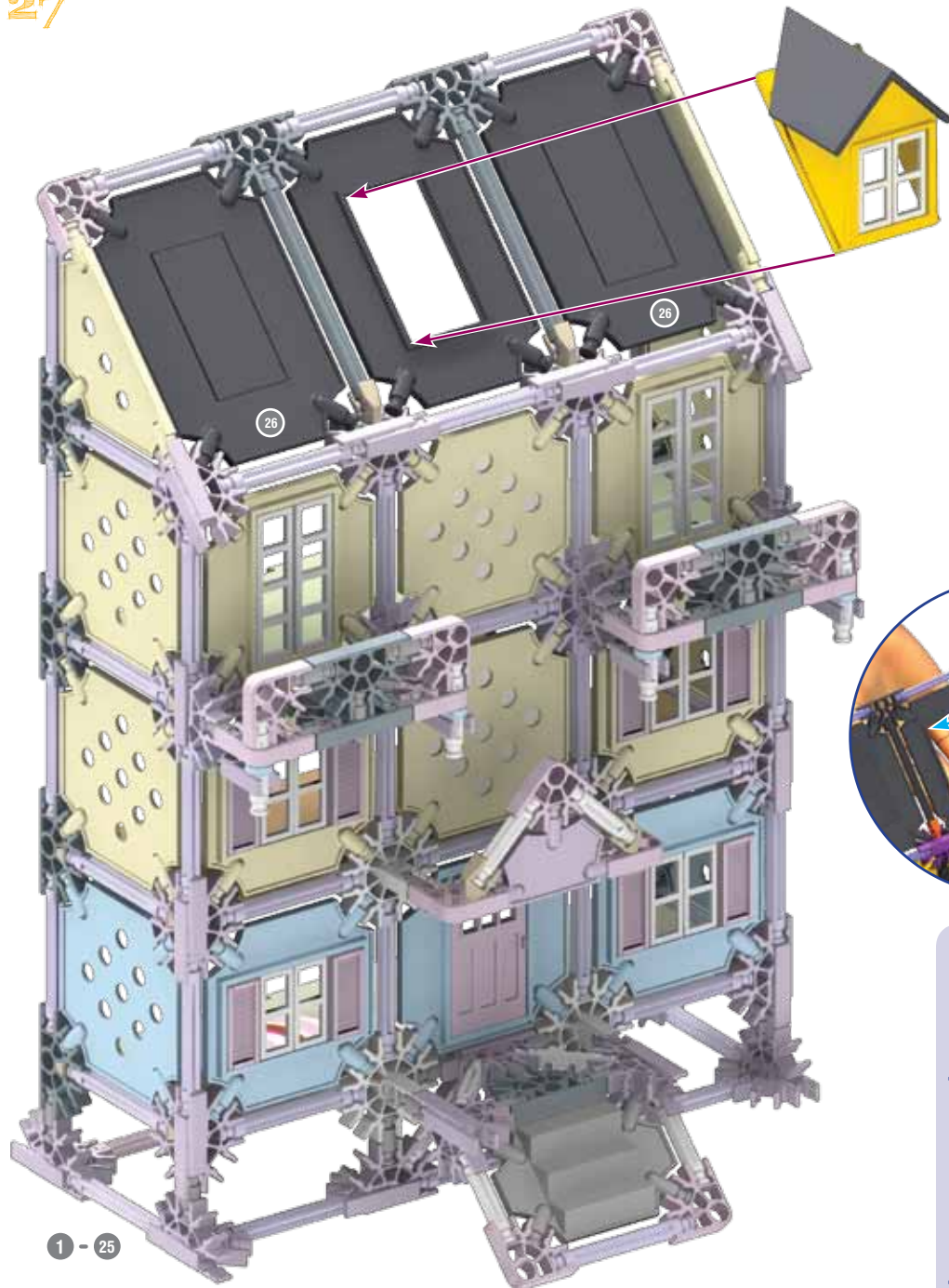

1 - 25

Snap the windows in from the back.

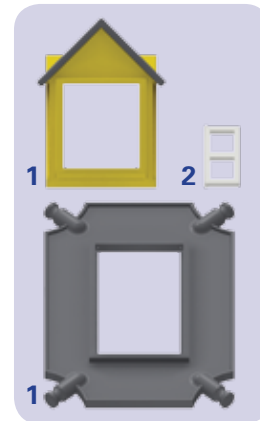
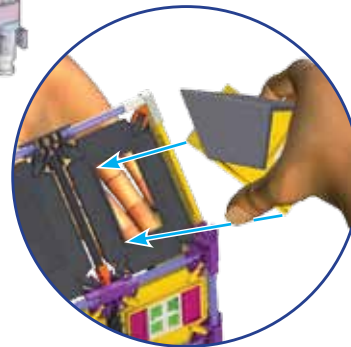
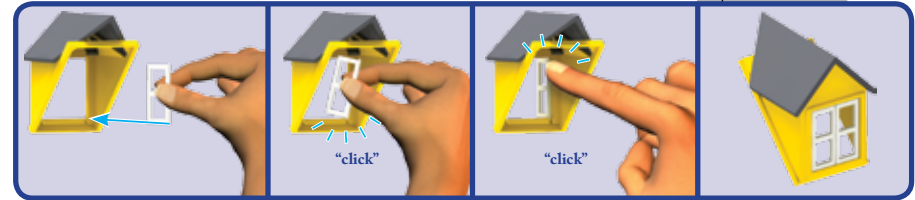

1 - 27



Awesome work building the brownstone. Do you think you could build other structures you see?

