

Home Designer
Concepteur
de la Maison

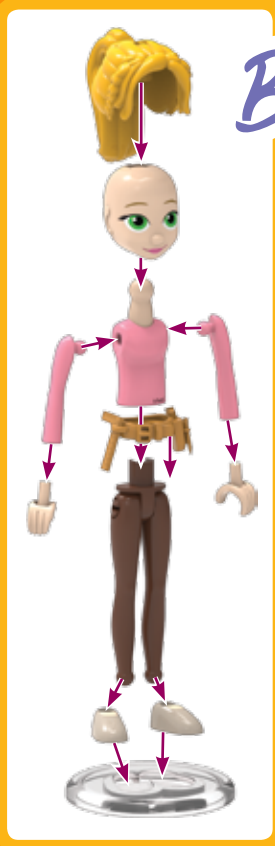

Meet Brianna & Sophia

Rencontrer Brianna et Sophia



Brianna

Brianna's favorite things!
Choses préférées de Brianna !

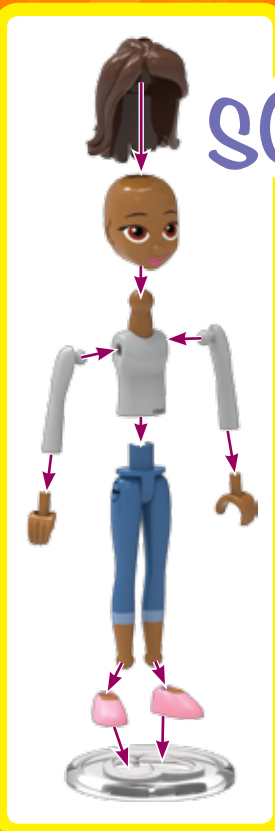

sophia

Sophia's favorite things!
Choses préférées de Sophia !





We love to design and build houses! Can you help us build our own homes?
 Nous aimons à concevoir et construire des maisons. Pouvez-vous nous aider
 à construire notre propre maison ?



Before we get started on our houses, let's learn how to build a strong structure. Grab your Mighty Makers® card to get started!

Avant de commencer sur nos maisons, nous allons apprendre à construire une structure solide. Prenez votre Mighty Makers® carte de commencer !





Now that we learned how to make a strong structure, let's get started building my ranch style house!

Maintenant que nous avons appris comment rendre une structure forte, nous allons commencer à construire ma maison de style ranch !

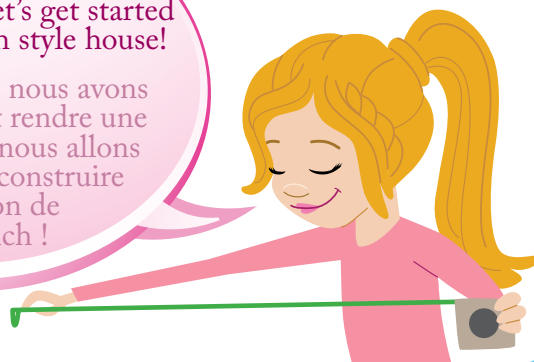

Brianna's house Maison de Brianna

1

- ☑ Apply stickers
- ☑ Appliquez des autocollants
- ☑ Aplicar pegatinas
- ☑ Bringe die Aufkleber an
- ☑ Applicare gli adesivi
- ☑ Aplicar adhesivos
- ☑ Stickers plakken

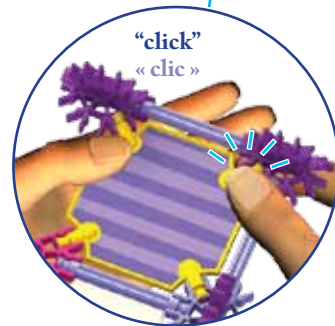
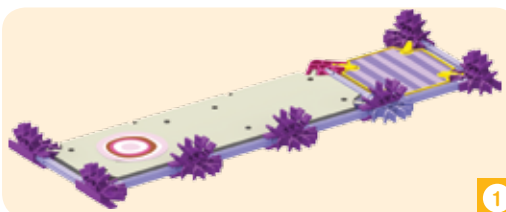
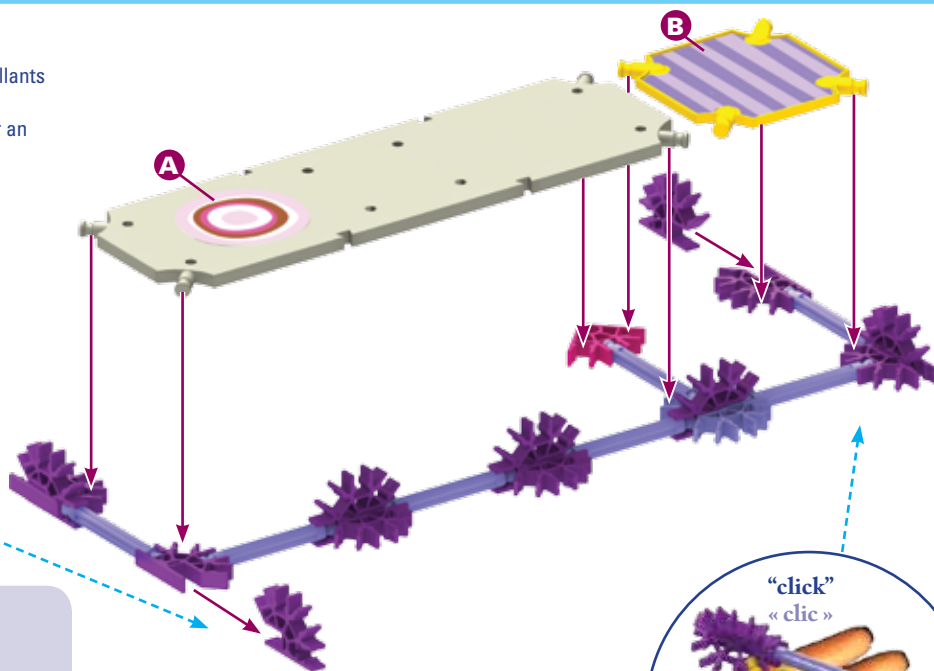
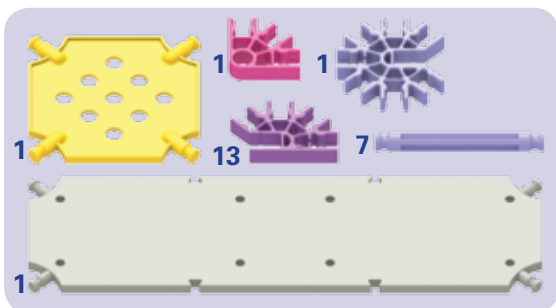
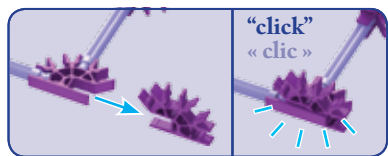

2

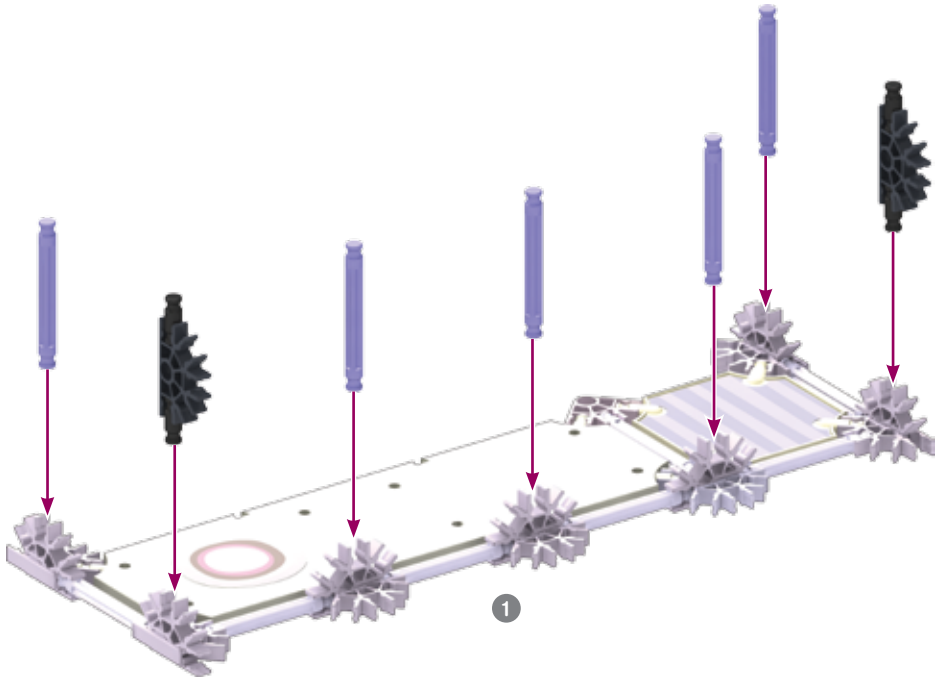
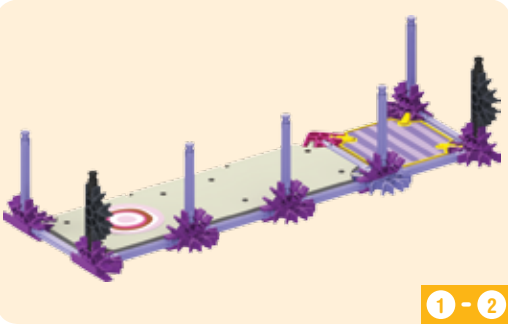
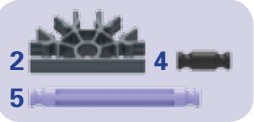

3

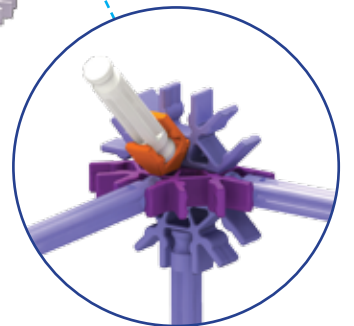
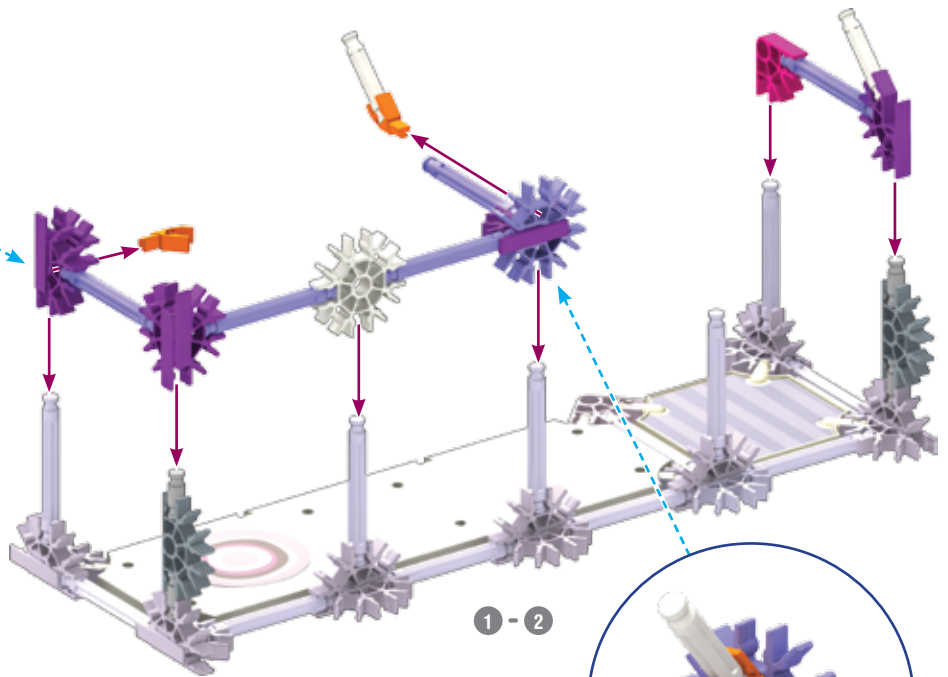
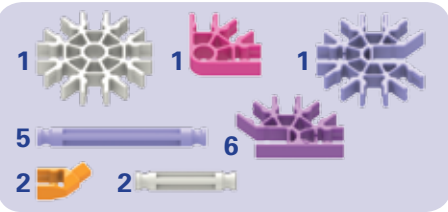

4

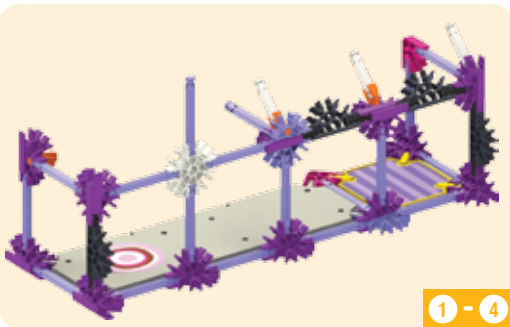
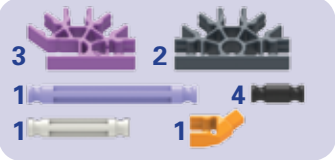
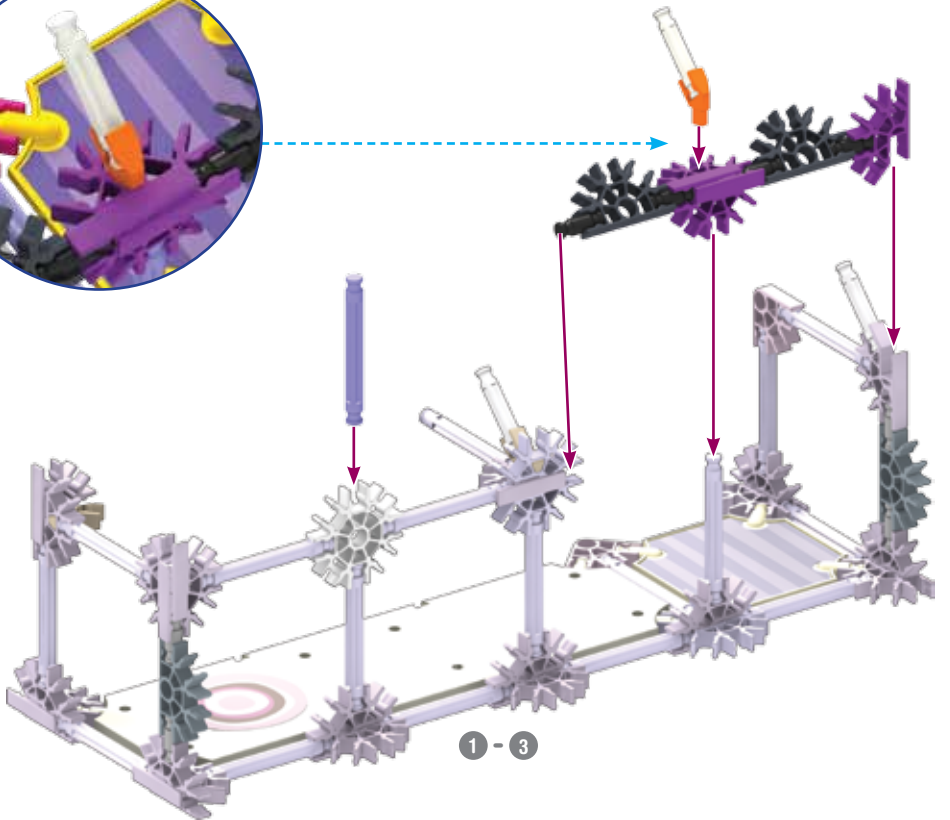

1 - 4

1 - 3

5

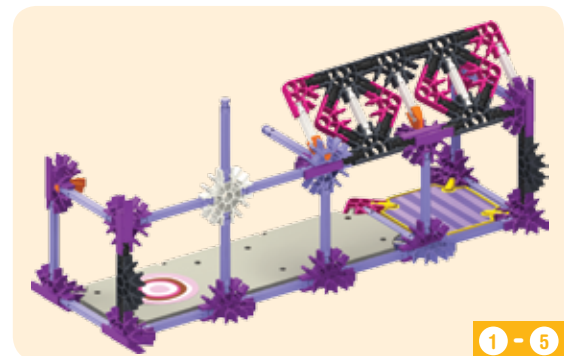
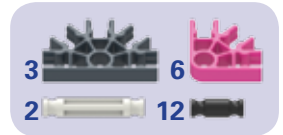
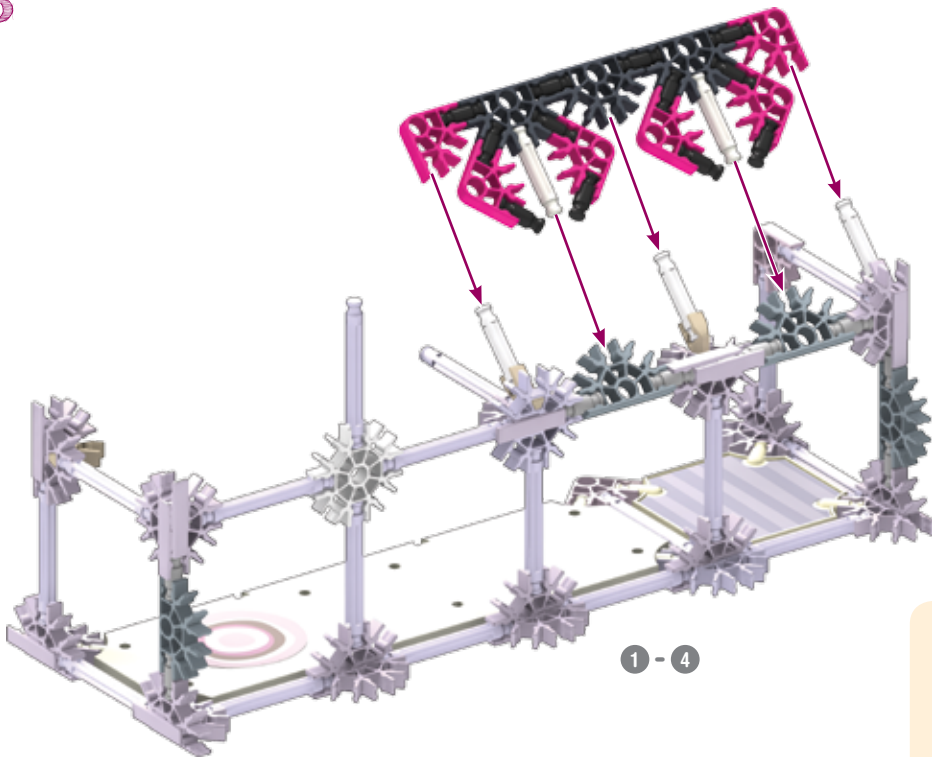
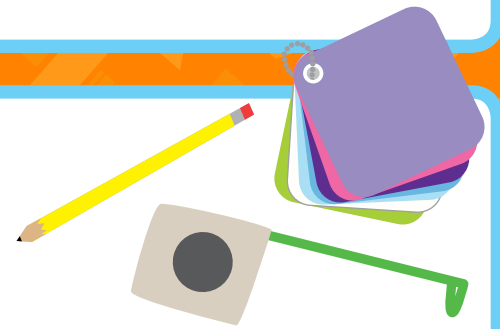

1 - 4

1 - 6

6

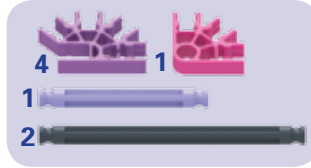
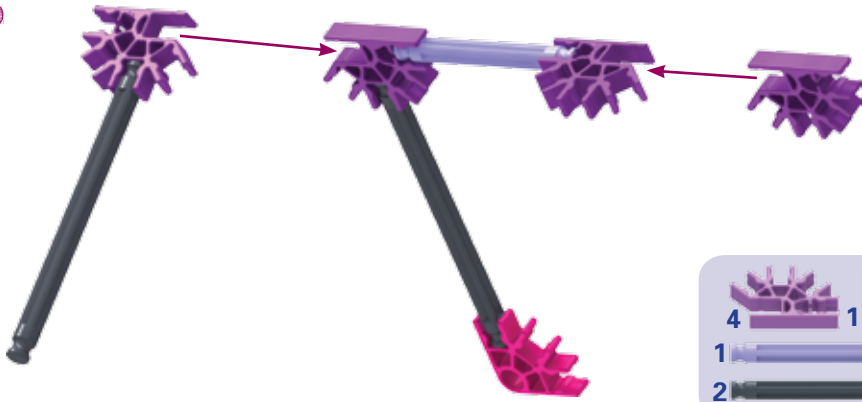

6

7

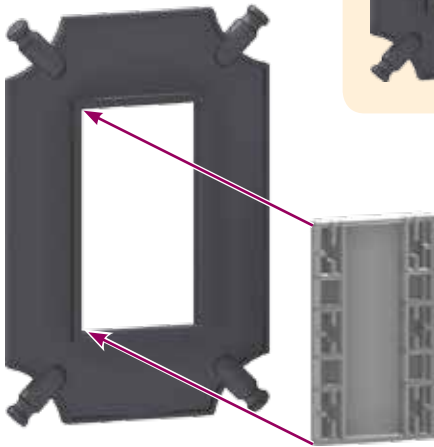
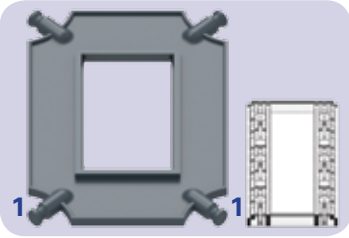

7

8

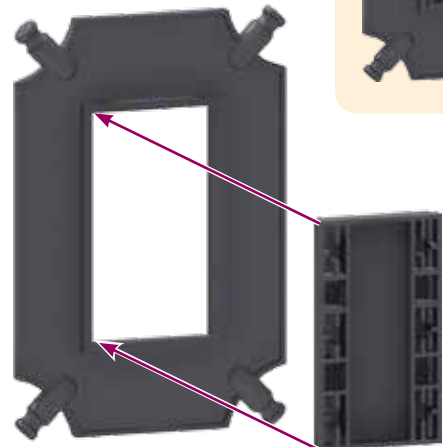
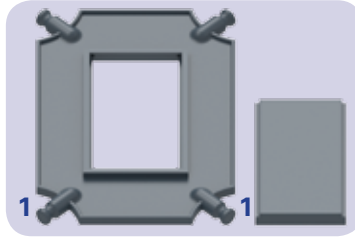

8

9

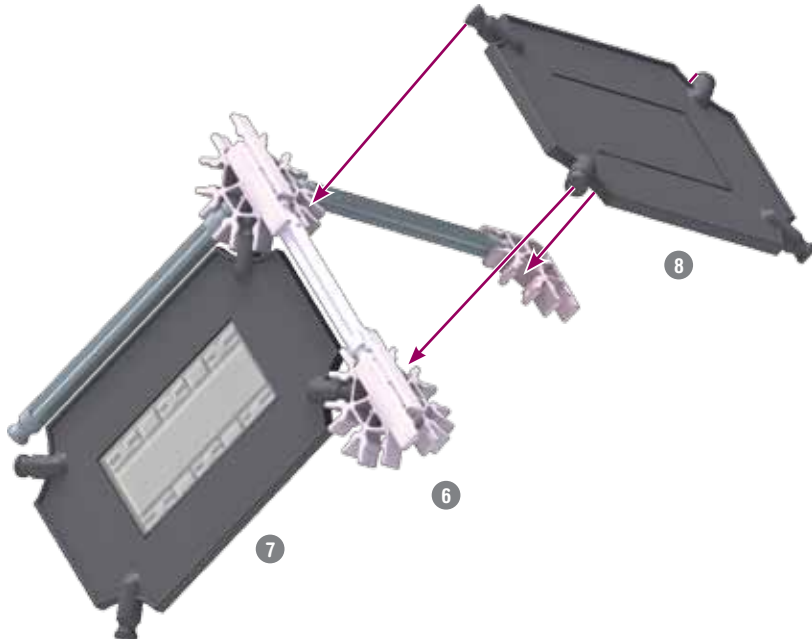

6 - 9

10

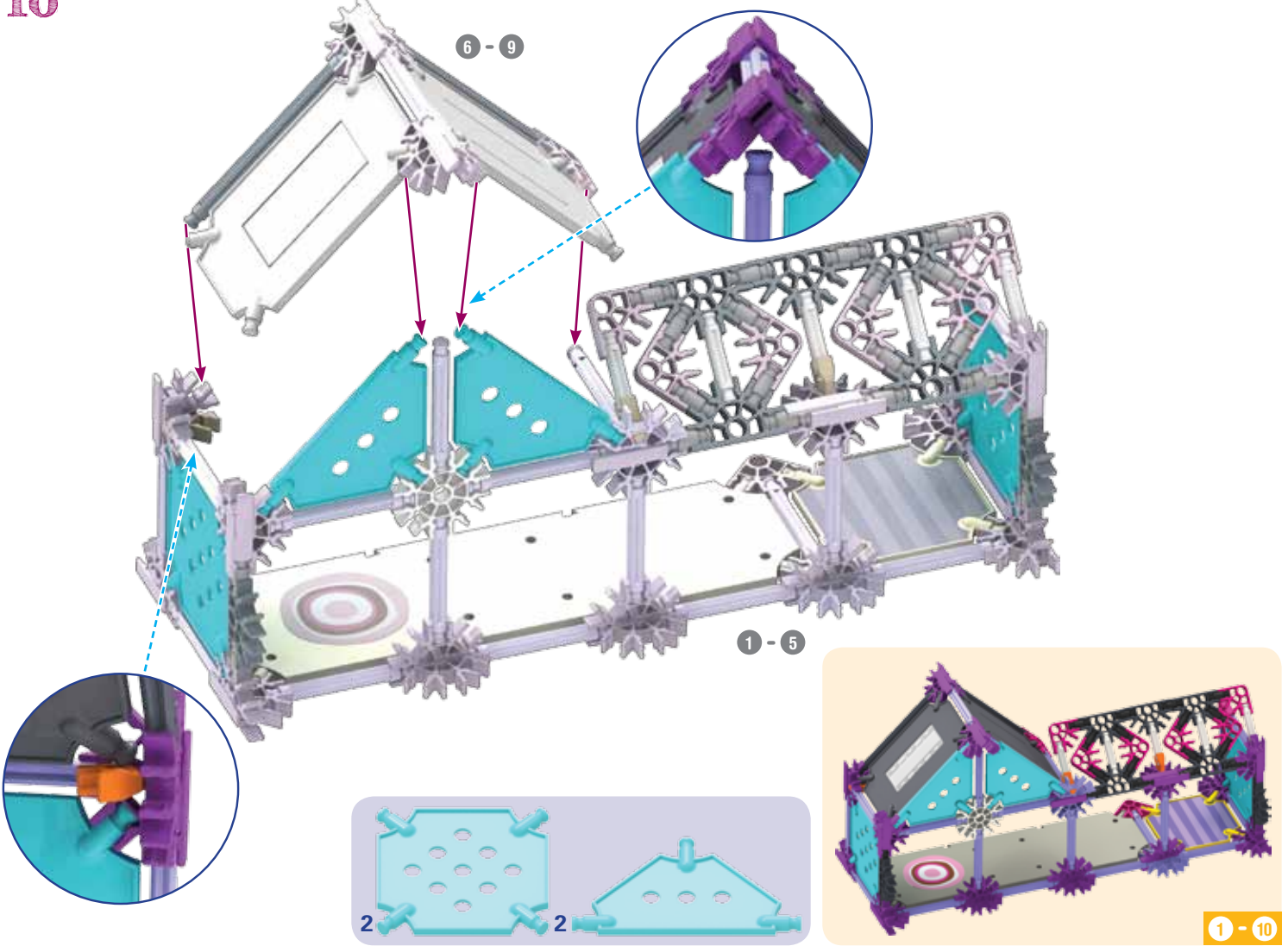

11

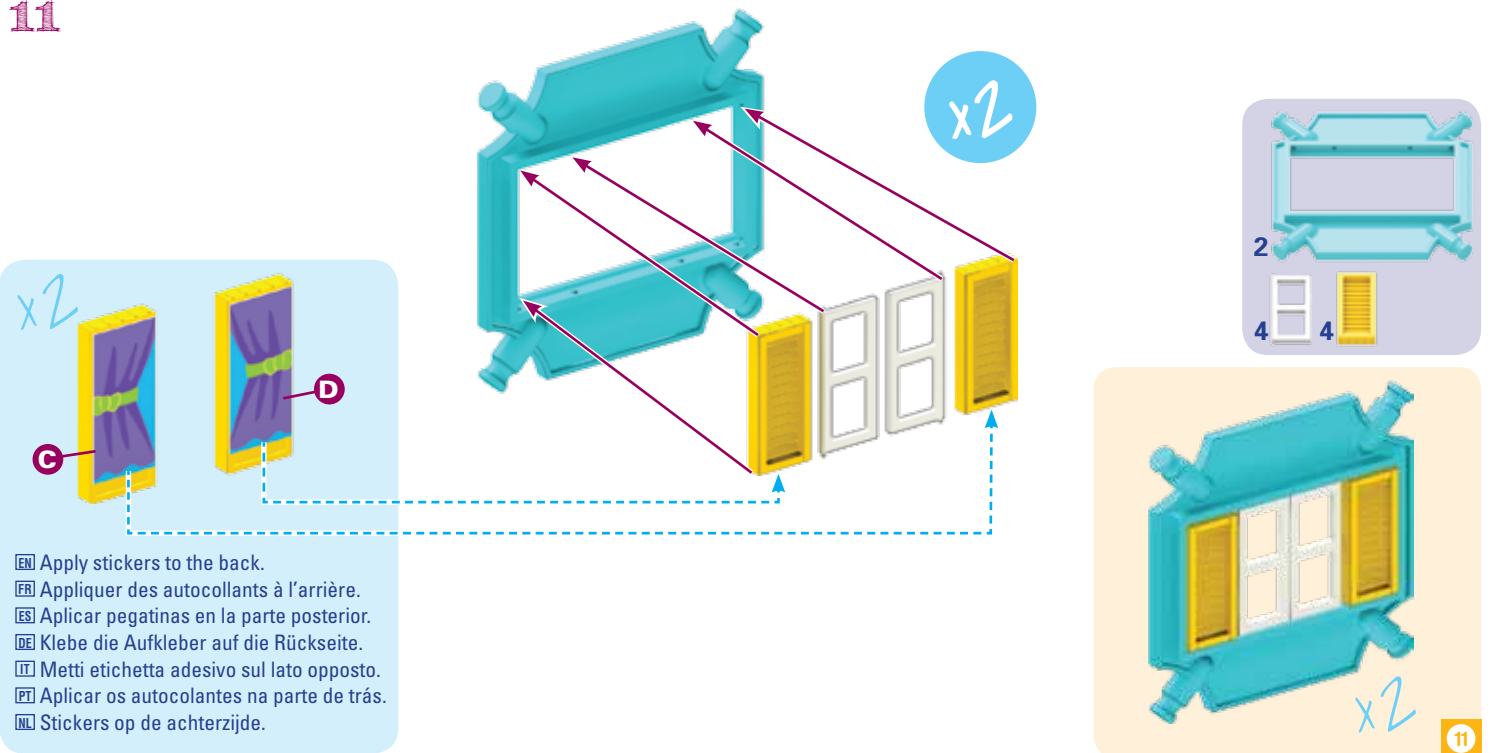

- Apply stickers to the back.
- Appliquer des autocollants à l'arrière.
- Aplicar pegatinas en la parte posterior.
- Klebe die Aufkleber auf die Rückseite.
- Metti etichetta adesivo sul lato opposto.
- Aplicar os autocolantes na parte de trás.
- Stickers op de achterzijde.

12

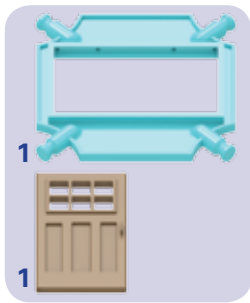
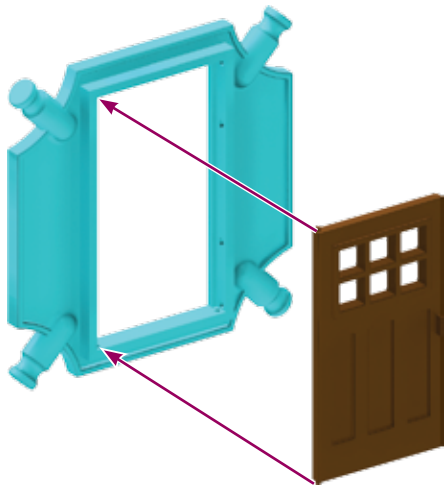

13

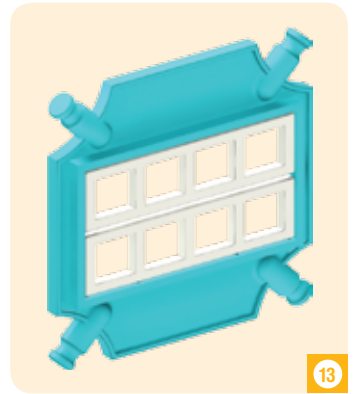
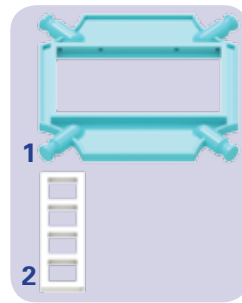
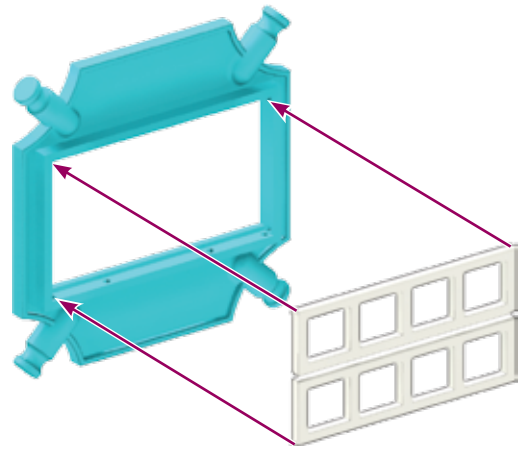

14

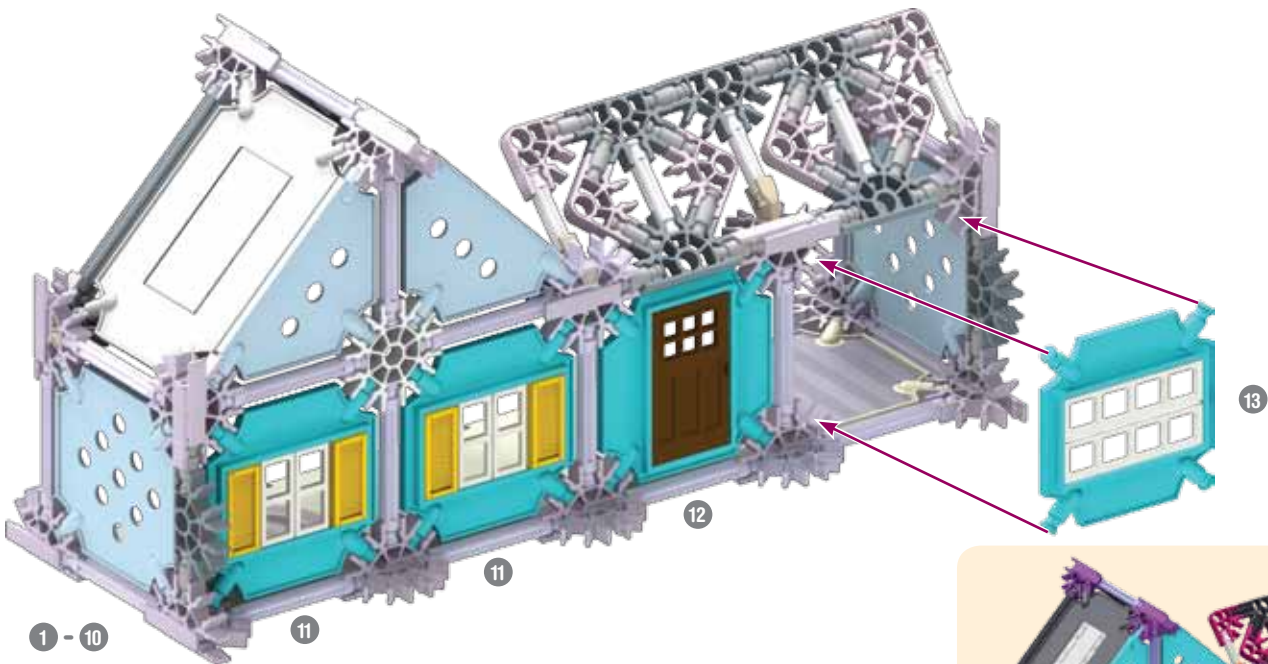

15

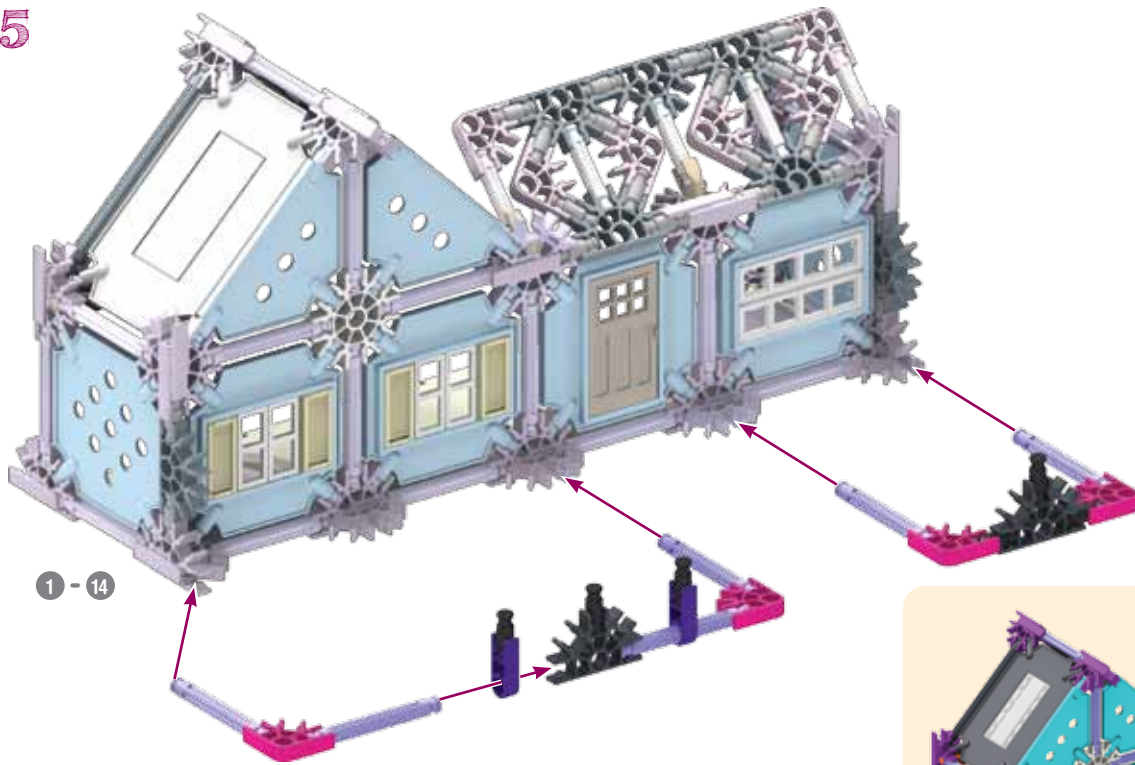

1 - 14

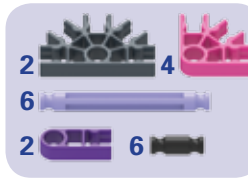

1 - 15

16



1 - 15

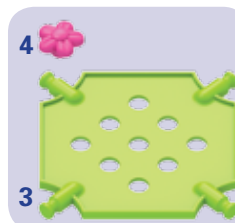

1 - 16

17

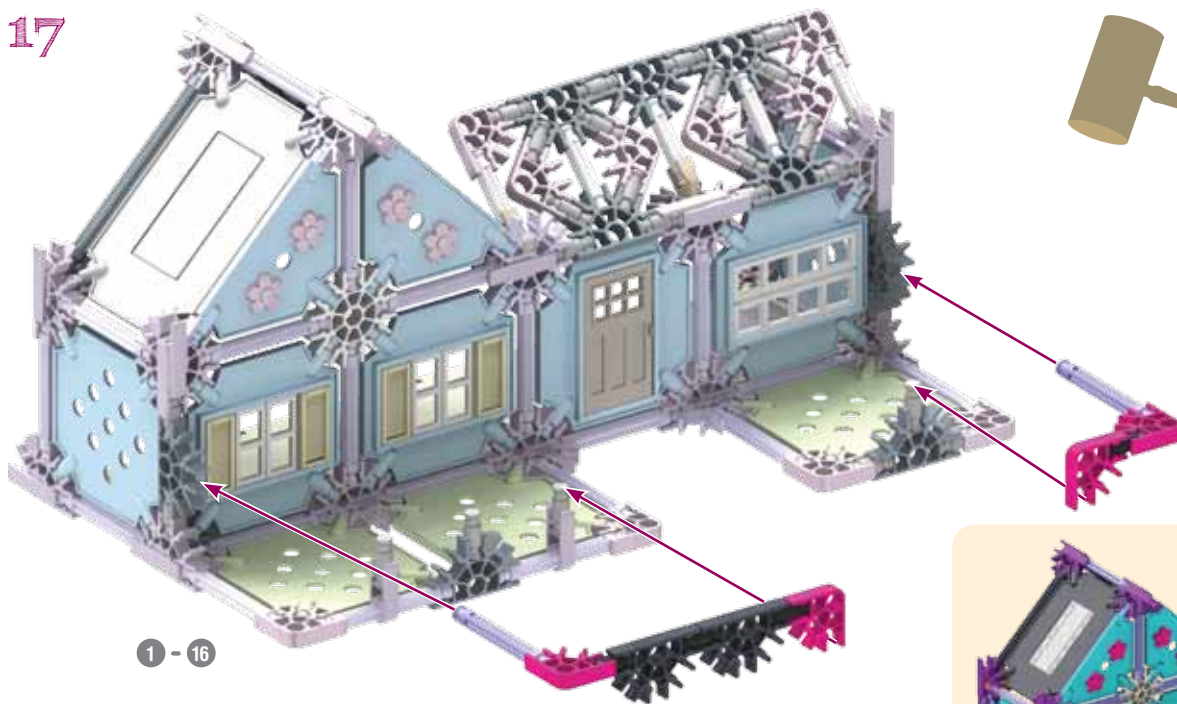

1 - 16

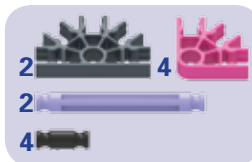

1 - 17

18

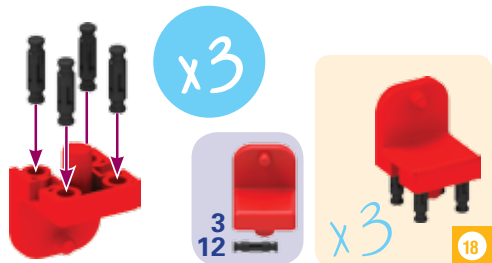

x3

3
12

x3

18

19

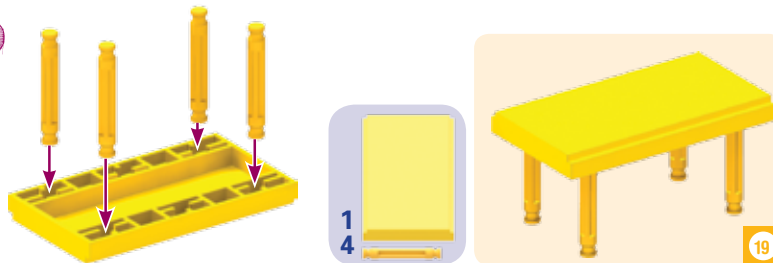

1
4

19





Great job helping Brianna! Now let's keep building by constructing my colonial style house.

Bon travail en aidant Brianna ! Continuons maintenant à bâtir en construisant ma maison de style colonial.



Sophia's house Maison de Sophia

1

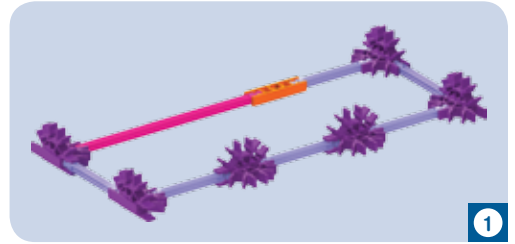
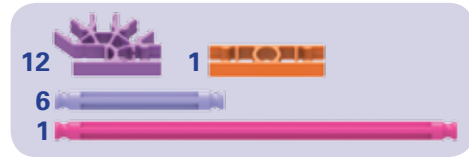
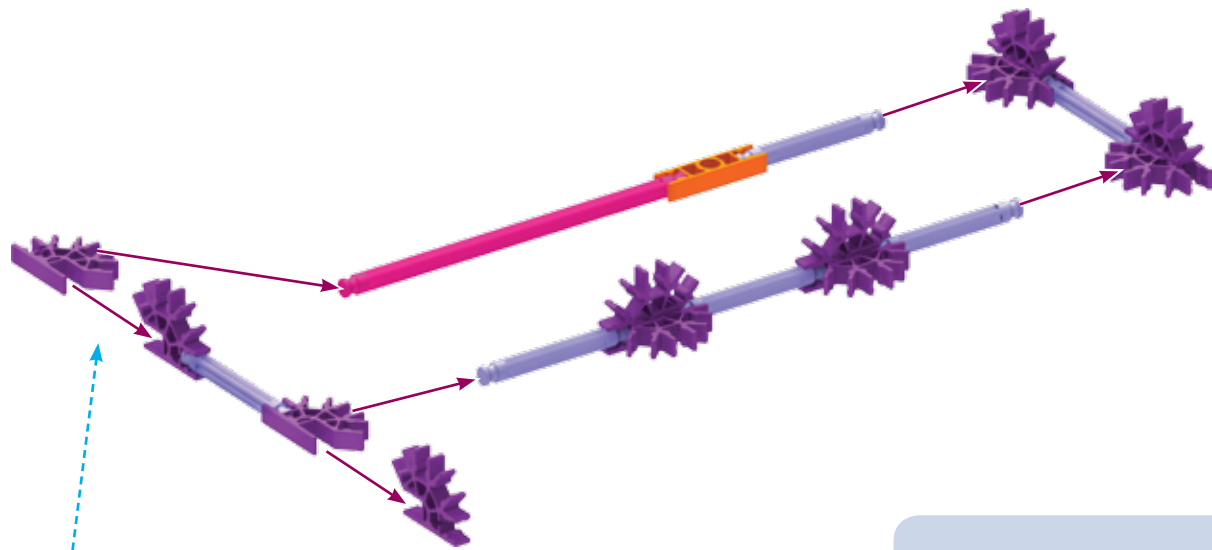

2

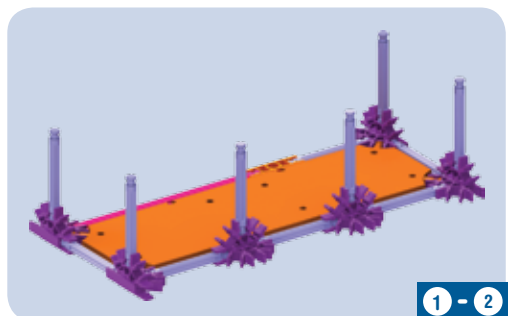
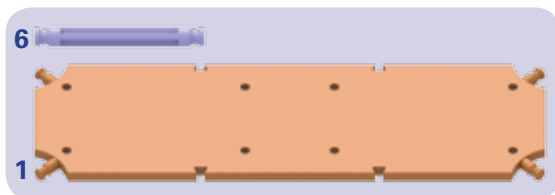
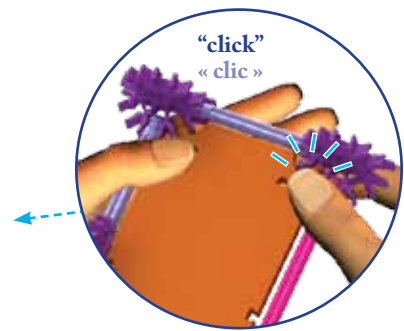
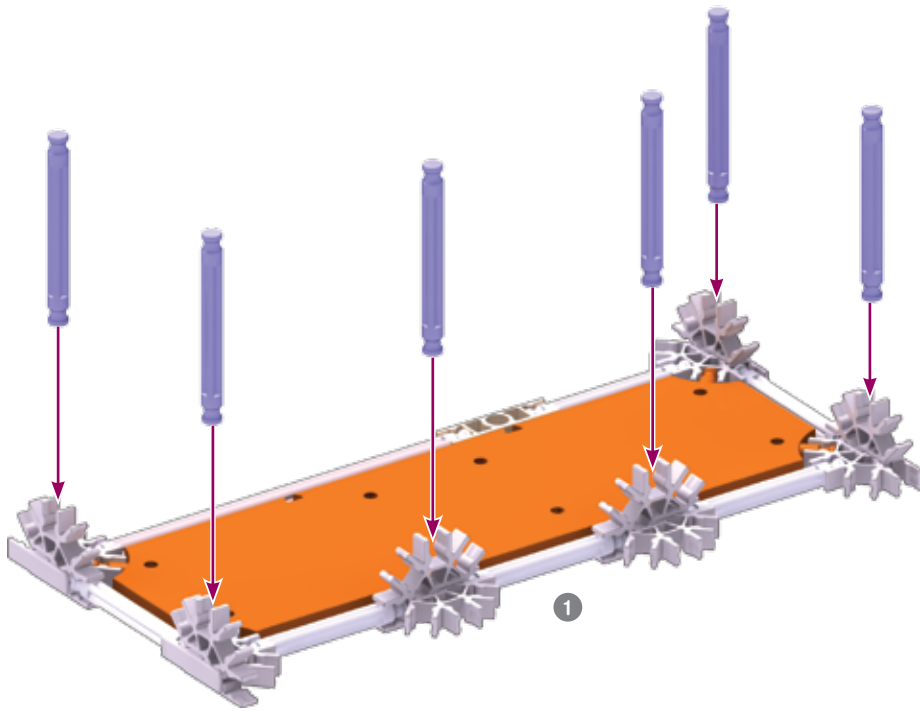

3

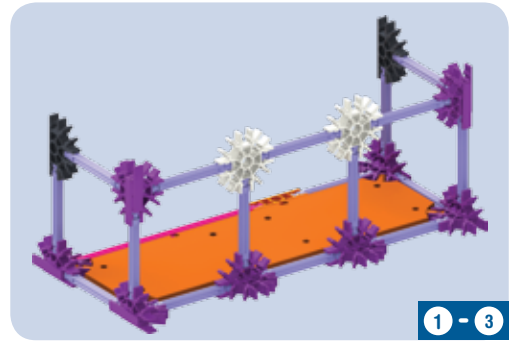
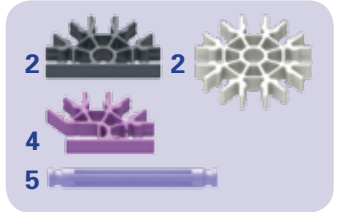
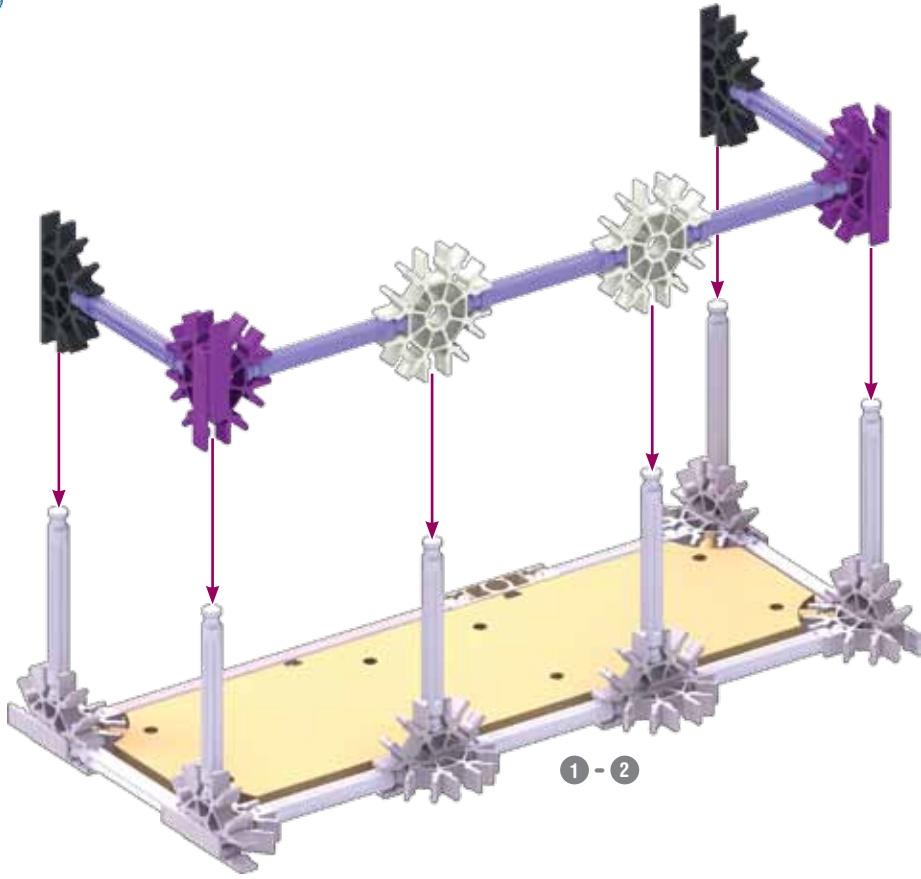

4

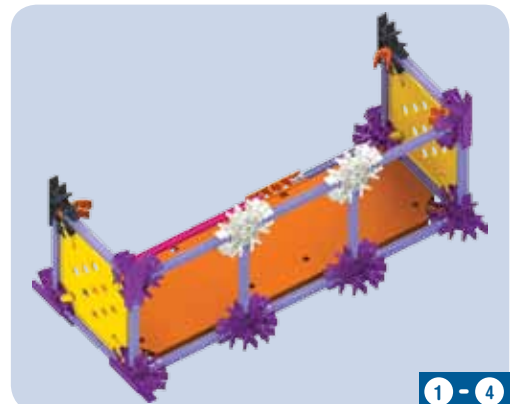
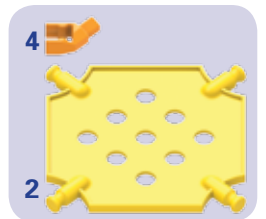
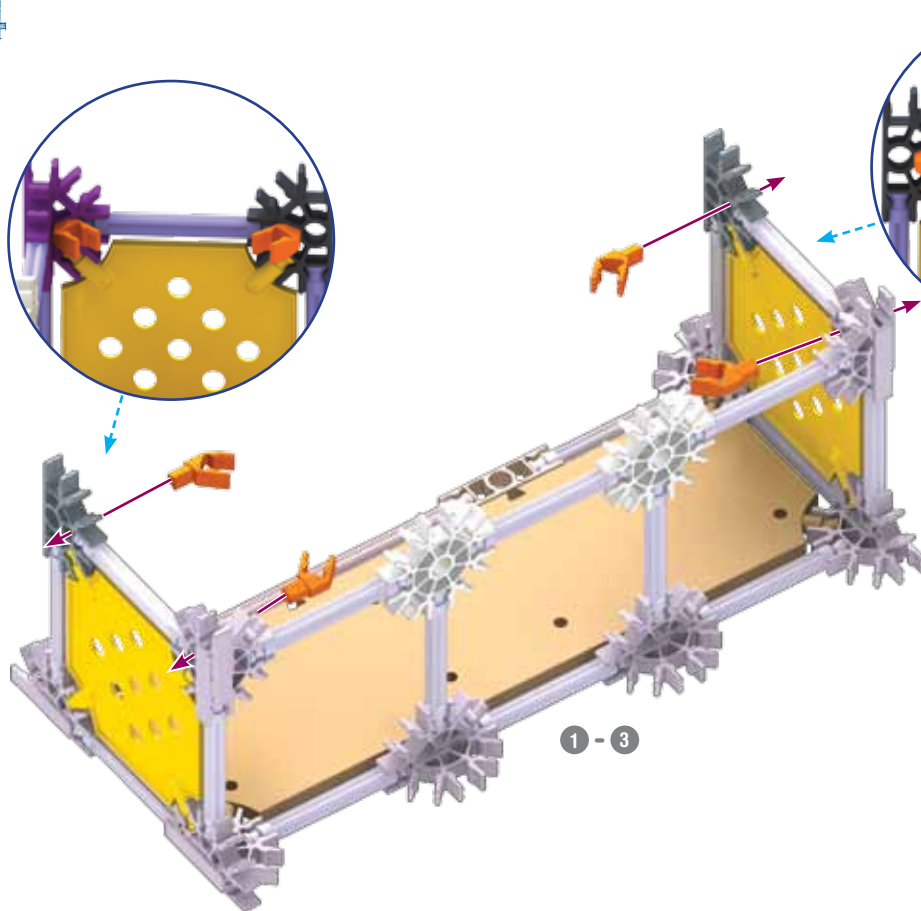

5

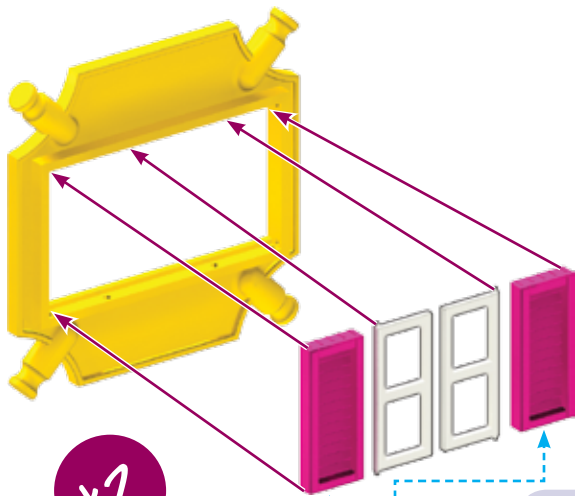

x2

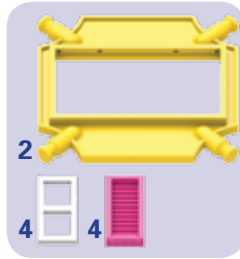

2

4

4

x2

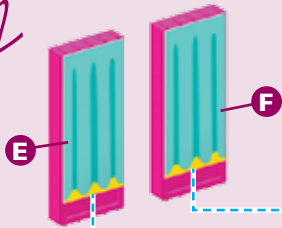

E

F

- Apply stickers to the back.
- Appliquer des autocollants à l'arrière.
- Aplicar pegatinas en la parte posterior.
- Klebe die Aufkleber auf die Rückseite.
- Metti etichetta adesivo sul lato opposto.
- Aplicar os autocolantes na parte de trás.
- Stickers op de achterzijde.



x2

5

6

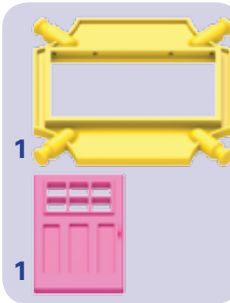
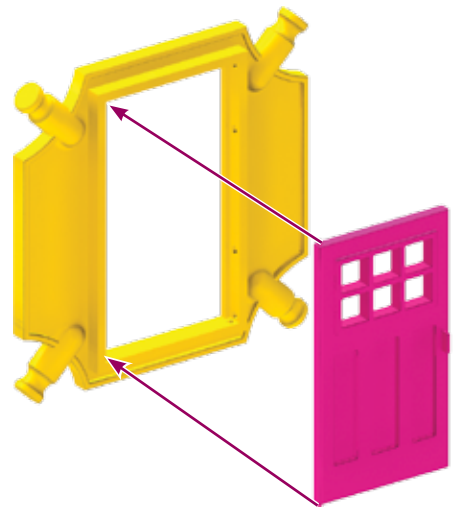

1

1



6

7

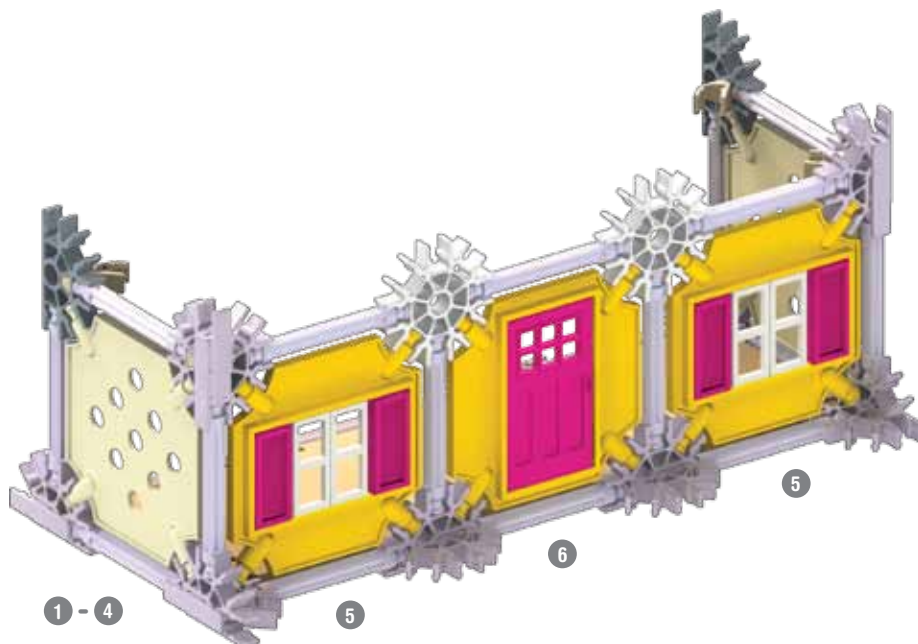

1 - 4

5

6

5



1 - 7

8

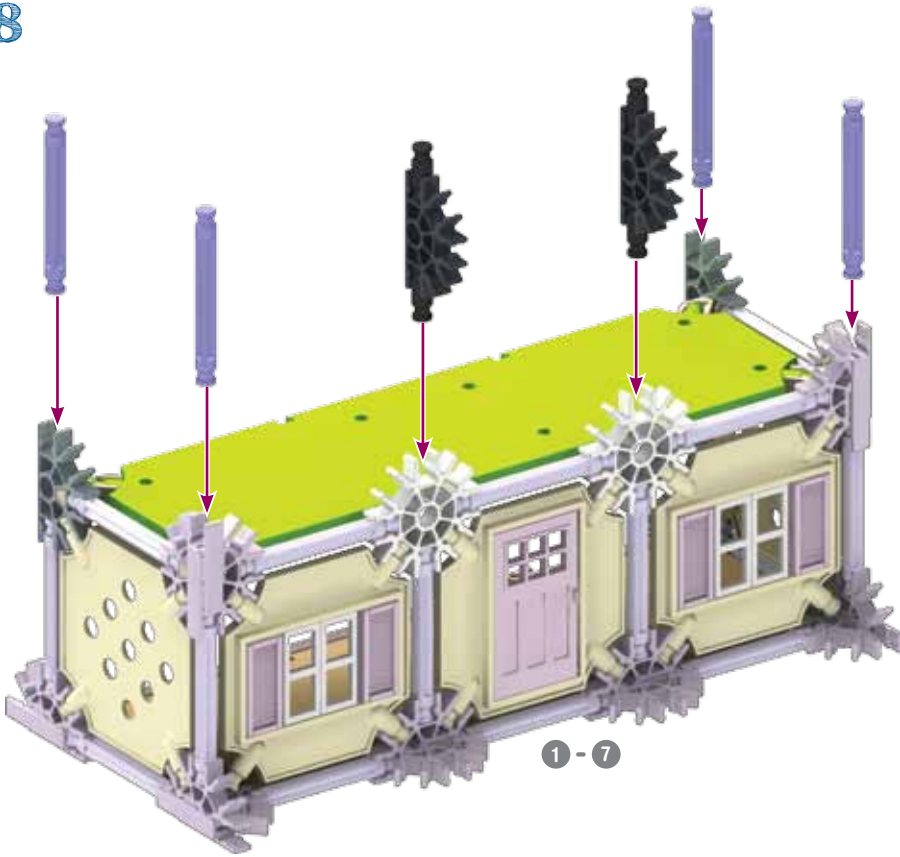

1 - 7

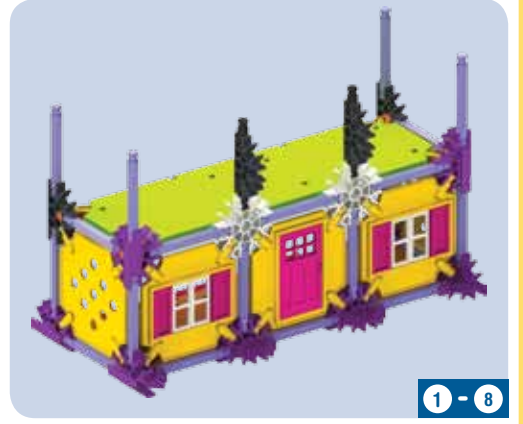

1 - 8

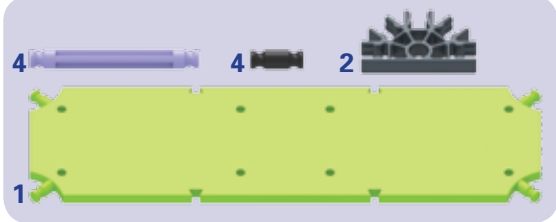

9



1 - 8

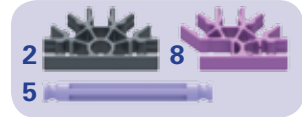

1 - 9

10

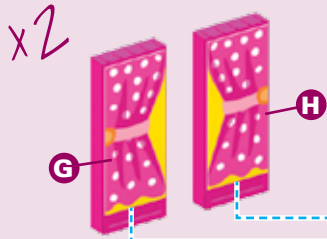
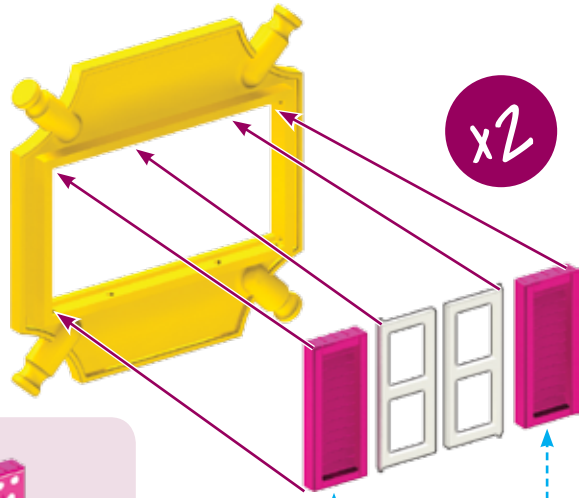

- EN Apply stickers to the back.
- FR Appliquer des autocollants à l'arrière.
- ES Aplicar pegatina en la parte posterior.
- DE Klebe die Aufkleber auf die Rückseite.
- IT Metti etichetta adesivo sul lato opposto.
- PT Aplicar os autocolantes na parte de trás.
- NL Stickers op de achterzijde.

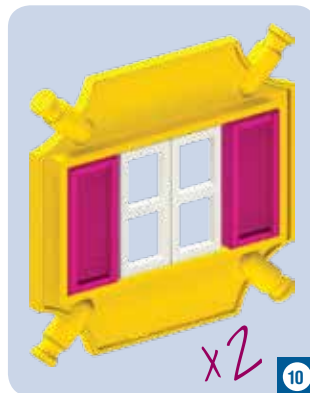
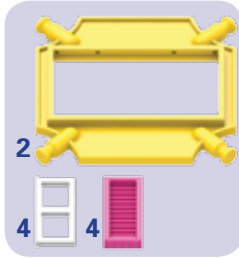

11

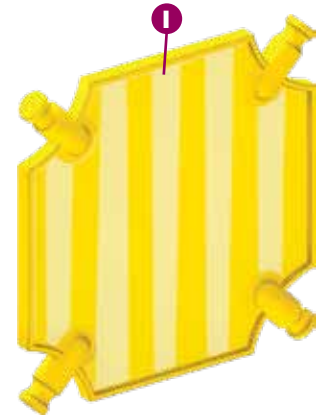

- EN Apply sticker to the back.
- FR Appliquer des autocollant à l'arrière.
- ES Aplicar pegatina en la parte posterior.
- DE Klebe die Aufkleber auf die Rückseite.
- IT Metti etichetta adesivo sul lato opposto.
- PT Aplicar os autocolantes na parte de trás.
- NL Sticker op de achterzijde.

12

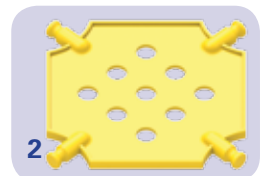
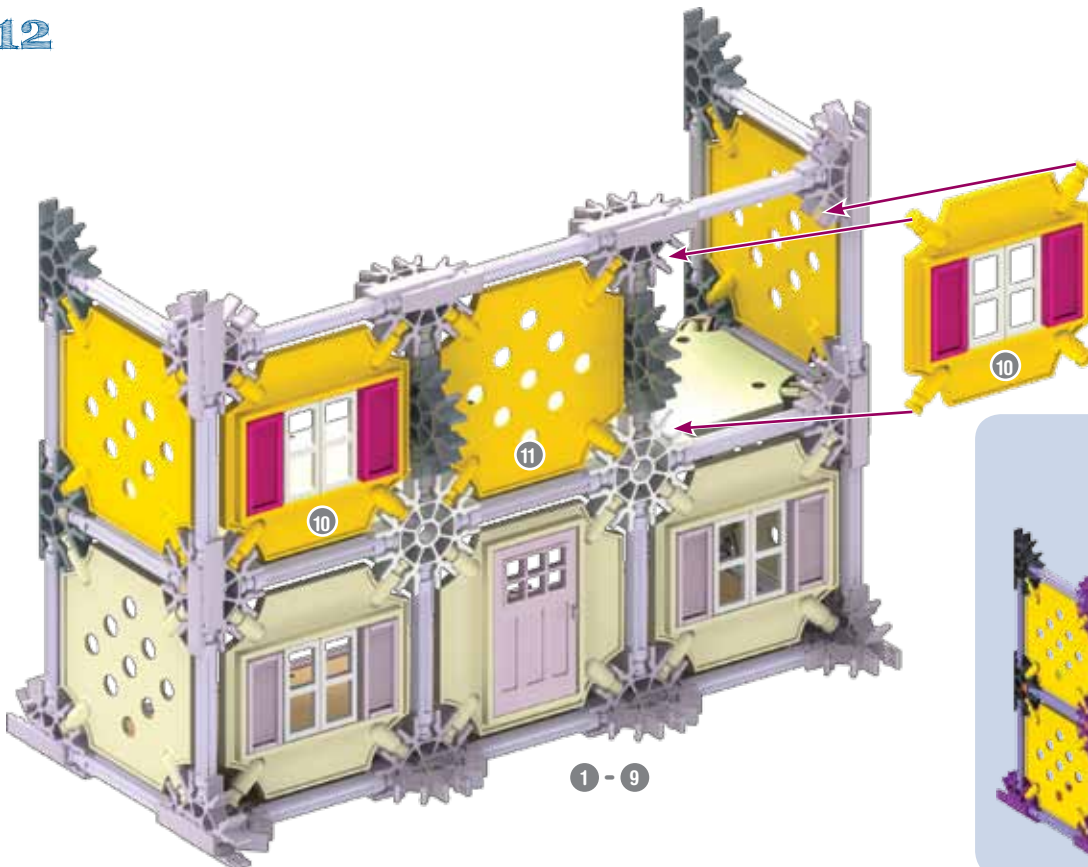

13

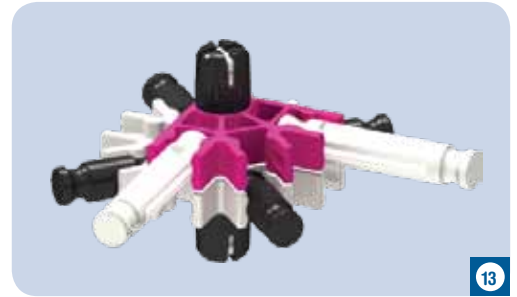
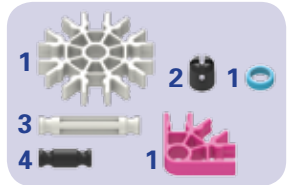
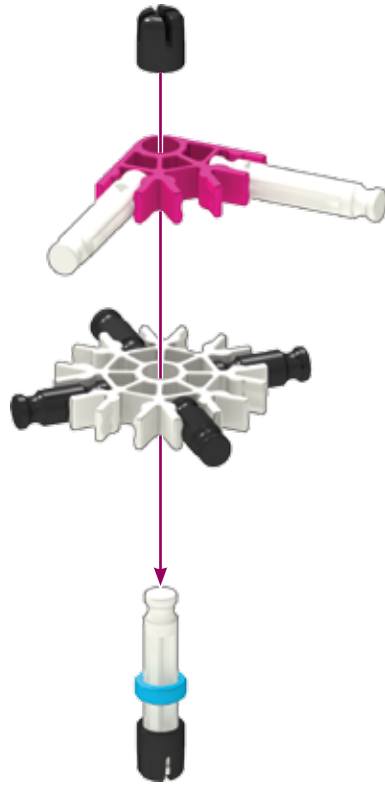

13

14

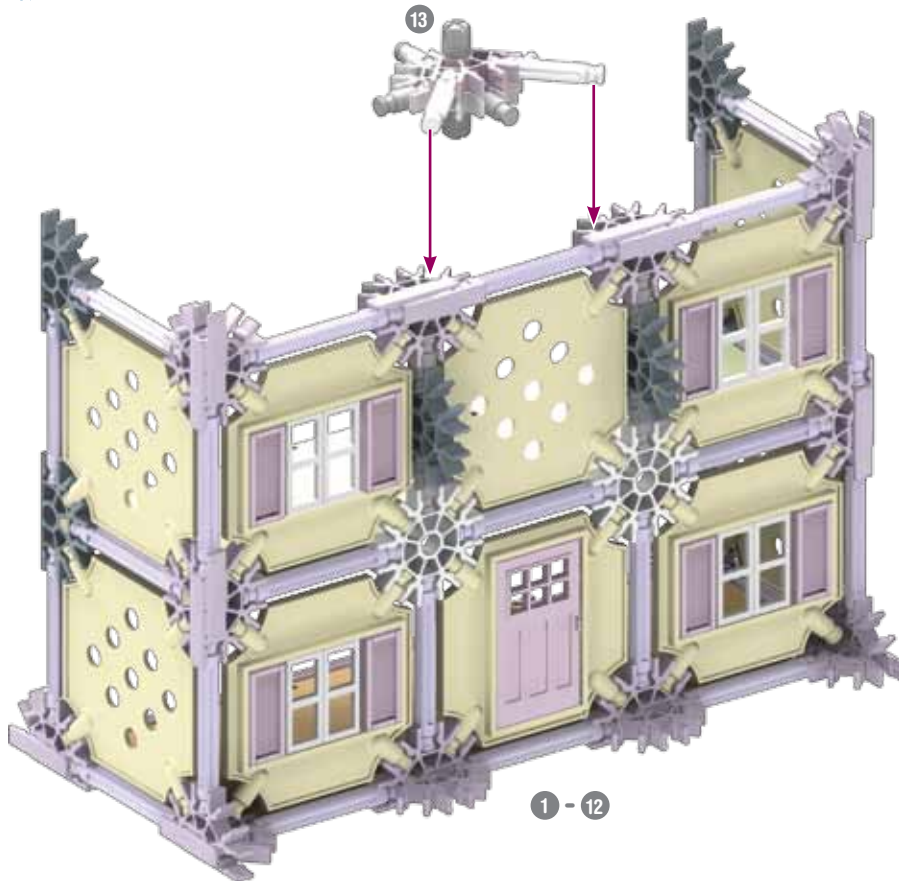

1 - 14

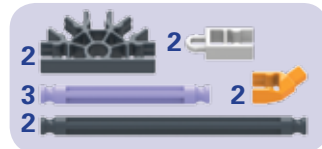
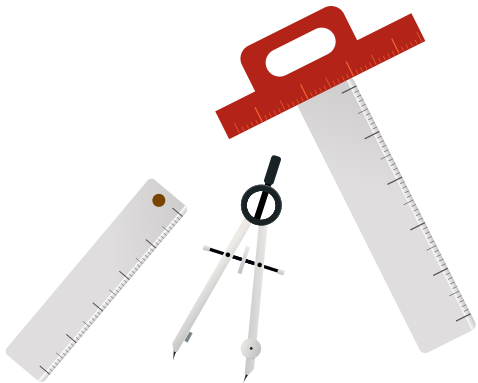
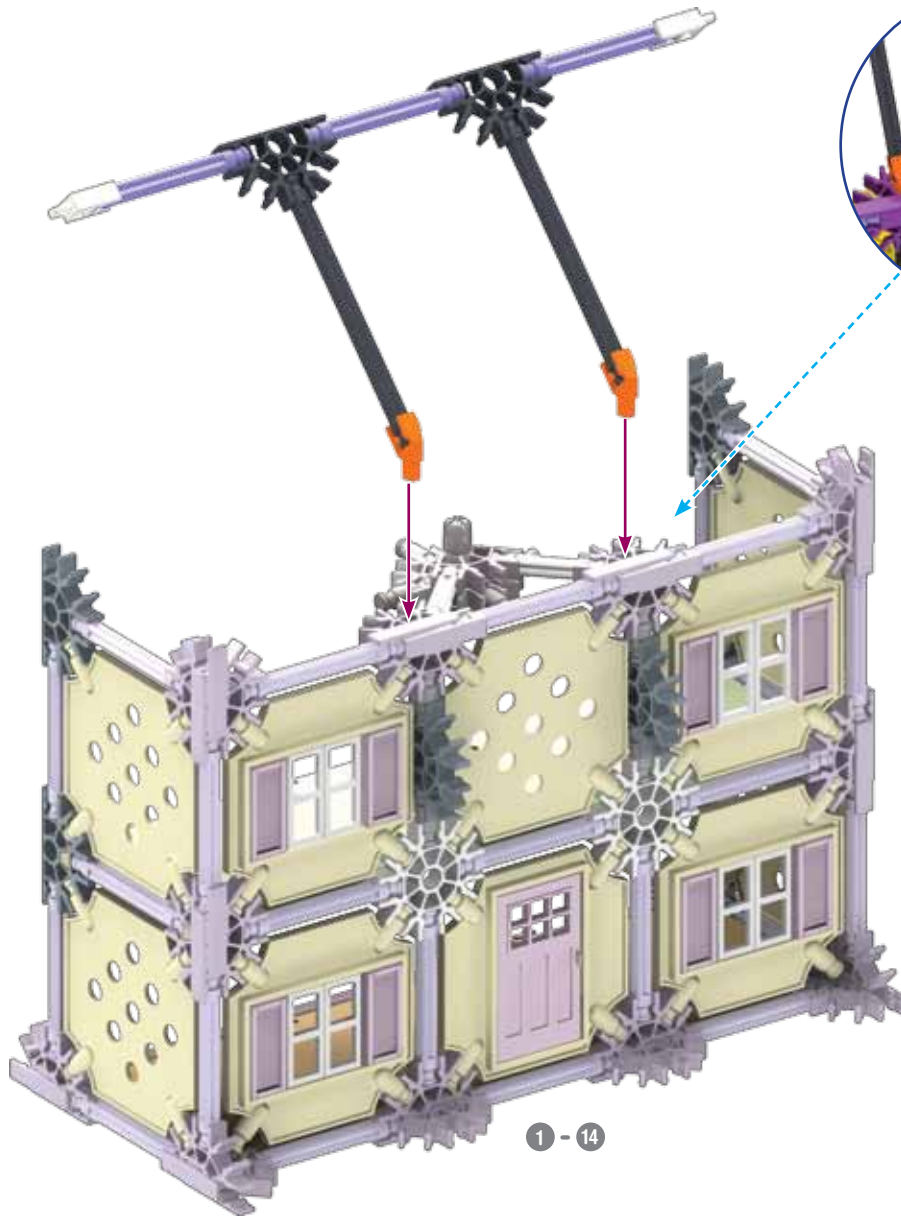

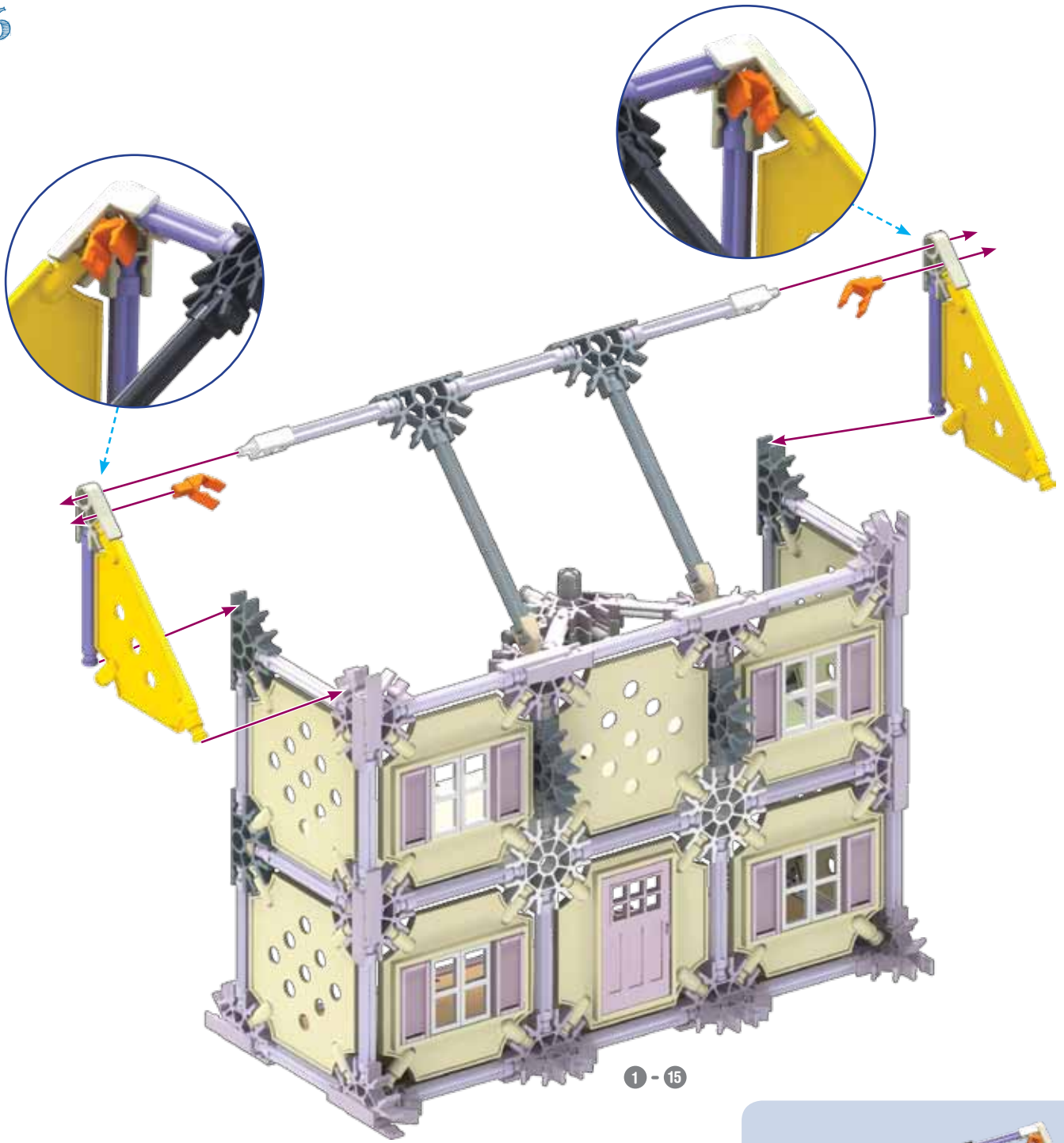

17

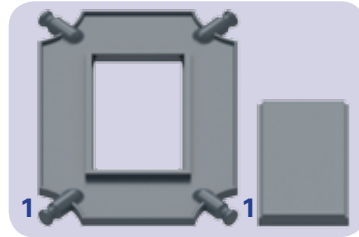
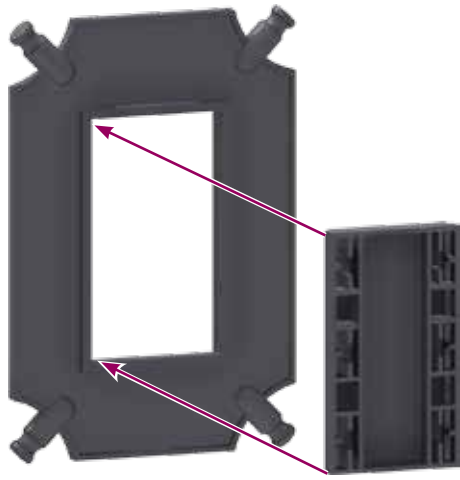

18

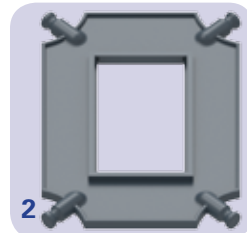
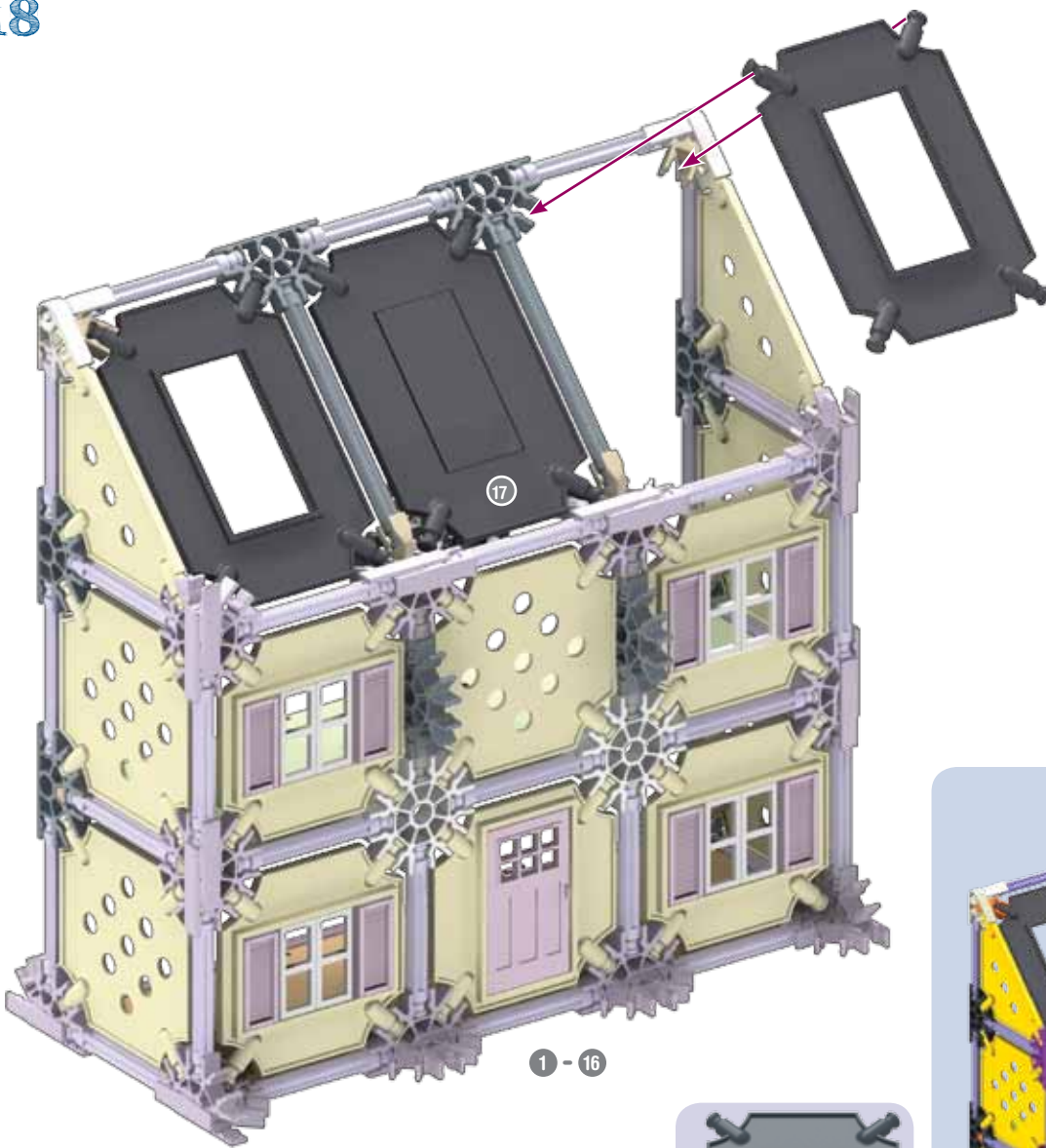

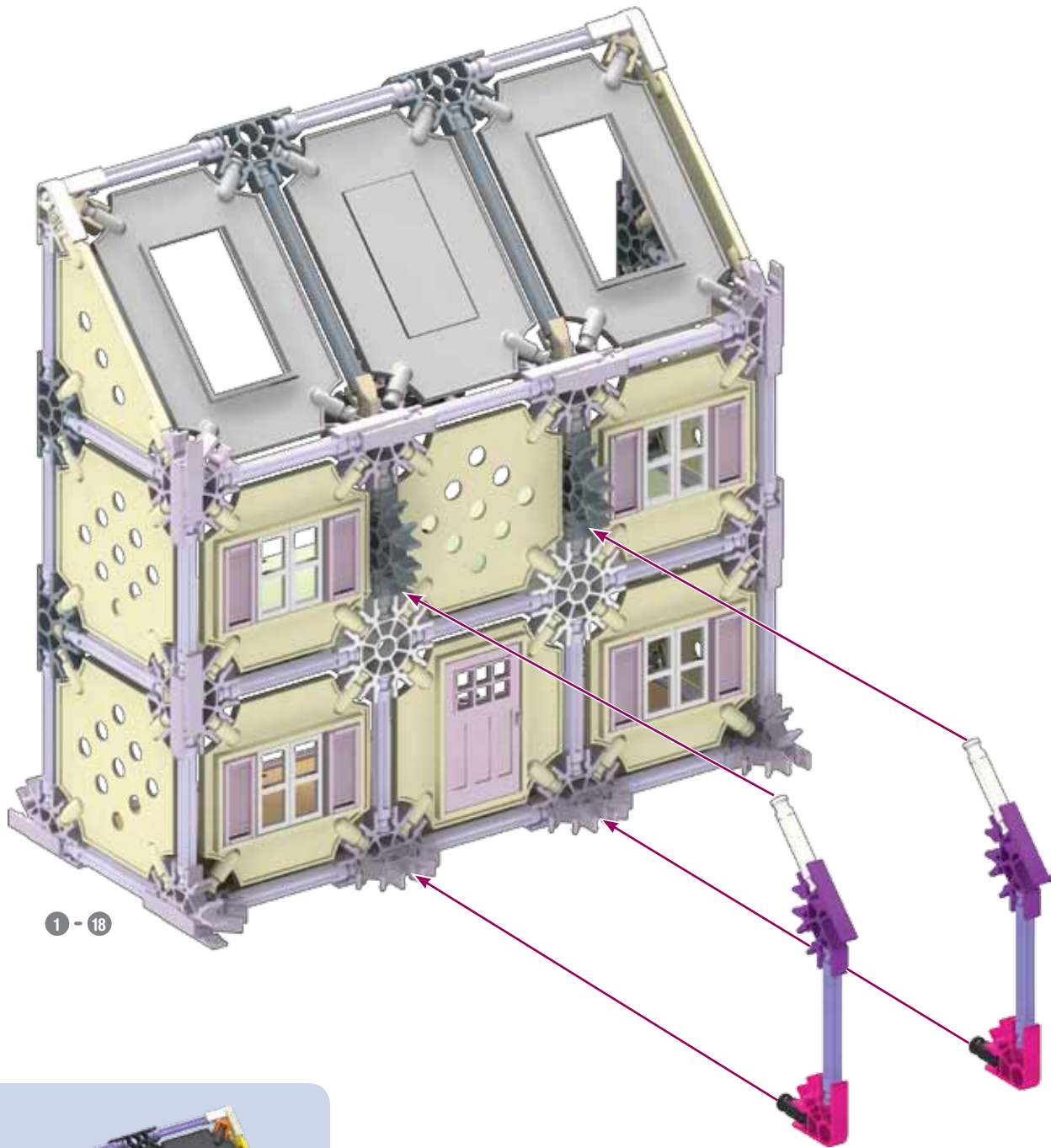

1 - 18

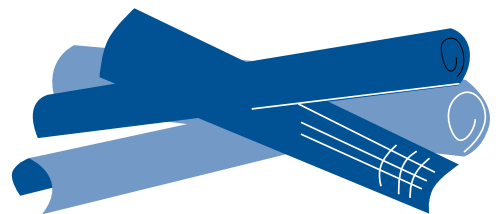
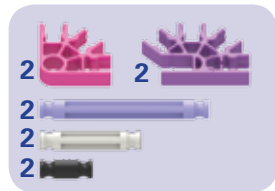

Snap the windows in from the back.

Enclencher la fenêtre depuis l'arrière.

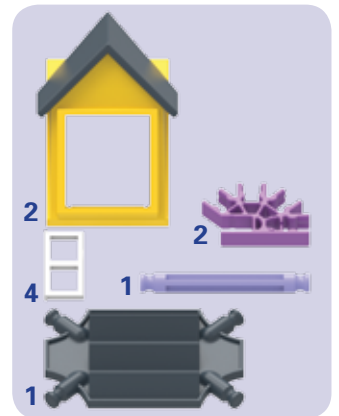
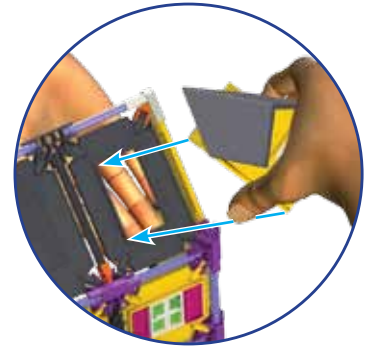
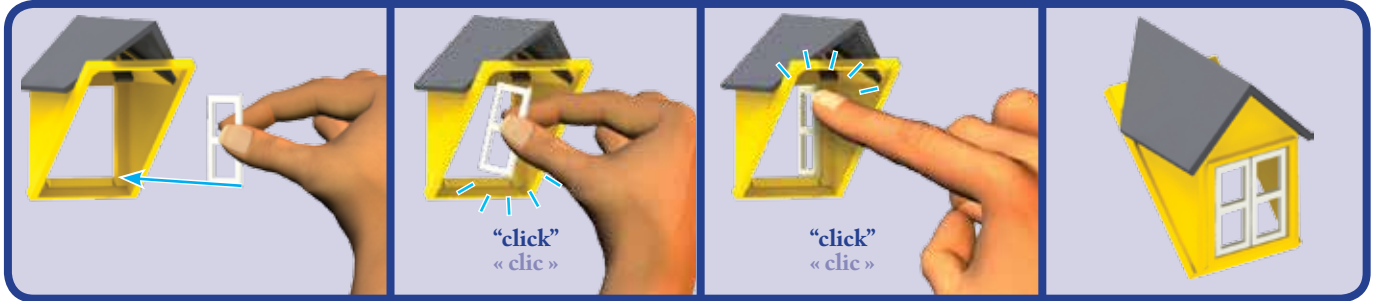

1 - 19

1 - 20

21

x2

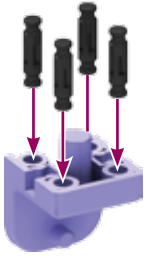

22

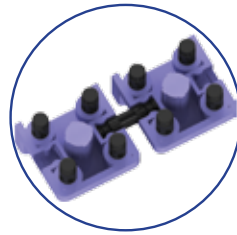
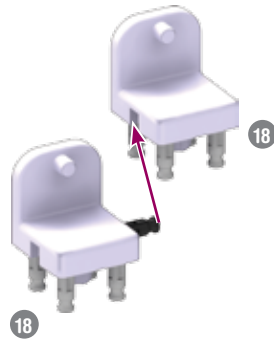

23

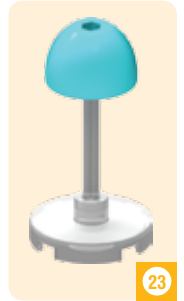

24

x2

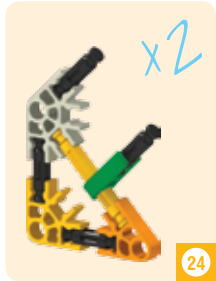
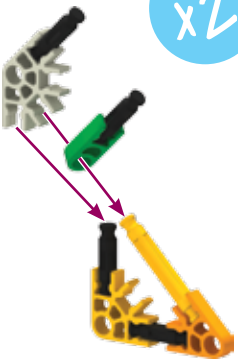

25

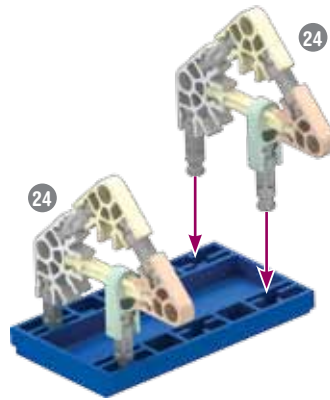

- Apply sticker
- Appelez des autocollant
- Aplicar pegatina
- Bringe die Aufkleber an
- Applicare gli adesivi
- Aplicar adesivo
- Sticker plakken



24 - 25

26

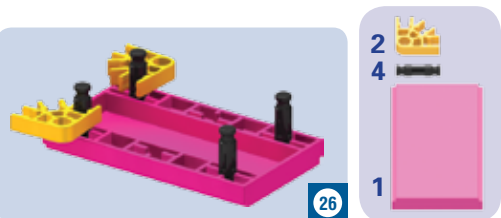
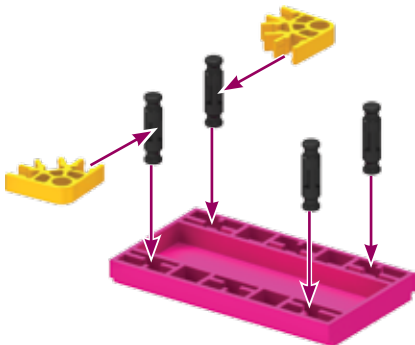

27

- Apply sticker
- Appelez des autocollant
- Aplicar pegatina
- Bringe die Aufkleber an
- Applicare gli adesivi
- Aplicar adesivo
- Sticker plakken

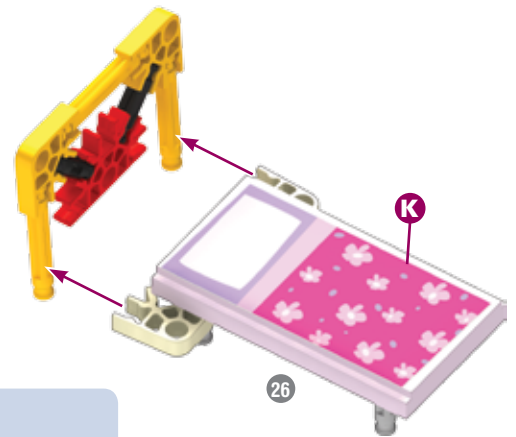

26 - 27







Awesome work building the houses! You are a great architect.

Beau travail a batir les maisons ! Tu es un grand architecte.



For instructions of these models go to www.knex.com/instructions and enter code 43735.

Pour instructions de ces modèles vont à www.knex.com/instructions et entrez dans le code 43735.



brownstone
pierre brune



picture frame
cadre photo

Check out these
other cool things we
can build.

Découvrez tous les autres
idées géniale qu'on peut
construire.

* Go to www.knex.com/downloadables
and enter 43735 to print graphic panels!

Allez à www.knex.com/downloadables et
entrez 43735 pour imprimer des panneaux
graphiques !



#IamAMightyMaker

(ES) (Página 2)

Conozca a Brianna y Sophia

¡Cosas favoritas de Brianna!

¡Cosas favoritas de Sophia!

**Aprenda acerca...#Arquitectura

(Página 3)

¡Nos encanta diseñar y construir casas! ¿Puede usted ayudarnos a construir nuestras propias casas?

Antes de empezar a trabajar en nuestras casas, vamos a aprender cómo construir una estructura fuerte. ¡Coge tu tarjeta Mighty Makers® para empezar!

(Página 4)

Casa de Brianna

¡Ahora que hemos aprendido cómo hacer una estructura fuerte, vamos a empezar a construir mi casa estilo rancho!

“clic”

(Página 12)

Casa de Sofia

¡Gran trabajo ayudando a Brianna! Ahora vamos a seguir construyendo mi casa de estilo colonial.

(Página 23)

Enclencher la fenêtre depuis l'arrière.

(Página 27)

¡Gran trabajo a la construcción de las casas! Usted es un gran arquitecto.

(Página 28)

Ya que las instrucciones de los estos modelos van a www.knex.com/instructions y entre en el código **43735**.

pedra marrón

marco

Compruebe estas otras cosas interesantes que podemos construir.

¡Ir a www.knex.com/downloadables y escriba **43735** para imprimir paneles gráficos!

(Tarjeta Mighty Makers®)

¡Que sea fuerte!

Los edificios están hechos de piezas más pequeñas, como techos, paredes y puertas - cada uno con diferente tamaño y geometría. Formas como triángulos ayudan a hacer una estructura fuerte. ¿Puedes ver las distintas formas que hacen de esta estructura fuerte?

(DE) (Seite 2)

Treffen sie Brianna und Sophia

Briannas Lieblingsachen!

Sophias Lieblingsachen!

**Lernen sie über...
#Architektur

(Seite 3)

Wir lieben Häuser zu entwerfen und bauen! Können Sie uns beim Bau unserer eigenen Wohnungen helfen?

Bevor wir mit den Häusern beginnen, lasst uns lernen, wie Sie eine starke Struktur baut. Greifen Sie sich Ihre Mighty Makers® Karte um zu beginnen!

(Seite 4)

Brianna's Haus

Jetzt, wo wir wissen wie man eine starke Struktur baut, können wir anfangen mein Haus im Ranchstil zu bauen!

“klicken”

(Seite 12)

Sophia's Haus

Du hast Brianna super geholfen! Jetzt machen wir weiter mit der Konstruktion von meinem Haus im Kolonialstil.

(Seite 23)

Die Fenster von der Rückseite einrasten.

(Seite 27)

Super Arbeit mit dem Bauen der Häuser! Sie sind ein guter Architekt.

(Seite 28)

Für Anweisungen dieser Modelle gehen sie zu www.knex.com/instructions und geben sie Code **43735** ein.

braunstein

bilderrahmen

Schaue auch auf diese anderen coolen Dinge die wir bauen können.

Gehe zu www.knex.com/downloadables und gebe **43735** ein um die Graphiken zu drucken!

(Karte Mighty Makers®)

Mache es stark!

Gebäude bestehen aus kleineren Bauteilen wie Dächer, Wände, und Gänge – jedes in unterschiedlichen Grössen und Formen. Dreiecke helfen die Struktur zu versteifen. Kannst Du die verschiedenen Formen, die die Struktur steif machen erkennen?

(IT) (Pagina 2)

Conosci Brianna e Sophia

Cose preferite di Brianna!

Cose preferite di Sophia!

**Imparavi...#Architettura

(Pagina 3)

Chi piace di progettare e costruire case! Puoi aiutarci a costruire le case nostre?

Prima di iniziare le nostre case, impariamo a costruire una struttura forte. Prendi la tua carta di Mighty Makers® per cominciare!

(Pagina 4)

Casa di Brianna

Ora che abbiamo imparato a fare una struttura forte, cominciamo a costruire la mia casa a uno piano!

“clic”

(Pagina 12)

Casa di Sophia

Ottimo lavoro a aiutare Brianna! Adesso continuiamo a costruire la mia casa in stile coloniale.

(Pagina 23)

Attacca le finestre sul lato opposto.

(Pagina 27)

Magnifico lavoro a costruire le case! Lei è un grande architetto.

(Pagina 28)

Per istruzioni di questi modelli vai a www.knex.com/instructions e' inserire il codice **43735**.

casa con pietra arenaria

cornice

Dare uno sguardo a queste altre cose fantastiche che noi possiamo costruire.

Vai a www.knex.com/downloadables e inserire **43735** per stampare carte grafici!

(Carta Mighty Makers®)

Farlo più forte!

Edifici sono fatti di pezzi più piccoli come tetti, parete, e porte – ogni uno con dimensioni & geometria differente. Figure come triangoli aiutano a fare una struttura più forte. Puoi vedere le figure differente che rendono questa struttura più forte?

(PT) (Página 2)

Reunir-se Brianna e Sophia

Brianna coisas favoritas!

Sophia coisas favoritas!

**Aprender sobre...#Arquitetura

(Página 3)

Temos amor para projetar e construir casas! Você pode ajudar-nos a criar nossos próprios lares?

Antes de começar em nossas casas, vamos aprender a criar uma forte estrutura. Agarra a tua Mighty Makers® cartão para começar!

(Página 4)

Casa de Brianna

Agora que aprendemos a fazer uma forte estrutura, vamos começar a criar a minha casa estilo rancho!

“clique”

(Página 12)

Casa de Sophia

Ótimo trabalho ajudando Brianna! Agora, vamos continuar criando, construindo minha casa em estilo colonial.

(Página 23)

Encaixe o windows a partir da parte de trás.

(Página 27)

Incrível trabalho construindo as casas! Você é um grande arquiteto.

(Página 28)

Para obter instruções destes modelos vá em www.knex.com/instructions e digite o código **43735**.

pedra marrom

moldura de retrato

Confira as outras coisas incríveis que podemos construir.

Vá para www.knex.com/downloadables e entrar **43735** para imprimir painéis gráficos!

(Cartão Mighty Makers®)

Faça o seu forte!

Os edifícios são feitos de partes menores como telhados, paredes e portas, cada um com diferentes tamanhos e geometria. As formas como triângulos ajuda a fazer uma estrutura forte. Você pode ver as diferentes formas que compõem esta estrutura forte?

(NL) (Bladzijde 2)

Ontmoet Brianna en Sophia

Brianna favoriete dingen!

Sophia favoriete dingen!

**Leer over...#Architectuur

(Bladzijde 3)

Wij houden van ontwerp en bouw van huizen! U kunt meewerken aan onze eigen huizen?

Voordat we aan de slag met onze huizen, laten we leren hoe te bouwen aan een krachtige structuur. Pak uw Mighty Makers® kaart aan de slag!

(Bladzijde 4)

Brianna's Huis

Nu geleerd hoe je een sterke structuur, aan de slag gebouw mijn ranch style house!

"klik"

(Bladzijde 12)

Sophia's Huis

Geweldige opdracht helpen Brianna! Nu laten we bouwen door mijn koloniale huis.

(Bladzijde 23)

Snap windows vanaf de achterzijde.

(Bladzijde 27)

Geweldig de huizen! U bent een groot architect.

(Bladzijde 28)

Voor instructies van deze modellen naar www.knex.com/instructions en vul de code **43735**.

bruine steen

fotolijst

Bekijk de andere leuke dingen die we kunnen bouwen.

Ga naar www.knex.com/downloadables en voer **43735** printen grafische panelen!

(Mighty Makers® Kaart)

Het Sterk!

Gebouwen zijn gemaakt van kleinere delen, zoals daken, muren en deuren - elk met verschillende maten en geometrie. Profielen zoals driehoeken helpen om een structuur sterk. Ziet u de verschillende vormen die deze structuur strek?



Home Designer

building set

Concepteur de la Maison

jeu de construction



Sold separately.

Vendus séparément.

Se venden por separado.

Separat erhältlich.

Venduti separatamente.

Vendidos separadamente.

Afzonderlijk verkocht.



KNEX.COM

WARNING: CHOKING HAZARD – Small parts. Not for children under 3 years.
ATTENTION : RISQUE D'ÉTOUFFEMENT – Pièces de petite taille. Ne convient pas aux enfants de moins de 3 ans.
ADVERTENCIA: PELIGRO DE ASFIXIA – Piezas pequeñas. No para niños menores de 3 años.
ACHTUNG: ERSTICKUNGSGEFAHR – Kleinteile. Nicht geeignet für Kinder unter 3 Jahren.
AVVISO: PERICOLO DI SOFFOCARE – Pezzi piccoli. Non adatto per bambini sotto 3 anni.
AVISO: PERIGO DE SUFOCAÇÃO – Peças pequenas. Não se destina a crianças com menos de 3 anos de idade.
WAARSCHUWING: INSLIKKINGSGEVAAR – Kleine onderdelen. Niet geschikt voor kinderen jonger dan 3 jaar.

©2016 K'NEX Limited Partnership Group, P.O. Box 700, Hatfield, PA 19440-0700; 1-800-KID-KNEX (USA/Canada/États-Unis/EE.UU.); email@knex.com; knex.com. K'NEX UK Ltd., P.O. Box 3083, Reading RG1 9YQ, England.

K'NEX, Building Worlds Kids Love, Mighty Makers, and Building Big Ideas are registered trademarks of K'NEX Limited Partnership Group. Product & colors may vary. Most models can be built one at a time. For customers outside the USA/Canada please contact your local distributor at www.knex.com/distributors.

(FR) K'NEX, Building Worlds Kids Love, Mighty Makers, et Building Big Ideas sont des marques déposées de K'NEX Limited Partnership Group. Le produit et ses couleurs peuvent varier. Les différents modèles ne peuvent être construits qu'un par un. Pour les clients en dehors du Canada et des États-Unis, veuillez contacter votre distributeur local que vous pouvez trouver sur www.knex.com/distributors.

(ES) K'NEX, Building Worlds Kids Love, Mighty Makers, y Building Big Ideas son marcas registradas de K'NEX Limited Partnership Group. El producto y los colores pueden variar. La mayoría de los modelos se pueden construir uno a la vez. El cliente que no vive en EE.UU./Canadá se pone en contacto con el distribuidor local. Encuentre la información para el distribuidor local en www.knex.com/distributors.

7+

43735

143735-V1-04/16