

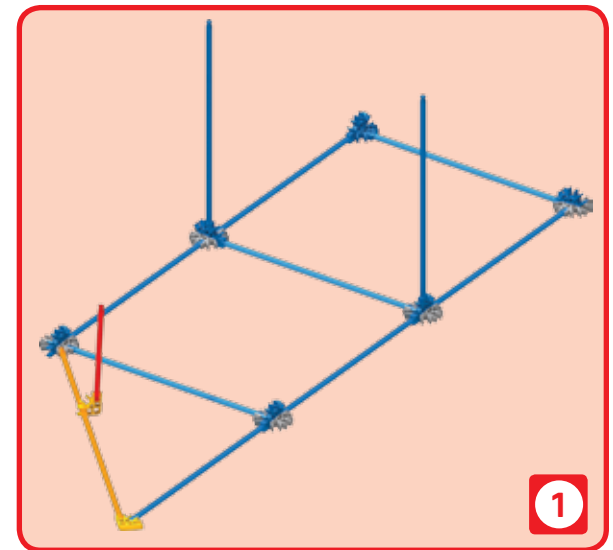

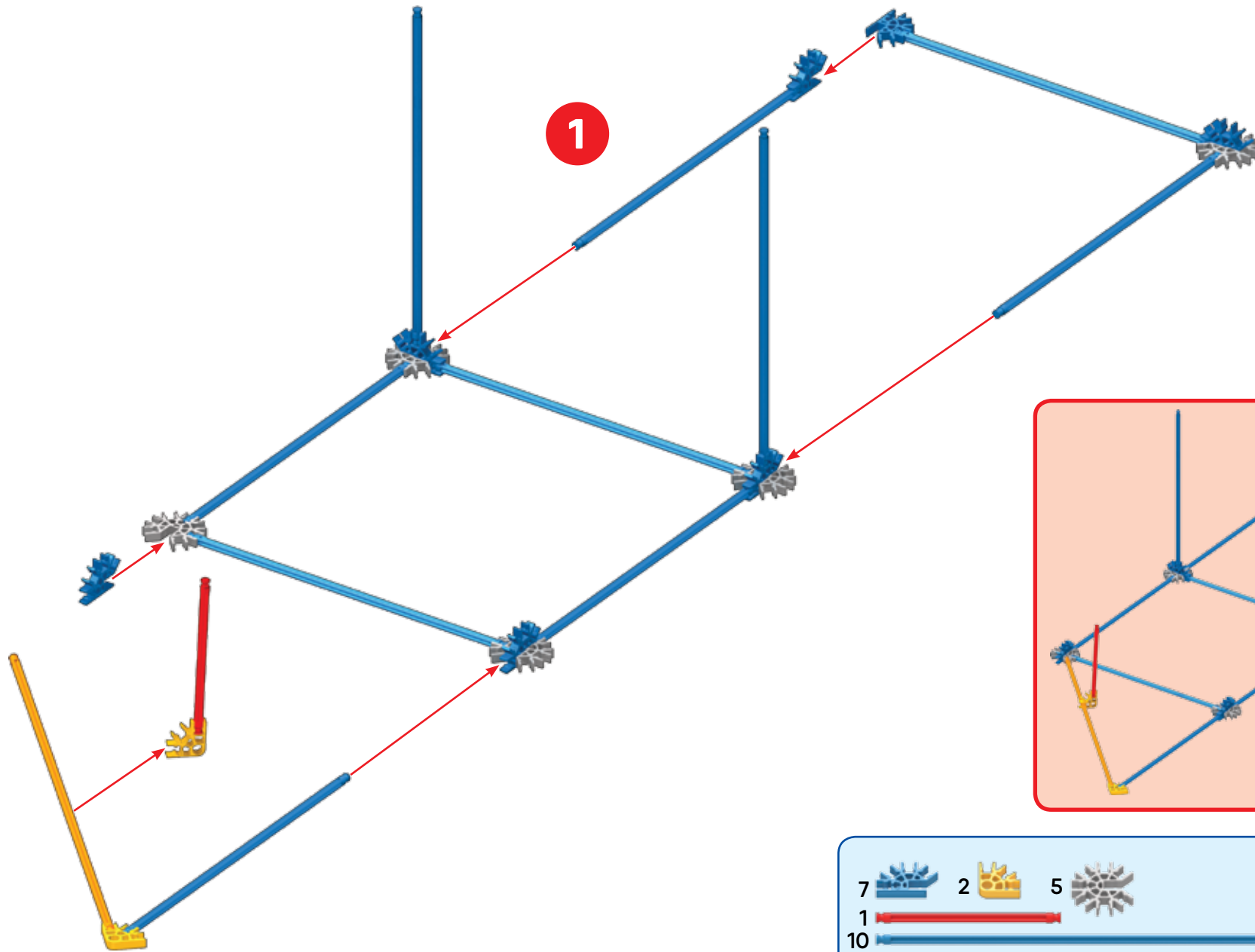



51425 LUNAR LAUNCH ALTERNATE BUILD









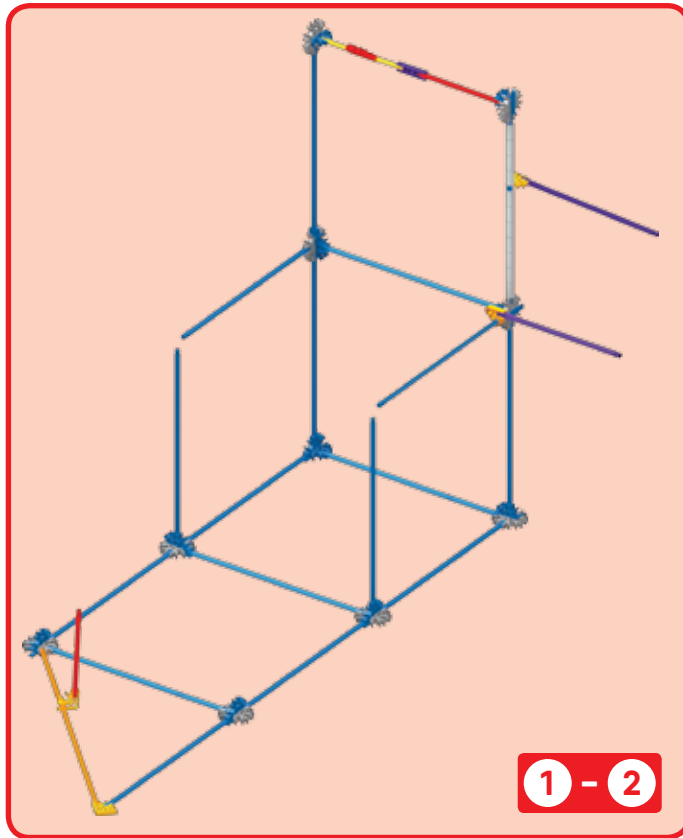





TIP: While you're building make sure you face your model in the same direction as the pictures shown in the instructions.



7		2		5	
1					
10					
1					



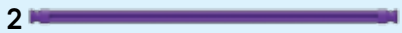



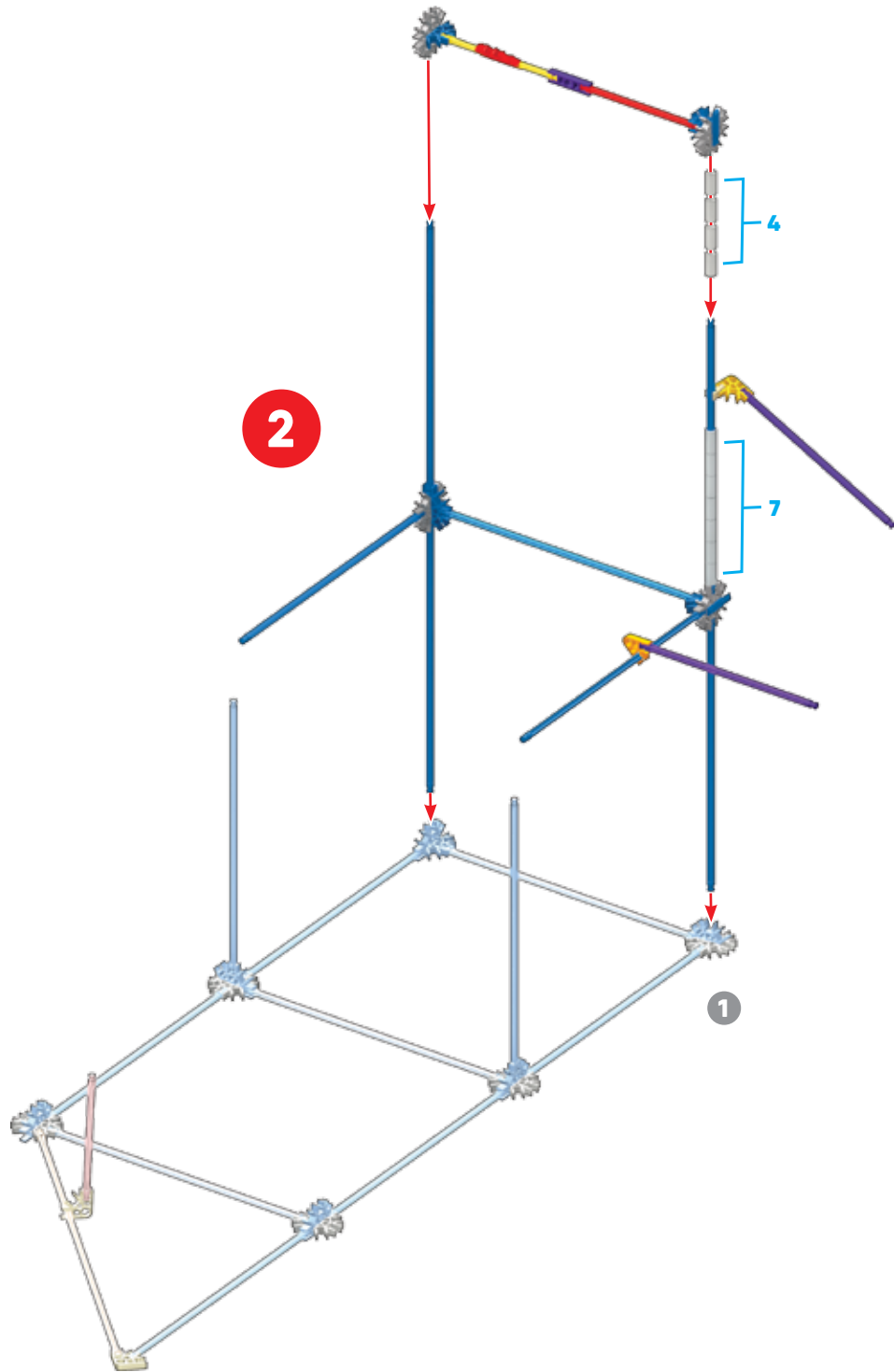

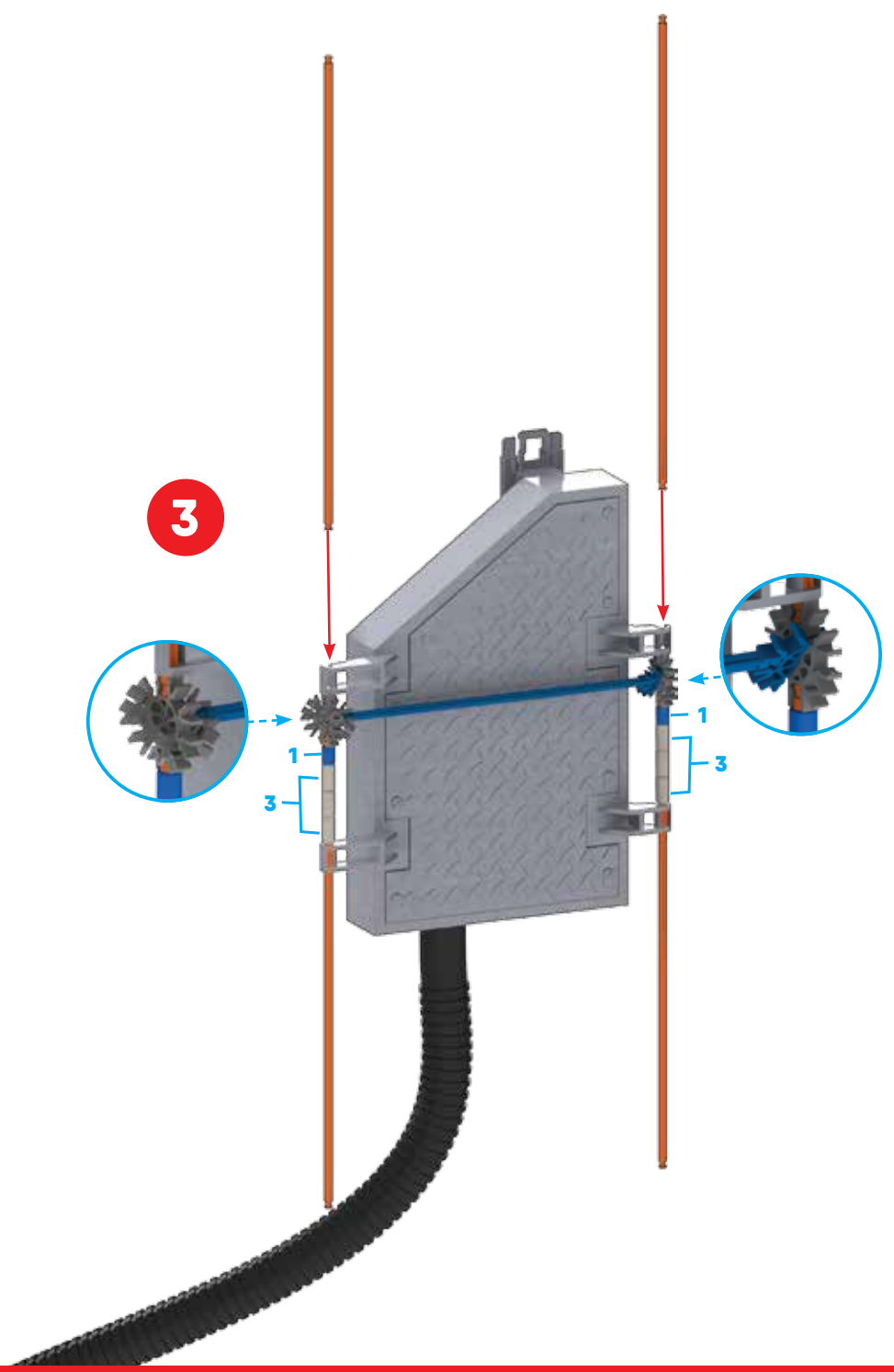
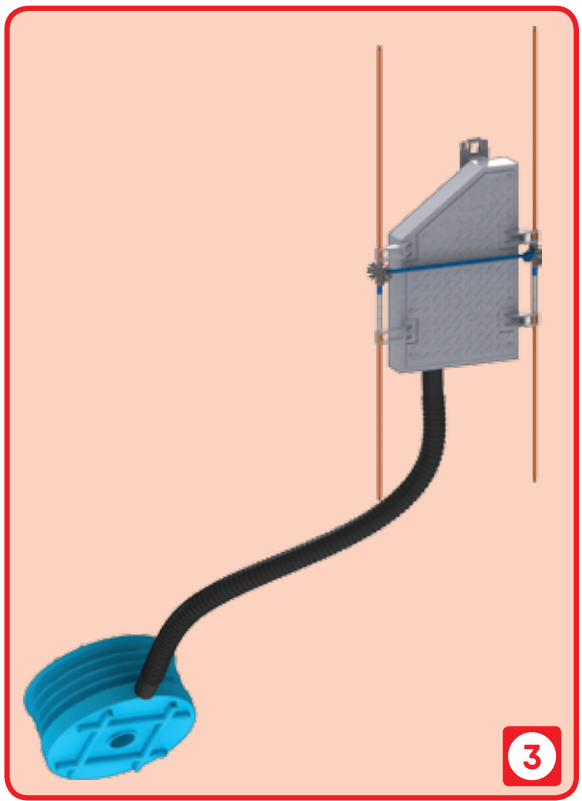
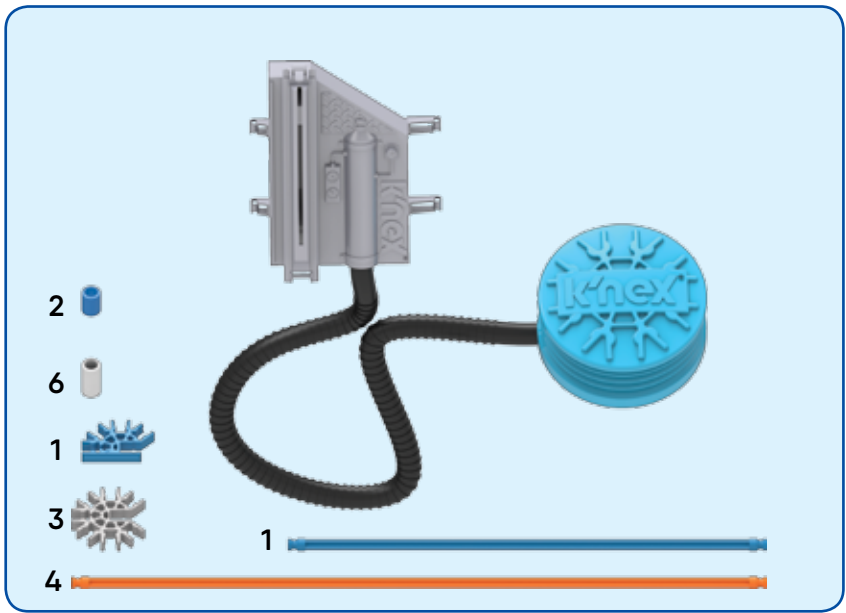

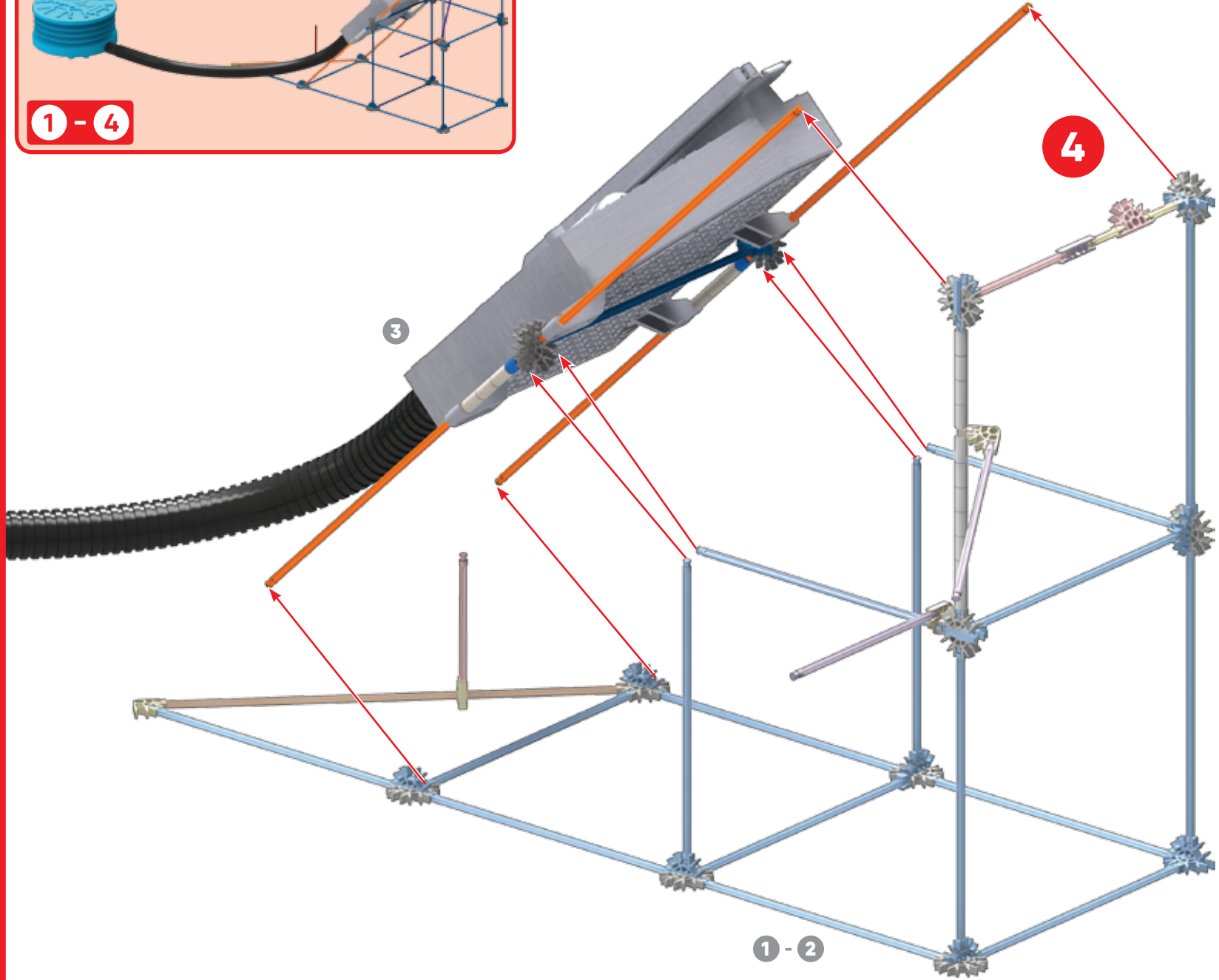
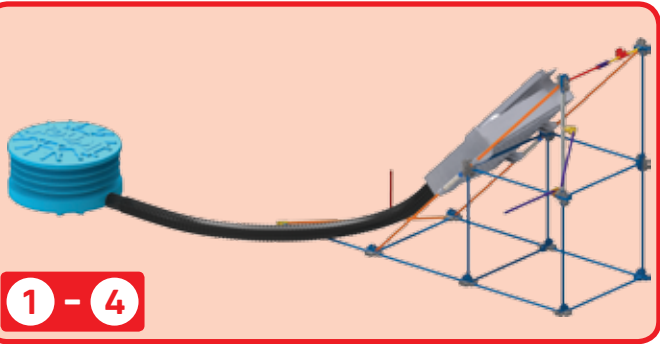

1 - 2

- 11  1  1  1  4  4 
- 2  1 
- 1  1 
- 2 
- 7 







- 7  2  7  1  3 
- 1 
- 4 
- 2 
- 6 
- 2 

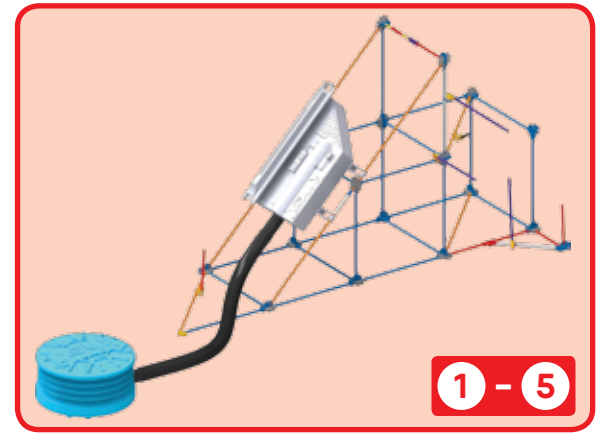

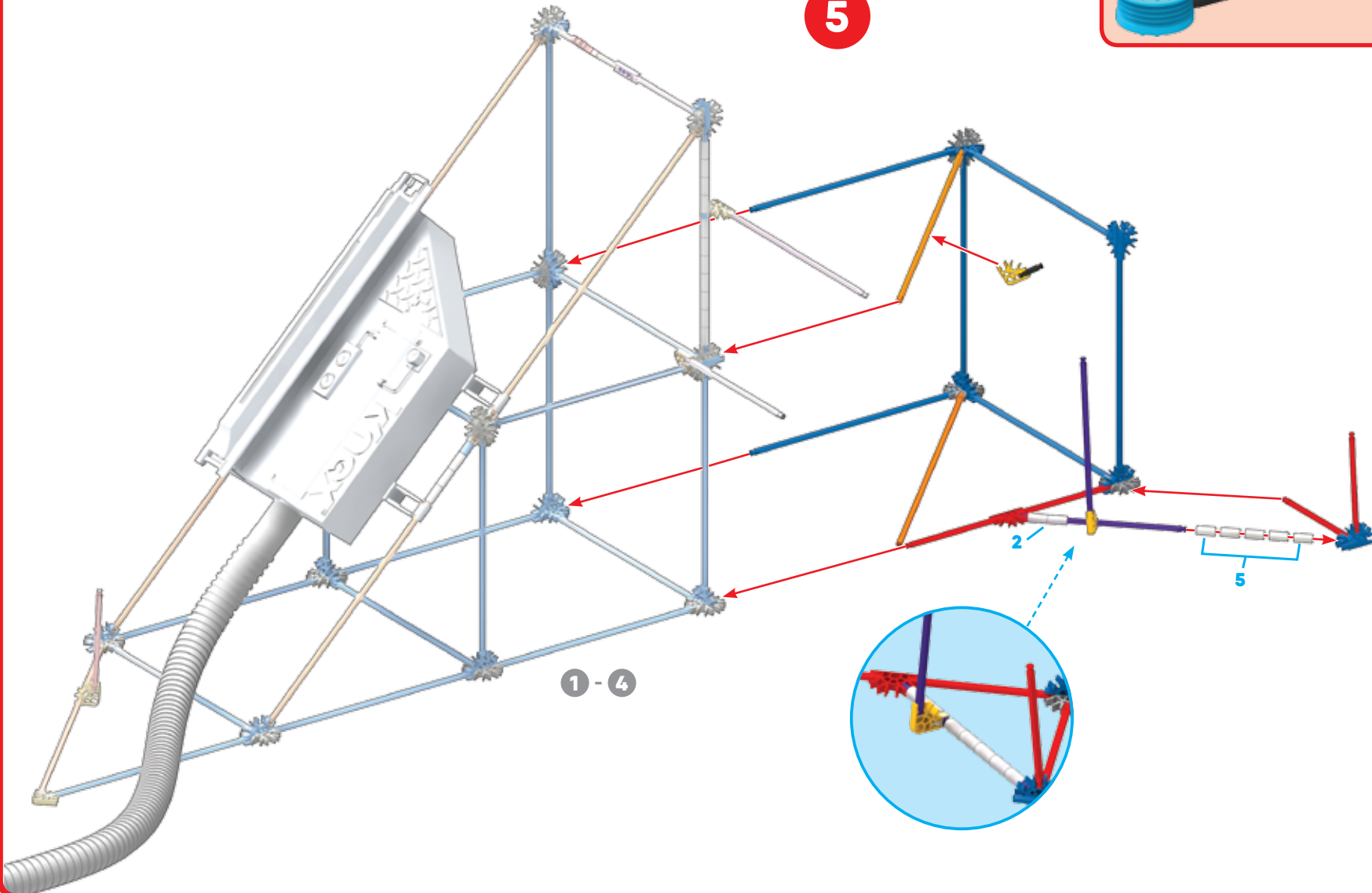

1 - 5

5







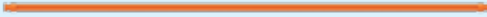

1 - 4

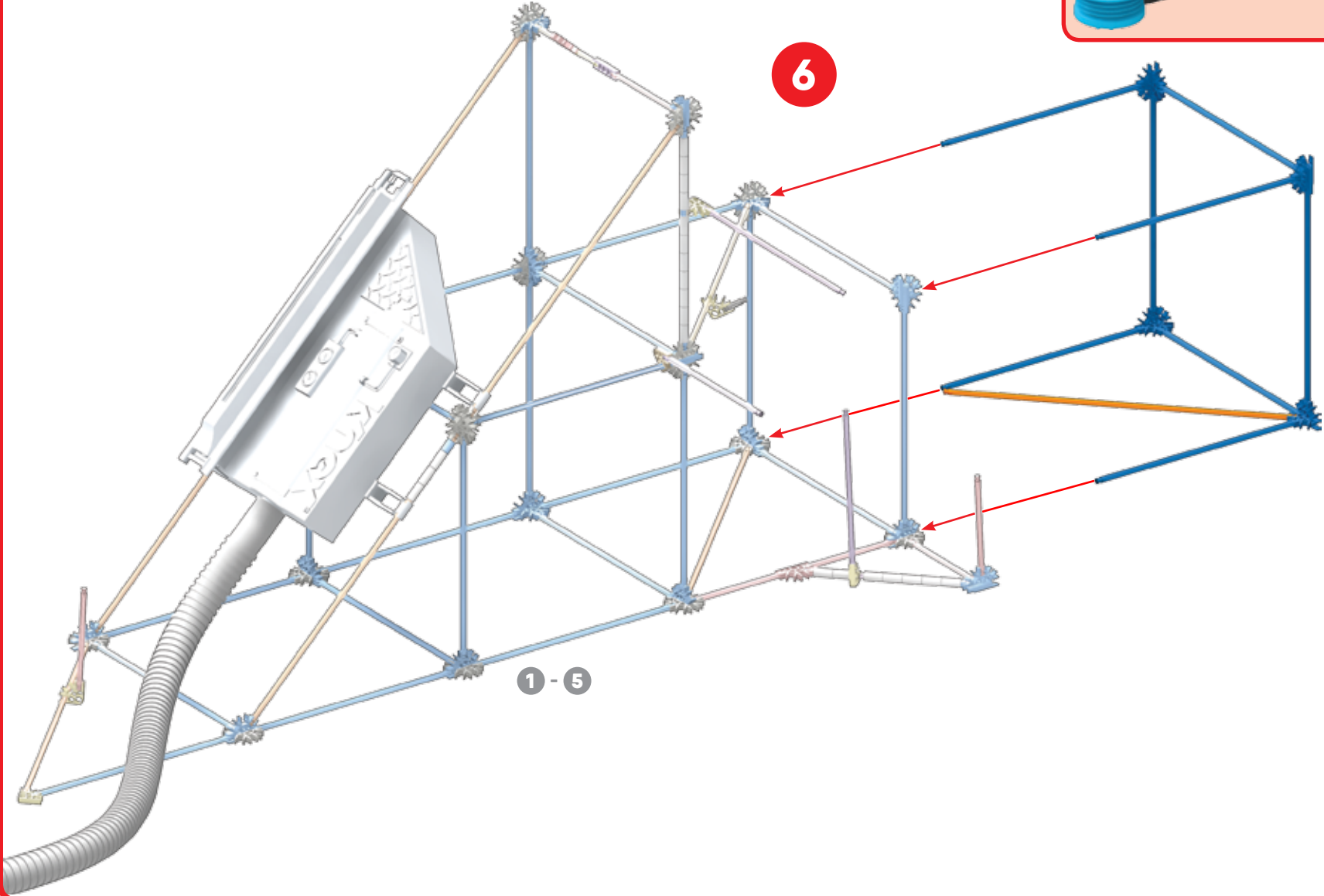
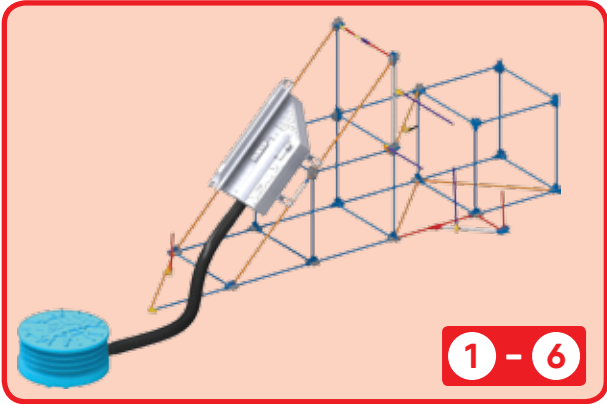
8 

8 

1 

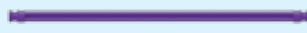

- 2  6  2 
- 1 
- 9 
- 1 

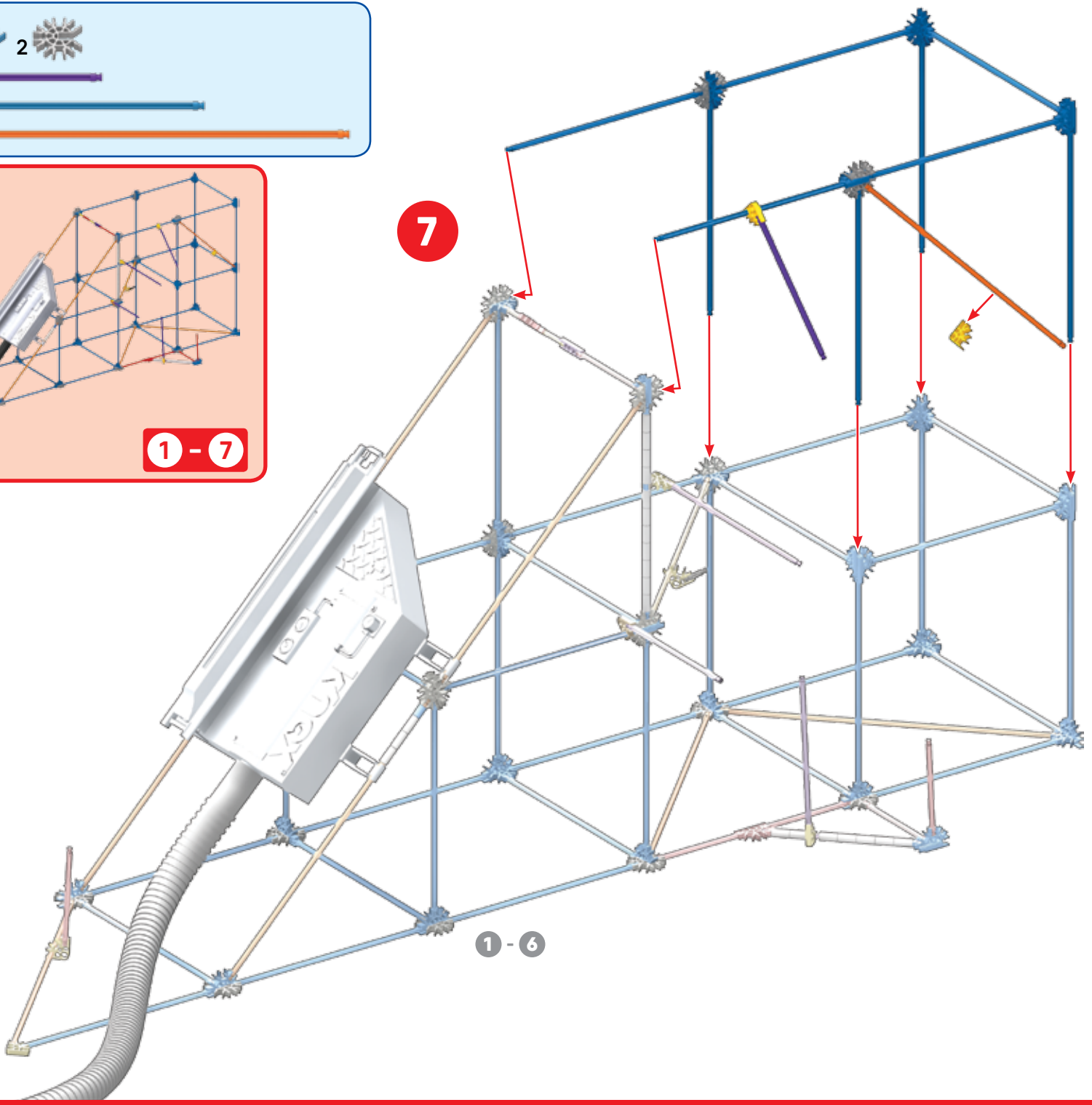
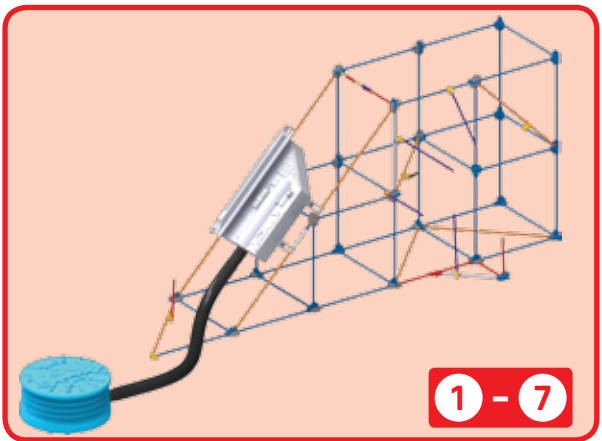

5

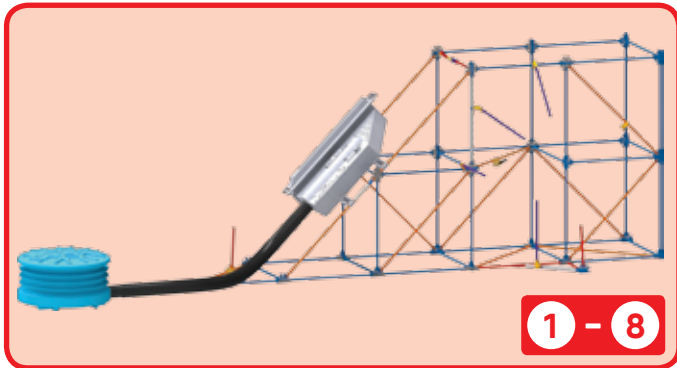

8

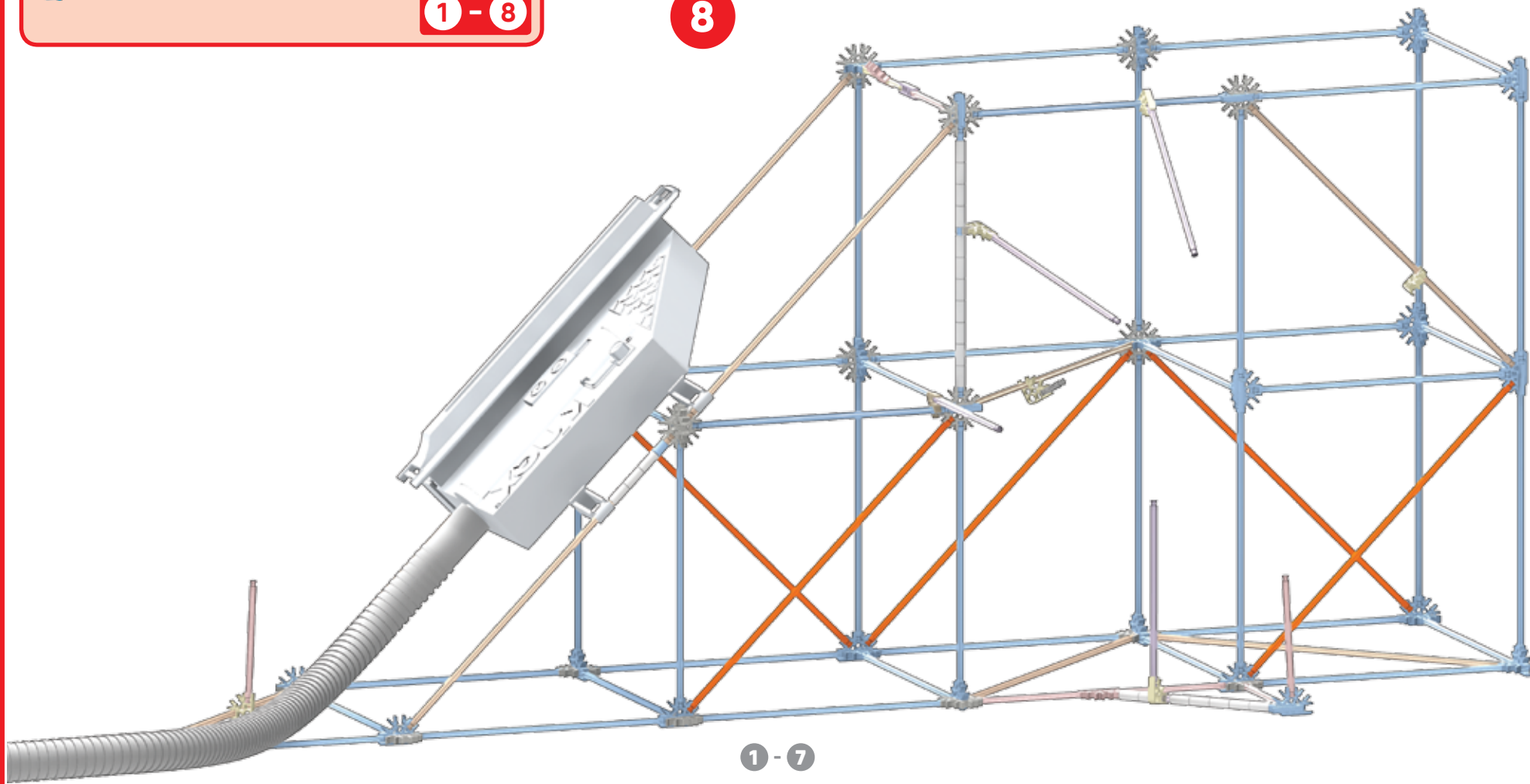

5

1 - 9

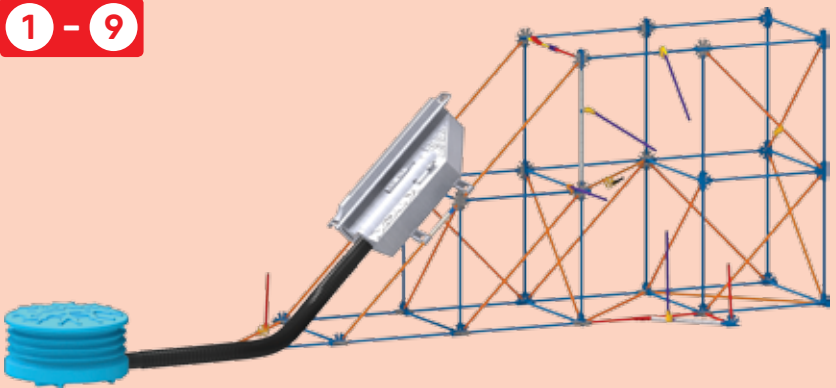



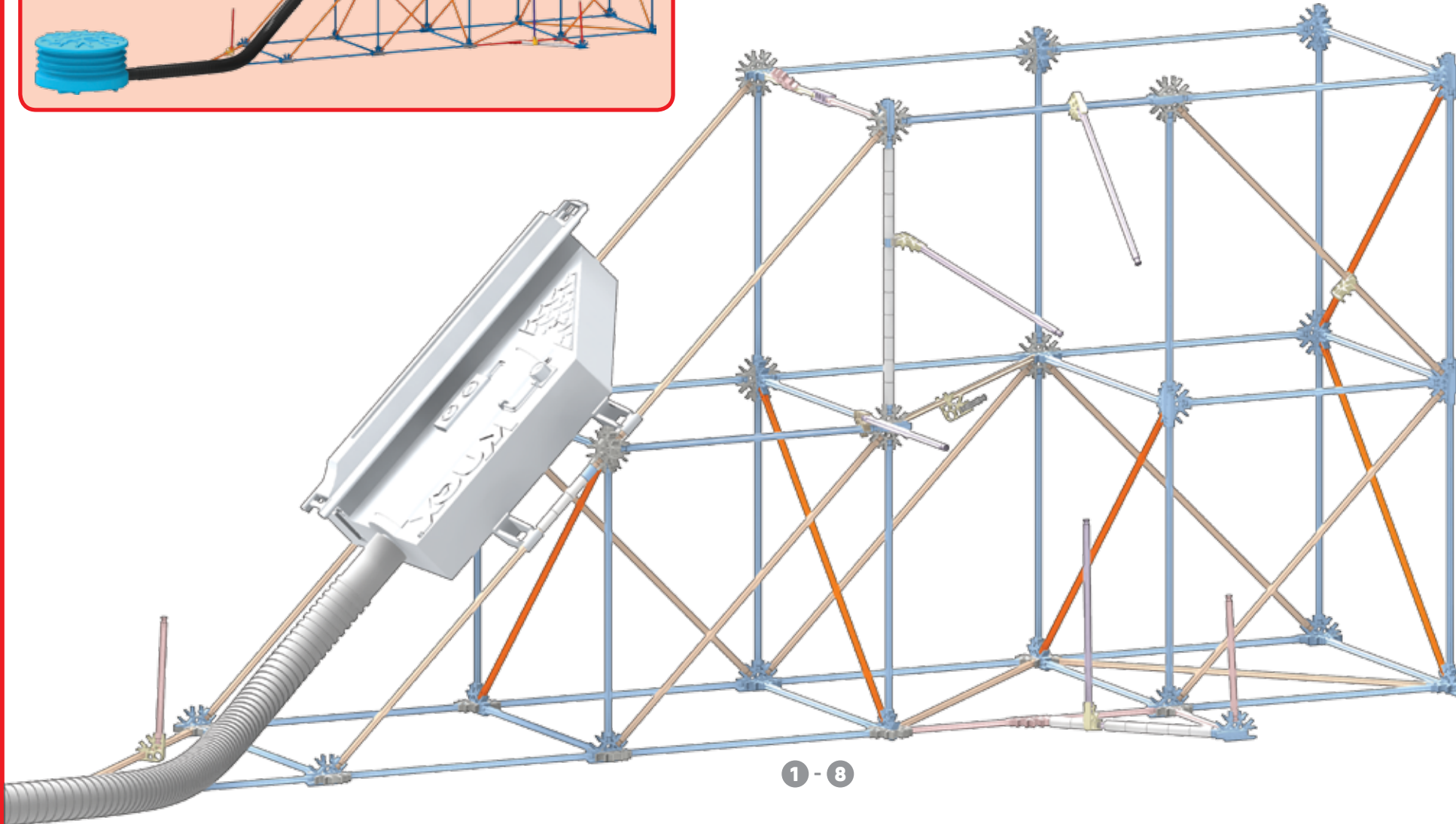





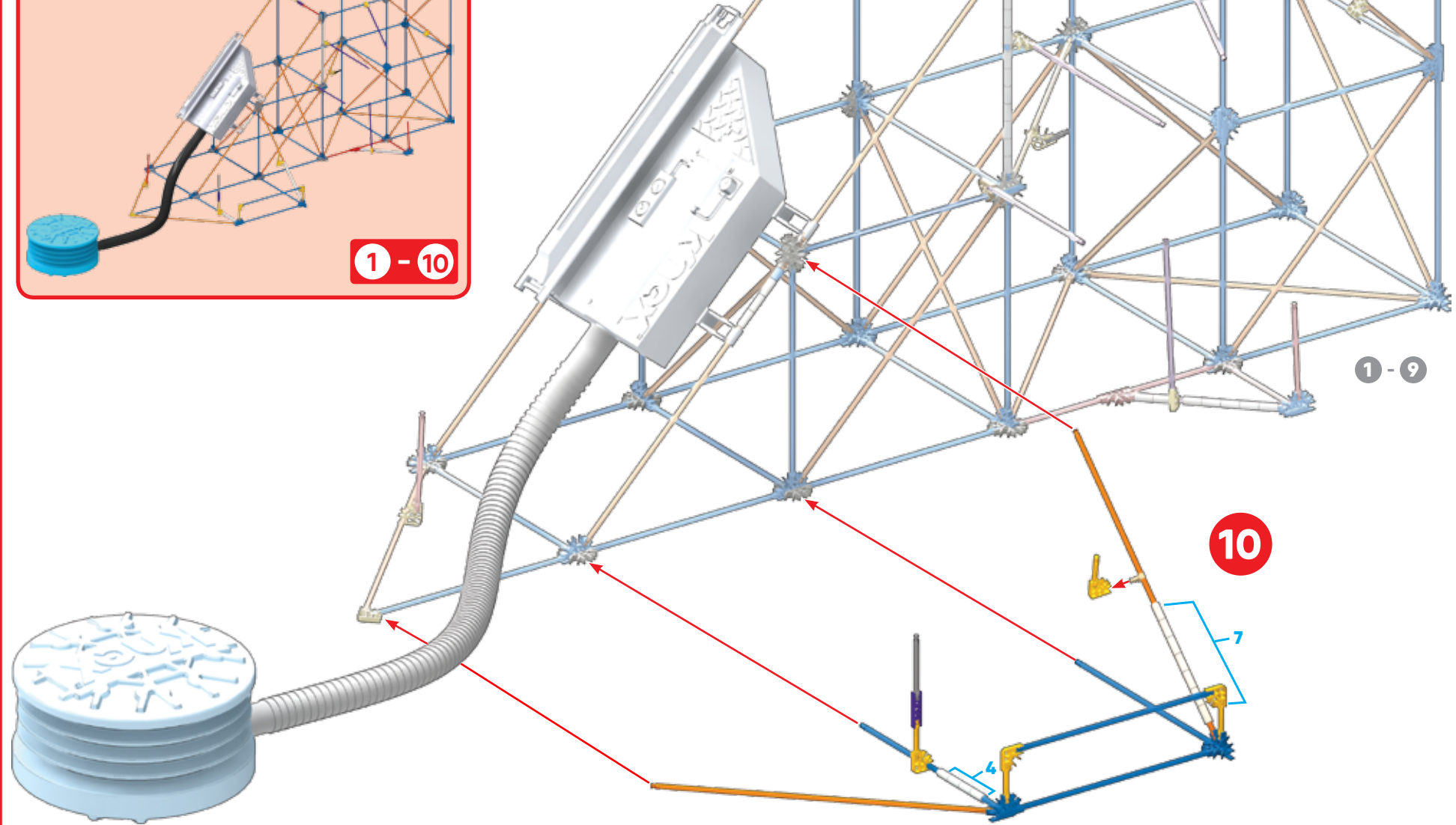
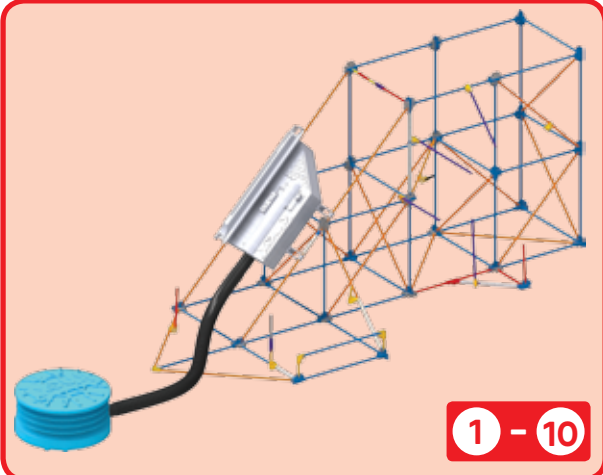





9

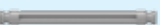

1 - 8

- 1 11 1 4 4
- 4
- 1
- 4
- 2



- 15  1  1  6  1  1  2 
- 1 
- 2 
- 1 
- 1 
- 7 
- 1 

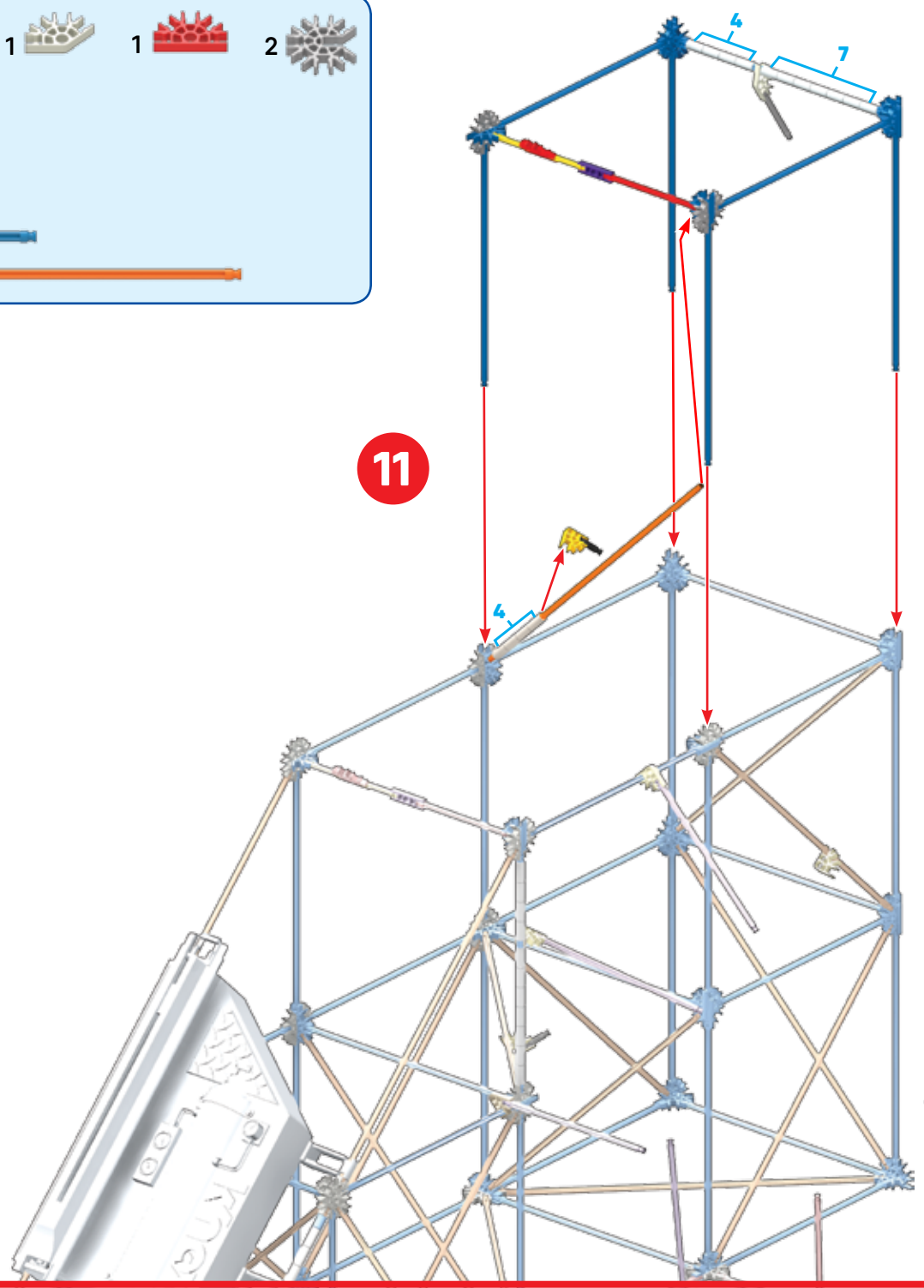
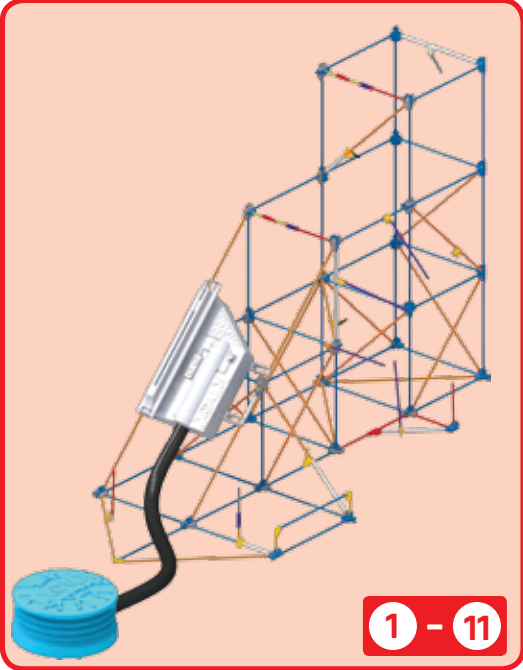

7 

1 - 12

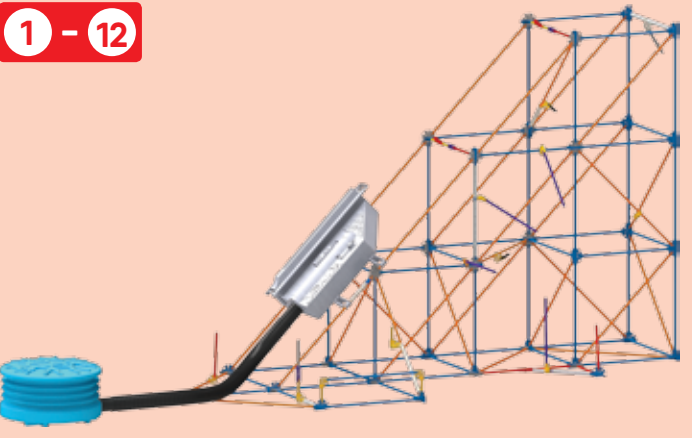

12

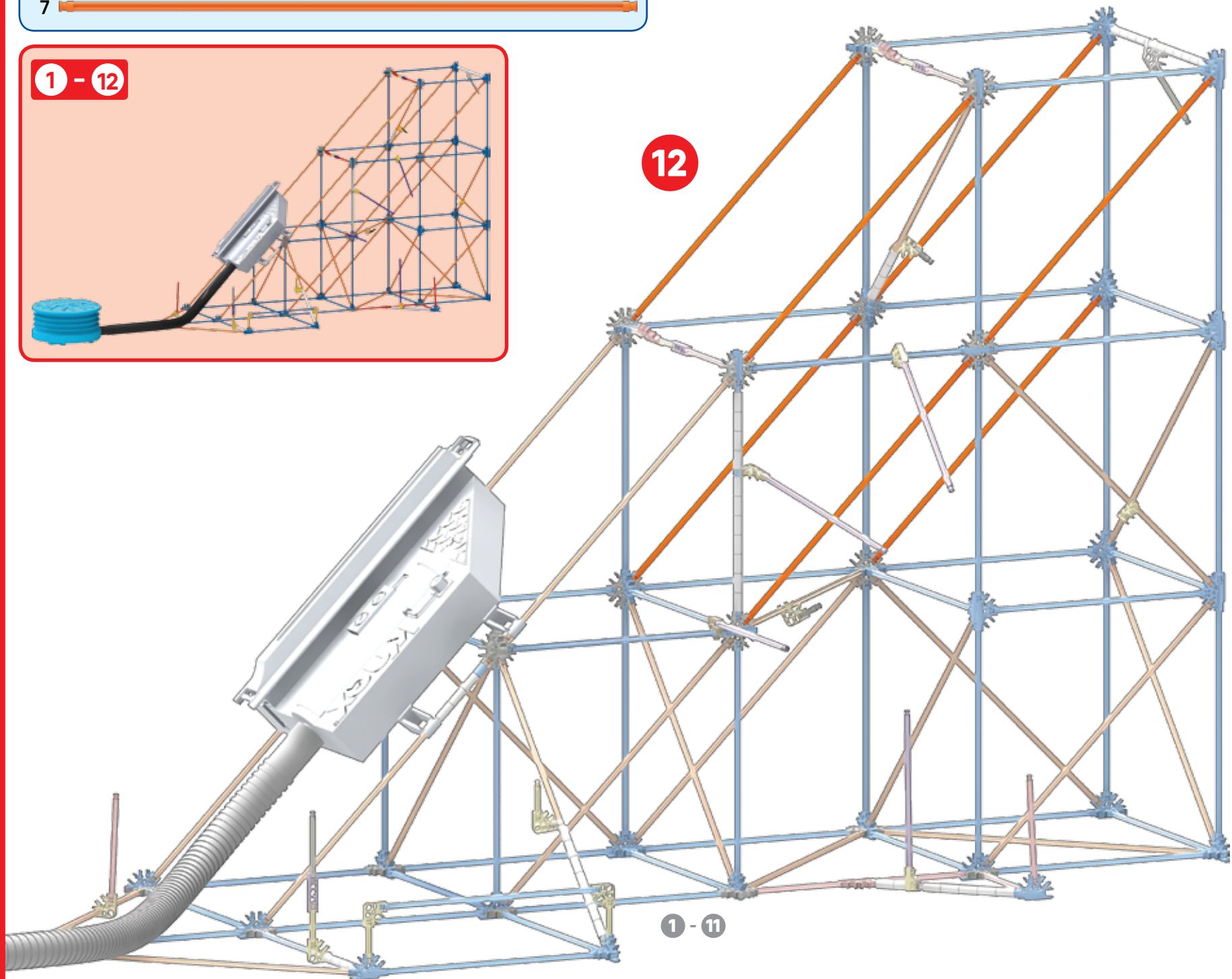

1 - 11

1 - 13

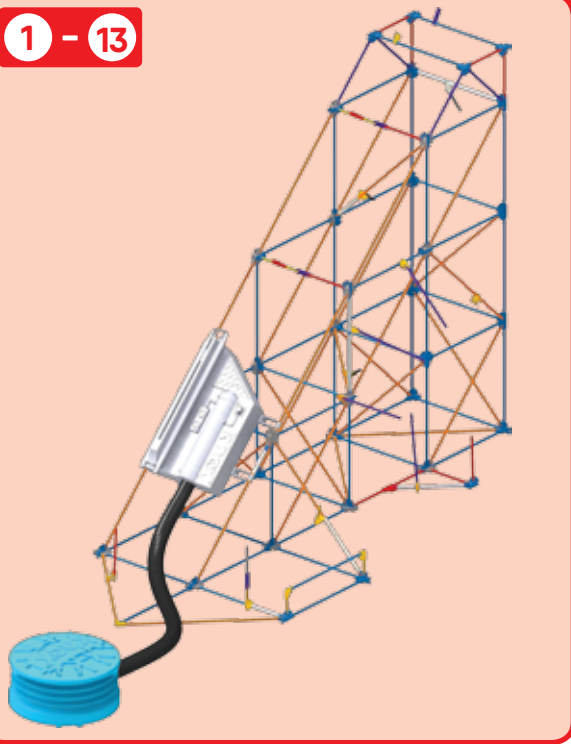

13

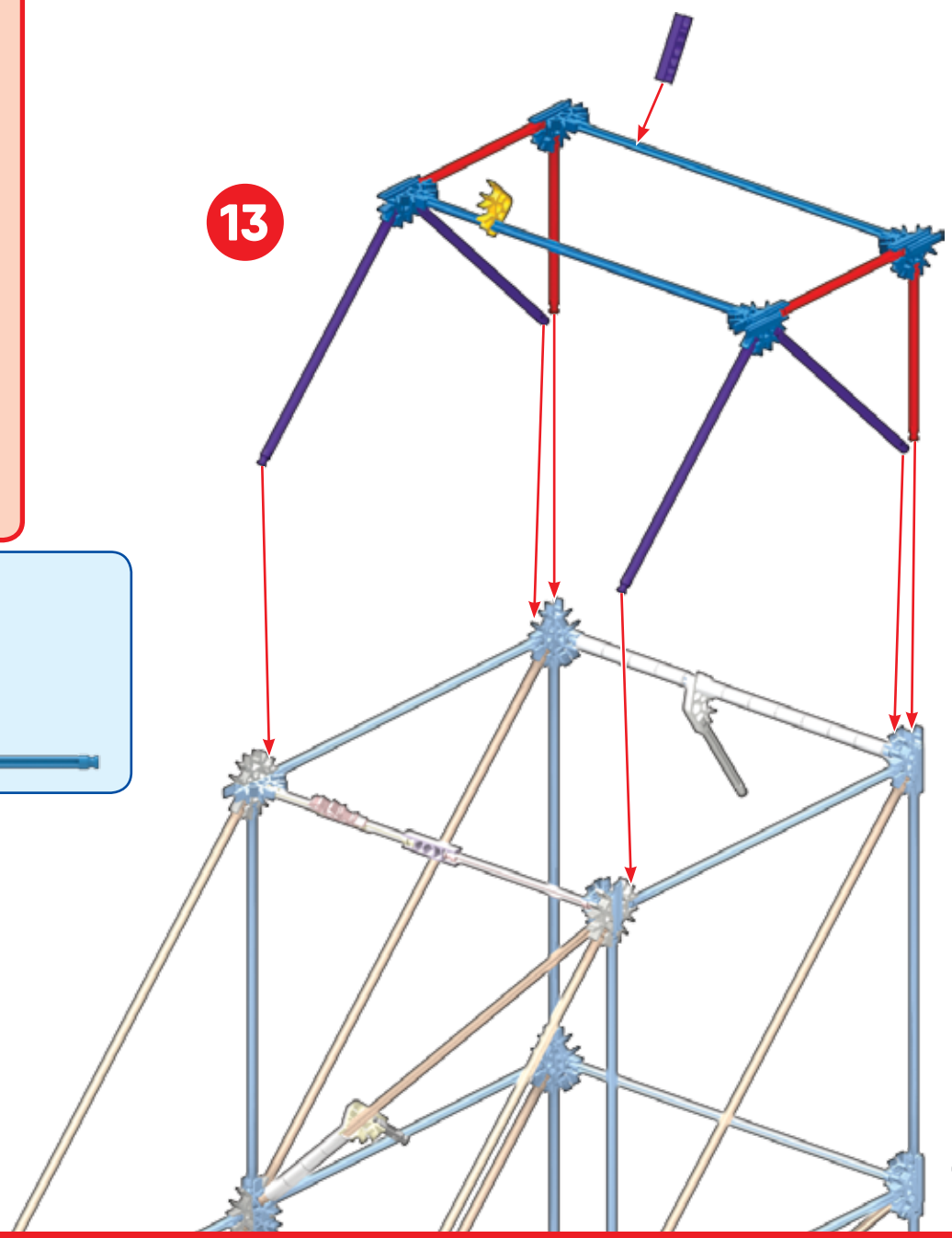

- 1  1  8 
- 4 
- 4 
- 2 

1 - 12

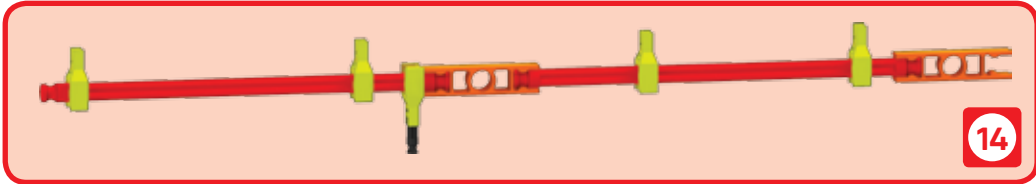

14



14

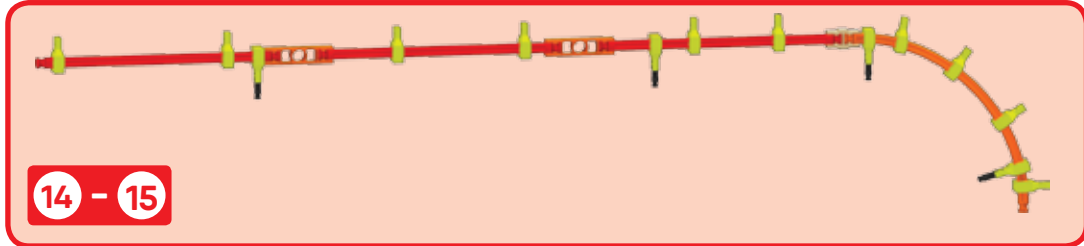

14 - 15

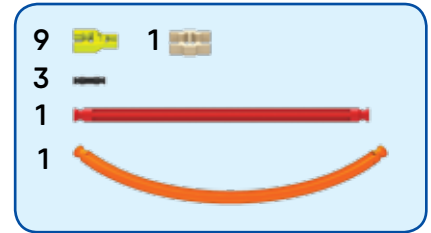

15

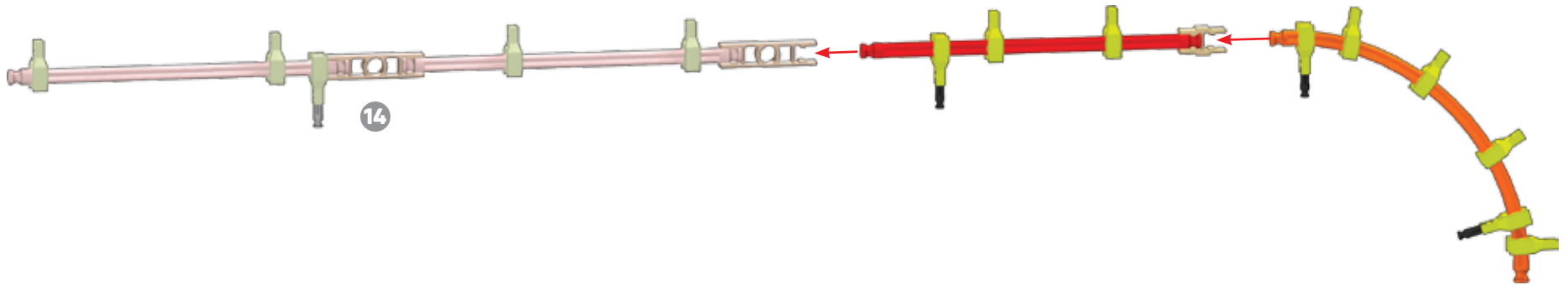

14

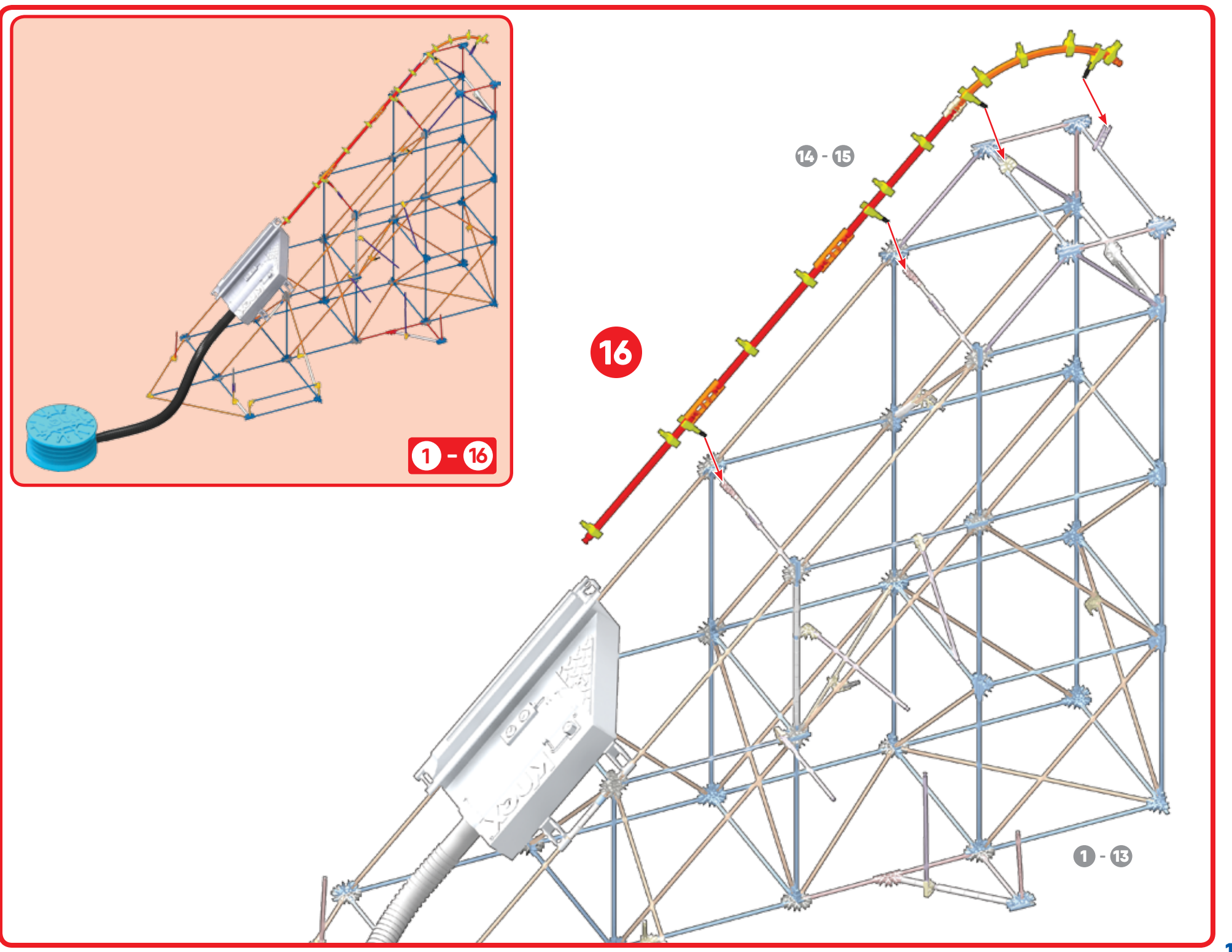

1 - 16

16

14 - 15

1 - 13

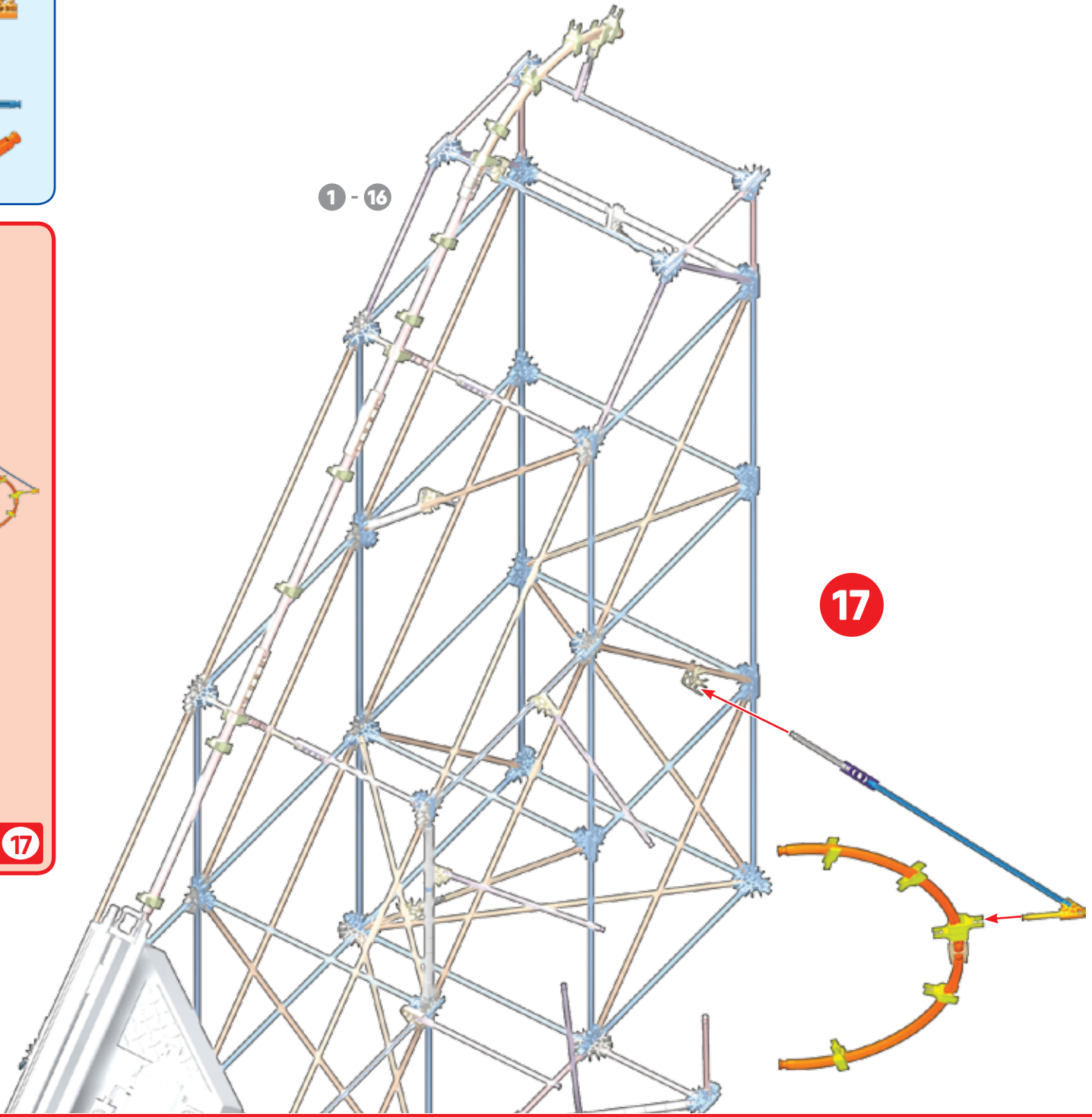
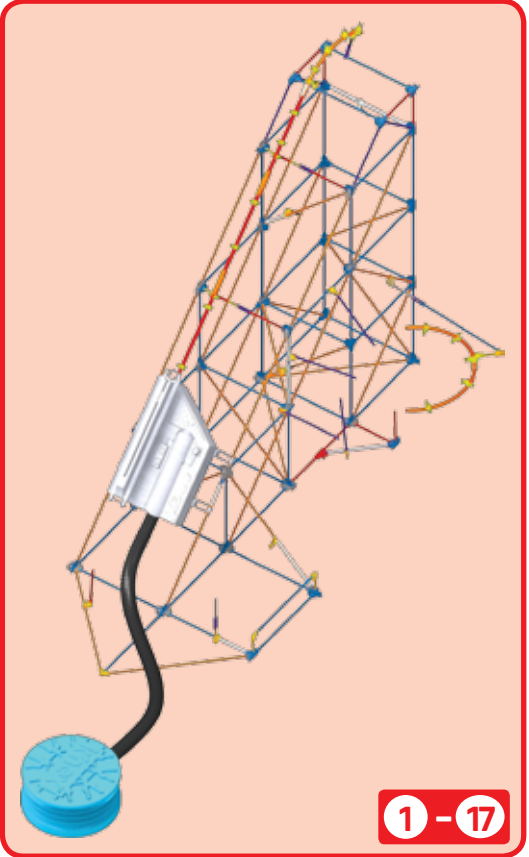
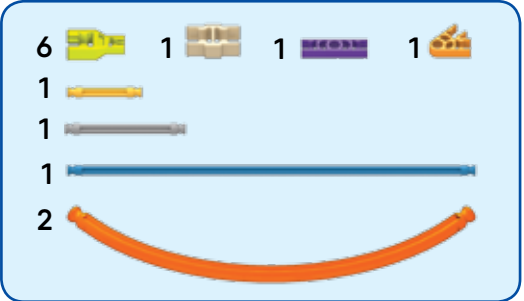

6

2



18

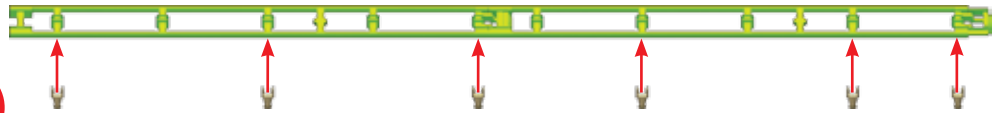

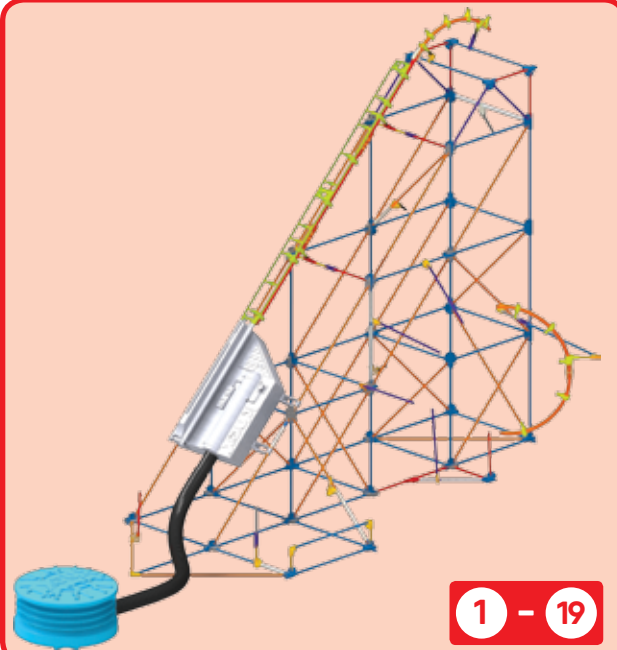

Attach the connectors to the track exactly as shown. Be sure to push the connectors on firmly until they "click".

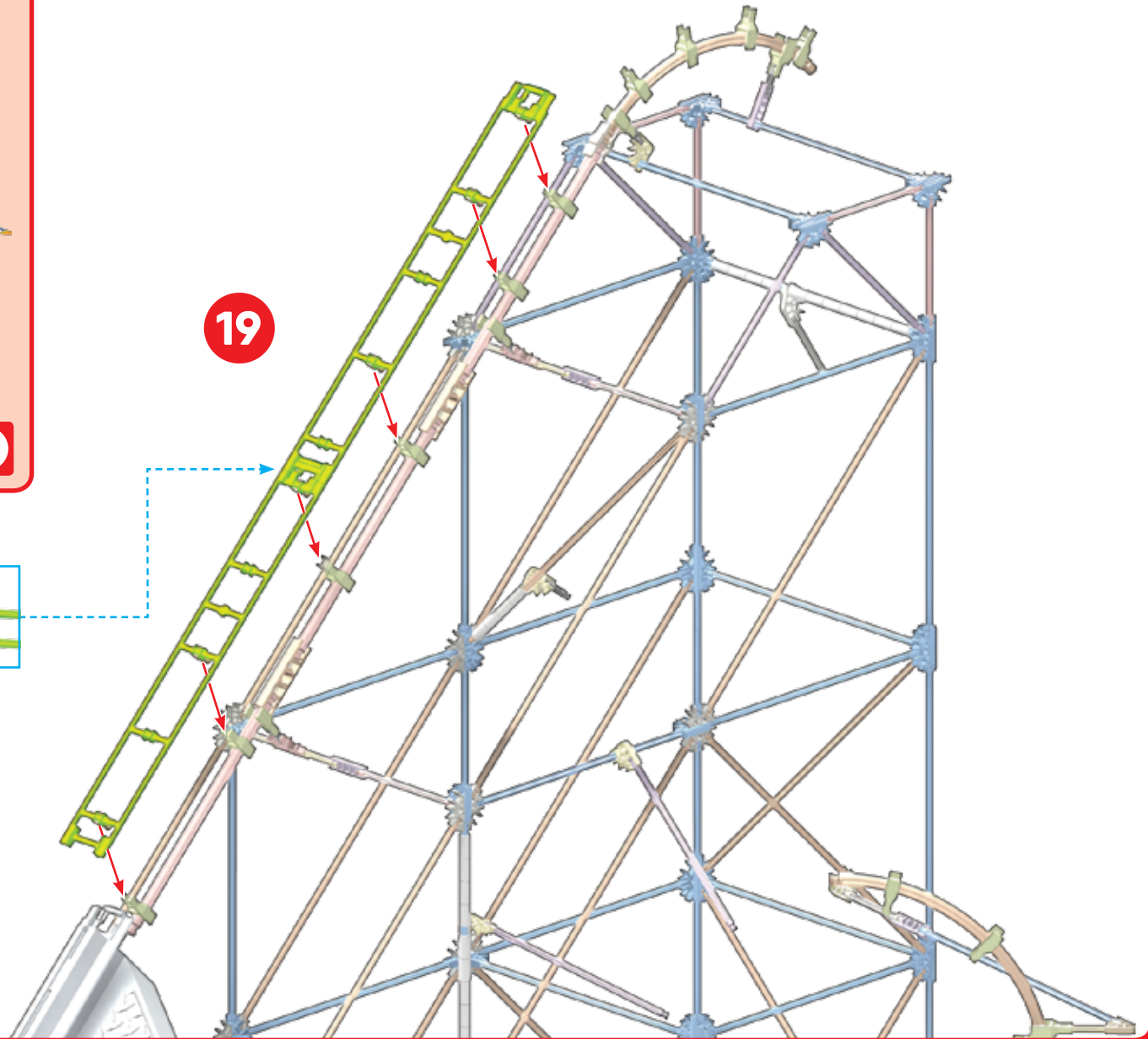
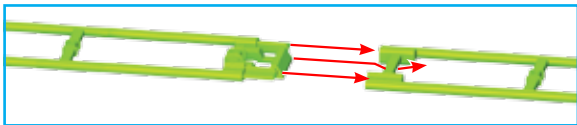

1 - 19

19



4  1 



20

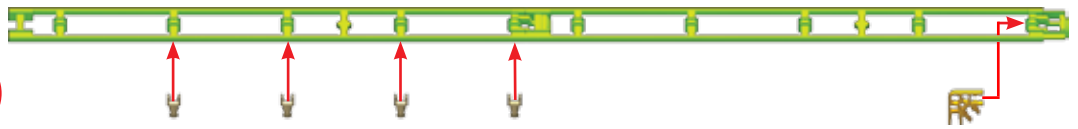

1 - 21

Always join this end of the track to the previous track piece first, then connect the rest of the track to the tower.

21

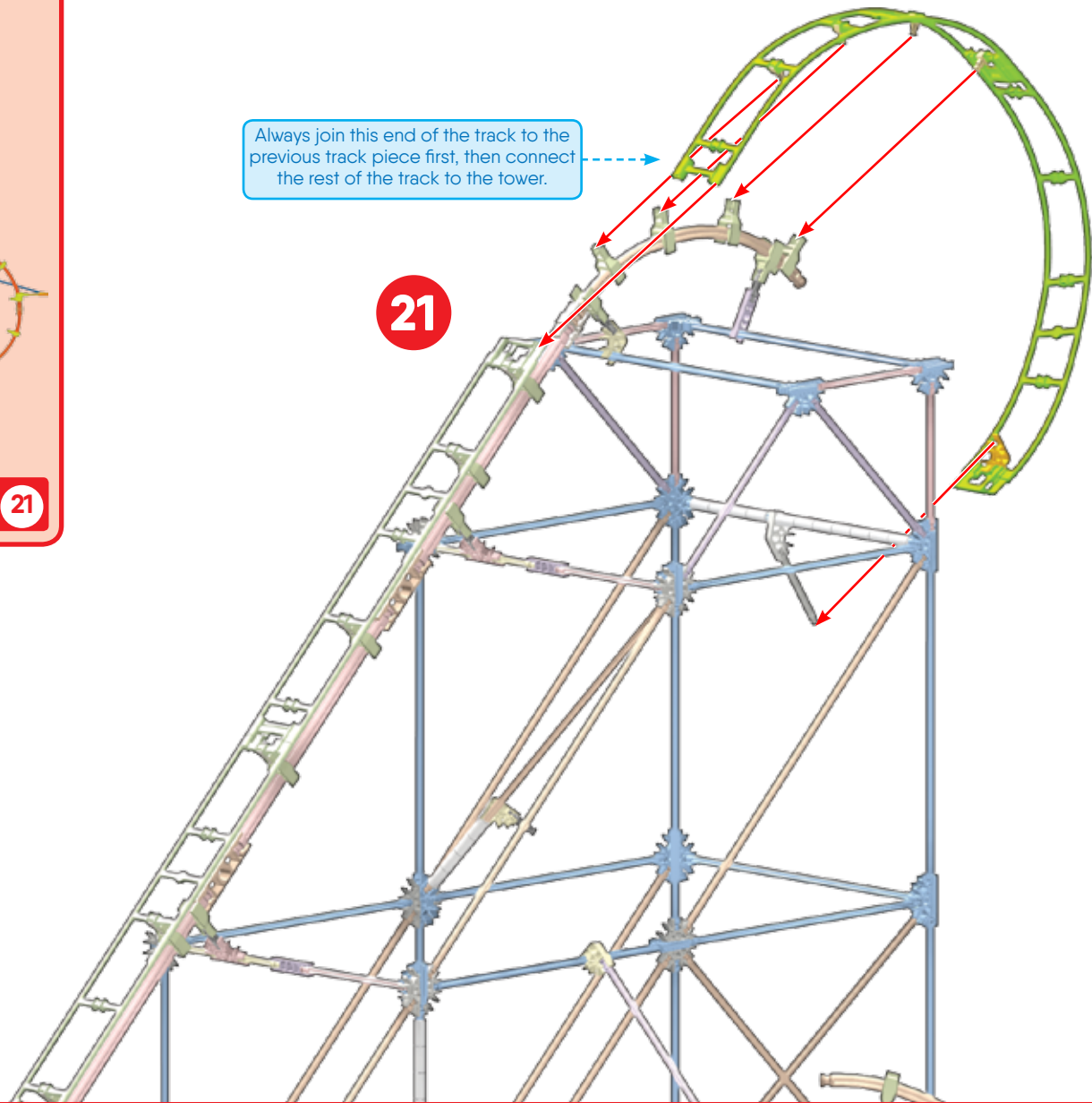

22

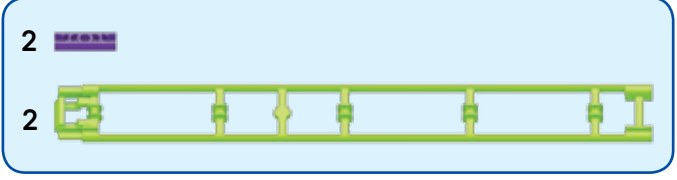

23



1 - 23



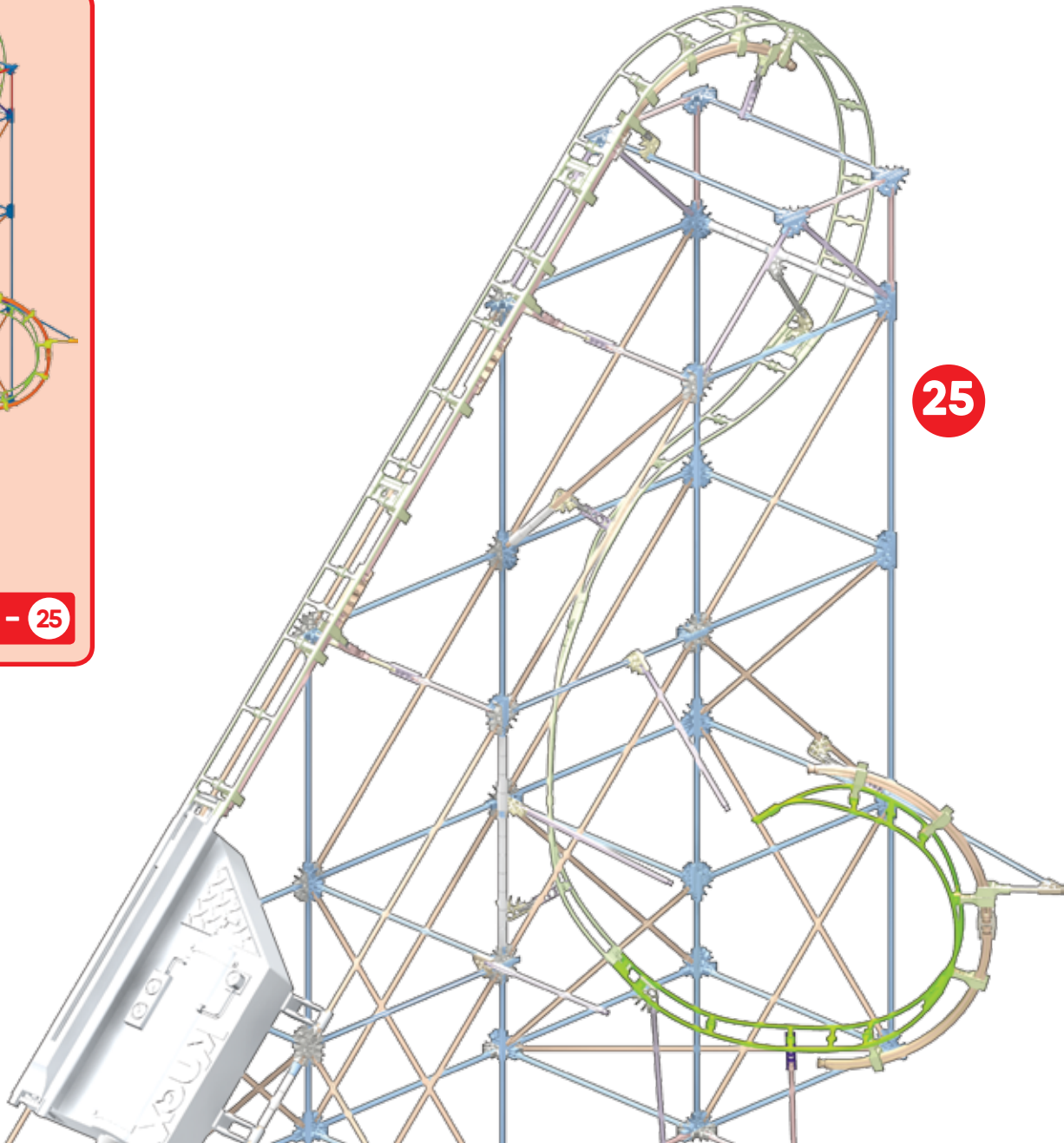
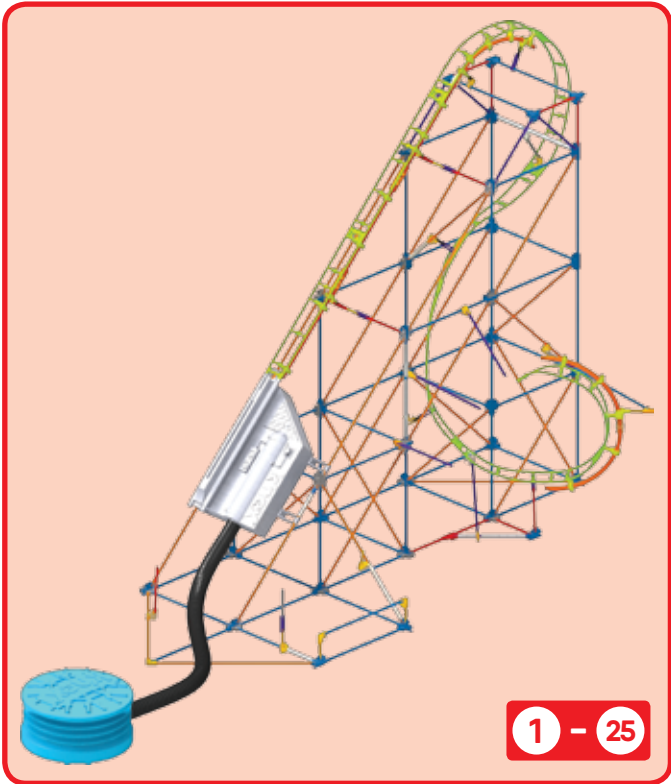
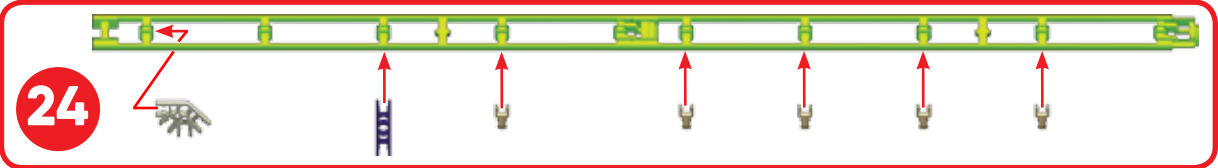
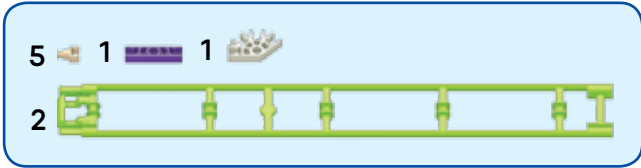

3  1 

