

# LIGHTNING FLASH ROLLER COASTER™

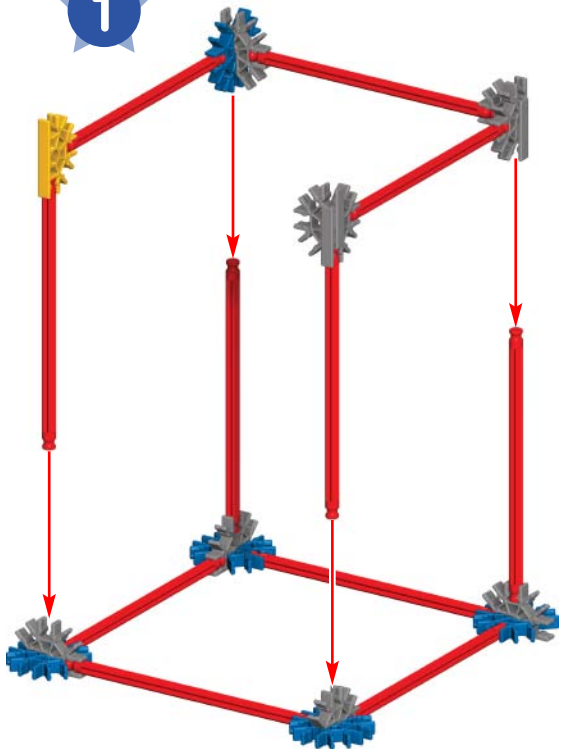

1



1

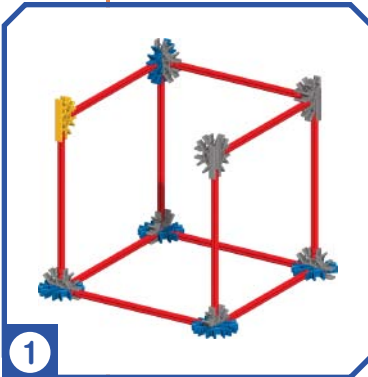

2

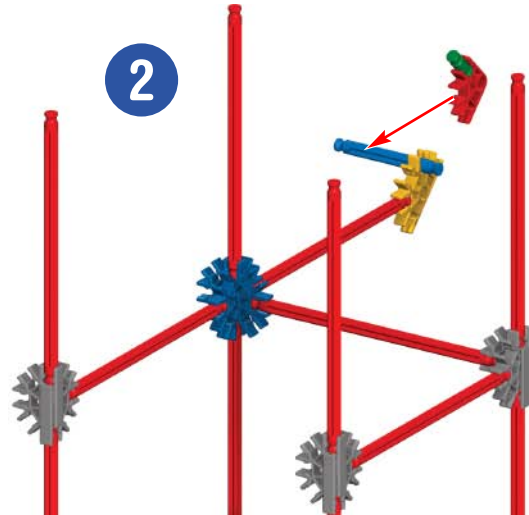

1

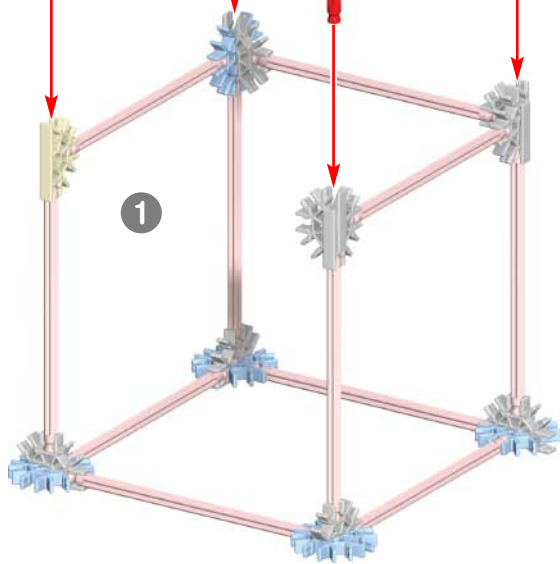

1 - 2

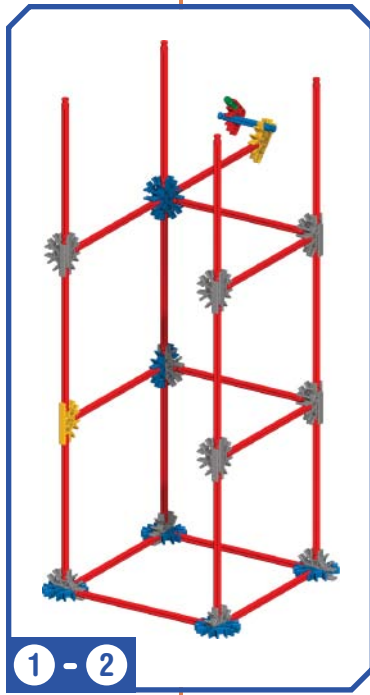

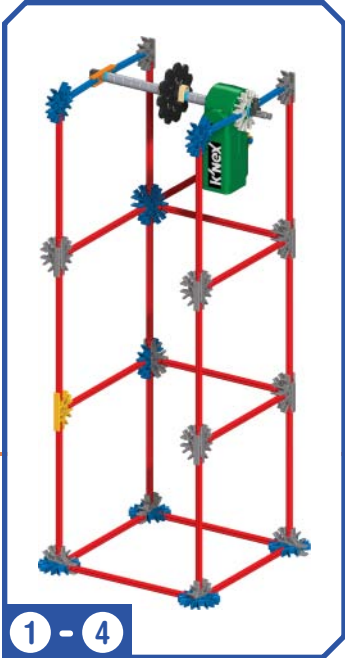
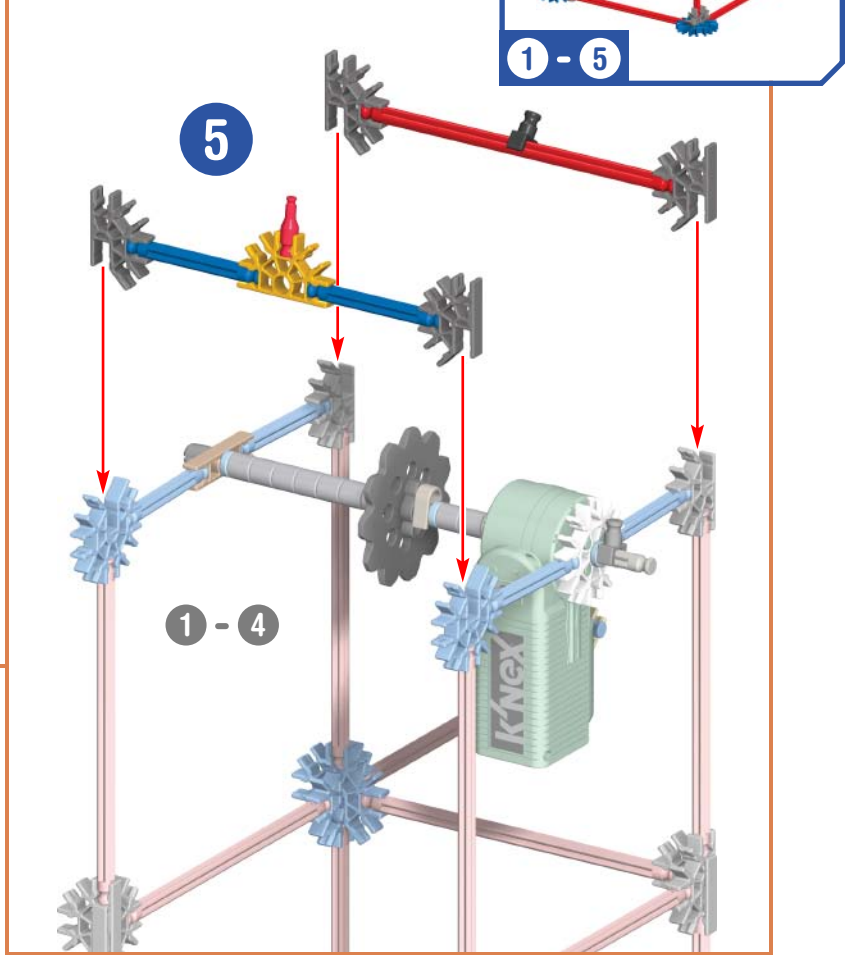
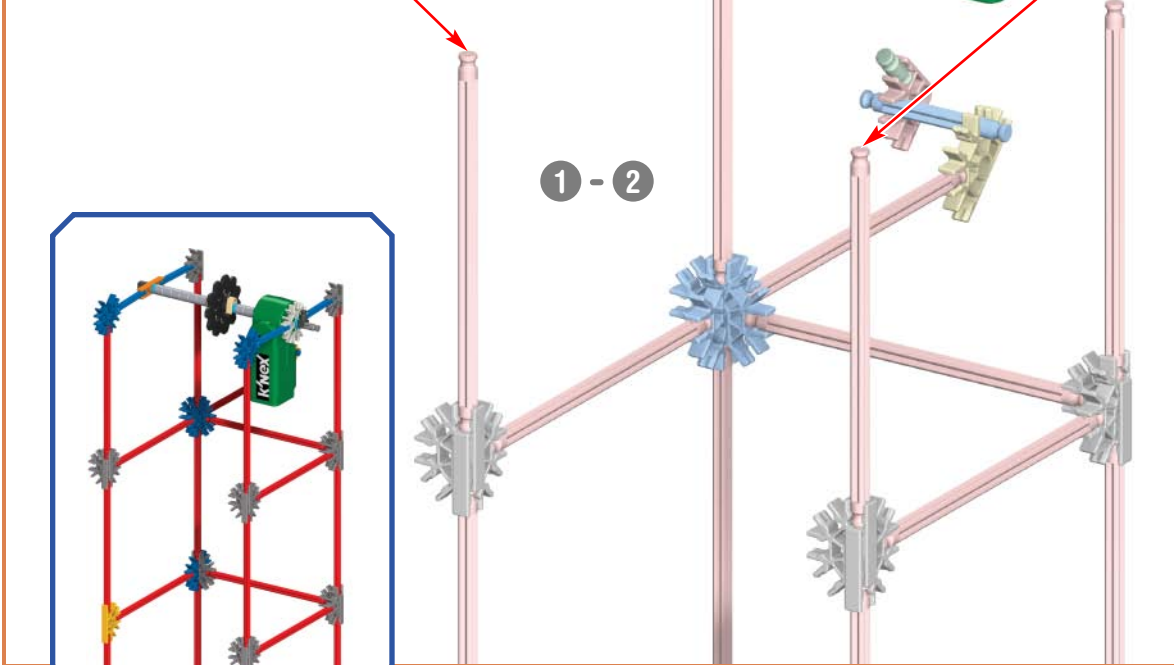
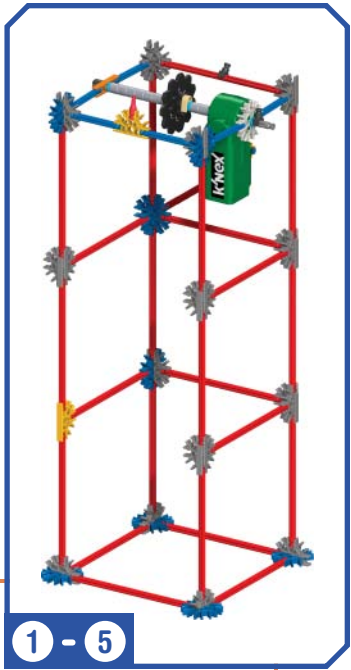
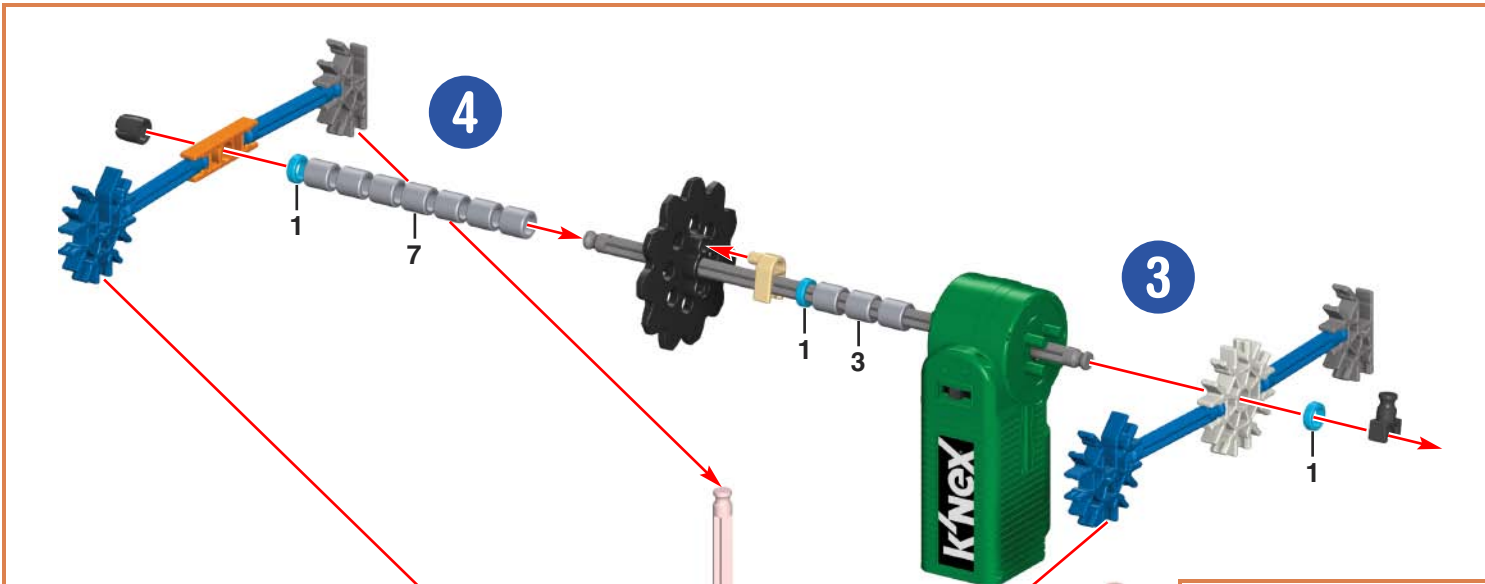

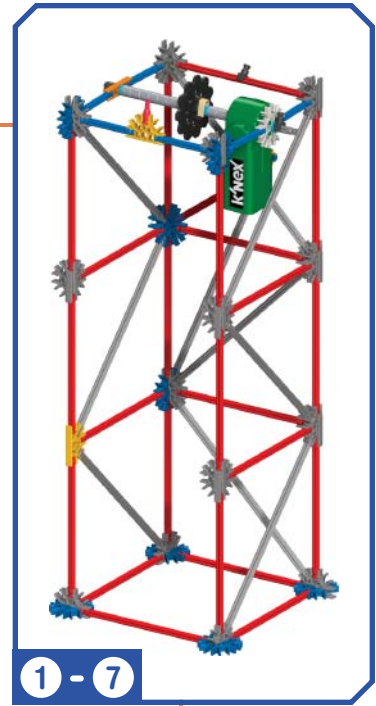
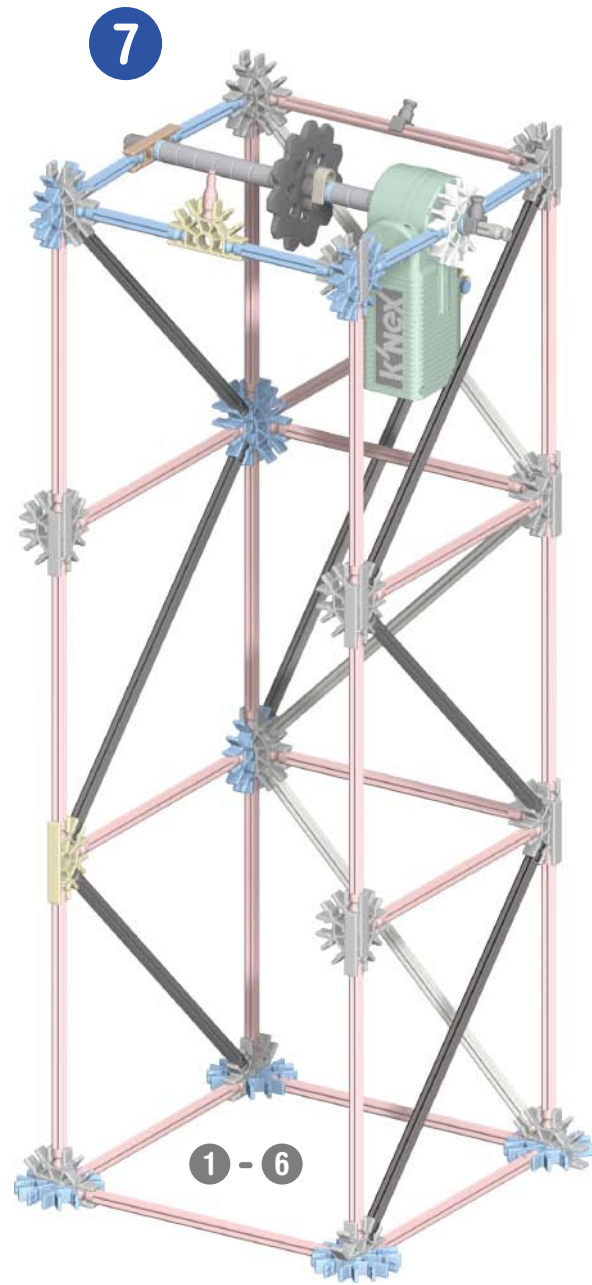
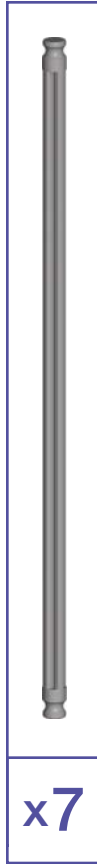
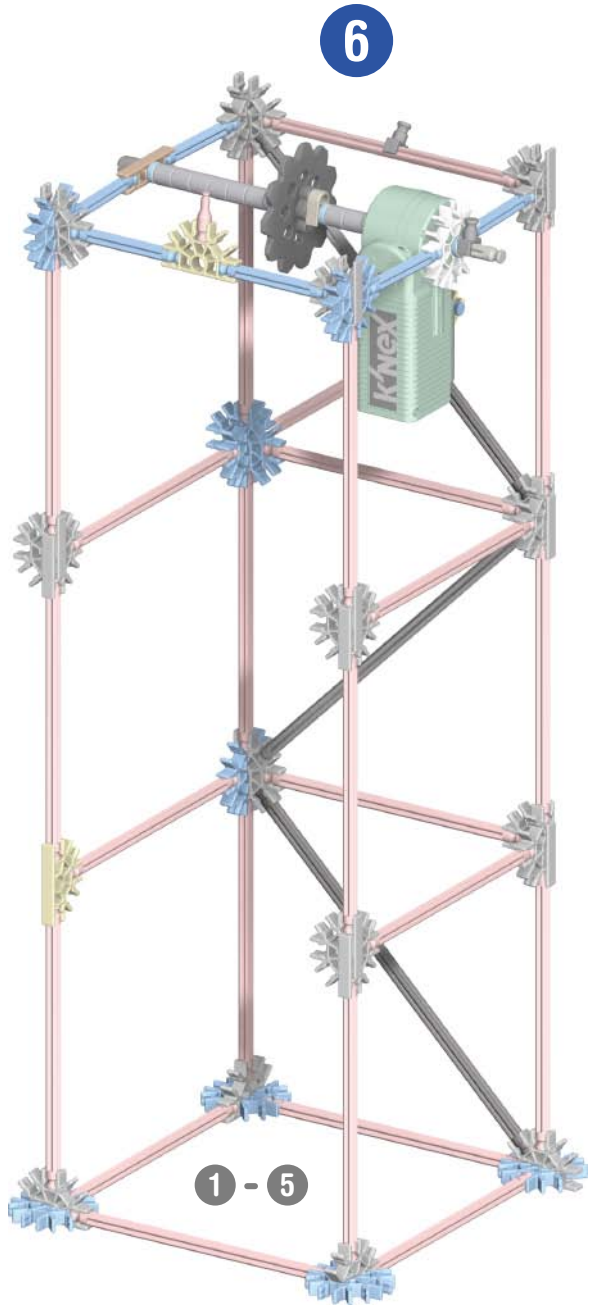
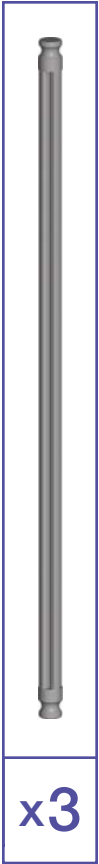

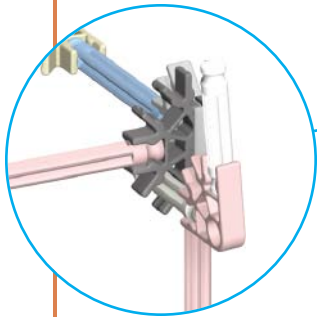

8

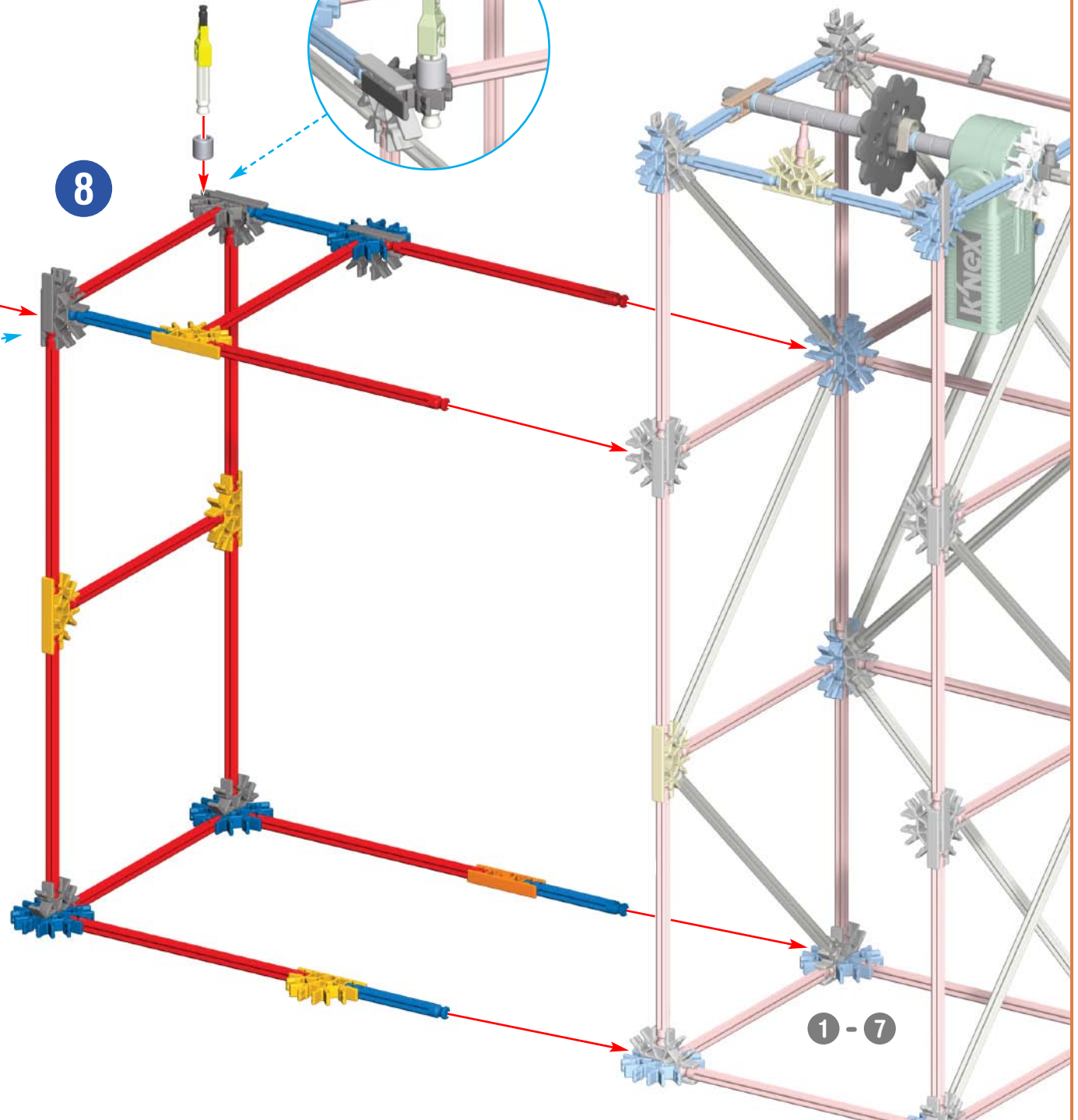
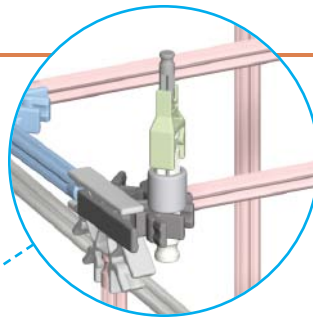

1 - 7

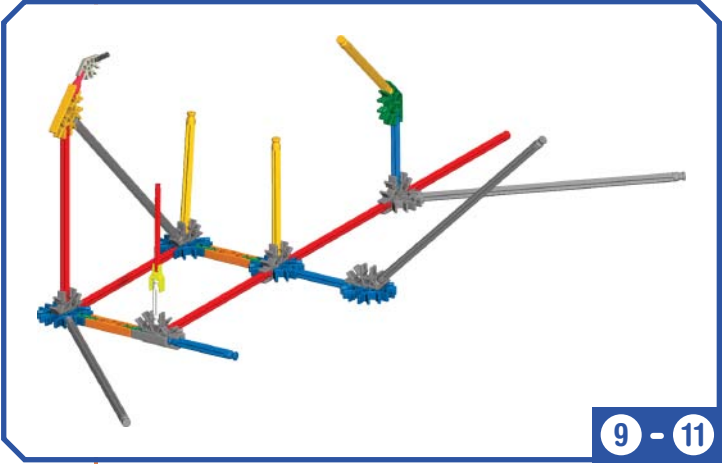
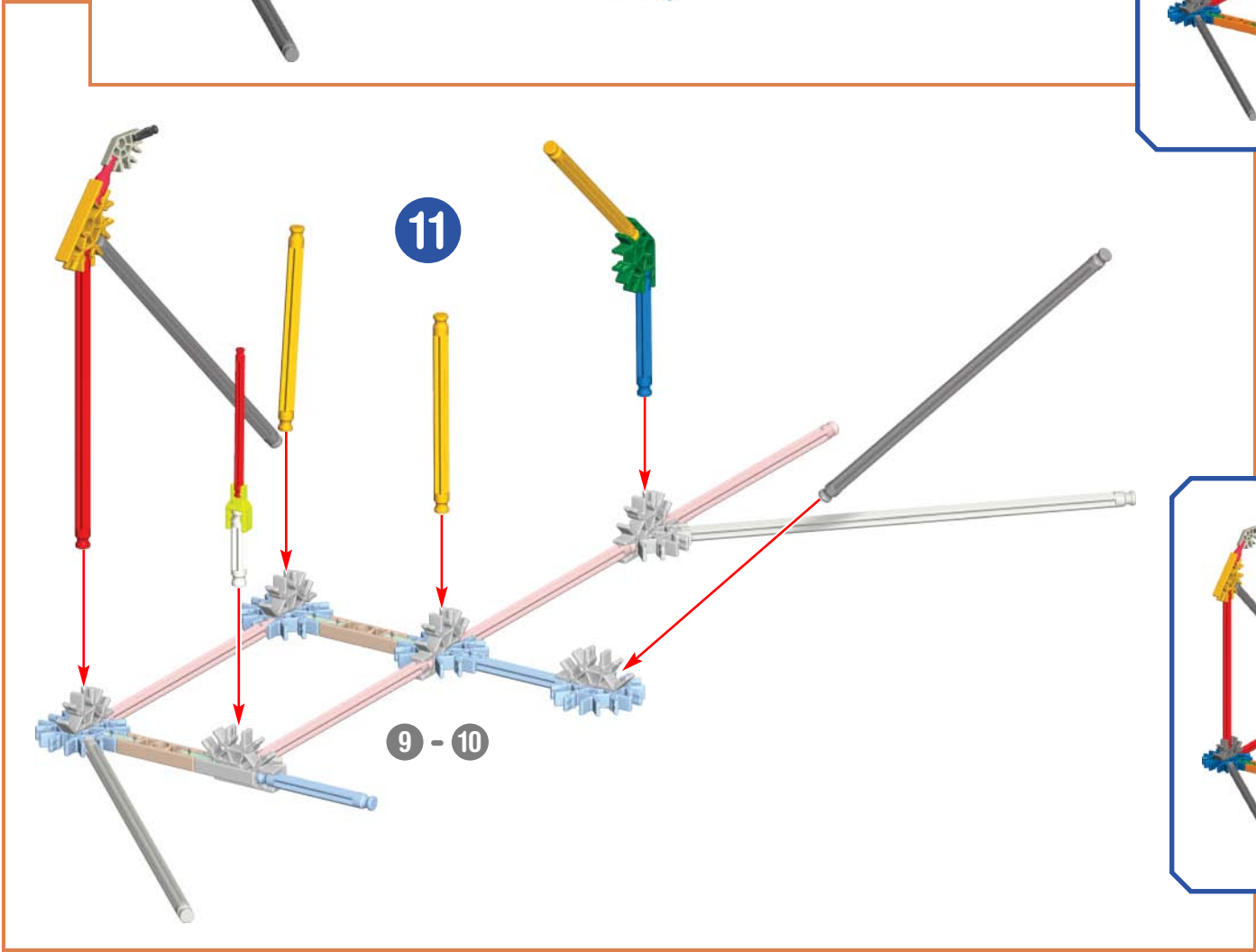
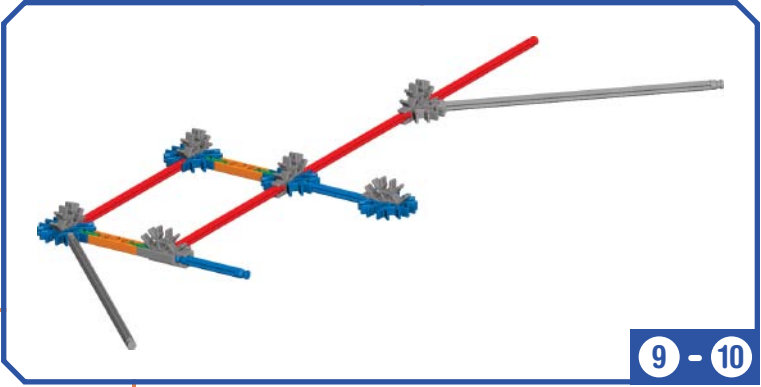
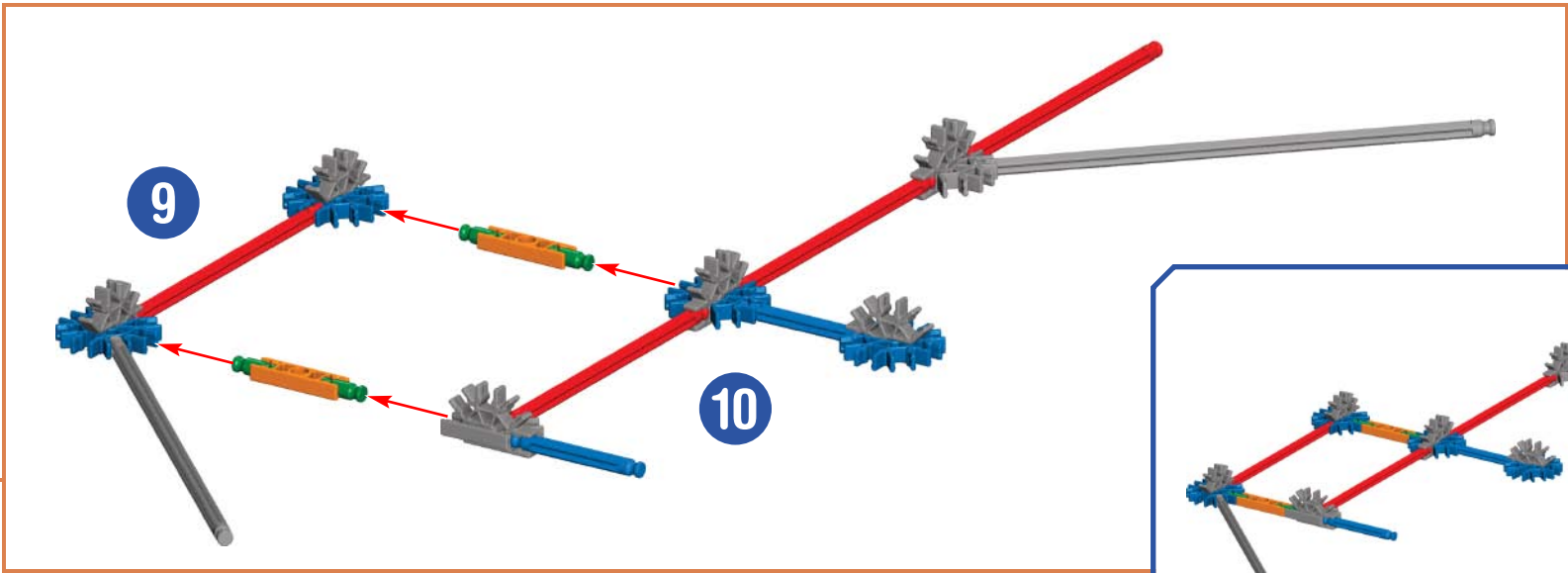

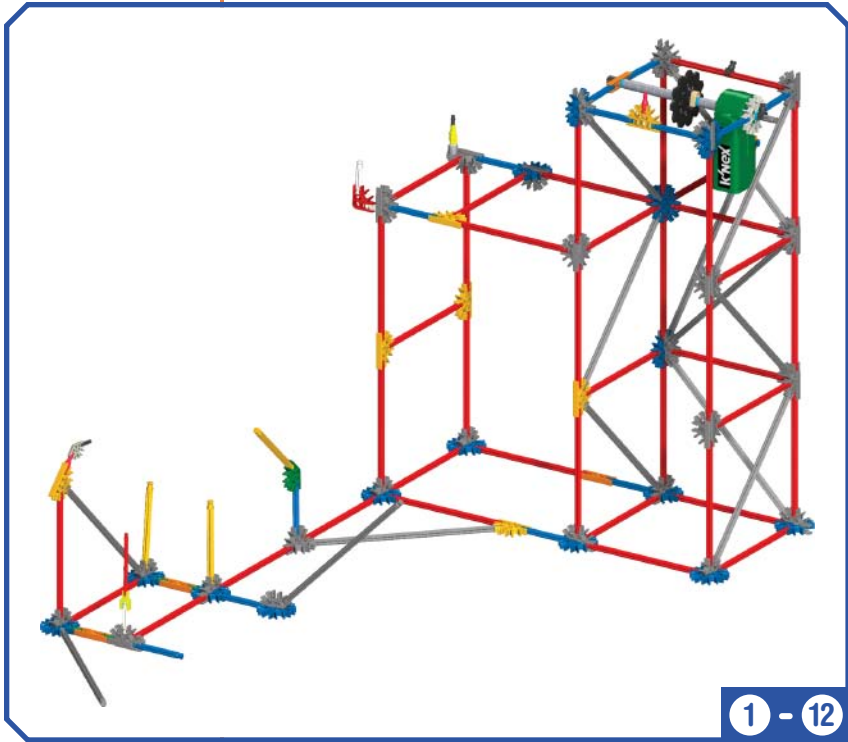

1 - 12

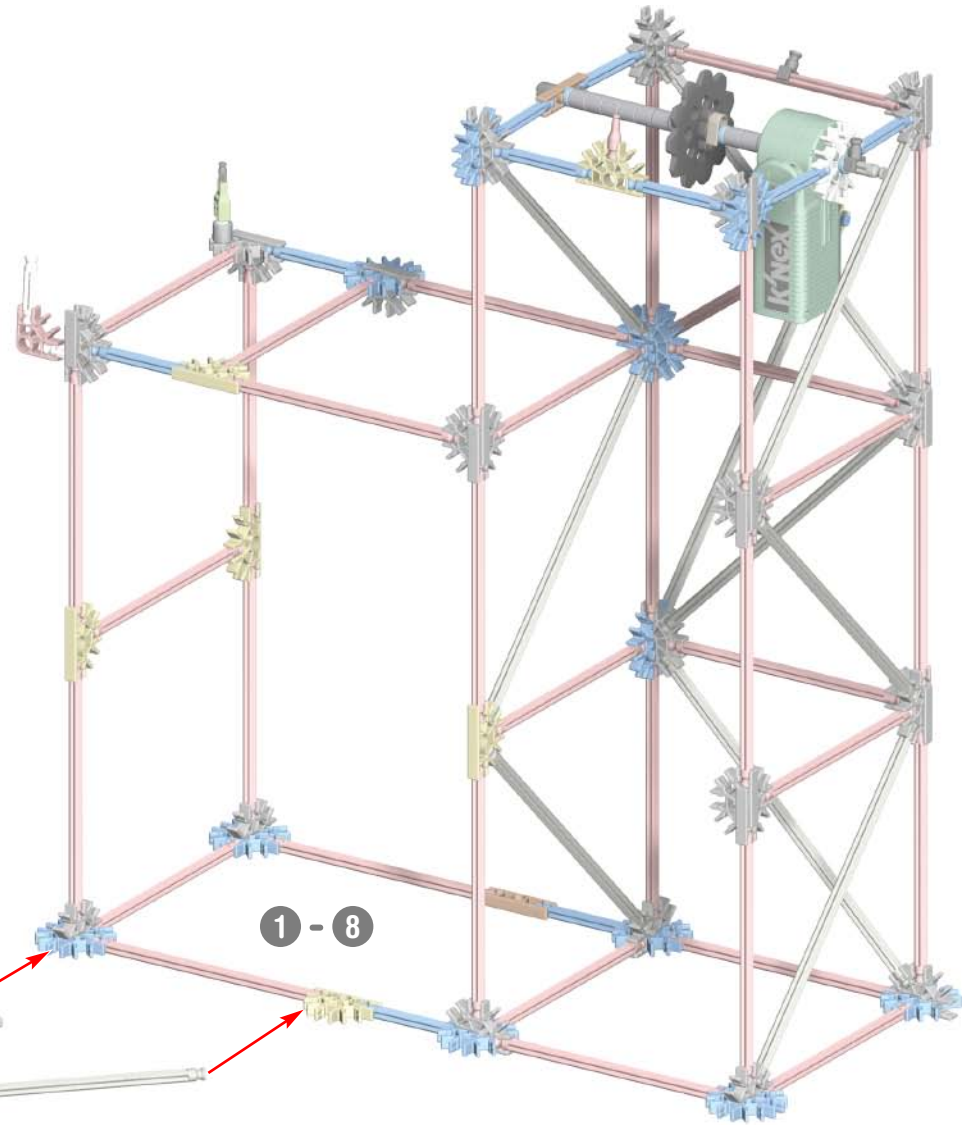

12

1 - 8

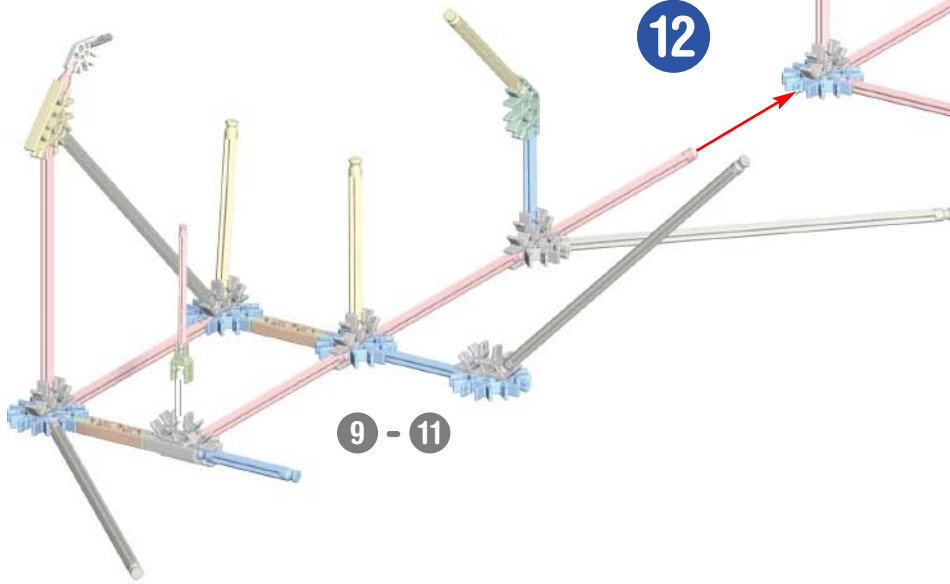

9 - 11

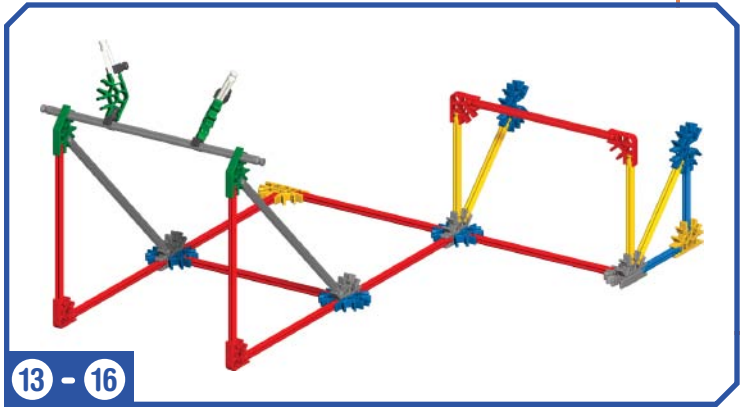
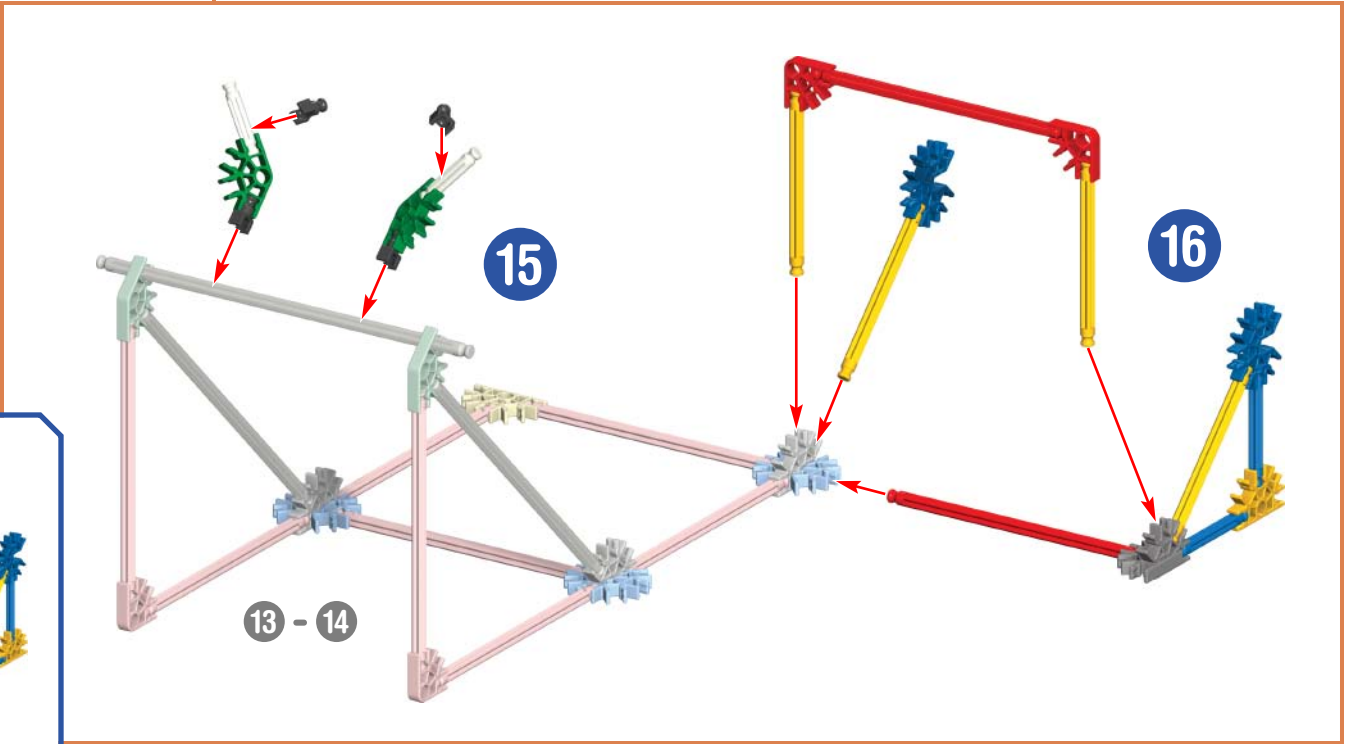
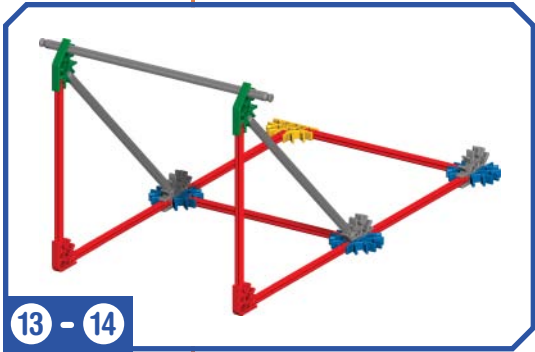
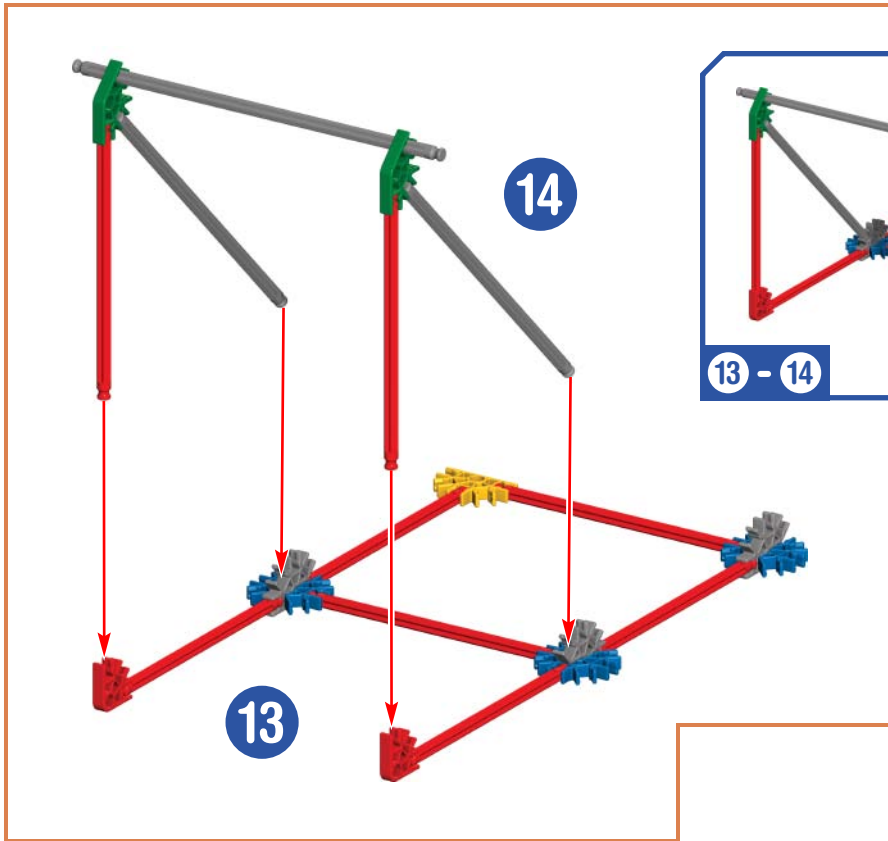

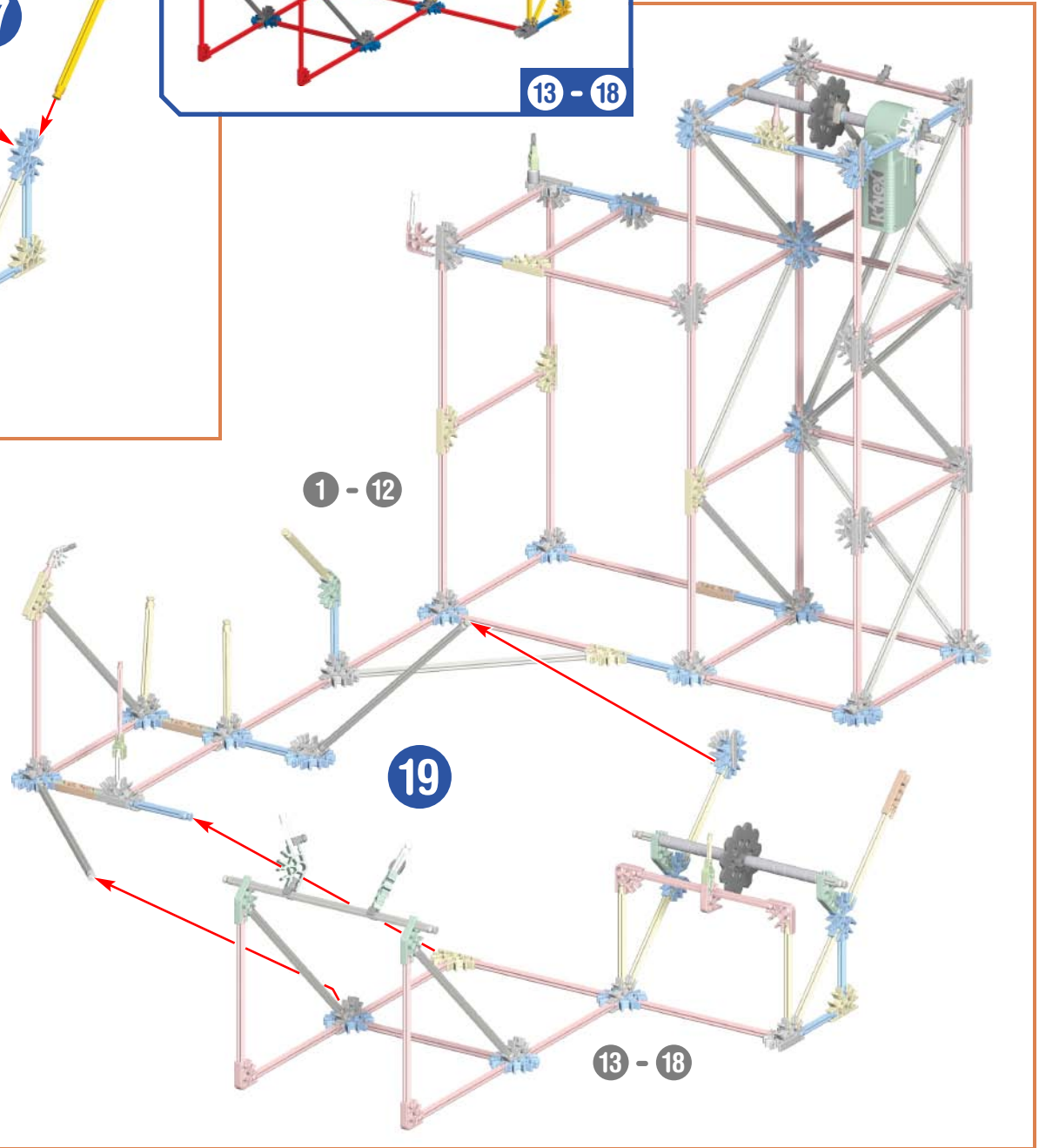
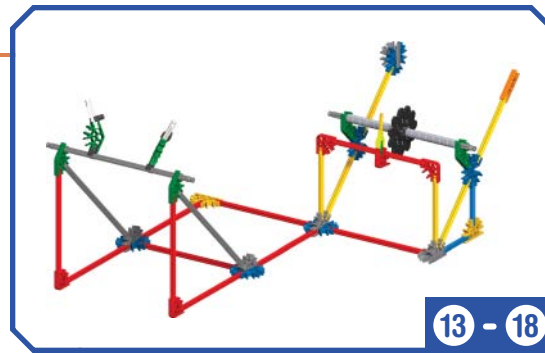
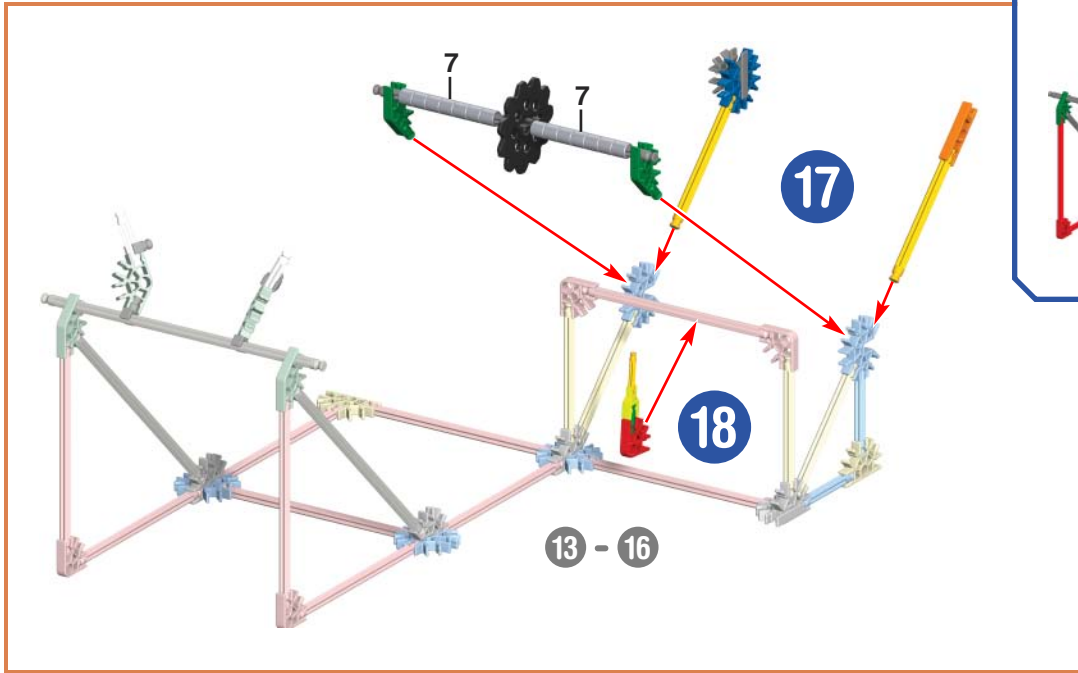

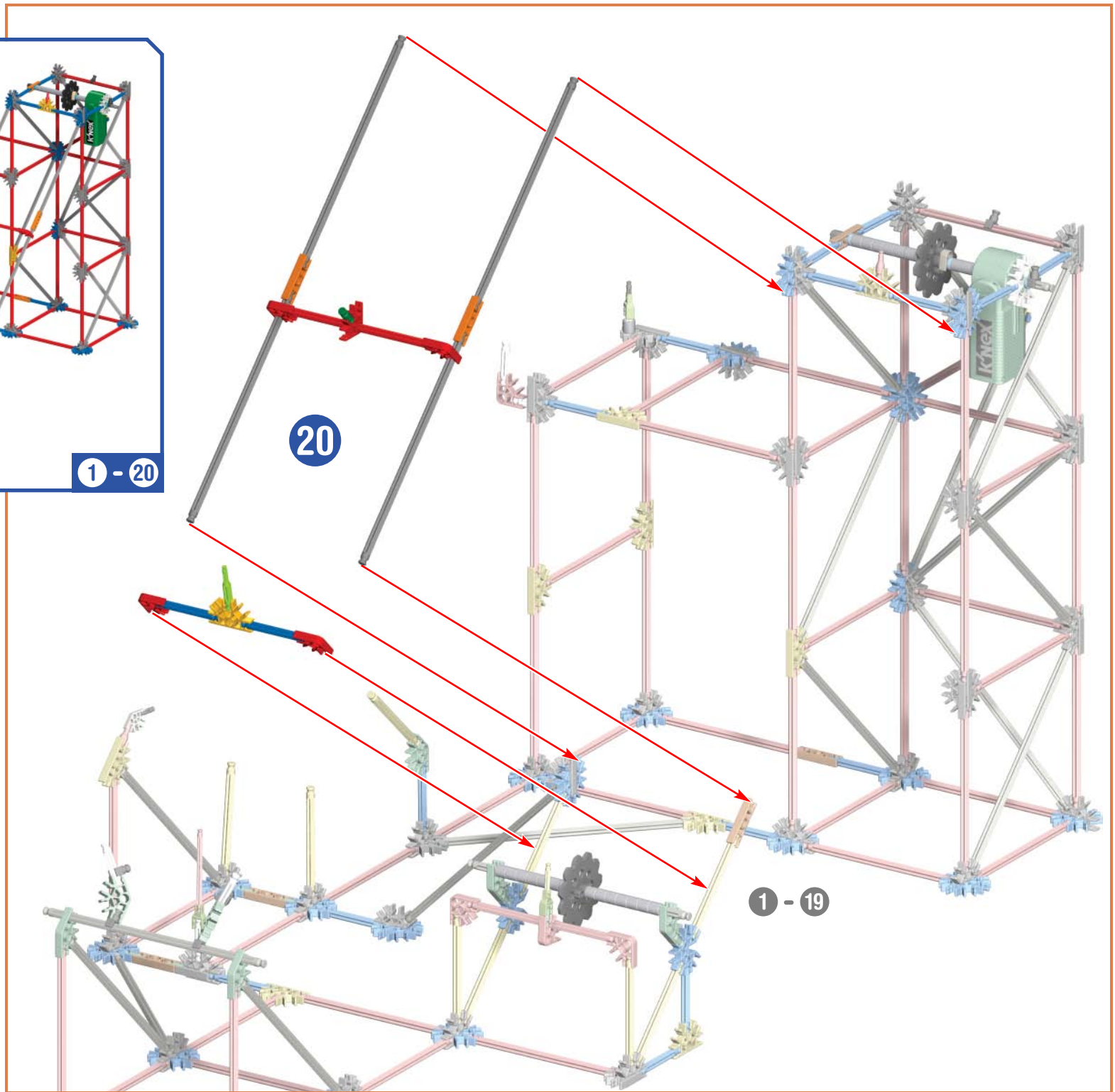

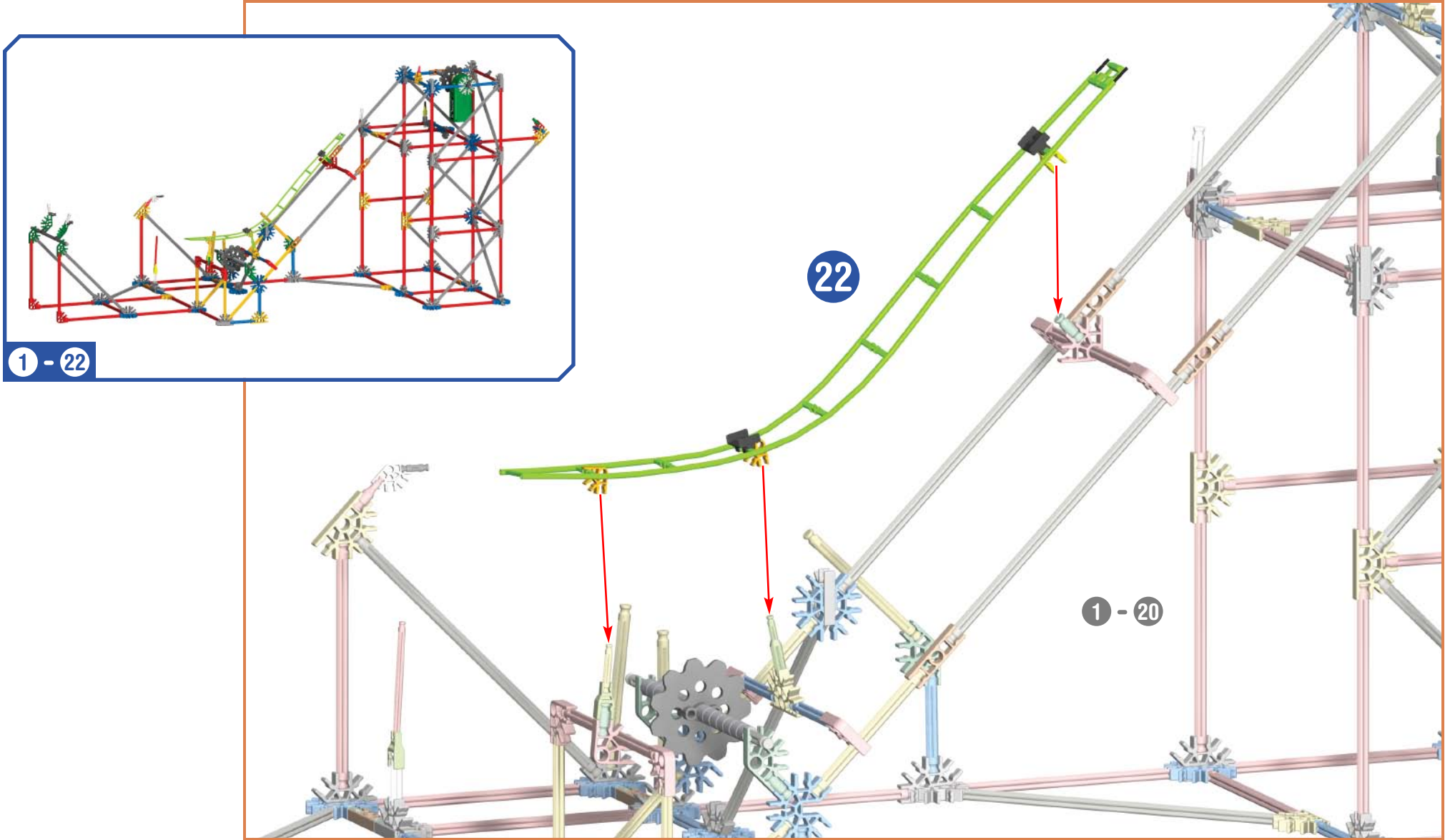
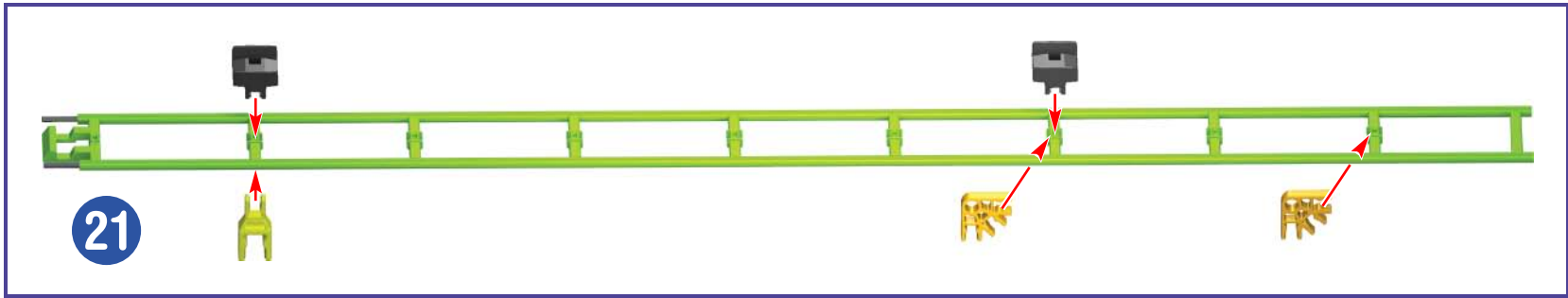

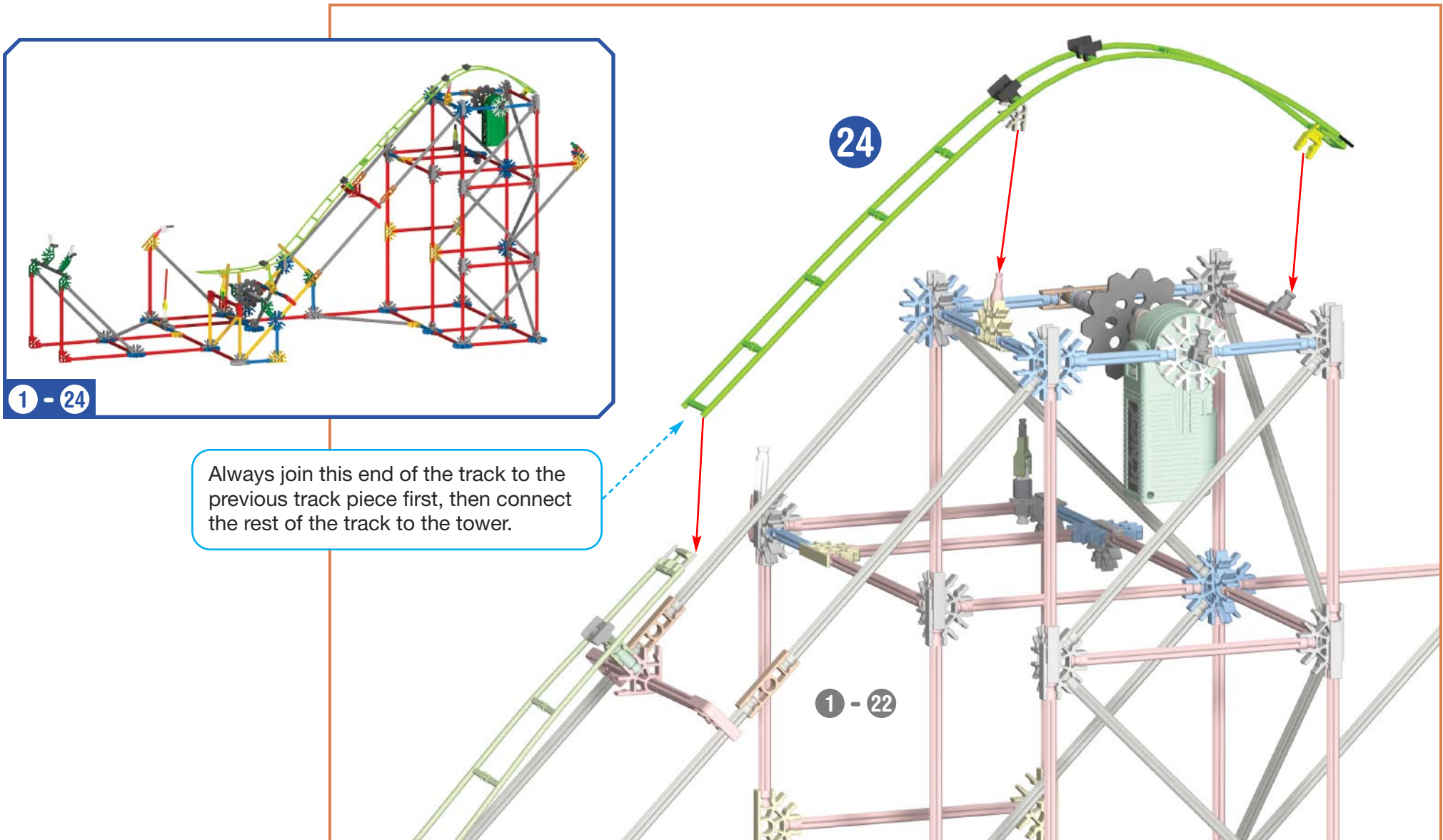
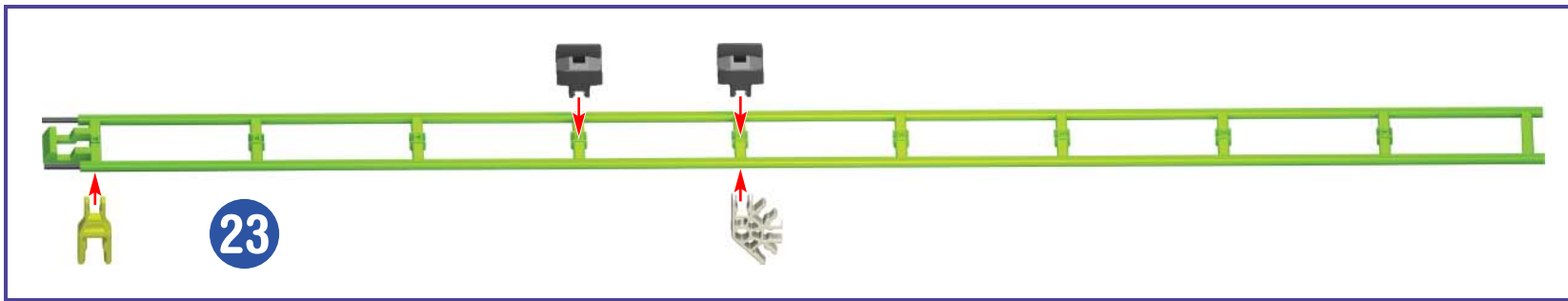

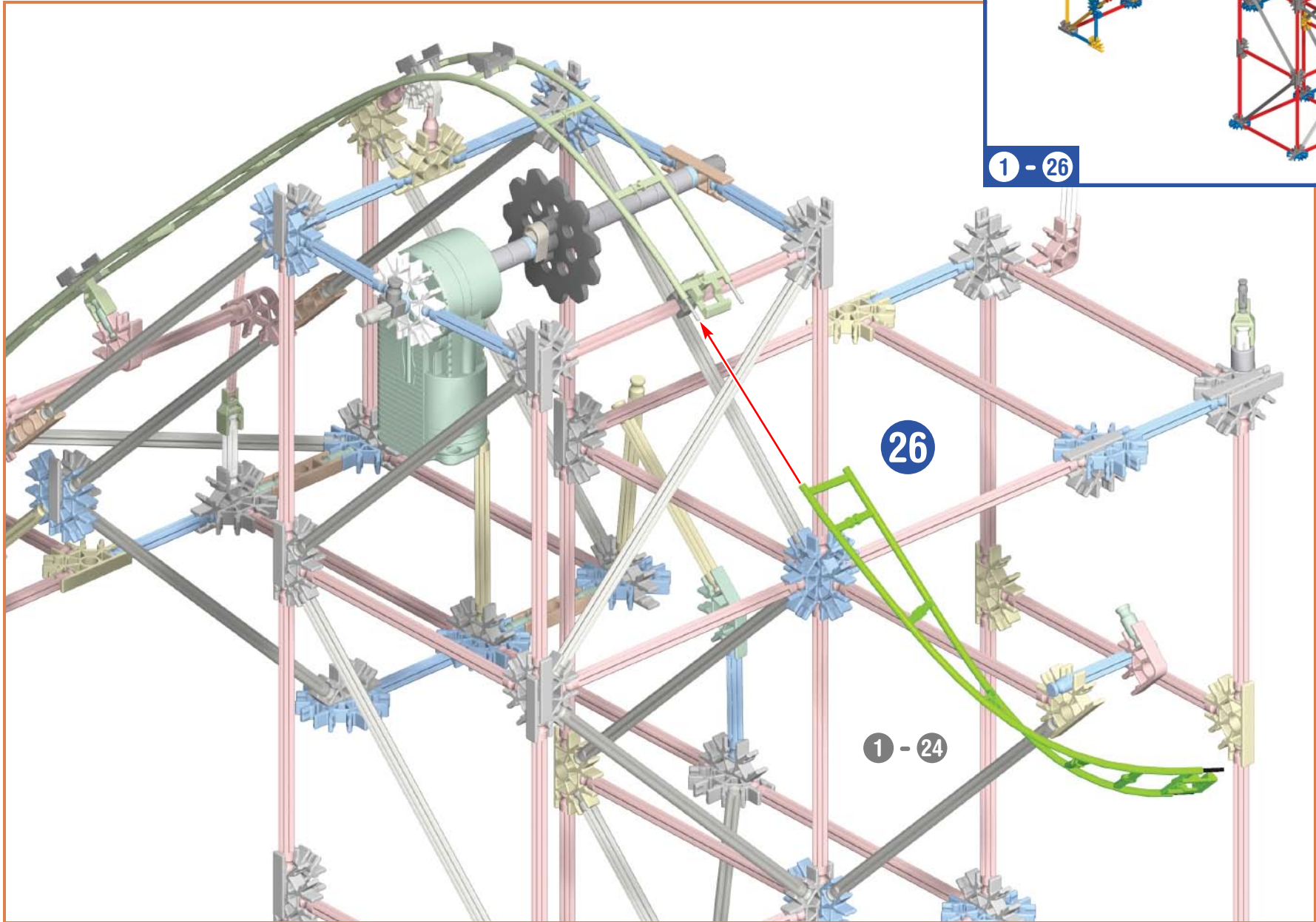
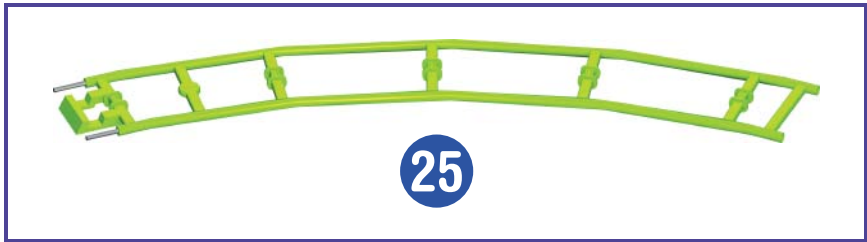

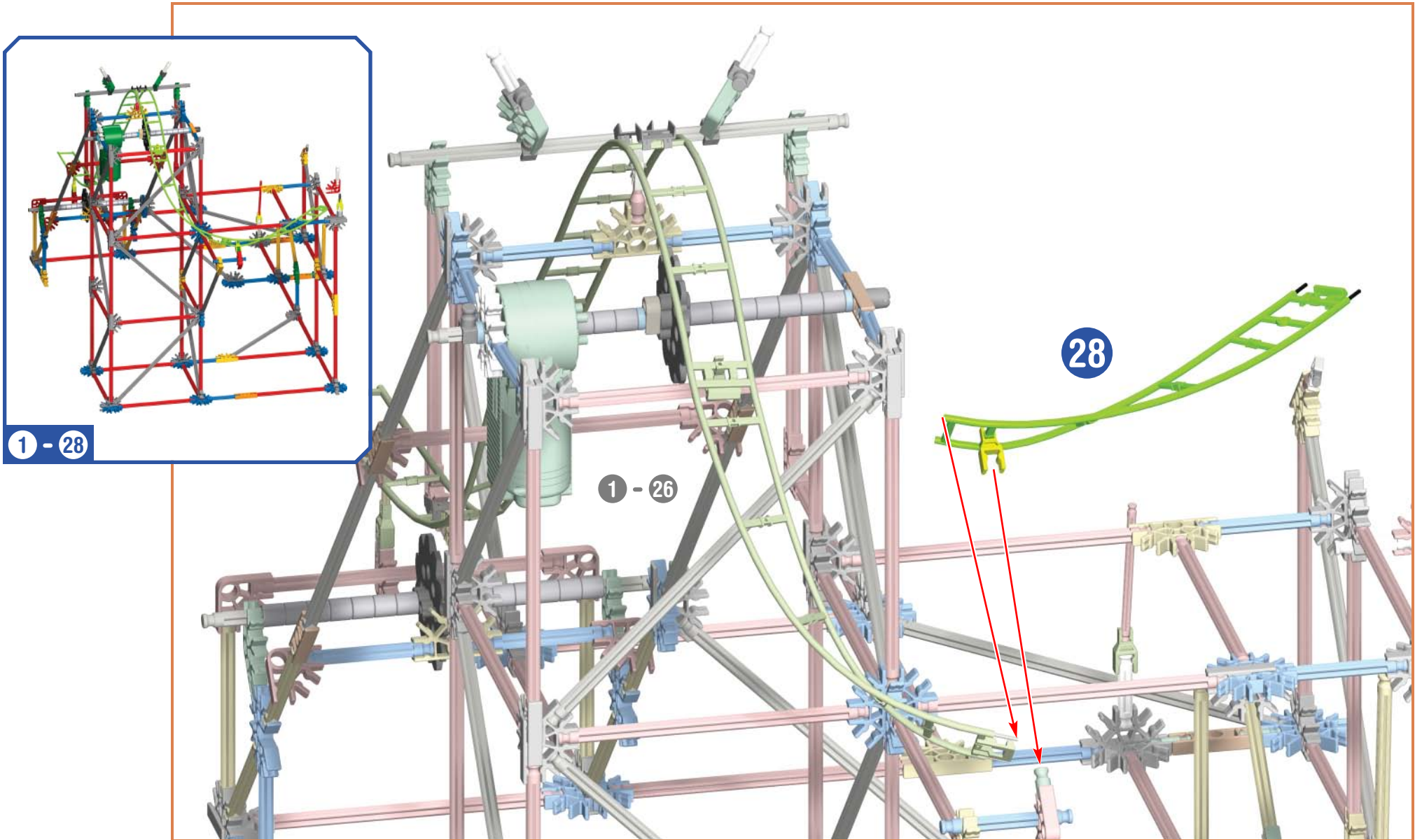
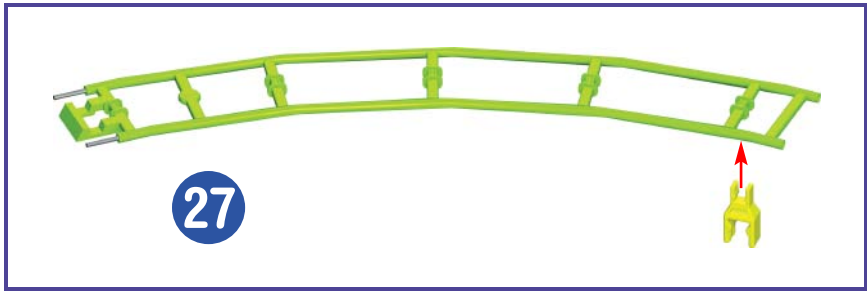

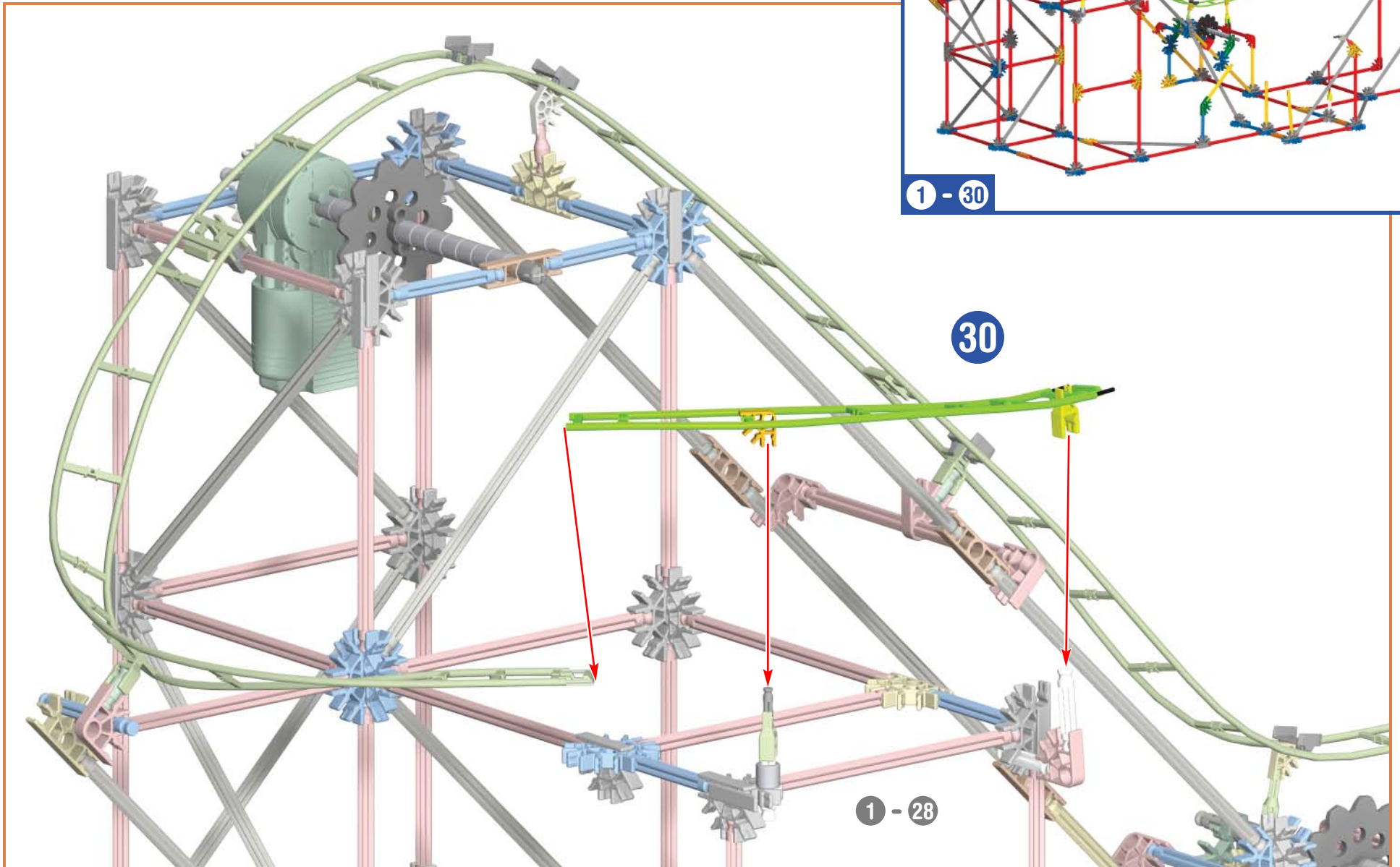
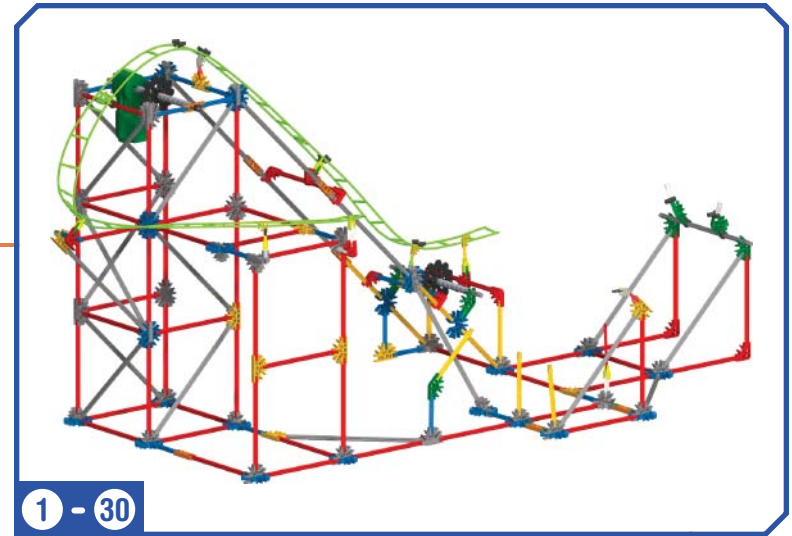
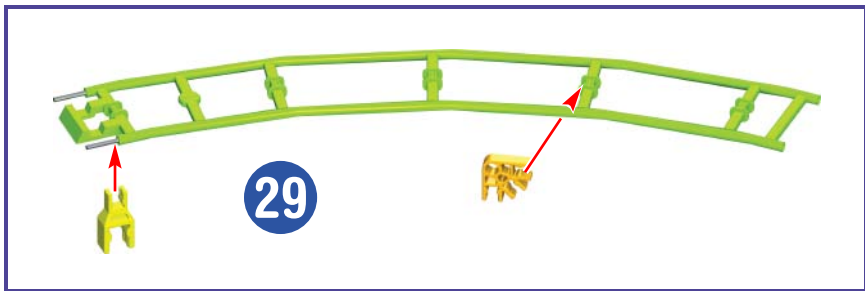

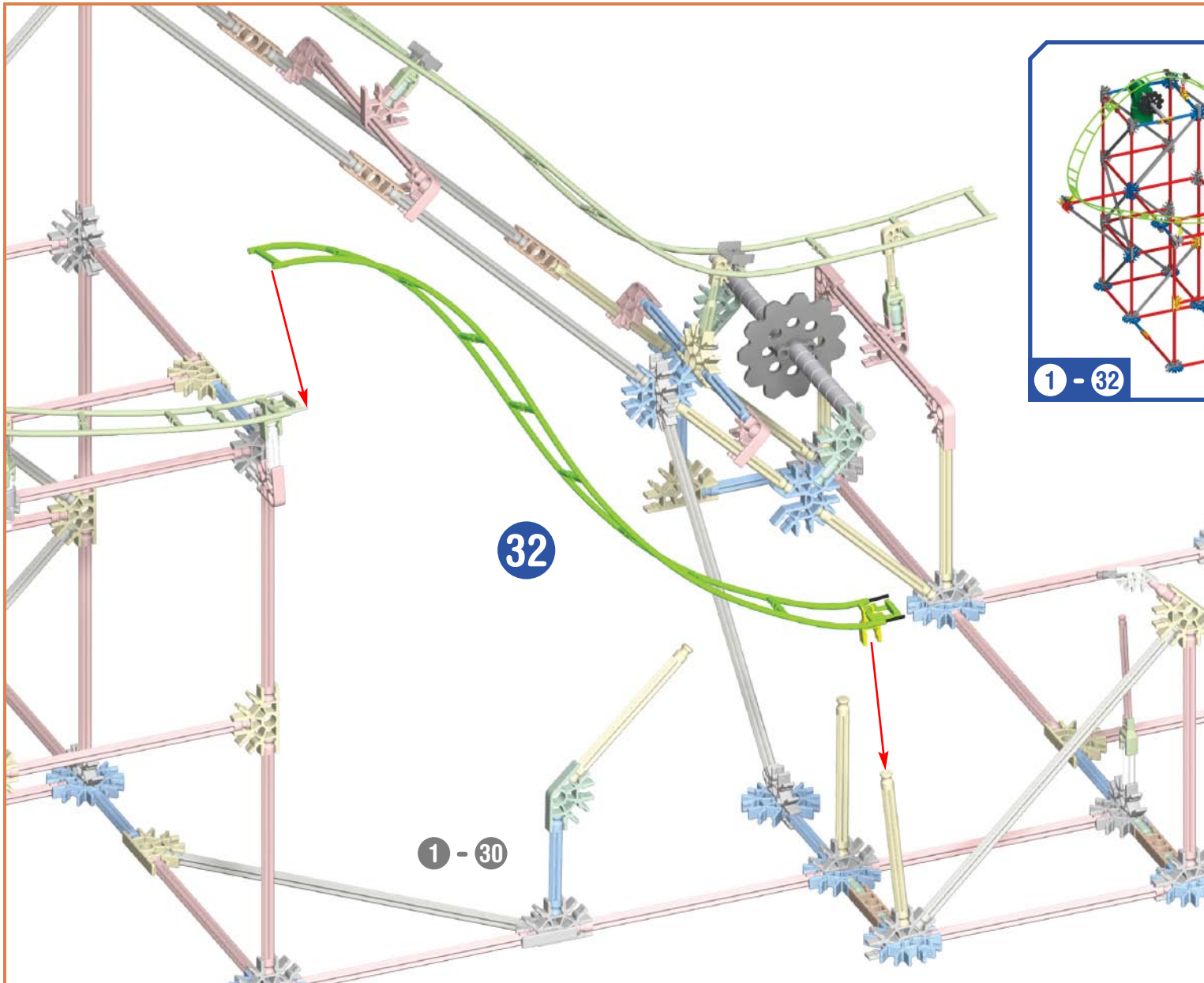
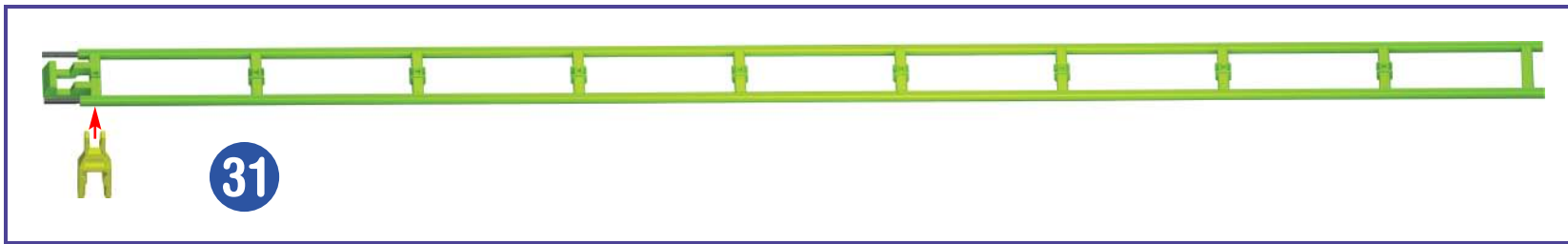

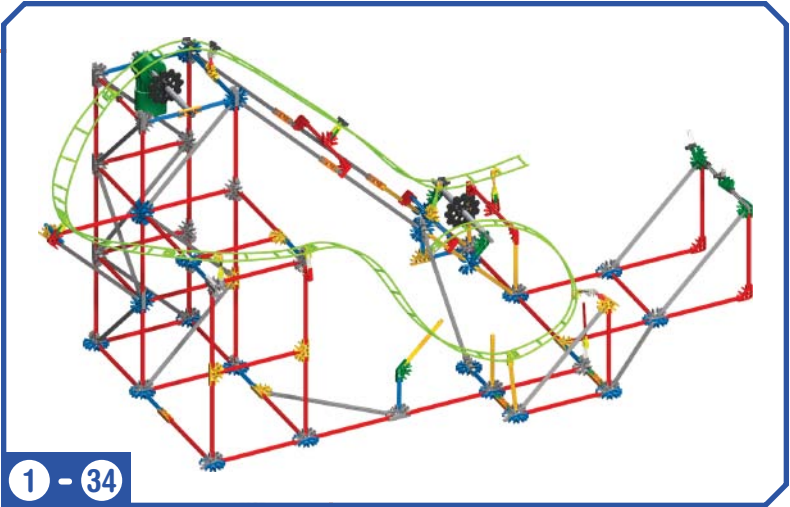
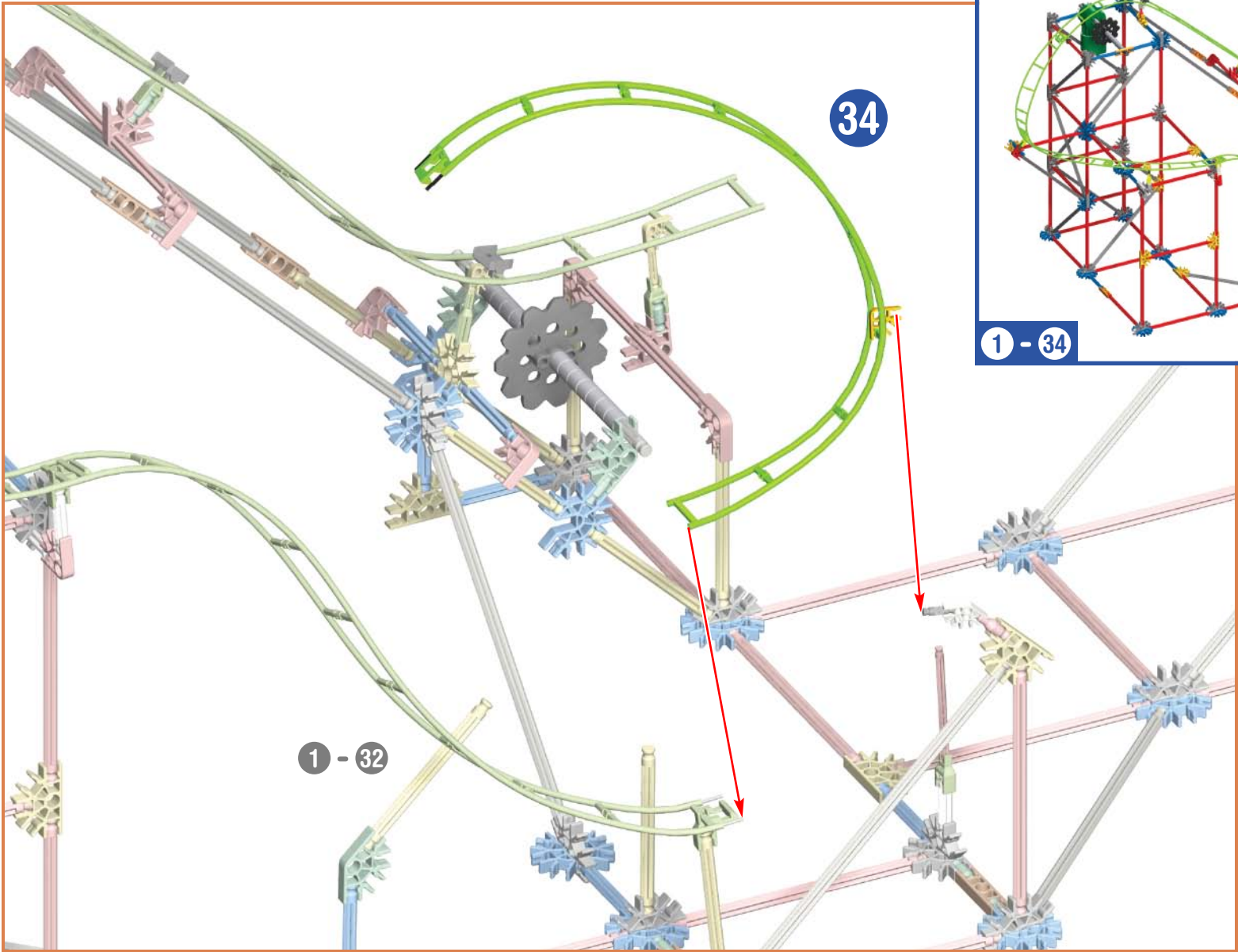
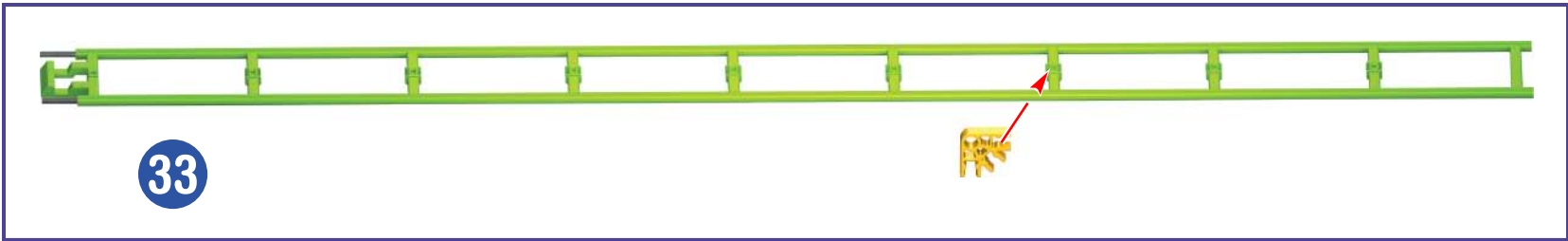

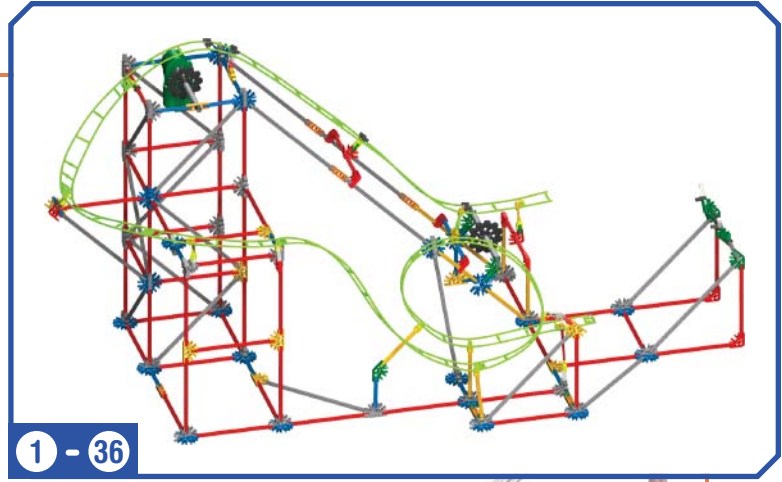
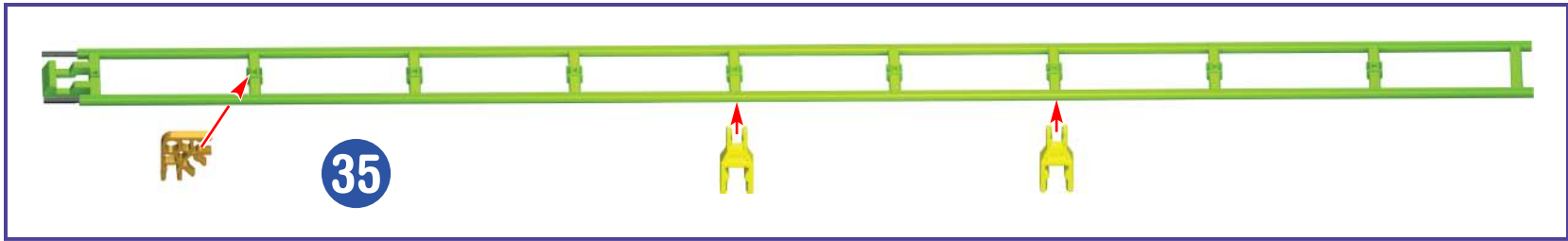

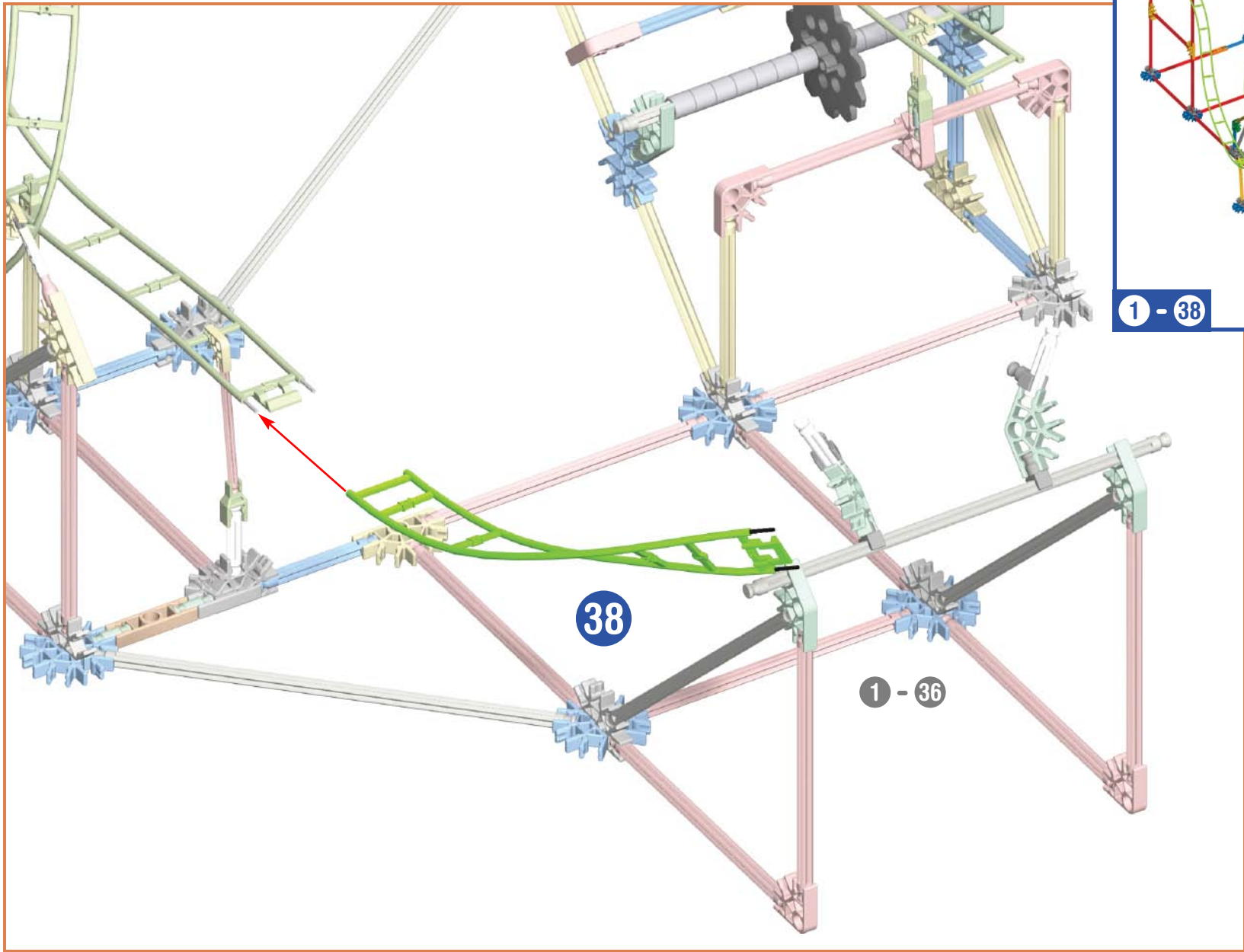
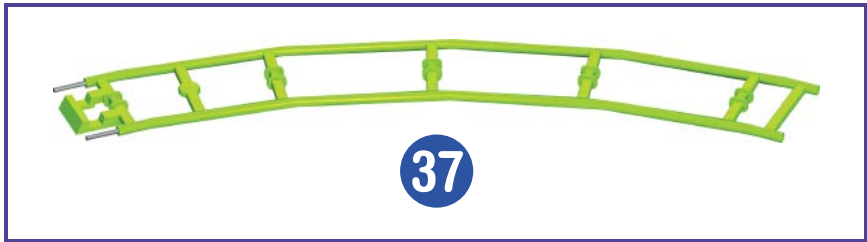

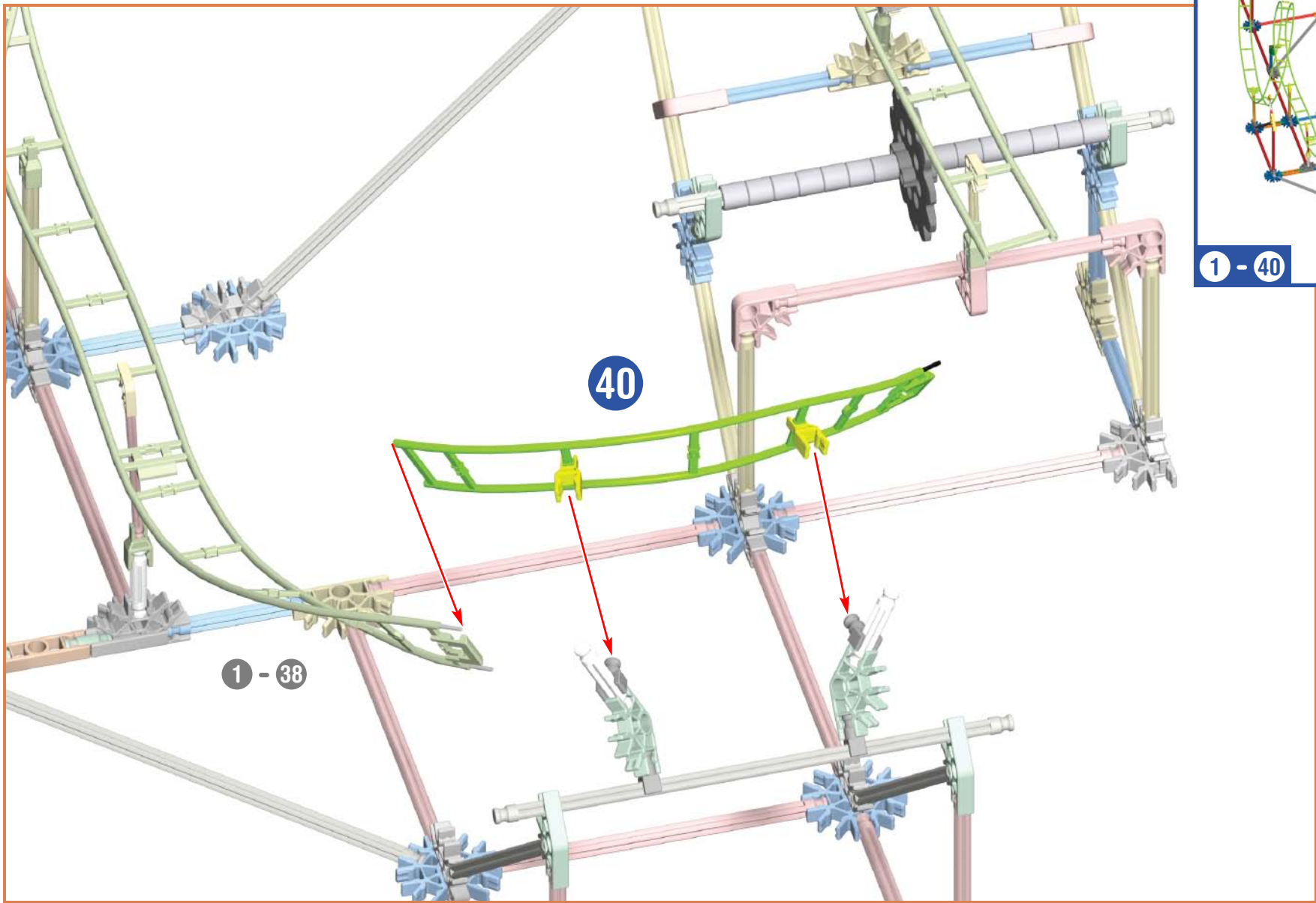
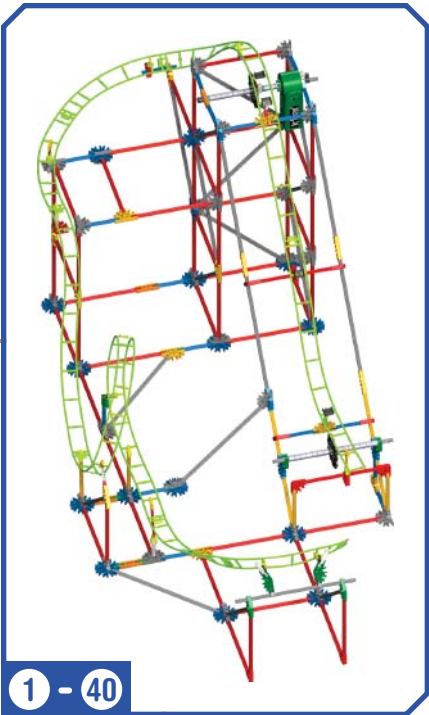
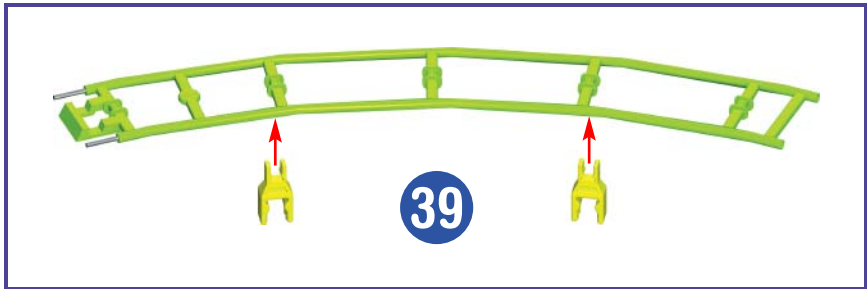

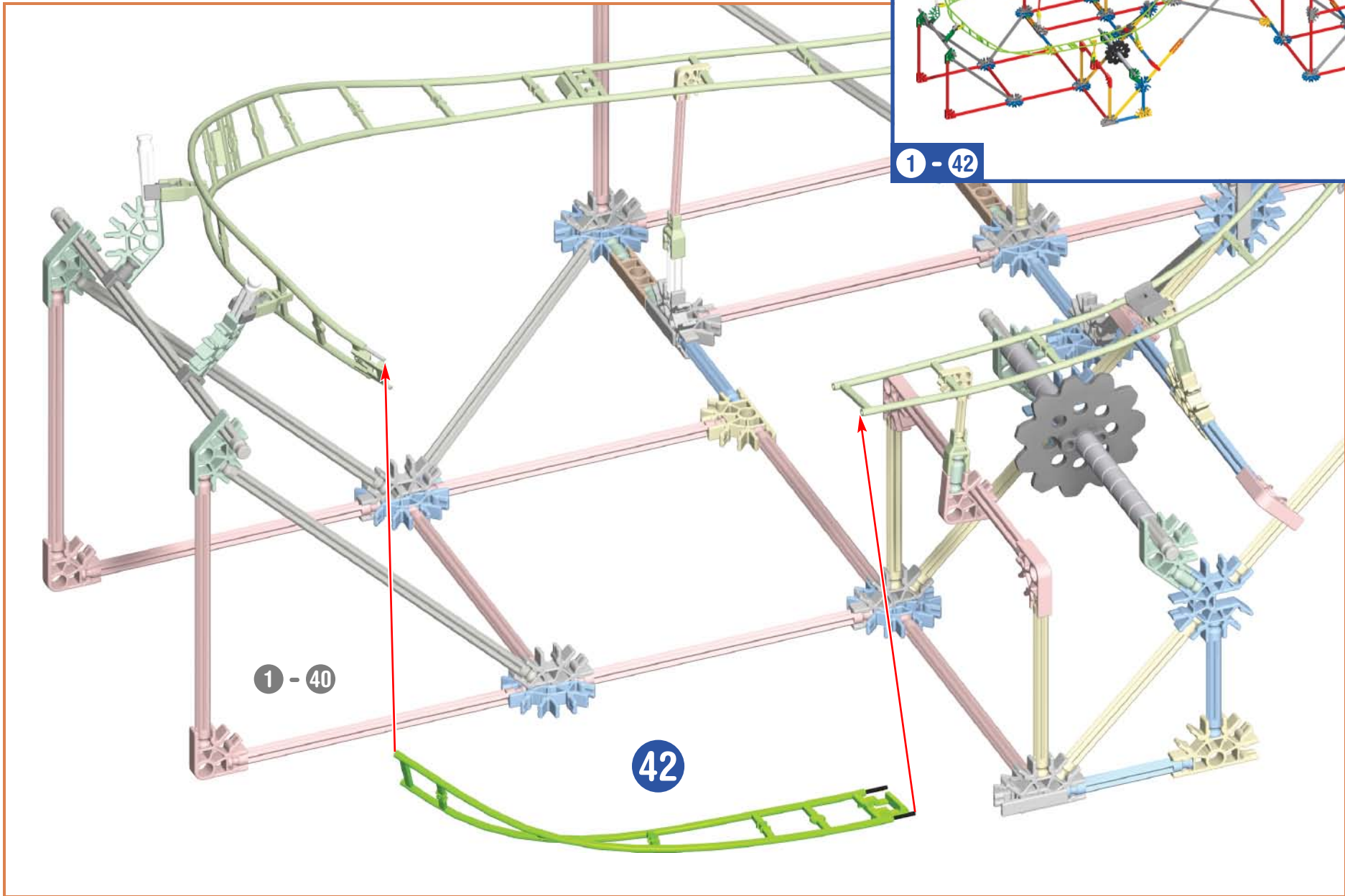
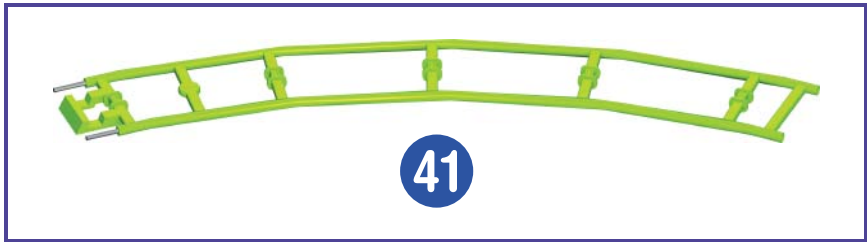



**IMPORTANT:** Attach all the chain links in the same direction.



x10

43

x9



x8

44

x1



43

43

43

45

43

43

43

43

43

43

44

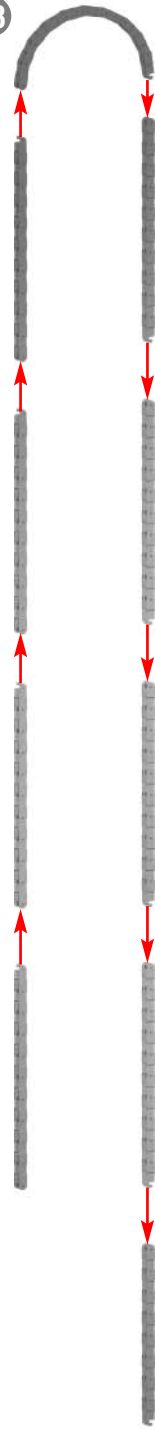

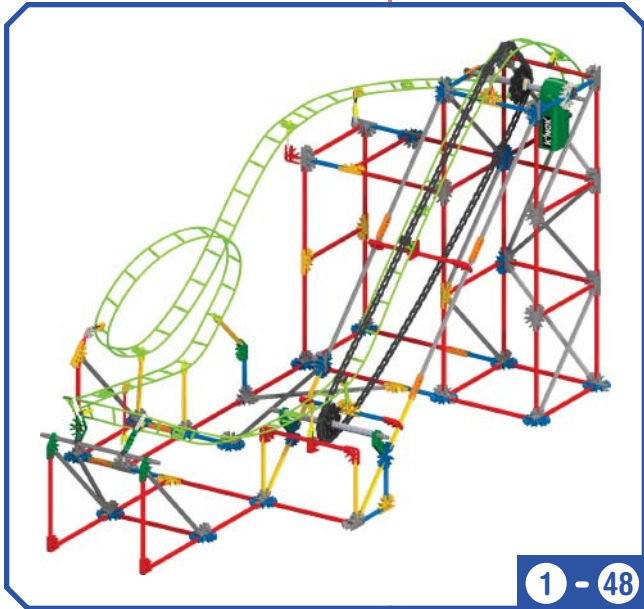

1 - 48

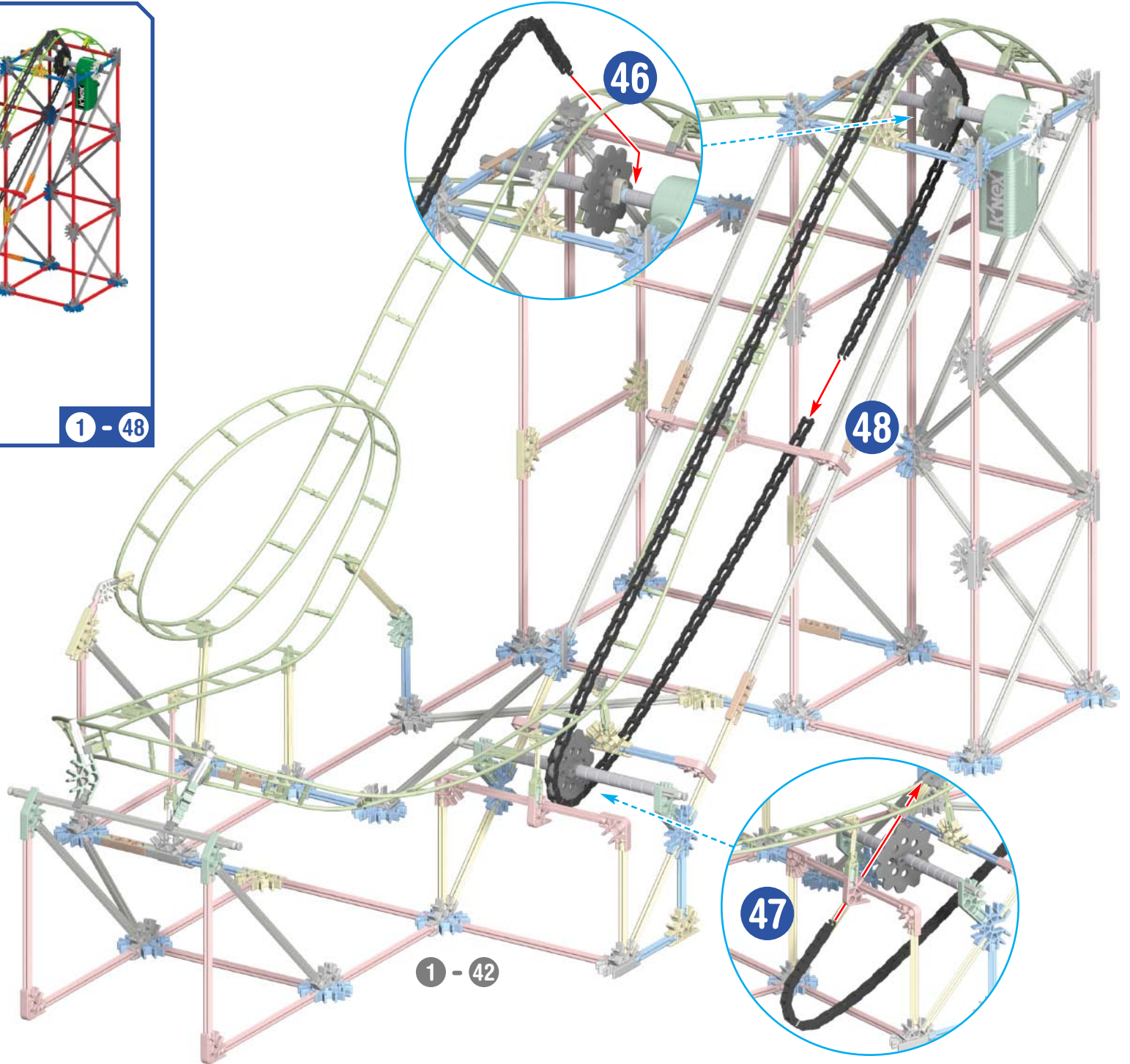

1 - 42

46

48

47

## Attaching Coaster Car

To attach the car, slide onto an open end of the track. If the car gets stuck on the way down, make sure it is not hitting any K'NEX parts.

