

YOU CAN CREATE THESE OTHER BUILDINGS OR DESIGN YOUR OWN!
TU PEUX ÉGALEMENT CRÉER D'AUTRES MODÈLES, OU BIEN CONSTRUIS DES CRÉATIONS ISSUES DE TON IMAGINATION !
¡PUEDES CREAR ESTOS OTROS EDIFICIOS O DISEÑAR LOS TUYOS!

TIP FOR PARENTS:
 Because LINCOLN LOGS pieces are colored and stained in the traditional manner, the dyes can rub off. Use is recommended on surfaces that can be wiped clean. Avoid placing the logs directly on carpet and other absorbent surfaces, which may cause staining.

CONSEIL AUX PARENTS :
 Les éléments de LINCOLN LOGS étant colorés et teintés de manière traditionnelle, les couleurs peuvent déteindre. Il est donc recommandé de poser les éléments sur des surfaces qui peuvent être facilement essuyées. Évitez aussi de placer les bûches directement sur les moquettes, les tapis, et les autres surfaces absorbantes. Elles risqueraient de se tacher.

CONSEJO PARA LOS PADRES:
 Como las piezas LINCOLN LOGS son pintadas y teñidas de la manera tradicional, las tintas pueden desteñir. Se recomienda usarlas en superficies que se pueden limpiar con un paño húmedo. Evite usar los leños directamente en una alfombra u otras superficies absorbentes, pues las tintas pueden causar manchas.

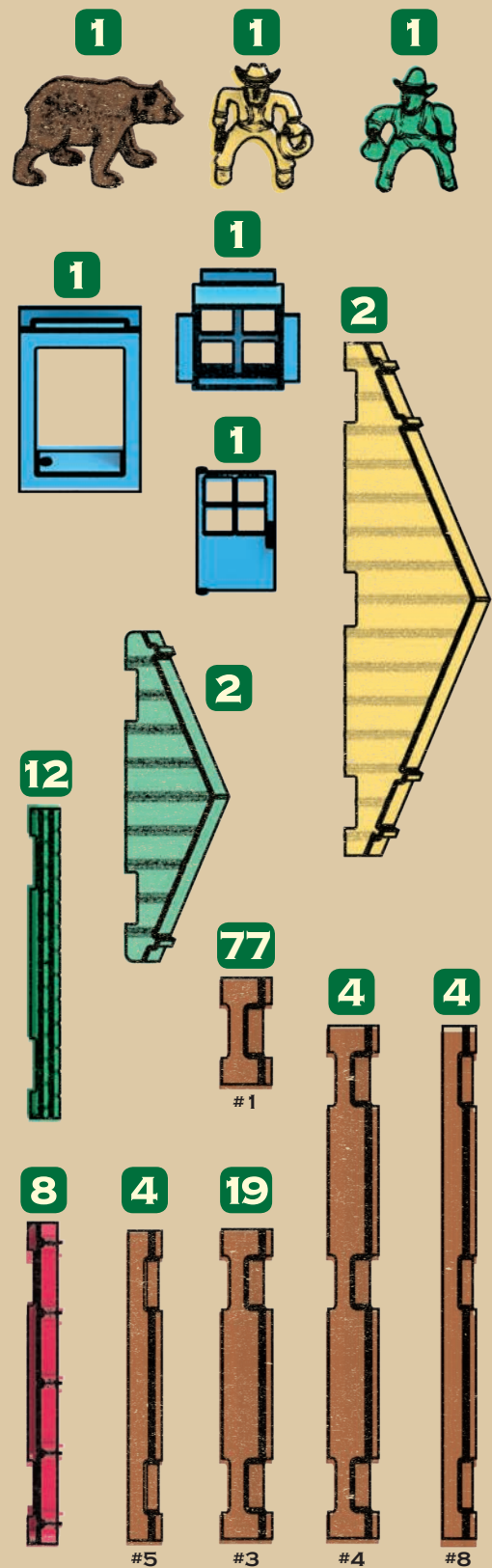

the original

MOUNTAINTOP HIDEOUT • LE REFUGE DE LA MONTAGNE

3+

LINCOLN LOGS

A Classic Since 1916!
 Un Classique Depuis 1916 !

America's national toy™

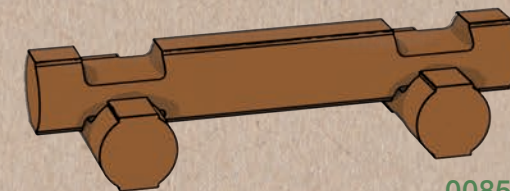
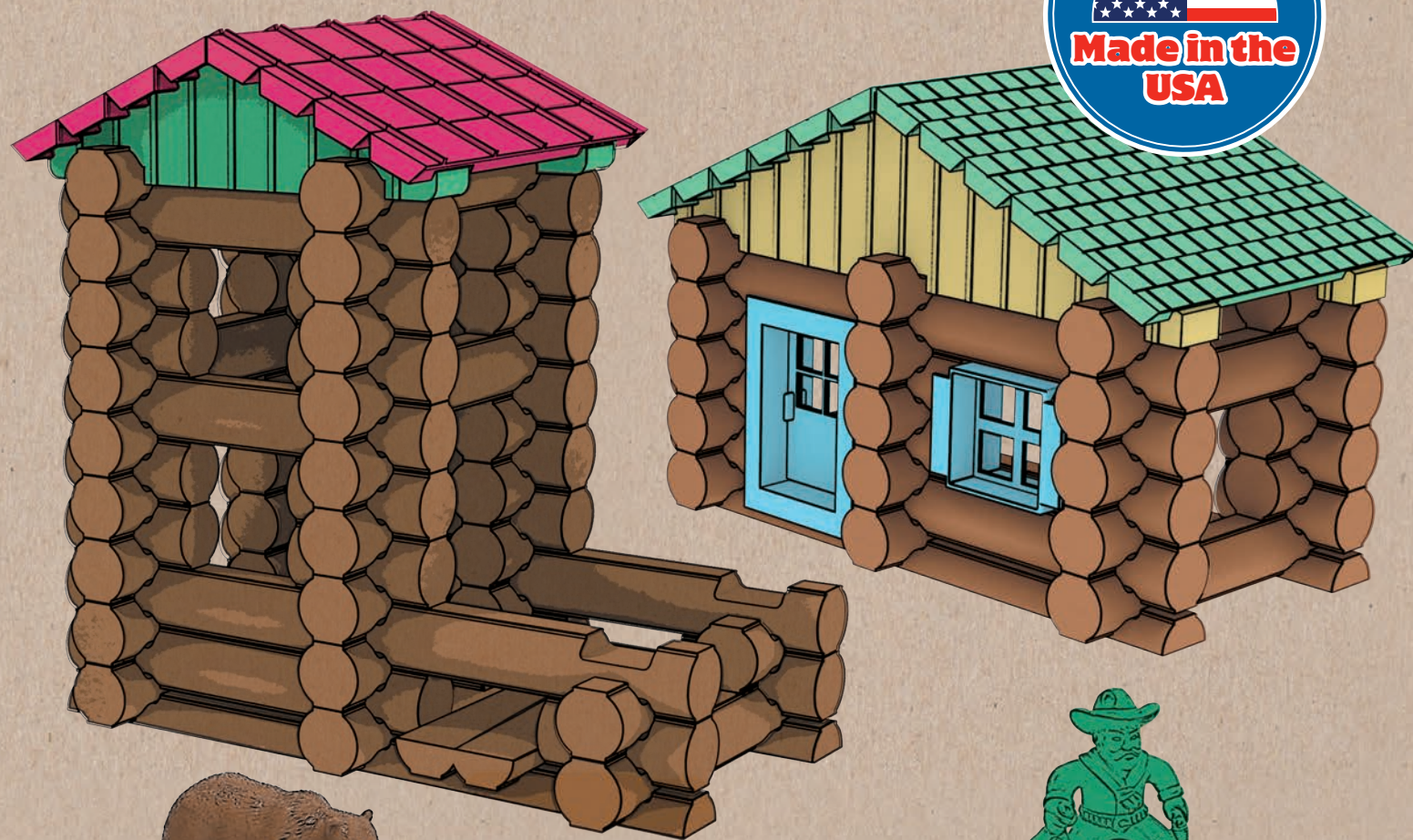

00859

(EN) Product & colors may vary. Most models can be built one at a time.
 (FR) Produits et couleurs peuvent varier. La plupart des modèles ne peuvent être construits que un à un.
 (ES) El producto y los colores pueden variar. La mayoría de los modelos se pueden construir uno a la vez.
 K'NEX is a registered trademark of K'NEX Limited Partnership Group. K'NEX es una marca registrada de K'NEX Limited Partnership Group.
 K'NEX est une marque déposée de K'NEX Limited Partnership Group.

Instructions are included for the model shown on the package front. HASBRO and its logo and LINCOLN LOGS are trademarks of HASBRO and are used with permission. ©2015 HASBRO. All Rights Reserved.
 Les instructions sont incluses pour le modèle figurant sur le devant de la boîte. HASBRO et son logo et LINCOLN LOGS sont des marques déposées de HASBRO et sont employés avec la permission.
 ©2015 HASBRO. Tous Droits Réservés. Se incluyen instrucciones para el modelo que se ve en el frente del paquete. HASBRO y su insignia LINCOLN LOGS son marcas registradas de HASBRO y se utilizan con el permiso. ©2015 HASBRO. Todos los Derechos Reservados.

Licensed By:



Autorisé Par :

www.knex.com

1-800-KID-KNEX (usa/canada)
 (états-unis/canada)



K'NEX Limited Partnership Group
 P.O. Box 700
 Hatfield, PA 19440-0700



facebook.com/lincolnlogs

ADVERTENCIA: PELIGRO DE ASFIXIA – Piezas pequeñas.
 No para niños menores de 3 años.

WARNING:
 CHOKING HAZARD – Small parts.
 Not for children under 3 years.

ATTENTION :
 RISQUE D'ÉTOUFFEMENT – Pièces de petite taille.
 Ne convient pas aux enfants de moins de 3 ans.

100859-V2-8/15

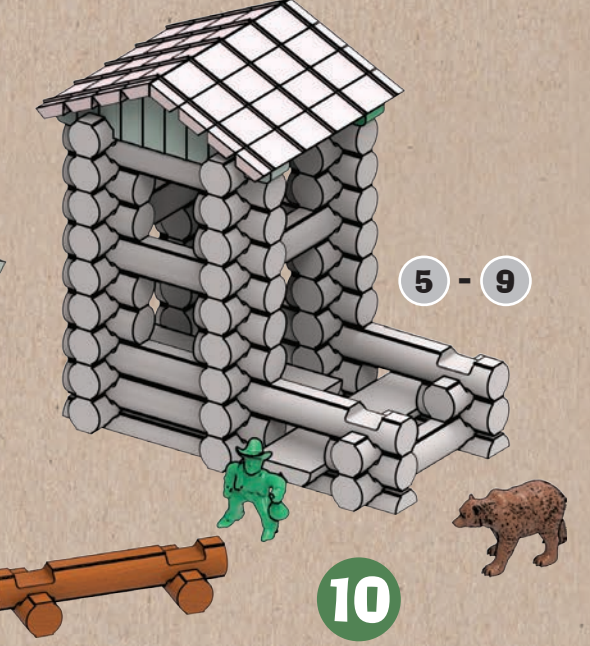
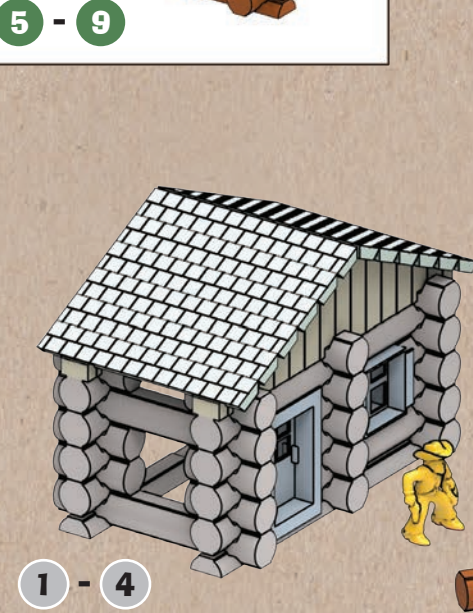
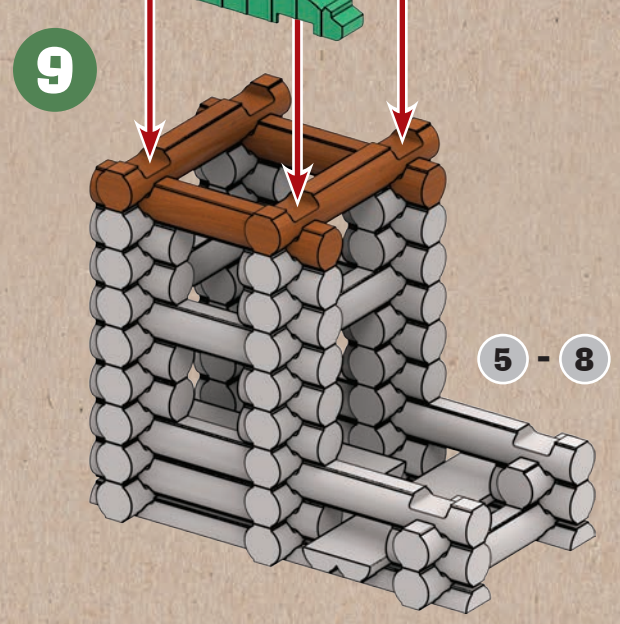
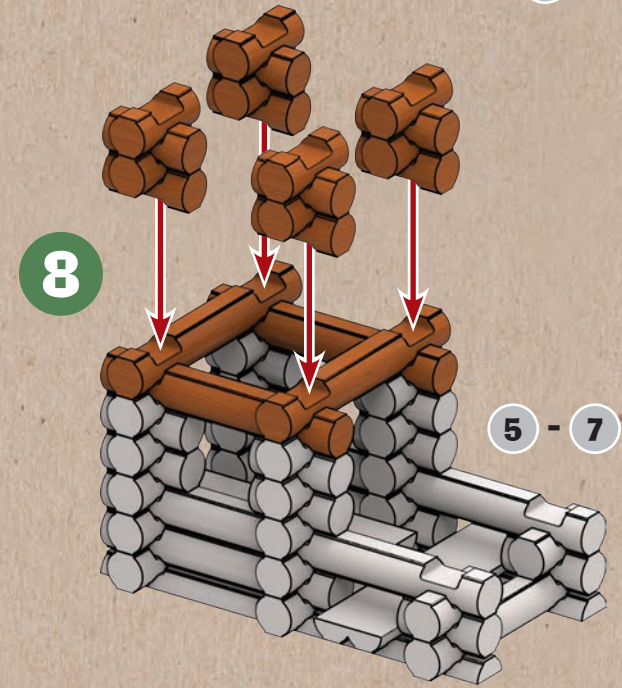
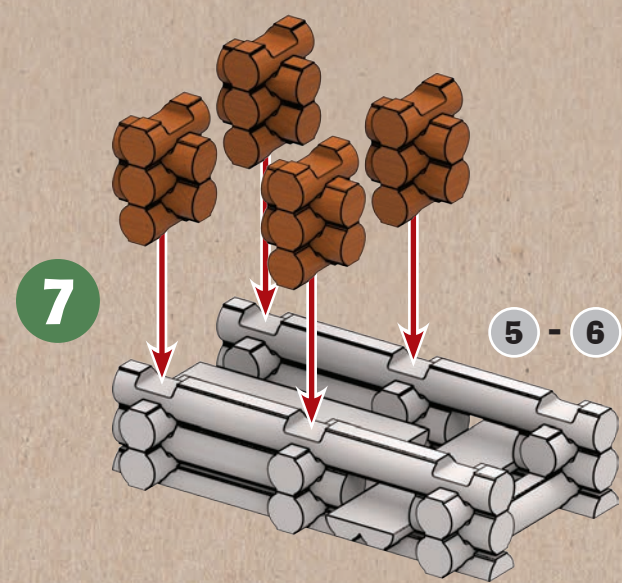
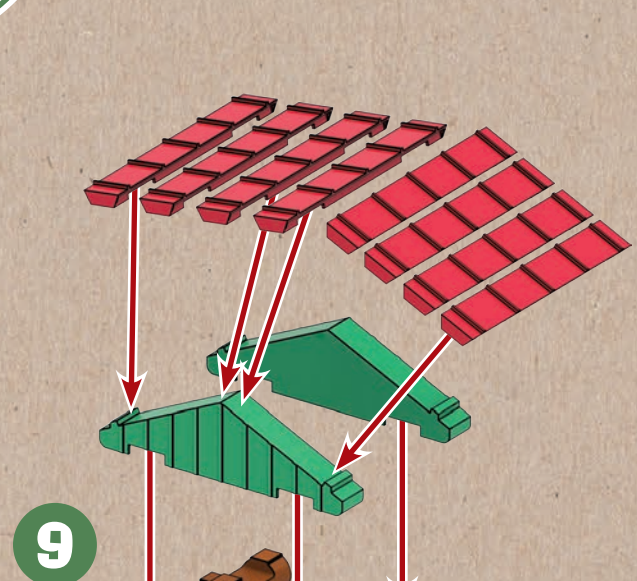
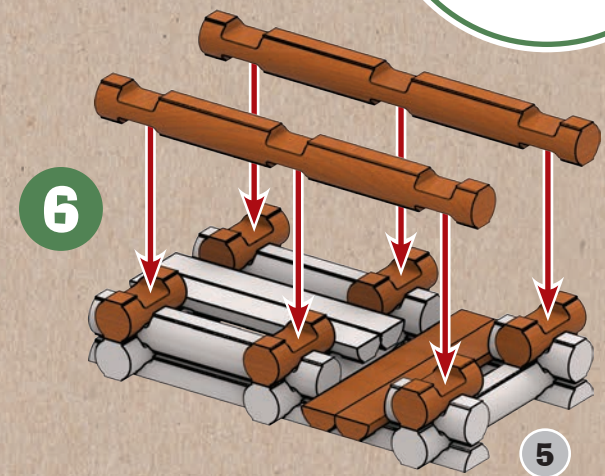
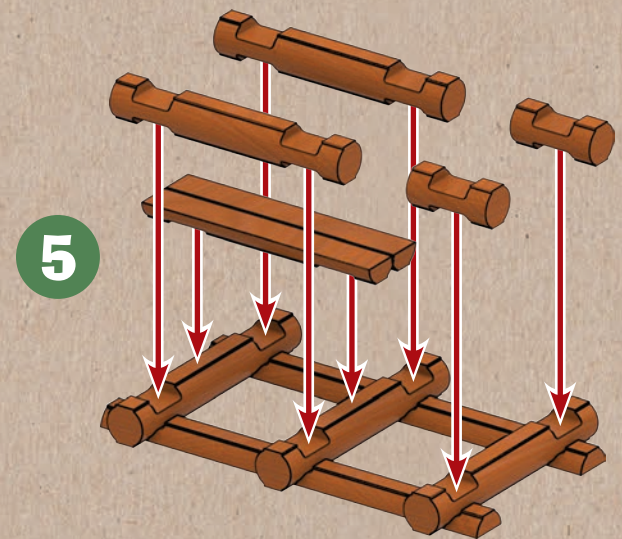
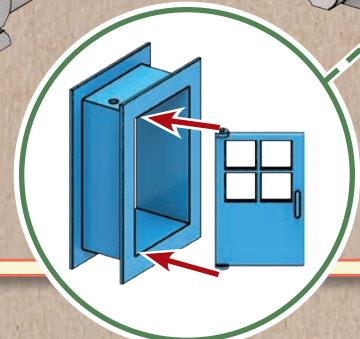
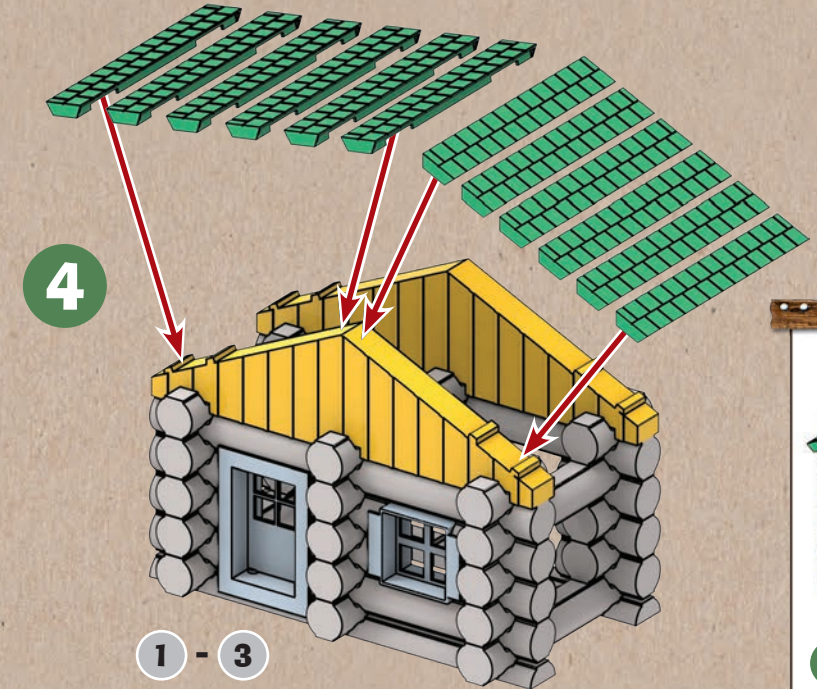
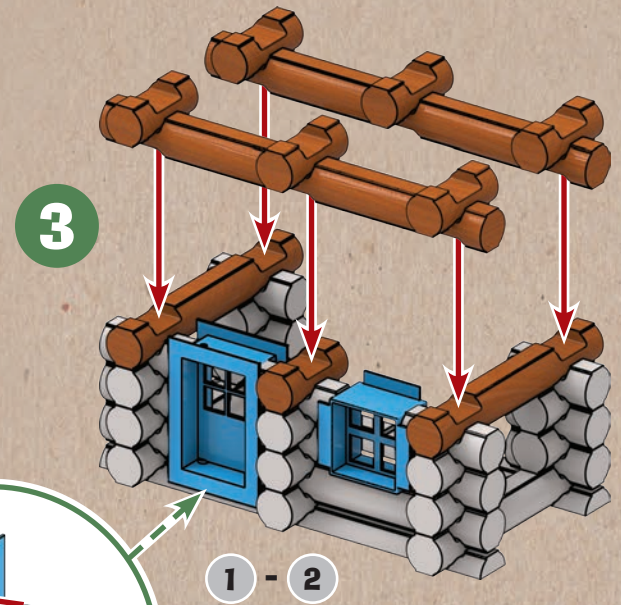
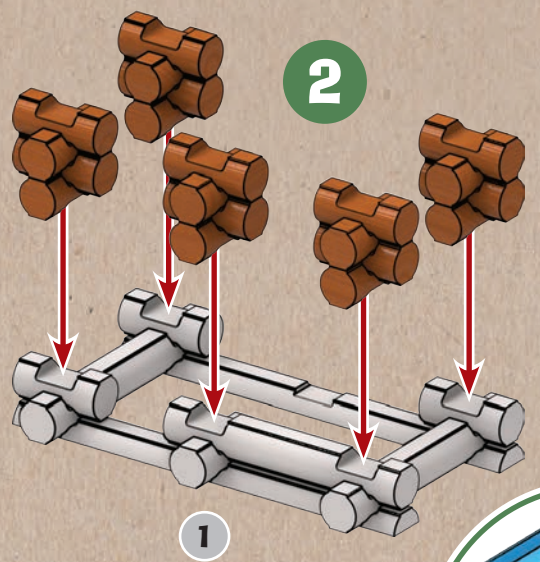
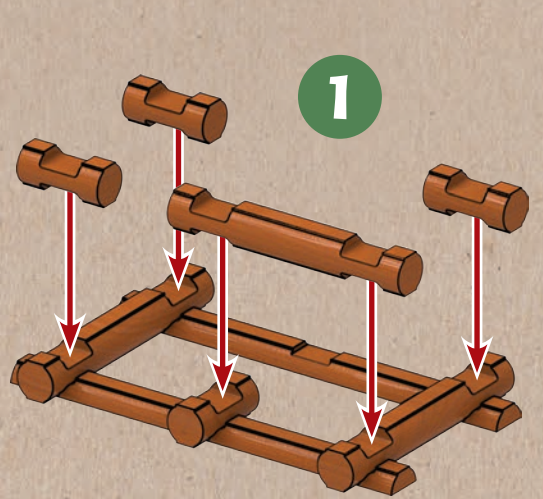

10