

FRONTIER EXPRESS

THE ORIGINAL

Ages: 3 & Up

LINCOLN LOGS

Thank you for purchasing this original Lincoln Logs building set! Lincoln Logs are made of real wood for lasting durability and authentic-looking designs. Easy-fitting plastic accessories include gable roofs, doors, train track, train cars, and many more bright, colorful pieces!



WARNING:

CHOKING HAZARD - Small parts.
Not for children under 3 years.



AVERTISSEMENT!

Danger d'étouffement. Pièces de petite taille.
Ne pas donner aux enfants de moins de 3 ans.



8 curved tracks, 2 crossing tracks, 2 mountain tracks, 2 arch pieces, locomotive, log car, caboose,
3 bases (detonator/crossing gate), detonator, crossing gate bar, log loader, log loader door, flag,
Sheriff Sam, Bad Bart, Engineer Bob, buffalo, safe and gold bars.

The Frontier Express includes
64 #1 logs, 40 #3 logs, 4 #5 logs,
2 gable roofs, hip roof, door/frame,
4 windows, 2 chimneys, 2 straight tracks,

**140
Pieces!**
Includes:
Sheriff Sam,
Bad Bart,
Engineer Bob
& Buffalo

LOGS



#1 LOG (64)



#3 LOG (40)



#5 LOG (4)

DOOR



TRACKS

Here are 6 different track formations that are possible with this set.

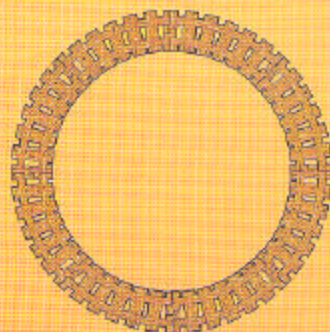
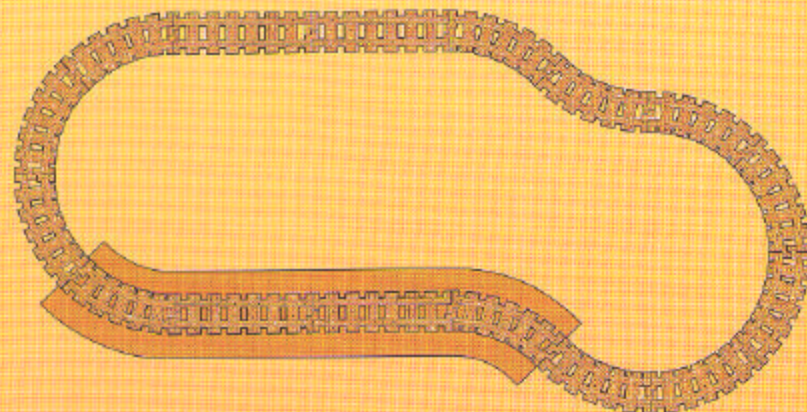
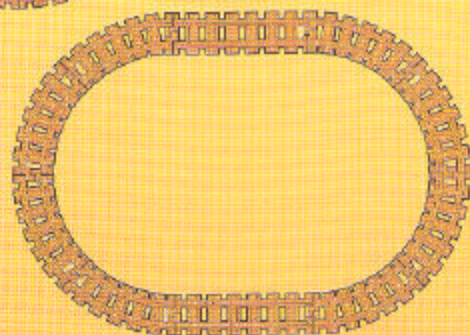
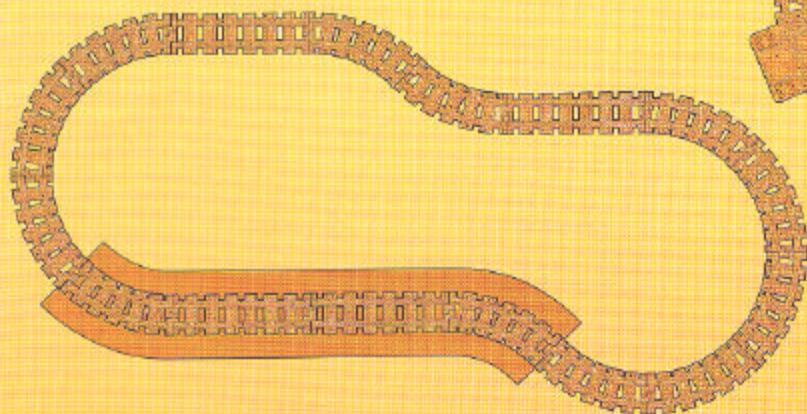
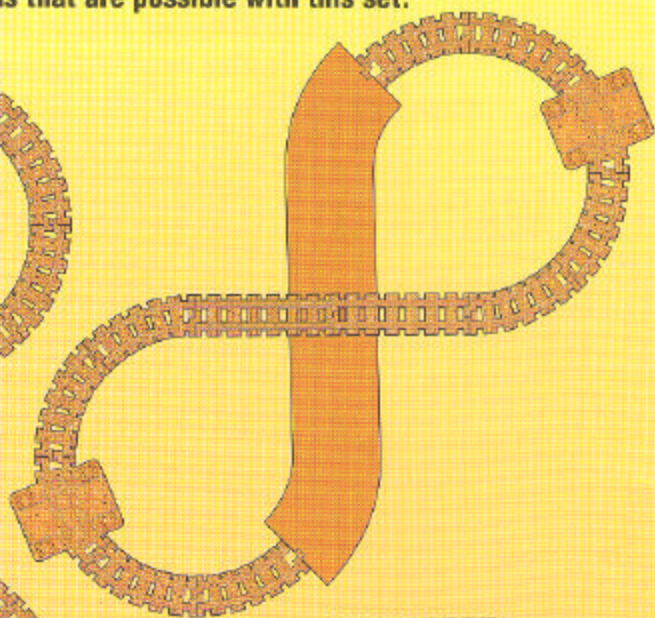
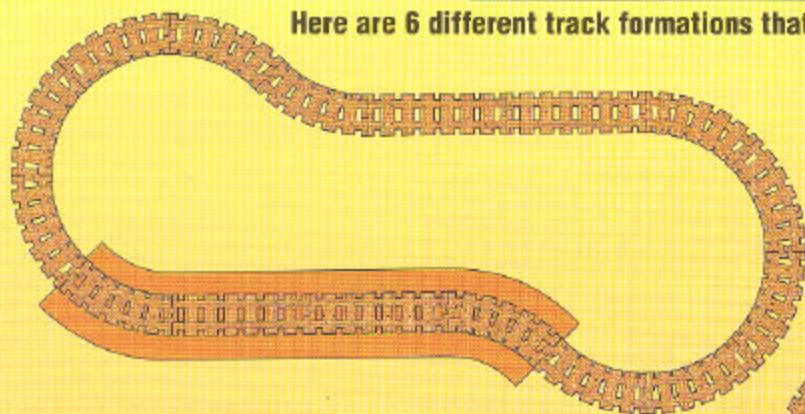

LET'S BUILD

1.

Pictured below are different ways to make log buildings. You can also design your own structures, or combine pieces from this set with other Lincoln Logs sets to create even larger and more exciting scenes.

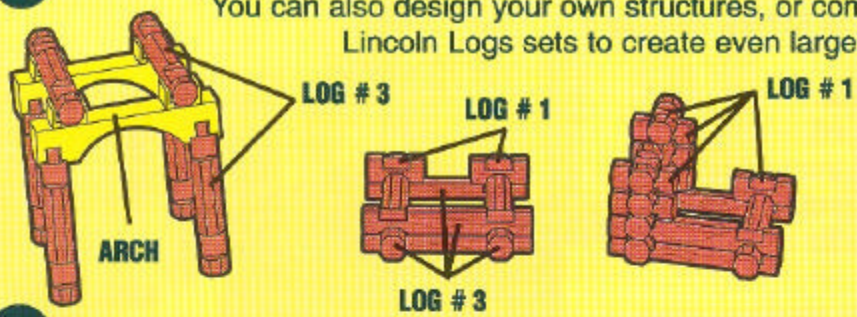

2.

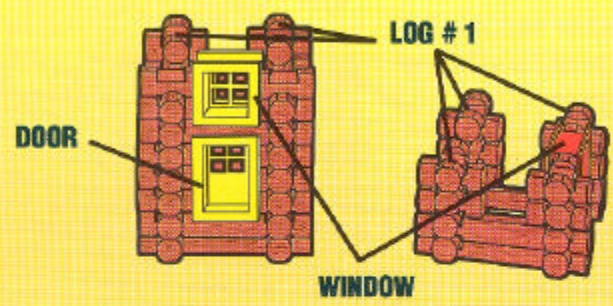

3.

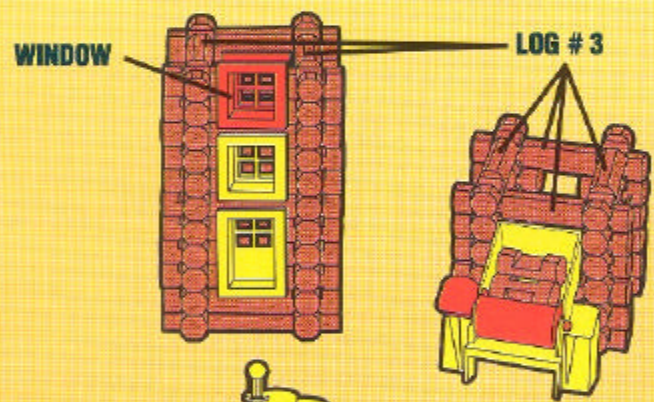

4.

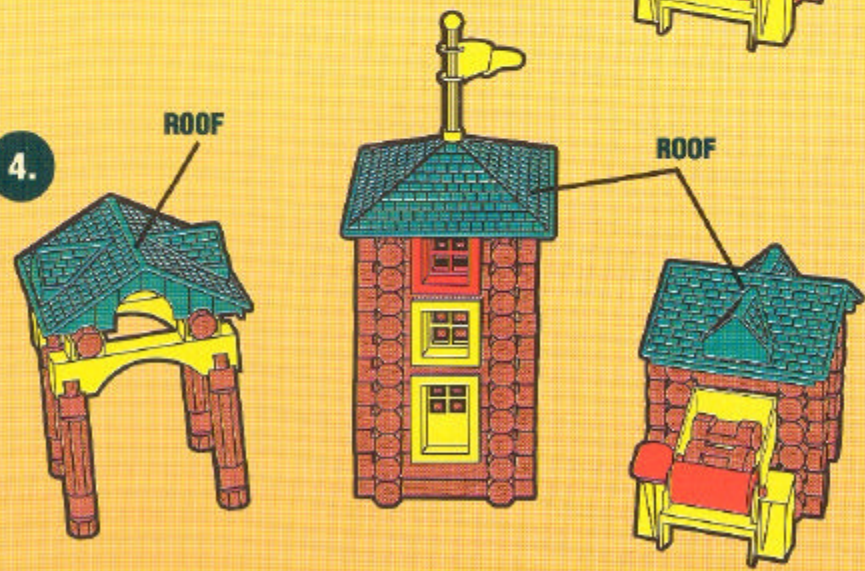

1.

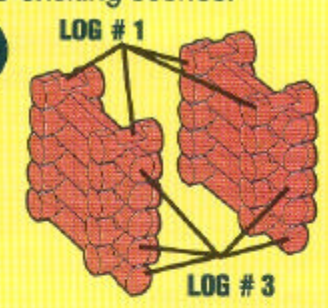

2.

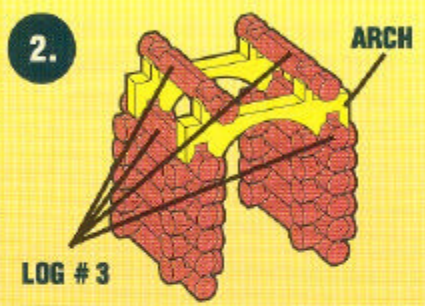

3.

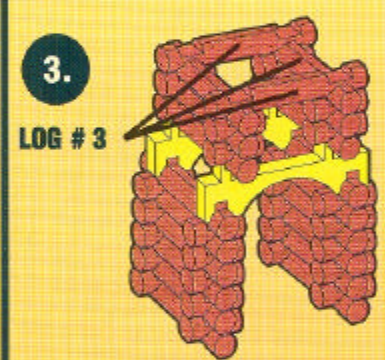

4.

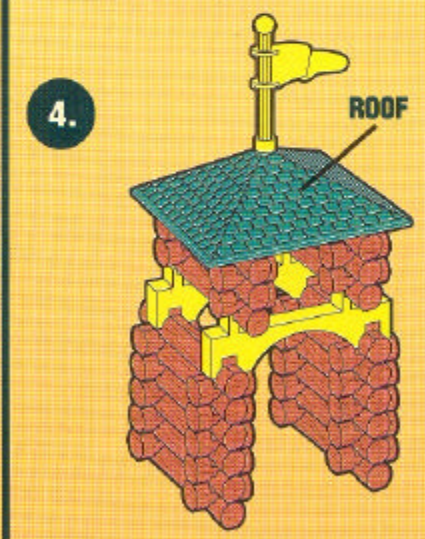

NOTE: To provide the necessary width for structures that cross over the track, the arch pieces must be used.

LET'S BUILD

1.

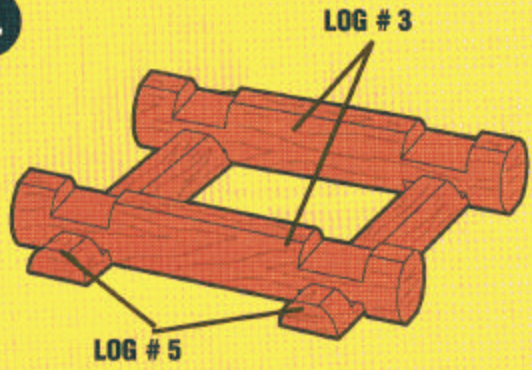

2.

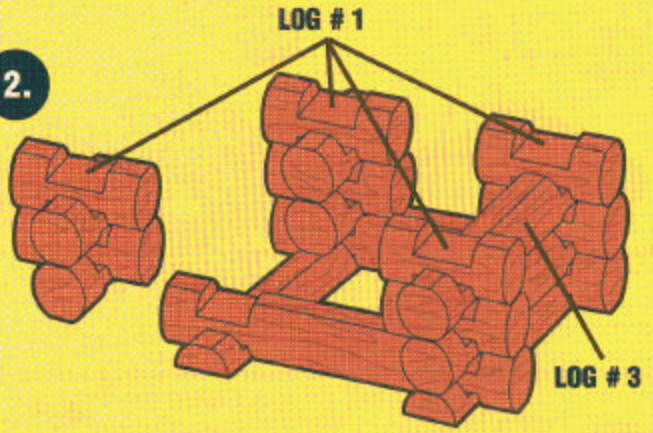

3.

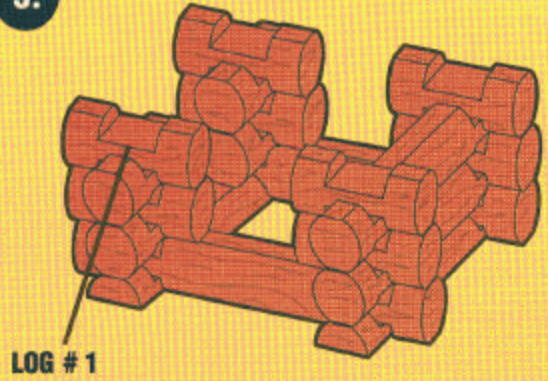

4.

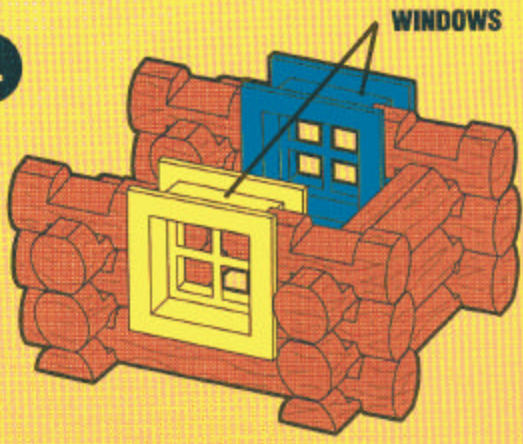

5.

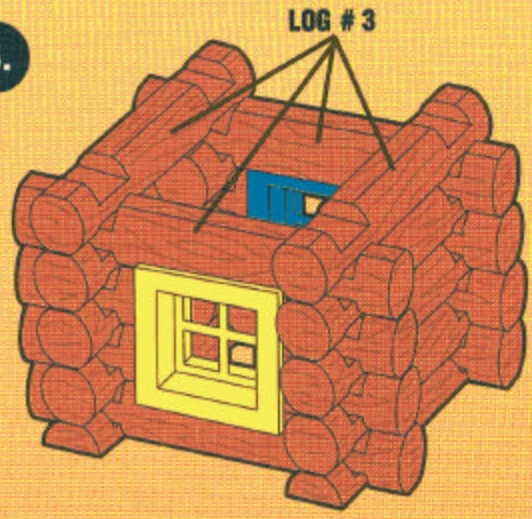

6.

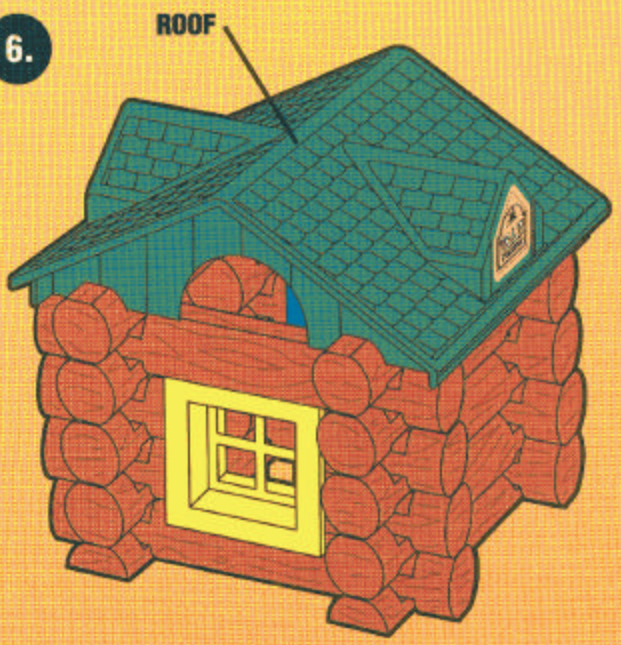

LET'S BUILD

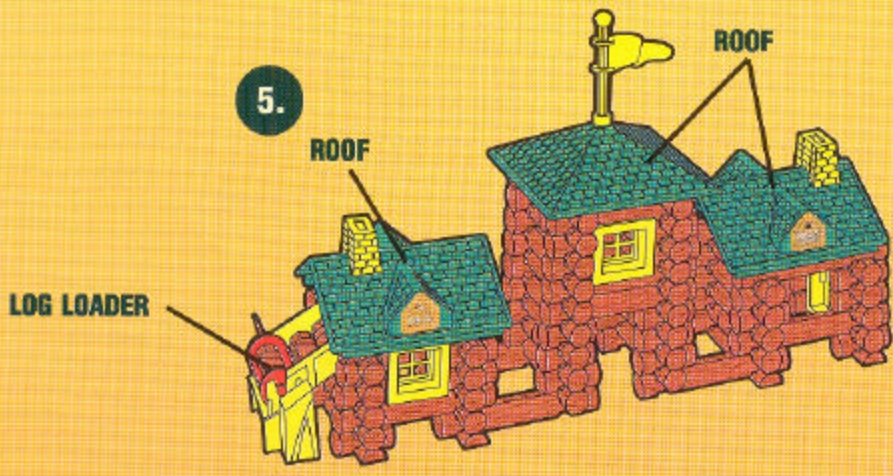
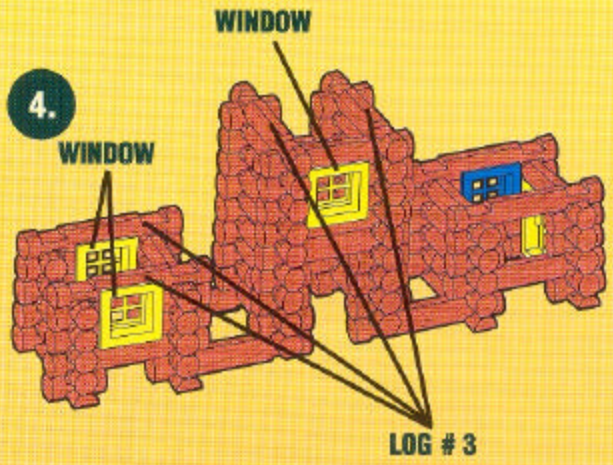
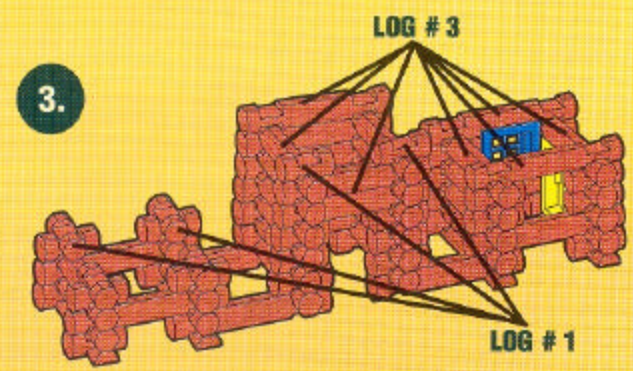
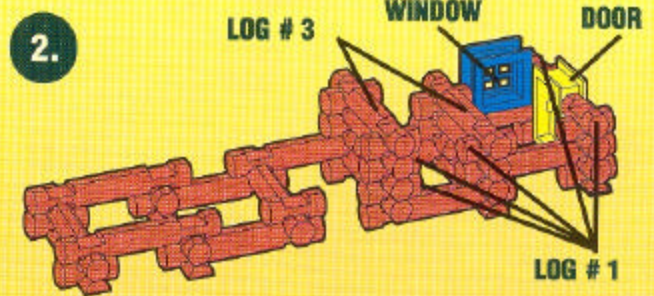
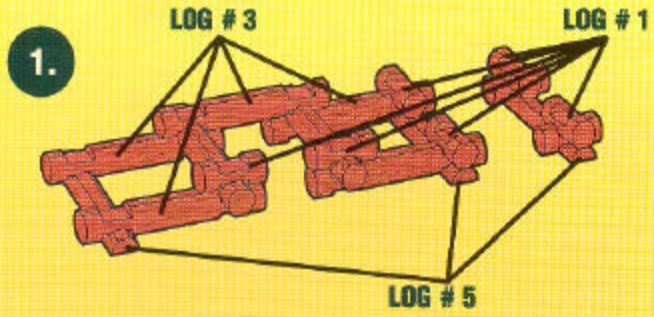
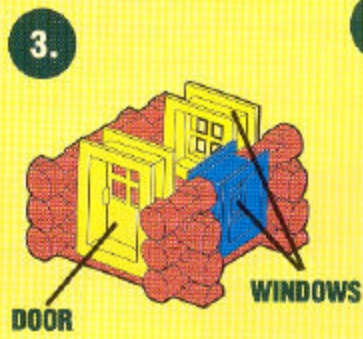
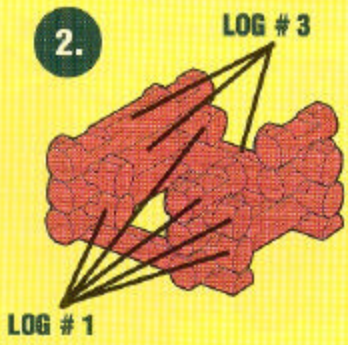
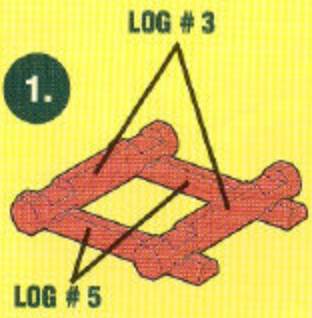

PLAY FEATURES

Detonator (2)

NOTE: Place detonator on mountain track BEFORE building a structure on mountain.

- Snap the detonator handle into the base. (Repeat for other detonator handle/base).
- Place detonator base into a mountain track hole.
- With the detonator in place, build an arch structure over the track. Be sure detonator handle is positioned under one of the bottom logs.
- Push the detonator handle to make the structure come tumbling down!
- You can also use a detonator to topple other buildings. Just place the handle under the log of a completed building and push the lever to make the logs fall!

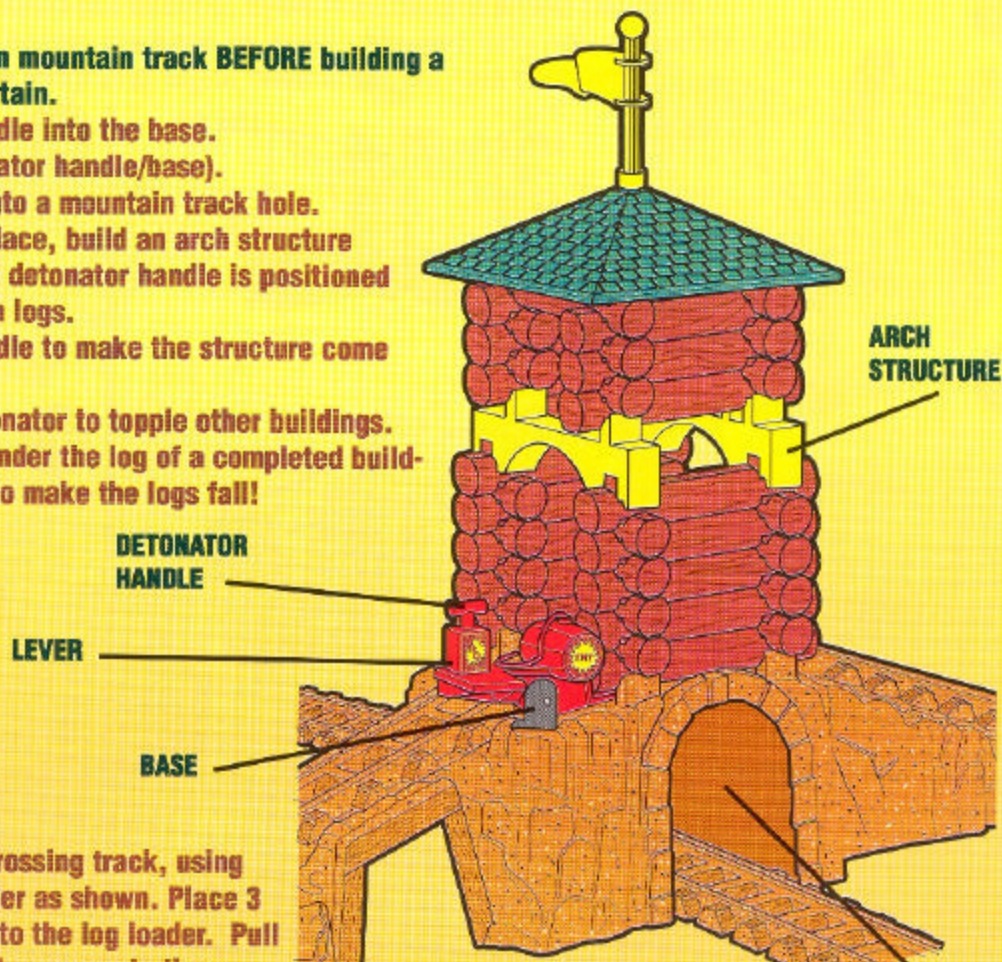

Log Loader

- Place log loader onto crossing track, using logs to support the loader as shown. Place 3 logs into the log loader. Pull the log car up to the loader, then push the loader lever to load the car with the three logs!
- The log loader will also fit in an arch window as shown.

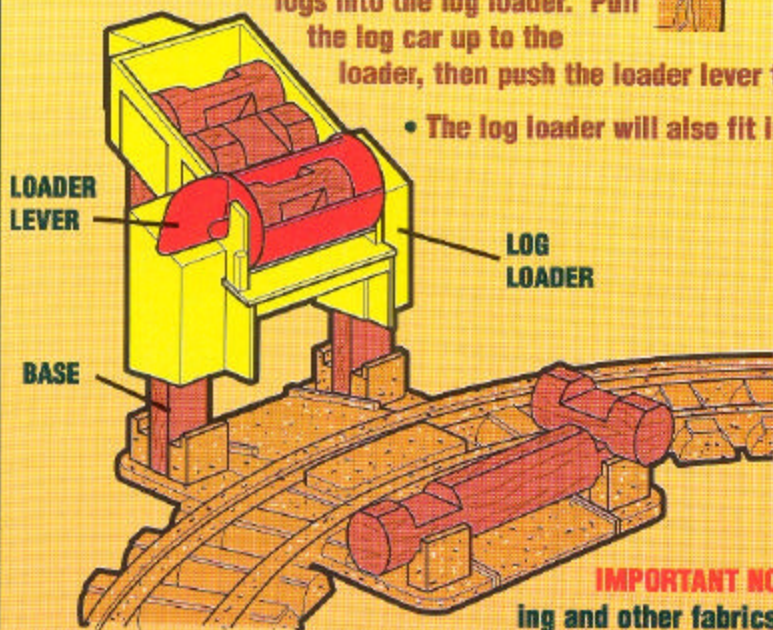

Crossing Gate

- Snap the crossing gate bar into the base. Fit the crossing gate base into any crossing track hole to stop and start traffic!



IMPORTANT NOTE TO PARENTS: Lincoln Logs may stain carpeting and other fabrics, especially if moisture or humidity is present. To prevent staining, we recommend playing with and storing Lincoln Logs in a cool, dry area, avoiding rugs, carpeting and other fabrics.