

THE ORIGINAL
LINCOLN LOGS
BUILDING SET

INCLUDES: 203 WOOD LOGS, 26 GREEN WOOD LOGS,
6 GREEN WOOD ROOF SLATS, 2 ORANGE WOOD ROOF EYES,
2 RED WOOD ROOF EYES, 1 METAL FRONTIERSMAN.

INCLUYE: 203 TRONCOS DE MADERA, 26 TRONCOS VERDES DE MADERA,
6 LISTONES VERDES DE MADERA, 2 ALEROS ANARANJADO DE MADERA,
2 ALEROS ROJOS DE MADERA, 1 FRONTERIZO DE METAL.

COMPRED : 203 RONDINS EN BOIS, 26 RONDINS VERTS EN BOIS,
6 LATTES VERTES DE TOIT EN BOIS, 2 AVANT-TOITS ORANGES EN BOIS,
2 AVANT-TOITS ROUGES EN BOIS, 1 PIONNIER EN MÉTAL.

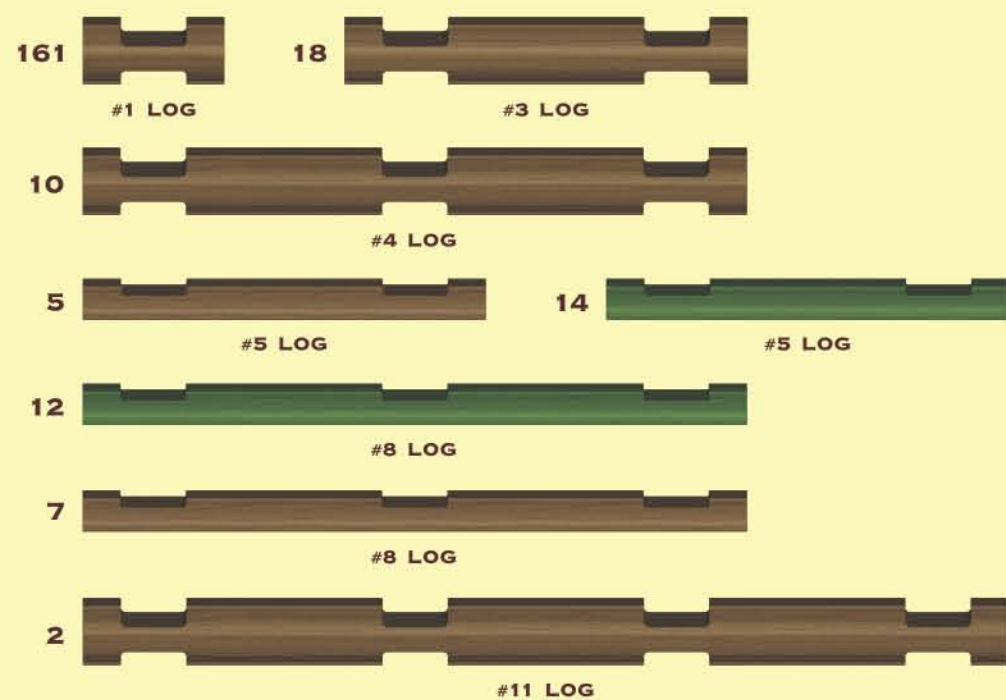

www.facebook.com/buildknex

CHECK US OUT ON THE WEB!
[HTTP://LINCOLNLOGS.KNEX.COM](http://LINCOLNLOGS.KNEX.COM)

¡VISITE NUESTRA PÁGINA EN EL INTERNET!
VENEZ NOUS RENDRE VISITE SUR LE WEB !



YOU CAN CREATE THESE OTHER
BUILDINGS OR DESIGN YOUR OWN!

¡PUEDES CREAR ESTOS OTROS
EDIFICIOS O DISEÑAR LOS TUYOS!

TU PEUX ÉGALEMENT CRÉER
D'AUTRES MODÈLES, OU BIEN
CONSTRUIS DES CRÉATIONS
ISSUES DE TON IMAGINATION !



THE ORIGINAL
LINCOLN LOGS
BOULDER CREEK TOWN™ BUILDING SET

ALL
WOOD
PIECES
Just Like You Remember!

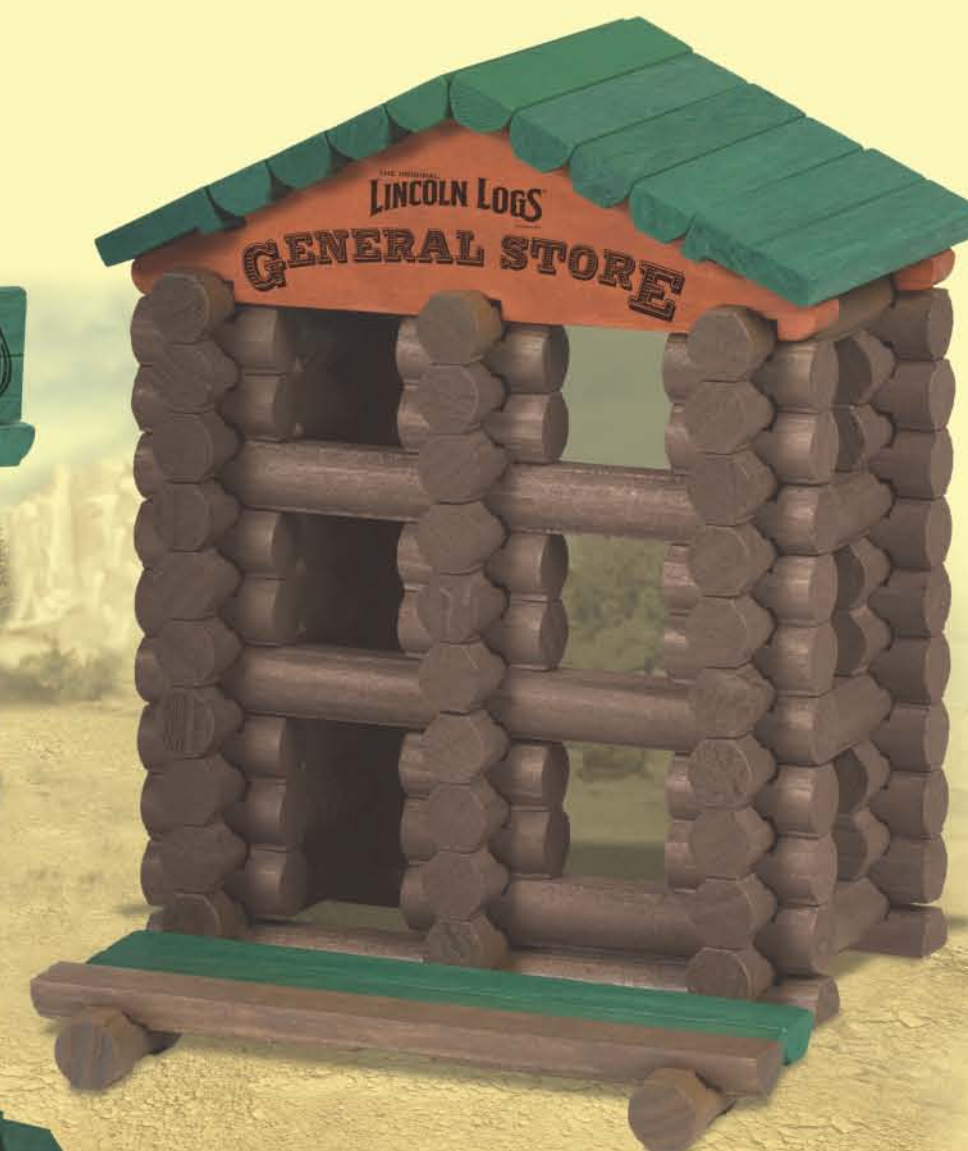
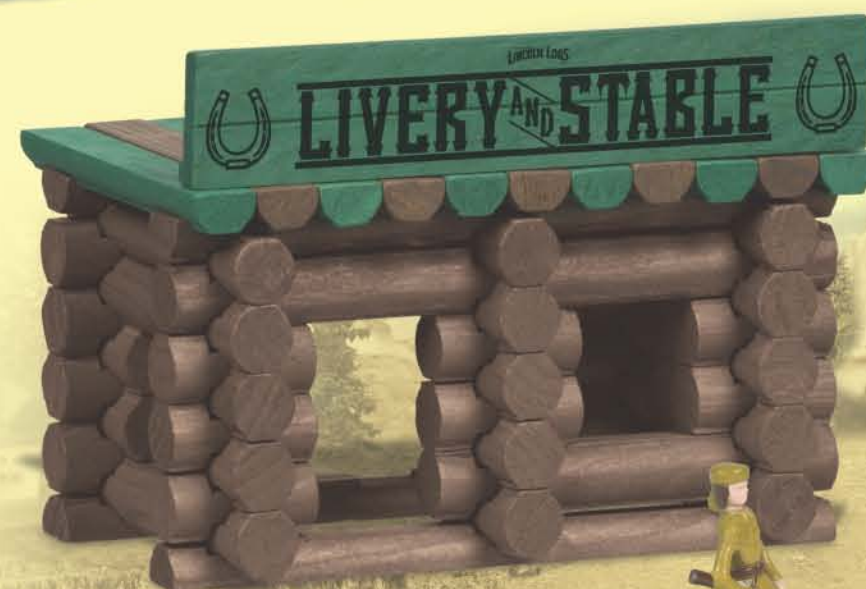

1-800-KID-KNEX
(USA/CANADA)
(ÉTATS-UNIS/CANADA)

Ⓢ TIP FOR PARENTS:
Because LINCOLN LOGS pieces are colored and stained in the traditional manner, the dyes can rub off. Use is recommended on surfaces that can be wiped clean. Avoid placing the logs directly on carpet and other absorbent surfaces, which may cause staining.

Ⓢ CONSEJO PARA LOS PADRES:
Como las piezas LINCOLN LOGS son pintadas y teñidas en la manera tradicional, las tintas pueden desteñir. Se recomienda usarlas en superficies que se pueden limpiar con un paño húmedo. Evite usar los leños directamente en una alfombra u otras superficies absorbentes, pues las tintas pueden causar manchas.

Ⓢ CONSEIL AUX PARENTS :
Les éléments de LINCOLN LOGS étant colorés et teintés de manière traditionnelle, les couleurs peuvent déteindre. Il est donc recommandé de poser les éléments sur des surfaces qui peuvent être facilement essuyées. Évitez aussi de placer les bûches directement sur les moquettes, les tapis, et les autres surfaces absorbentes. Elles risqueraient de se tacher.



K'NEX
www.knex.com

©2011 K'NEX
Limited Partnership Group
P.O. Box 700
Hatfield, PA 19440-0700
Made in China.
Hecho en China.
Fabriqués en Chine.

Ⓢ Product & colors may vary. Most models can be built one at a time. Instructions are included for the model shown on the package front. HASBRO and its logos, Playskool and LINCOLN LOGS are trademarks of HASBRO and are used with permission. ©2011 HASBRO. All Rights Reserved.
Ⓢ El producto y los colores pueden variar. La mayoría de los modelos se pueden construir uno a la vez. Se incluyen instrucciones para el modelo que se ve en el frente del paquete. HASBRO y su insignia, Playskool y LINCOLN LOGS son marcas registradas de HASBRO y se utilizan con el permiso.
Ⓢ Produits et couleurs peuvent varier. La plupart des modèles ne peuvent être construits qu'un à un. Les instructions sont incluses pour le modèle figurant sur le devant de la boîte. HASBRO et son logo, Playskool et LINCOLN LOGS sont des marques déposées de HASBRO et sont employés avec la permission.
©2011 HASBRO. Tous Droits Réservés.

Licensed By:



V1-5/11

3+

00864

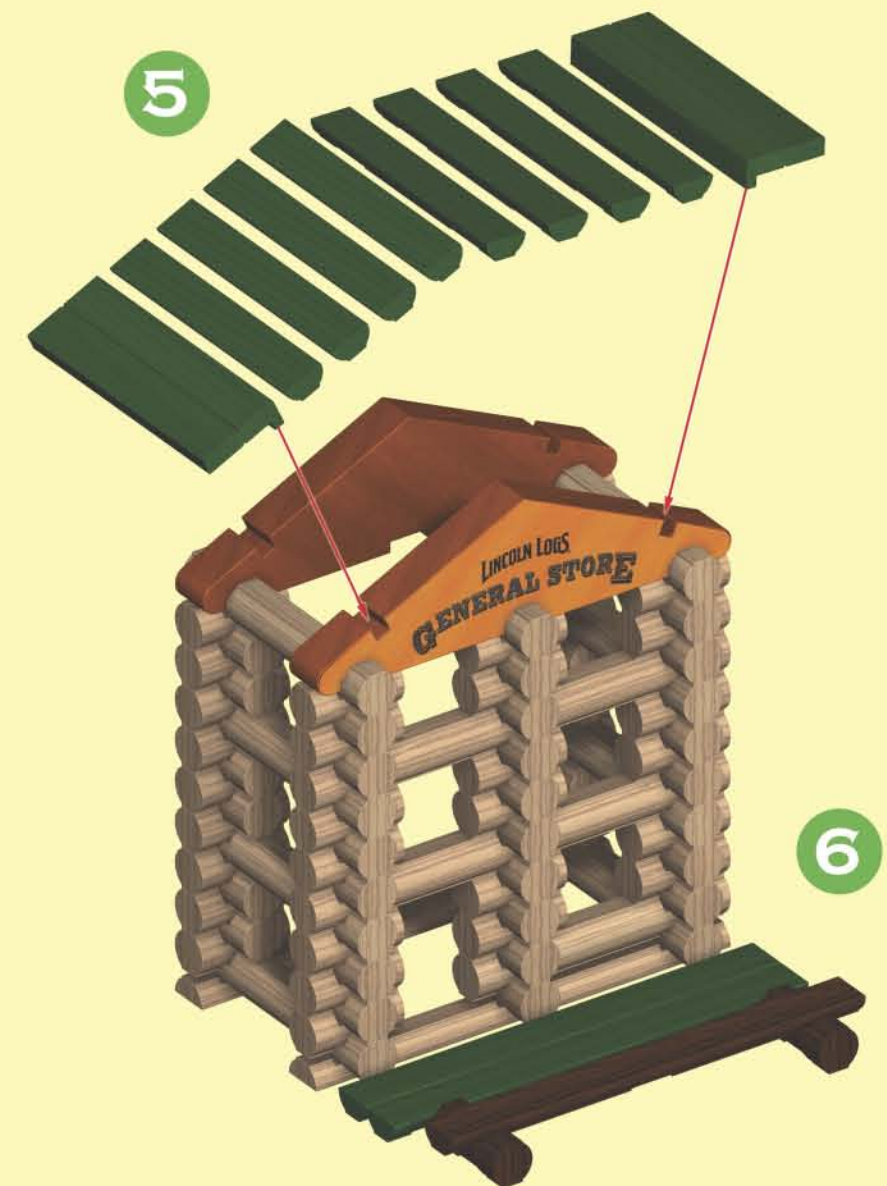
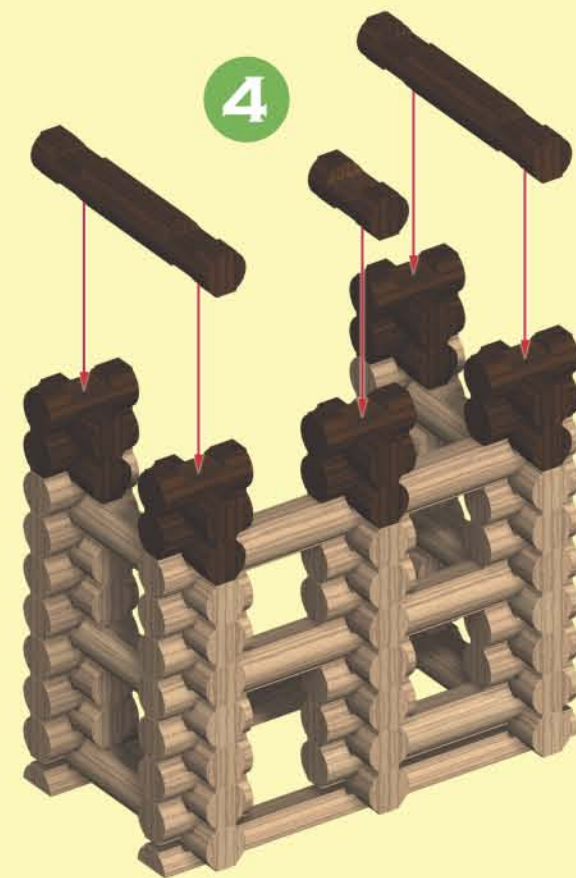
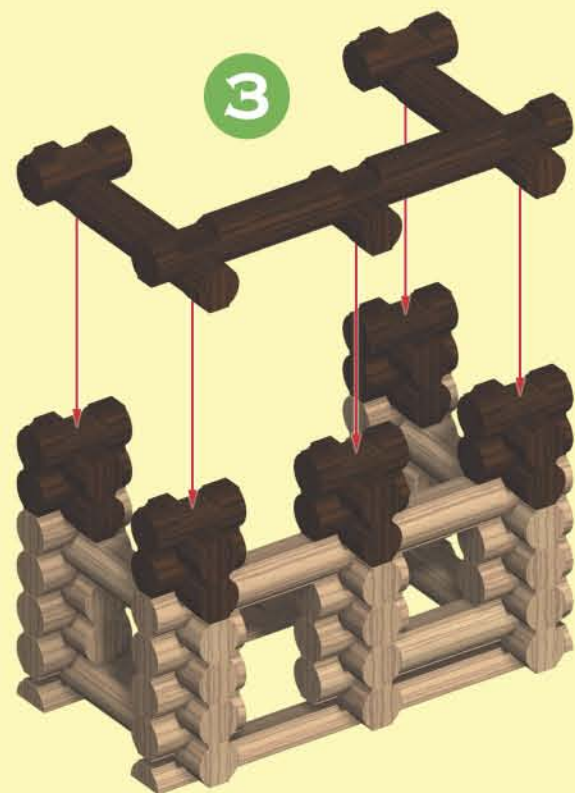
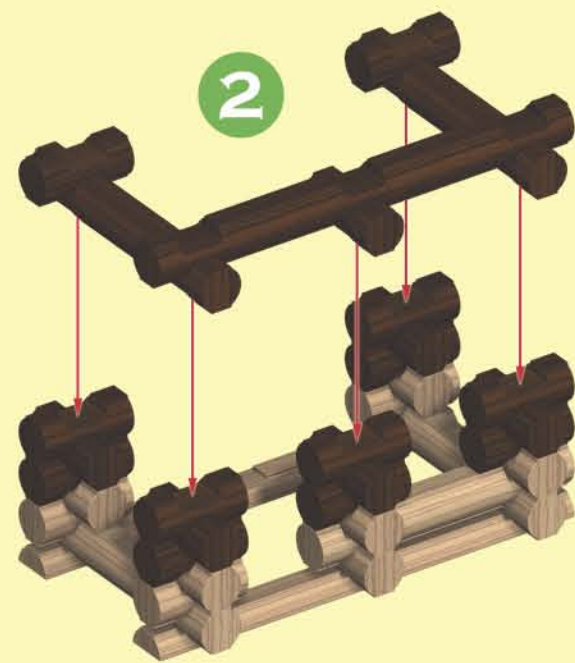
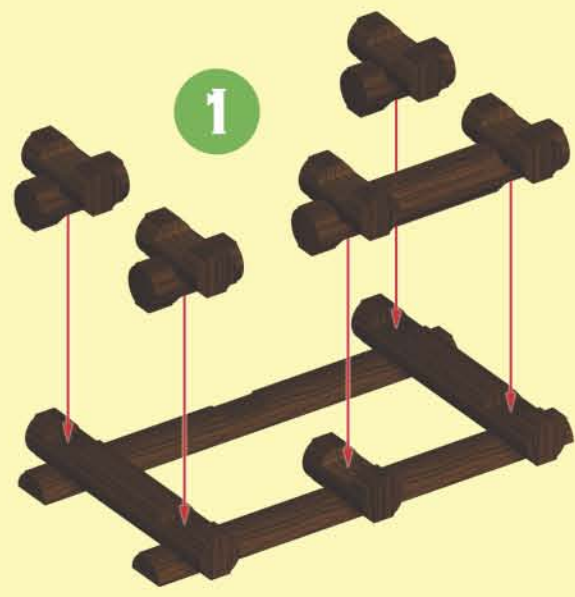

6

