

35035/45035

# EXPLORER

S E R I E S 1

Instructions

Anleitung

Instrucciones

Instruções

Istruzioni

Aanwijzingen

Instruksjoner

Byggevejledning

Ohjeet

ΟΔΗΓΙΕΣ

Anvisningar

説明書

AÇIKLAMALAR

説明書

הוראות



Creative Construction for Kids™

- GB** Contains small parts. Not suitable for children under the age of 3 years.
- F** Contient des pièces de petite taille. Ne convient pas aux enfants de moins de 3 ans.
- I** A causa dei suoi piccoli componenti, questo giocattolo non è adatto a bambini di età inferiore ai 3 anni.
- D** Enthält kleine Teile und ist daher nicht für Kinder unter 3 Jahren geeignet.
- E** Debido a la presencia de piezas pequeñas, no se recomienda su uso para menores de 3 años.
- S** Innehåller smådelar. Ej lämpligt för barn under 3 år.
- DK** Ikke egnet for børn under 3 år pga. smådele.
- N** Inneholder smådeler. Egner seg ikke for barn under 3 år.
- SF** Varoitus! Ei sovellu alle 3-vuotiaille lapsille. Sisältää pieniä osia.
- NL** Bevat kleine onderdelen. Niet geschikt voor kinderen jonger dan 3 jaar.
- P** Devido às dimensões reduzidas de algumas peças, não é recomendado para crianças de idade inferior a 3 anos.
- G** Λόγω των μικρών εξαρτημάτων που περιέχουν, δεν είαι κατάλληλα για παιδιά μικρότερα των 3 ετών.
- TR** Küçük parçalardan dolayı 3 yaşından küçük çocuklar için uygun değildir.
- J** 細かい部品がありますので、3才以下のお子様には適しません。
- CHI** 內含極小零件，不適合3歲以下孩童。
- IL** מאחר והערכה מכילה חלקים קטנים, היא אינה מתאימה לילדים מתחת לגיל 3.



### **WARNING:**

CHOKING HAZARD – Small Parts.  
Not for Children under 3 years.



### **AVERTISSEMENT!**

Danger d'étouffement. Pièces de petite taille.  
Ne pas donner aux enfants de moins de 3 ans.

**USA (GB) IF YOU CAN IMAGINE IT,  
YOU CAN BUILD IT!**

Your K'NEX Set is different from any other construction set you've ever seen. It has parts called "Connectors", "Rods", "Tires (Tyres)" and "Pulleys" that let you build anything from simple flat models to complex constructions that actually move. In fact, K'NEX parts can be put together in hundreds of different ways – allowing you to build almost anything you can imagine.

So although this book has all the easy to follow directions and pictures you need to build the models shown, the great thing is that there's no "right" or "wrong" way to build with K'NEX.

The choice is always yours.

The secret of following the instructions is that all the Connectors and Rods are color (colour) coded. They simply snap together. All you have to do is match the colors (colours) in your set to those in the step by step pictures. As long as you snap the parts together in the same way they are shown, your finished model will look just like the one in the instructions. What's more, you'll find it's even easier to build your model facing the same direction as the one in the book.

For practice, try assembling some of the simple shapes shown here...

Now choose which model you want to make (we suggest you start with one of the simpler models in the first half of this book) and you'll soon see why the excitement is building with K'NEX!



**D WENN SIE SICH'S VORSTELLEN  
KÖNNEN, DANN KÖNNEN SIE'S  
AUCH BAUEN !**

Ihr K'NEX-Bausatz unterscheidet sich von allen anderen, die Sie je gesehen haben. Da gibt es Teile wie Verbindungsstücke, Anschlußstifte, Reifen Radkappen und Laufräder, mit denen Sie von einfachen flachen Modellen bis hin zu komplexen Konstruktionen, die auch in Bewegung gesetzt werden können, alles bauen können, was Sie sich vorstellen können. Tatsächlich können die K'NEX-Teile in unzähligen Variationen zusammengesetzt werden. Sie können (fast) alles aus Ihrer Vorstellungswelt konstruieren.

Wenn Ihnen also diese Broschüre auch alle leicht verständlichen Anleitungen und Abbildungen zum Bau der gezeigten Modelle liefert, so ist es doch wichtig zu wissen, daß man mit K'NEX nicht "richtig" oder "falsch" bauen kann.

Wie Sie bauen, das bleibt allein Ihnen überlassen.

Das Geheimnis der leicht verständlichen Anleitungen liegt in der Farbkodierung. Die farbkodierten Verbindungsstücke und Anschlußstifte steckt man einfach ineinander, bis sie hörbar einschnappen. Sie müssen lediglich die Farbe der Teile in Ihrem Bausatz mit denen der Abbildungen vergleichen, um dann schrittweise den Zusammenbau vorzunehmen. Wenn Sie die Teile genau nach Anleitung zusammenstecken, dann erhalten Sie das Modell, das auf der Anleitung abgebildet ist. Noch einfacher haben Sie es, wenn Sie Ihr Modell beim Bauen so hinstellen, wie in der Abbildung gezeigt. Vielleicht versuchen Sie zur Übung erst einmal, einige von den einfacheren Modellen aus dieser Broschüre zu konstruieren.

Suchen Sie sich dann ein anderes Modell aus, das Sie gerne bauen möchten (am besten beginnen Sie mit einem der einfachsten Modelle, die Sie im ersten Teil der Broschüre abgebildet finden) und Sie werden sehr schnell herausfinden, warum das Bauen mit K'NEX so faszinierend und spannend ist!

**F SI VOUS POUVEZ L'IMAGINER VOUS  
POUVEZ LE CONSTRUIRE**

Votre kit K'NEX est différent de tous les autres kits de construction que vous ayez jamais vus. Il est constitué de pièces appelées "connecteurs", "baguettes", "pneus" et "poulies" qui vous permettent de réaliser n'importe quel objet, depuis des modèles plats simples jusqu'aux constructions les plus complexes qui peuvent être animées. En fait, les pièces K'NEX peuvent être assemblées de centaines de manières différentes... Vous pouvez construire tout ce que vous pouvez imaginer, ou presque.

En conséquence, bien que cette brochure donne toutes les instructions faciles à suivre nécessaires pour réaliser les modèles illustrés, ce qui est important, c'est qu'il n'y a pas de manière "correcte" ou "incorrecte" de construire avec K'NEX.

Le choix reste toujours le vôtre.

Le secret de la facilité des instructions, c'est que tous les connecteurs et toutes les baguettes ont un code couleur. Ils s'emboîtent tout simplement les uns dans les autres. Il vous suffit d'assortir, pas à pas, les couleurs de votre kit à celles des images de construction. Aussi longtemps que vous emboîtez les pièces de la façon indiquée, vous réaliserez un modèle qui sera la réplique exacte de celui présenté dans les instructions. Bien plus, votre tâche sera encore facilitée si vous orientez votre modèle dans le même sens que celui de la brochure.

A titre d'exercice, essayez de réaliser quelques-unes des simples formes illustrées ici...

Maintenant, sélectionnez le modèle que vous désirez construire (nous vous proposons de commencer avec un des modèles les plus simples que vous trouverez dans la première moitié de la brochure) et vous découvrirez bien vite pourquoi il est excitant et fascinant de construire avec K'NEX!

**I SE RIUSCITE A IMMAGINARLO,  
POTETE COSTRUIRLO!**

Il vostro K'NEX Set è diverso da tutte le altre scatole di costruzioni che avete veduto prima. Contiene parti chiamate "raccordi", "aste", pneumatici e "pulegge" che vi consentono di costruire quello che volete, da semplici modelli piani a costruzioni complesse, addirittura mobili. Infatti le parti del K'NEX possono venire assiate in centinaia di modi diversi, consentendovi di costruire praticamente tutto quanto possiate immaginare.

Di conseguenza, anche il presente opuscolo contiene tutte le indicazioni e figure facili da seguire occorrenti per costruire i modelli illustrati; la cosa più bella è che non esiste un modo "giusto" o "errato" per costruire con il K'NEX.

La scelta spetta sempre a voi.

Il segreto per seguire le istruzioni è che tutti i raccordi e le aste sono contraddistinti da colori. Si accoppiano semplicemente a scatto. Basta combinare i colori dei pezzi della vostra scatola con i colori dei pezzi delle illustrazioni, che indicano il da farsi un pezzo dopo l'altro. Se disporrete tutte le parti assieme nel modo illustrato, il vostro modello finito sarà esattamente uguale a quello raffigurato nelle istruzioni. Per di più, troverete anche più facile costruire il vostro modello nella medesima direzione di quello del libretto di istruzioni.

Per far pratica, provate a comporre alcune delle forme più facili illustrate qui...

Scegliete ora il modello che desiderate costruire (vi consigliamo di iniziare con uno dei più semplici contenuti nella prima metà di questo opuscolo), e vi renderete conto immediatamente del divertimento che trarrete dalle costruzioni con K'NEX!

## **E** SI PUEDES IMAGINARLO, PUEDES CONSTRUIRLO

Tu Juege K'NEX es diferente a cualquier otro juego de construcción que has visto hasta ahora. Posee piezas denominadas 'conectores', 'varillas', y 'poleas' que te permitirán construir cualquier cosa, desde simples modelos planos hasta complejas construcciones que incluso se mueven. De hecho, las piezas de K'NEX pueden ser unidas en cientos de formas distintas - permitiéndote construir prácticamente cualquier cosa que puedas imaginar.

Aunque este folleto contiene todas las sencillas instrucciones y fotos que necesitas para construir las figuras mostradas, lo mejor de todo es que no existe una manera correcta o errónea de construir con K'NEX.

La elección es siempre tuya.

El secreto de seguir las instrucciones es que todos los conectores y varillas están codificados por colores. Simplemente encajan unos con otros. Todo lo que tienes que hacer es igualar los colores en tu juego con aquellos en las fotos paso a paso. Mientras encajes las piezas de la misma forma que se muestra, tu figura terminada se parecerá a la de las instrucciones. Y lo que es más, encontrarás que incluso es más fácil construir tu figura orientado en la misma dirección que el del folleto.

Como práctica, intenta construir algunas de las figuras simples que aquí se muestran...

¡Ahora elige la figura que quieres construir (te sugerimos que comiences con una de las figuras más simples que se encuentran en la primera mitad del folleto) y enseguida notarás la emoción de construir con K'NEX!

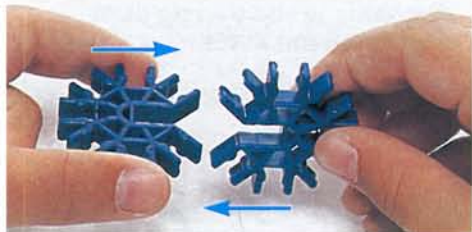

## **S** FANTASIN ÄR ENDA BEGRÄNSNINGEN!

Din K'NEX byggsats är annorlunda från andra byggsatser. Har finns delar som kallas för "anslutare", "pinnar", "däck och hjul och med dem kan du bygga allt från enkla modeller till komplicerade konstruktioner som rör sig. Faktum är att K'NEX sätts samman på hundratals olika sätt - du kan bygga nästan vad du vill, fantasin är enda begränsningen.

I den här boken finner du enkla anvisningar som är lätta att följa och bilder som visar hur du kan göra, för det finns inget som heter rätt eller fel när du bygger med K'NEX. Valet är alltid ditt.

Hemligheten med att följa instruktionerna är att anslutarna och pinnarna är färgkodade. De passar helt enkelt tillsammans. Allt du behöver göra är att följa färgerna på bilderna steg för steg. Om du följer instruktionerna kommer din modell att se ut som den på bilden. Det är dessutom enklare att bygga din modell om du vänder den åt samma håll som i boken.

Som övning kan du sätta ihop några av de här modellerna...

Välj nu vilken modell du vill göra (vi föreslår någon av de enklare modellerna i den första delen av boken) och snart kommer du att ha jättekul med K'NEX!

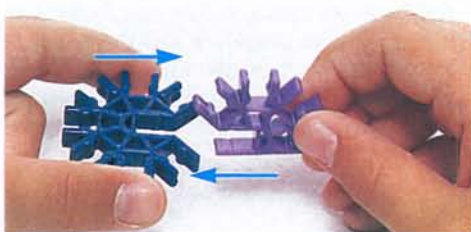

## **DK** HVIS DU KAN FORESTILLE DIG DET, SÅ KAN DU OGSÅ BYGGE DET!

K'NEX sættet er anderledes end alle andre byggesæt, du nogensinde har set. Det består af forskellige dele, de såkaldte 'samleelementer', 'stænger', dæk og 'remskiver', hvormed du kan bygge alt fra enkle, flade modeller til komplicerede konstruktioner, der kan bevæge sig. Faktisk kan K'NEX dele samles på hundredvis af forskellige måder - så du kan bygge næsten alt, hvad du kan forestille dig.

Så selv om der i denne bog findes alle de vejledninger og billeder, som du har brug for at kunne bygge de viste modeller og som er lette at følge, er det bedste ved sættet, at der ikke er nogen 'rigtig' eller 'forkert' måde at bygge med K'NEX på. Du kan altid selv bestemme, hvordan du vil bære dig ad.

Hemmeligheden ved at følge byggevejledningen er, at alle samlelementer og stænger er farvekodede. Delene skal blot trykkes sammen. Du skal blot matche farverne i sættet med dem på billeder, der viser samlingen trin for trin. Blot du trykker delene sammen på samme måde som vist, kommer den færdige model til at se ud nøjagtigt som i vejledningen. Endvidere vil du finde, at det er endnu lettere at bygge modellen, hvis den vender samme vej som i bogen.

Du kan øve dig ved at samle nogle af de enkle ting, der er vist her...

Vælg nu hvilken model du ønsker at bygge (vi foreslår, at du begynder med en af de enklere modeller i bogens første halvdel), og du vil hurtigt se, hvor spændende det er at bygge med K'NEX!

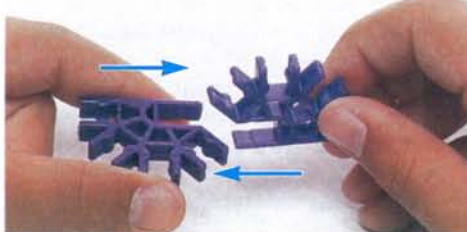

## **N** HVIS DU KAN FORESTILLE DEG DET, KAN DU BYGGE DET!

K'NEX settet er helt forskjellig fra andre byggesett. Det har deler som forbindelsesstykker, stenger, dekk og skiver, som gjør at du kan bygge alt fra enkle, flate modeller til kompliserte modeller som kan bevege seg. Delene kan settes sammen på mange hundre forskjellige måter - slik at du kan bygge nær sagt alt du kan forestille deg.

Så selv om dette heftet har alle anvisningene og bildene du trenger for å bygge de enkelte modellene, finnes det ikke noen "riktig" eller "gal" måte å bygge på. Valget er ditt.

Det er lett å følge instruksjonene, fordi alle forbindelsesstykkene og stengene er fargekodet og kan smekkes sammen. Alt du har å gjøre er å finne de fargene som står på bildene. Så lenge du bygger delene på samme måte som vist, vil modellen se ut som på bildet. Og det er enda lettere å bygge modellen i samme retning som den i heftet.

Øv deg på å sette sammen noen enkle deler som vist her...

Nå kan du velge hvilken modell du vil bygge (begynn helst med en enkel modell i første halvdel av heftet), og du ser snart hvor spennende det er å bygge med K'NEX!

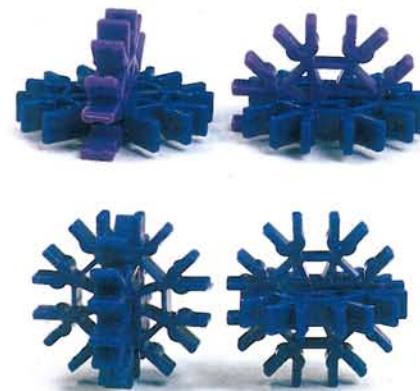

**SF OS OSAAT KUVITELLA SEN, OSAAT MYÖS RAKENTAA SEN!**

K'NEX on erilainen kuin kaikki muut näkemäsi rakennussarjat. Siihen kuuluu osia kuten 'liittimet', 'tangot', 'renkaat' ja 'hihnapyörät', joita käytetään voit rakentaa mitä tahansa aivan yksinkertaisista yhteen tasoon rajoituvista malleista aina monimutkaisiin ja todella liikkuviin laitteisiin asti. K'NEX-osista on mahdollista koota satoja erilaisia kokonaisuuksia ja siten voit rakentaa melkein mitä tahansa oman mielikuvituksesi mukaan.

Tässä kirjasessa on helposti seurattavat ohjeet ja kuvat, jotka tarvitaan siinä esitettyjen mallien rakentamiseen. On kuitenkin mukava tietää, että K'NEX-osien kokoamisessa ei oikeastaan ole mitään "oikeaa" tai "väärää" tapaa, vaan Sinulla on aina valta vapaasti valita kuinka sen suoritaa.

Ohjeiden seuraamista on helpotettu värikoodein, joita käytetään kaikissa liittimissä ja tangoissa. Nämä kiinnitetään toisiinsa pelkästään napsauttamalla. Sinun on vain noudatettava vaihe vaiheelta etenevässä kuvissa näkemiäsi värejä, kun kokoat omaa sarjaasi. Kun napsautat osat yhteen kuvien esittämällä tavalla, silloin itse kokoamastasi mallista tulee aivan samanlainen kuin ohjeiden kuvissa. Voit sitä paitsi tehdä rakentamisen vielä helpommaksi pitämällä mallin kokoamisen aikana samansuuntaisena kuin kuvissa.

Harjoittele kokoamalla joitakin tässä esitettyjä yksinkertaisia malleja...

Valitse sitten minkä mallin haluat rakentaa. (Ehdotamme, että kokoat aluksi jonkin tämän kirjasen alkupuoliskossa esitetyistä yksinkertaisemmista malleista.) Huomaat kyllä pian miksi K'NEX tekee askartelustasi niin jännittävän!

**NL HOE GEK JE HET OOK BEDENKT JE KAN HET MAKEN!**

Jouw K'NEX set is anders dan andere bouwpaketten. Het bevat onderdelen zoals "verbindingsstukken", "roedes", banden en "katrollen" waarmee je van alles kan maken, van eenvoudige tot en met ingewikkelde bouwsels, die bovendien kunnen bewegen. Nou en of, K'NEX onderdelen kunnen op honderd verschillende manieren in elkaar worden gezet - zodat je alles kan bouwen wat je maar bedenken kan.

En, al zit dit boek vol met allerlei voorbeelden en afbeeldingen met eenvoudige aanwijzingen om dingen te bouwen, het beste is dat er nooit een "goede" of "foute" manier is om met K'NEX dingen te maken. Jij doet het precies zo als je wilt.

Het geheim van het volgen van de aanwijzingen is dat alle verbindingstukken en roeden een kleurencode hebben. Ze passen gemakkelijk in elkaar. Paar de onderdelen uit jouw set met de kleuren op de tekening. Zolang je de onderdelen zoals afgebeeld aan elkaar bevestigt, ziet je uiteindelijke bouwset er net zo uit als op het plaatje. Bovendien, het is zelfs gemakkelijker om het model na te bouwen wanneer je het op de voorkant blijft zien net als op het plaatje in het boek.

Oefen maar eens met de eenvoudige voorbeelden die we hier beneden laten zien...

Kies nu het model uit dat je wilt nabouwen (wij stellen voor dat je eerst met iets eenvoudigs begint uit het eerste deel van het boek) en al snel ontdek je waarom het spelen met K'NEX zo spannend is!

**P SE CONSEQUES IMAGINAR, CONSEGUES CONSTRUIR!**

O teu Conjunto K'NEX é diferente de qualquer outro conjunto de construção que tenhas visto. Tem peças chamadas conectores, hastes, pneus e polias que te permitem construir qualquer coisa, desde simples modelos planos a construções complexas que se movem de verdade. As peças K'NEX podem de facto ser montadas de centenas de maneiras diferentes - permitindo-te construir praticamente qualquer coisa que consigas imaginar.

Portanto, embora este manual tenha todas as instruções fáceis e gravuras de que necessitas para construíres os modelos ilustrados, o que é ótimo é que não há maneiras "certas" ou "erradas" de construir com o K'NEX. Tu é que escolhes sempre. O segredo ao seguir as instruções é que todos os conectores e hastes são codificados por cores e encaixam simplesmente uns nos outros. Basta fazeres a correspondência das cores do teu conjunto às que vêm nas figuras "passo-a-passo".

Desde que encaixes as peças umas nas outras da forma ilustrada, o teu modelo final será exactamente como o que vêm nas instruções. E vais ver também que é ainda mais fácil construíres o teu modelo se o voltares na mesma direcção que o ilustrado no manual.

Para praticares, tenta montar algumas das formas simples aqui ilustradas...

A seguir escolhe o modelo que queres fazer (sugerimos que comeses com um dos modelos mais simples da primeira metade do manual) e depressa sentirás a emoção de construir com K'NEX!

**G AN MΠΟΡΕΙΤΕ ΝΑ ΤΟ ΦΑΝΤΑΣΤΕΙΤΕ,****ΜΠΟΡΕΙΤΕ ΝΑ ΤΟ ΚΑΤΑΣΚΕΥΑΣΕΤΕ!**

Το δικό σου σετ της K'NEX διαφέρει από κάθε άλλο σετ κατασκευών που έχετε δει ποτέ. Έχει εξαρτήματα που λέγονται "σύνδεσμοι", "ράβδοι", "ελαστικά" και "τροχαλίες" που σας επιτρέπουν να φτιάχνετε οτιδήποτε, από απλά επίπεδα μοντέλα μέχρι και σύνθετες κινούμενες κατασκευές. Στην πραγματικότητα, τα εξαρτήματα της K'NEX μπορούν να συναρμολογηθούν με εκατοντάδες διαφορετικούς τρόπους - επιτρέποντάς σας να φτιάξετε σχεδόν ό,τι φανταστείτε. Έτσι, αν και το το φυλλάδιο αυτό σας δίνει όλες τις εύκολα κατανοητές οδηγίες και εικόνες που χρειάζεστε για να φτιάξετε τα μοντέλα που σας δείχνουμε, το σπουδαίο είναι ότι δεν υπάρχει "σωστός" ή "λάθος" τρόπος να κάνετε κατασκευές με την K'NEX. Η επιλογή είναι πάντα δική σας. Το μυστικό του πώς να ακολουθήσετε τις οδηγίες είναι ότι όλοι οι σύνδεσμοι και ράβδοι έχουν τον δικό τους χρωματικό κωδικό. Πολύ απλά, εφαρμόζουν ο ένας στον άλλο. Το μόνο που έχετε να κάνετε είναι να ταιριάξετε τα χρώματα στο σετ σας με αυτά στις εικόνες της σταδιακής συναρμολόγησης. Απο τη στιγμή που θα ενώσετε τα εξαρτήματα με τον ίδιο τρόπο που σας δείχνουμε, το τελειωμένο μοντέλο σας θα μοιάζει ακριβώς με το μοντέλο των οδηγιών. Επίσης, θα διαπιστώσετε ότι είναι πió εύκολο να φτιάξετε το μοντέλο σας βλέποντας προς την ίδια κατεύθυνση προς την οποία βλέπει το μοντέλο στο φυλλάδιο. Για να κάνετε πρακτική εξάσκηση, προσπαθείστε να συναρμολογήσετε ορισμένα από τα απλά σχήματα που βλέπετε εδώ... Τώρα διαλέξτε ποió μοντέλο θέλετε να κατασκευάσετε (σας προτείνουμε να αρχίσετε με ένα από τα πió απλά μοντέλα στο πρώτο μισό αυτού του φυλλαδίου) και σύντομα θα δείτε γιατί είναι τόσο συναρπαστικό να κάνετε κατασκευές με την K'NEX!

## TR BİRŞEYİ HAYAL EDEBİLİYORSANIZ, ONU MONTE EDEBİLİRSİNİZ.

K'NEX setiniz daha önce gördüğünüz diğer tüm monte edilebilen setlerden farklıdır. 'Birleştirici', 'çubuk', 'tekerlek', ve 'makara' adı verilen parçalarla en basit düz modellerden, hareket edebilen en karmaşık modellere kadar her modeli monte edebilirsiniz. Gerçekten K'NEX parçaları yüzlerce değişik şekilde birleştirilerek hayal ettiğiniz hemen hemen herşeyi monte etmenize olanak sağlar.

Bu kitapçık gösterilen modelleri monte etmeniz için gerekli tüm kolay anlaşılır açıklama ve resimleri içerir, fakat K'NEX'in asıl güzelliği K'NEX'le doğru ya da yanlış monte etme diye birşey yoktur.

Seçim daima sizindir.

Açıklamaların kolayca takip edilebilmesi için tüm birleştirici, ve çubuklar değişik renklerde kodlanmıştır. Parçalar kolayca birbirlerine geçer. Bütün yapacağınız setinizdeki renkleri resimlerdeki renklere kademe kademe uydurmaktır. Parçaları gösterildiği şekilde birbirlerine eklediğiniz sürece tamamlanmış modeliniz aynen kitapçıktaki gibi olacaktır. Üstelik, modelinizi kurarken kitapçıktaki modelin yönünü takip ederseniz modelinizi daha da kolaylıkla kurabileceksiniz.

Deneme için burada gösterilen bazı basit şekilleri bir araya getirmeye çalışın...

Şimdi de yapmak istediğiniz modeli seçin (bu kitapçığın birinci yarısındaki basit modellerden biriyle başlamanızı öneririz). Kısa zamanda K'NEX'le monte etmenin heyecanının ne olduğunu göreceksiniz.

## J イメージさえつかめれば 組み立てられる!

K'NEXキットは、市販されているその辺の積木キットとは一味違う。「連結バー」、「棒」、「タイヤ」、「滑車」などのパーツが用意されていて、簡単なモデルから複雑な構造を持つモデルまで、自由自在に組み立てることができる。そこがK'NEXの面白いところだ。また、モデルによっては実際に動かすこともできる。K'NEXのもう1つの魅力は、これらのパーツの組み合わせが無数にあること。これで、イメージにフィットしたモデルをどんどん作り上げていくことができる。

本書には、各モデルの組み立てに必要な説明と参考図が挿入されているが、これらが唯一正しい組み立て方法とは限らない。そもそも、K'NEXではモデルを作る手順で、正しいとか、間違つたとかいう規制棒がないのだ。K'NEXの組み立て方は、すべてユーザー次第といえる。

組み立て手順の説明を理解する上で、すべての連結バーと棒が色付けされていることに注意して臨むのがコツである。色付けされた部分をつなくと、カチッと音がするから、フィットしたかどうかすぐに分かる。ということは、それぞれの組立段階で部品の色さえ注意して組み込んでいけばいいということになる。こうしてモデルを完成させていけば、最終的には図のモデルと同じシロモノが完成するというわけだ。なお、参考図のモデルと同じ向きで組み立てていく方が、完成させるのに楽である。

手始めに、ここに載せてあるやさしいモデルの組み立てにトライしてみよう。

どれでも好きなモデルを選んで構わないが、最初はできるだけ本書の前半にある簡単なモデルを選んだ方が無難。さあ、それではスタートだ。知らない間に、K'NEXにハマッてしまったのでは!

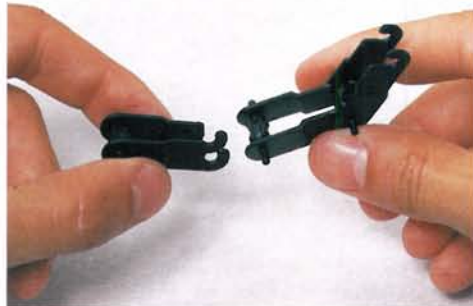

## CHI 只要你想得出， 你就能搭起來!

K'NEX 積木和你常見的其它積木不同。它有一些叫做“連接器”、“桿”、“輪胎”及“滑輪”的零件，用它們你可以搭起扁平模型到建造複雜甚至會動的構件。事實上，K'NEX的零件可以用幾百種方式拼搭起來 - 讓你也能搭建出你想得出來的任何東西。

因此，雖然這本冊子上有說明和圖片讓你依樣畫葫蘆搭造示出的模型，但最大的樂趣卻在於無拘束地用K'NEX盡情發揮。

選擇永遠是你的

使用說明的秘訣是所有的連接器和桿都是用顏色來區分的。它們很容易拼裝在一起。你所要做的只是使你搭的該零件的顏色和圖片說明上顏色相符。只要你照著圖片顯示，一步一步地把零件拼起來，完成的模型就會和說明書上的一樣。還有，搭造模型時和畫上圖片所示的方向一致，做起來就會更容易了。

爲了練習，先試試這幾個簡單的形狀看看...

現在選擇你想做的模型 (我們建議先從本書前半部中的幾個簡單模型著手)，然後你會發現搭建 K'NEX 爲何令人興奮!



## IL אם אתה יכול לדמיין את זה, אתה יכול לבנות את זה!

ערכות הנייה של K'NEX שונות מכל ערכות הנייה האחרות שאתה מכיר. יש בהן חלקים הנקראים מחברים, מוטות גלגלים וגלגלות, המאפשרים לך לבנות כל דבר, החל מדגמים פשוטים ושטוחים, ועד למבנים מורכבים שמתנועעים ומסתובבים. למעשה, חלקי K'NEX ניתנים להרכבה במאות צורות שונות, כך שתוכל לבנות כמעט כל דבר שאתה יכול לדמיין.

לכן למרות שבחברת זו מופיעות כל ההוראות והתמונות הדרושות לך כדי לבנות את הדגמים המופיעים בתמונות, הדבר הנפלא הוא שאין דרך "נכונה" או "לא נכונה" לבנות עם K'NEX

הבחירה היא תמיד שלך.

הסוד של ההוראות הוא שכל המחברים והמוטות מקודדים על פי צבעים. הם פשוט מתחברים יחד. כל מה שעליך לעשות הוא להתאים את הצבעים שבער-כה שלך לאלה בתמונות, המפרטות את צעדי הנייה השונים. כל עוד שתחבר את החלקים יחד כפי שהם מופיעים בתמונות, הדגם הסופי שלך יראה בדיוק כמו זה בהוראות. יתר על כן, תגלה כי אפילו קל יותר לבנות את הדגם שלך כאשר הוא פונה לאותו כיוון כמו הדגם המופיע בחוברת.

כדאי לתרגל הרכבה של חלק מהצורות הפשוטות המופיעות כאן...

עתה, בחר איזה דגם ברצונך להרכיב (אנו ממליצים כי תתחיל עם אחד הדגמים הפשוטים המופיעים בחצי הראשון של חוברת זו), ותגלה את ההתרגשות של הנייה עם K'NEX!



# Dinosaur

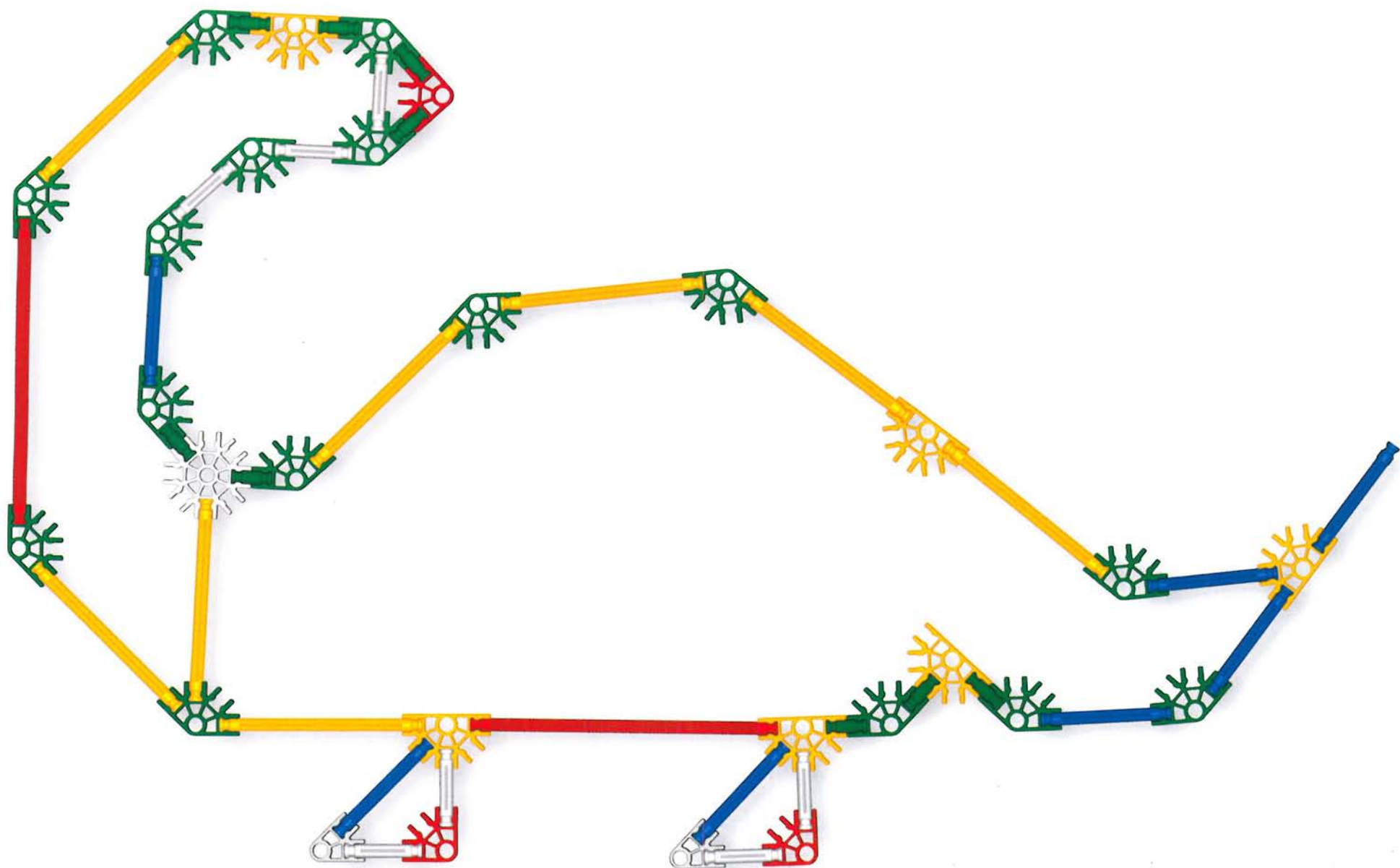

# Robot

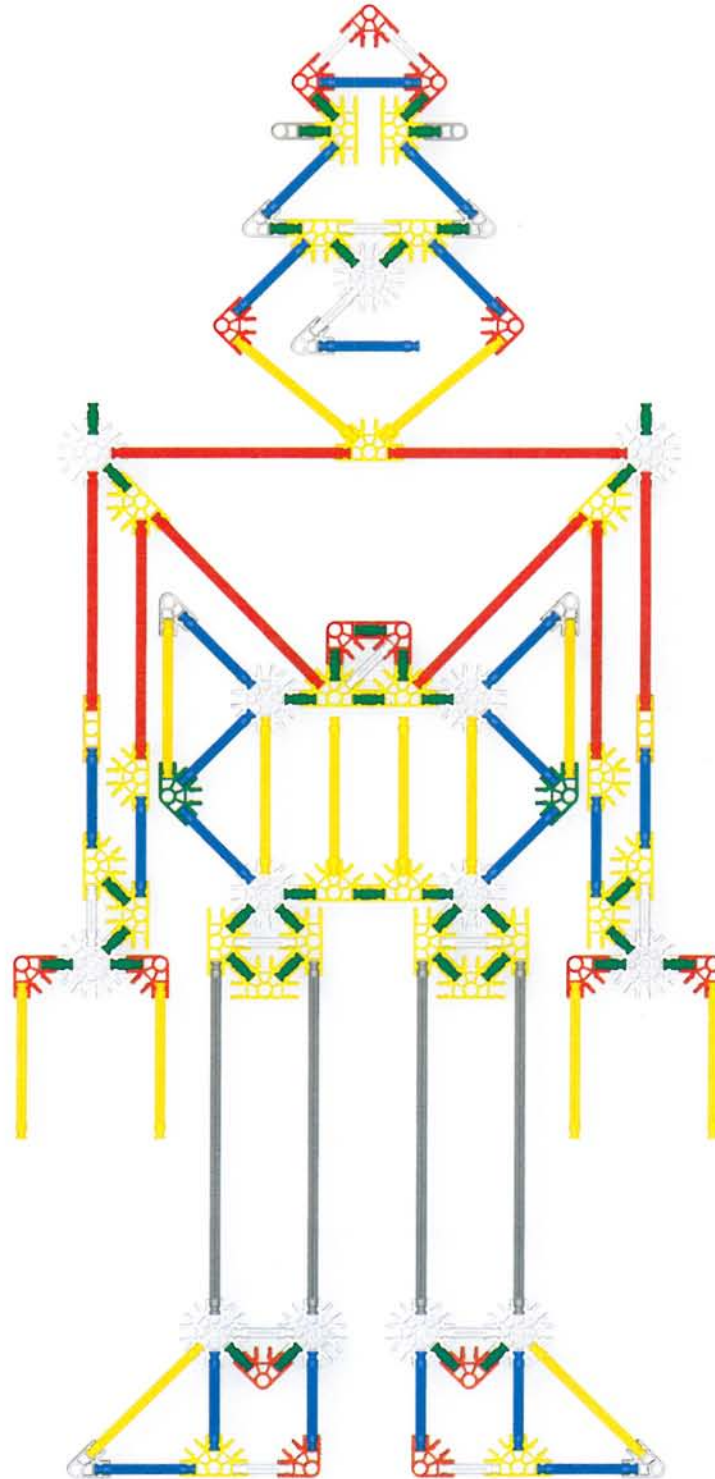

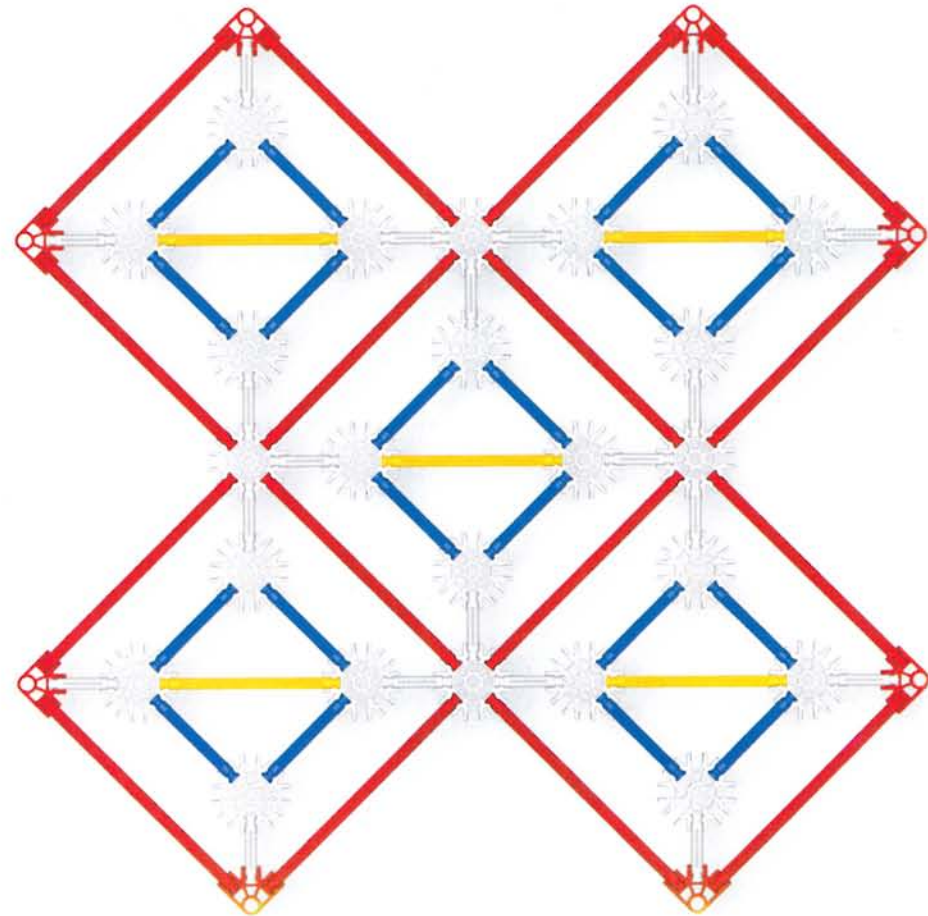
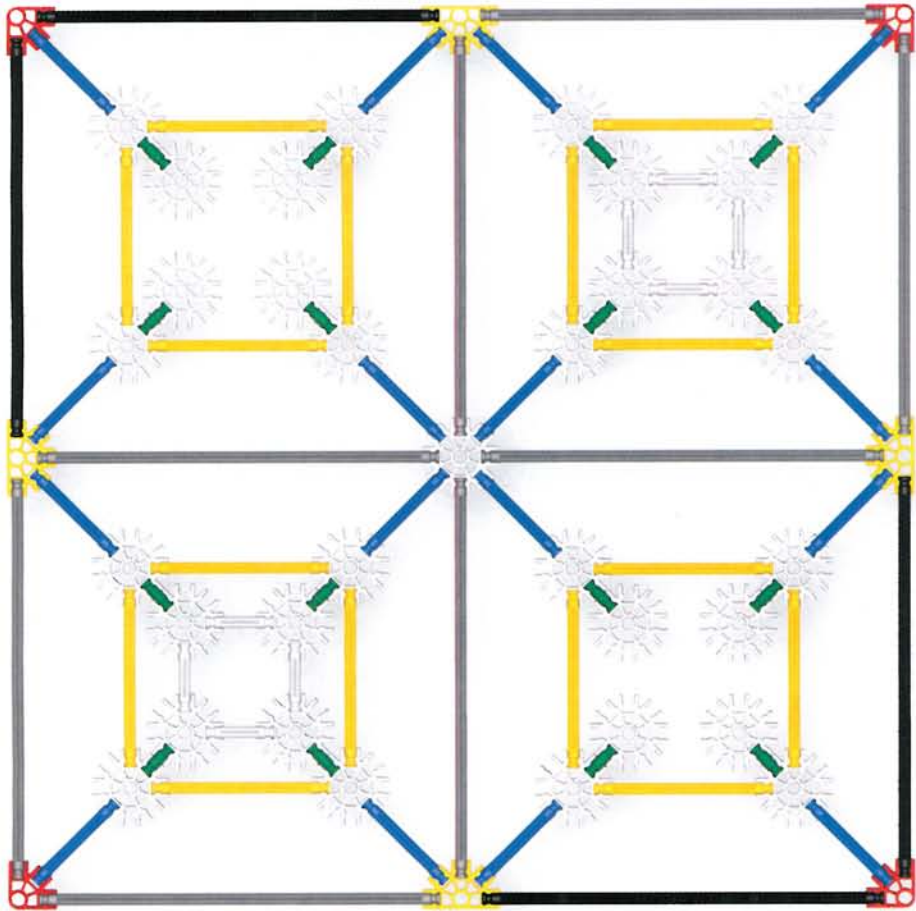

# Wrench



# L-Square

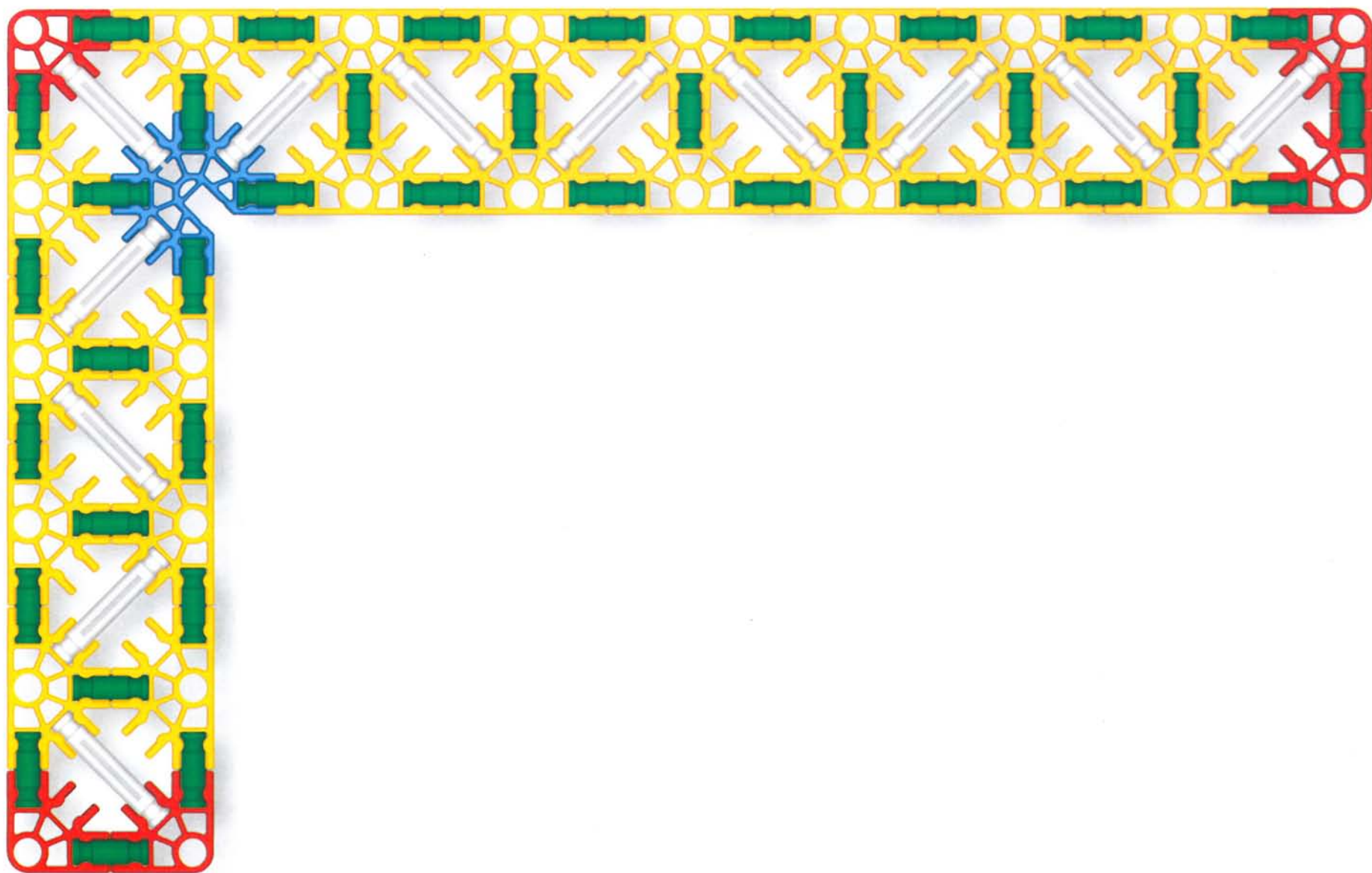

# Hammer and Drill

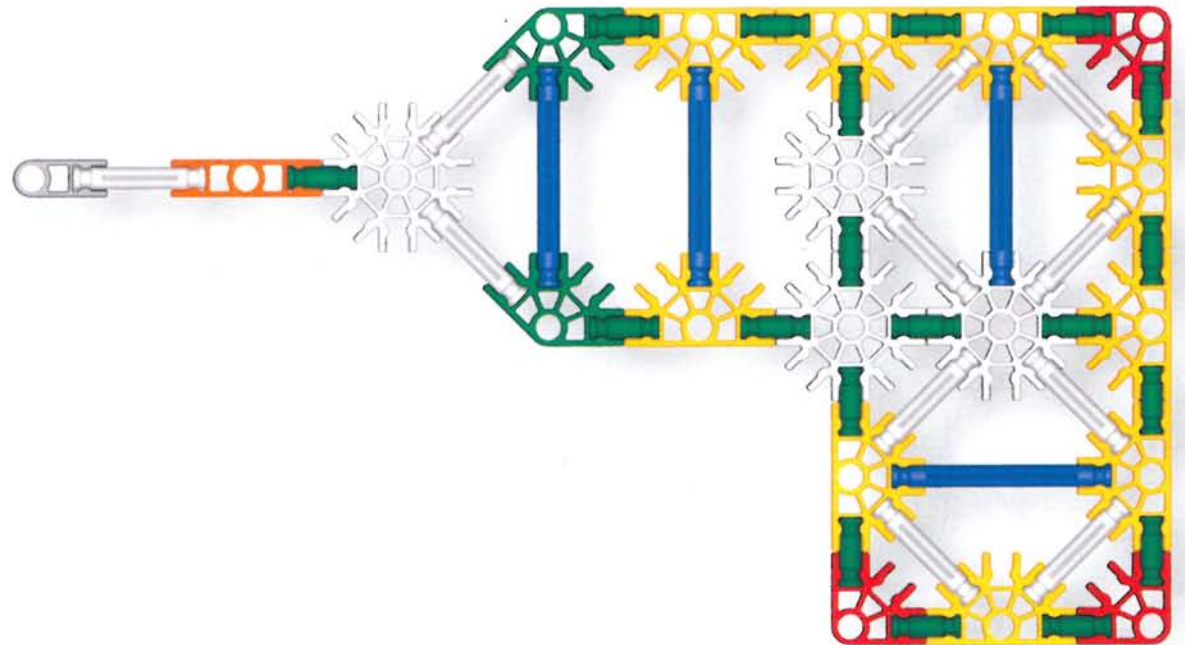
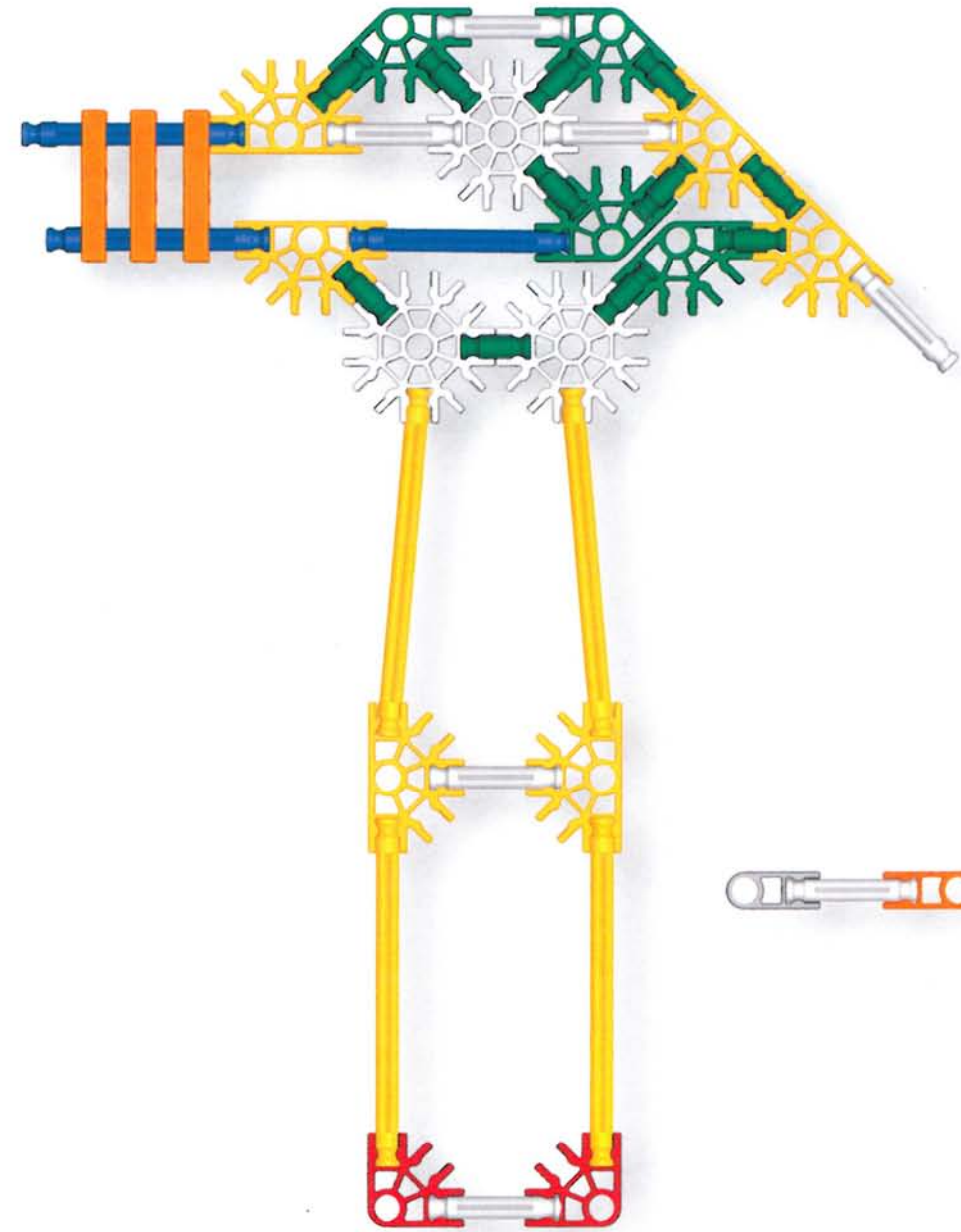

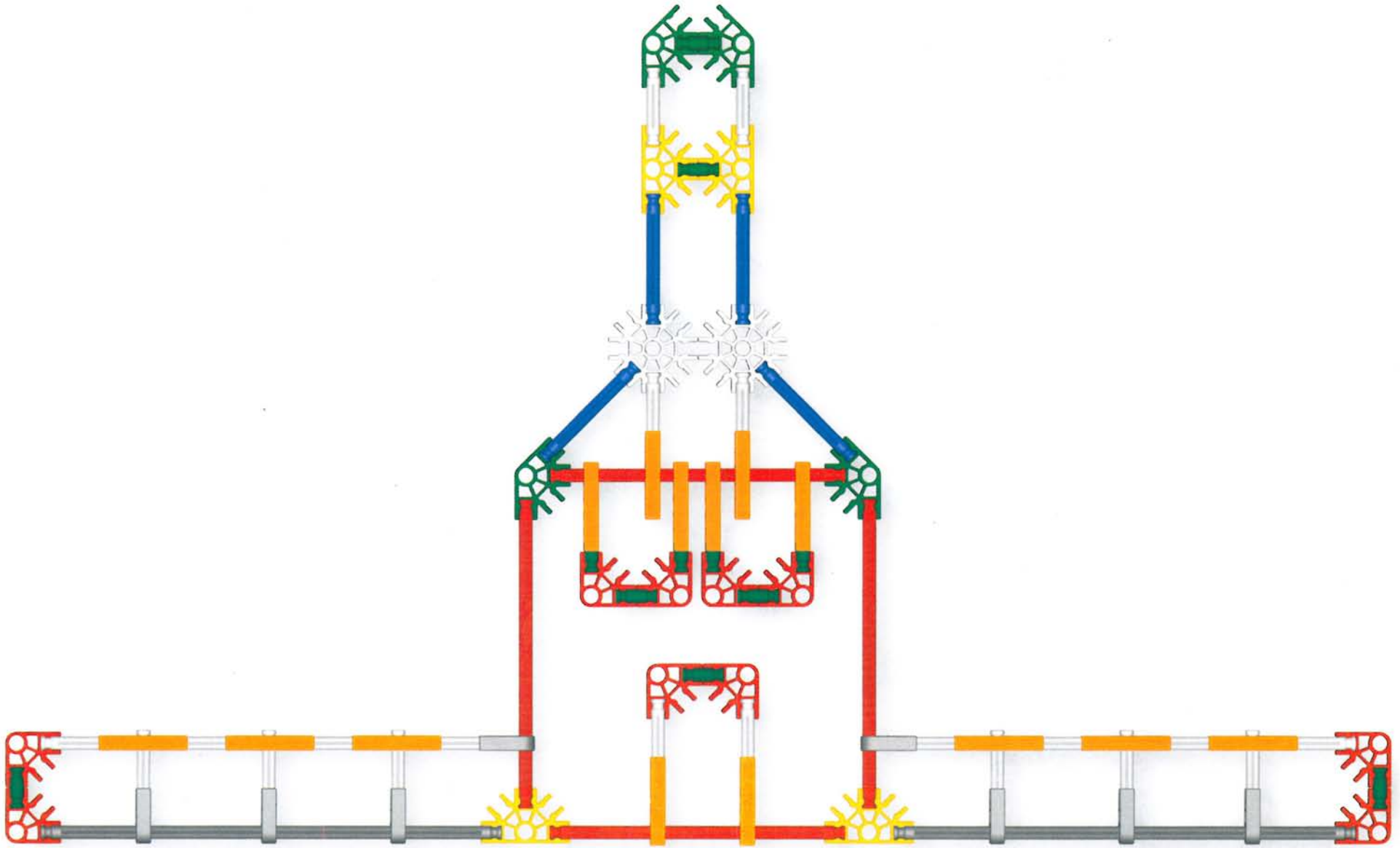

# Saw

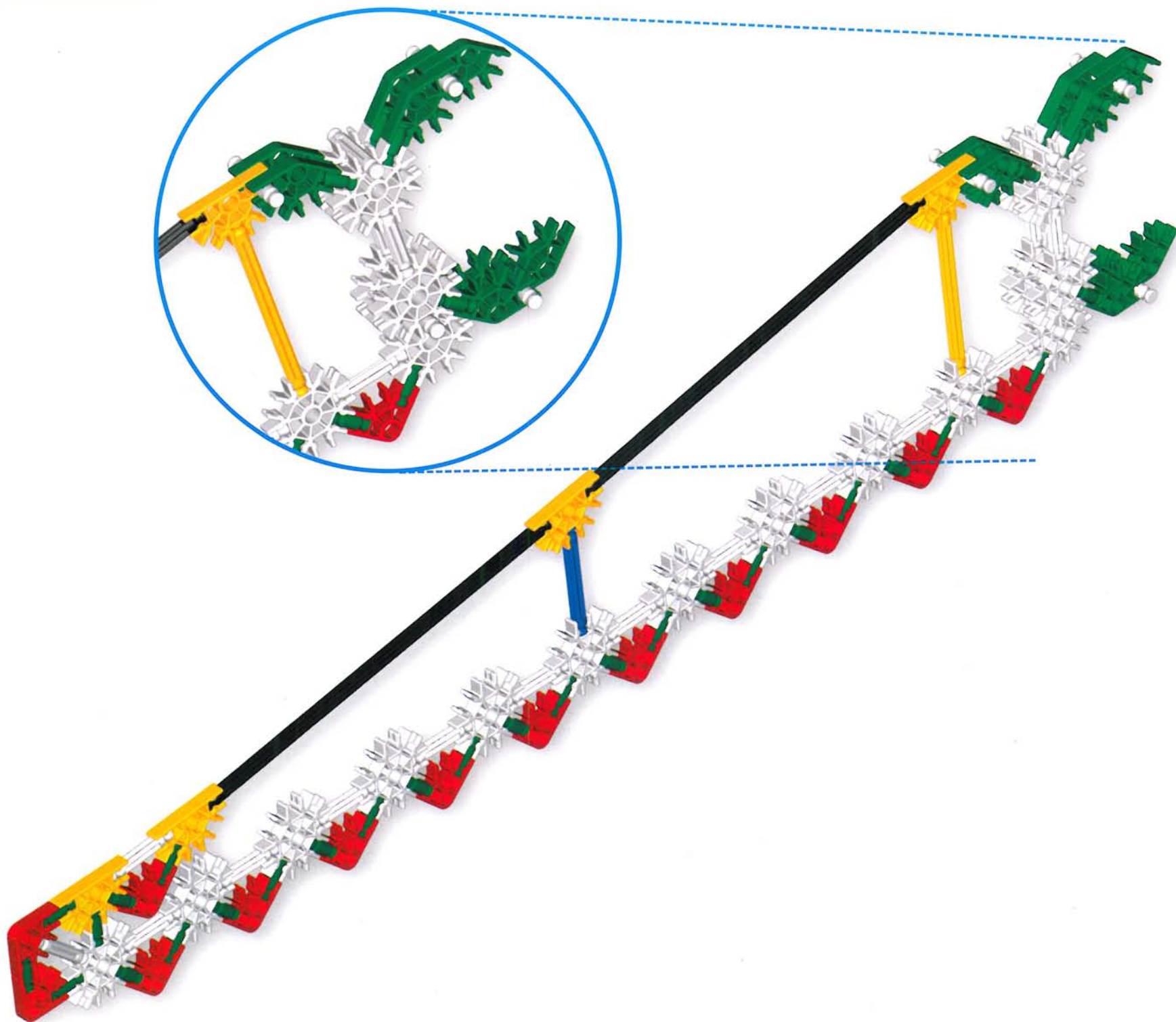

# Screwdriver

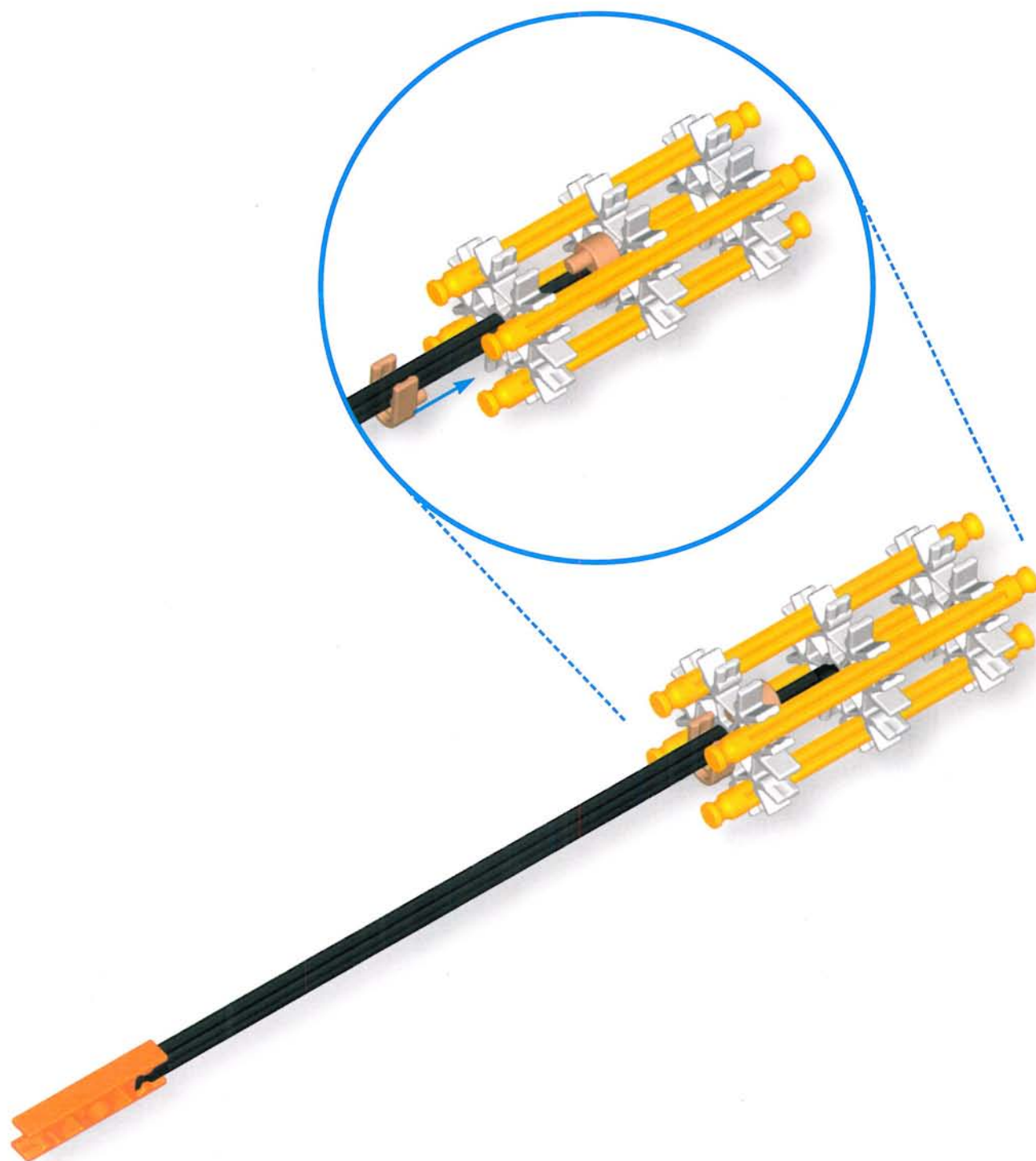

# Picture Frame

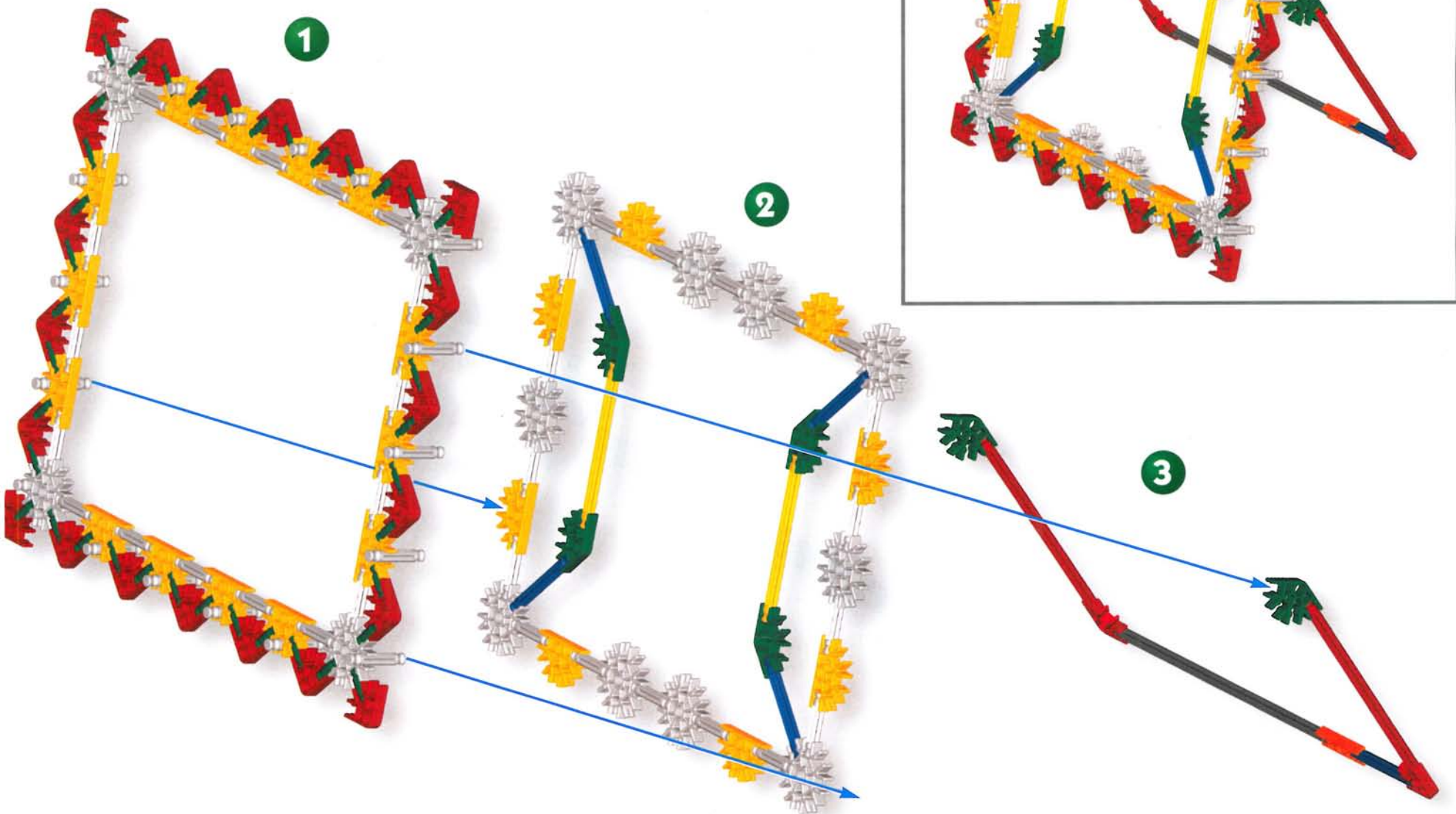

# Large Picture Frame

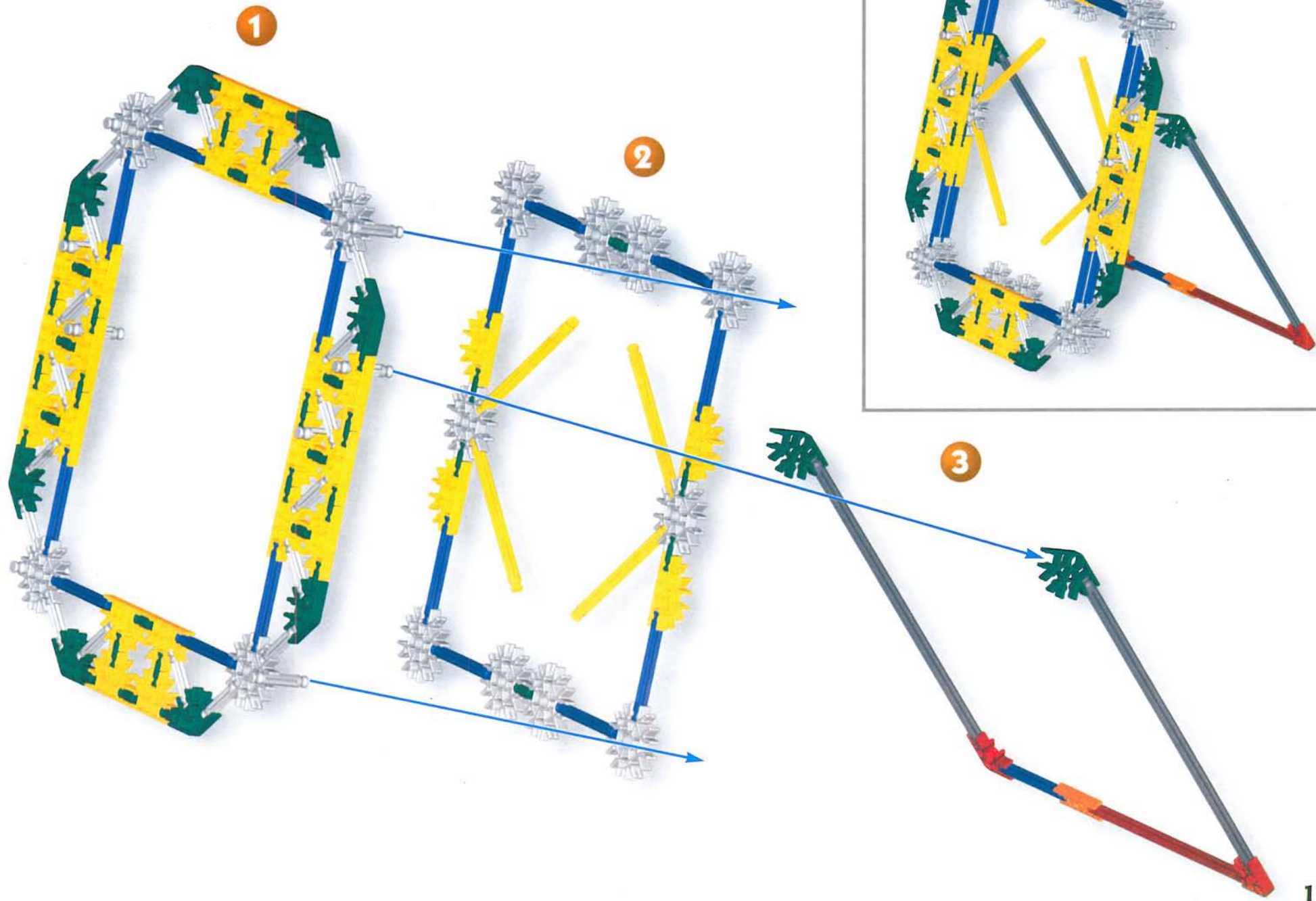

# Golf Game



# Horseshoes Game

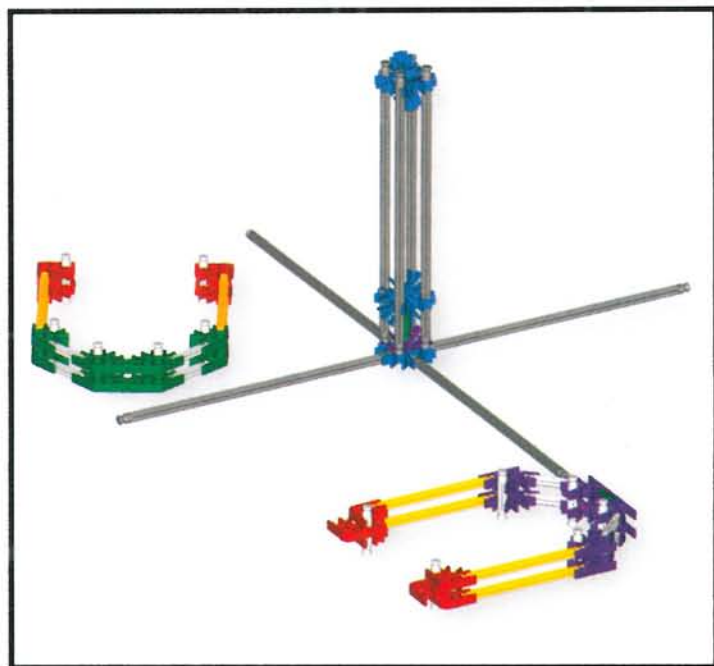
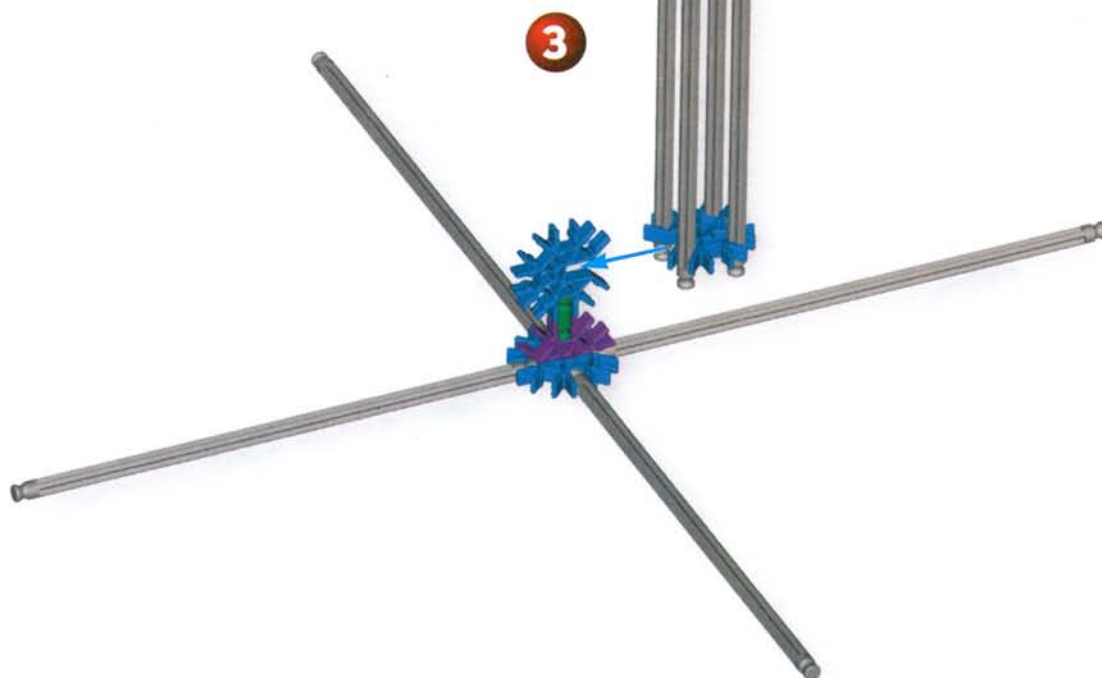
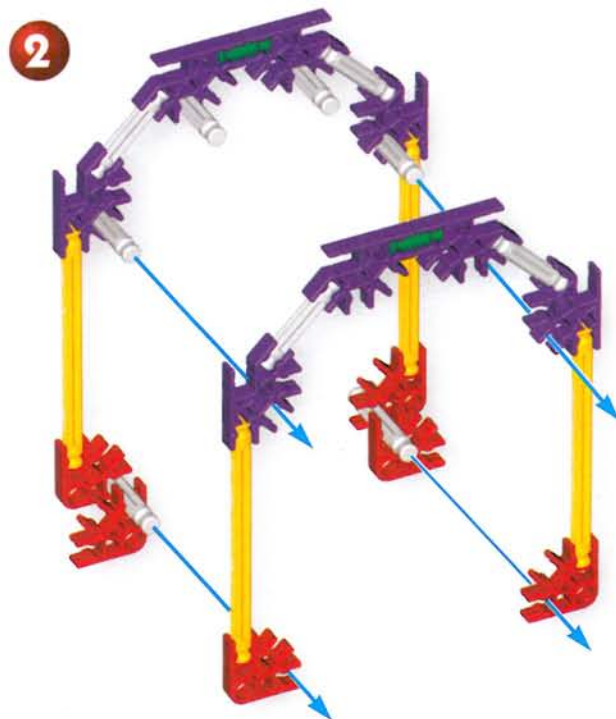
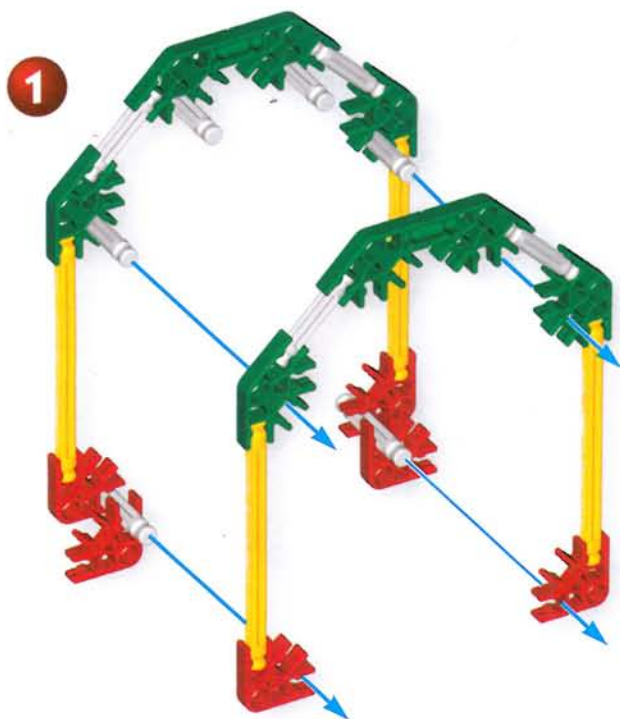

# Sprint Car 1

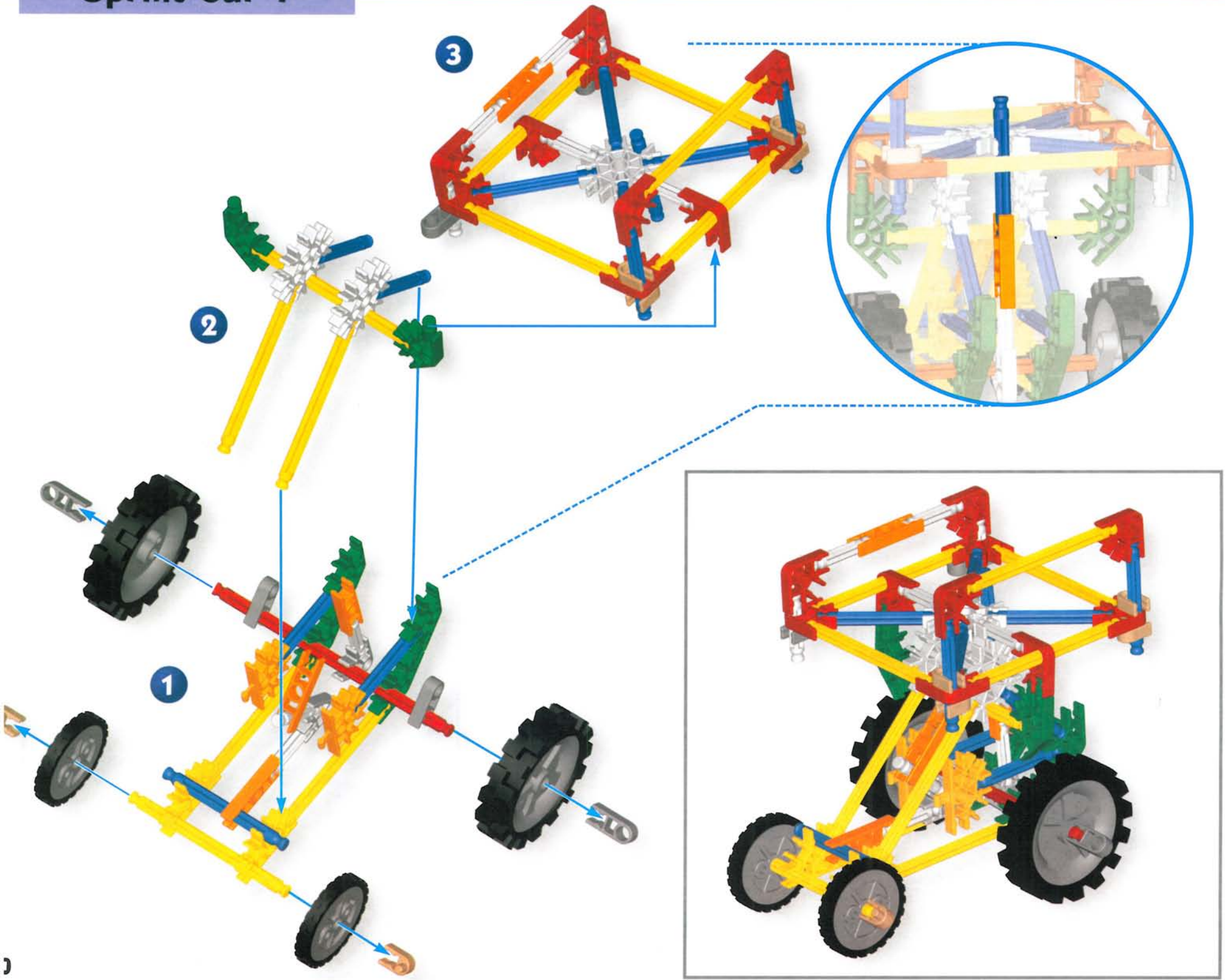

# Sprint Car 2

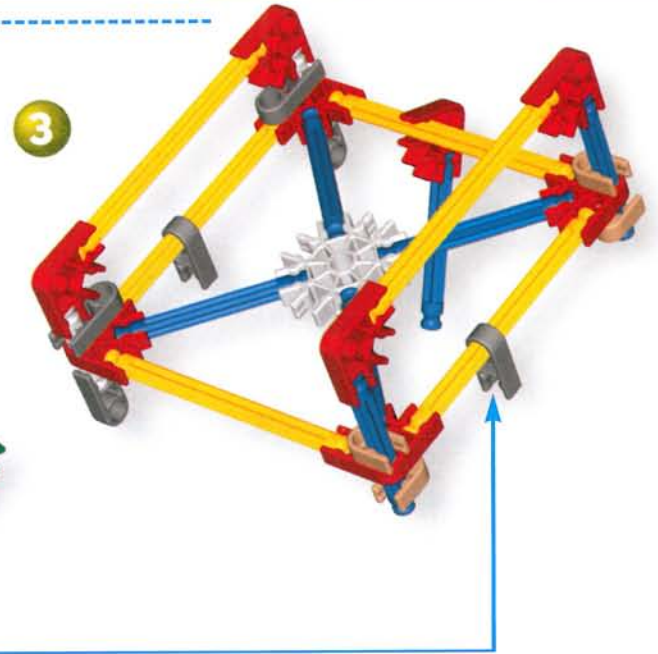
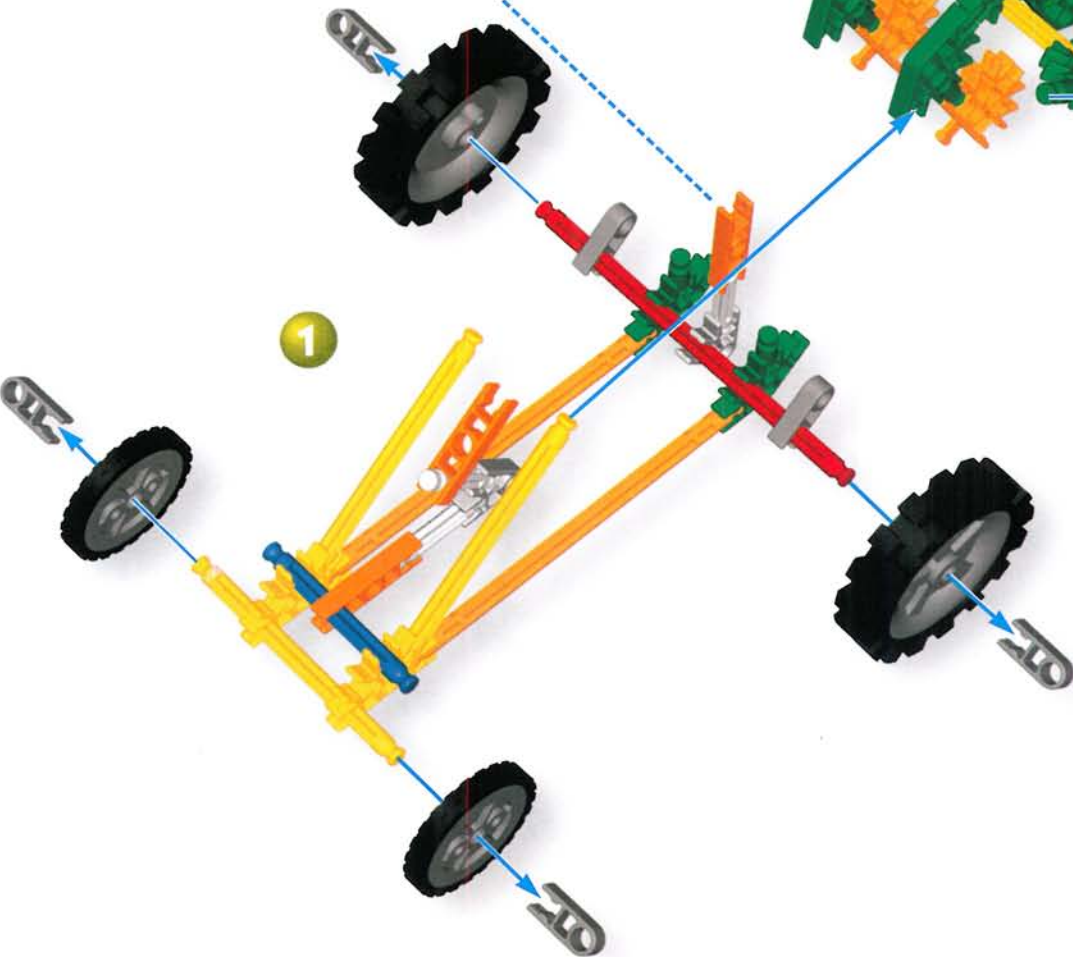
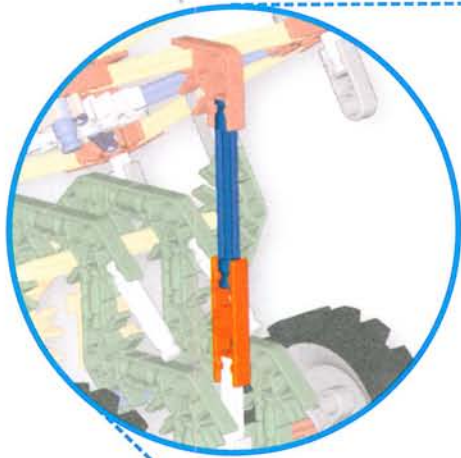

# Sailboat

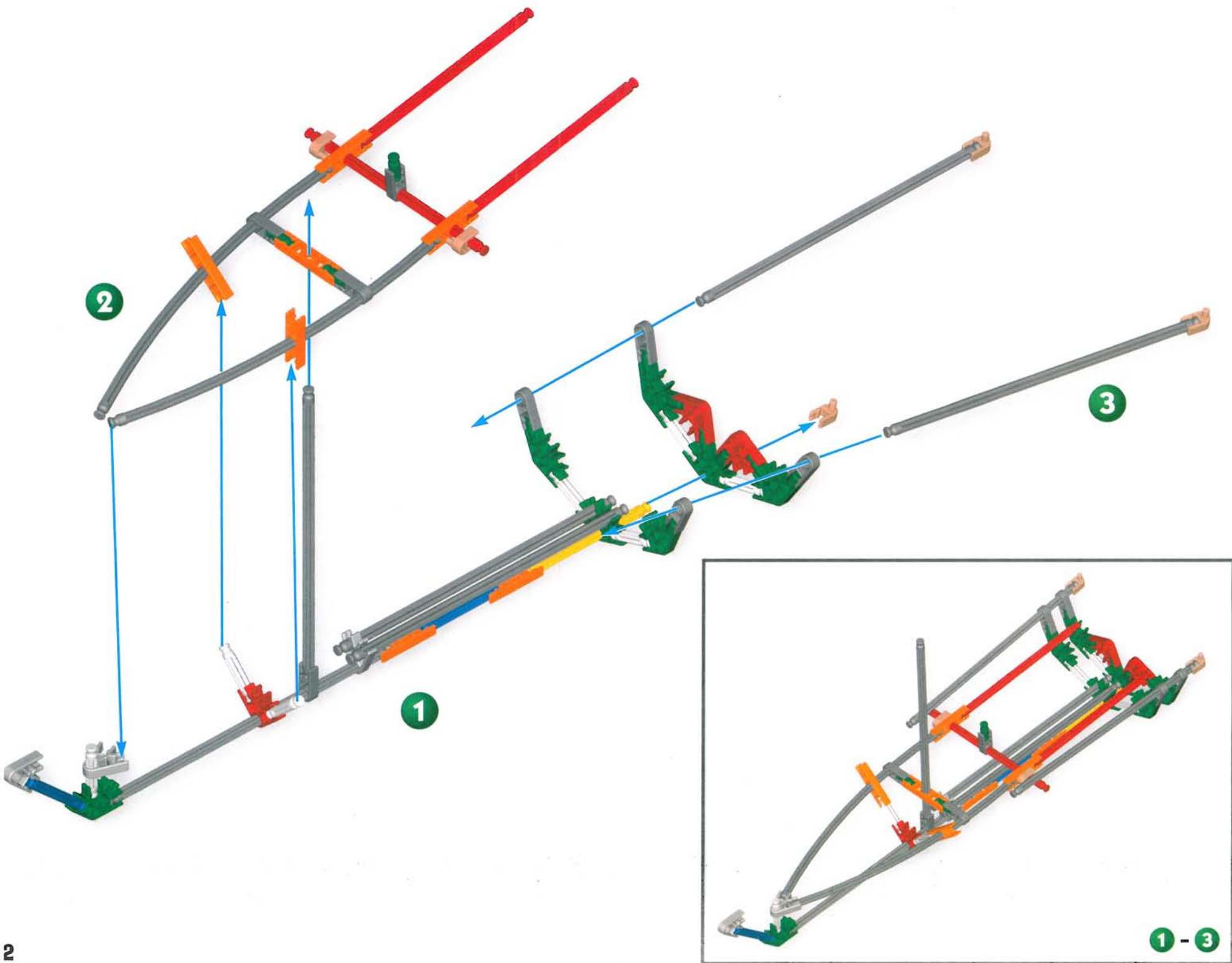

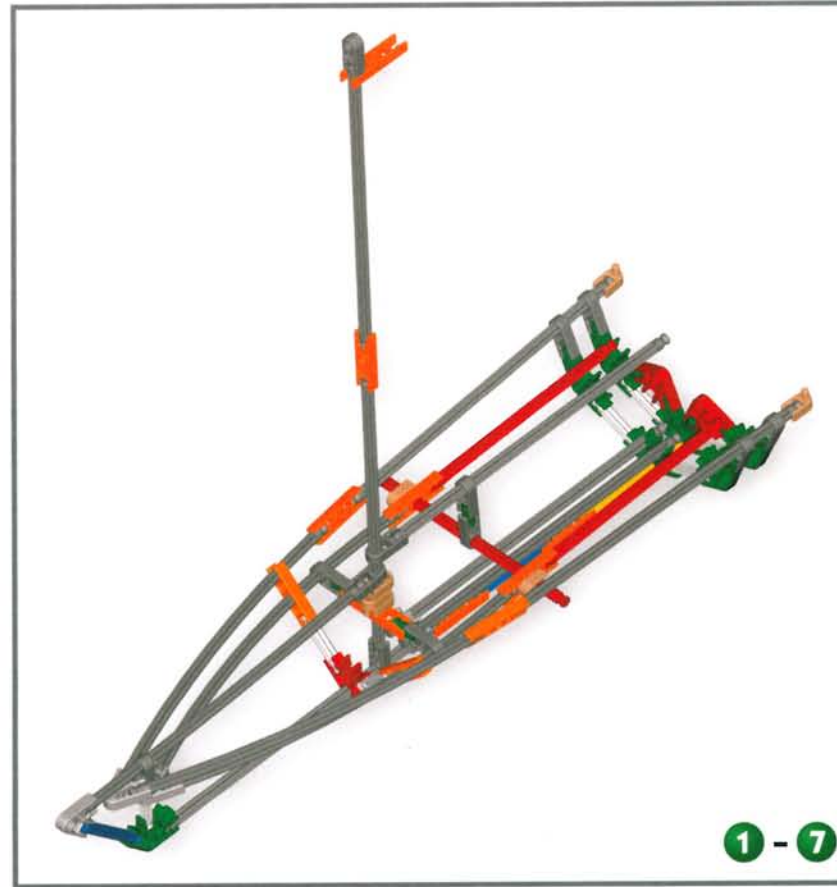
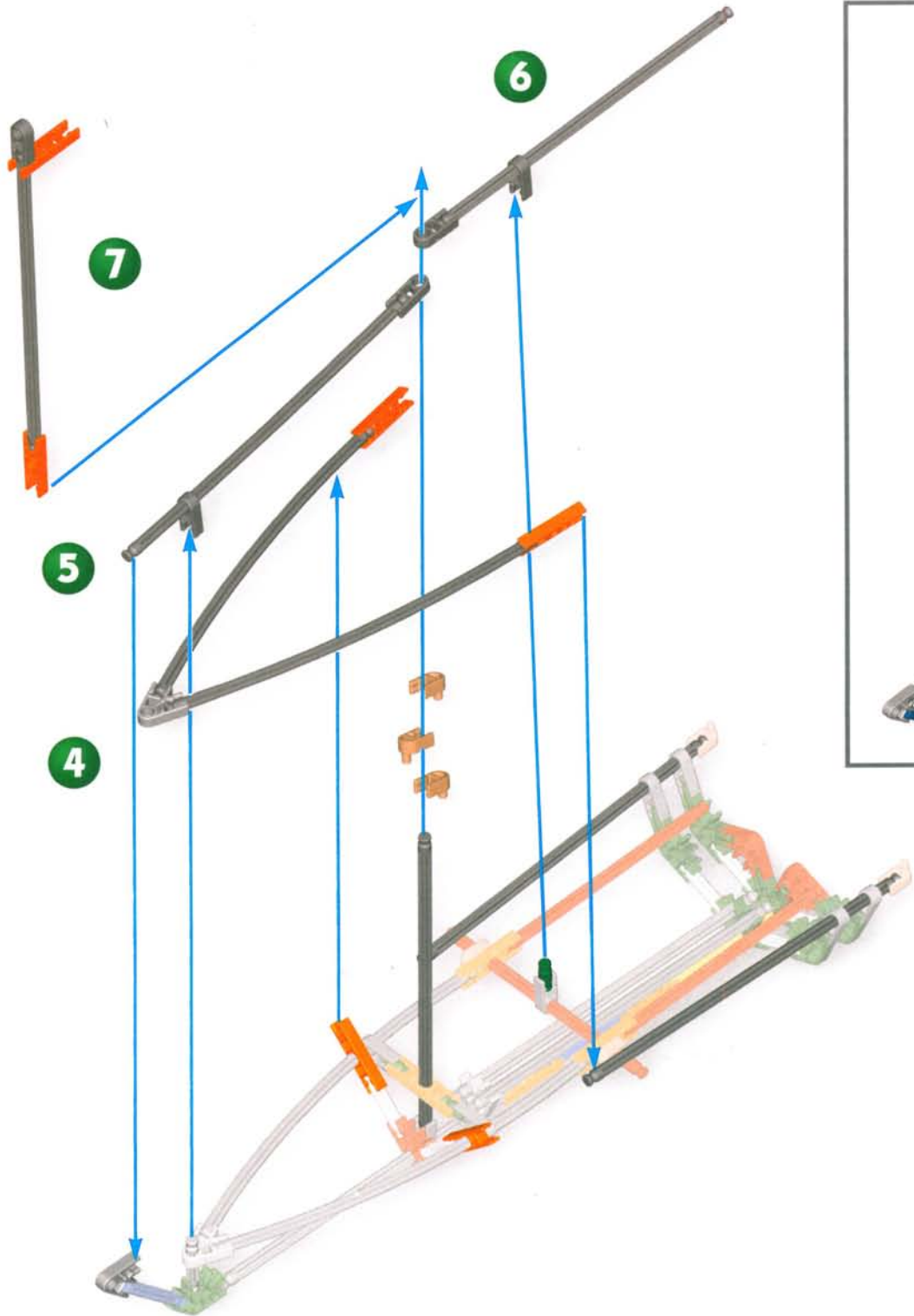

# Airplane and Tower

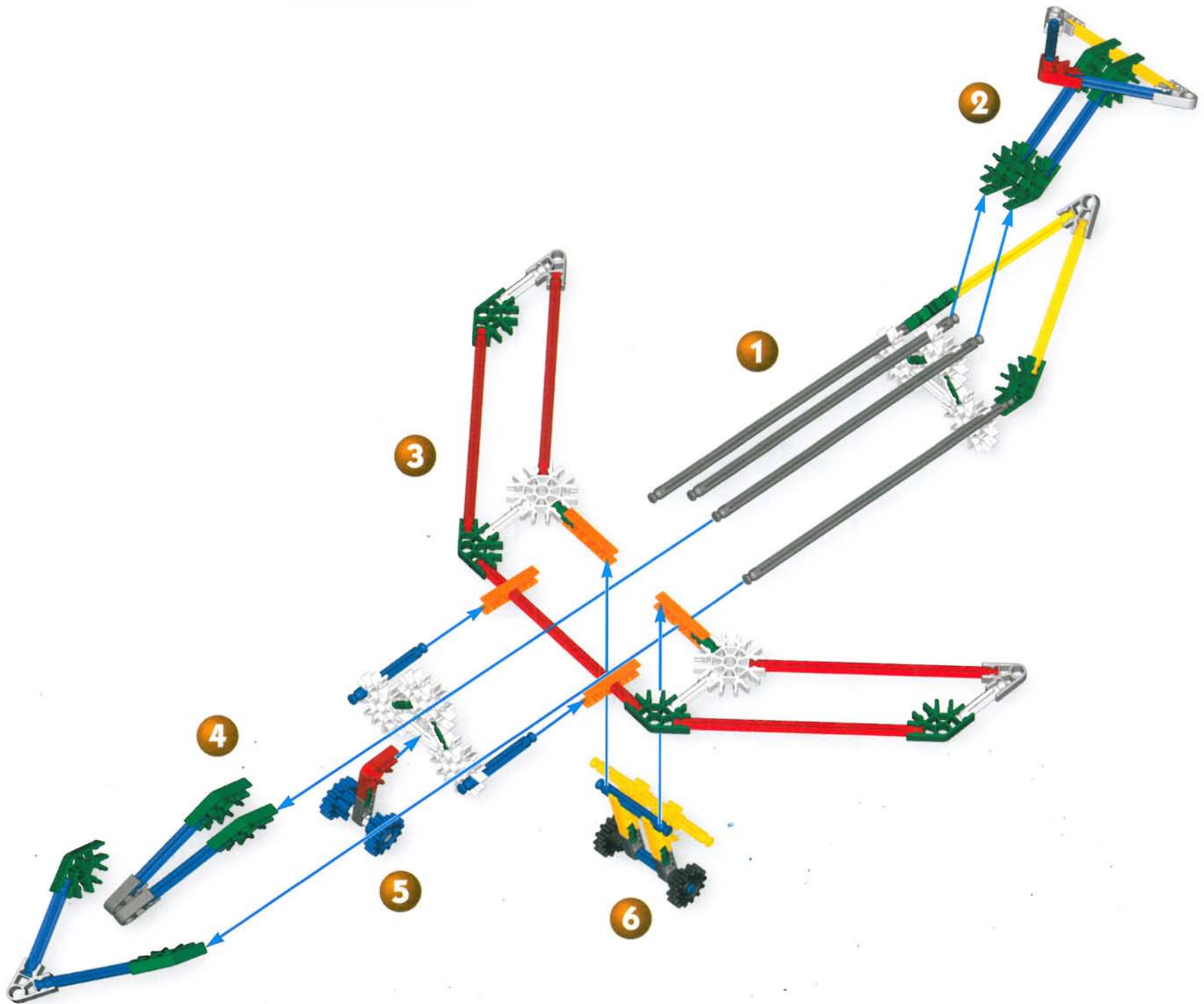

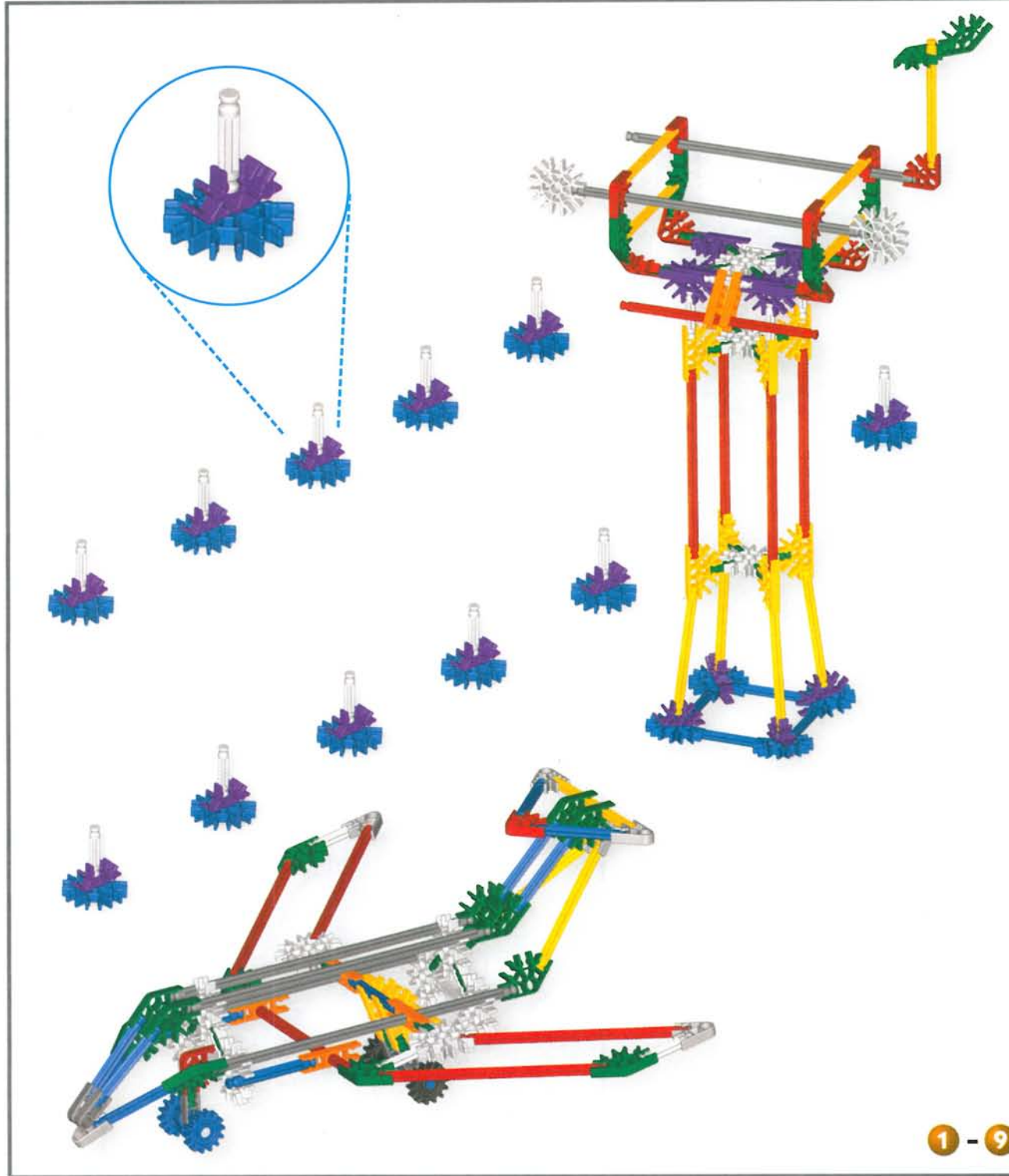
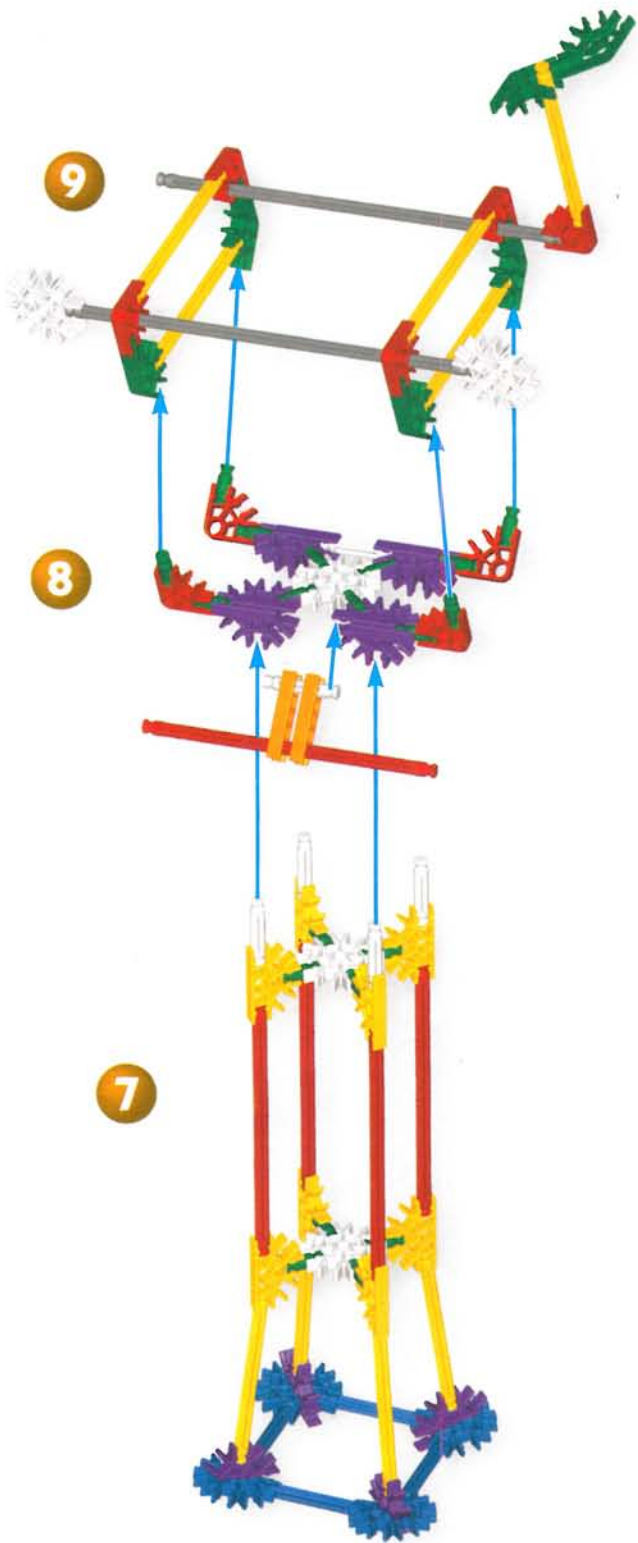

# Birdhouse

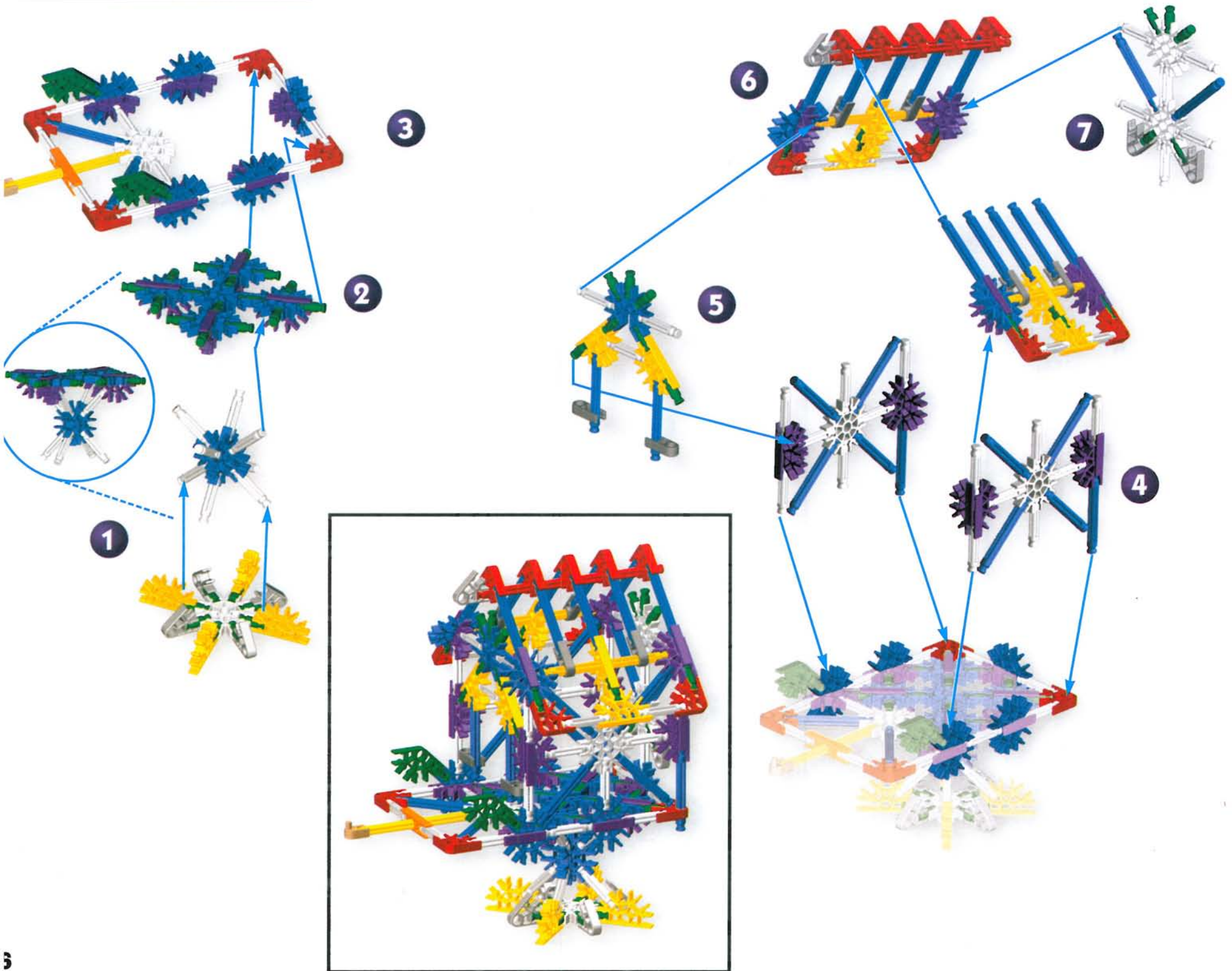

# The Conductor

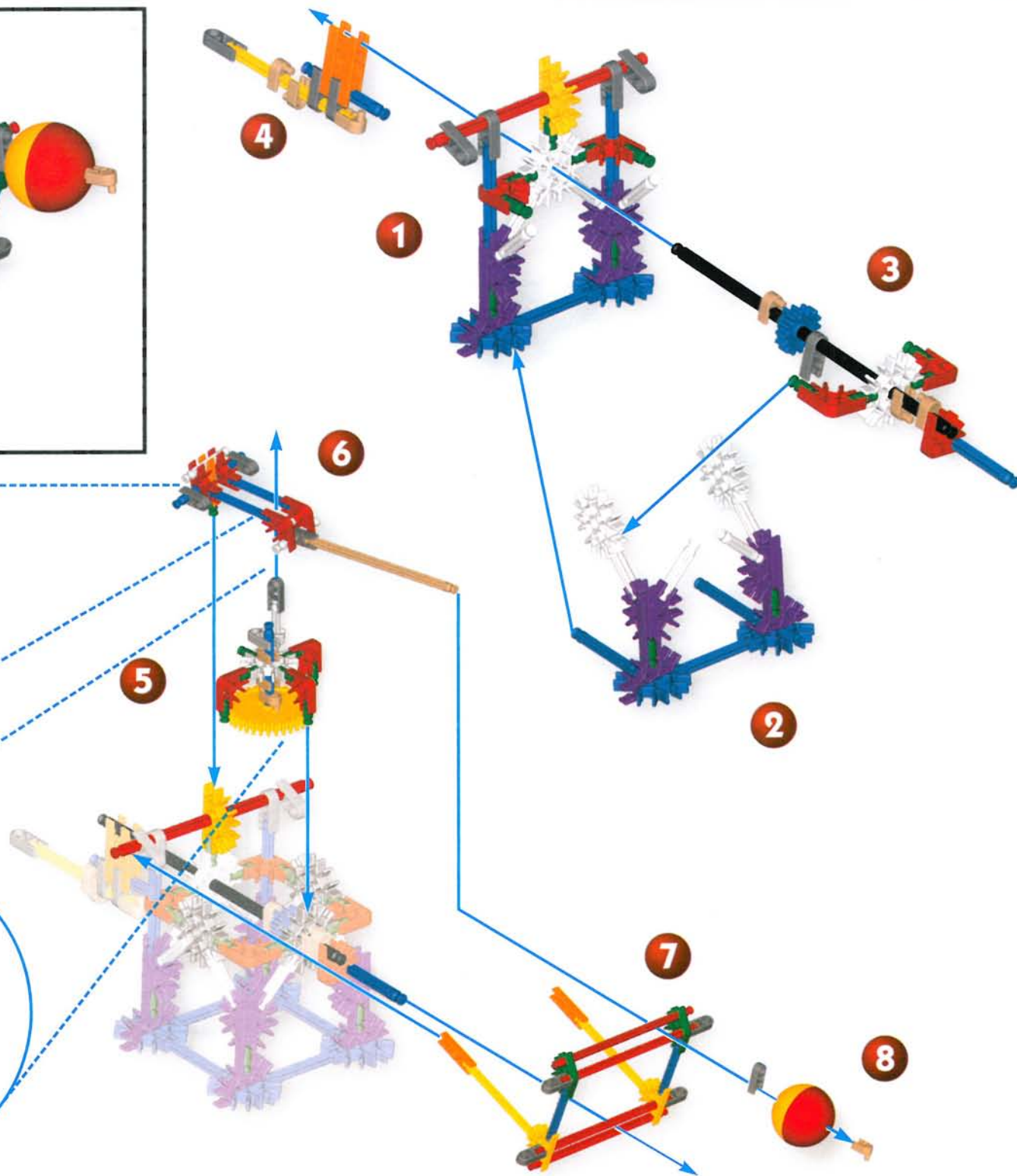
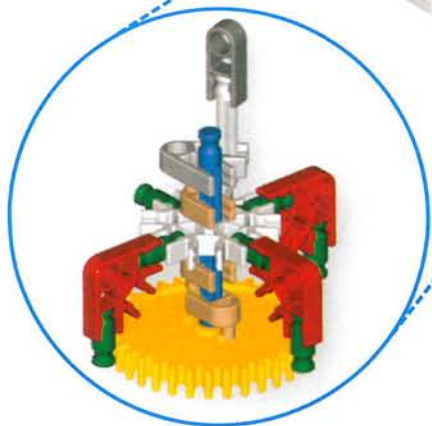
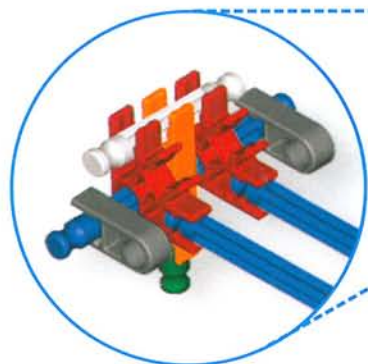
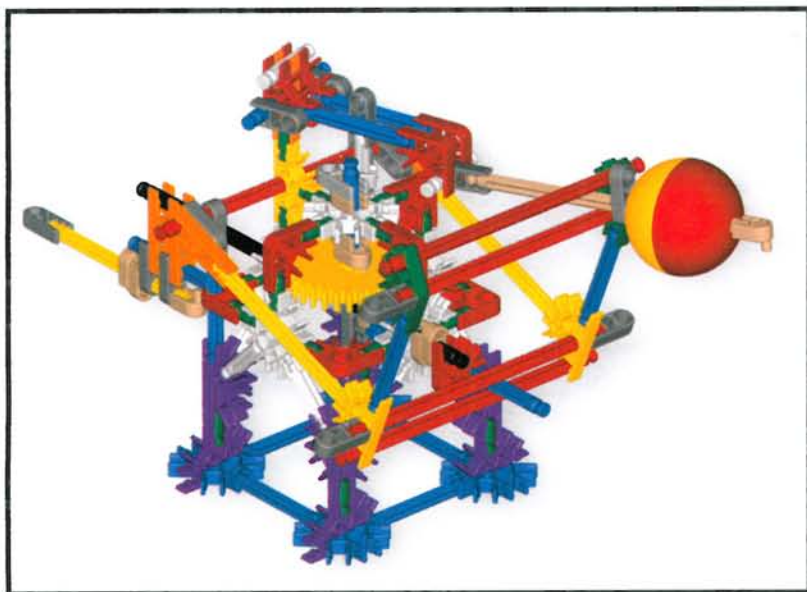

# Rocket and Mobile Launch Pad

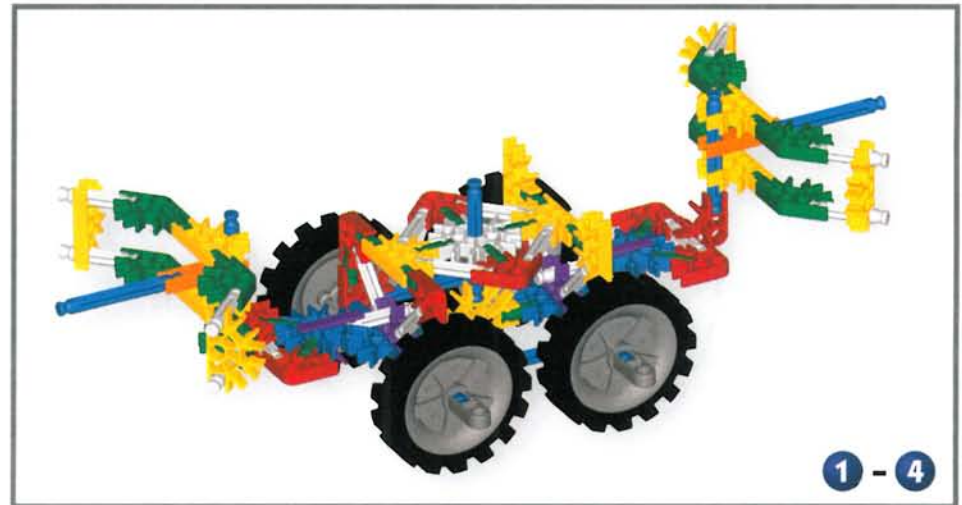
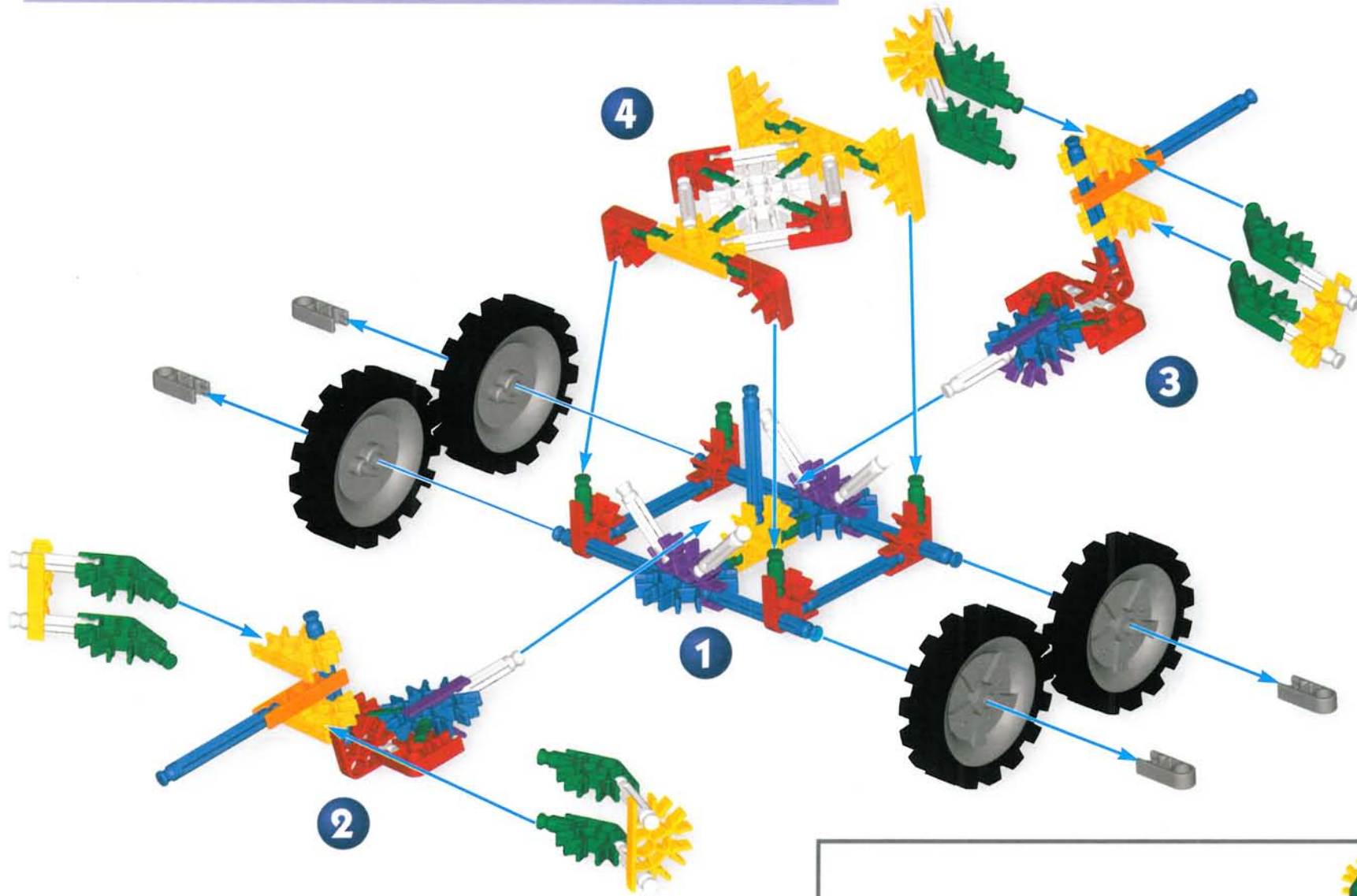

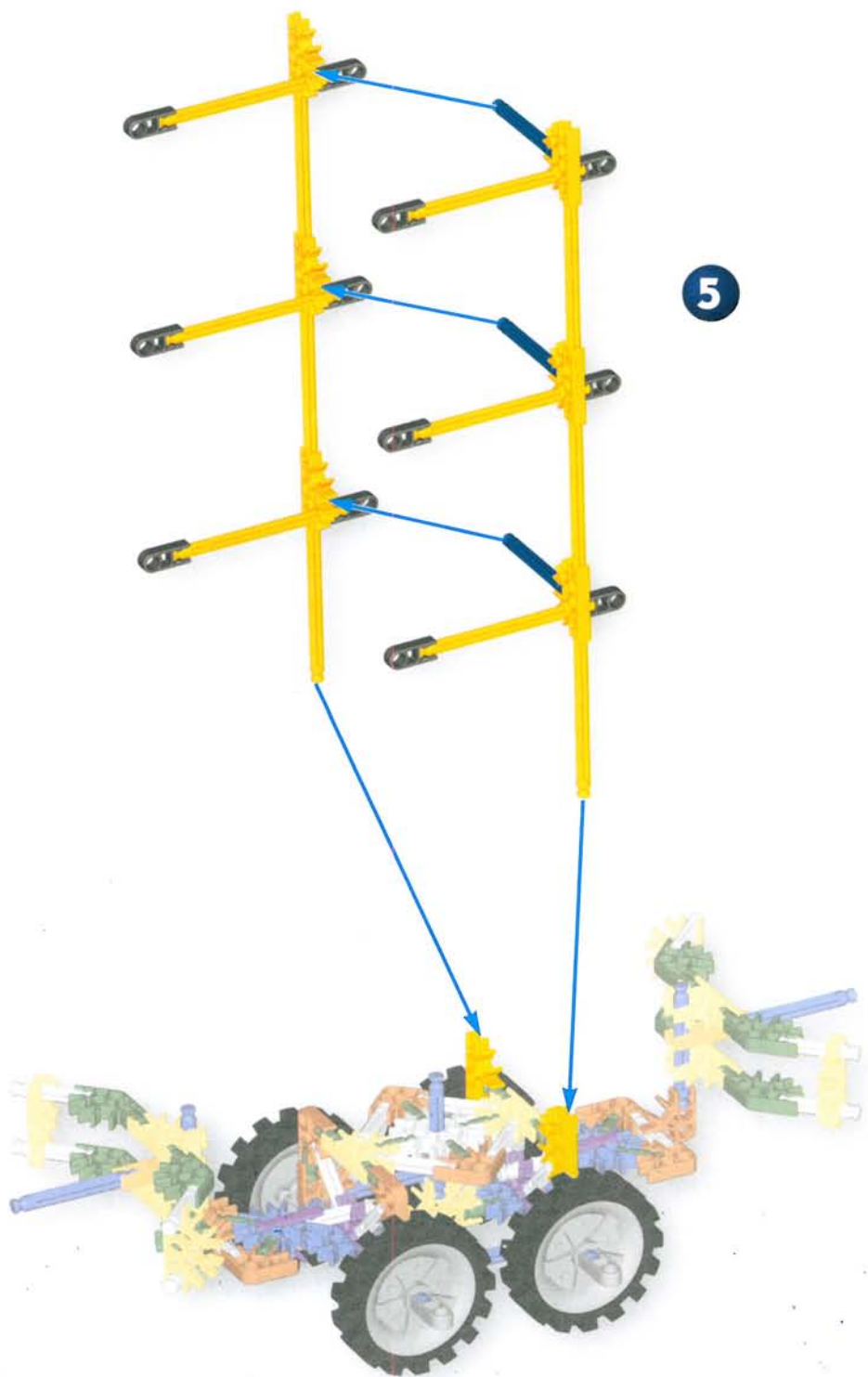

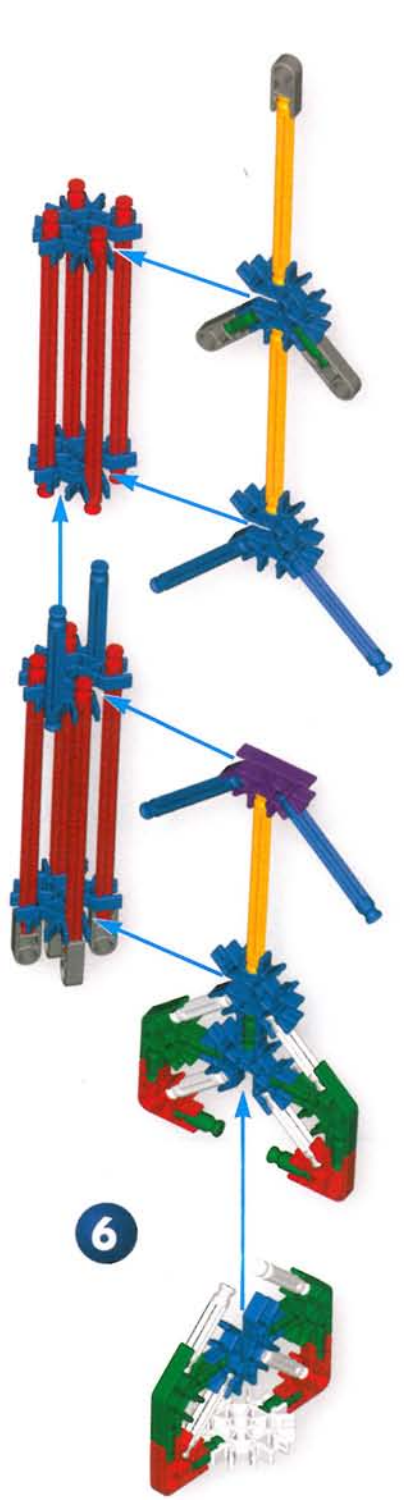

6

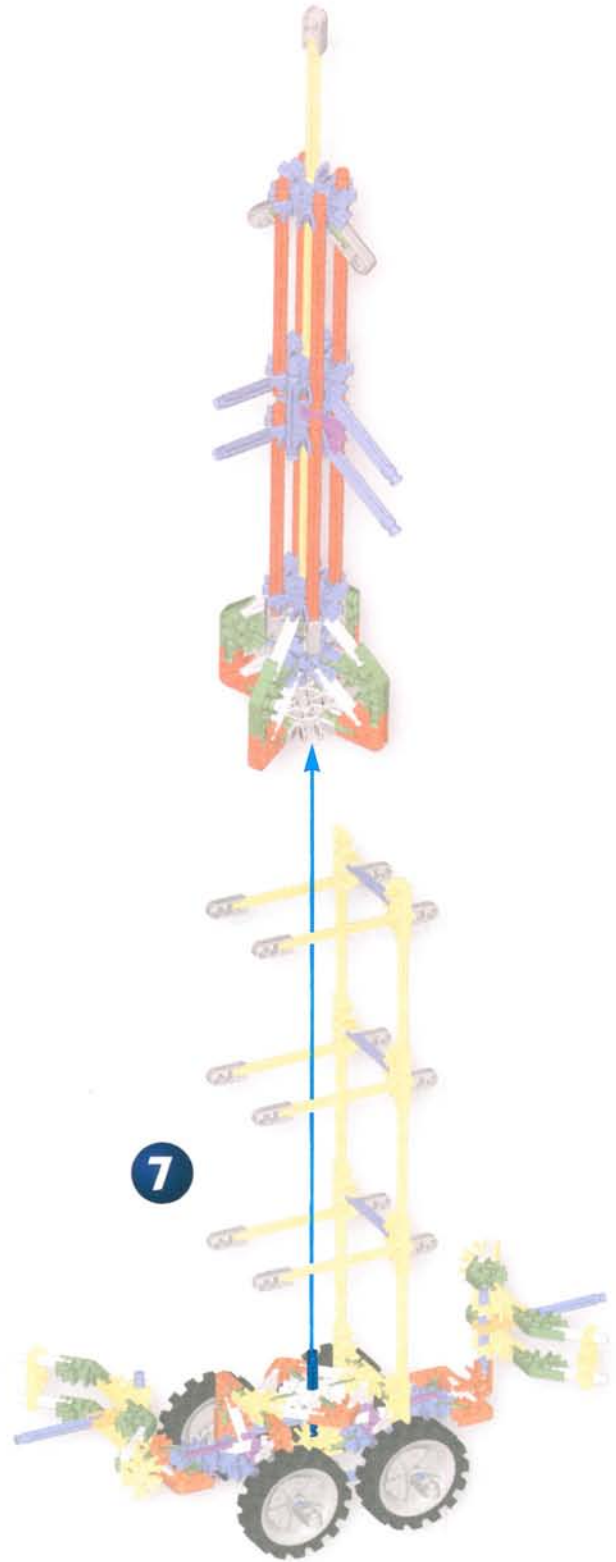

7



1 - 7

# Tilter

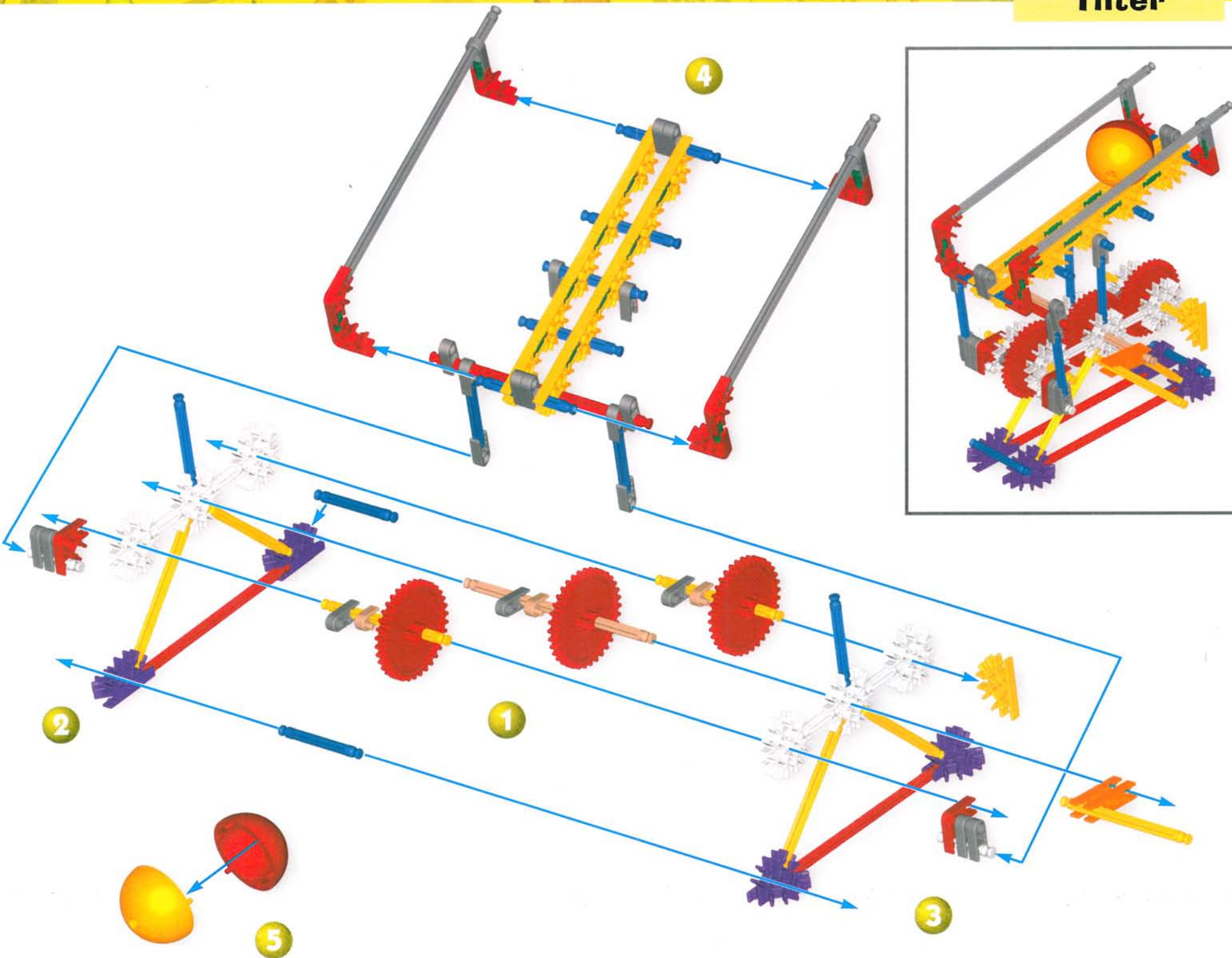

# Motorcycle and Sidecar

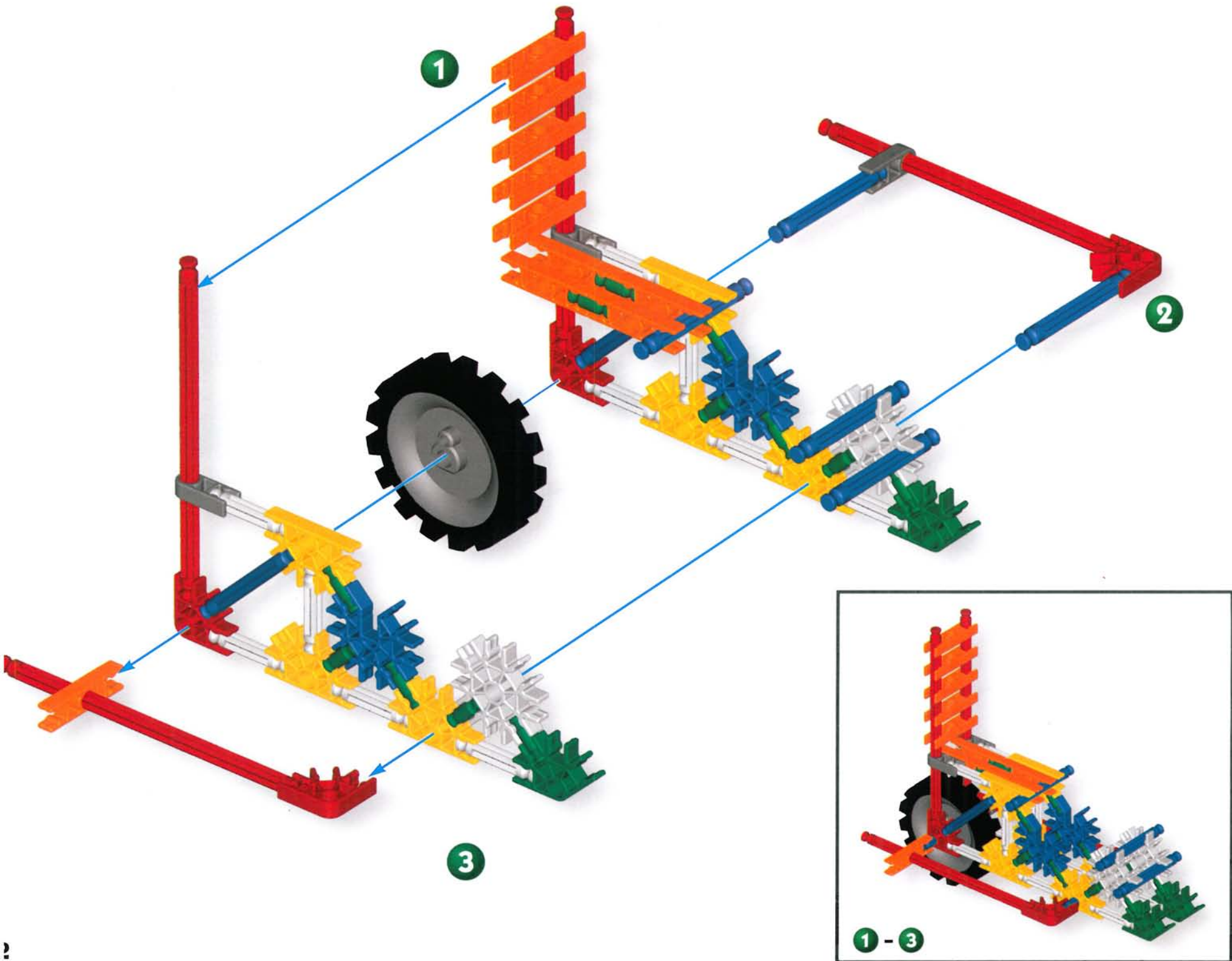

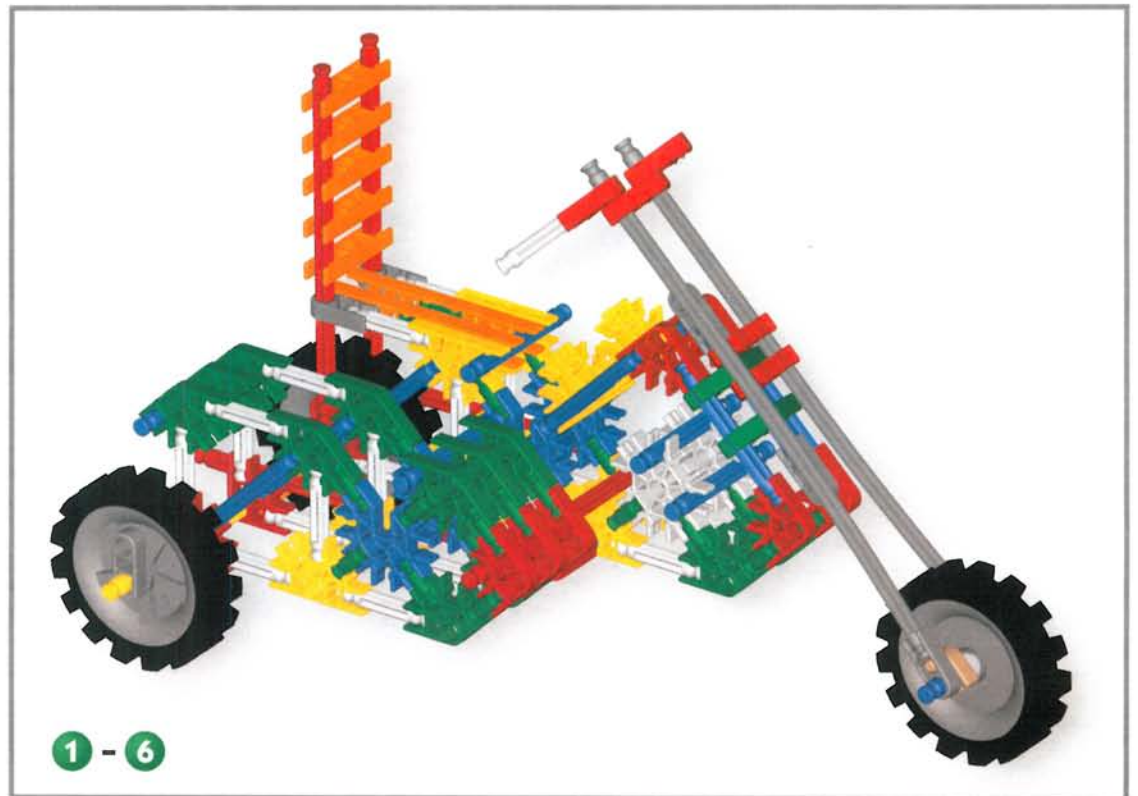
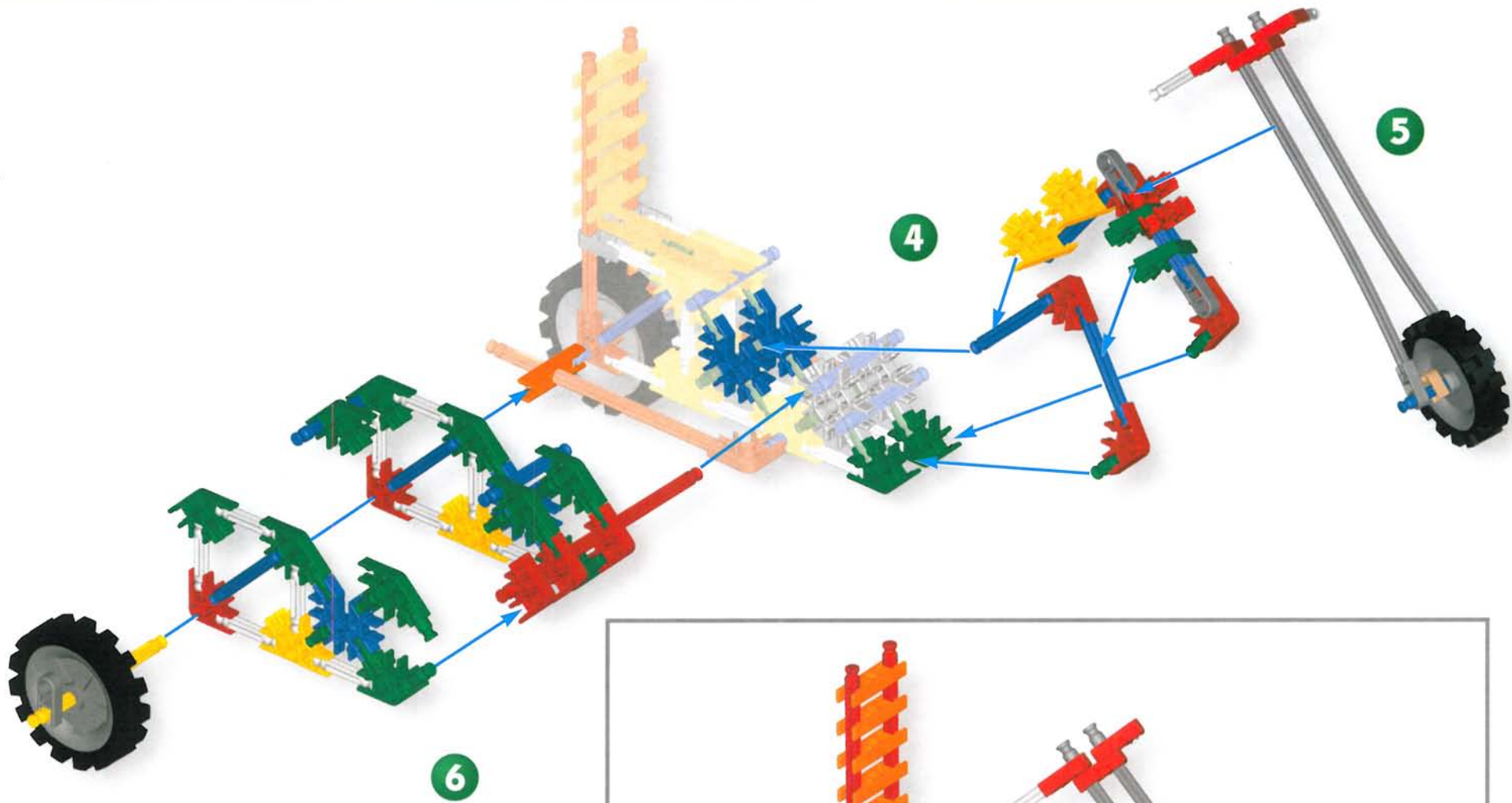

# Pliers

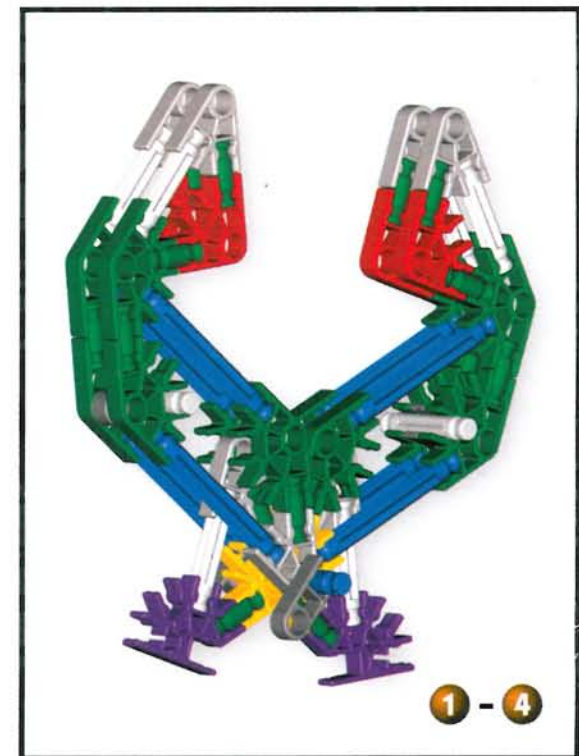
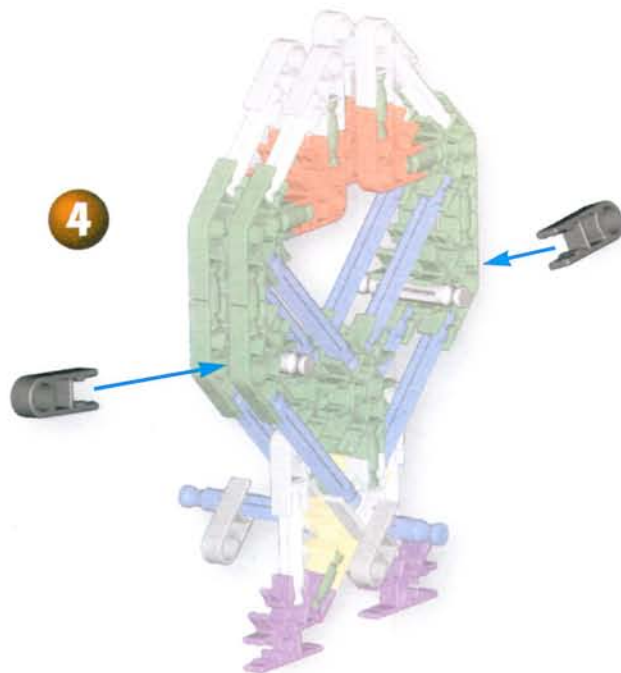
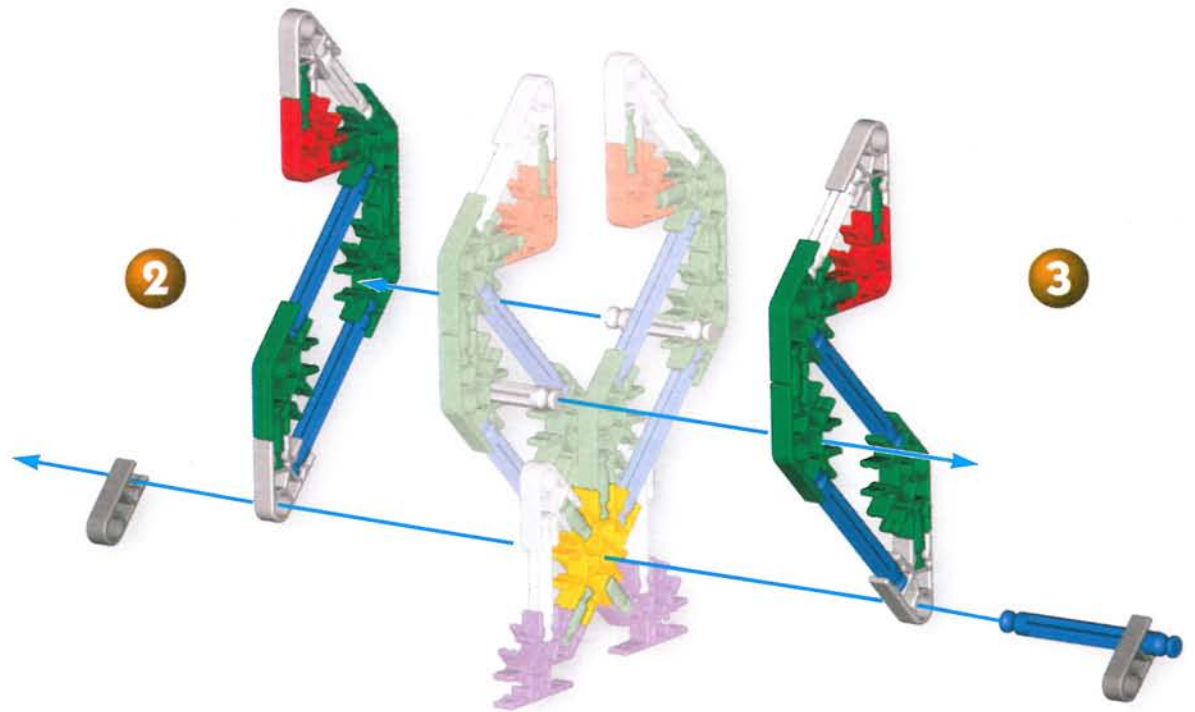
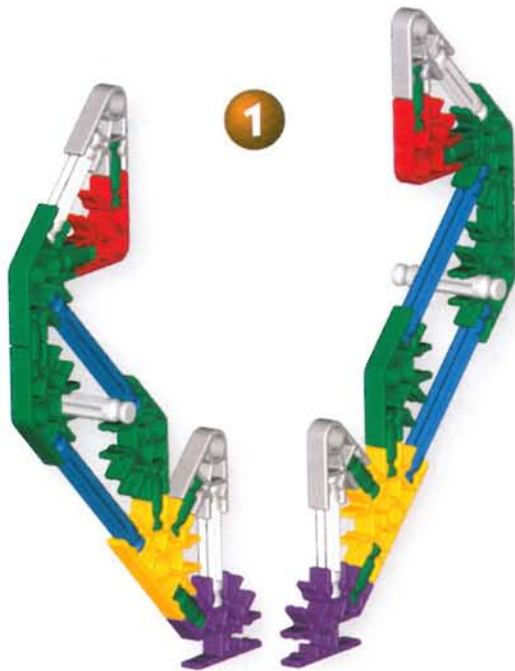

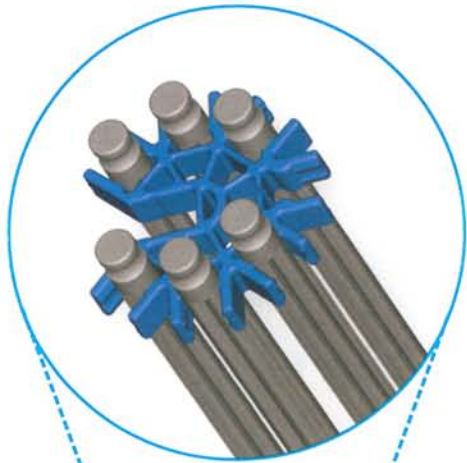

5

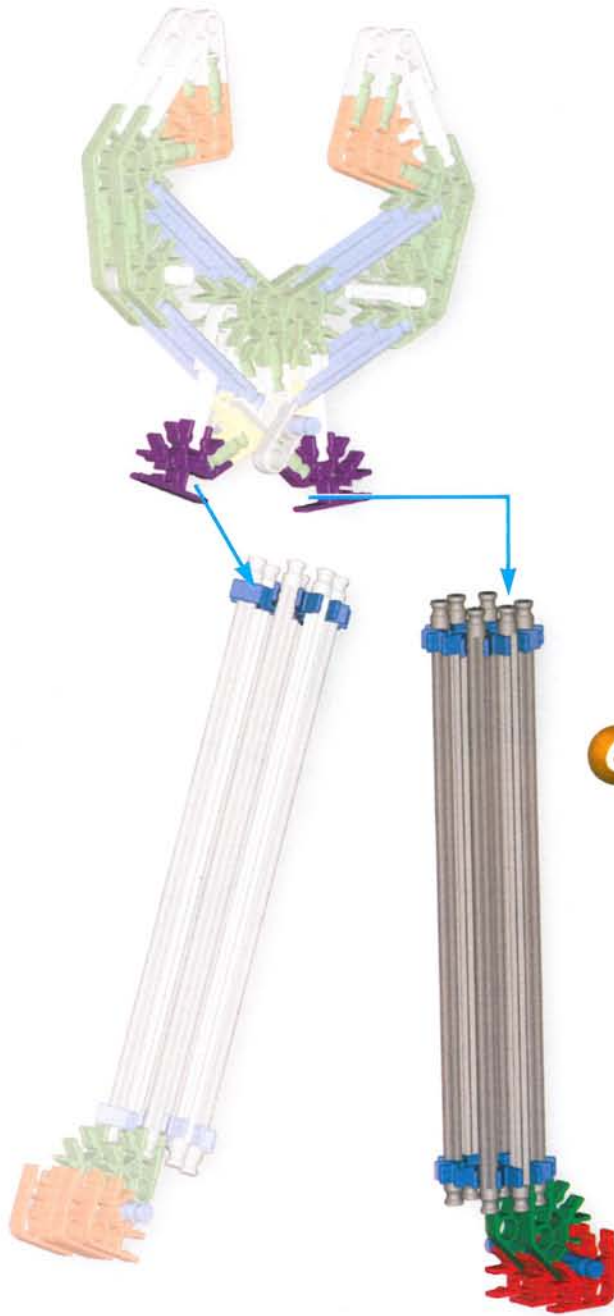

6

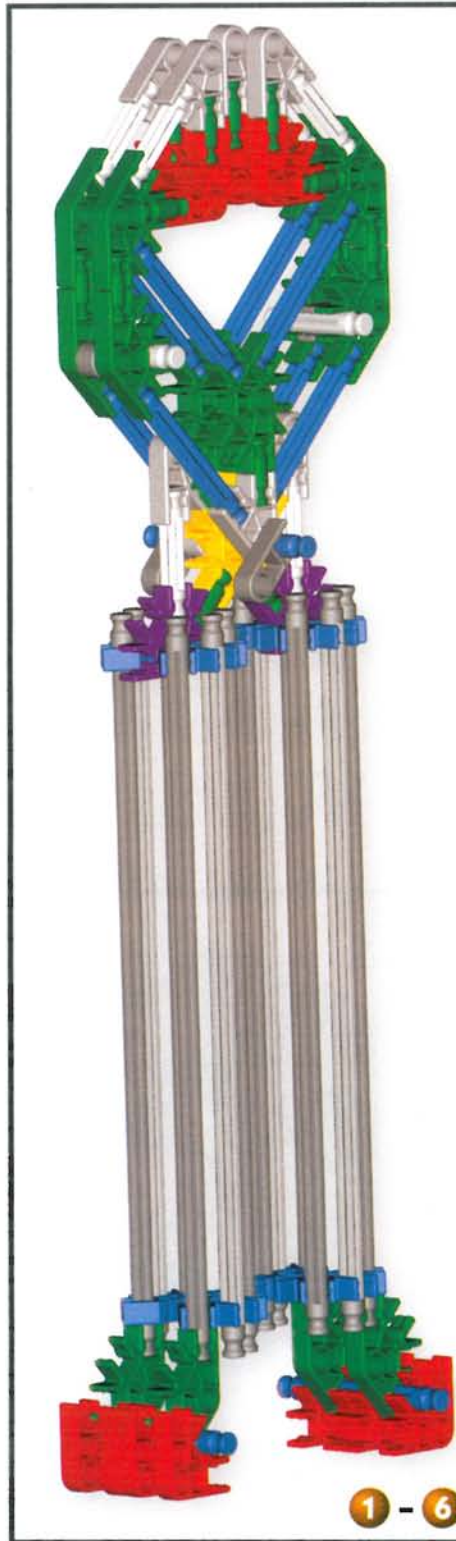

1 - 6

# Cake Mixer

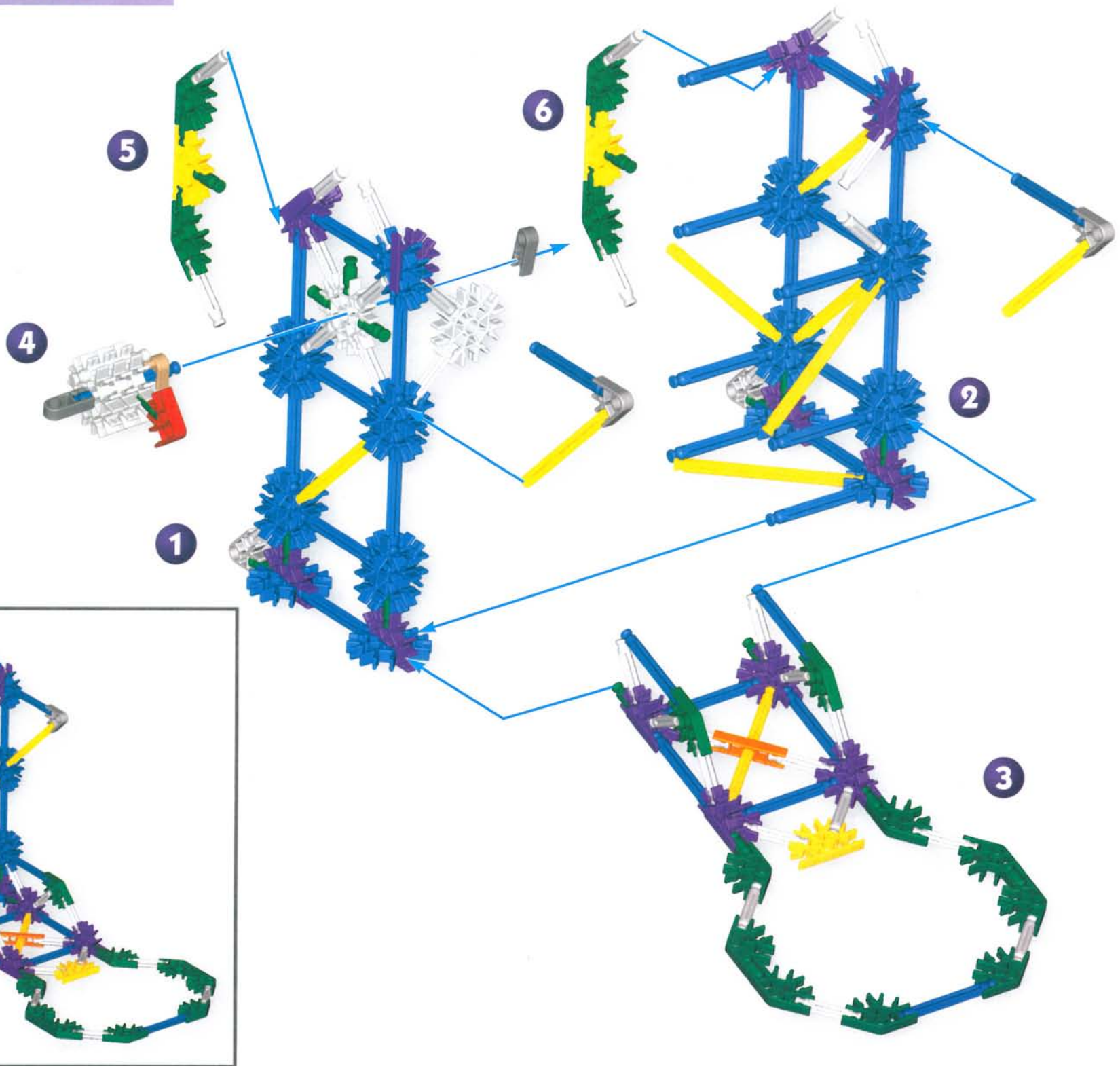

1 - 6

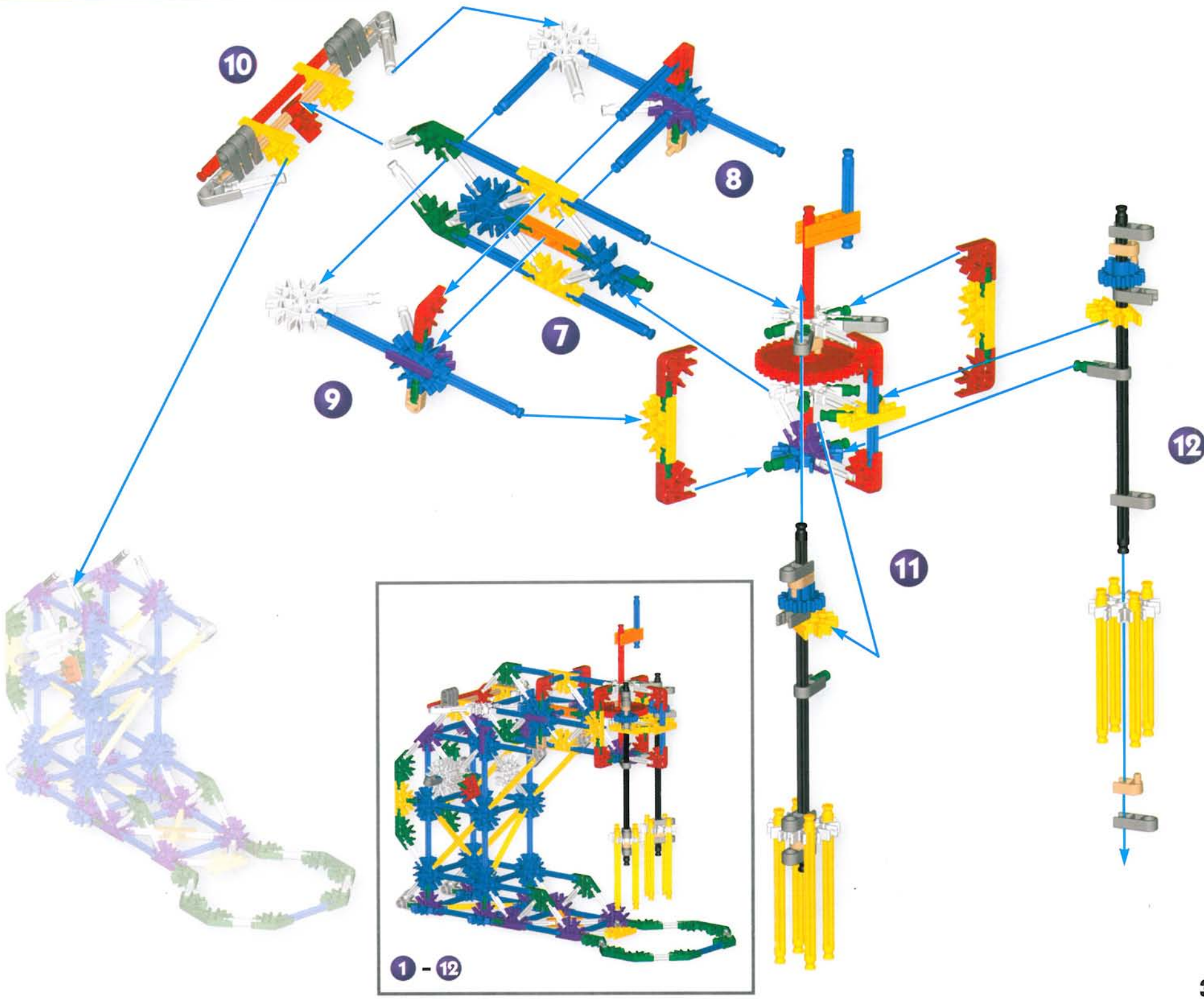

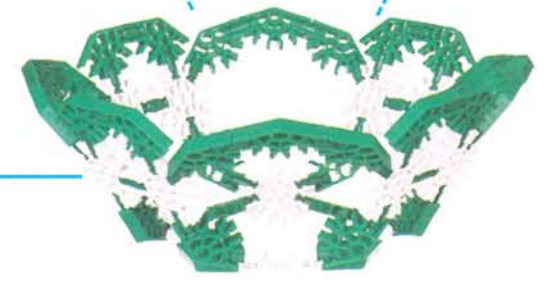
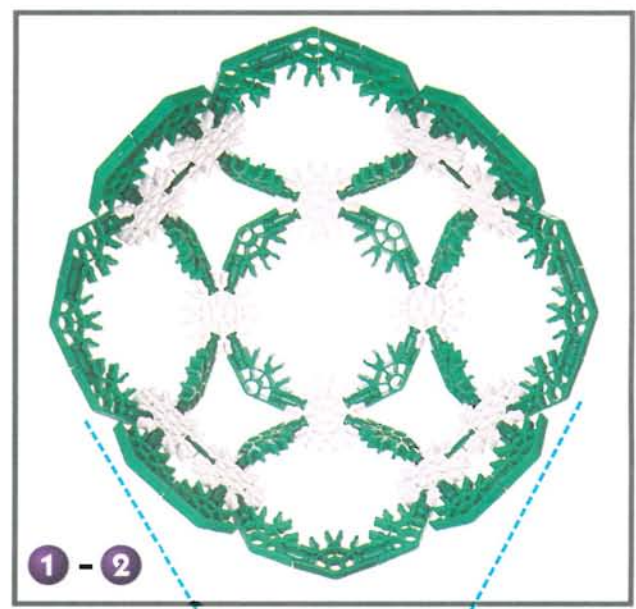
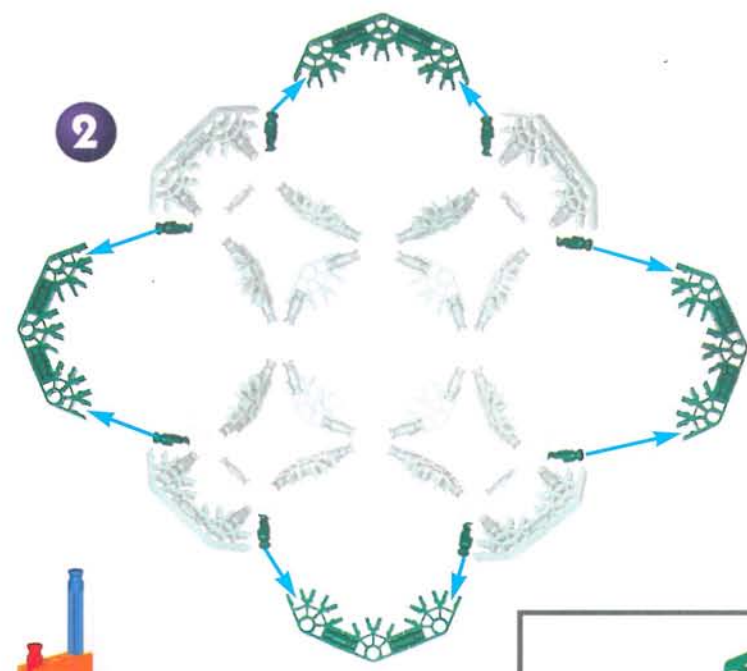
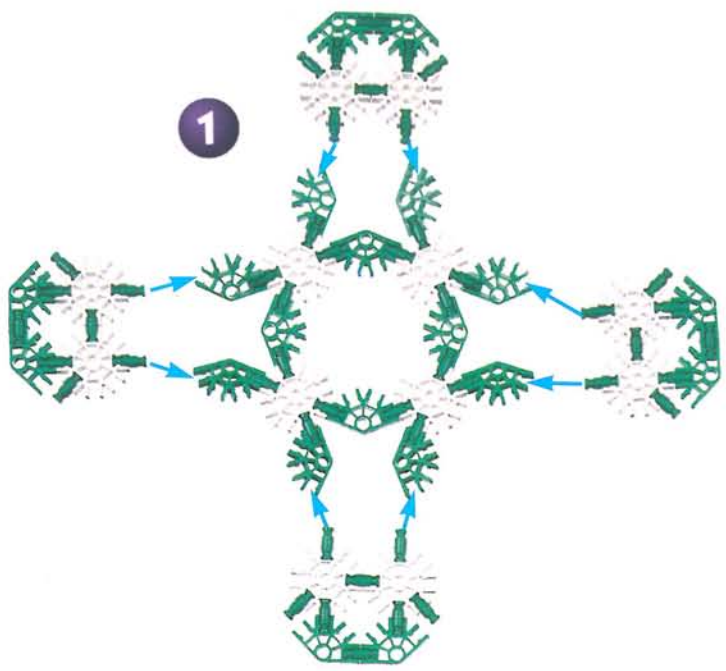

# Vehicle and Boat Trailer

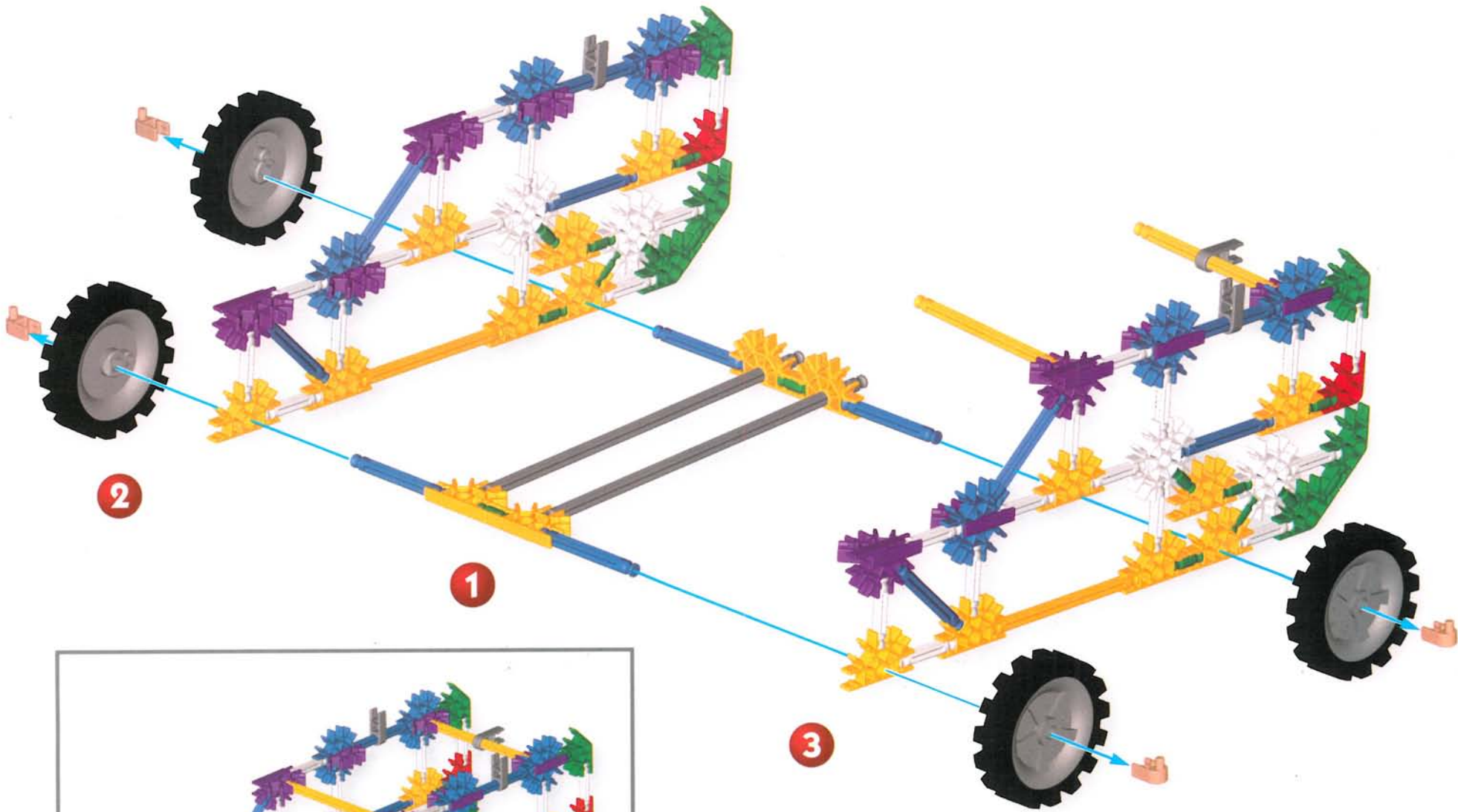

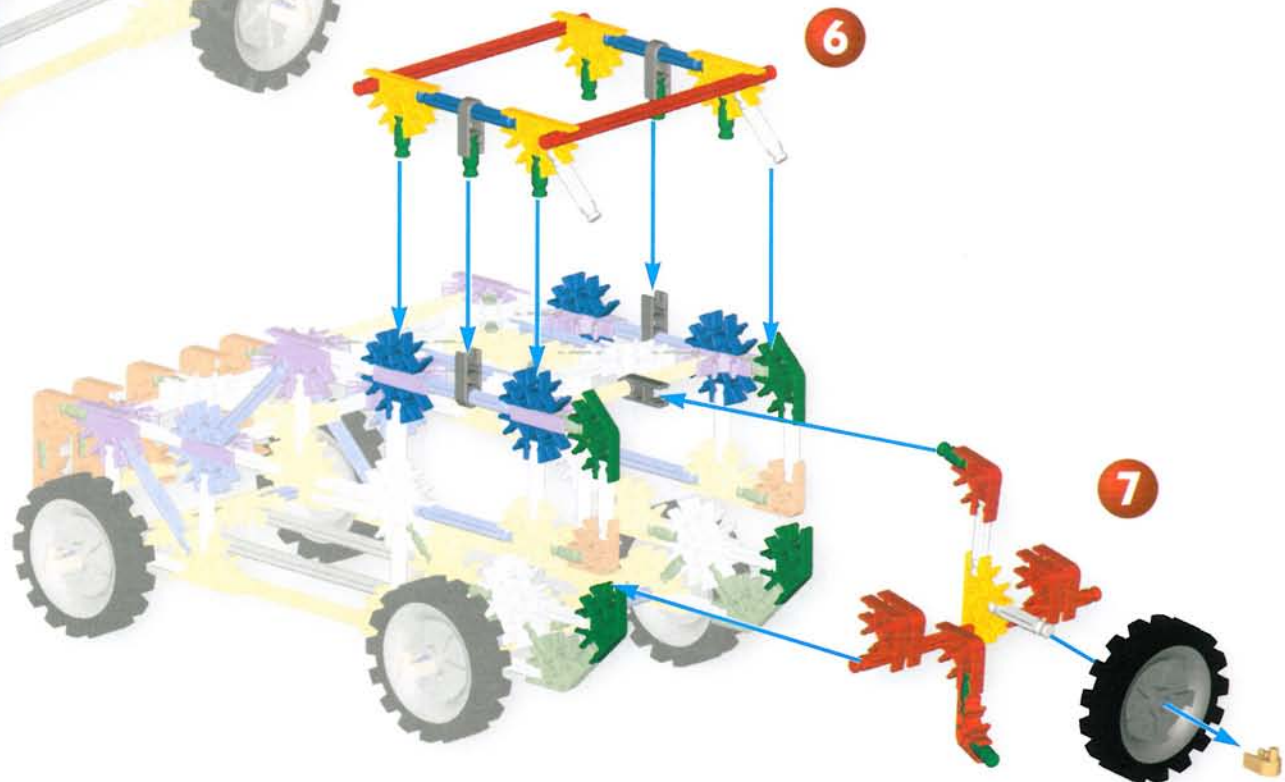
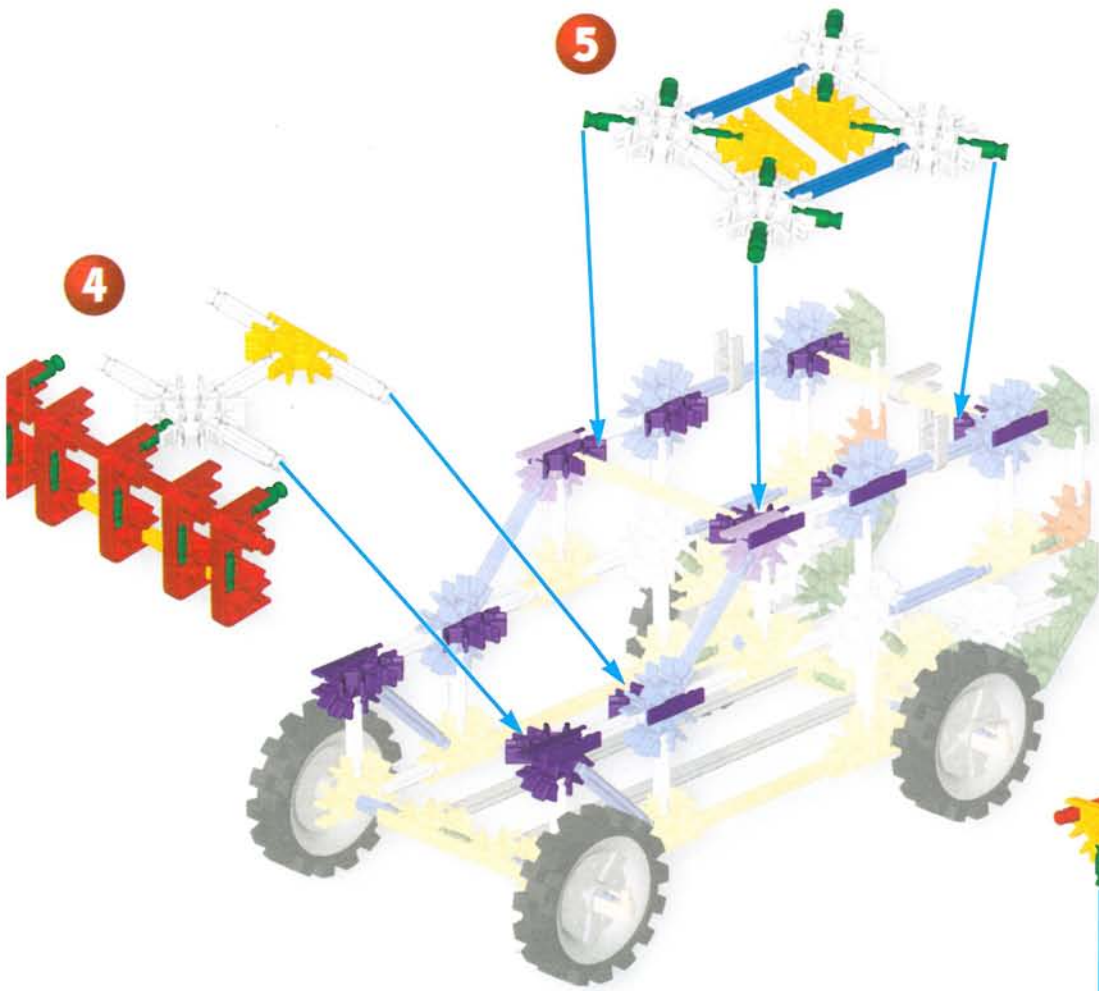

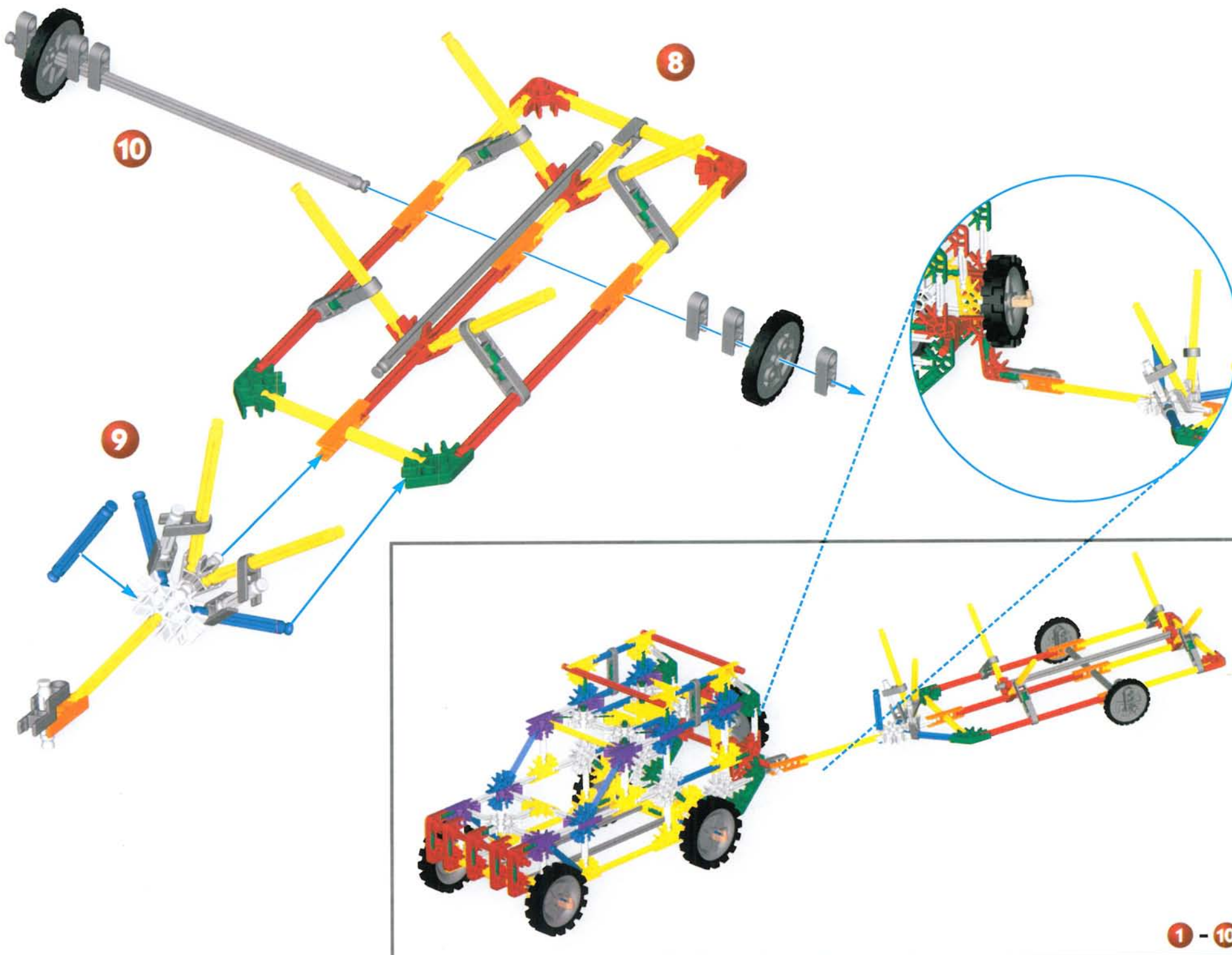

# Mighty MiniVan

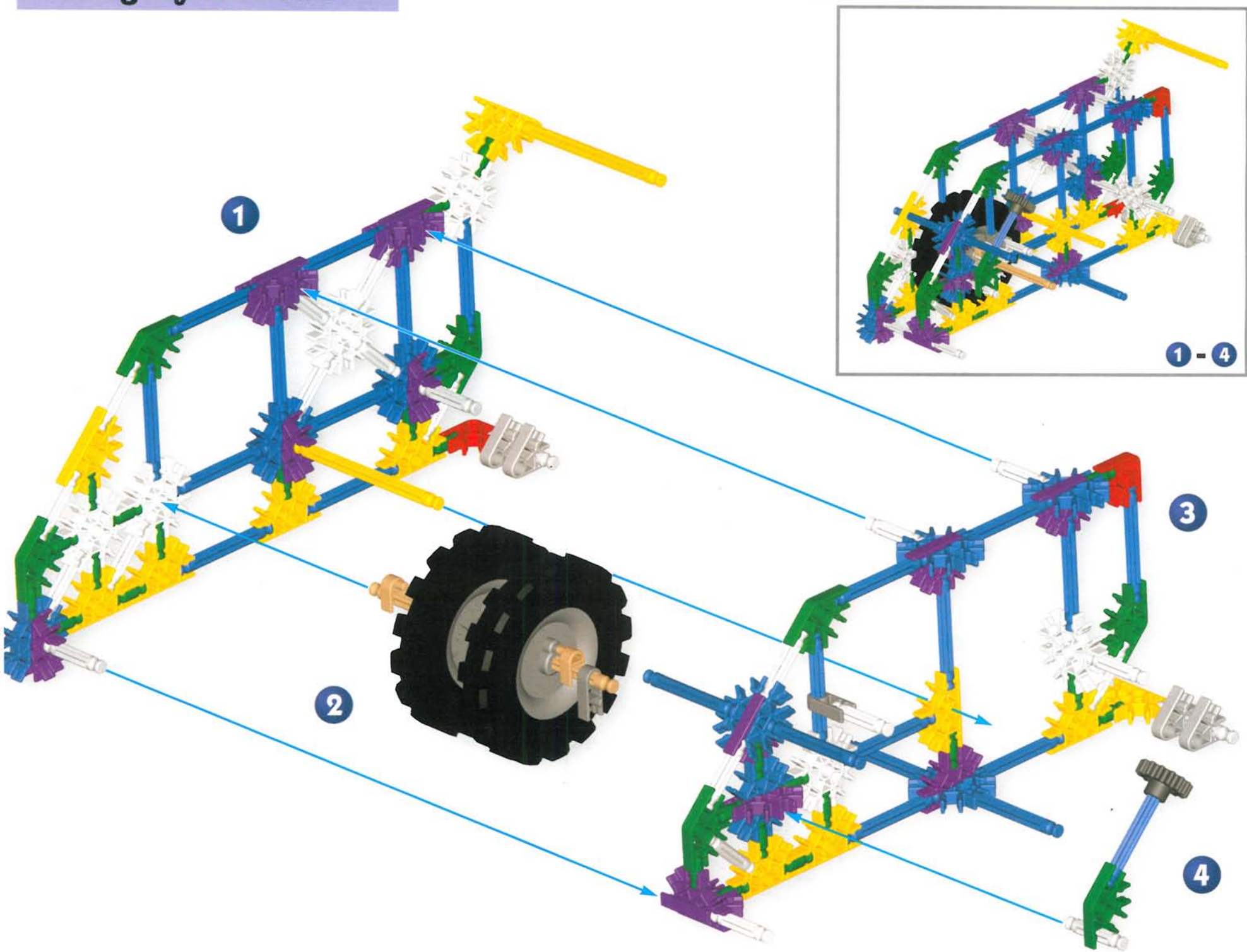

1

2

3

4

1 - 4

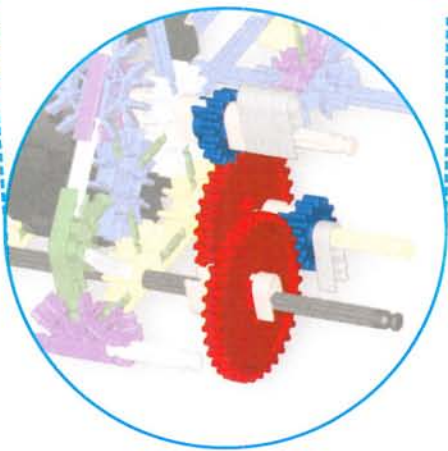
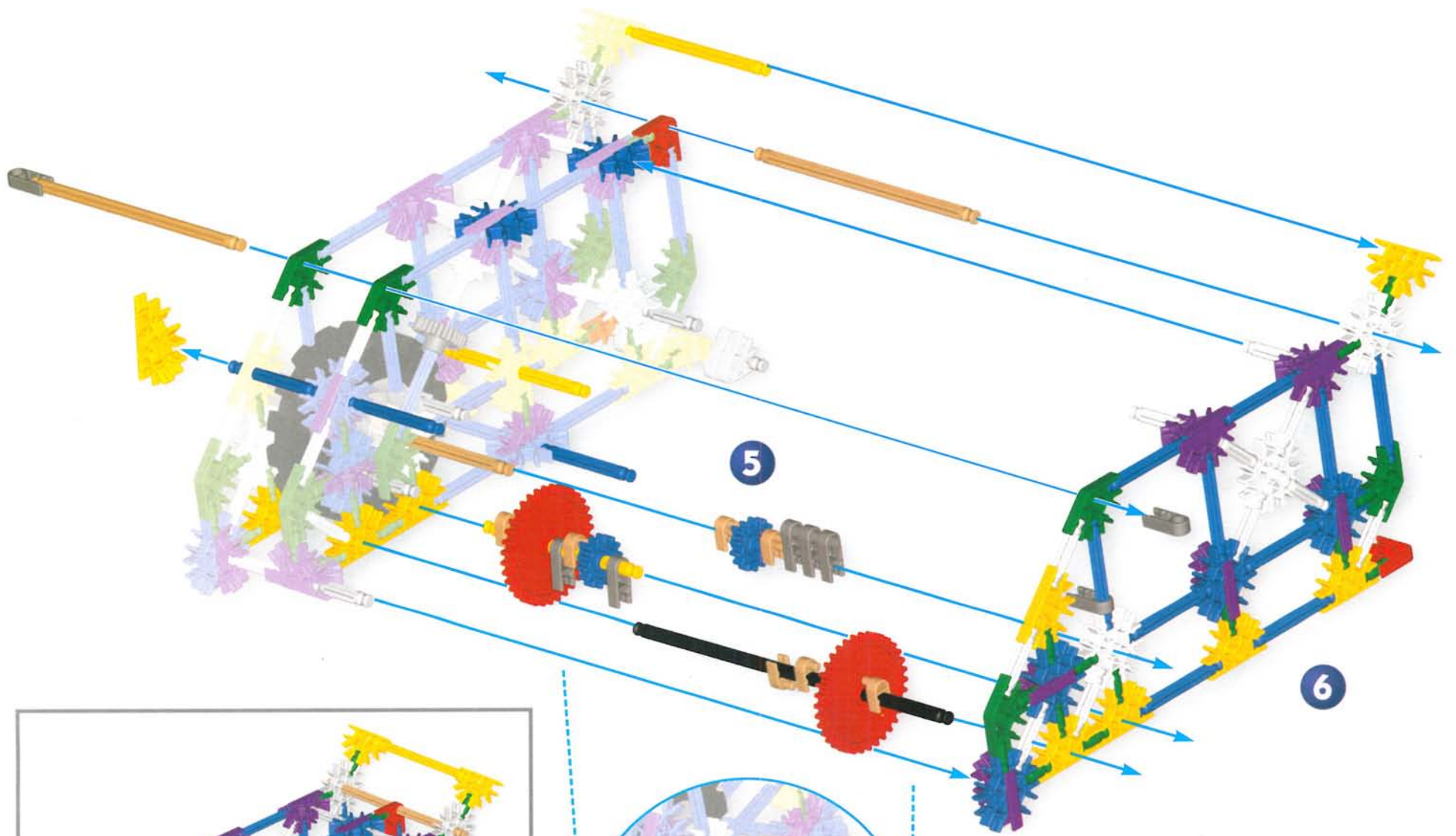

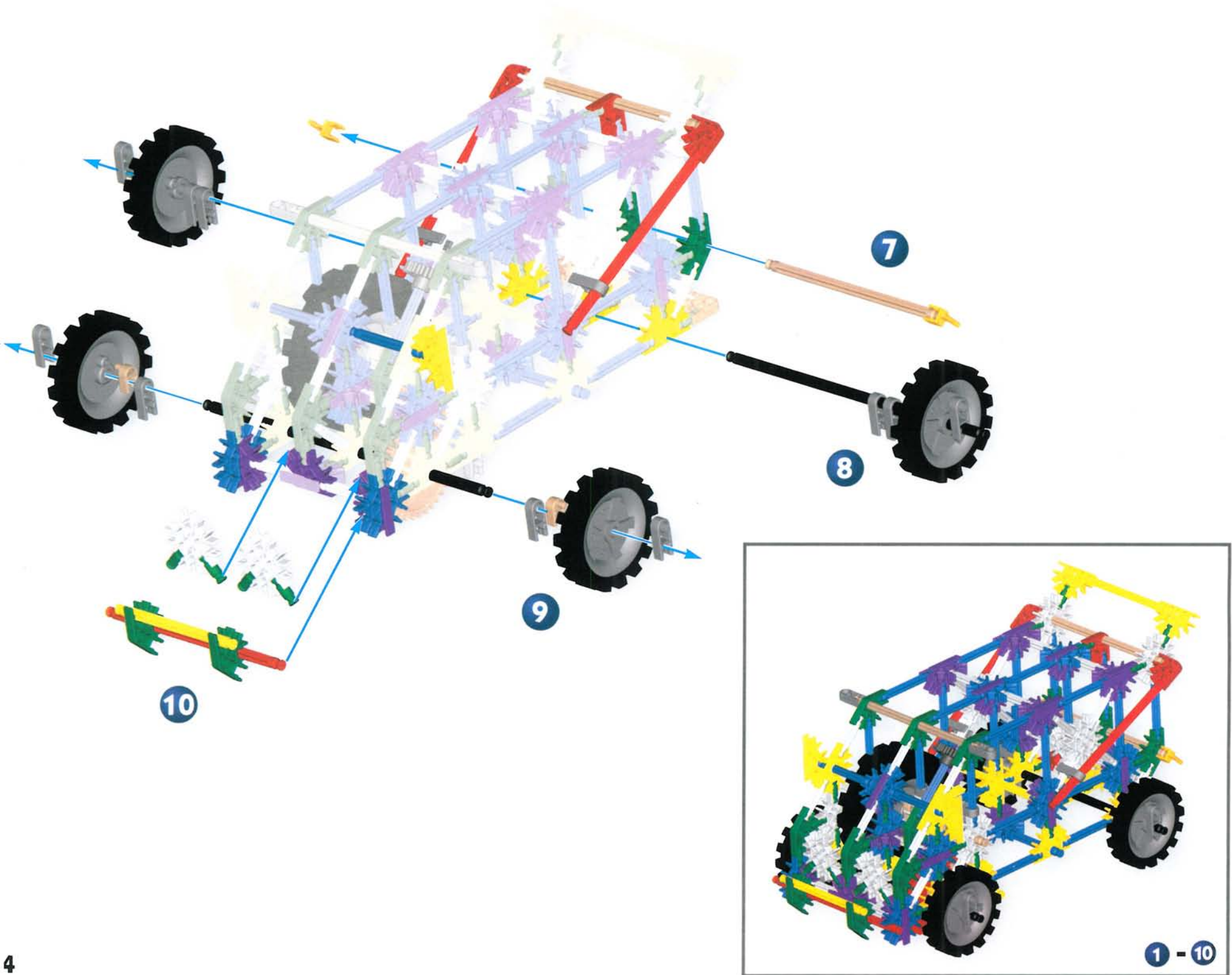

# Front End Loader

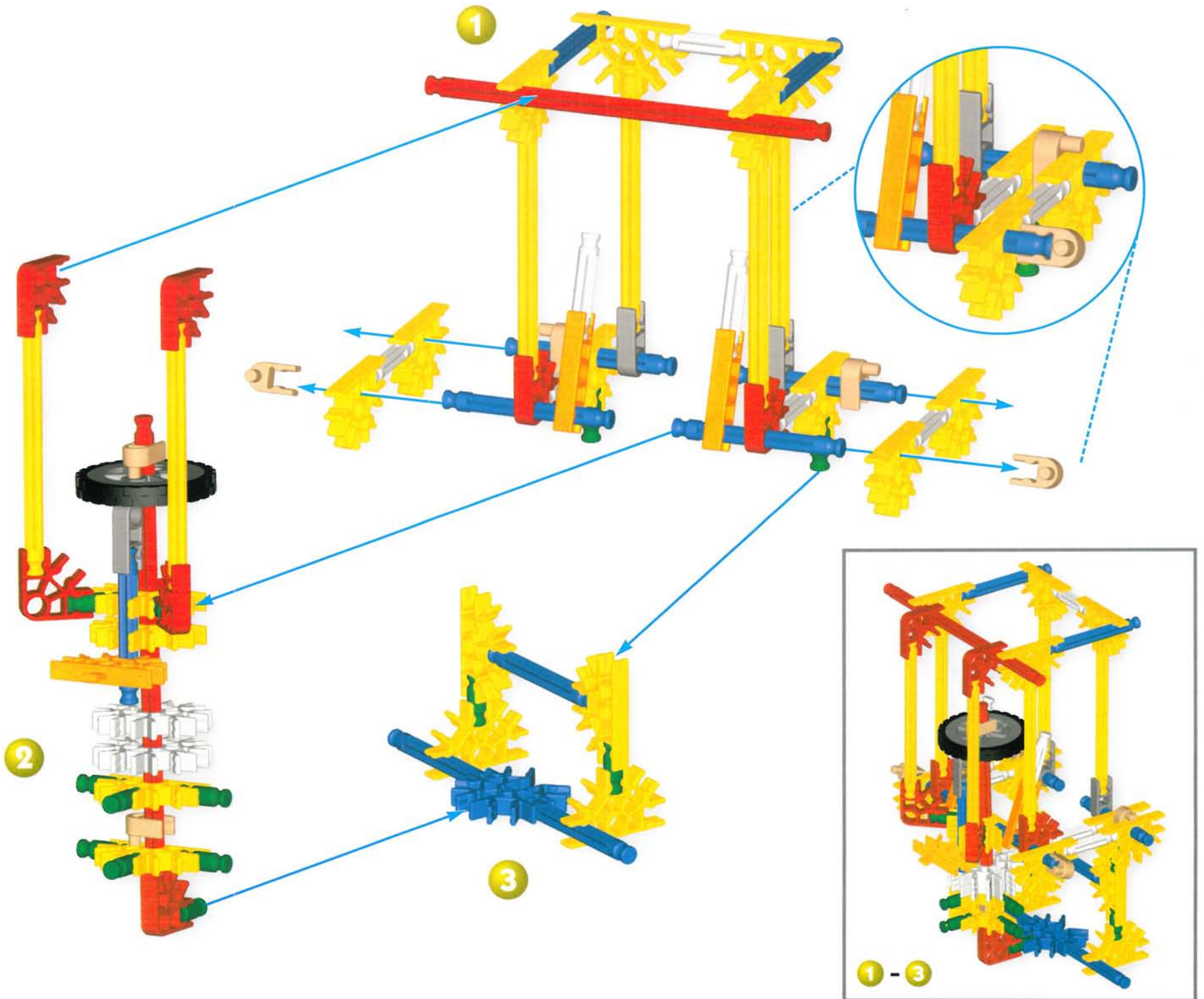

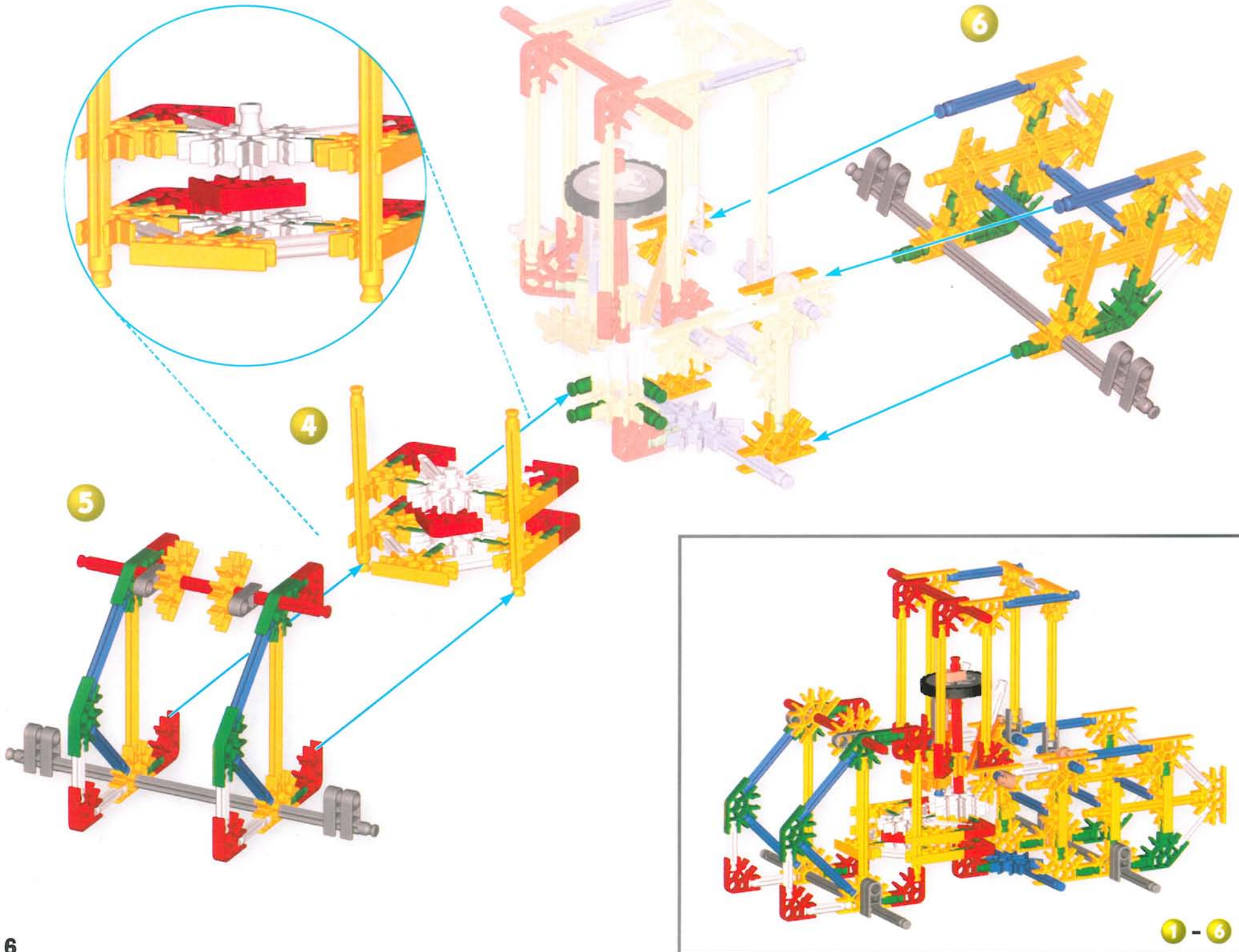

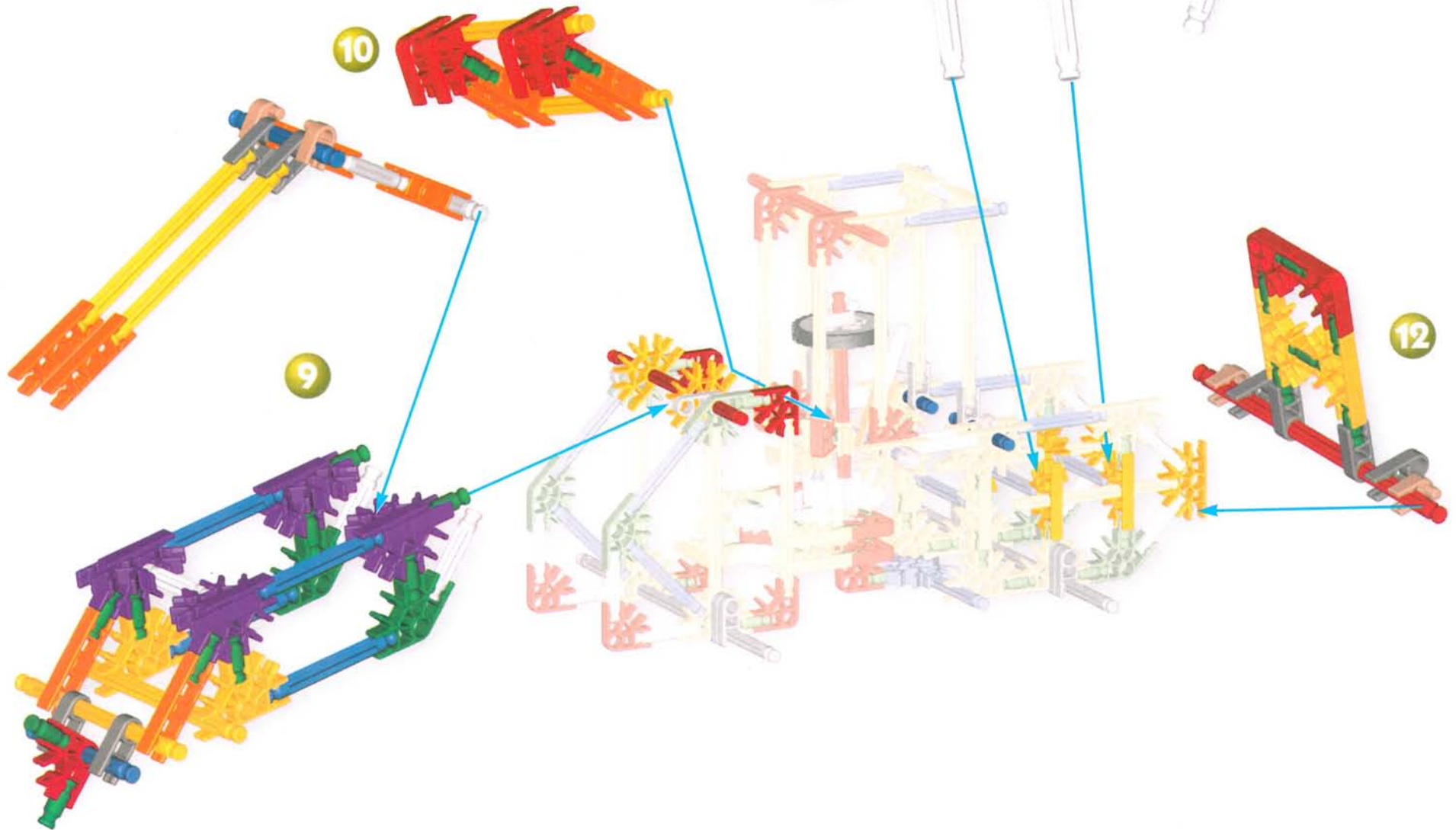
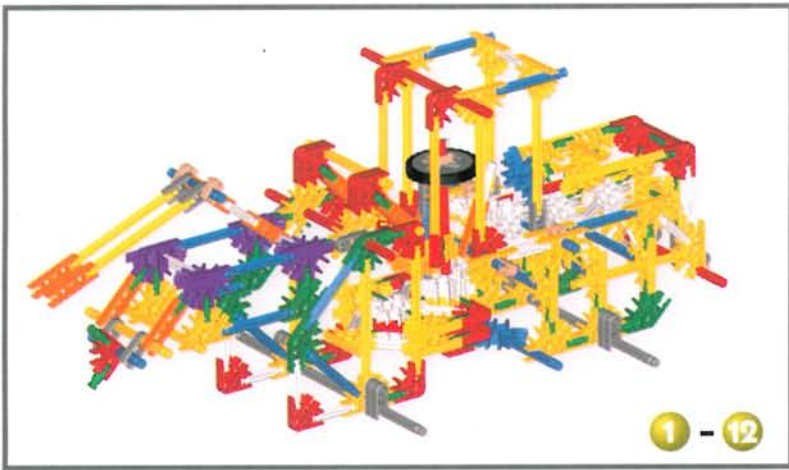

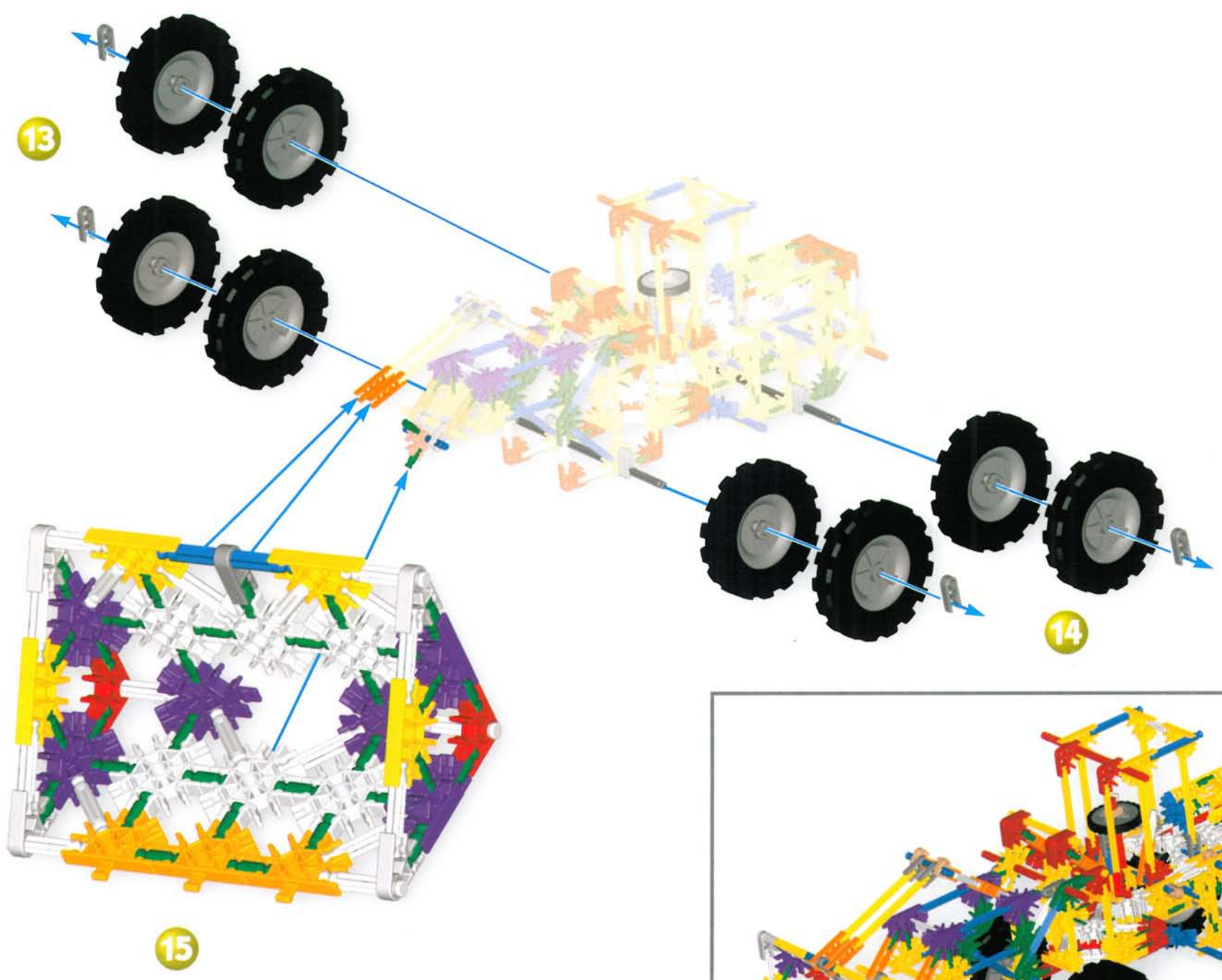

**K'NEX**  
MOTOR PACK

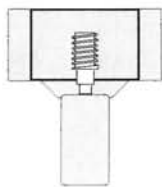

**POWER  
PACK**

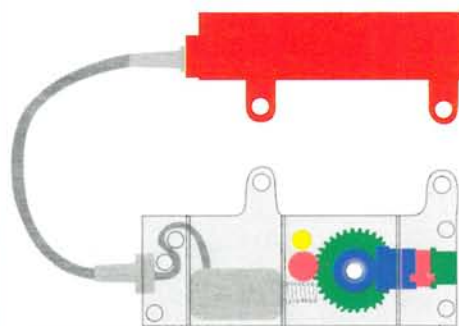

**MICRO  
POWER**

They Move



### Models move without motors.

Some instructions show motor installations using motors which are sold separately or in other K'NEX sets.

- GB** Models move without motors. Some instructions show motor installations using motors which are sold separately or in other K'NEX sets.
- F** Les modèles se déplacent sans moteur. Certaines explications illustrent des installations de moteurs, lesquels sont vendus séparément ou dans d'autres boîtes K'NEX.
- I** I modelli si muovono senza motori. Alcune istruzioni mostrano l'installazione di motori venduti separatamente o che fanno parte di altre confezioni K'NEX.
- D** Die Modelle bewegen sich ohne Motor. In einigen Anleitungen wird der Einbau von Motoren abgebildet, die separat oder mit anderen K'NEX-Bausätzen verkauft werden.
- E** Los modelos se mueven sin motor. Algunas instrucciones muestran instalaciones de motores que se venden por separado o en otros juegos K'NEX.
- S** Modellerna kan röra sig utan motor. Några bruksanvisningar visar montering av motorer som säljs separat eller i andra K'NEX-set.
- DK** Modellerne kan bevæge sig uden motor. Nogle brugsanvisninger viser montering af motorer, der sælges separat eller i andre K'NEX-sæt.
- N** Modellene kan bevege seg uten motor. Enkelte bruksanvisninger viser montering av motorer som selges separat eller i andre K'NEX-sett.
- SF** Mallit liikkuvat ilman moottoria. Joissakin ohjeissa näytetään asennuksia, joissa on erikseen tai muissa K'NEX-sarjoissa myytävä moottori.
- NL** De modellen worden zonder motor bewogen. Sommige instructies tonen installaties met motors; de motors worden apart of in andere sets van K'NEX verkocht.
- P** Os modelos deslocam-se mesmo sem motor. Algumas instruções apresentam motores que são vendidos separadamente ou fazem parte de outros conjuntos K'NEX.
- G** Τα μοντέλα κινούνται χωρίς κινητήρα. Μερικές από τις οδηγίες δείχνουν εγκατάσταση κινητήρων που πωλούνται ξεχωριστά ή βρίσκονται σε άλλα K'NEX σετ.
- TR** Modeller motorsuz hareket ederler. Bazı açıklamalarda ayrı olarak satılan veya diğer K'NEX setlerinde bulunan motorların nasıl takıldığı gösterilmektedir.
- J** 模型はモーターを使用しなくても動きます。別売り、あるいは他のK'NEXセットのモーターを使用する場合は、組込み方が説明書に記載されています。
- CHI** 模型操作不須馬達。某些拼裝指南列明馬達安裝方法，馬達另行出售或含在其它 K'NEX 組合。
- IL** הדגמים נעים ללא מנועים. בהוראות מסוימות, מופיעים התקני מנוע שעושים שימוש במנועים, אשר נמכרים בנפרד או בערכות אחרות של K'NEX.

# Twirler

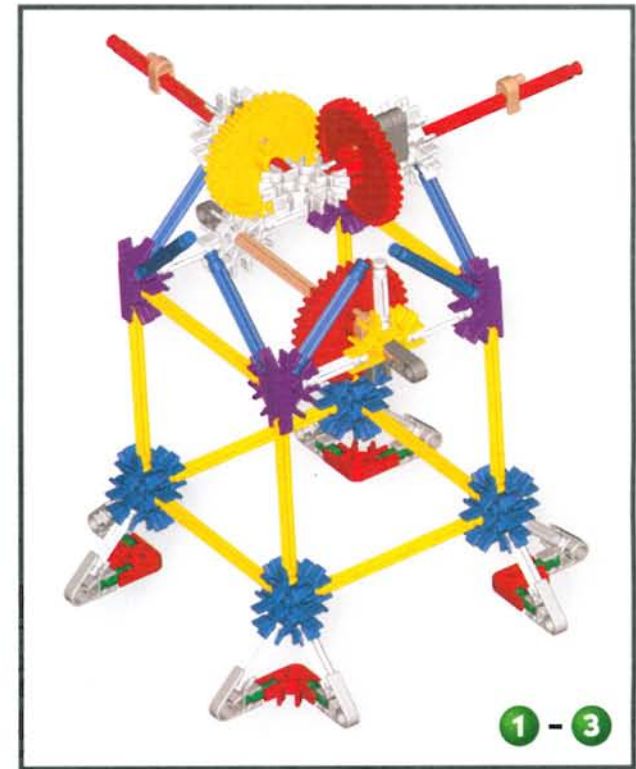
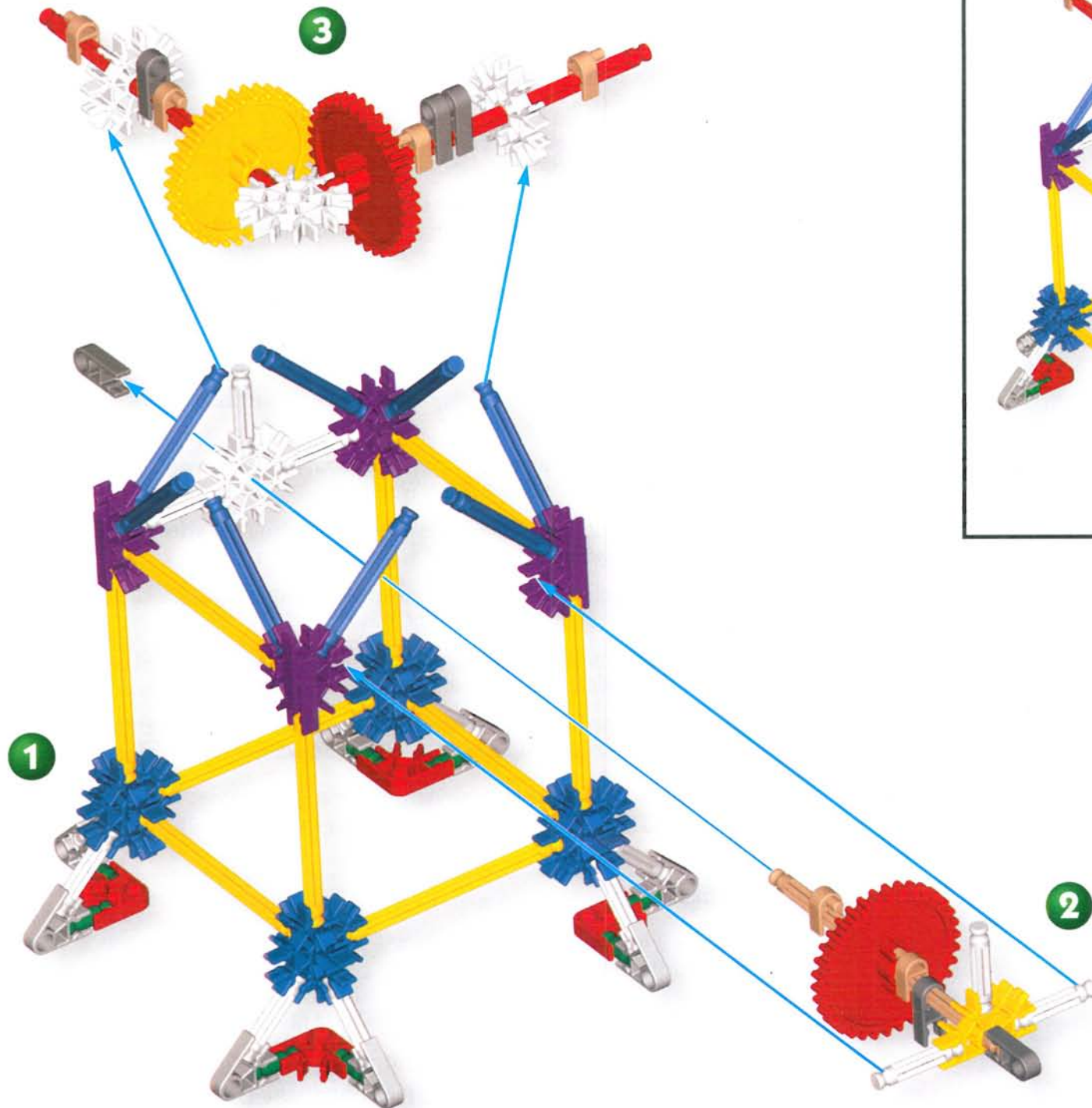

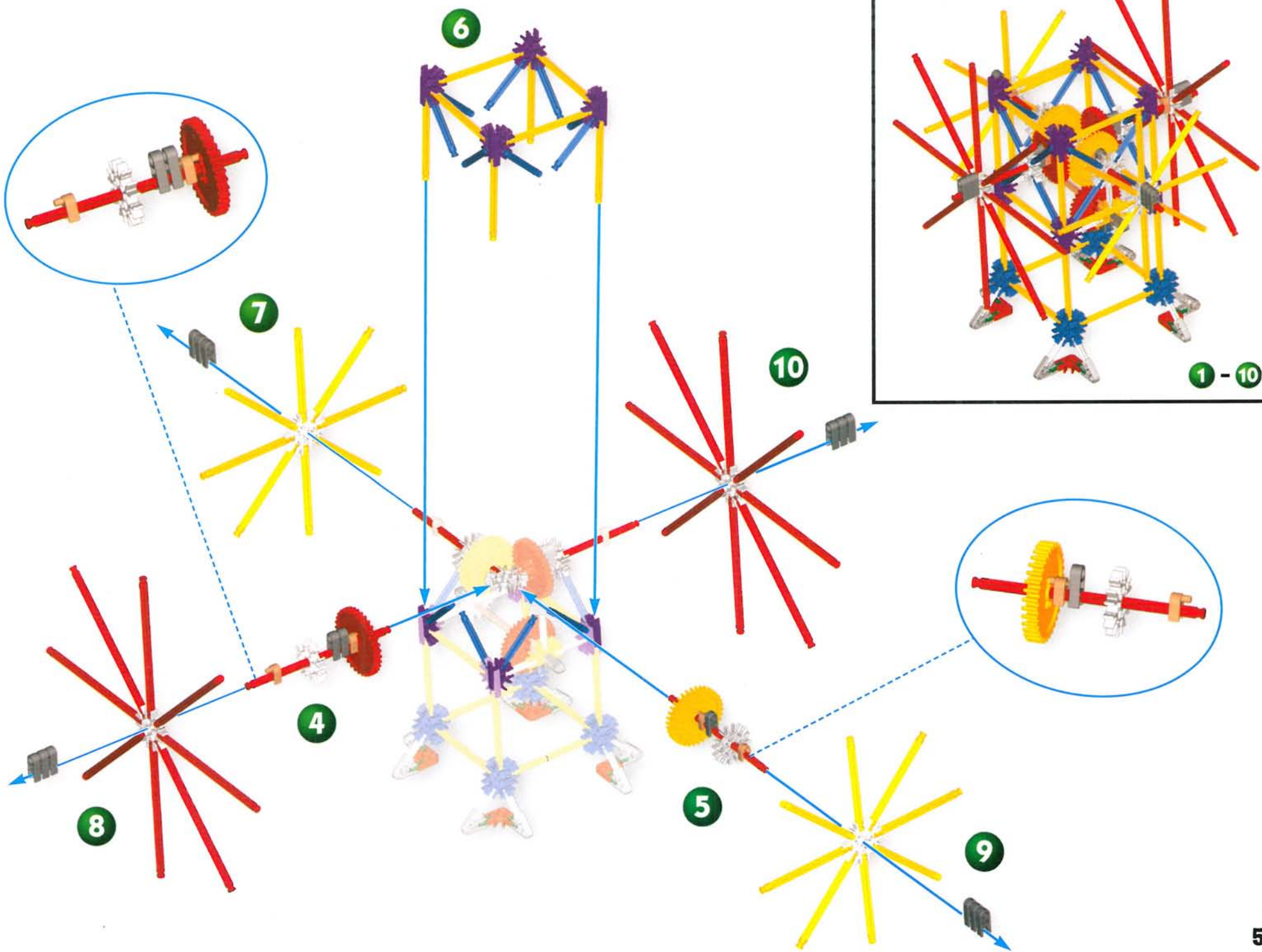

 **K'NEX**  
MOTOR PACK  
INSTALLATION

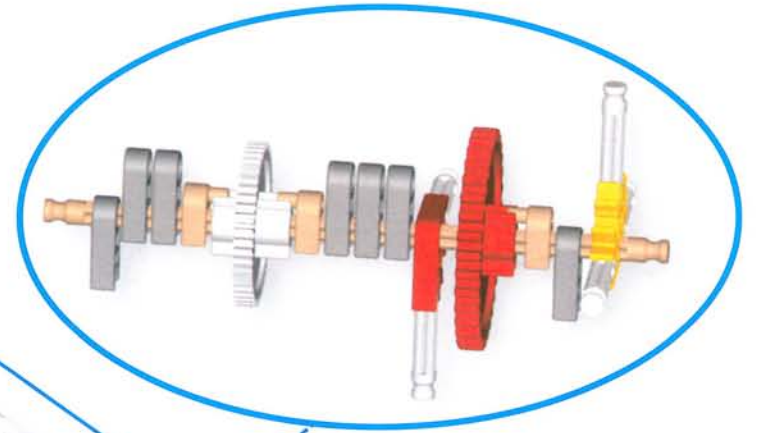
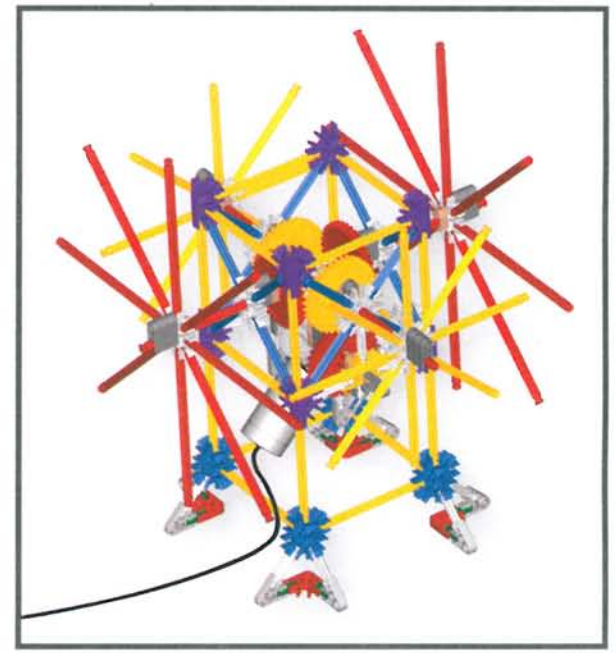
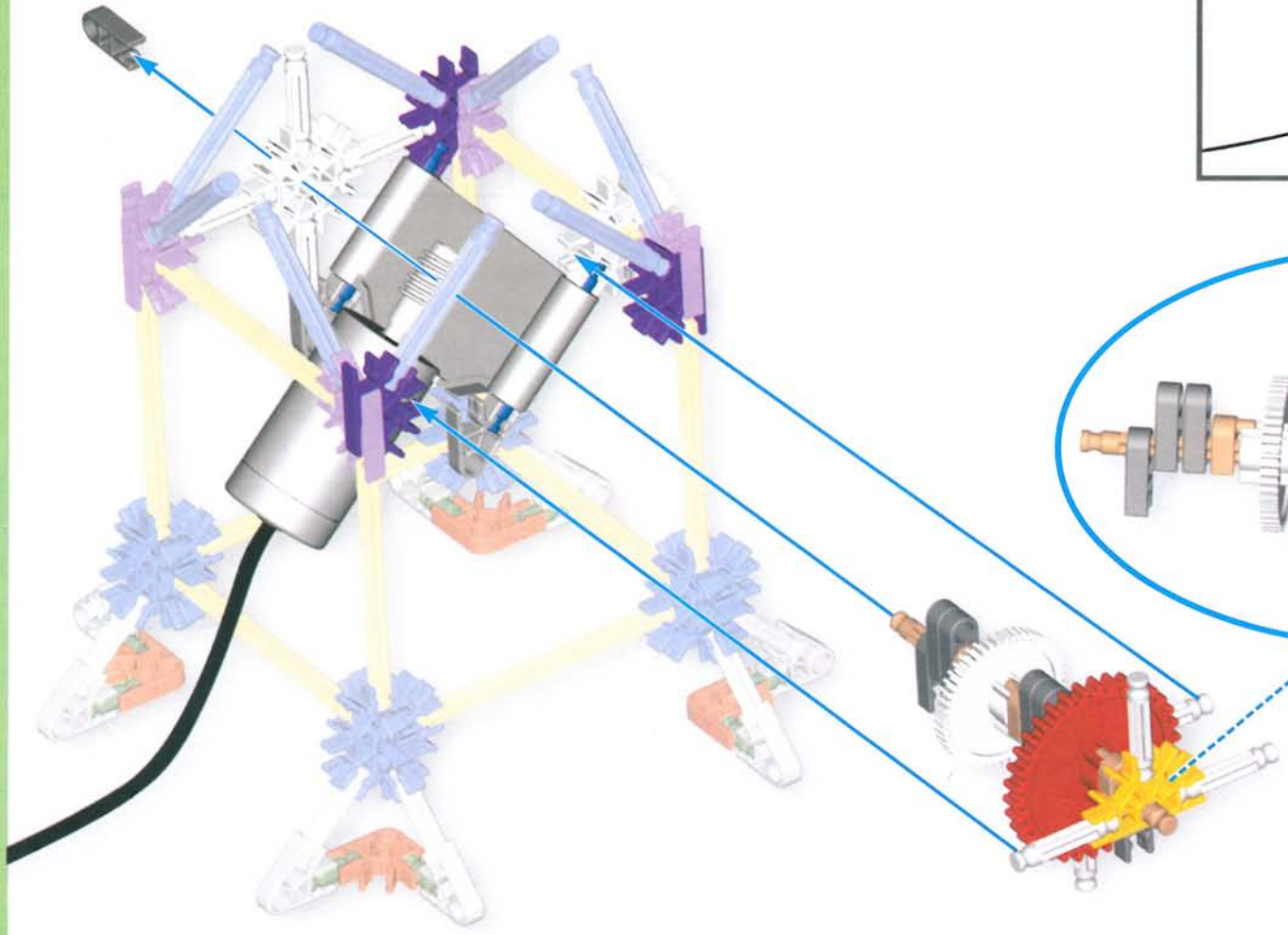

# Swing Ride

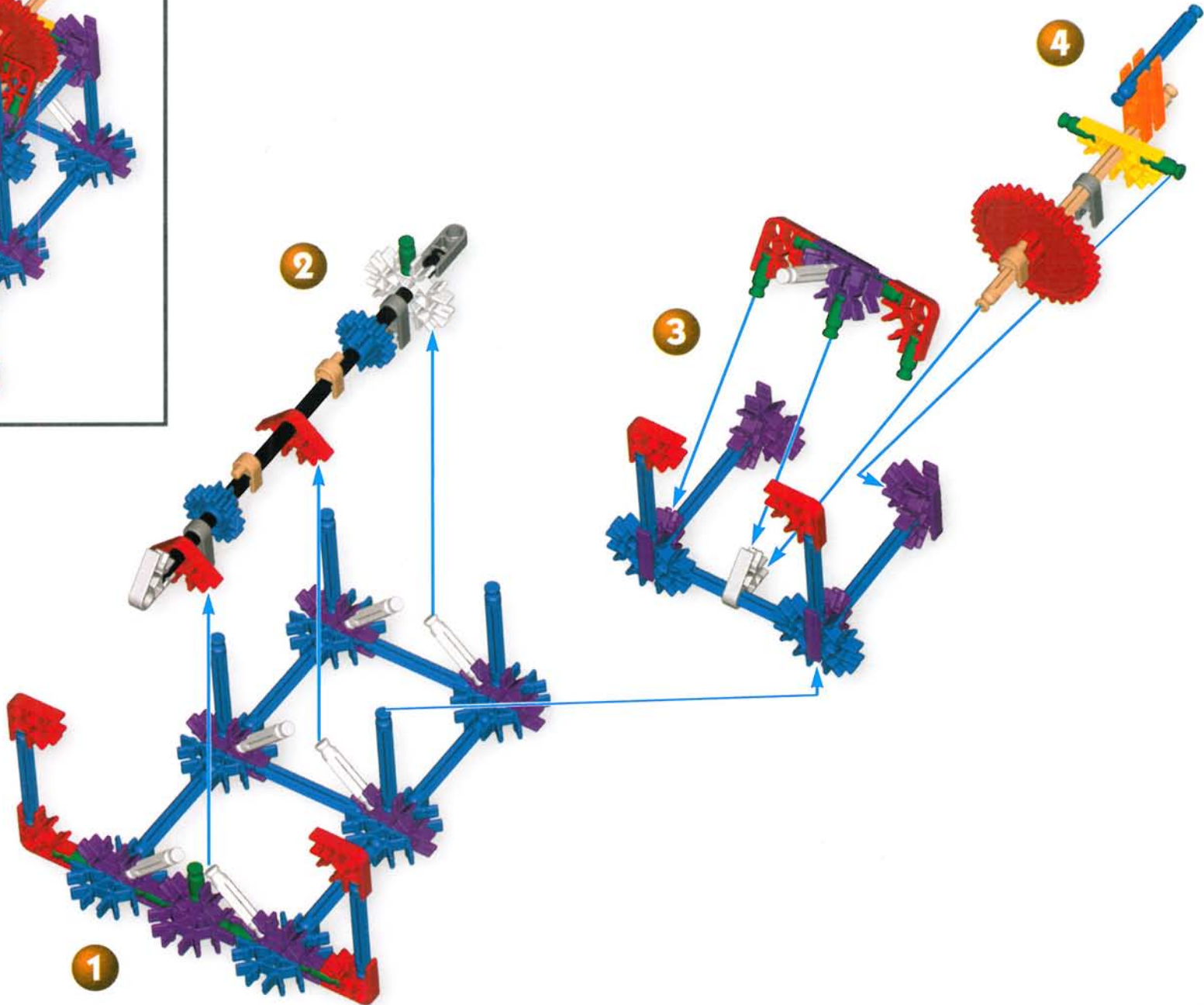
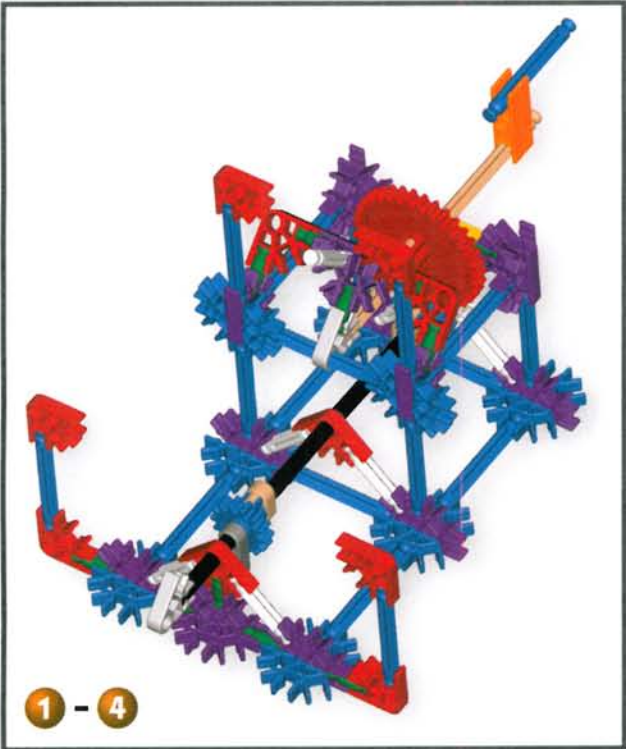

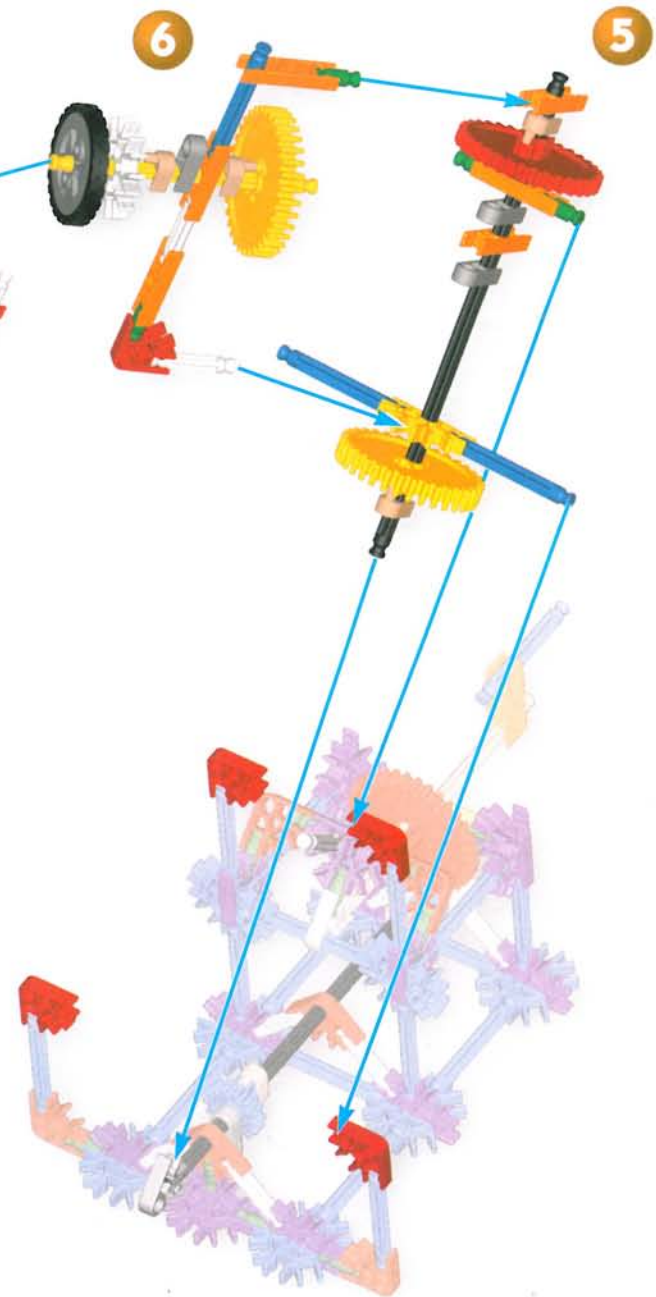
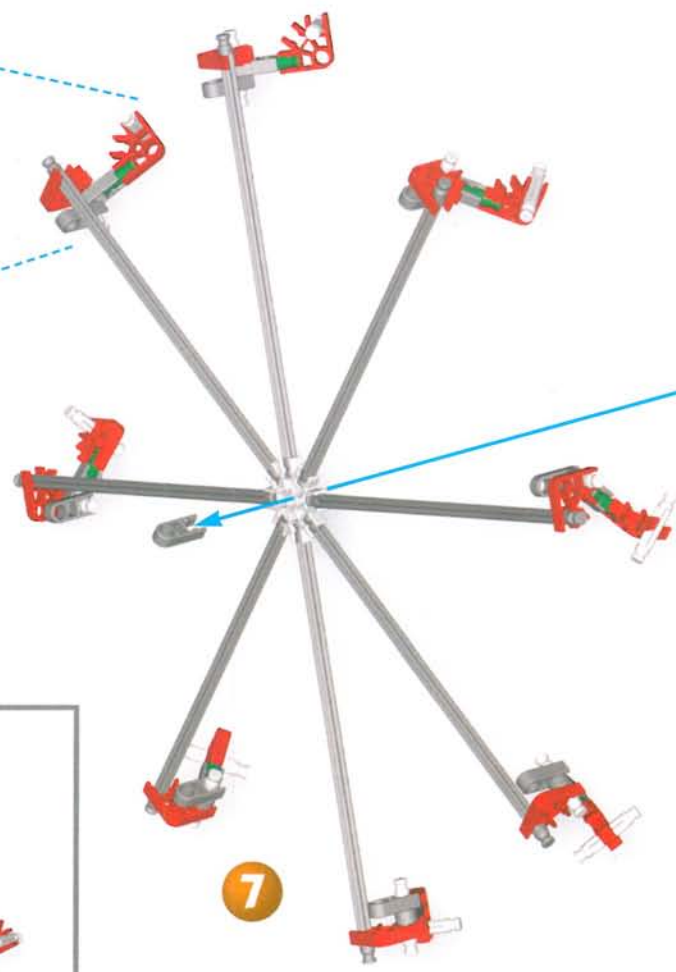
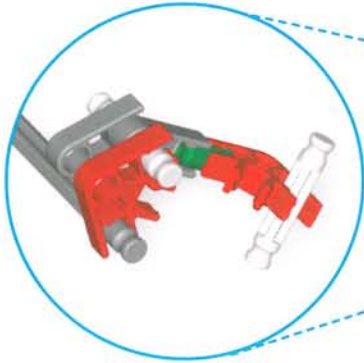

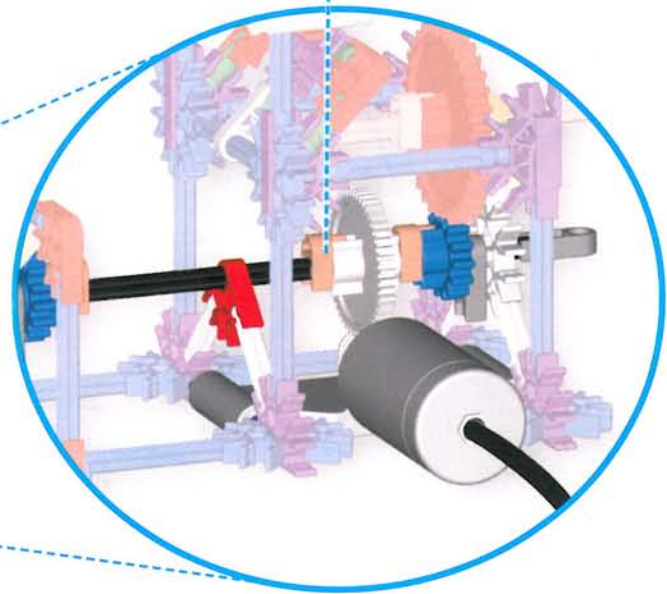
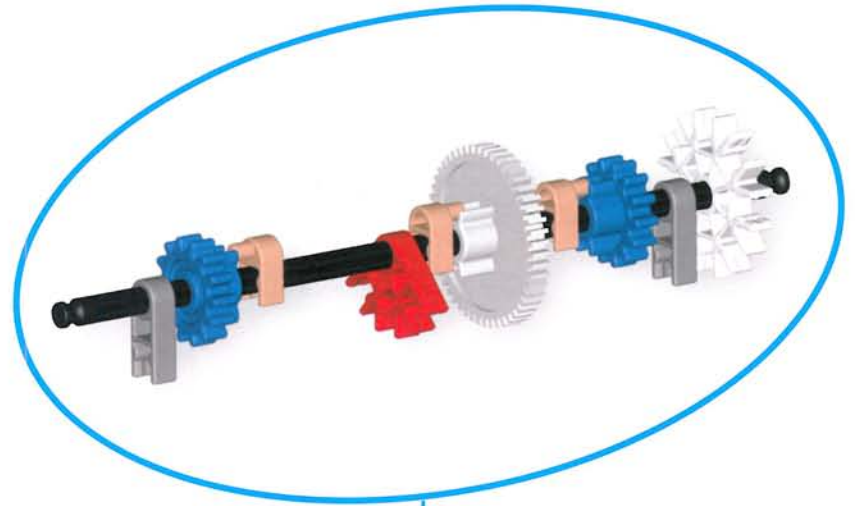
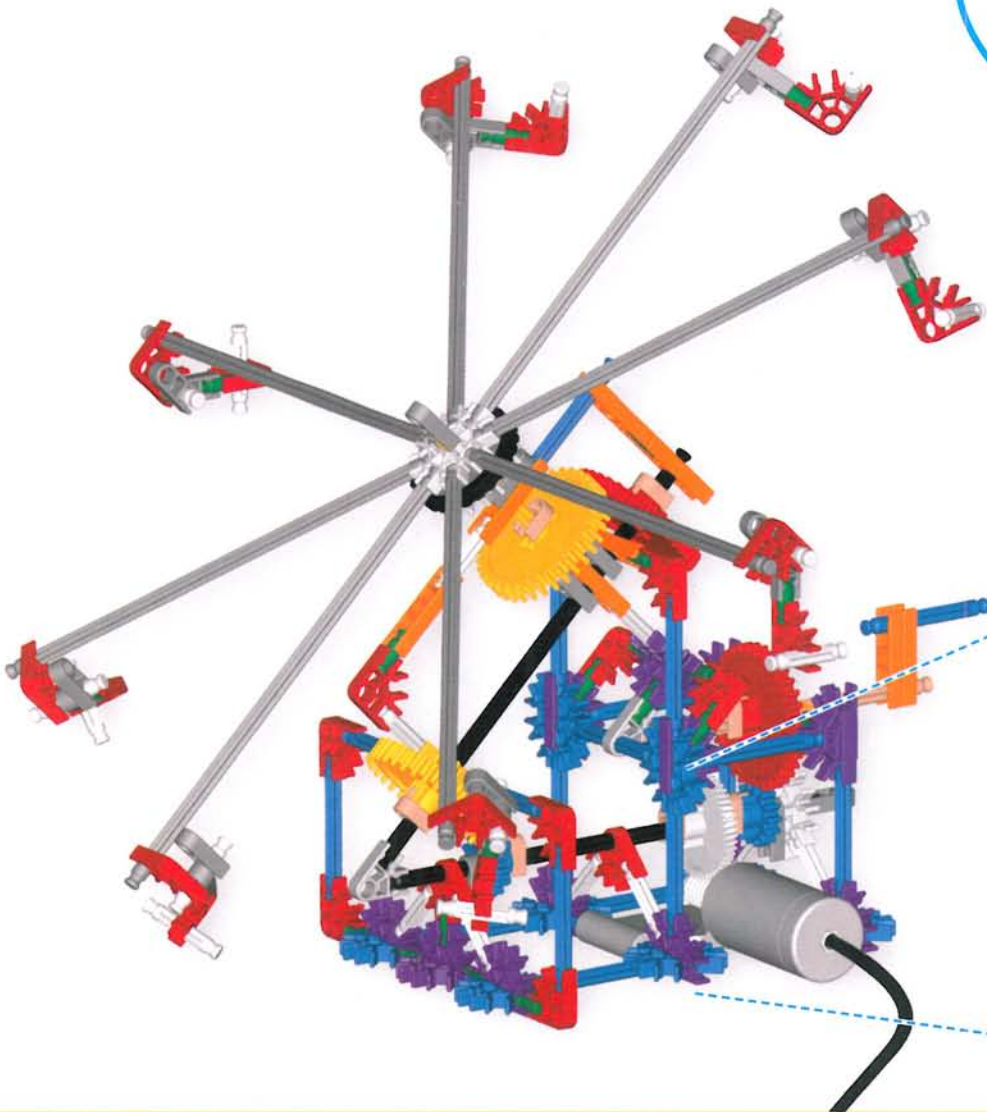

# Gizmo

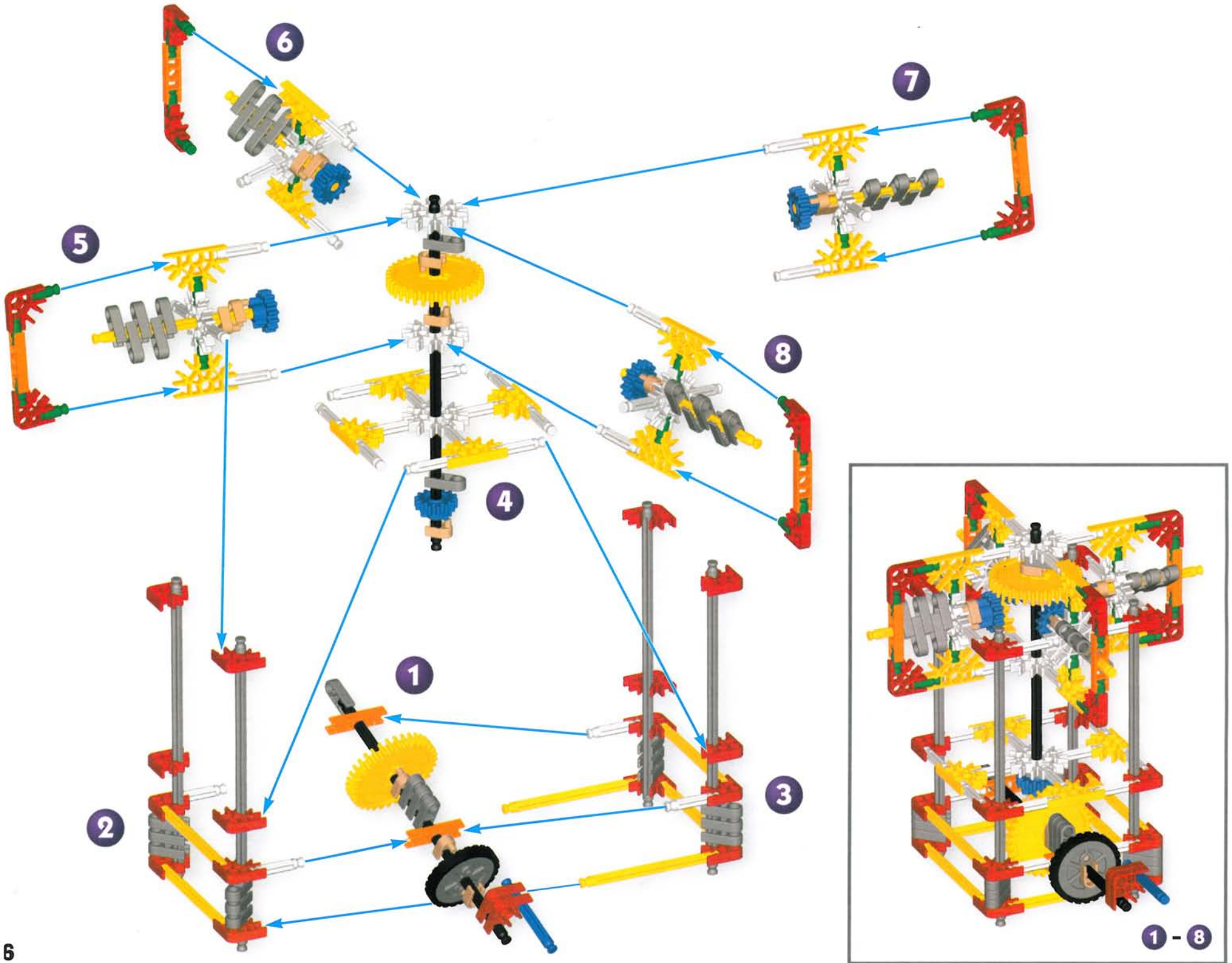

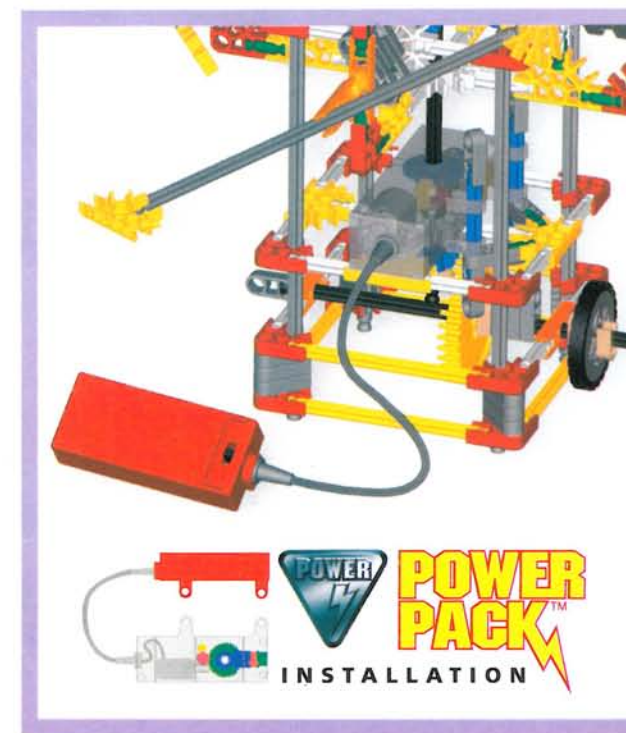
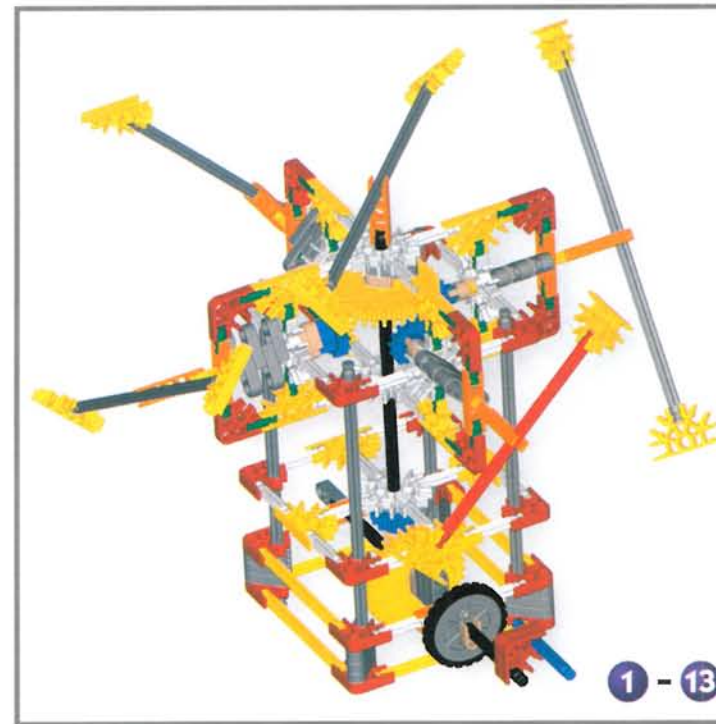
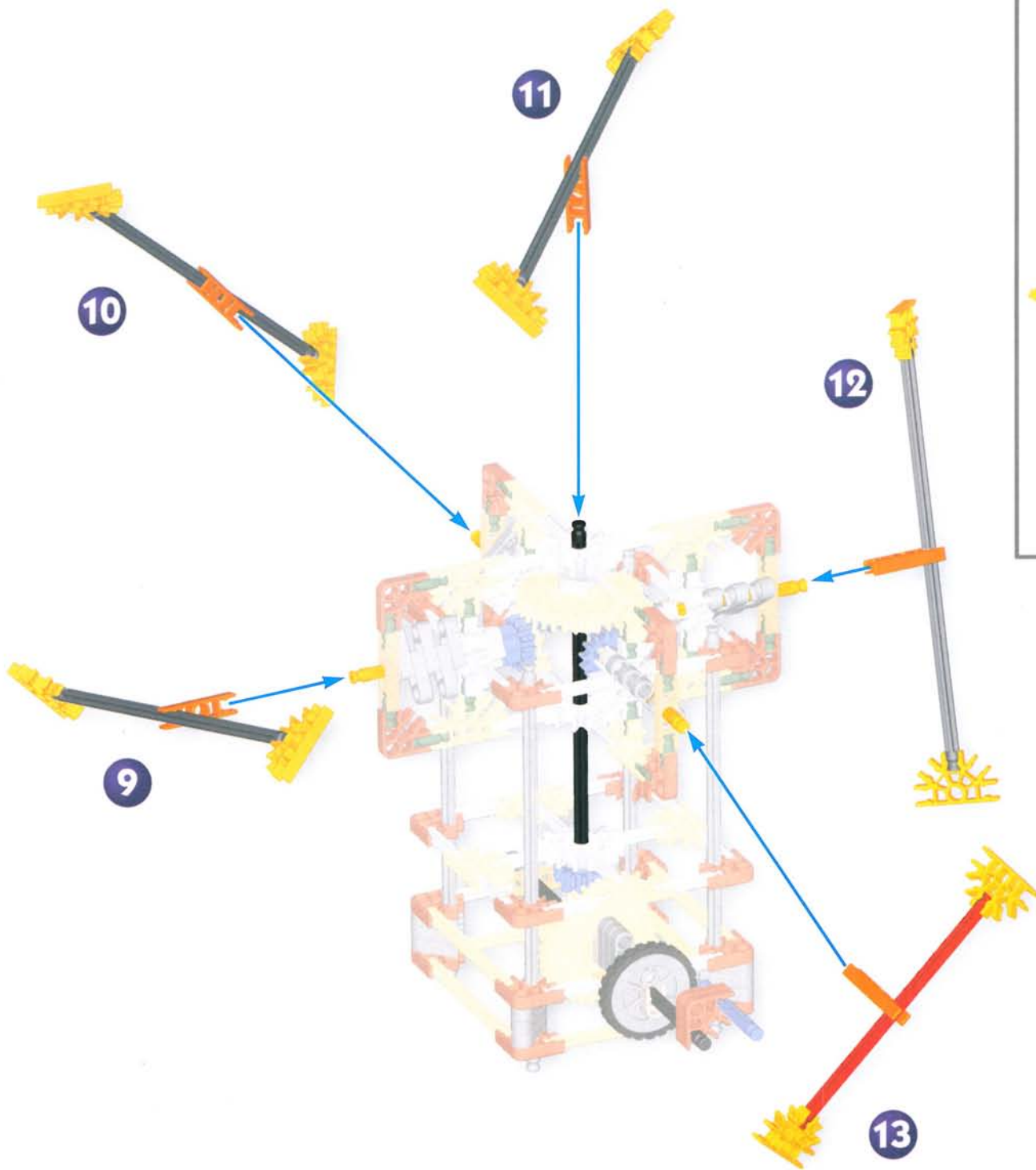

# Telephone

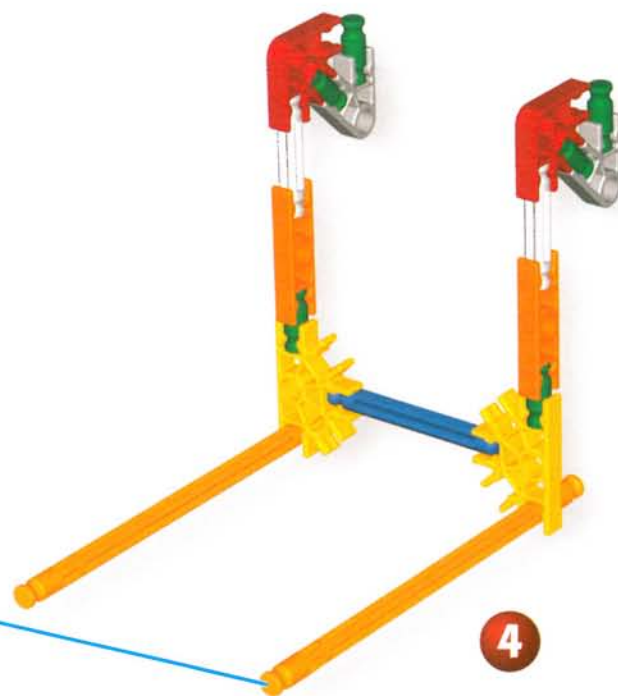
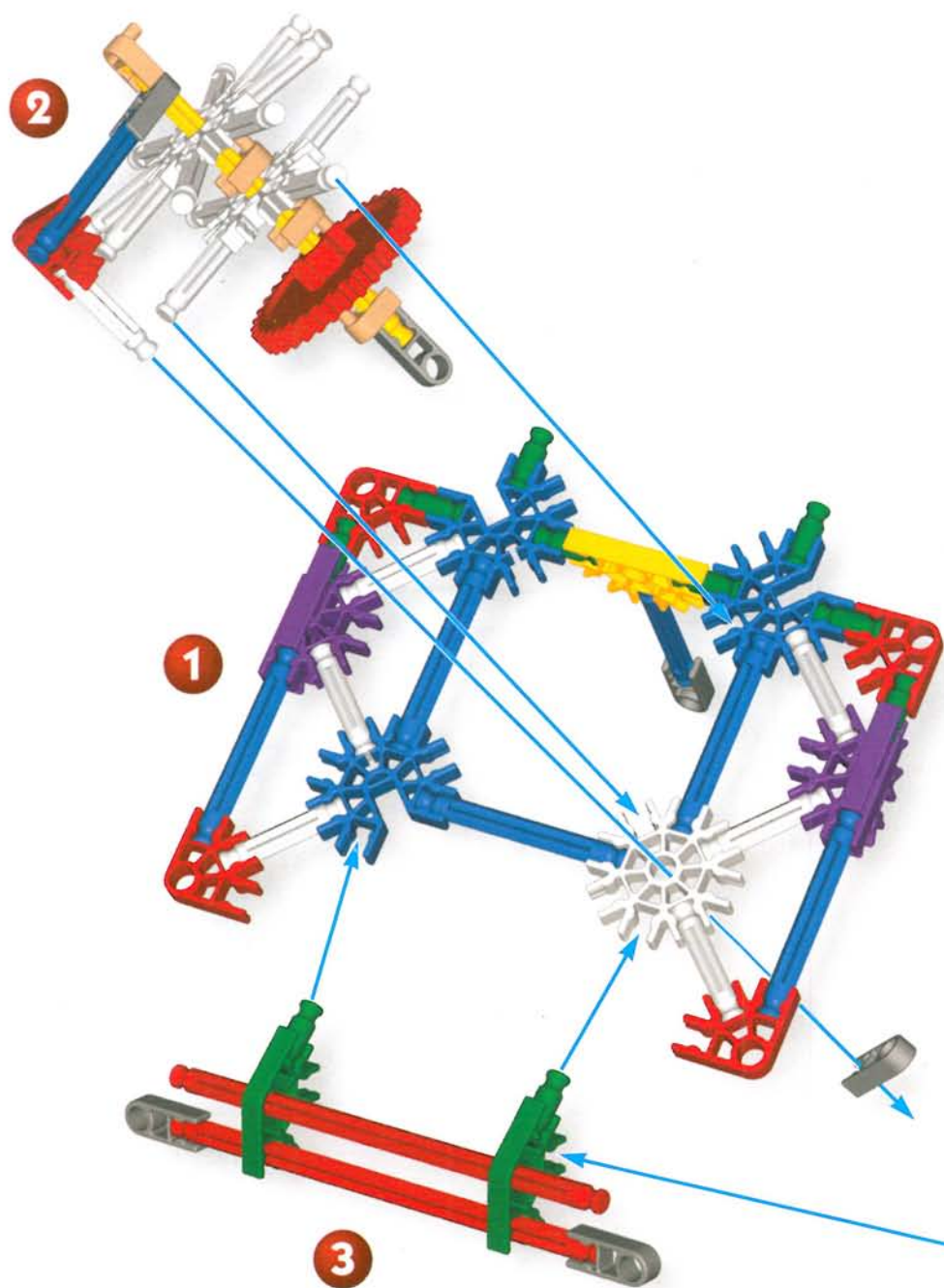

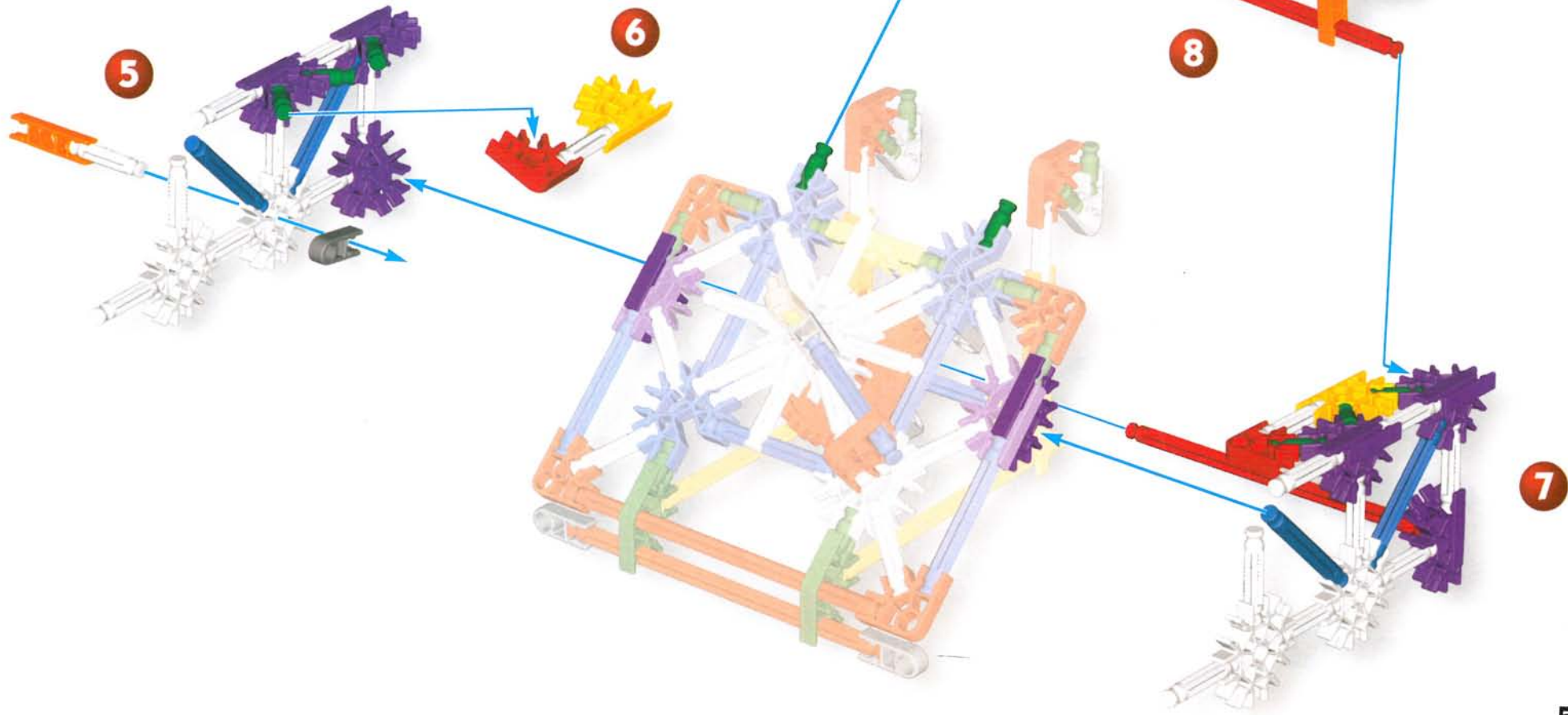
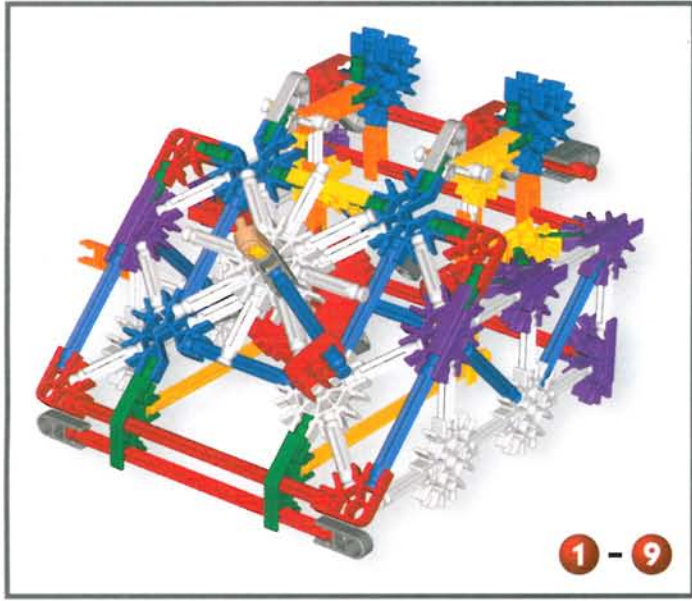

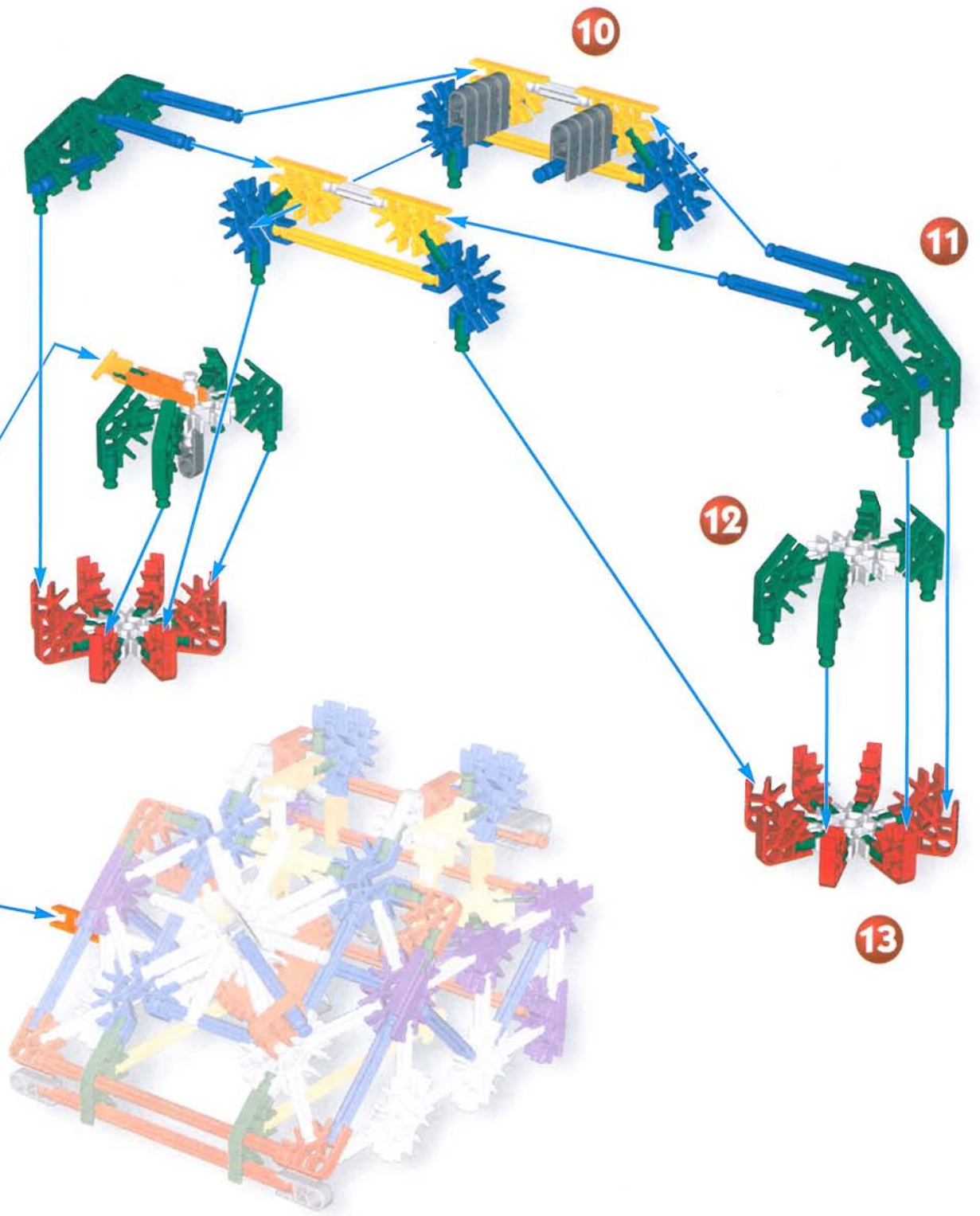

 x24



 **K'NEX**  
MOTOR PACK  
INSTALLATION

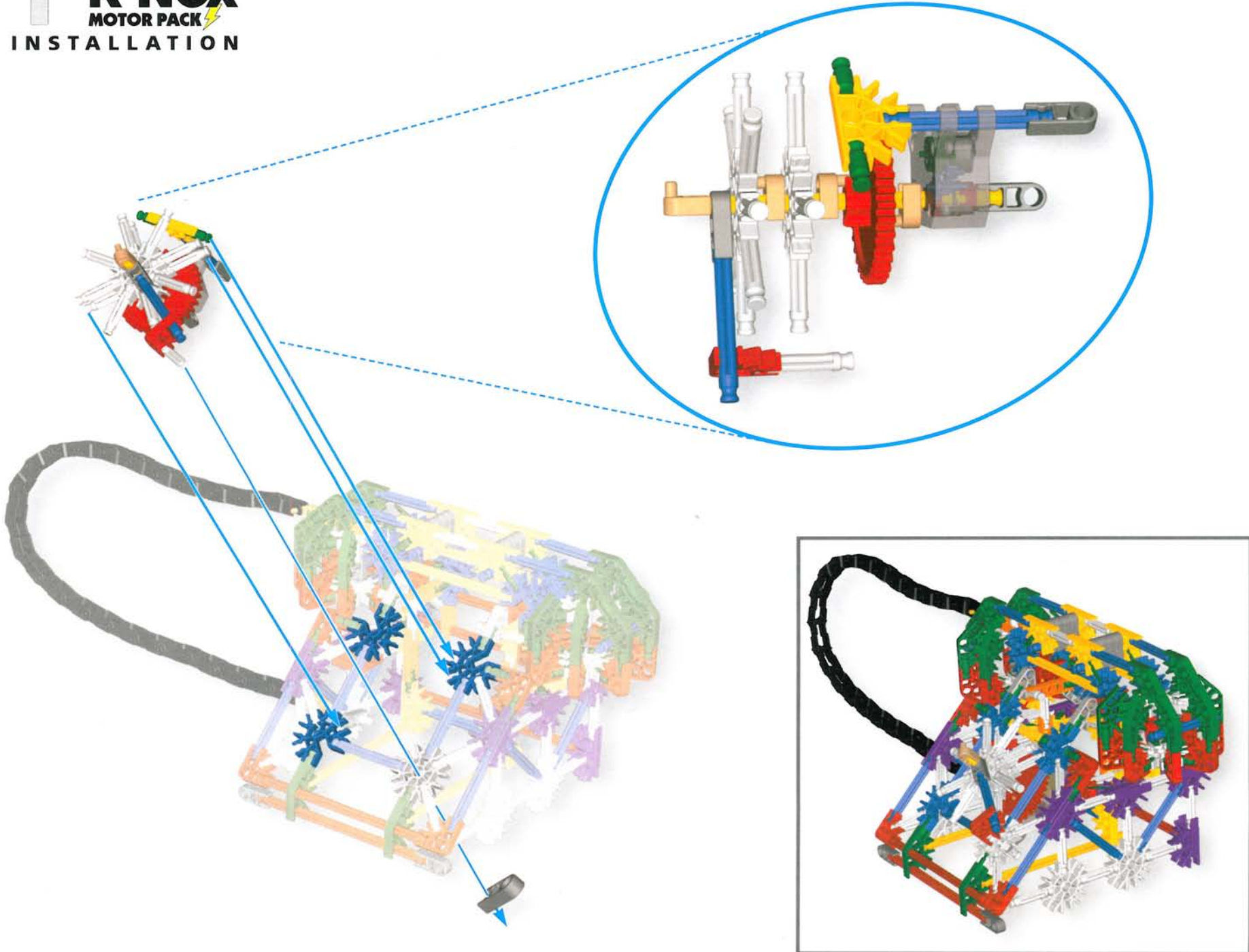

# Dump Truck

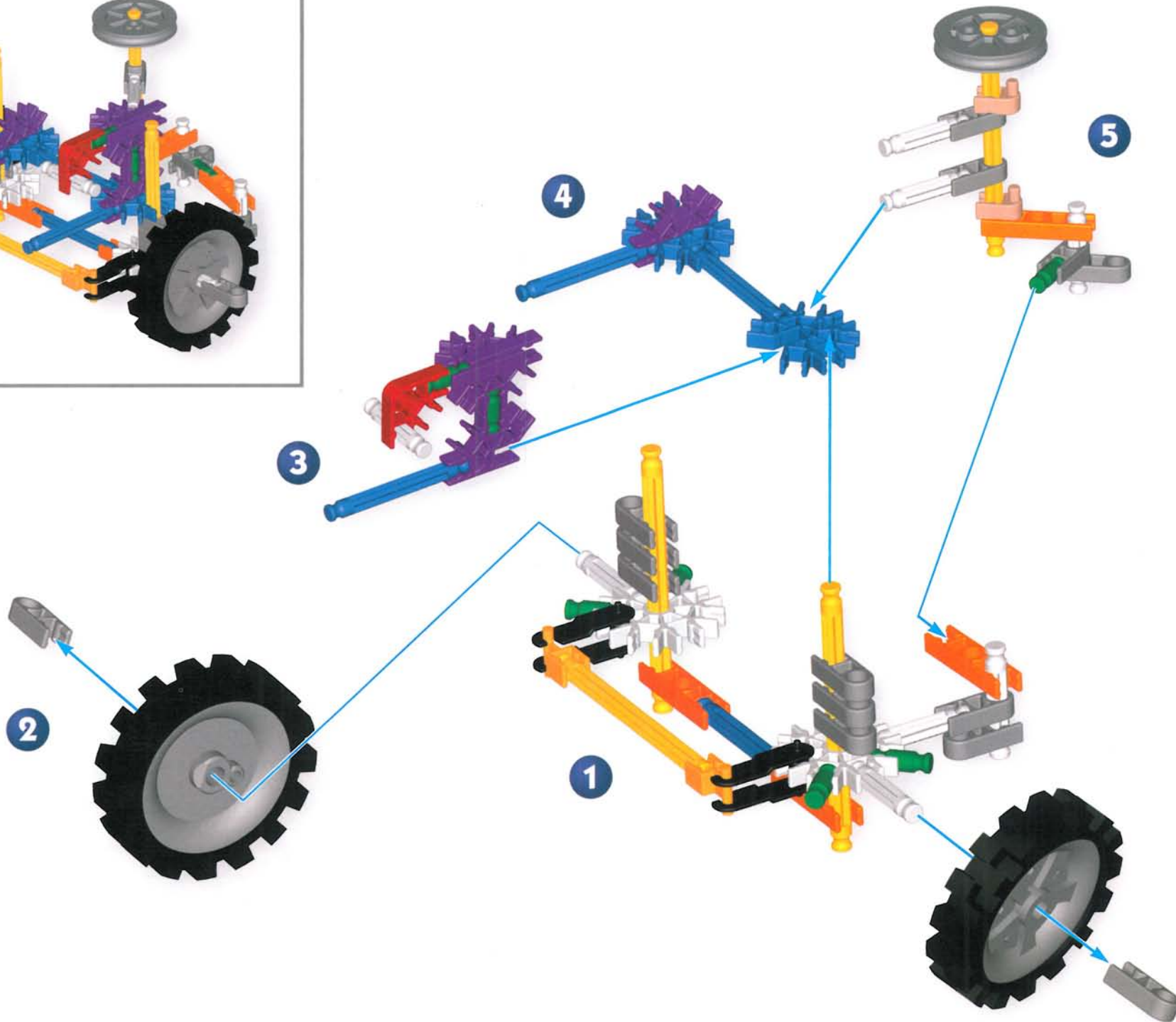

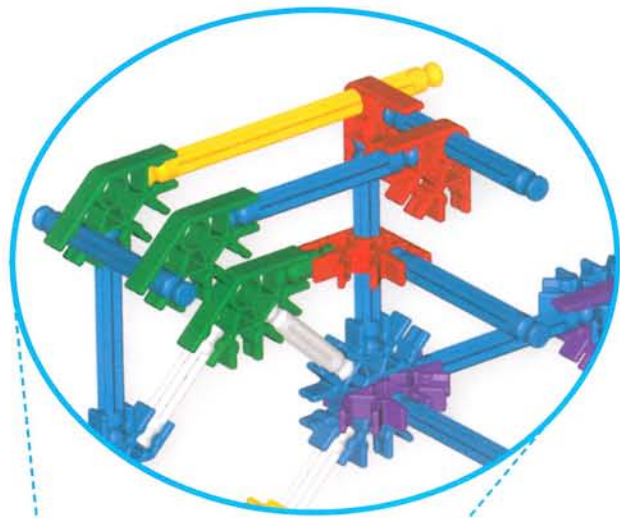

6

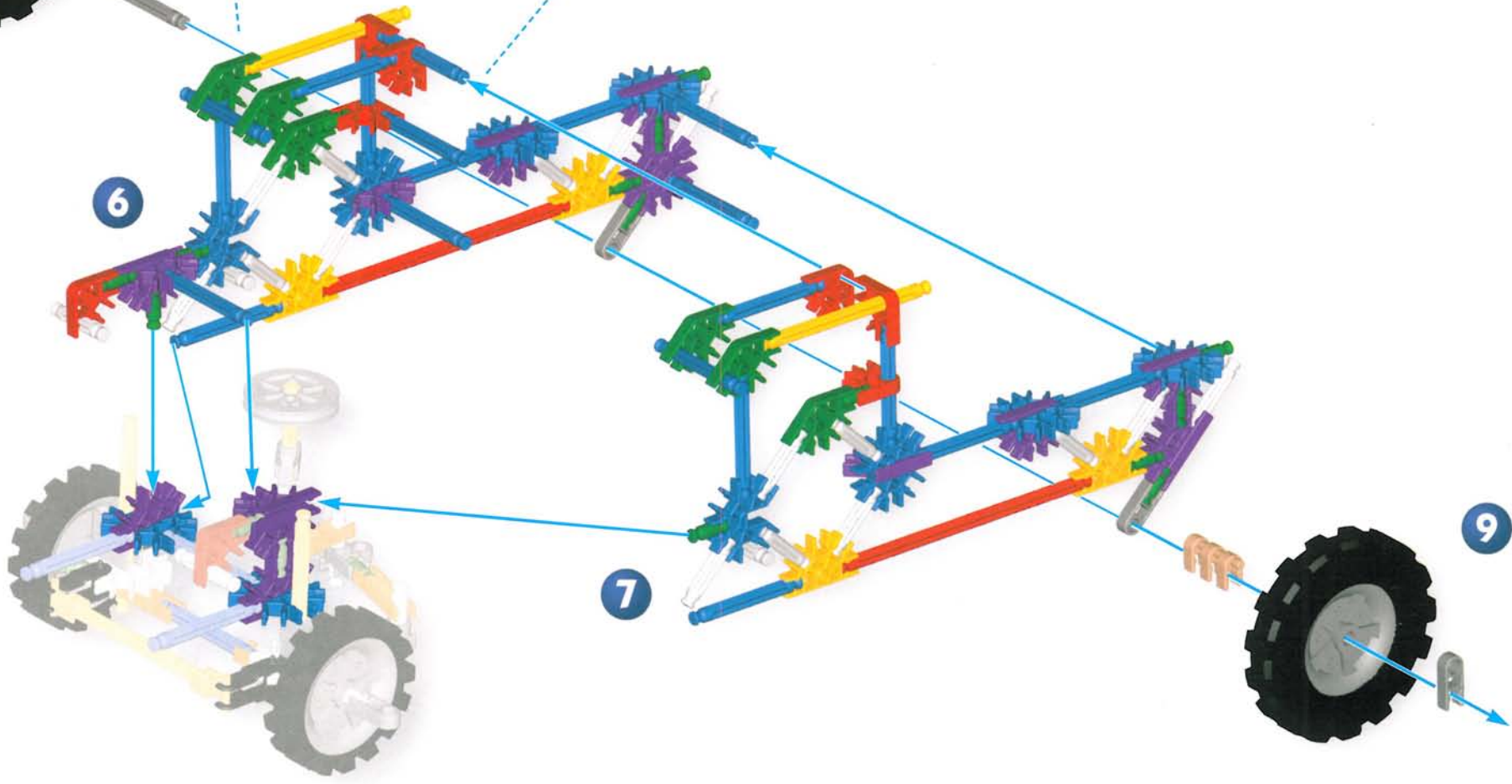

7

9

1 - 9

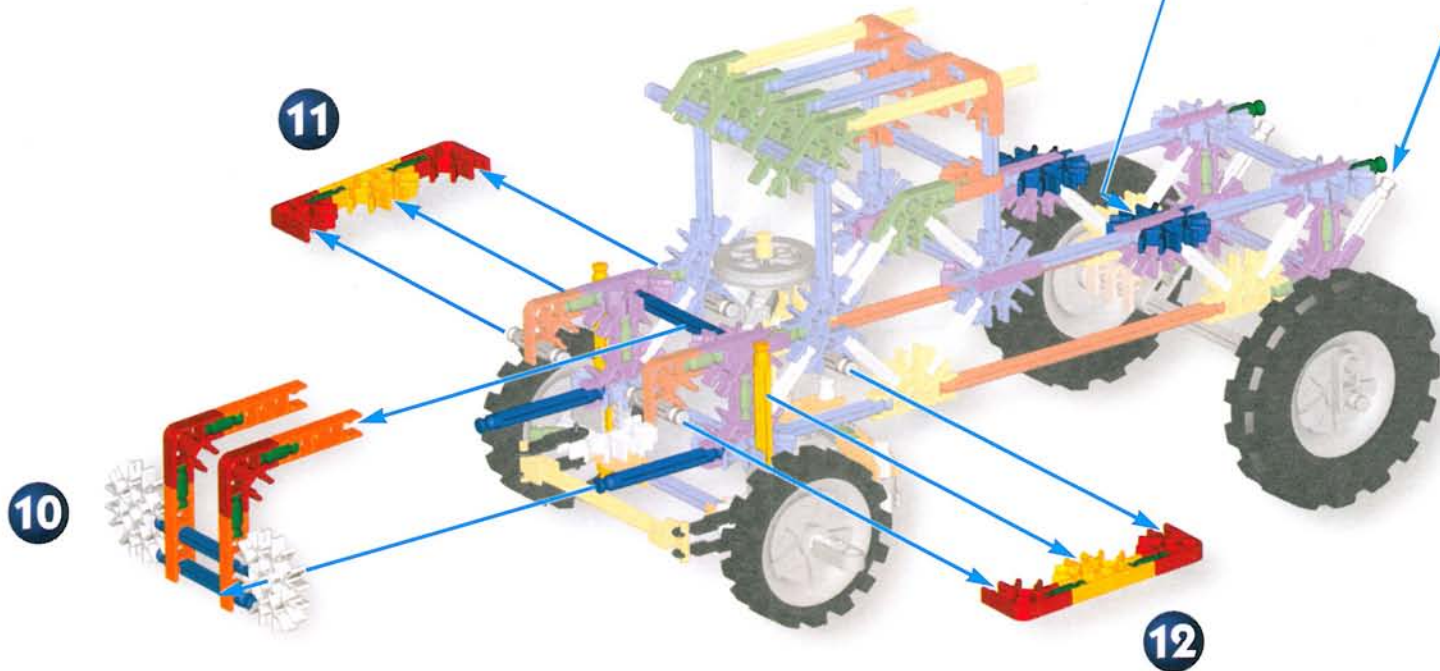
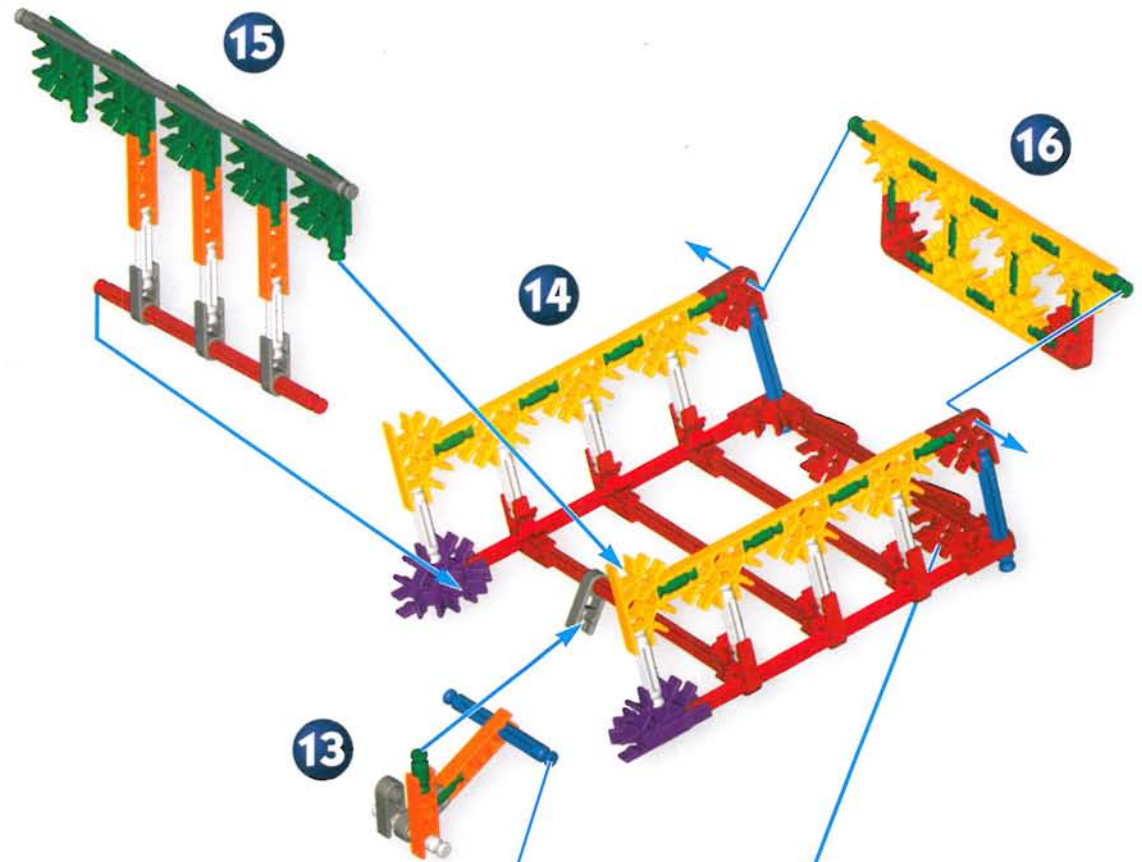
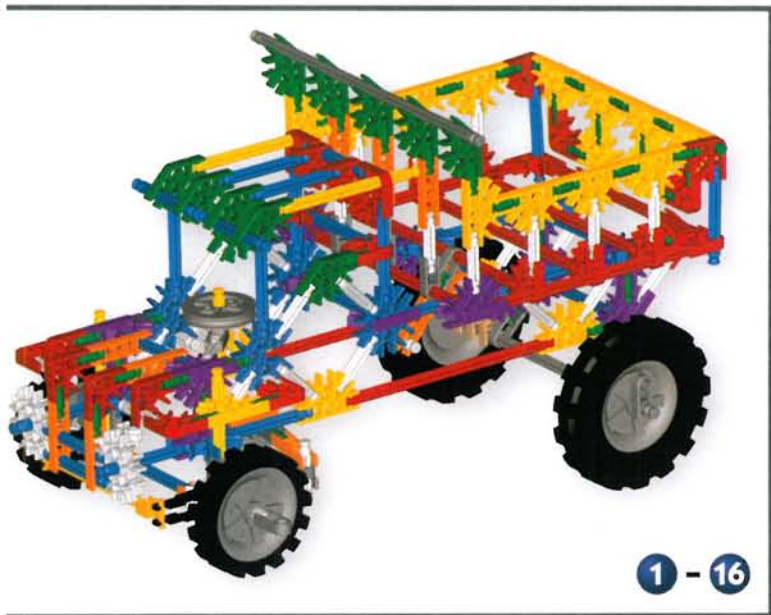

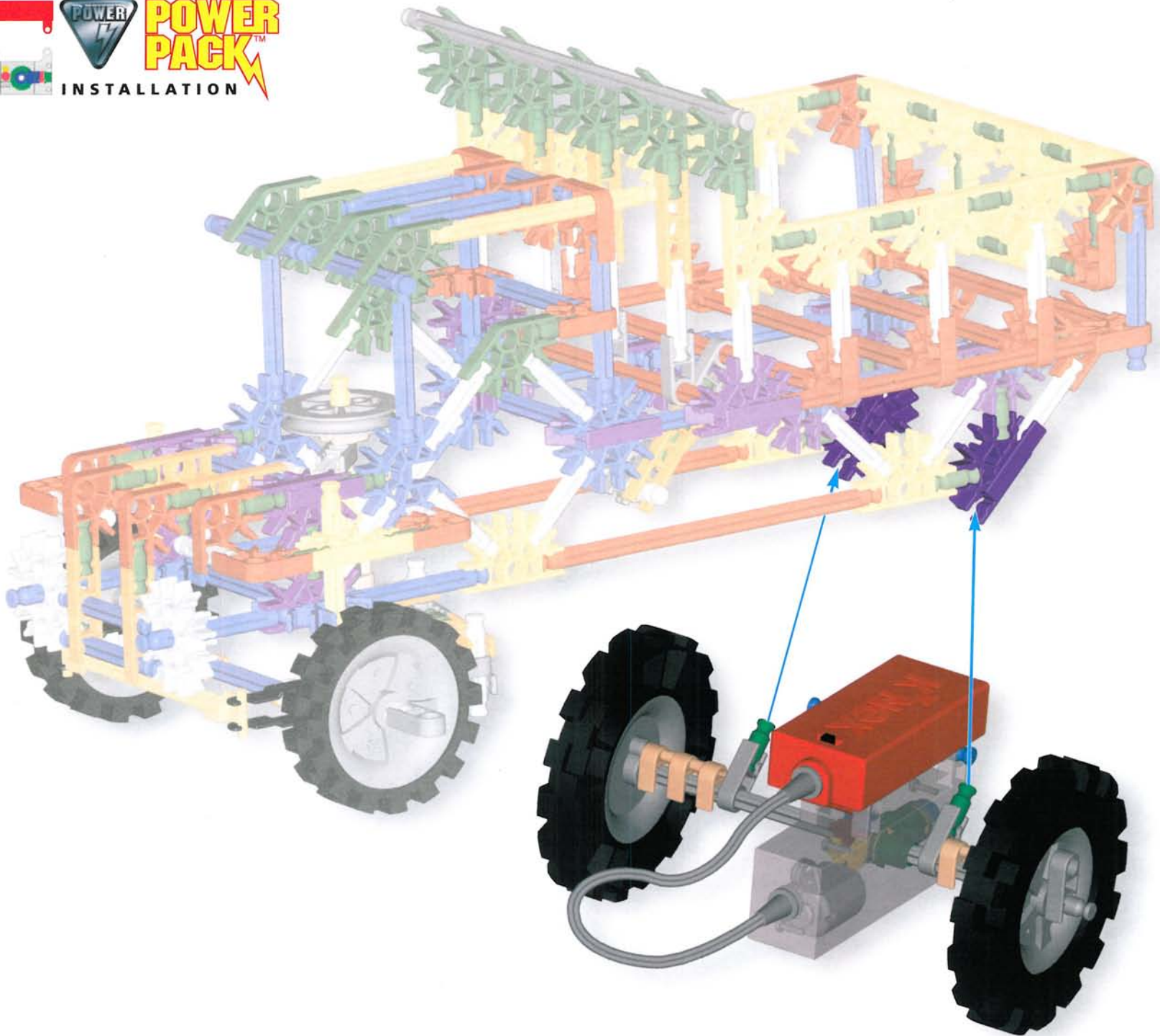

# Helicopter Ride

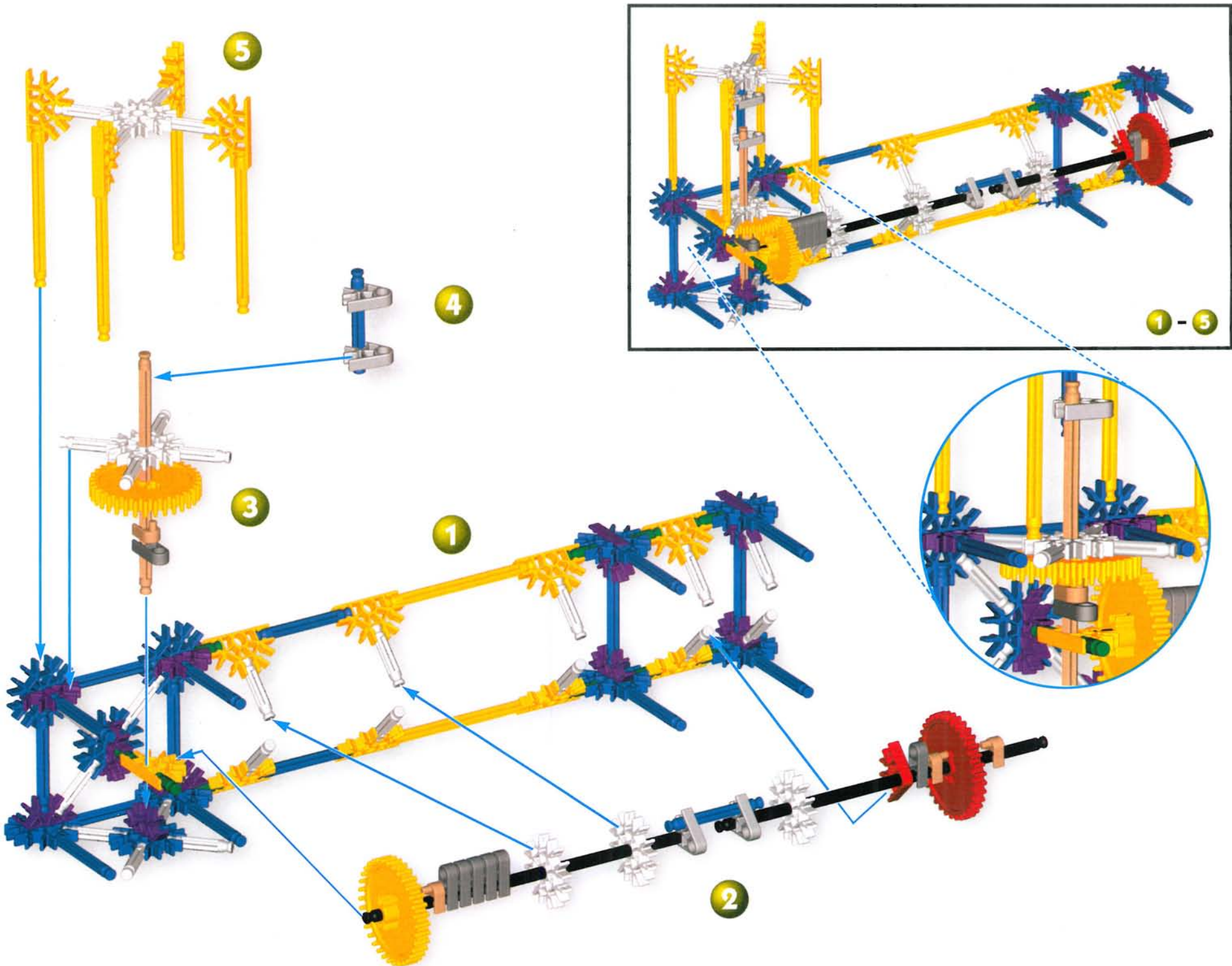

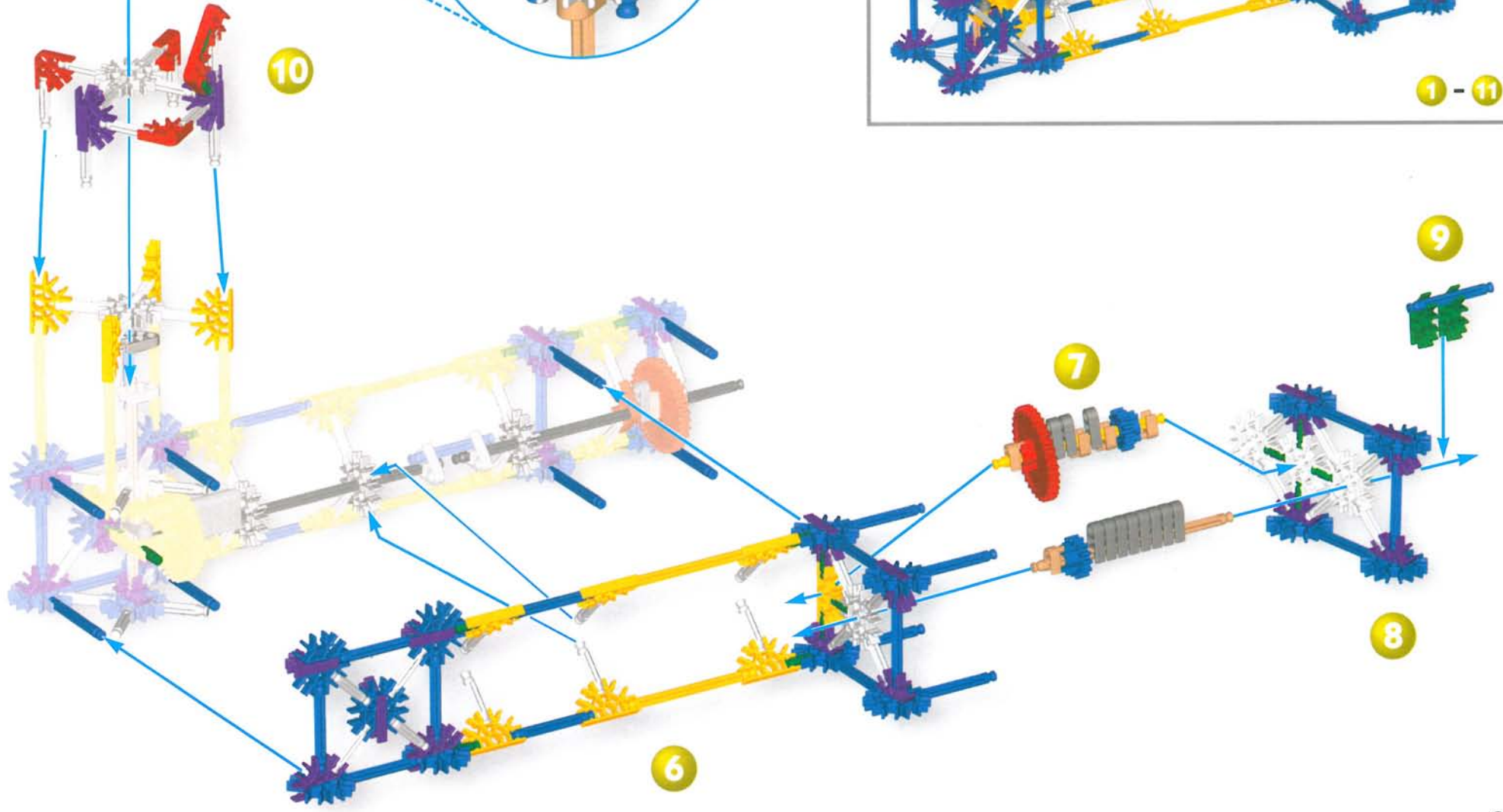
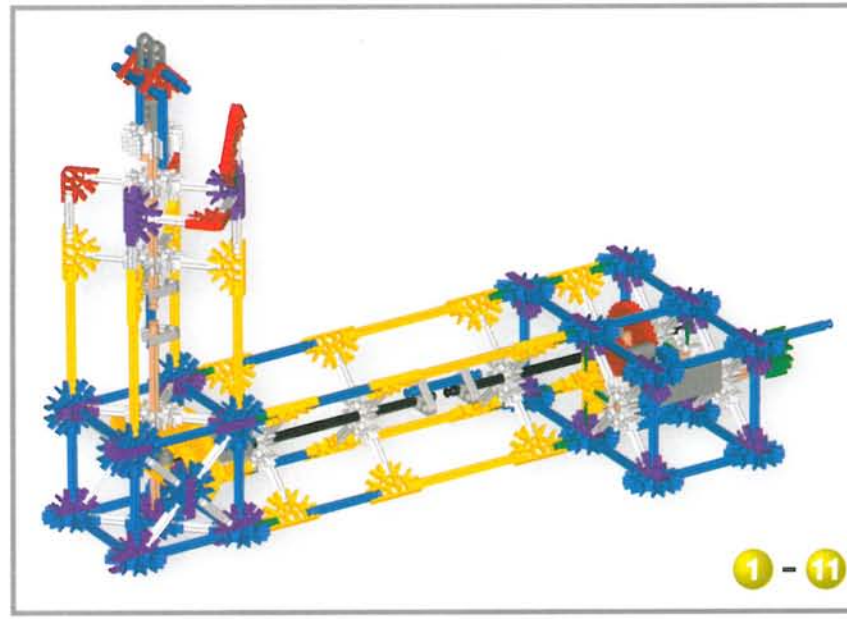
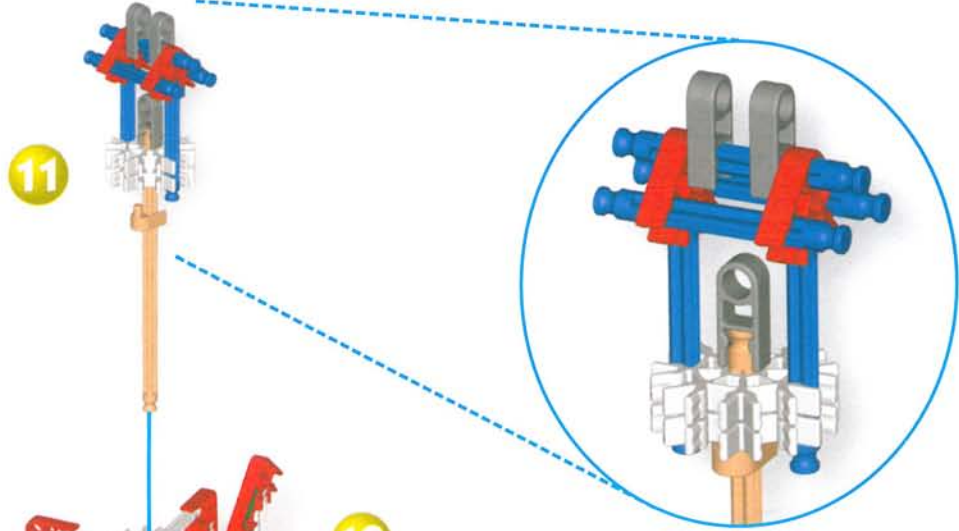

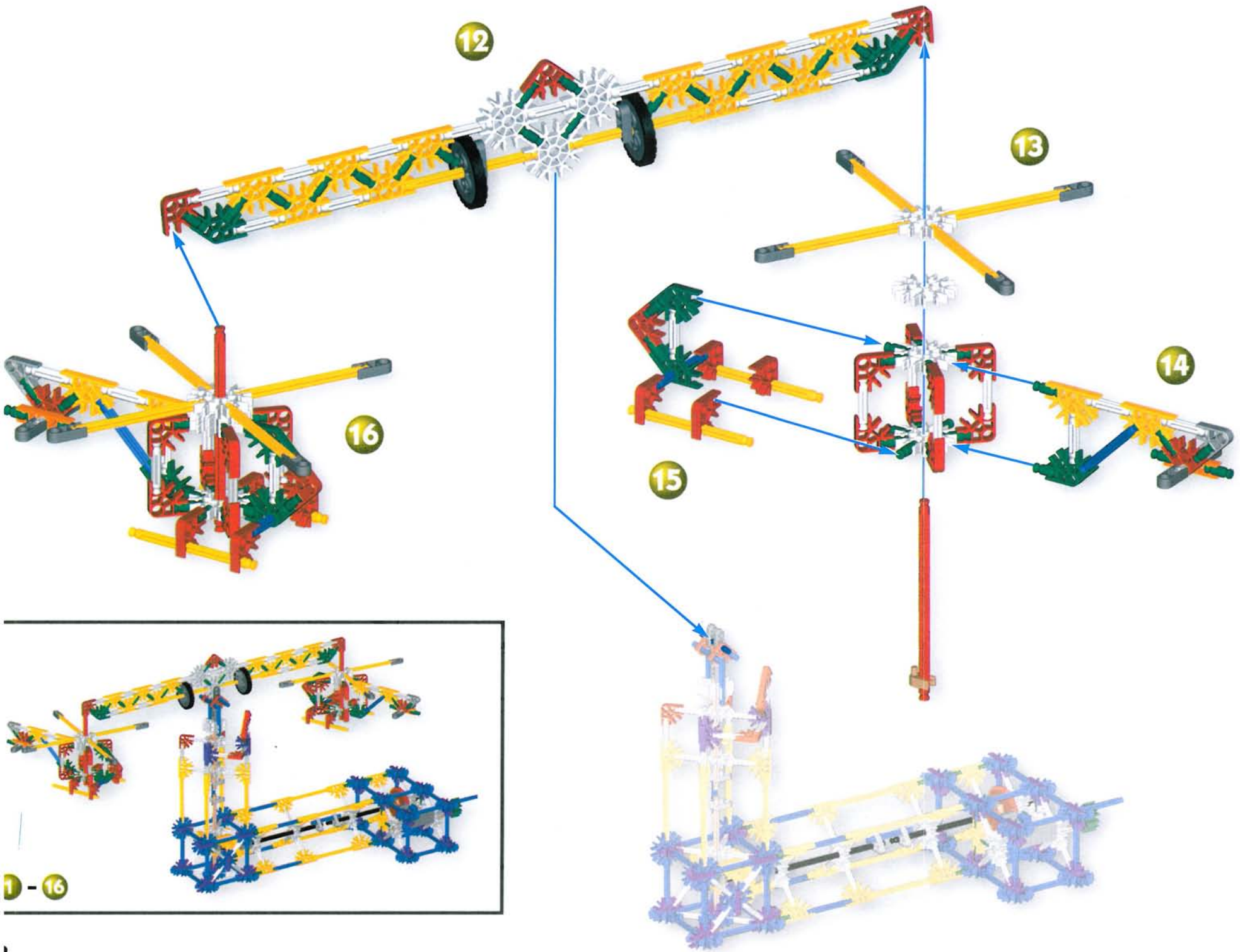

 **K'NEX**  
MOTOR PACK  
INSTALLATION

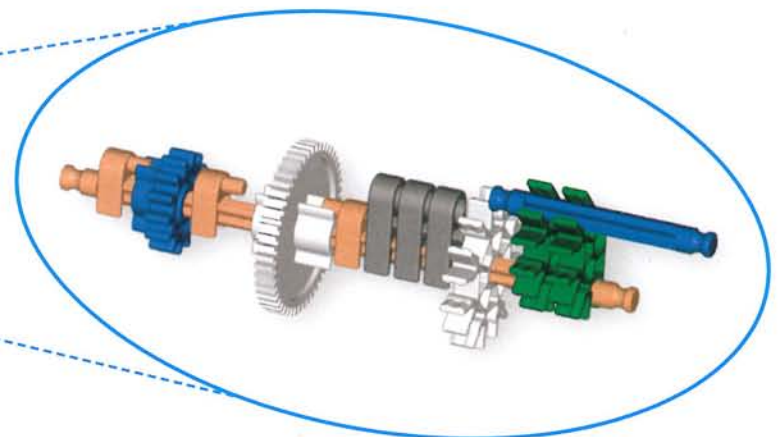
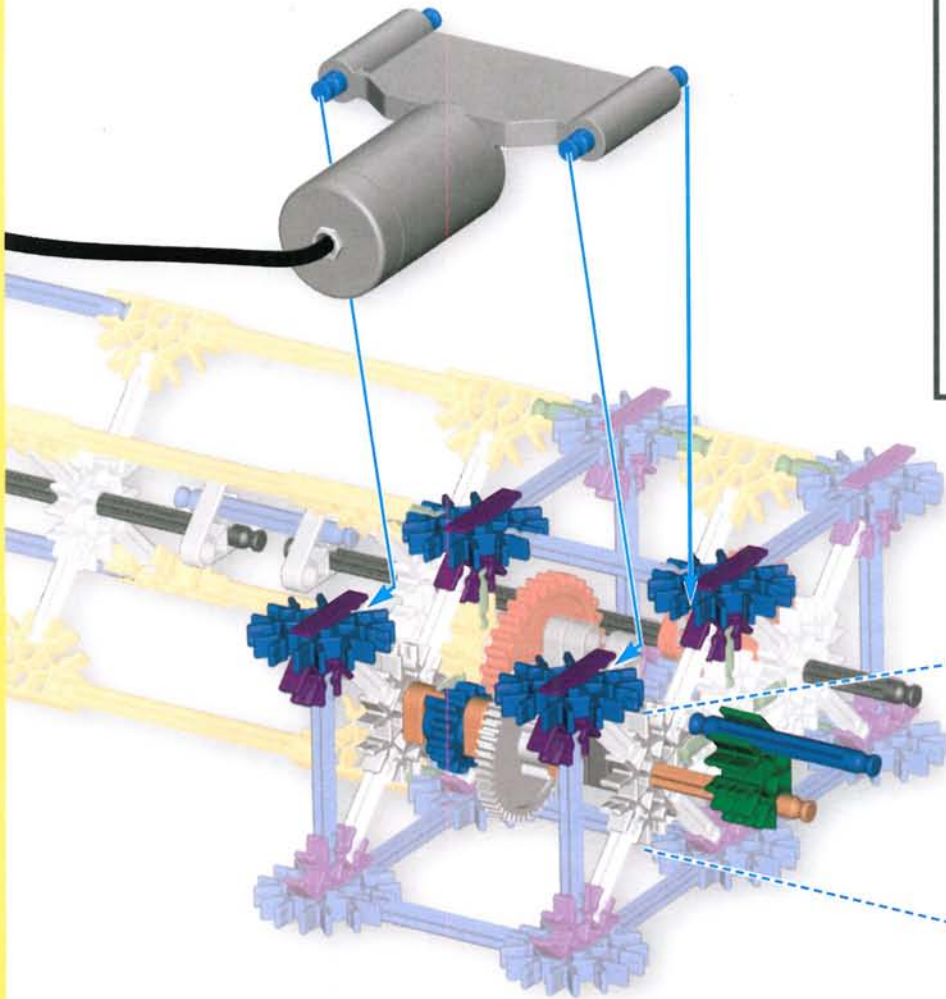

# Cordless Drill

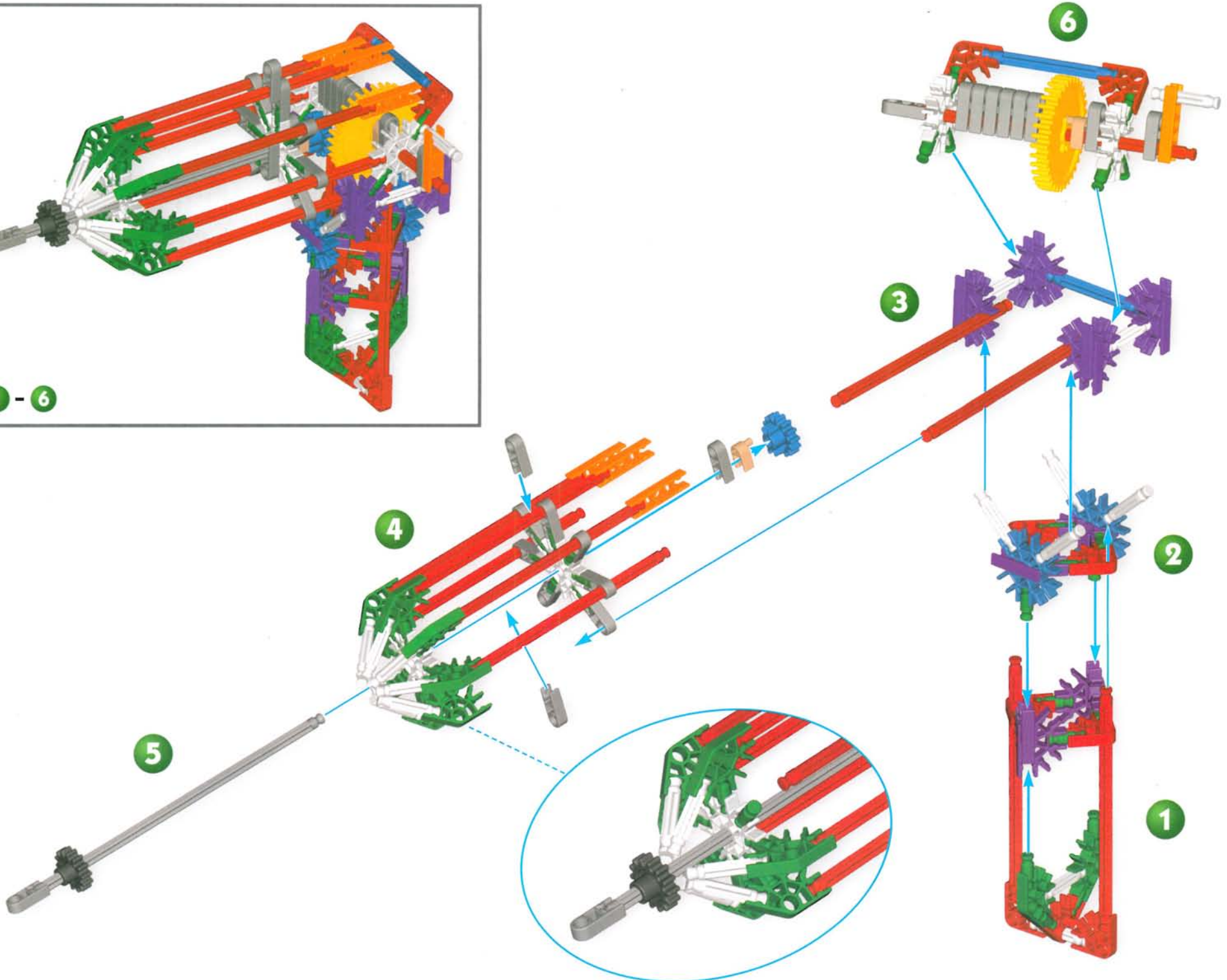
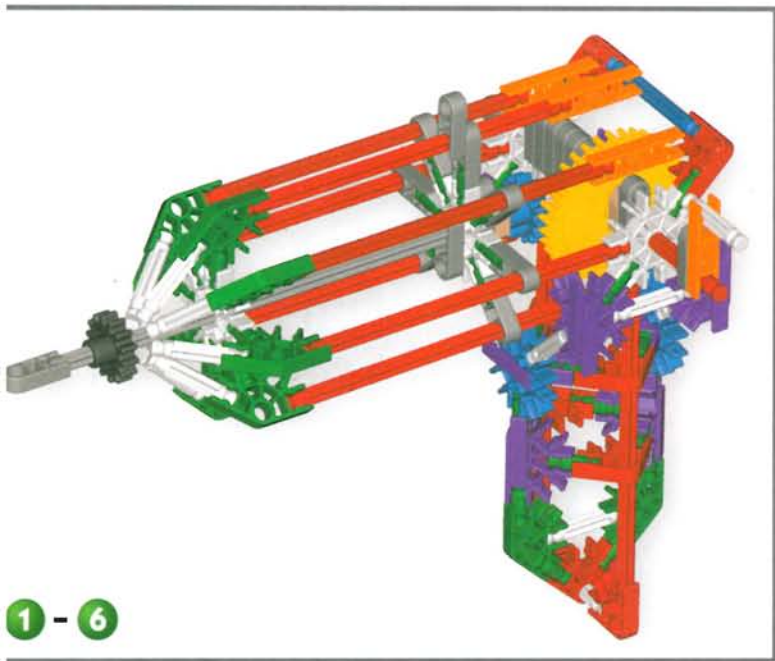

 **POWER**  
**PACK™**  
INSTALLATION

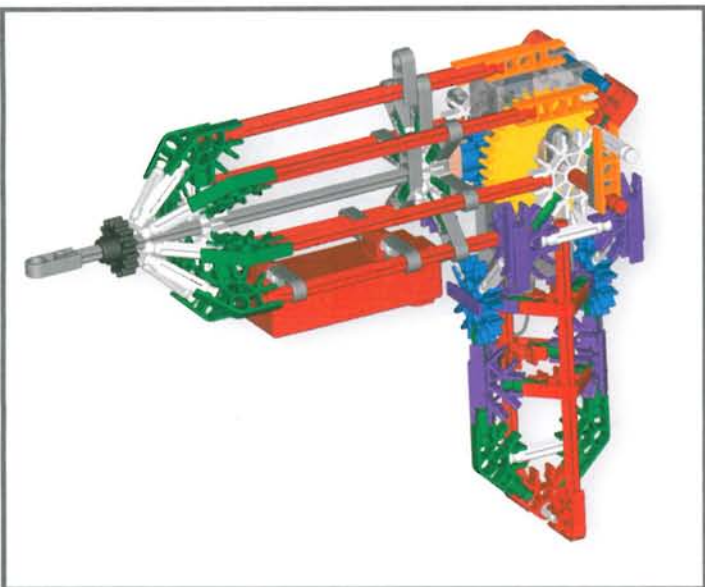
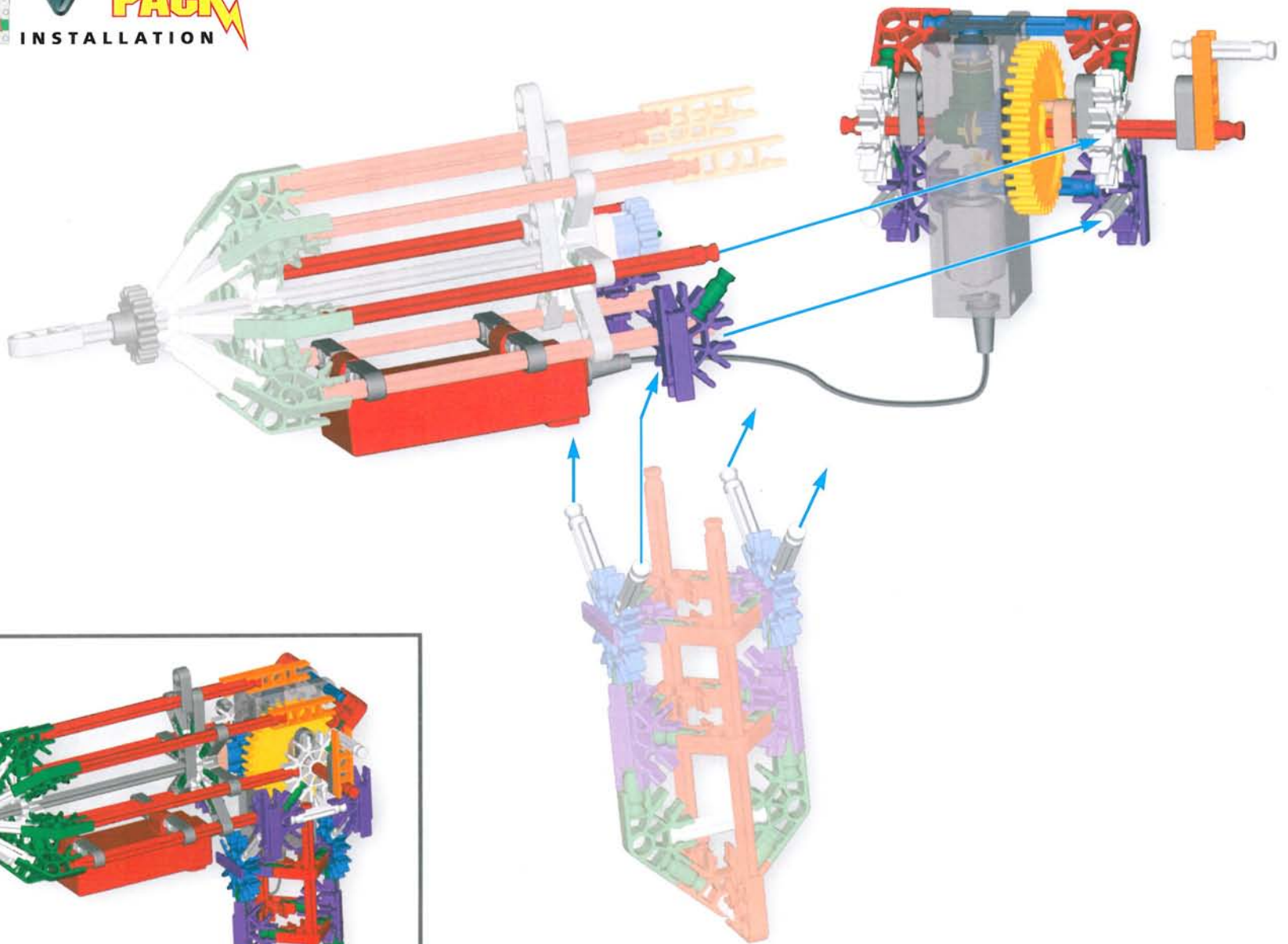

# Paddle Windmill

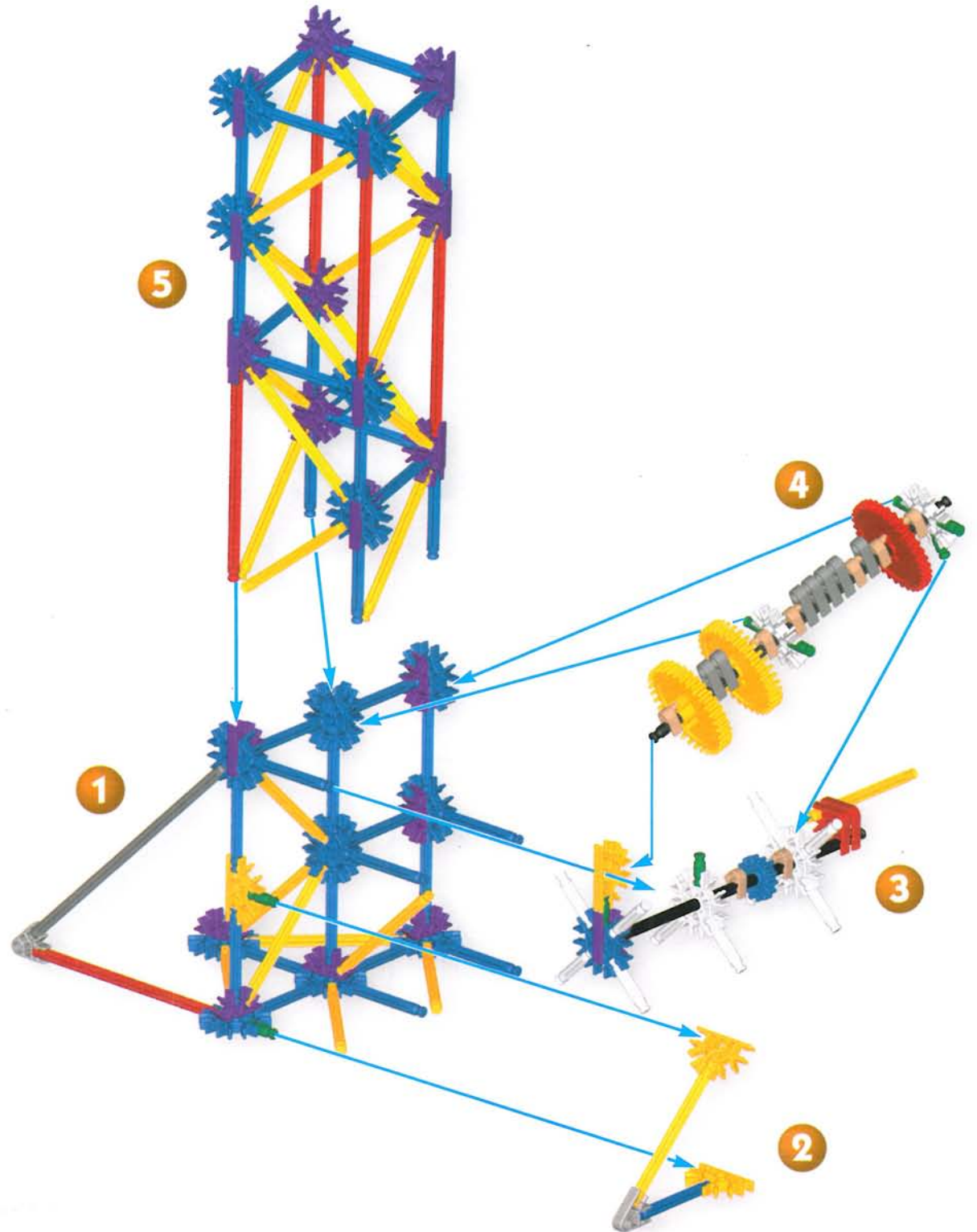
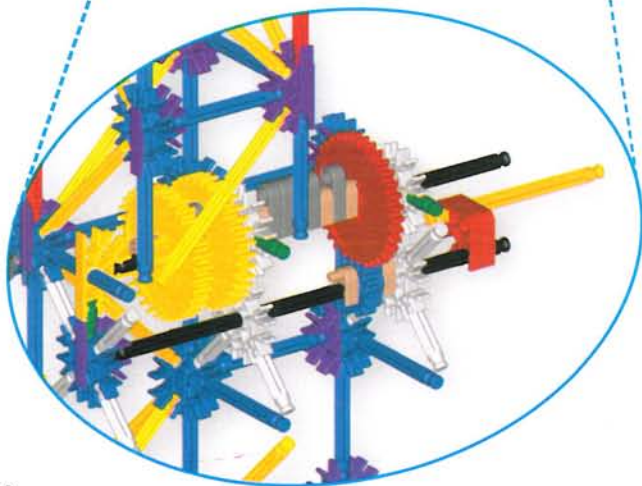
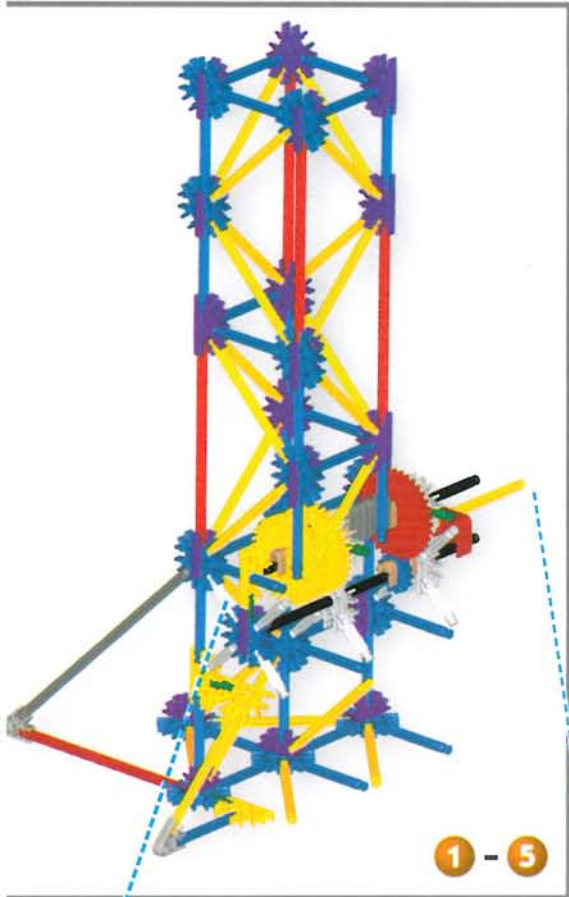

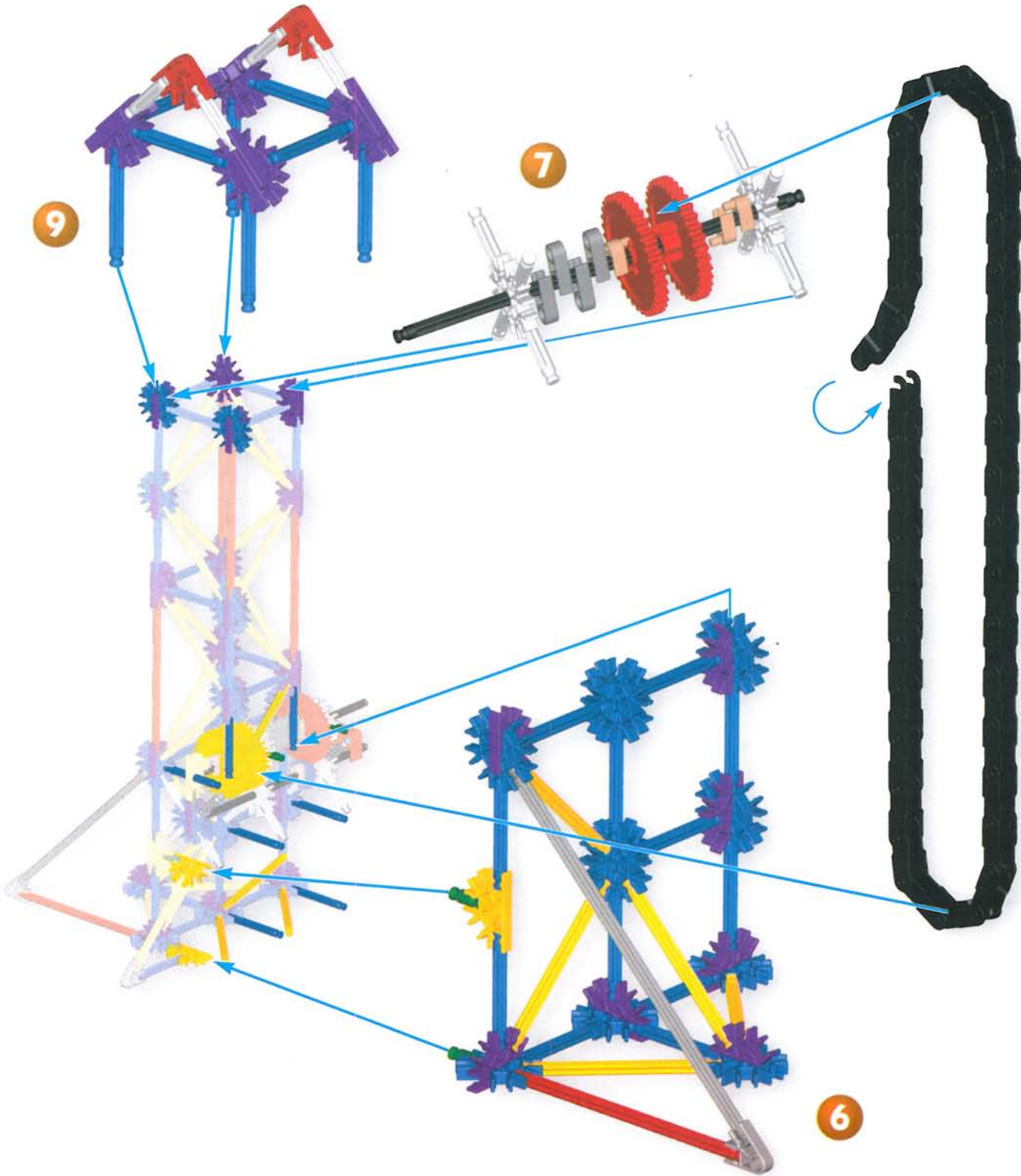

 x36

8



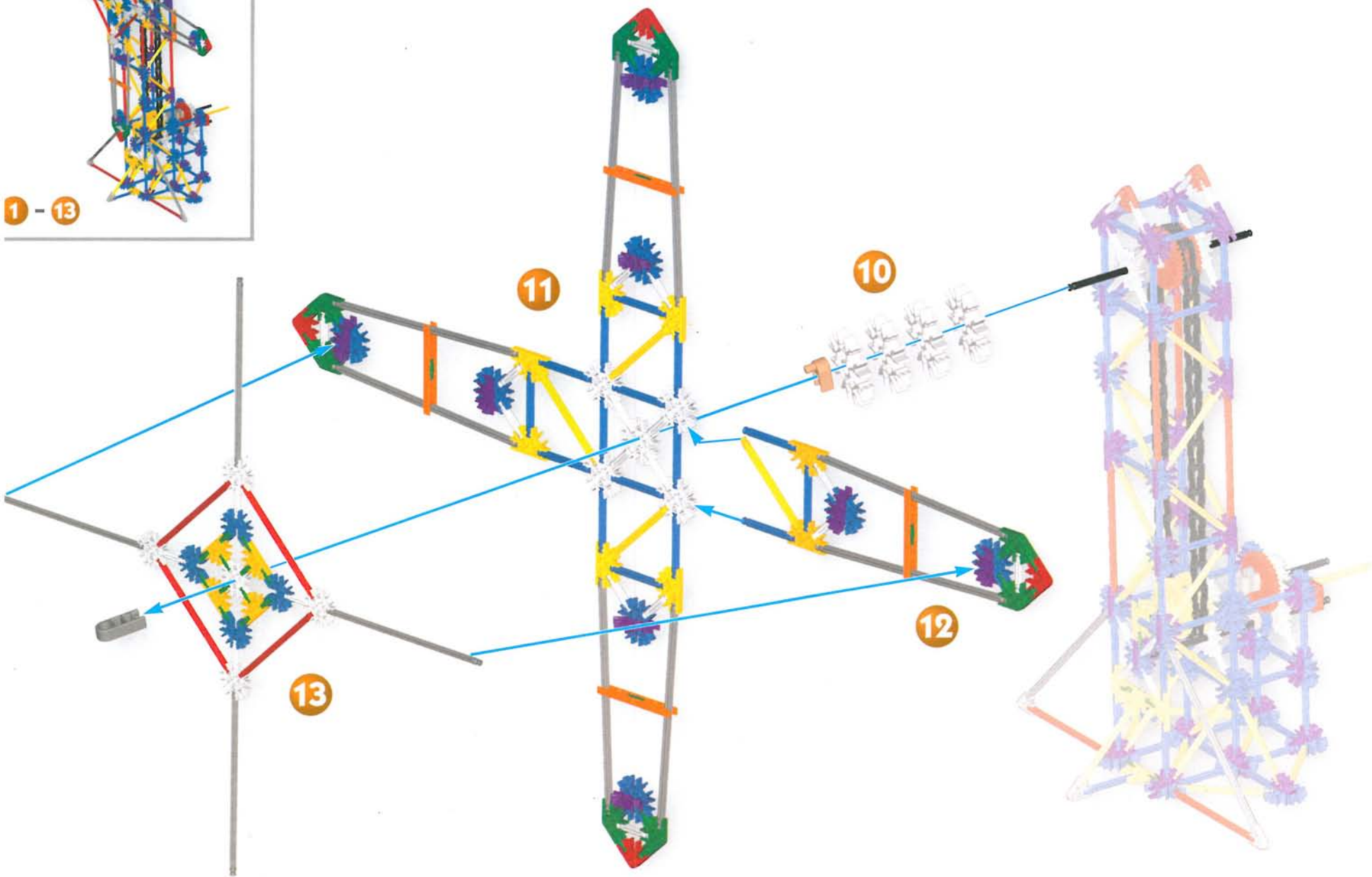

 **K'NEX**  
MOTOR PACK  
INSTALLATION

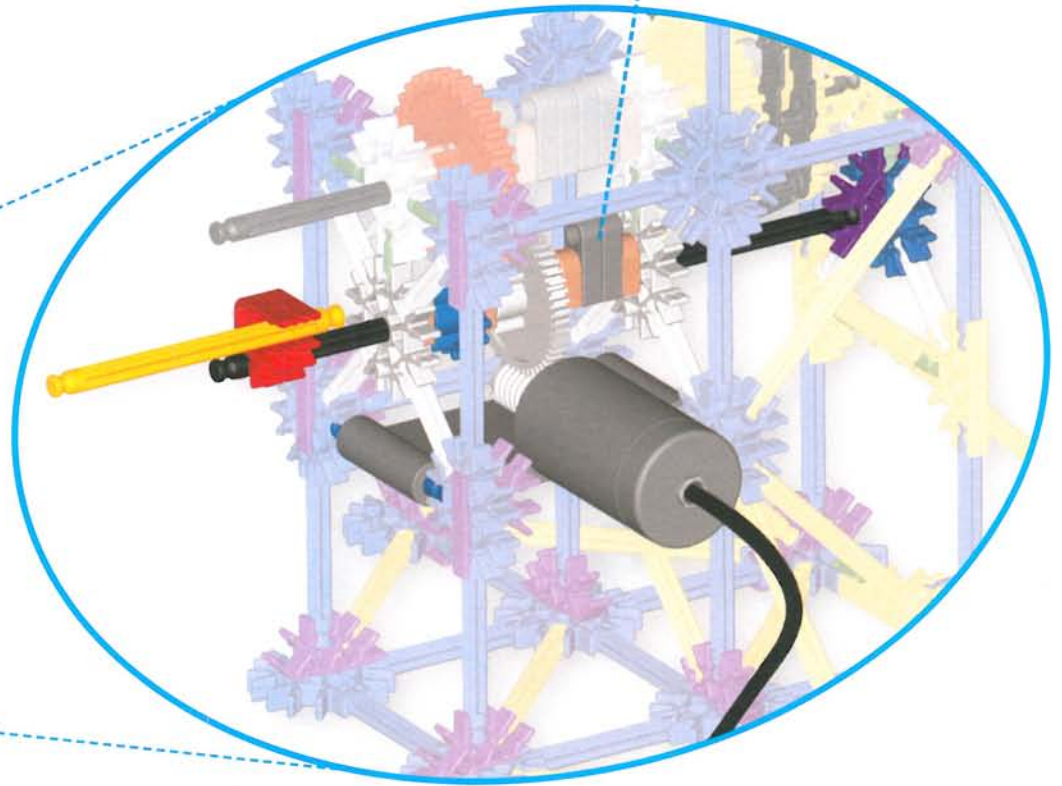
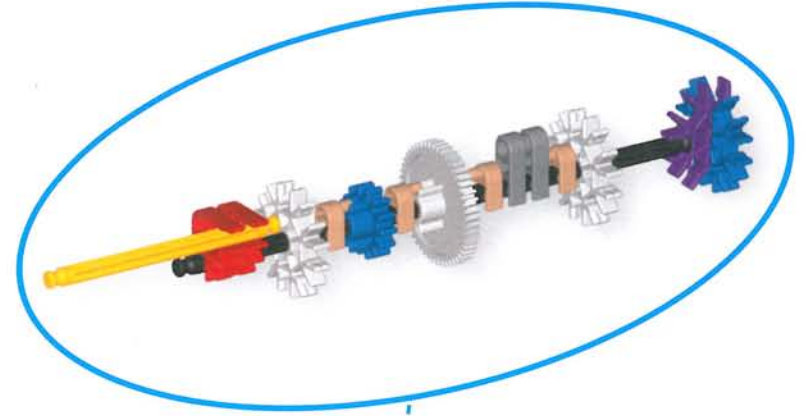
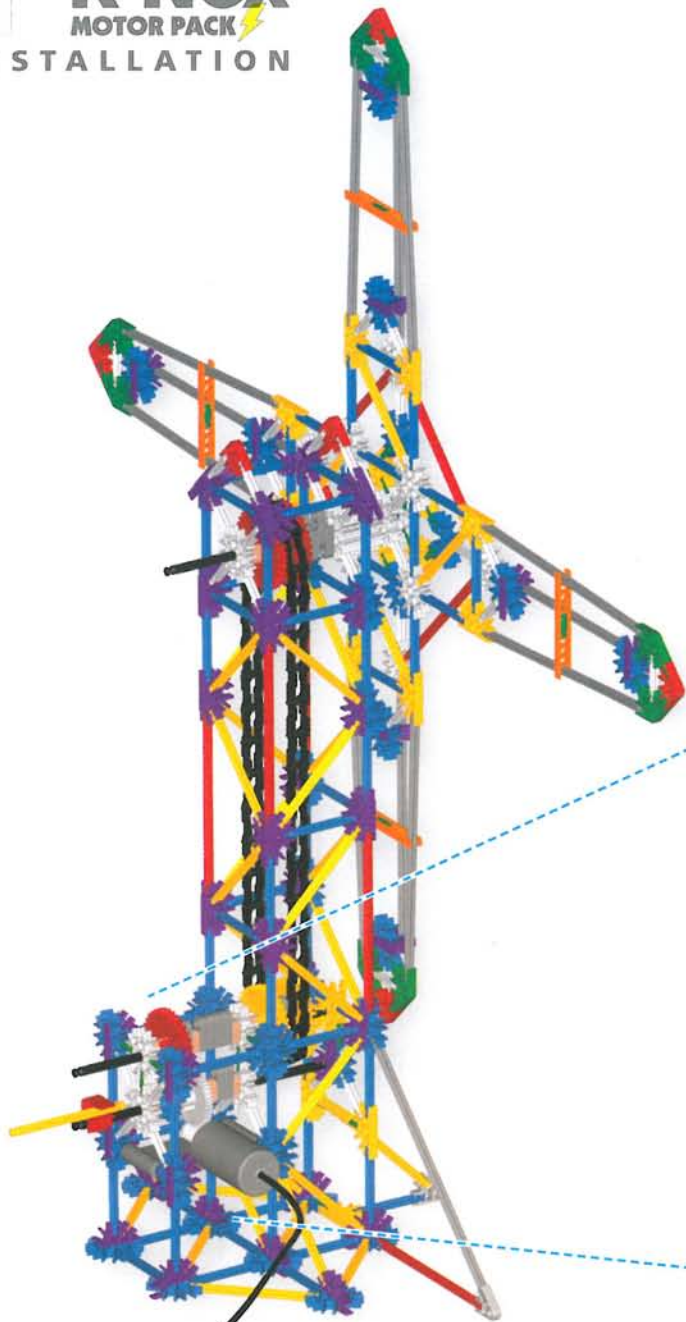

# Moon Rover

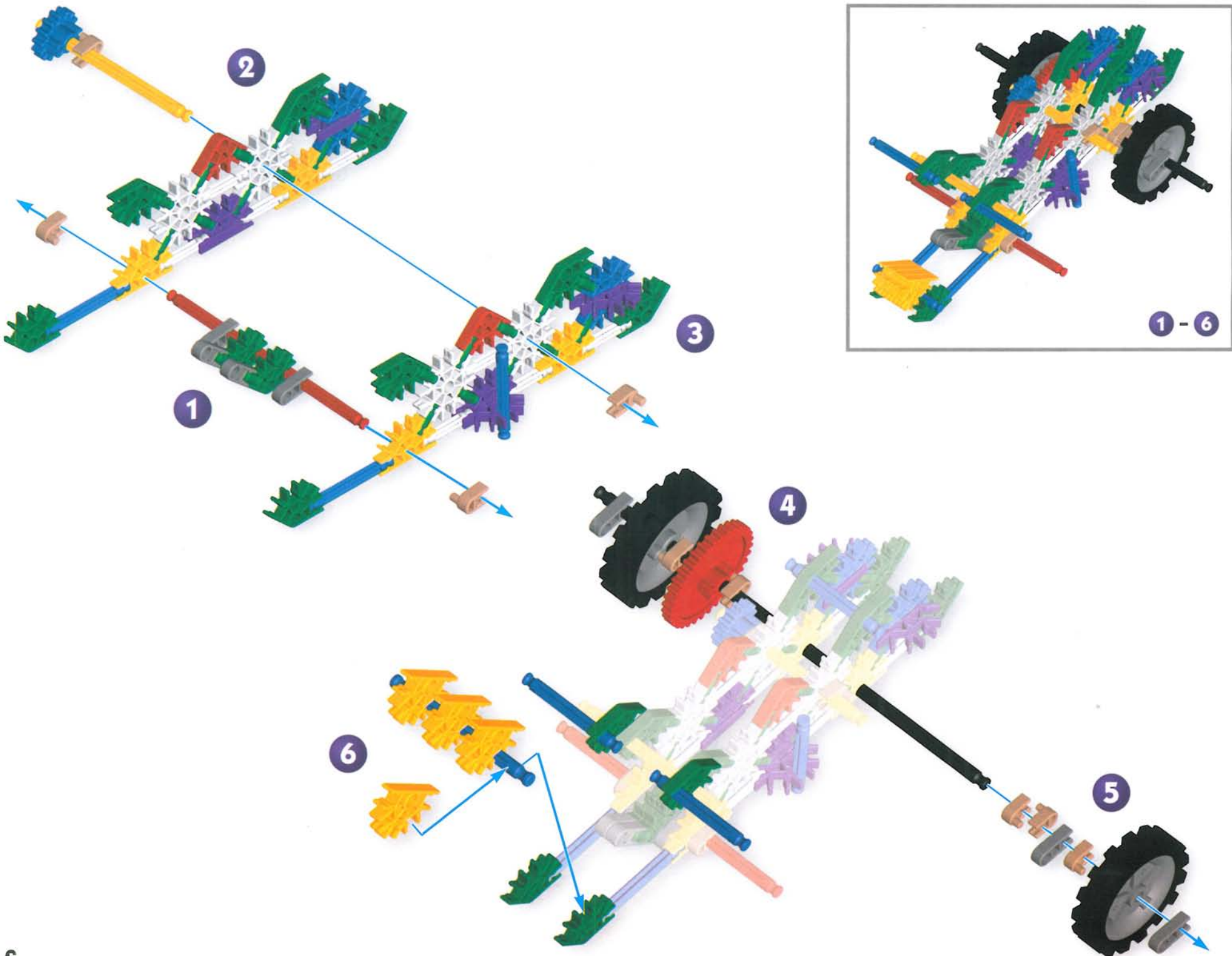

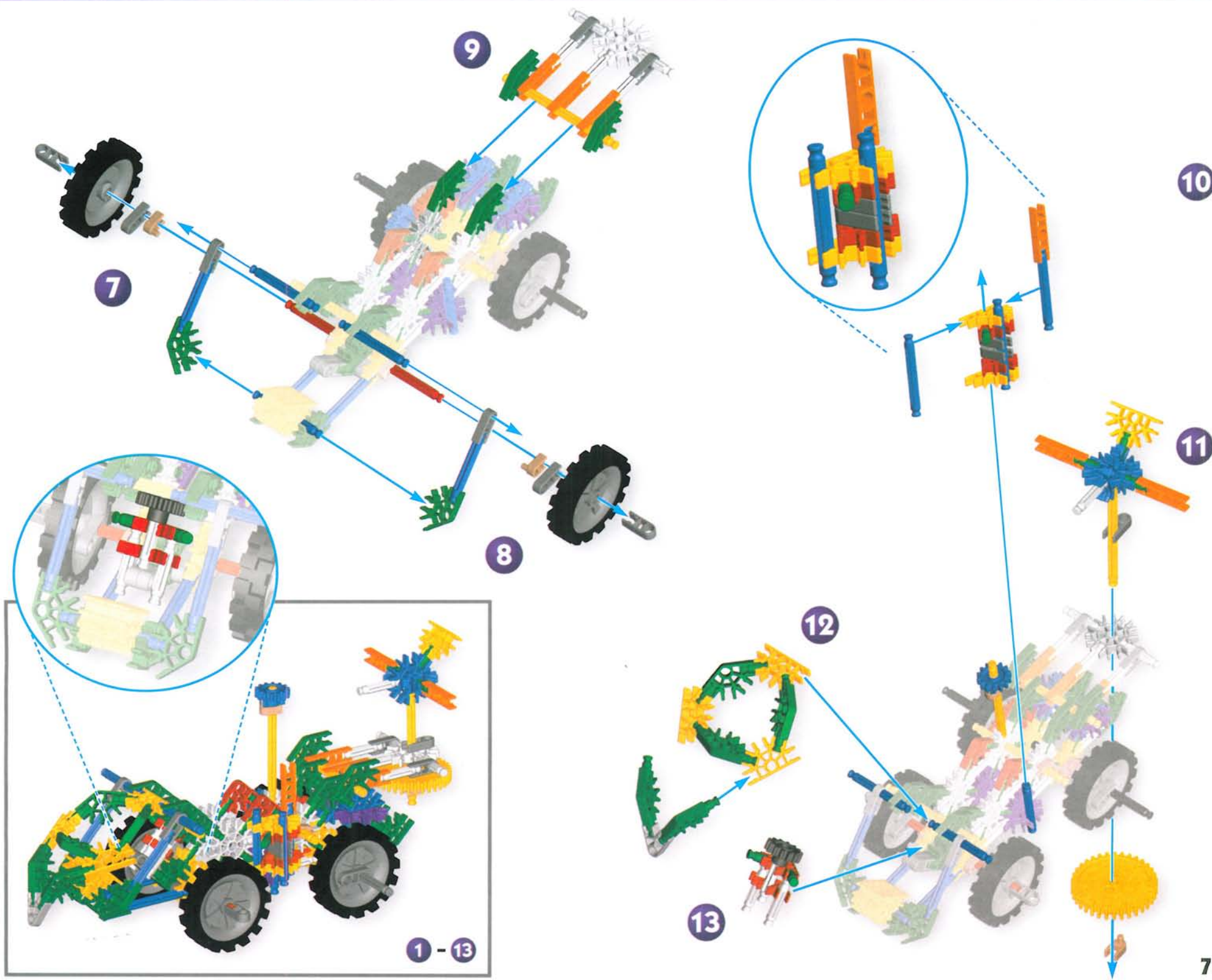

 **POWER  
PACK™**  
INSTALLATION

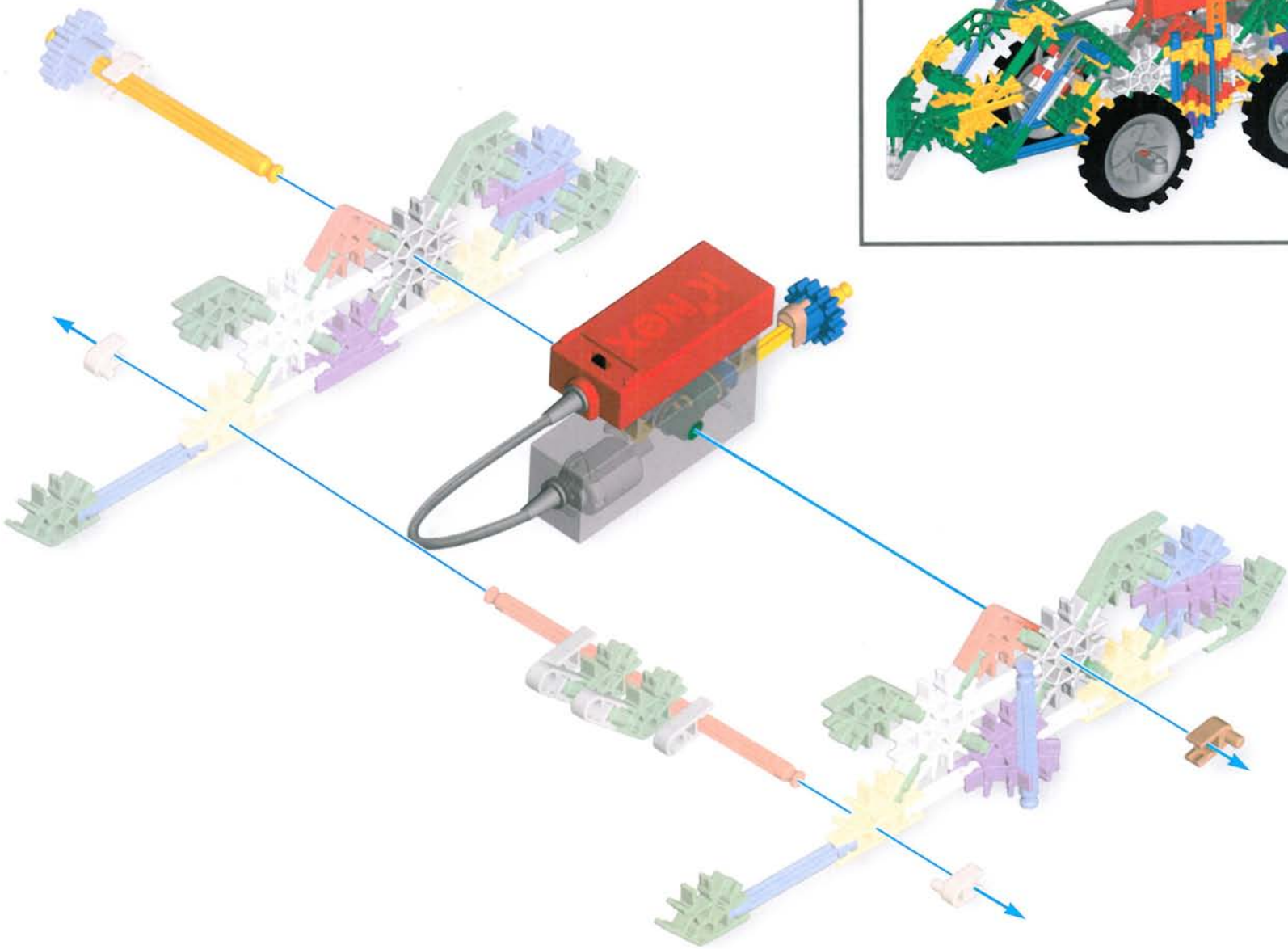

# Fancy Ferris Wheel

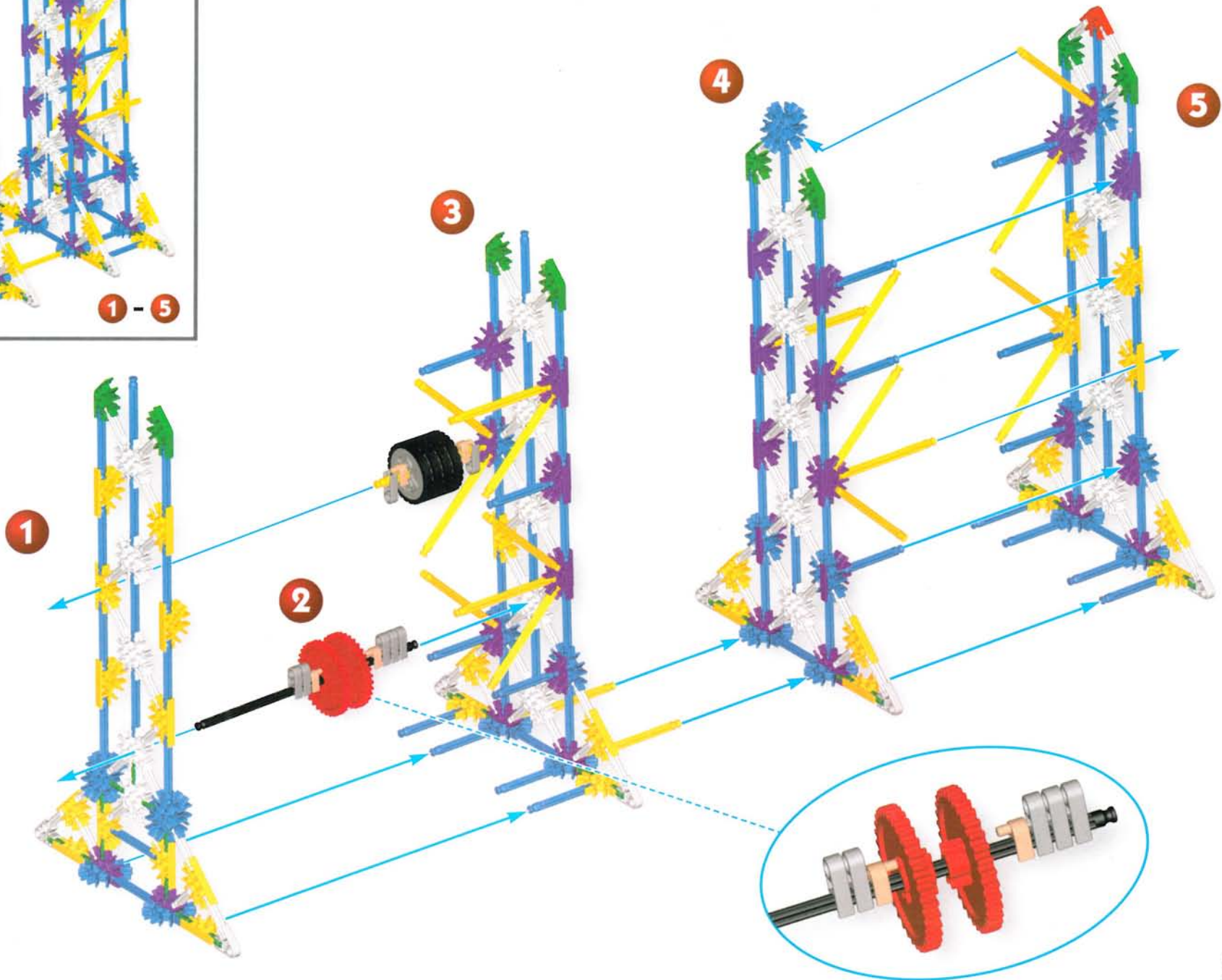
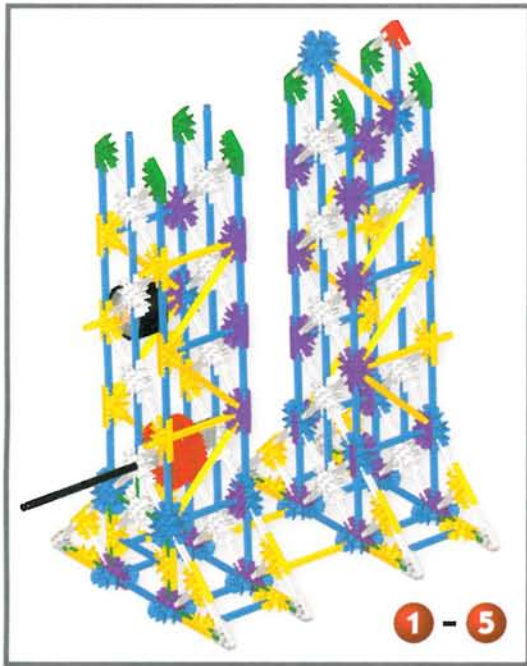

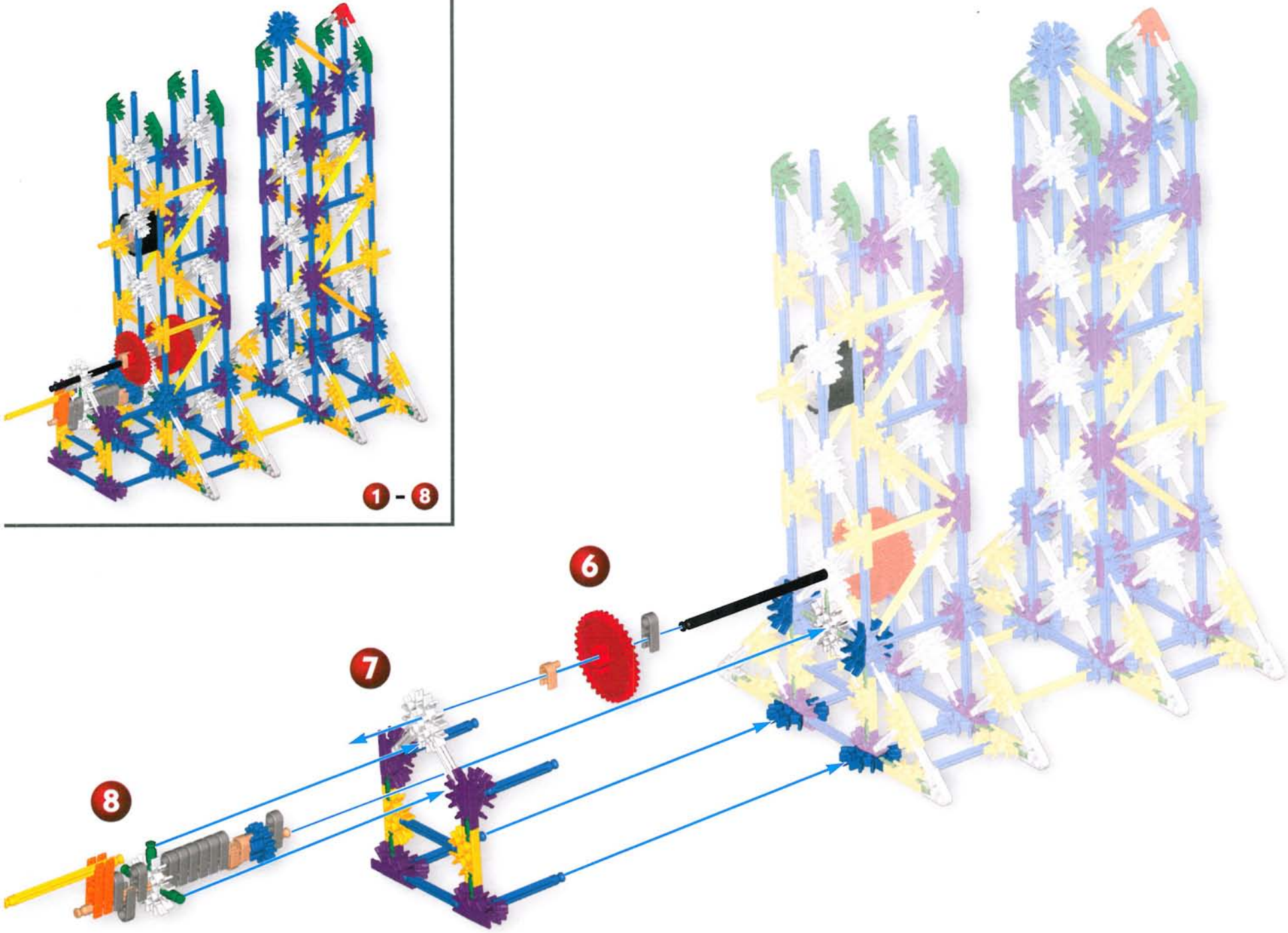

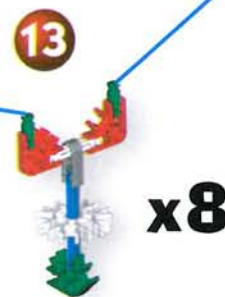
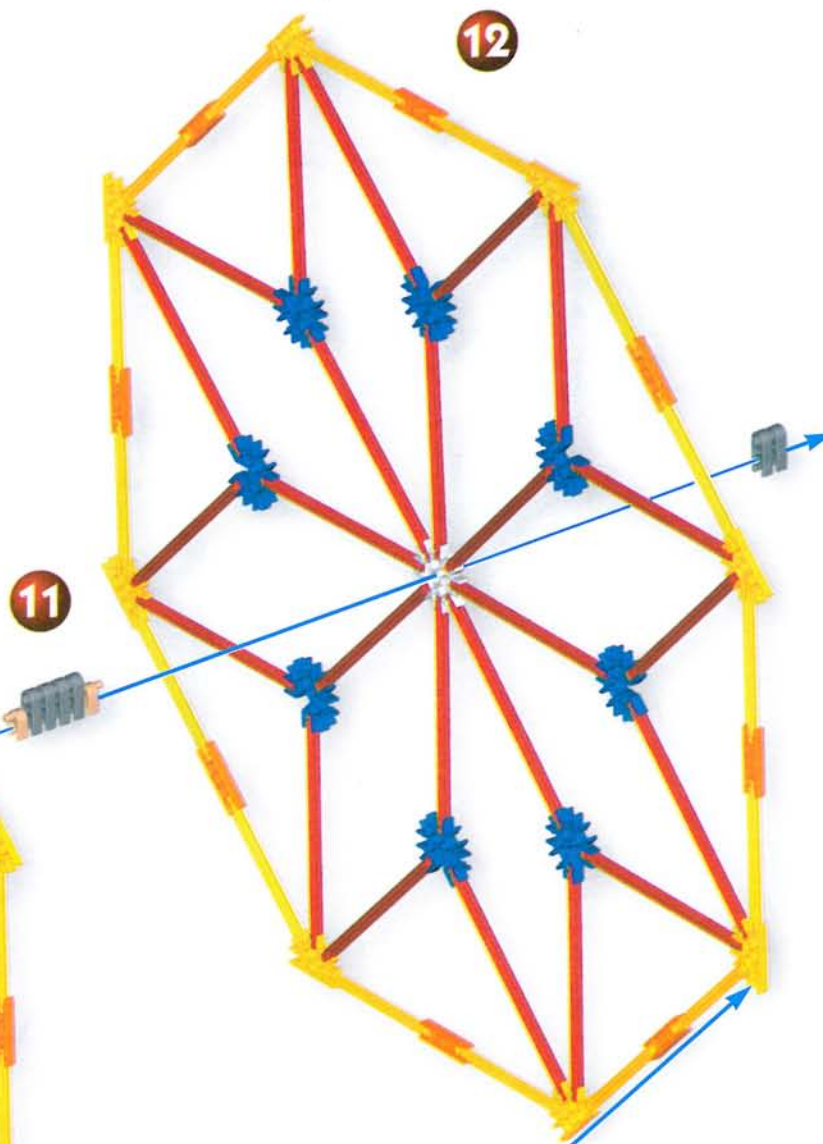
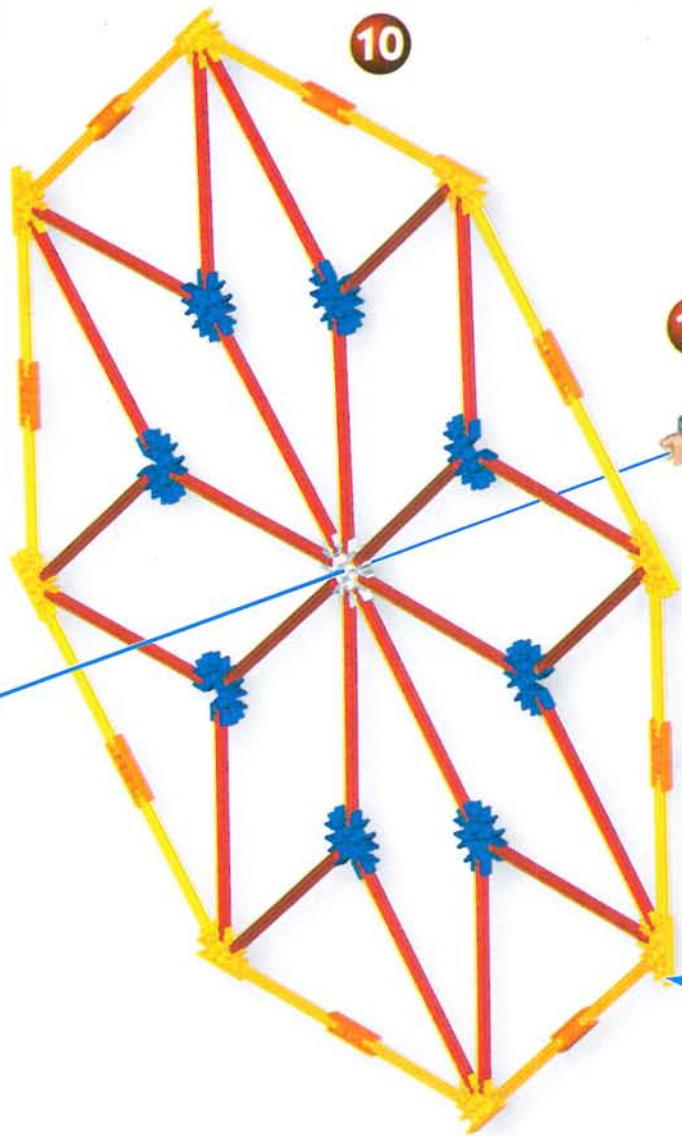
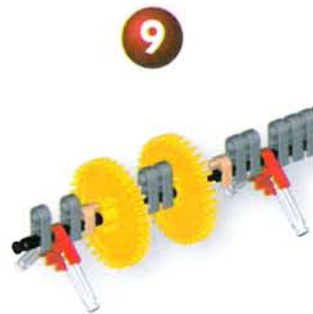
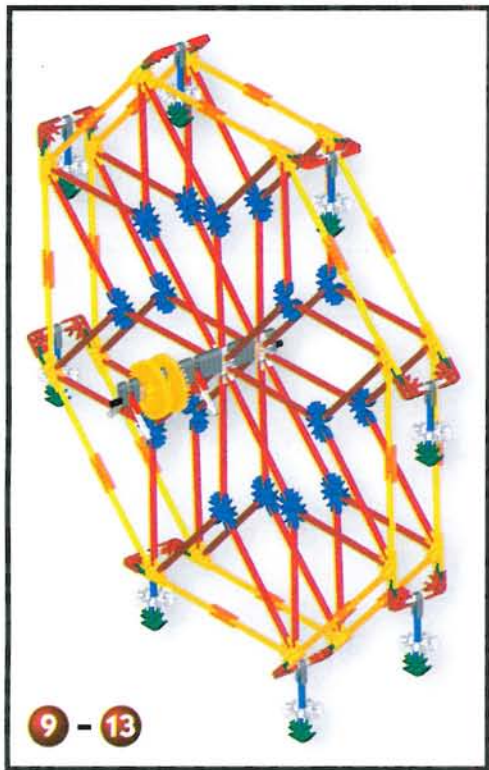

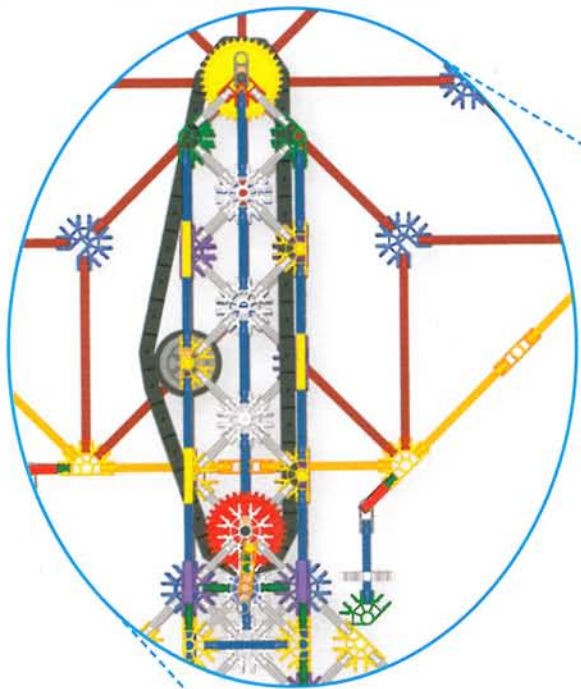

14

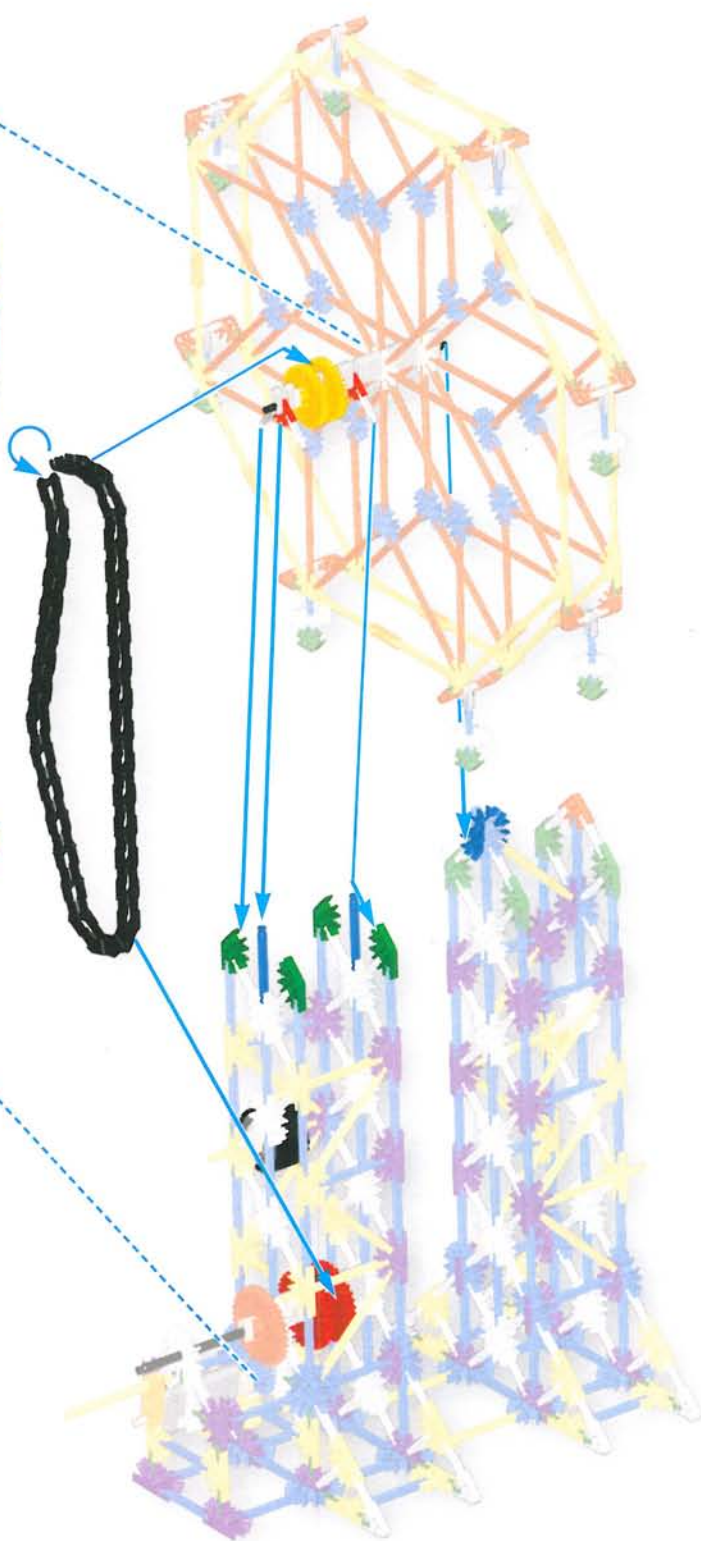

 x33

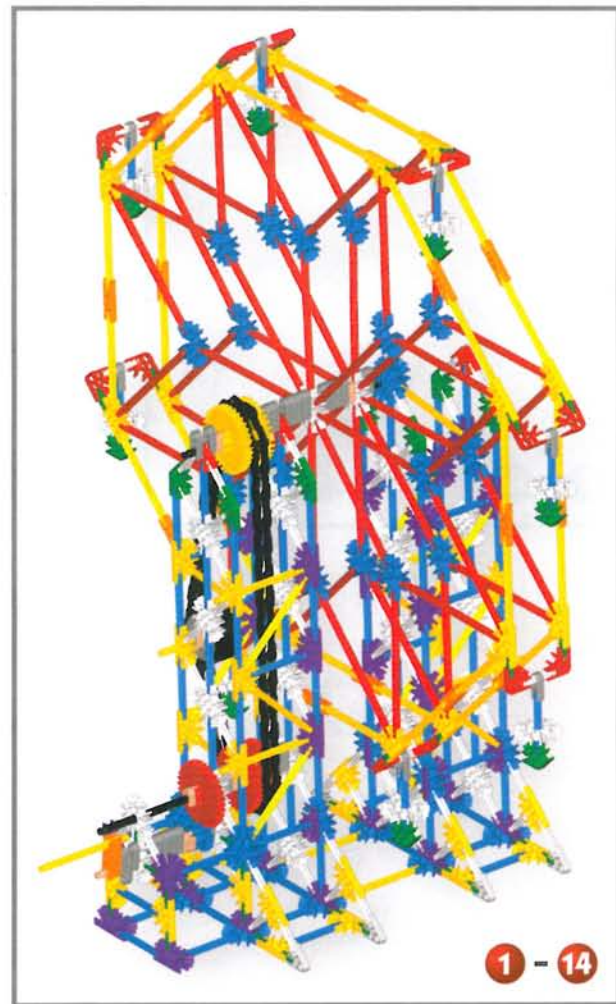

1 - 14

 **K'NEX**  
MOTOR PACK  
INSTALLATION

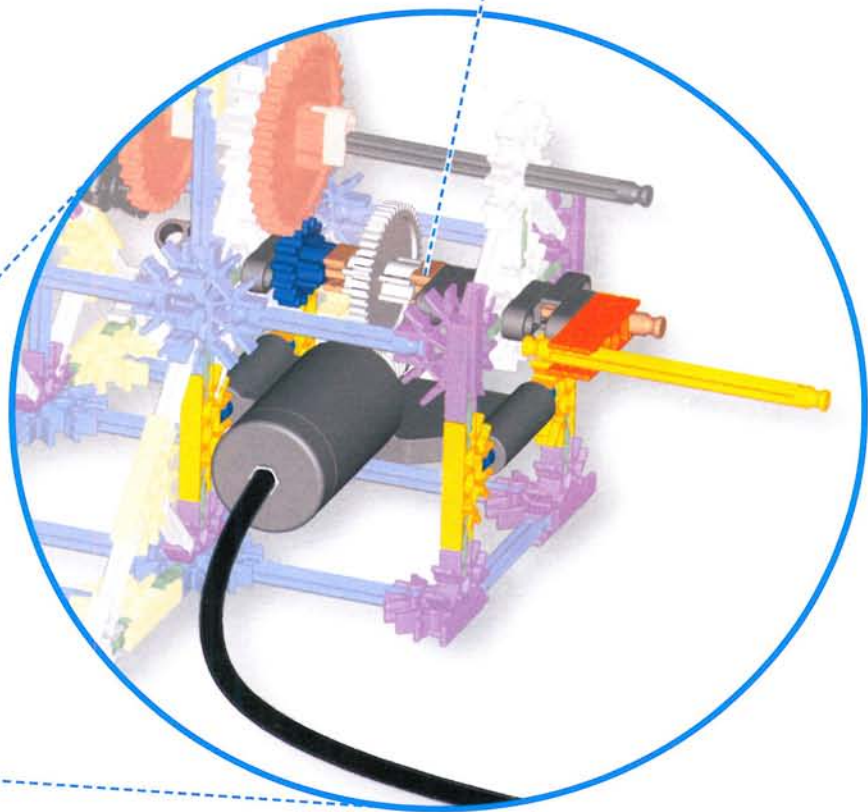
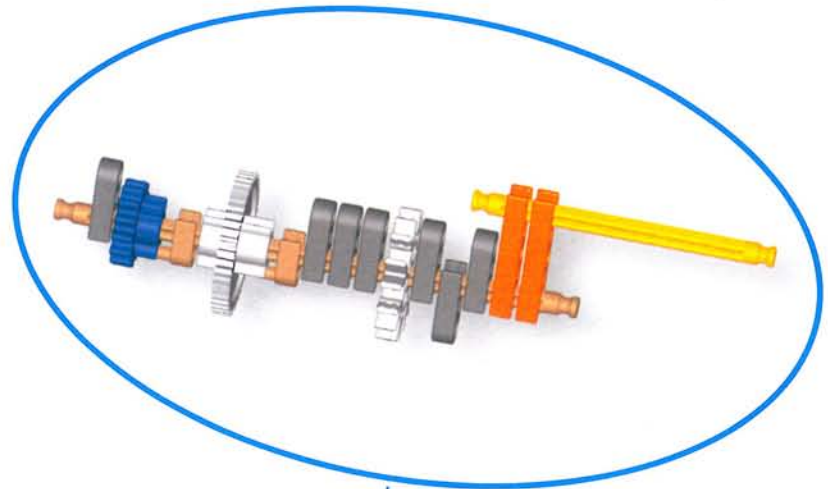
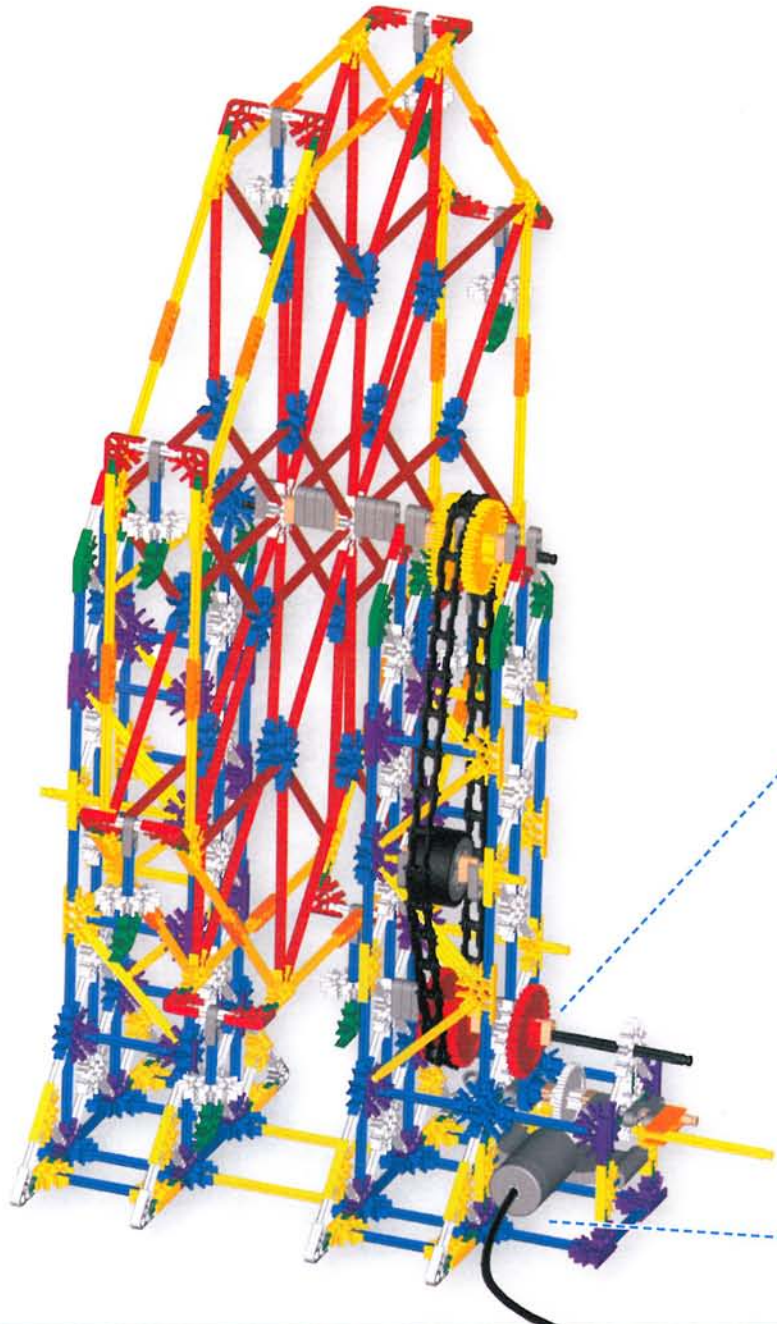

# Salt & Pepper Ride

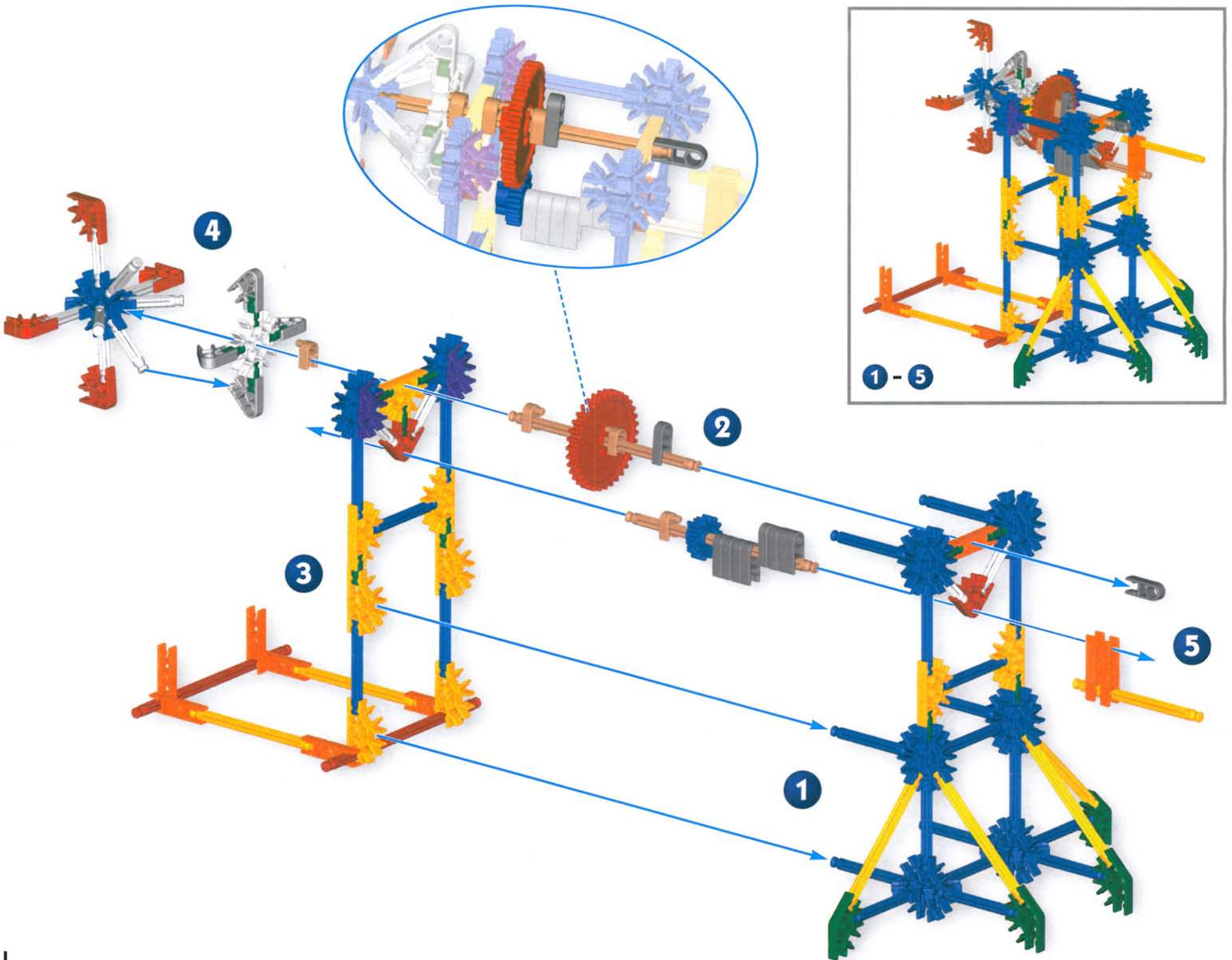

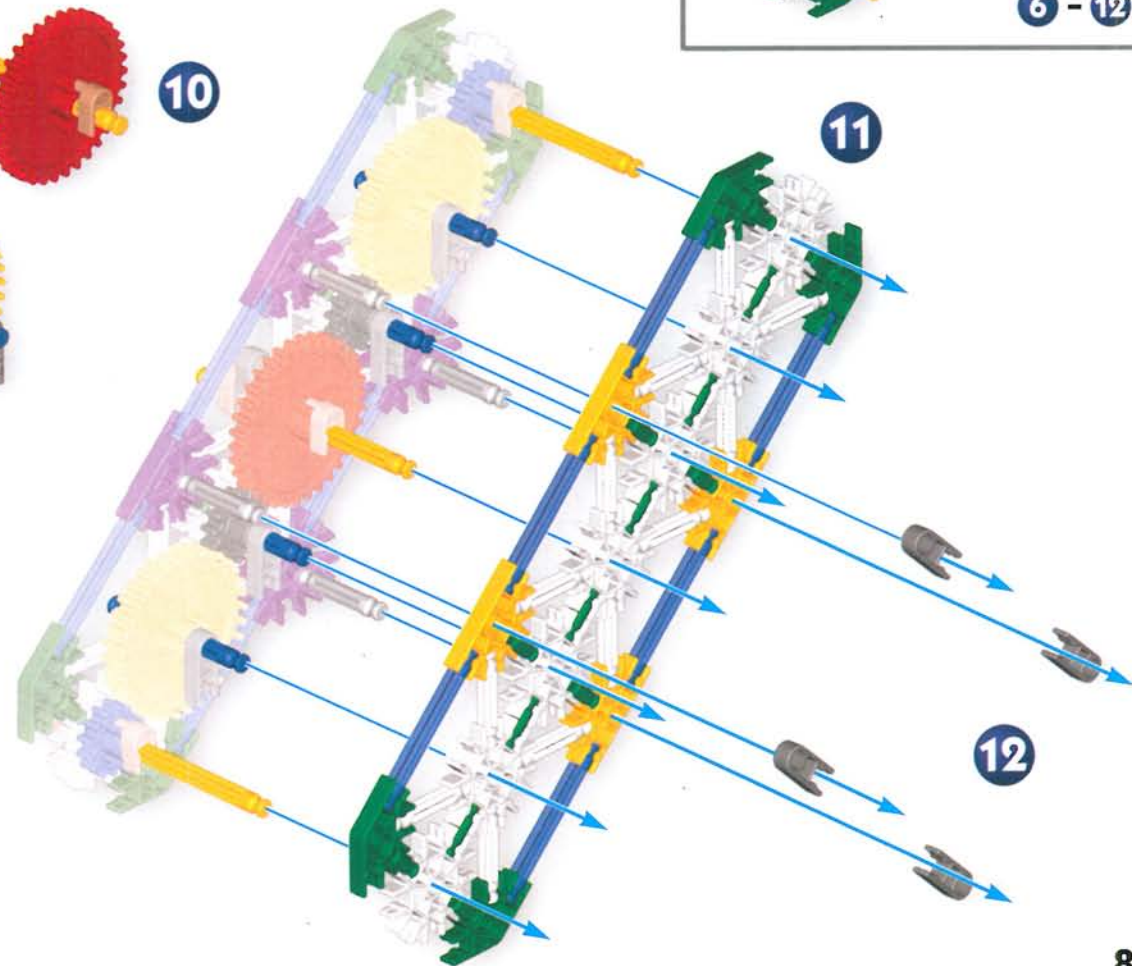
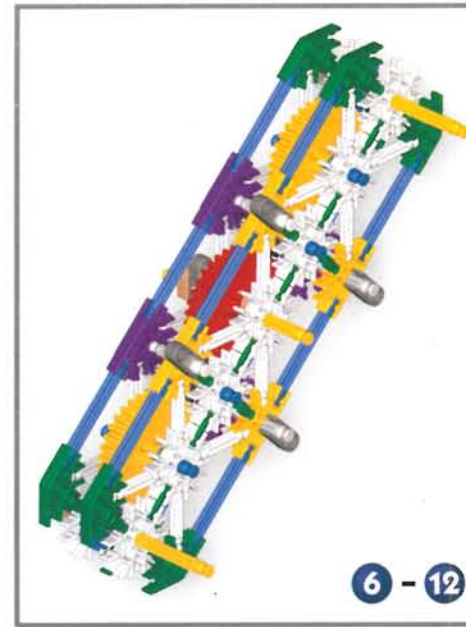
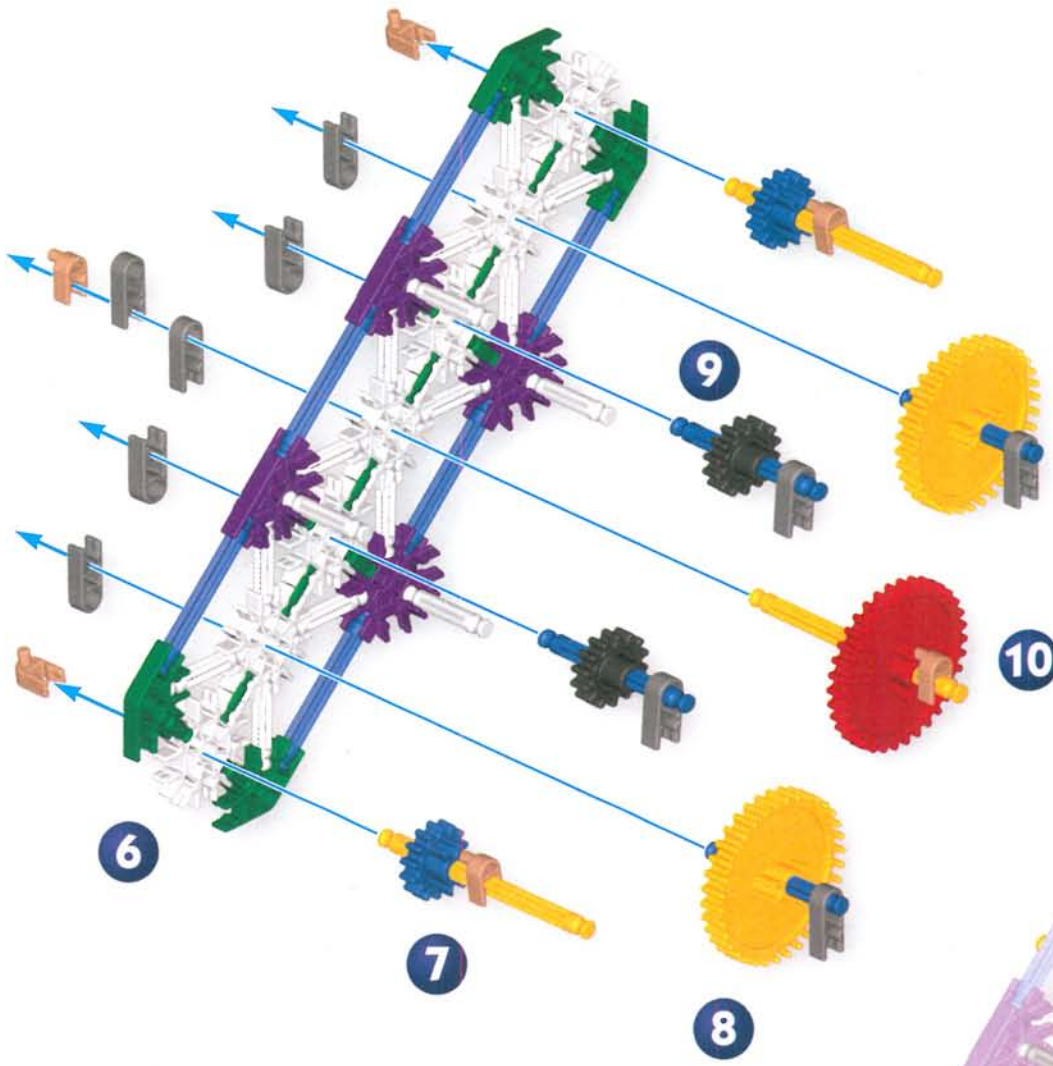

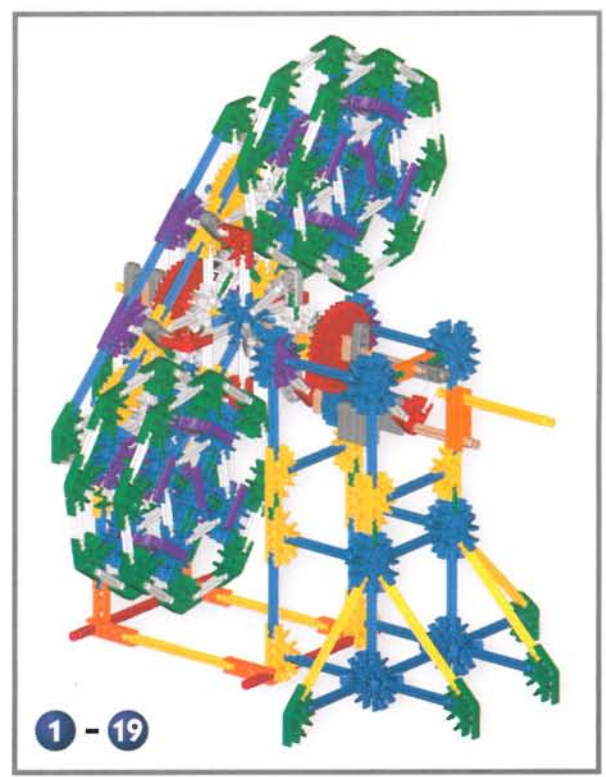
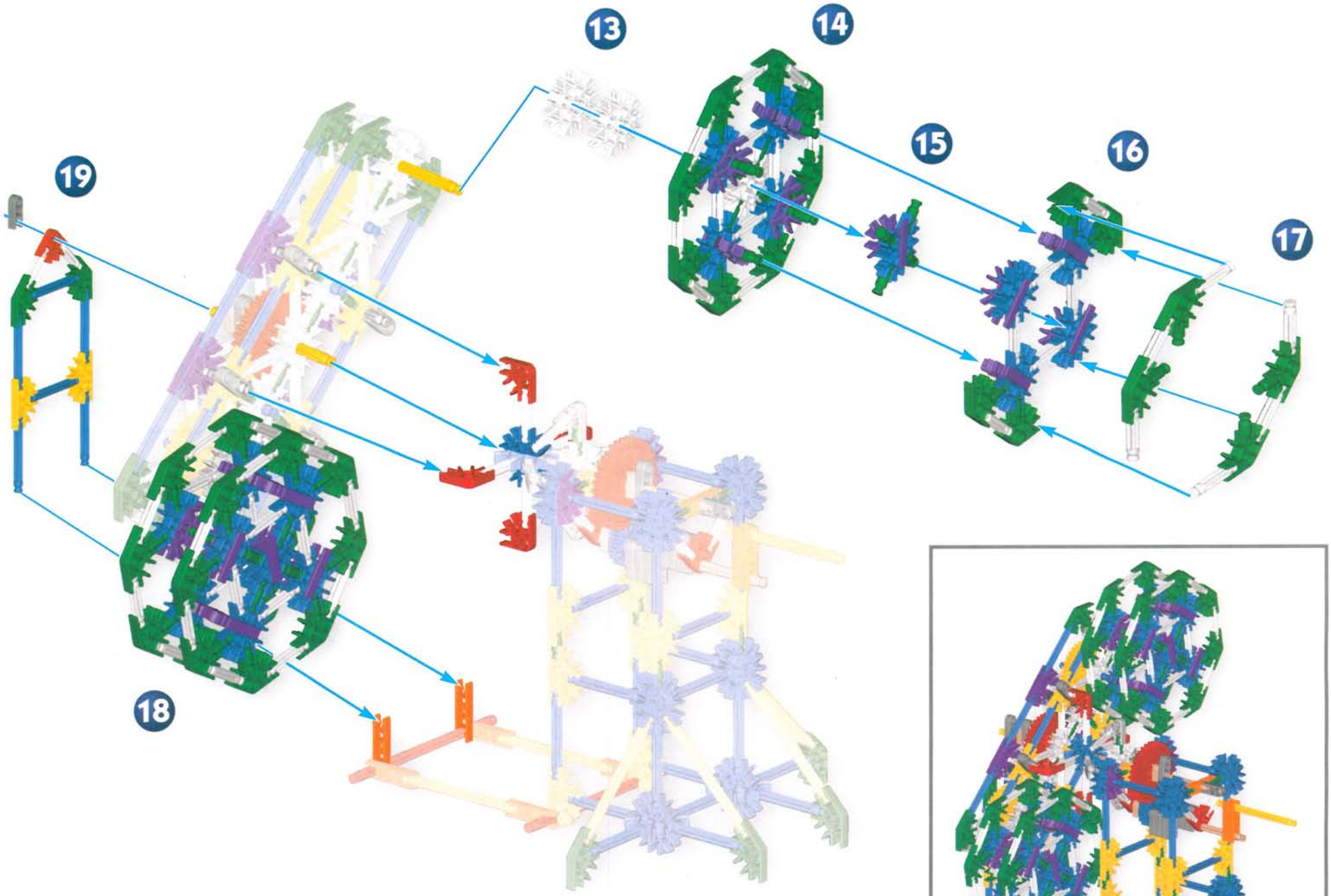



**K'NEX**  
MOTOR PACK

INSTALLATION

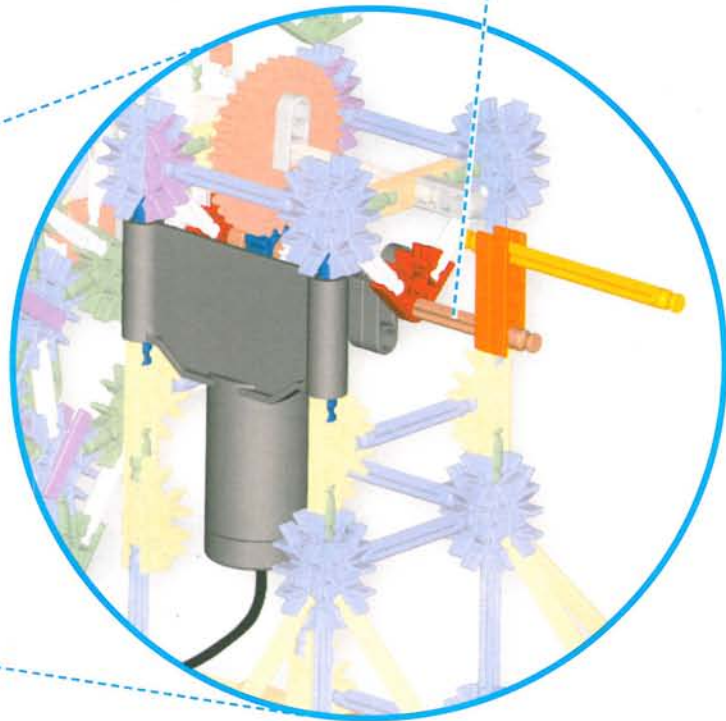
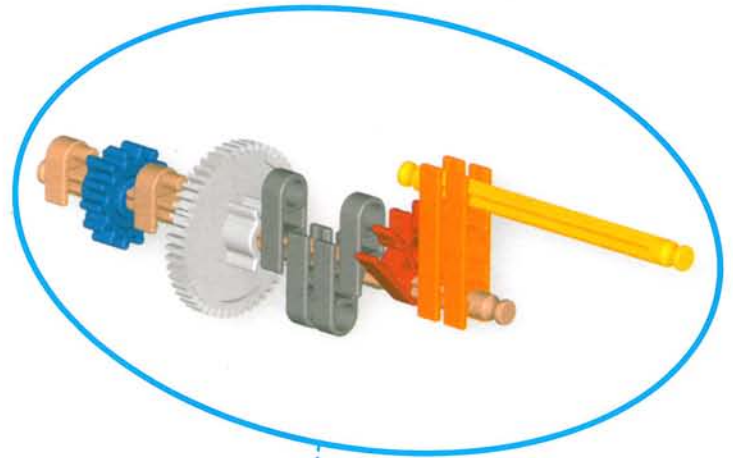
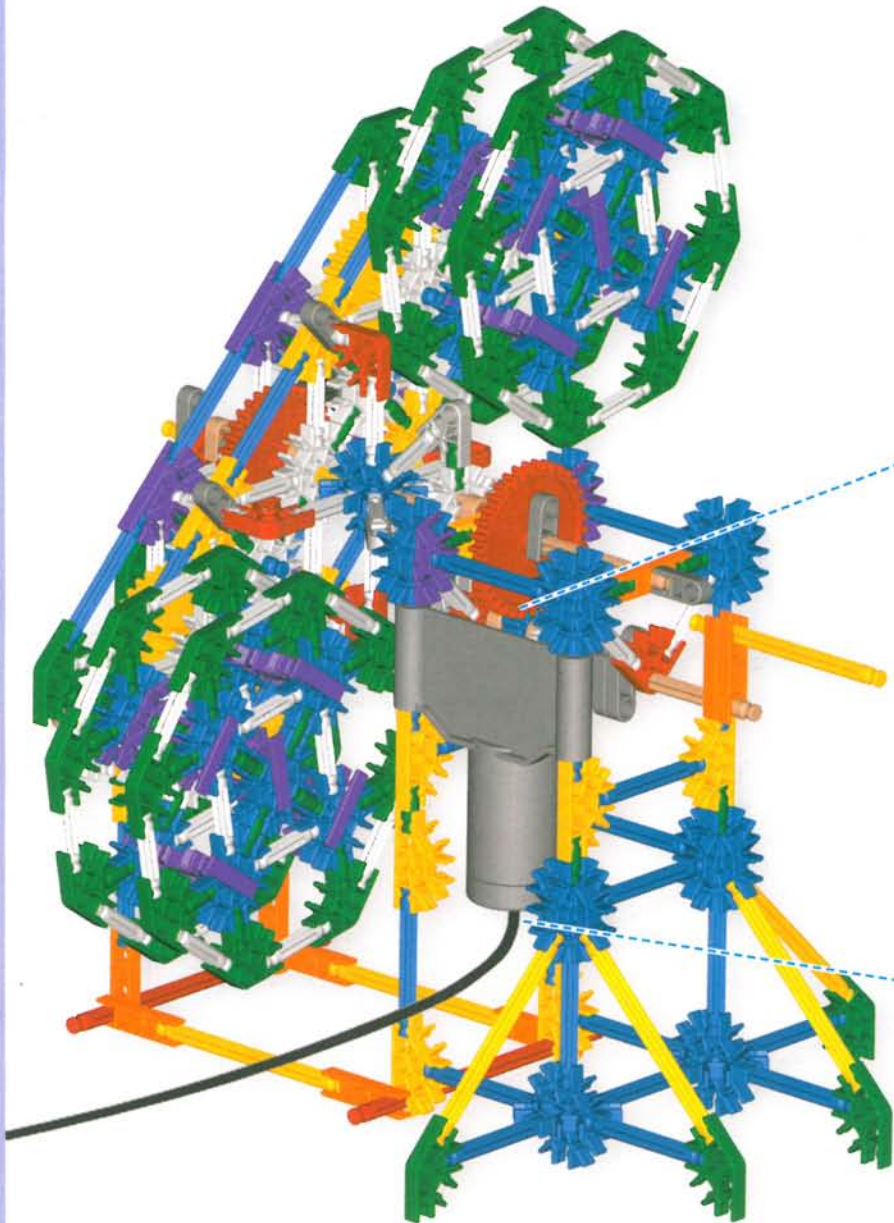

# Mini Ball Machine

 x33

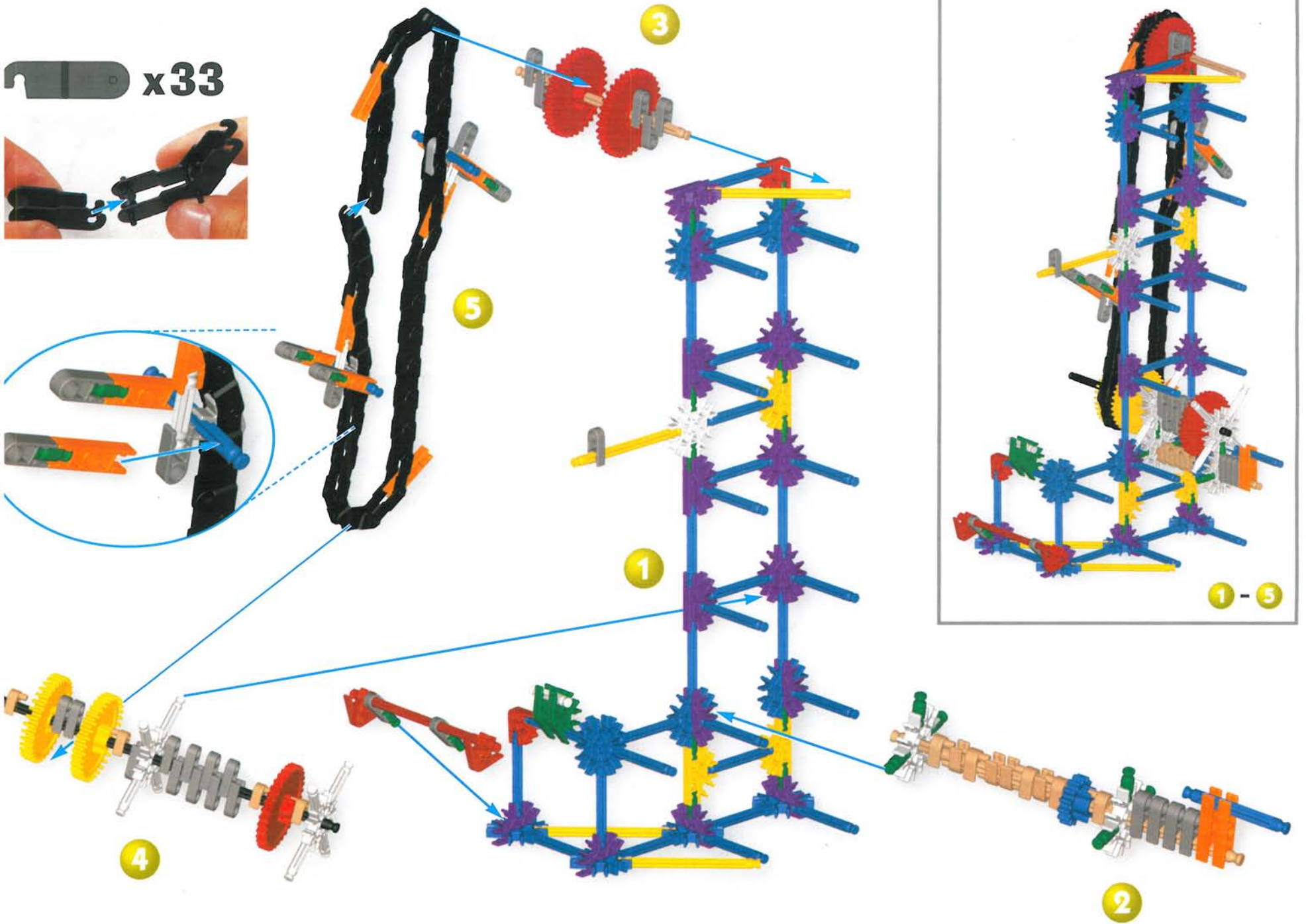
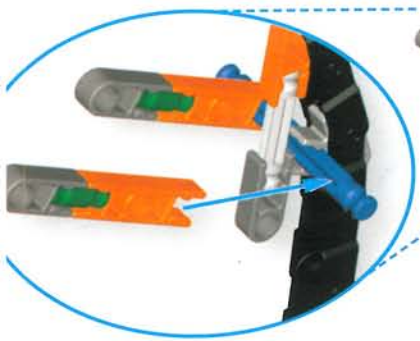

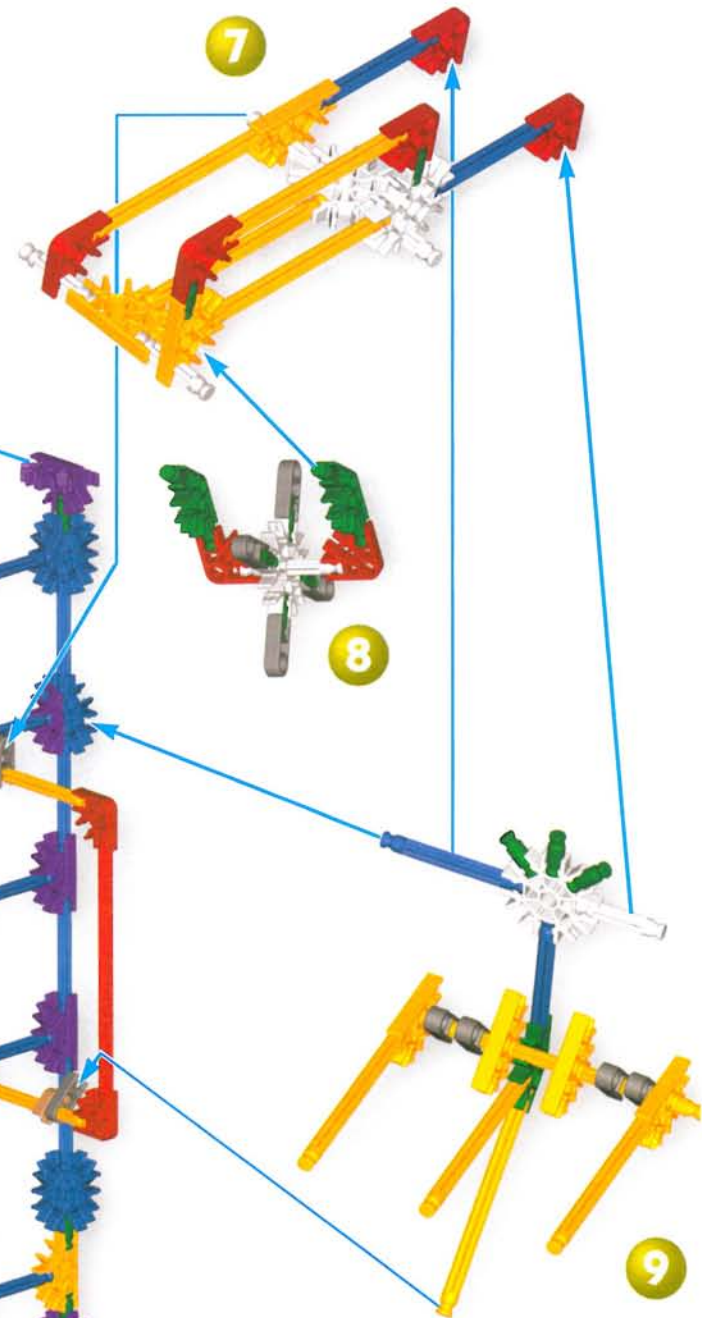
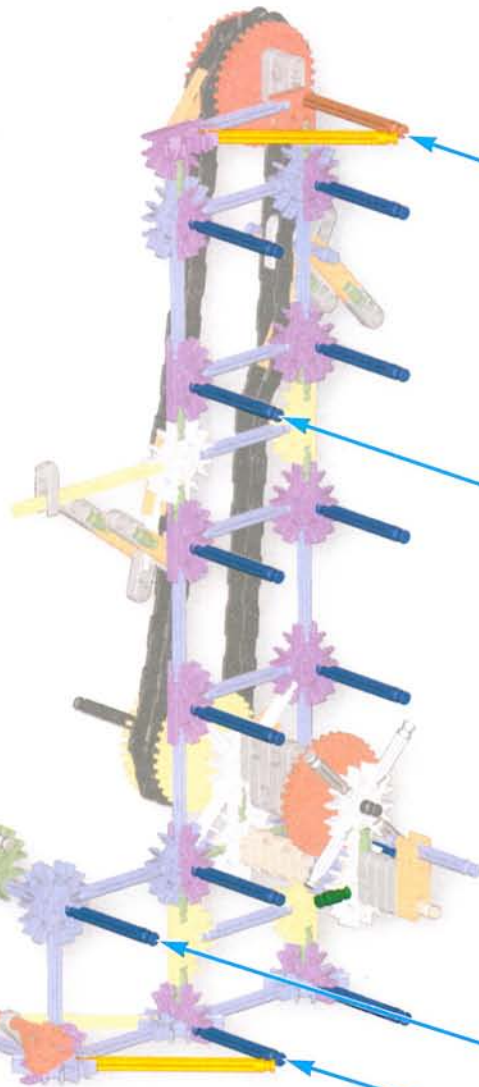

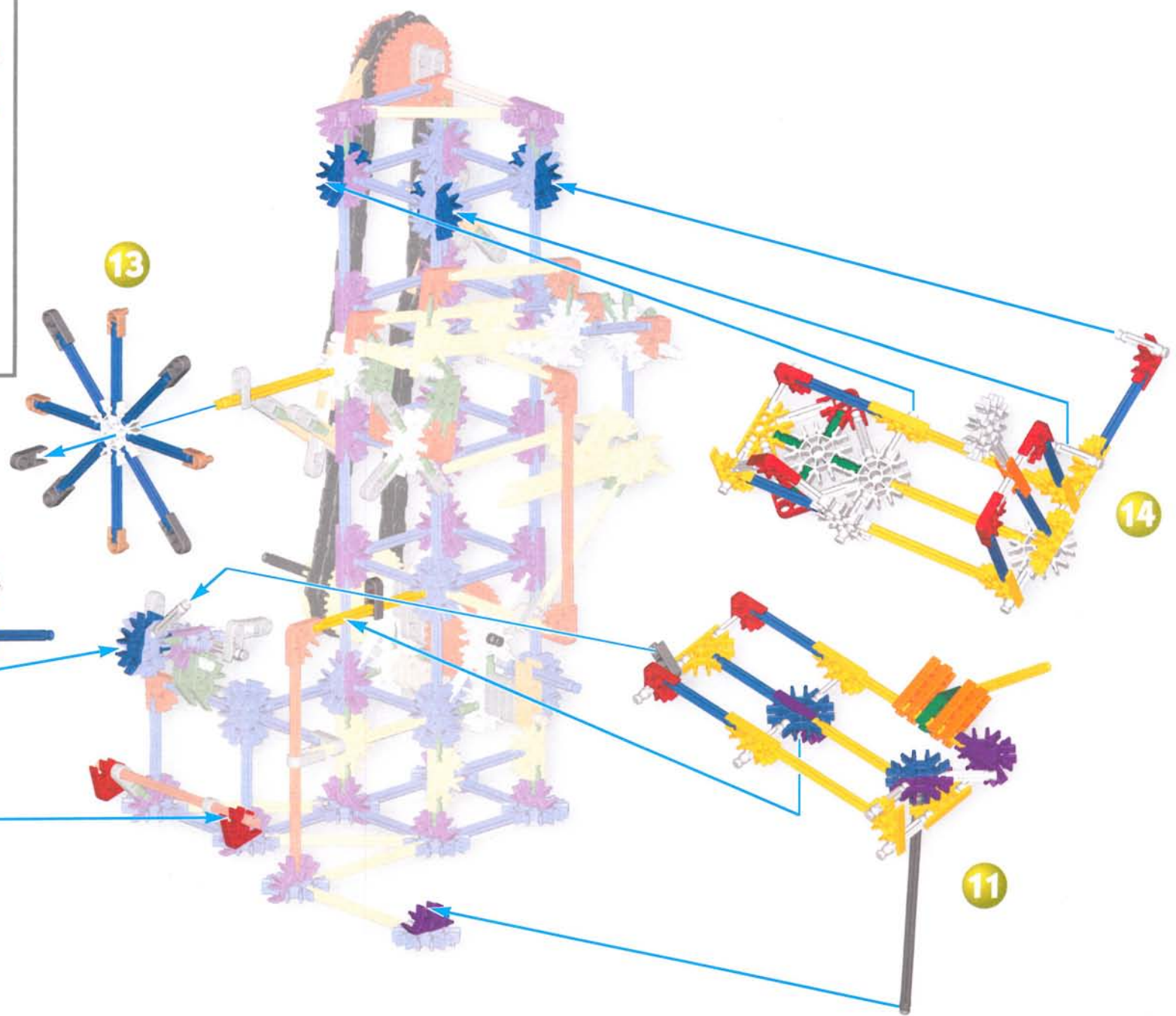

)

 **K'NEX**  
MOTOR PACK  
INSTALLATION

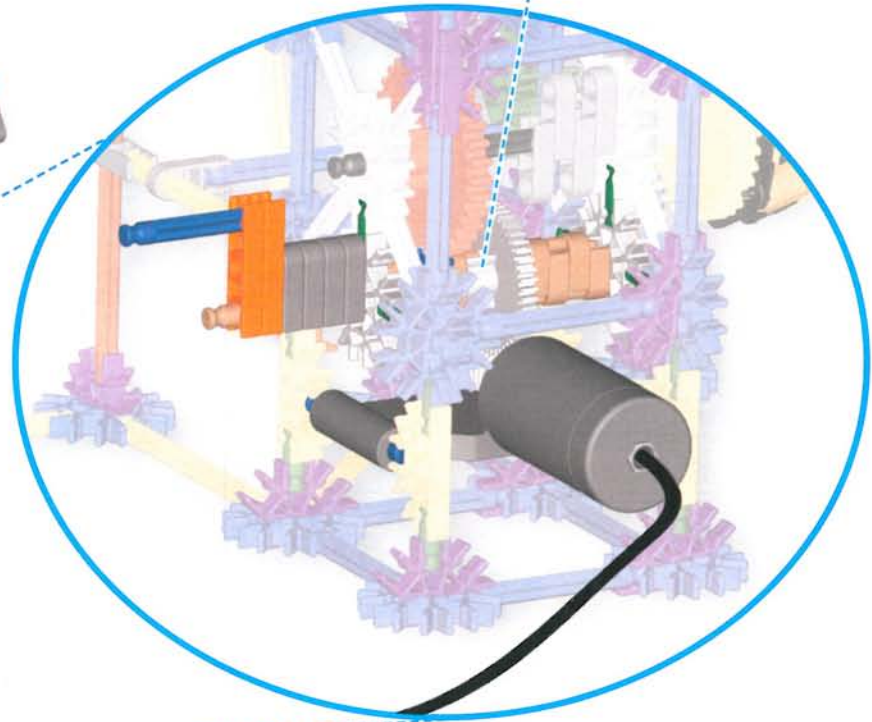
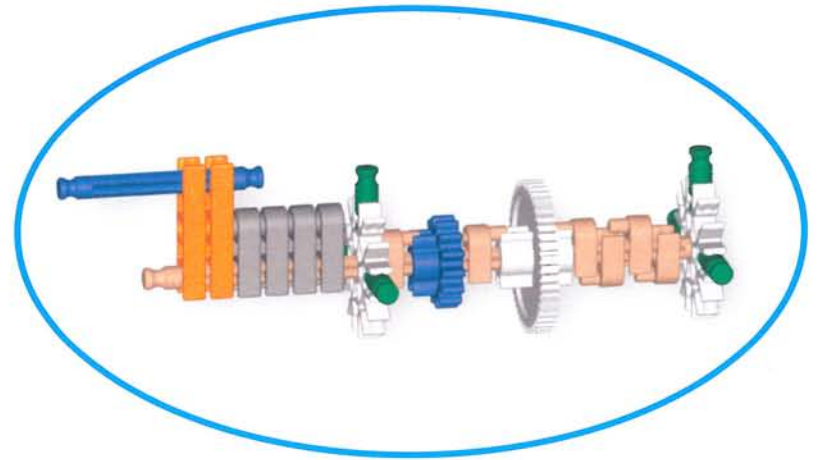

# Spinaround Ride

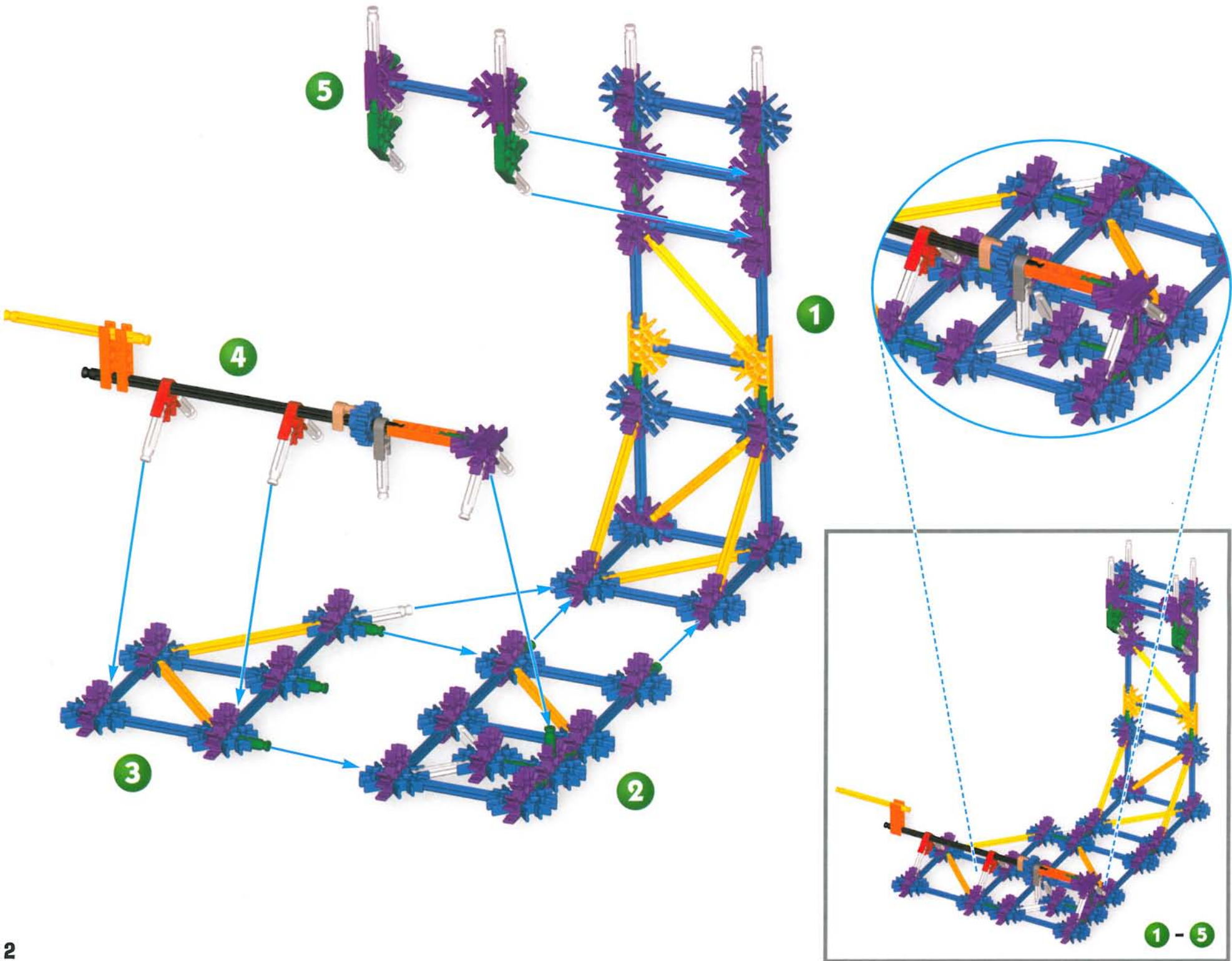

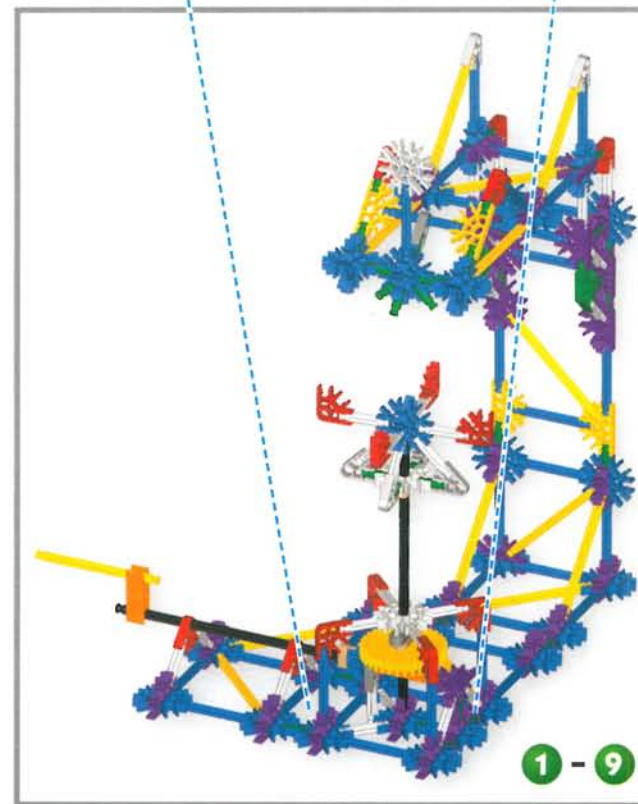
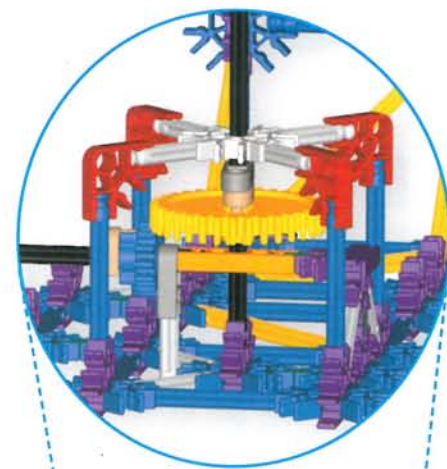
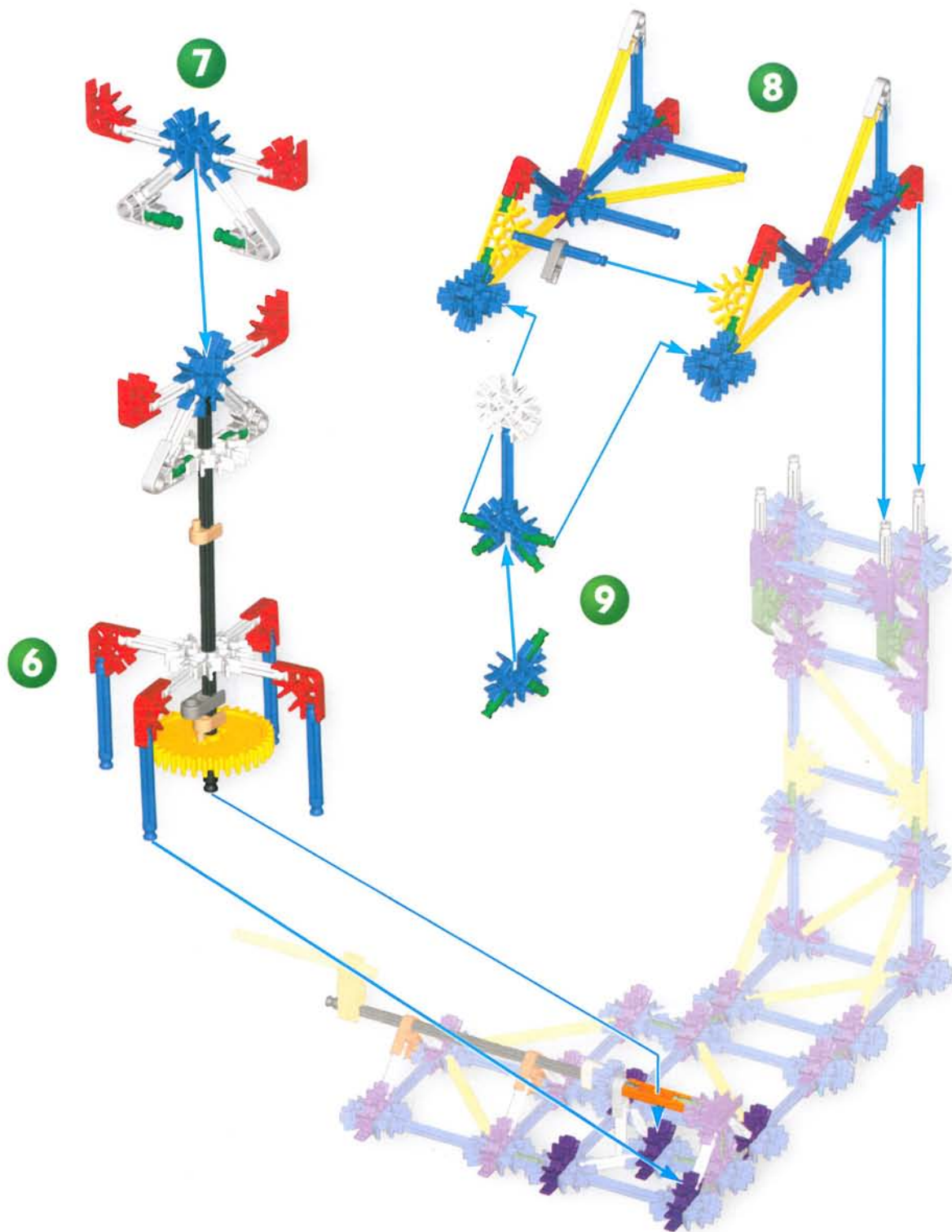

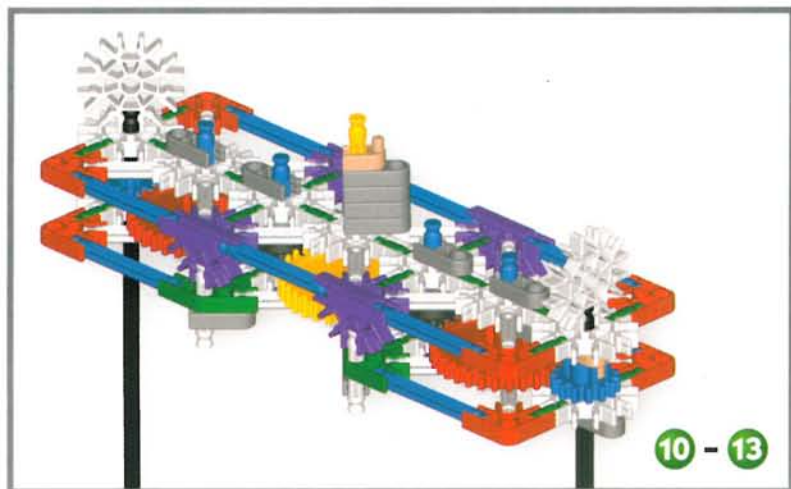
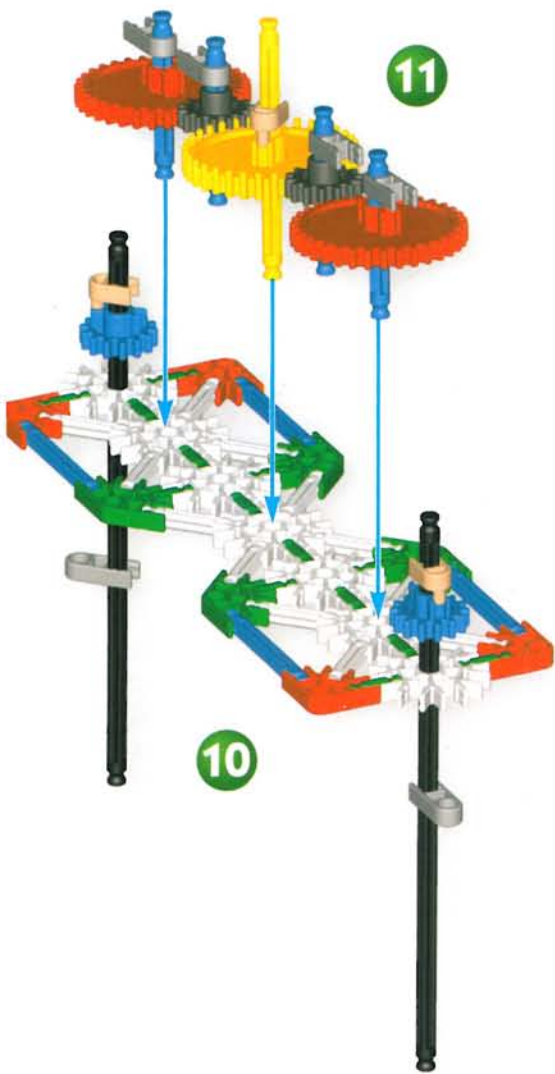

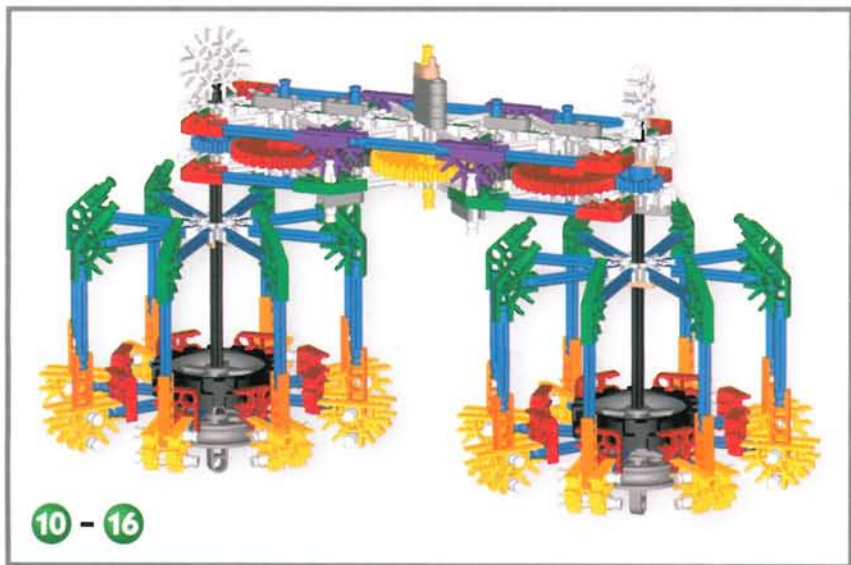
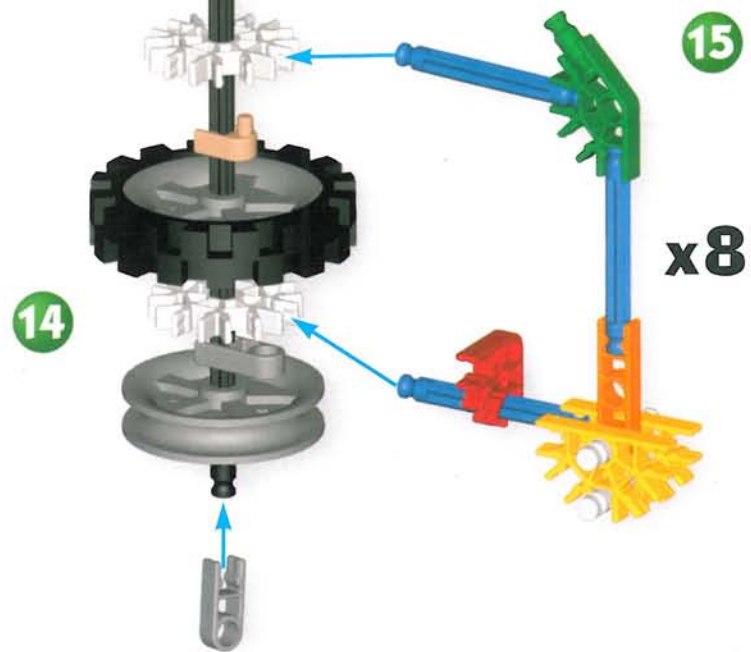

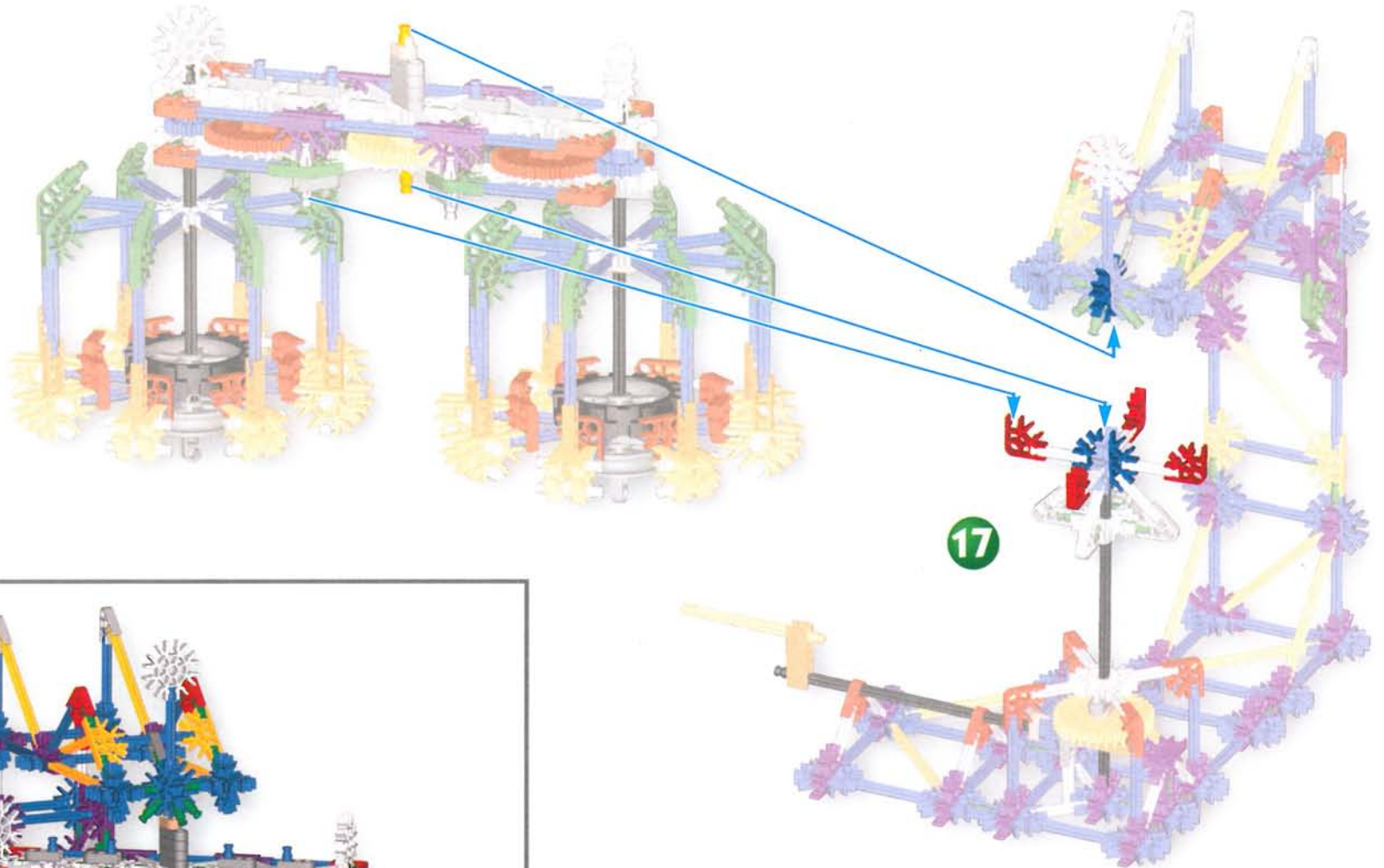

**GB** K'NEX is a registered trademark of K'NEX Industries, Inc. K'NEX International, Century House, Station Way, Cheam, Surrey, SM3 8SW, United Kingdom. FREEPHONE 0800 834938 (UK only) Printed in the USA on recycled paper.

**F** K'NEX est une marque déposée de K'NEX Industries, Inc. K'NEX France, ZA de la Plaise, 73370 Le Bourget-du-Lac. Hasbro (Schweiz) AG, Alte Bremgartenstrasse 2, CH-8965 Berikon and S.A. Hasbro N.V., Riverside Business Park - Spey House, Bld International 55/4 Internationale Laan, Bruxelles 1070 Brussel. Imprimé aux États-Unis sur papier recyclé.

**I** K'NEX è un marchio di fabbrica registrato della K'NEX Industries, Inc. Stampato negli USA su carta riciclata.

**D** K'NEX ist ein eingetragenes Warenzeichen der K'NEX Industries, Inc. K'NEX GmbH, Waldstraße 49, 90763 Fürth. Hasbro (Schweiz) AG, Alte Bremgartenstrasse 2, CH-8965 Berikon. Gedruckt in den USA auf Recyclingpapier.

**E** K'NEX es una marca registrada de K'NEX Industries, Inc. Distribuido en España por M.B. España S.A. Apartado de Correos 133 Quart de Poblet-Valencia. N.I.F. A-46156444; R.I. 6170. Los colores de los componentes pueden diferir de los indicados en la caja. Recomendamos que guarde nuestra dirección por si le es necesaria más adelante. Impreso en Estados Unidos en papel reciclado.

**S** K'NEX är ett registrerat varumärke av K'NEX Industries, Inc. Hasbro Sweden AB, Johanneslundsvägen 2, Business Campus, S-194 81 Upplands Väsby. Tryckt i USA på återvunnet papper.

**DK** K'NEX er et registreret varemærke, der tilhører K'NEX Industries, Inc. Hasbro Denmark A/S, Ejby Industrivej 40, DK-2600 Glostrup. Trykt i USA på genbrugspapir.

**N** K'NEX er et registrert varemerke som tilhører K'NEX Industries, Inc. Hasbro Norway AS, Nye Vakås Vei 64, N-1360 Nesbru. Trykt i USA på gjenvunnet papir.

**SF** K'NEX on K'NEX Industries, Inc. rekisteröimä tavaramerkki. Hasbro Finland OY, Vattuniemenranta 2, SF-00210 Helsinki. Painettu USA:ssa uusiopaperille.

**NL** K'NEX is een handelsmerk van de K'NEX Industries, Inc. Hasbro B.V., Smart Business Park, Kanaalweg 16 G, 3526 KL Utrecht. S.A. Hasbro N.V., Riverside Business Park - Spey House, Bld International 55/4 Internationale Laan, Bruxelles 1070 Brussel. In Amerika op kringlooppapier gedrukt.

**P** K'NEX é uma marca registada da K'NEX Industries, Inc. Distribuido em Portugal por HASBRO, IMPORTAÇÃO e EXPORTAÇÃO DE JOGOS E BRINQUEDOS LDA, Rua Melo e Sousa, Bloco 2, Estoril Garden, 2765 Estoril. NIF 502949546. As cores dos componentes podem diferir das indicadas na caixa. Recomendamos que anotem a nossa morada para futura referência. Impresso nos Estados Unidos em papel reciclado.

**G** Το K'NEX είναι σήμα κατατεθέν της K'NEX Industries, Inc. Τυπώθηκε στις Ηνωμένες Πολιτείες σε ανακυκλωμένο χαρτί.

**TR** K'NEX, K'NEX Industries, Inc.'in tescilli markasıdır. İNTERTOY tarafından ithal edilmiştir. PK 221, Şişli İstanbul. A.B.D.'de yeniden kullanılmış kağıda basılmıştır.

**J** K'NEXは K'NEX Industries, Inc. の登録商標です。リサイクル紙使用 Printed in the USA.

**CHI** K'NEX 是 K'NEX Industries, Inc. 的注册商標。香港九龍尖沙嘴廣東道七號海港城世運中心一五零六室 Palmyra (香港) 有限公司台灣分公司, 台北縣砂址鎮中興路九十五號五樓二室在美國用再生紙印刷。

**IL** K'NEX Industries, Inc. הוא סימן מסחרי רשום של הסברו ישראל בע"מ, שדרות הרצל 104, ירושלים 96187 מודפס בארצות הברית על נייר ממוחזר

©1996 K'NEX Industries, Inc. • Hatfield, PA 19440-0700 • 1-800-KID-KNEX (USA only)

K'NEX is a registered trademark of K'NEX Industries, Inc. Manufactured under U.S. Patents 5,061,219, 5,137,486, 5,199,919, 5,238,438, 5,346,420, 5,350,331, 5,368,514, 5,421,762, 5,423,707, 5,427,559 and 5,518,435. Other U.S. and foreign patents pending.

Conforms to the Requirements of ASTM Standard Consumer Safety Specification on Toy Safety F963-95.

PRINTED IN U.S.A.



1000

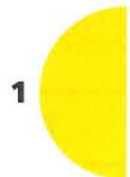
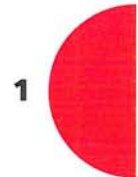
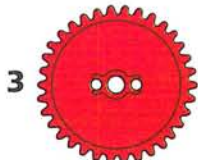
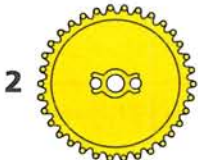
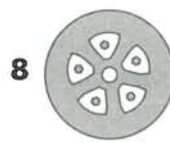
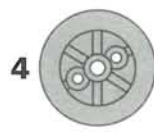
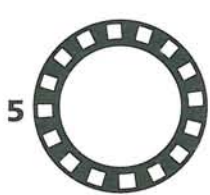
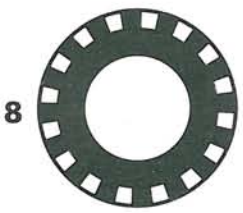
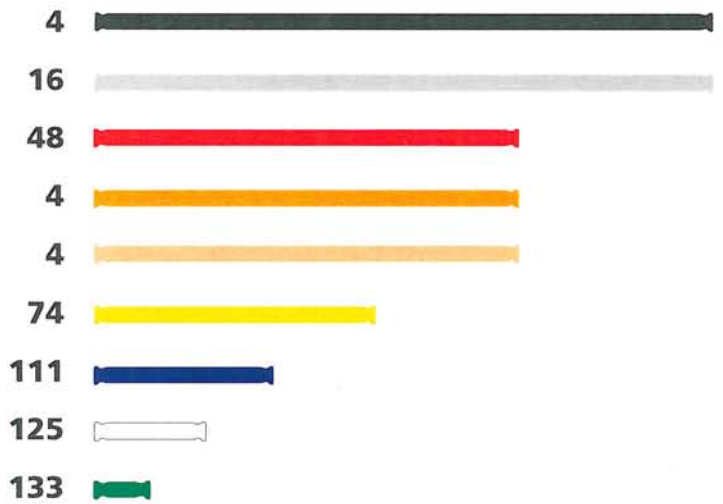

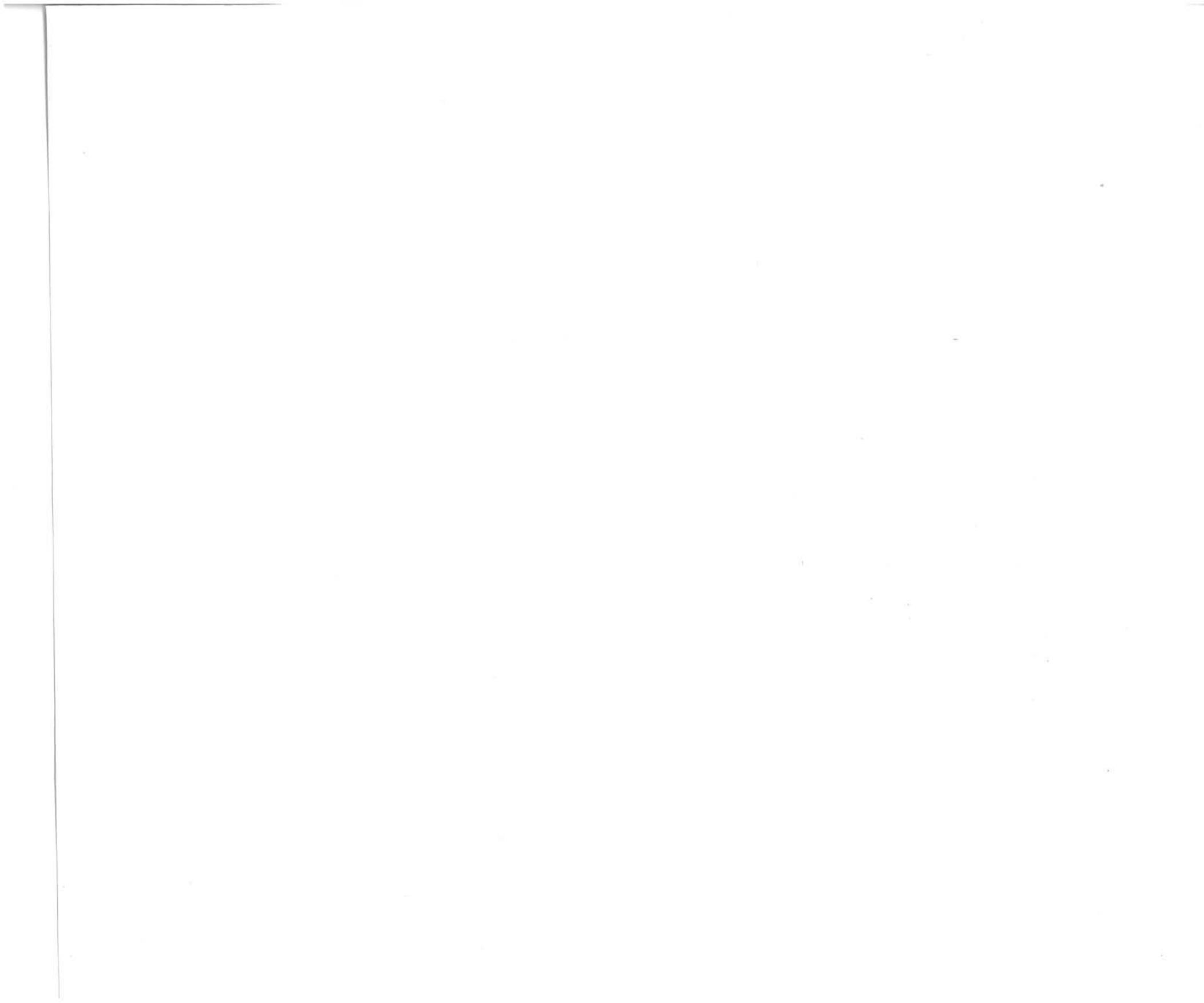



©1996 K'NEX Industries, Inc.  
Hatfield, PA 19440-0700  
1-800-KID-KNEX (USA only)