

47024 Sabertooth Blaster Alt 4

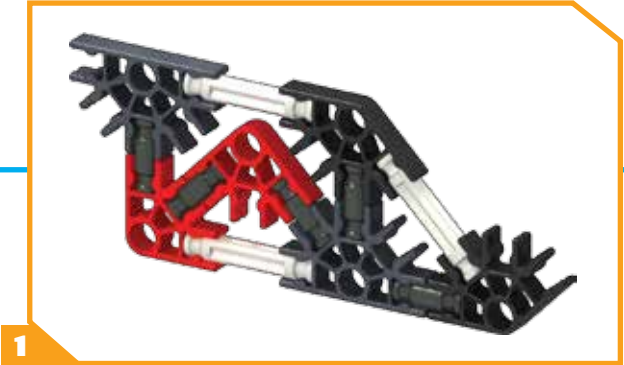

- 2 
- 2  2 
- 3  5 

1

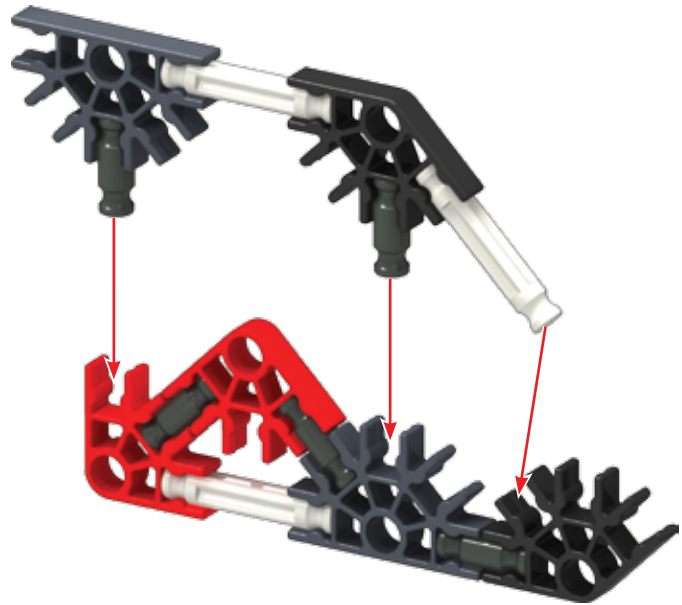

1

- 1  1 
- 1 
- 1  4 
- 1 

2

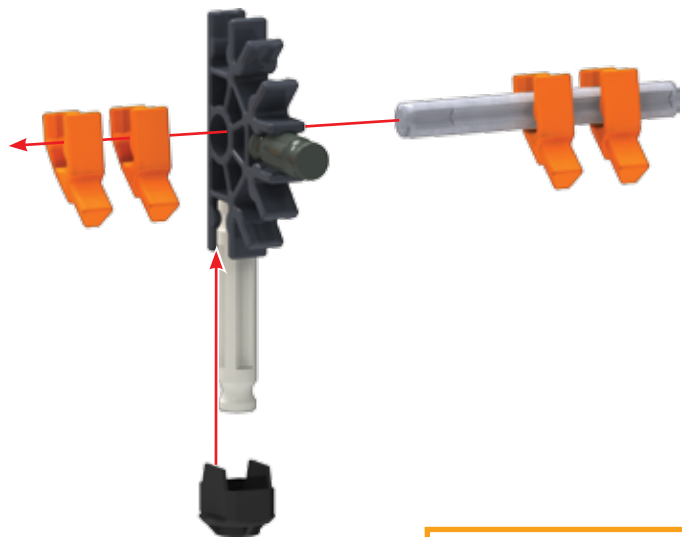

2

3

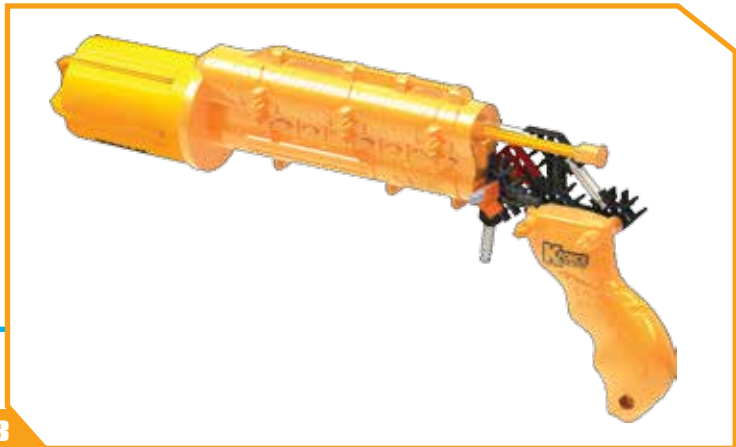
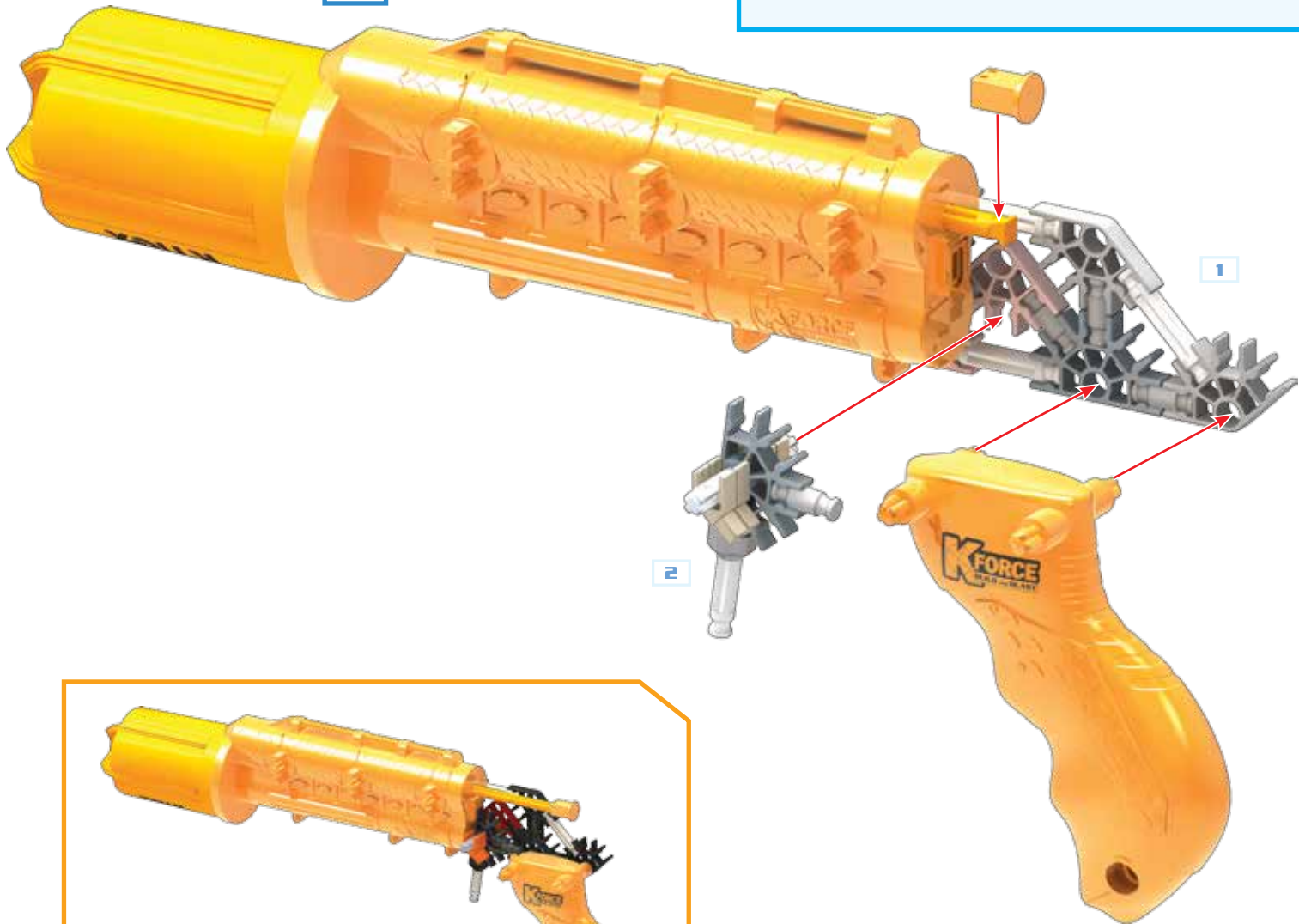

1 - 3

- 2 
- 2  2 
- 3  5 

4

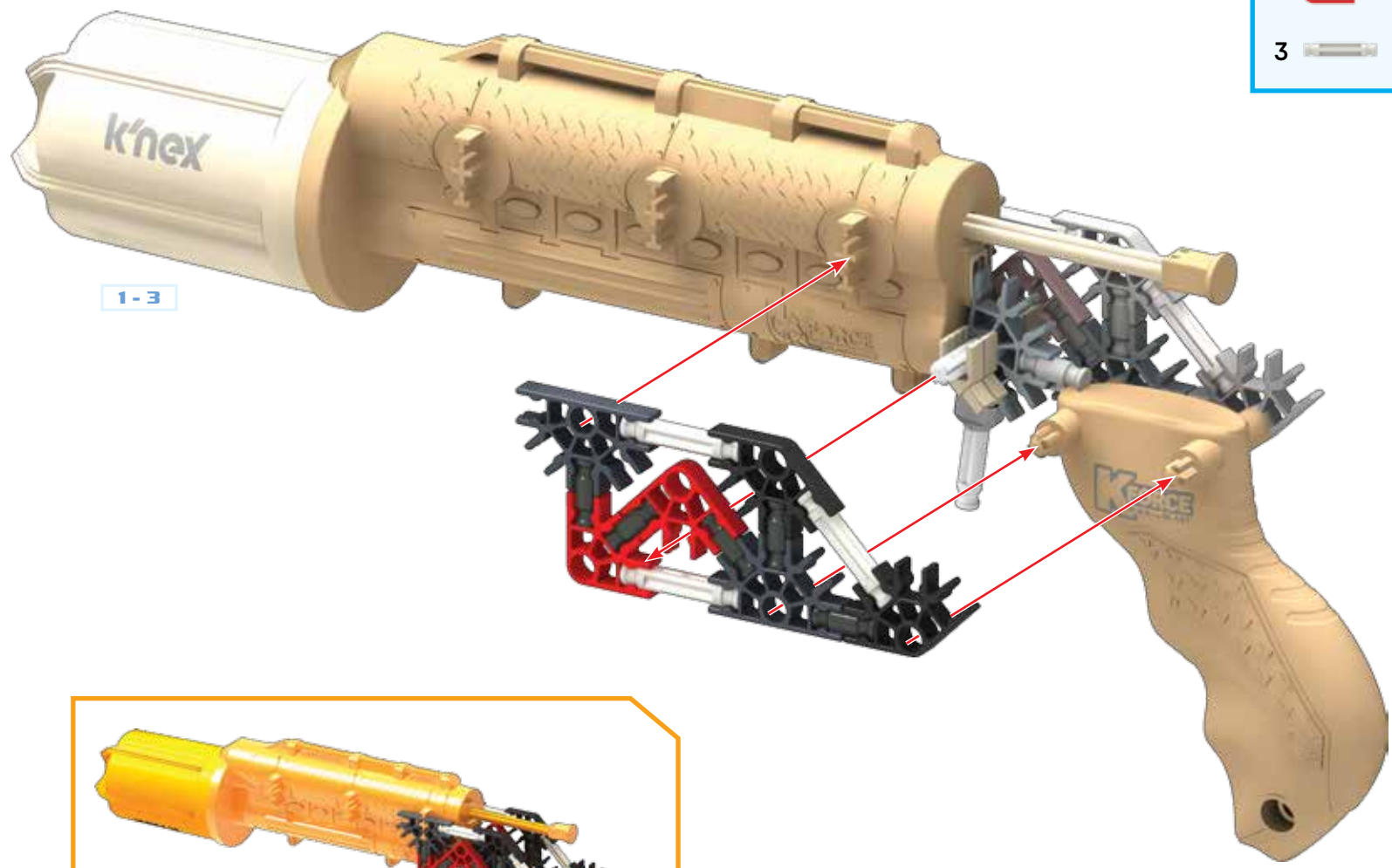

1-3



1-4

5

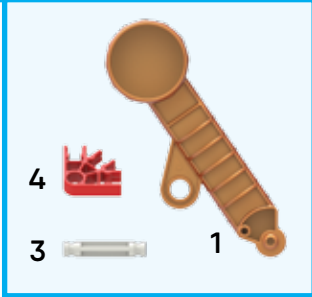

5



6

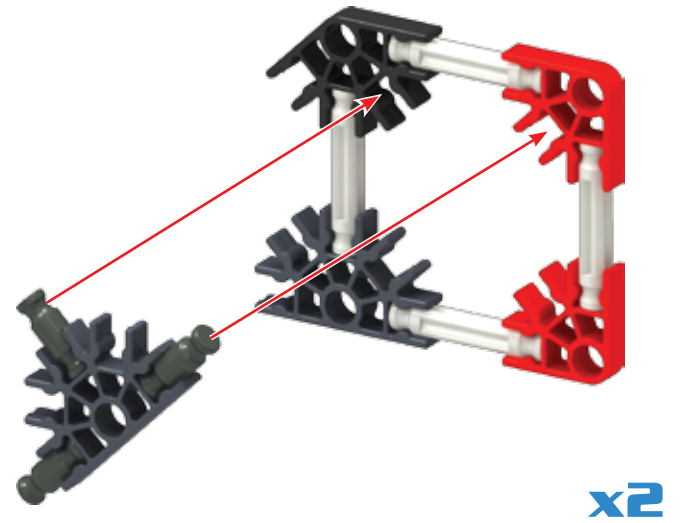

6

x2

