

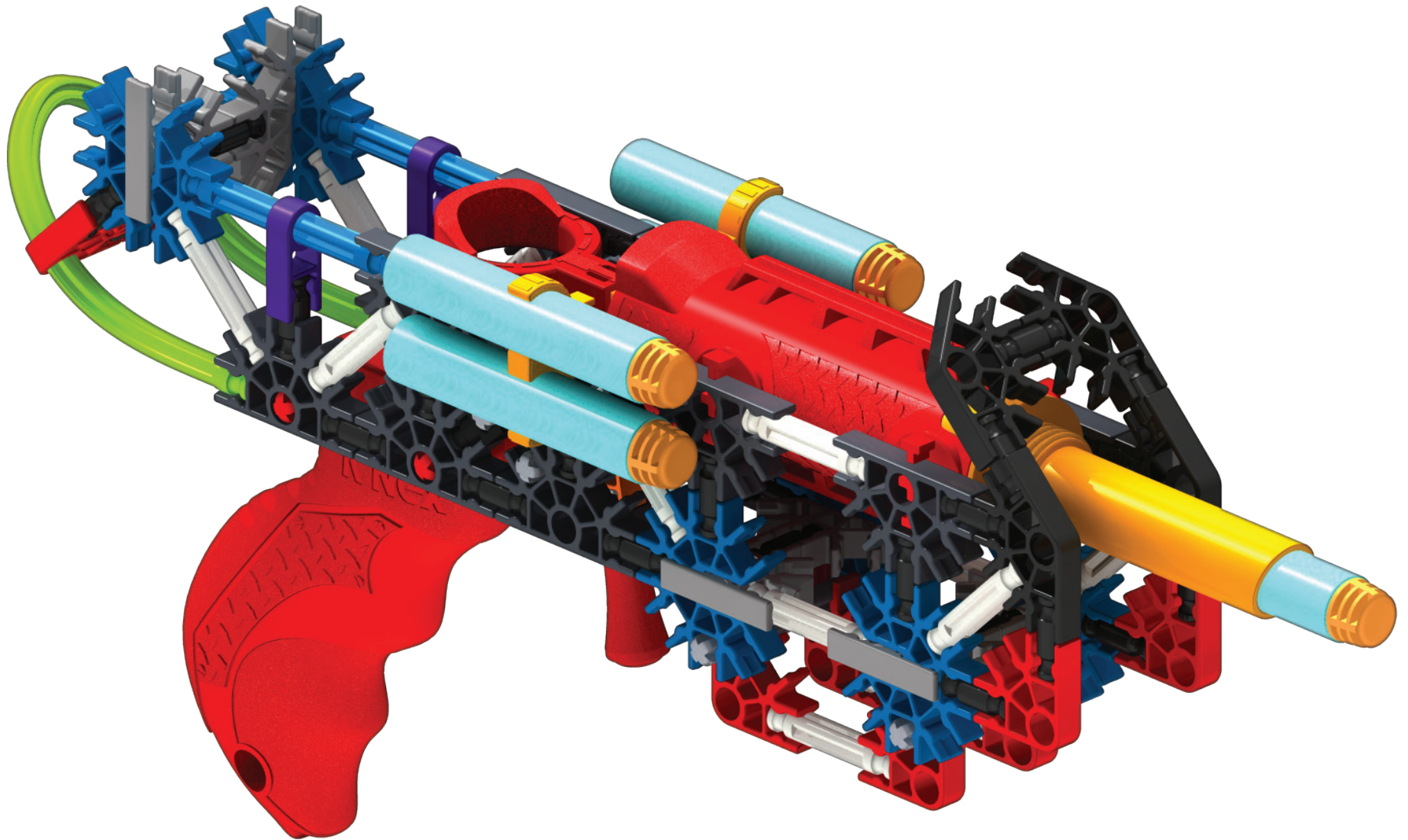

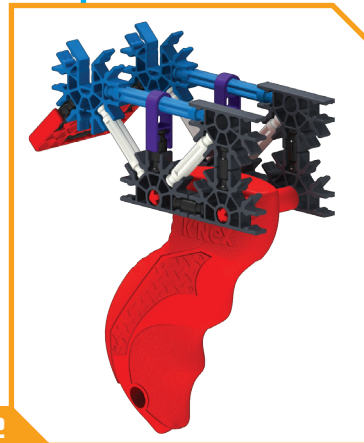

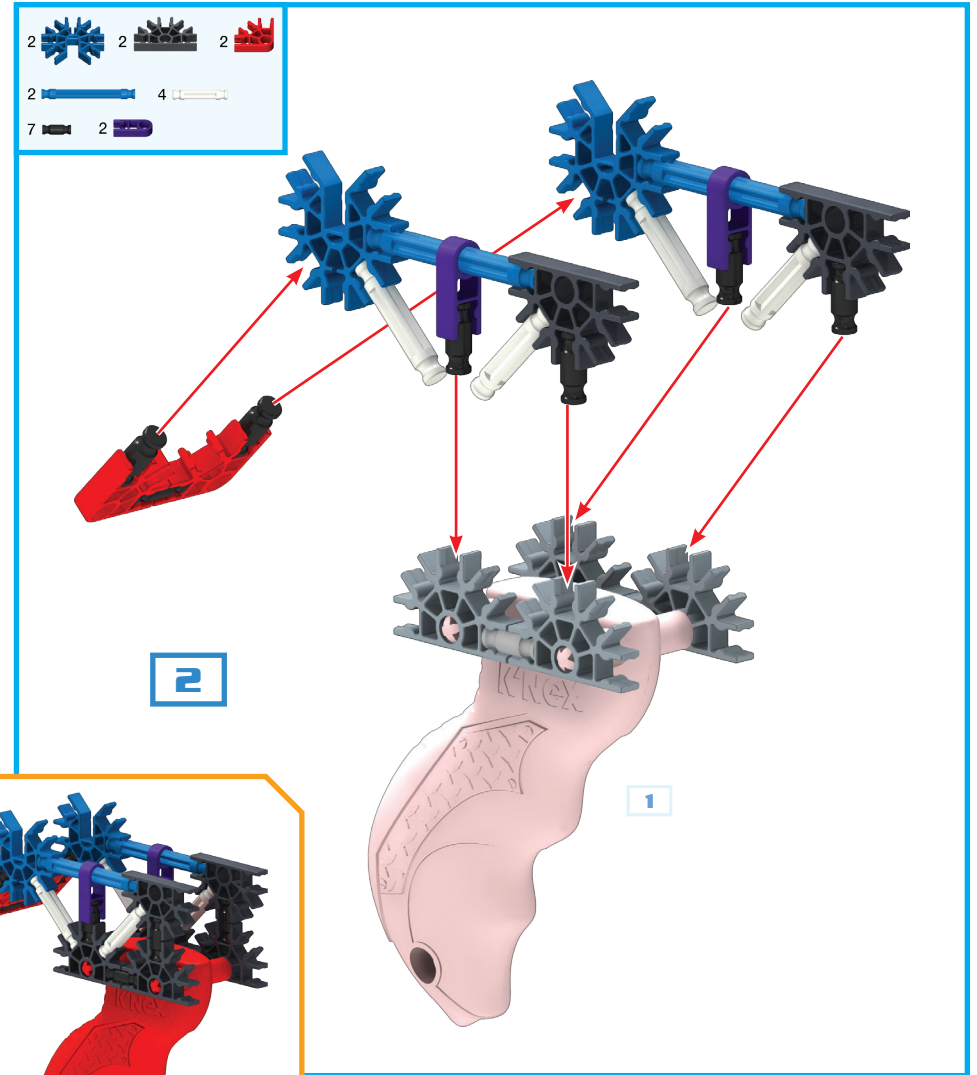

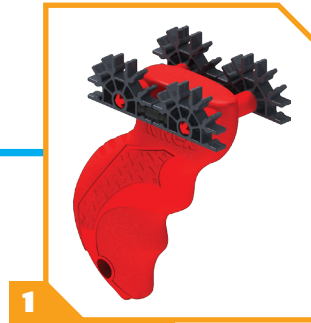

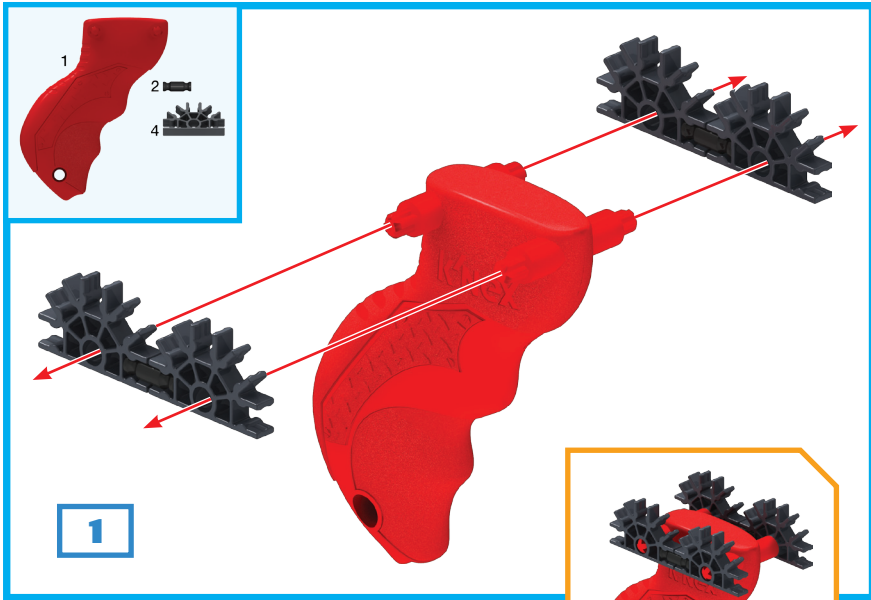
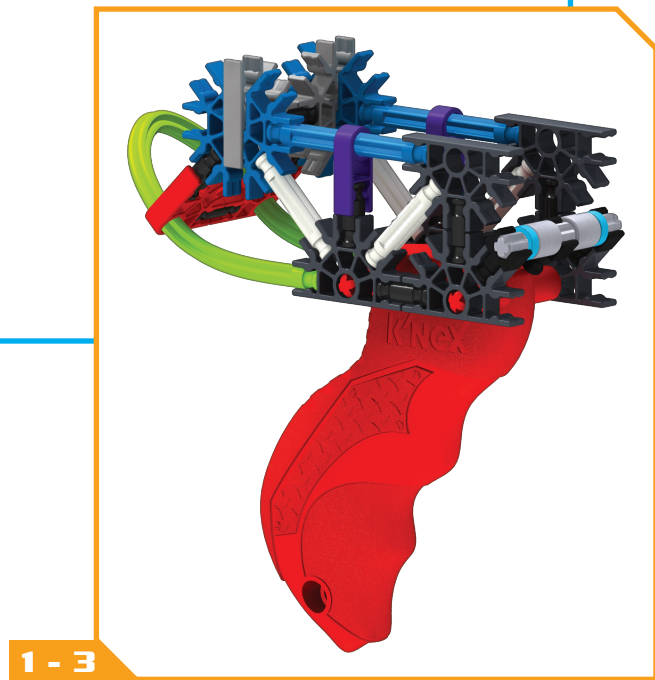
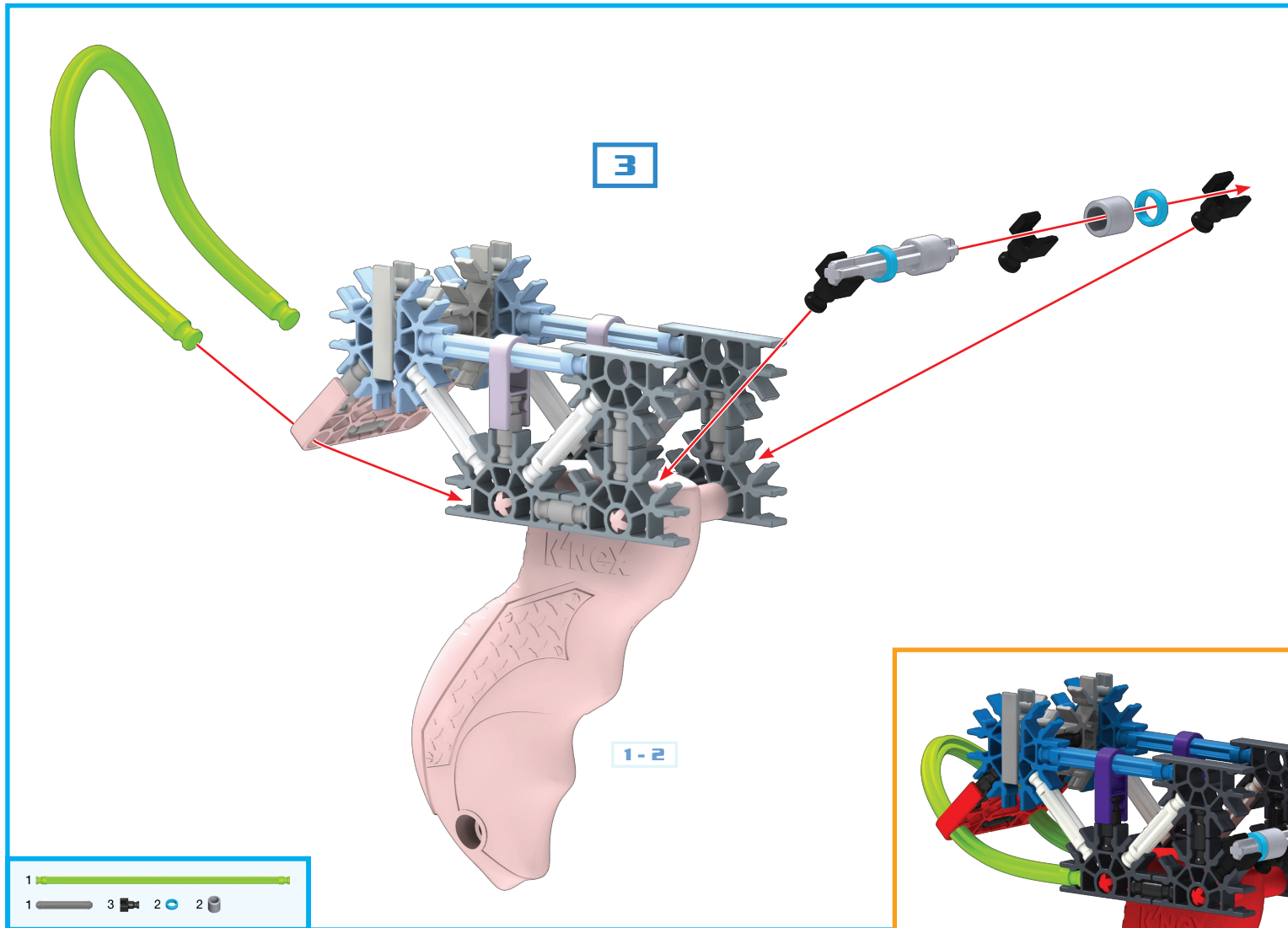

# 47524 K-20x Alt 1







- 4  1  1 
- 1  2  2  1 
- 10  3  1 

4

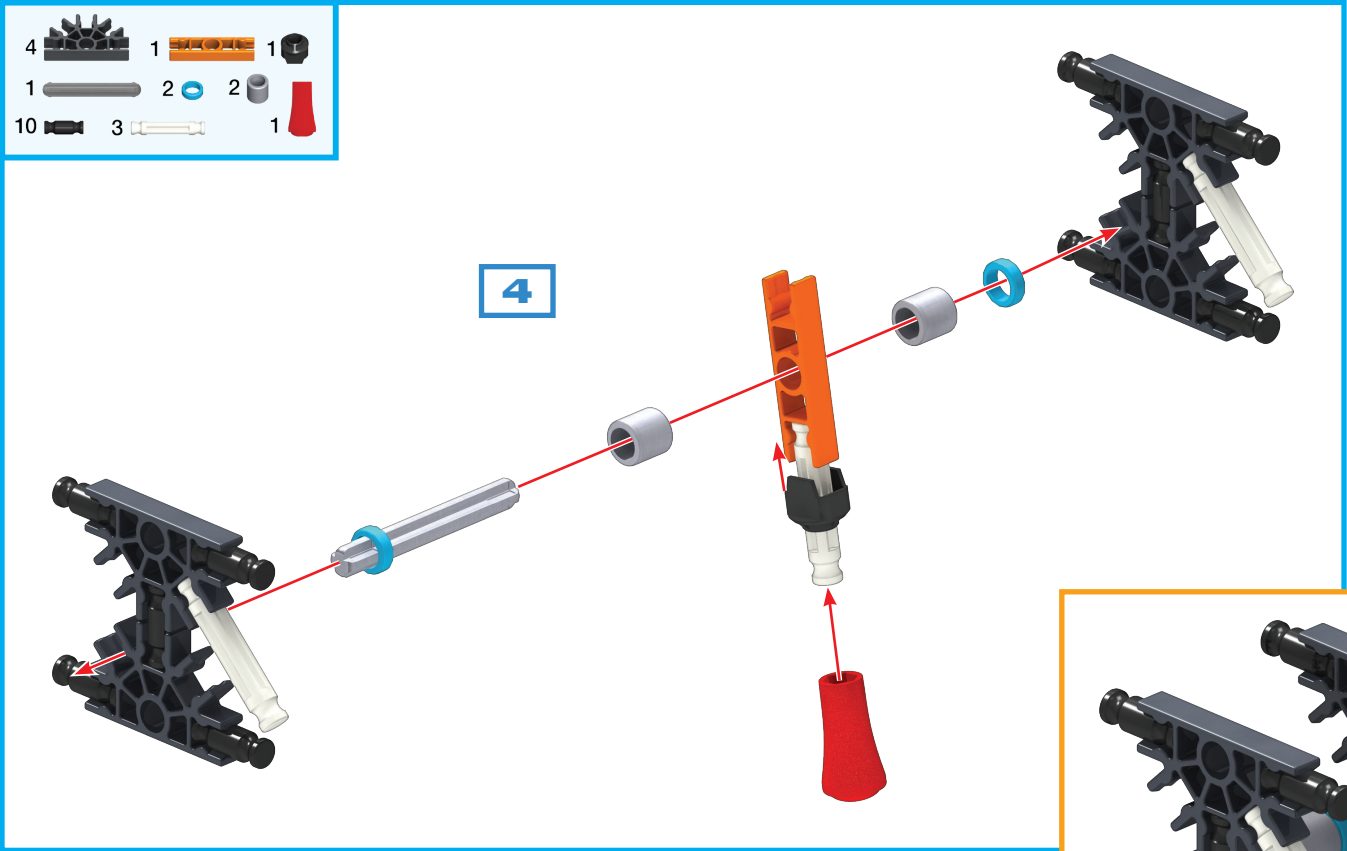

4

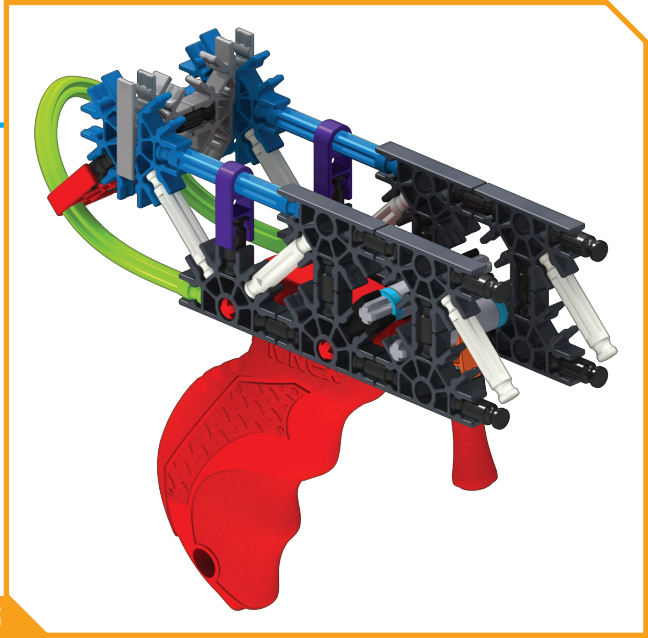
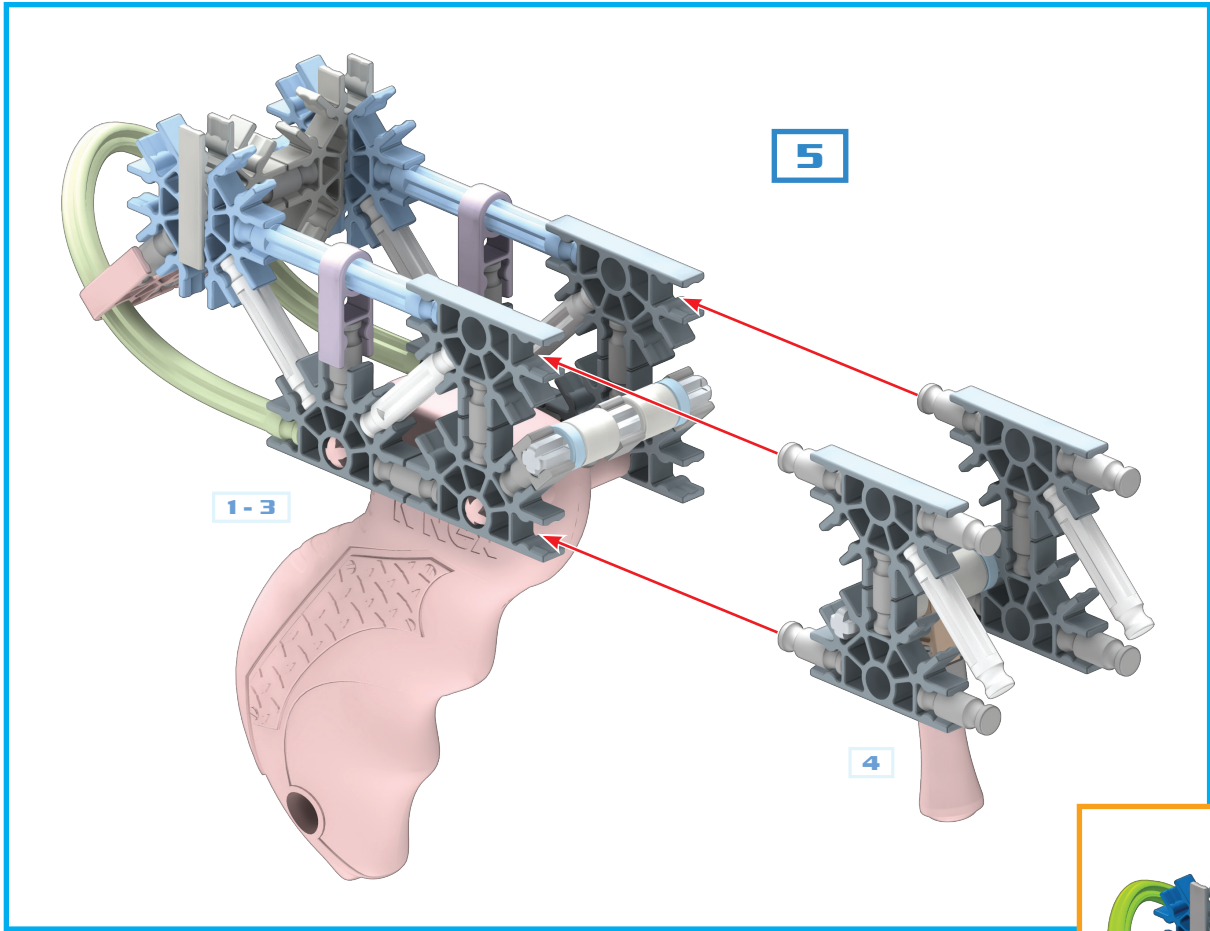

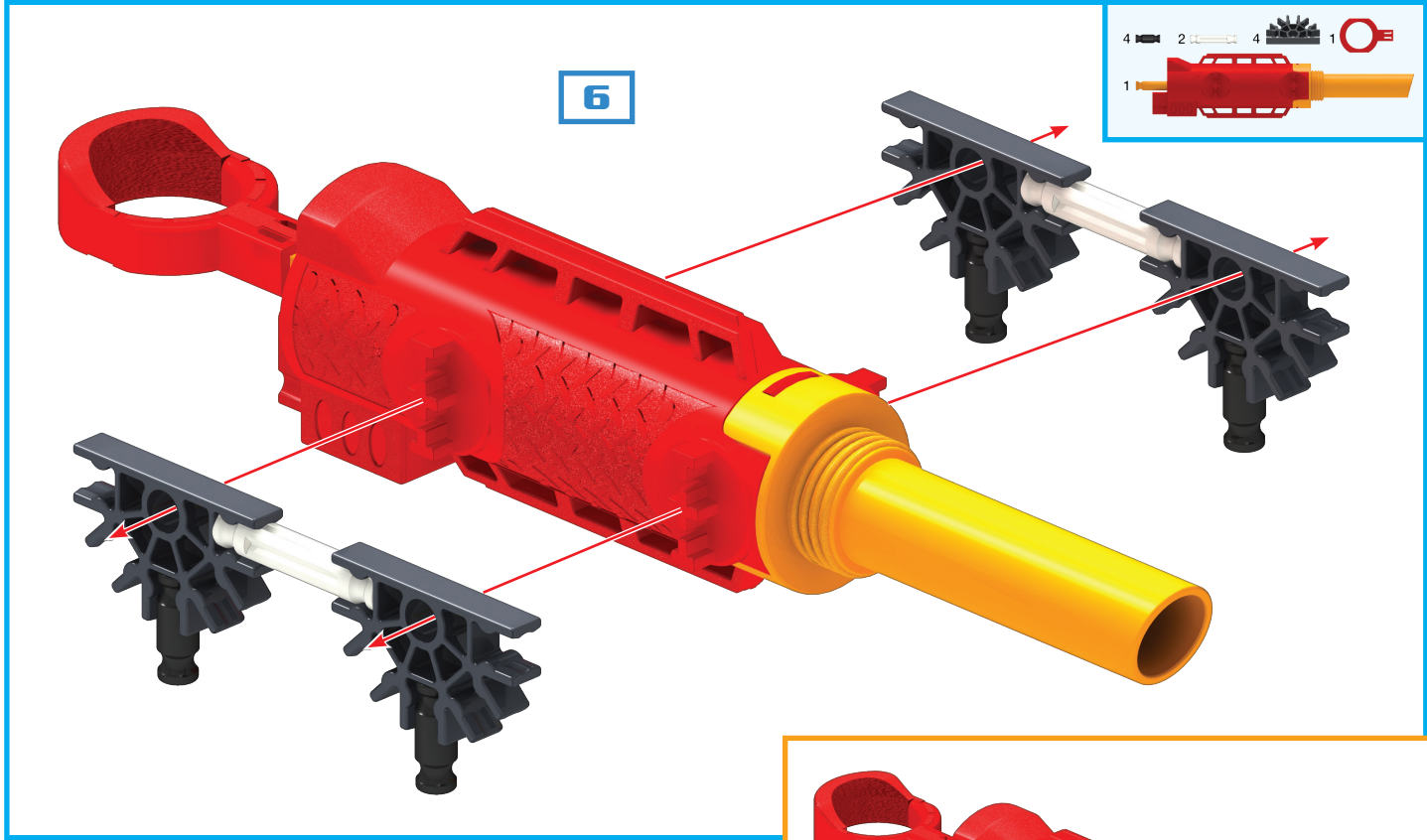

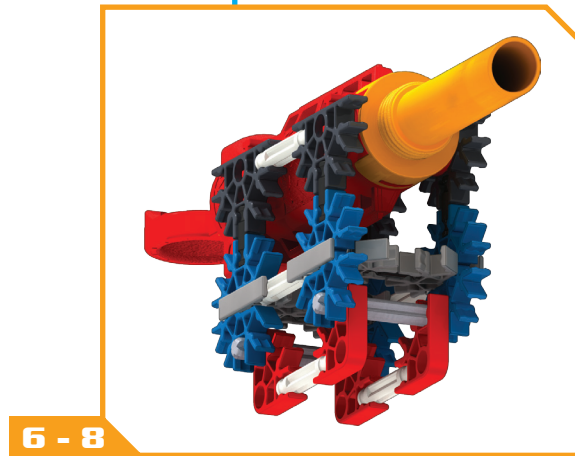
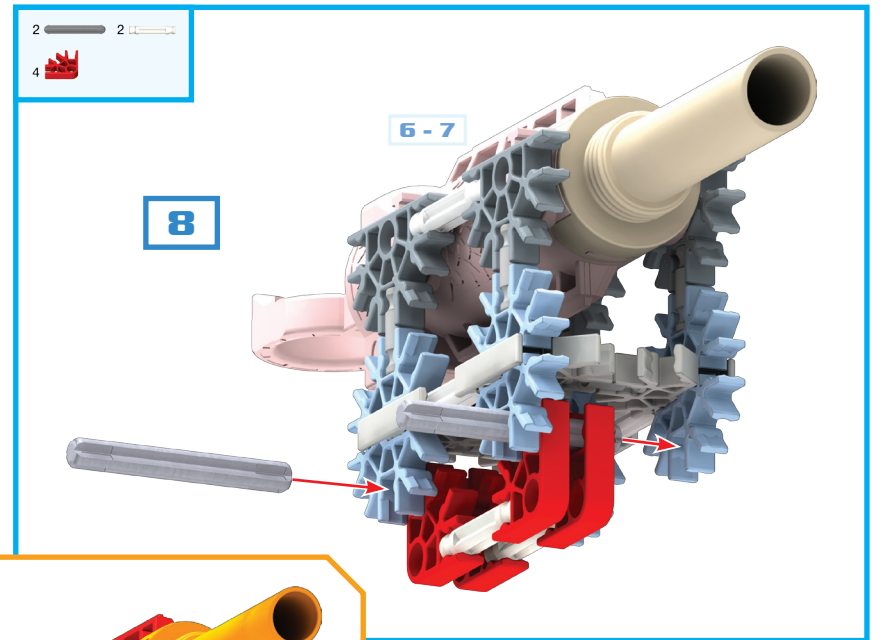
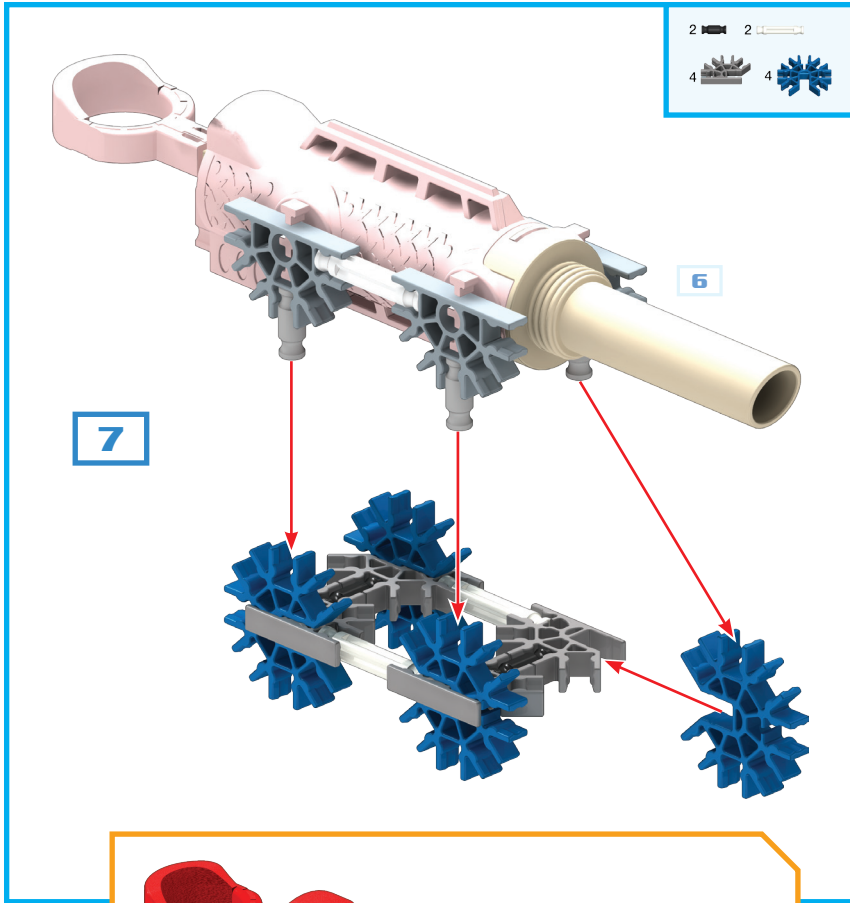

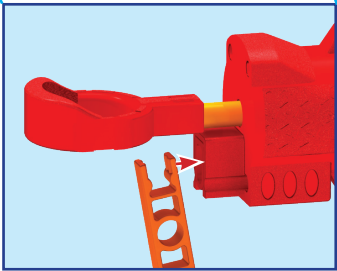
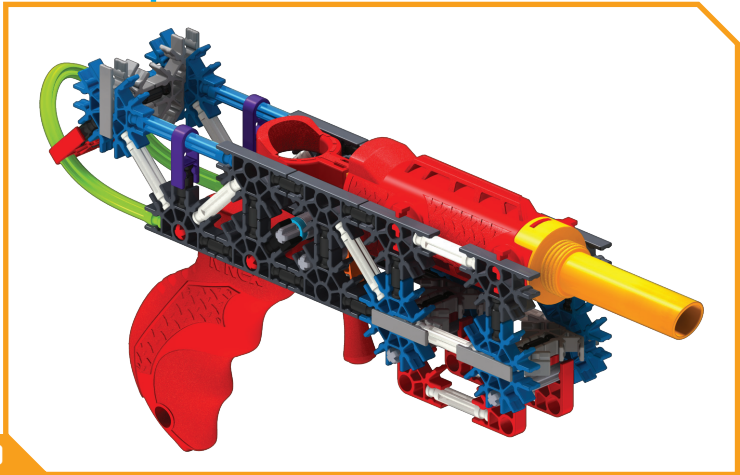
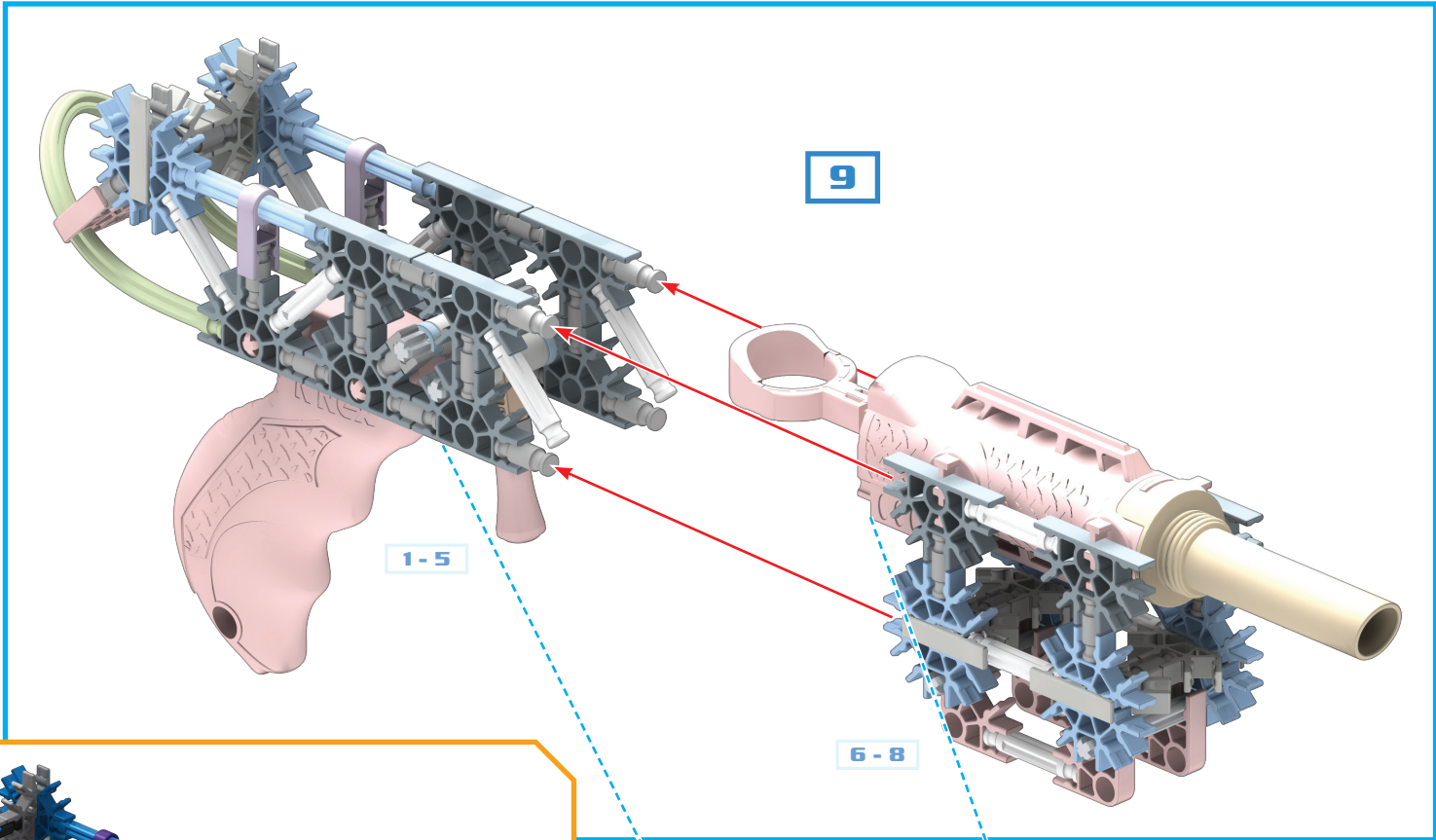

- |   |  |   |  |
|---|--|---|--|
| 9 |  | 2 |  |
| 2 |  | 4 |  |

10

1-9

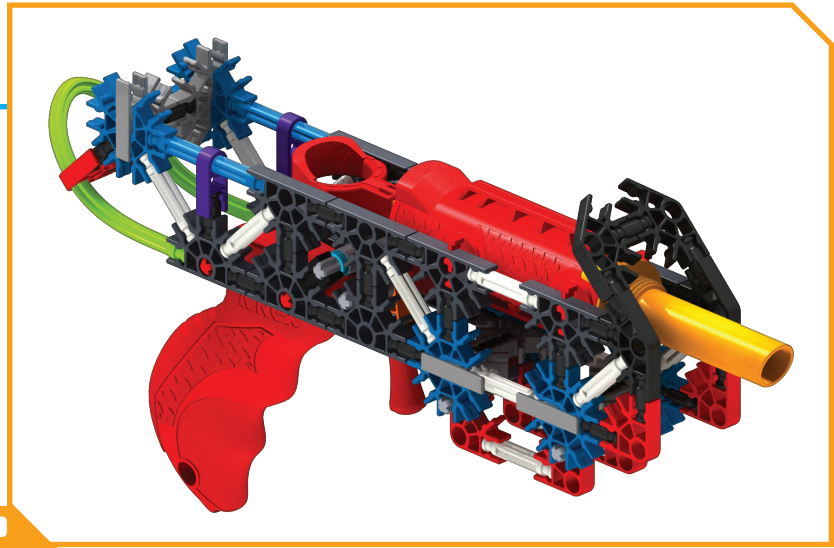
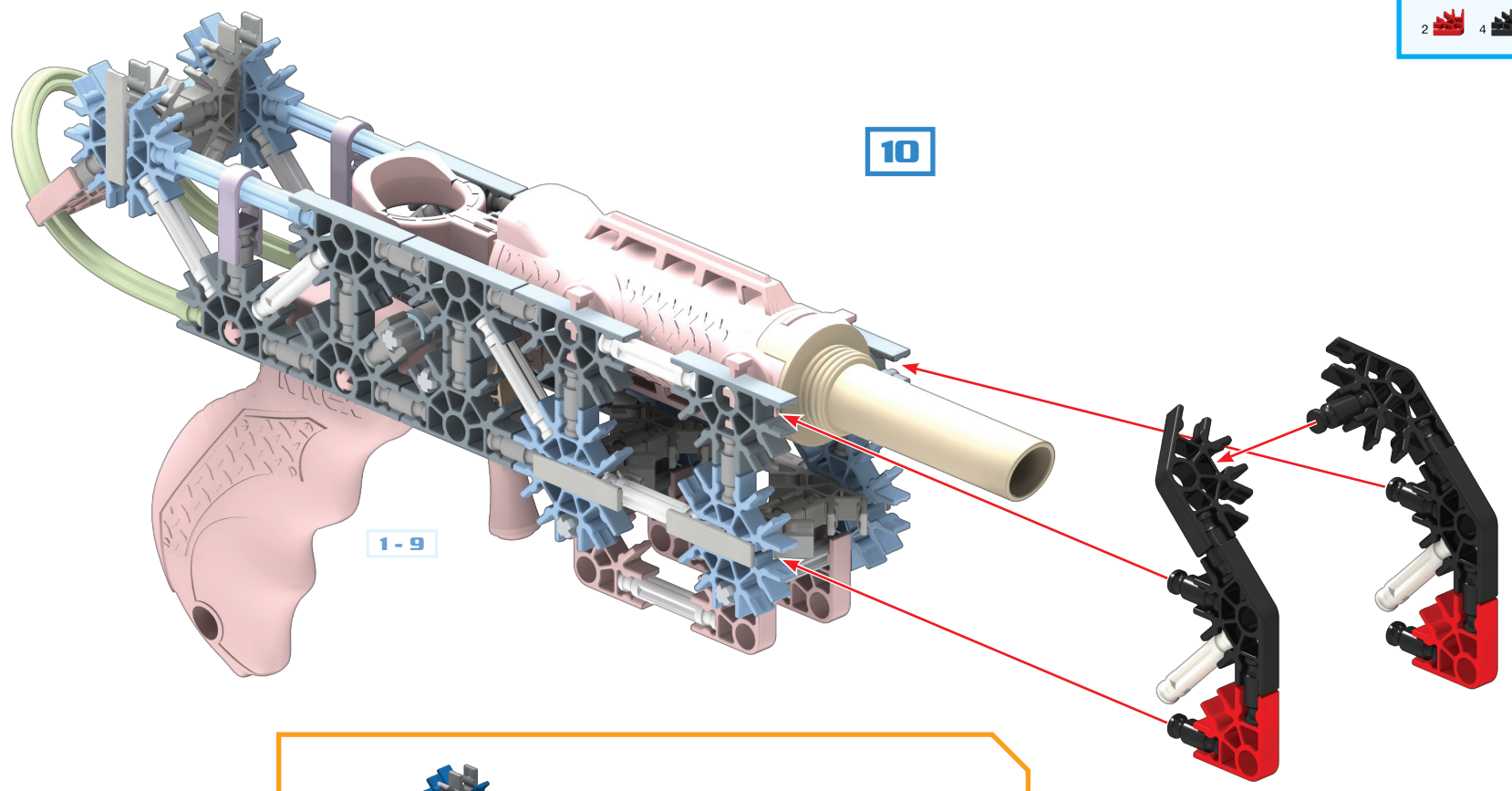

1-10

