

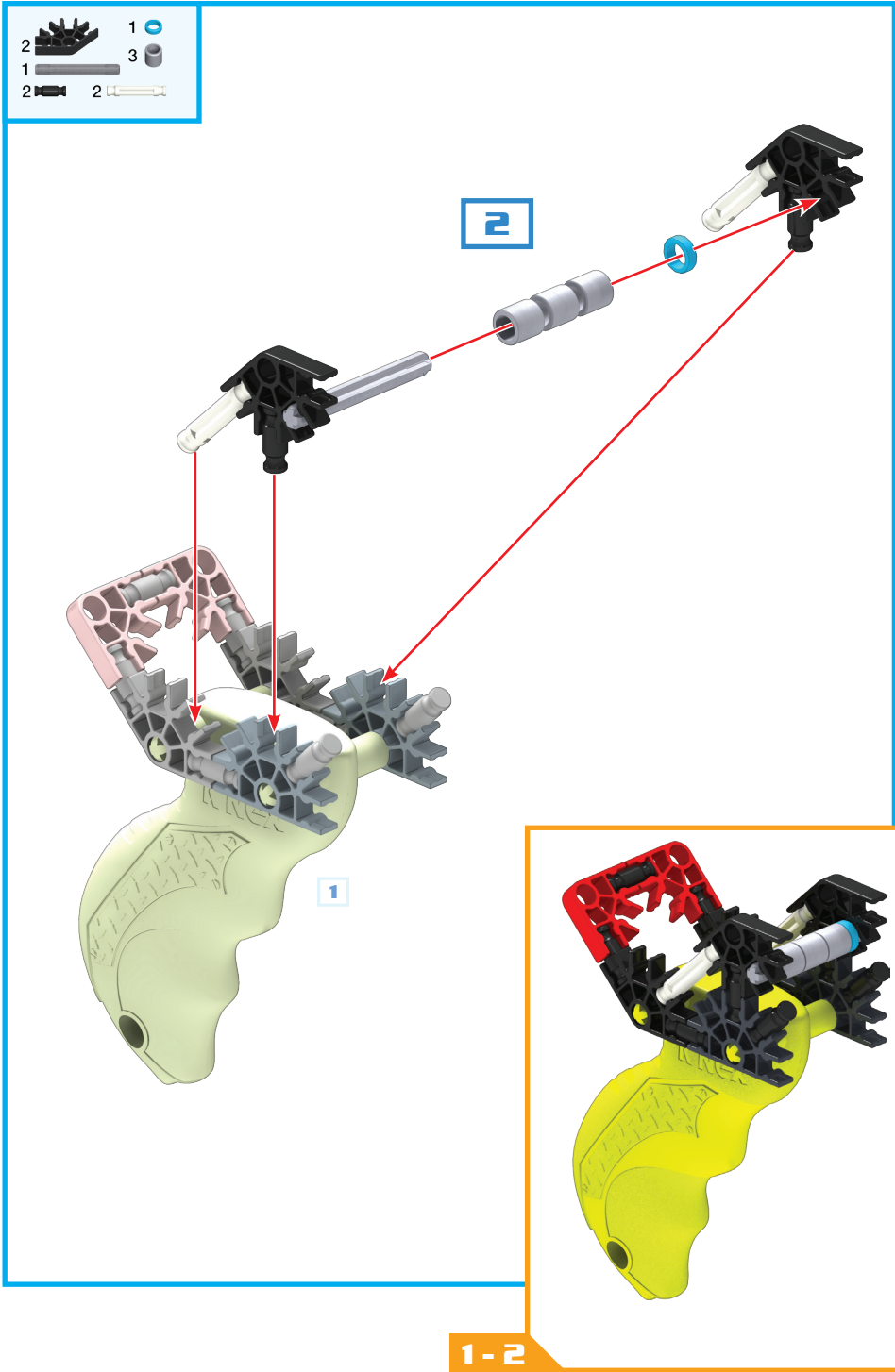

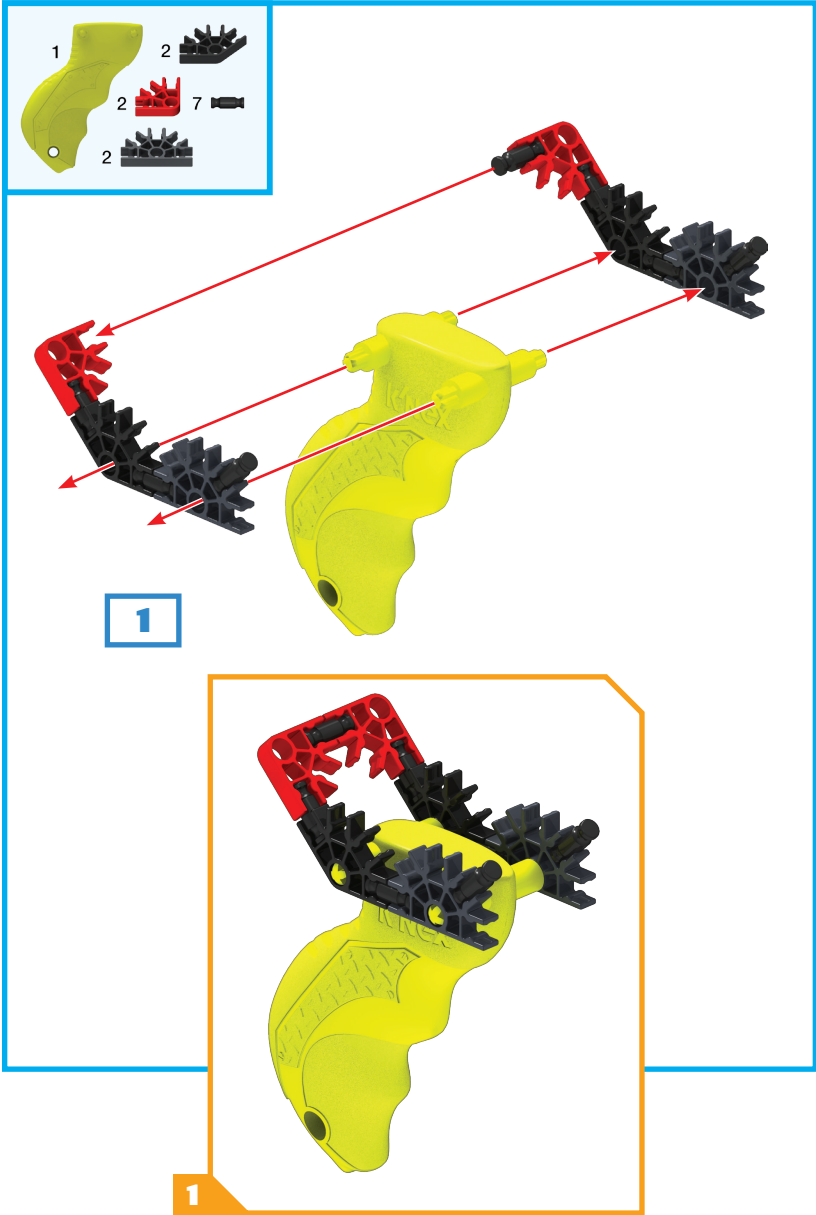







47526 Dual Cross Alt 2





- 1  2 
- 1  1  1 
- 1  2  2  1 

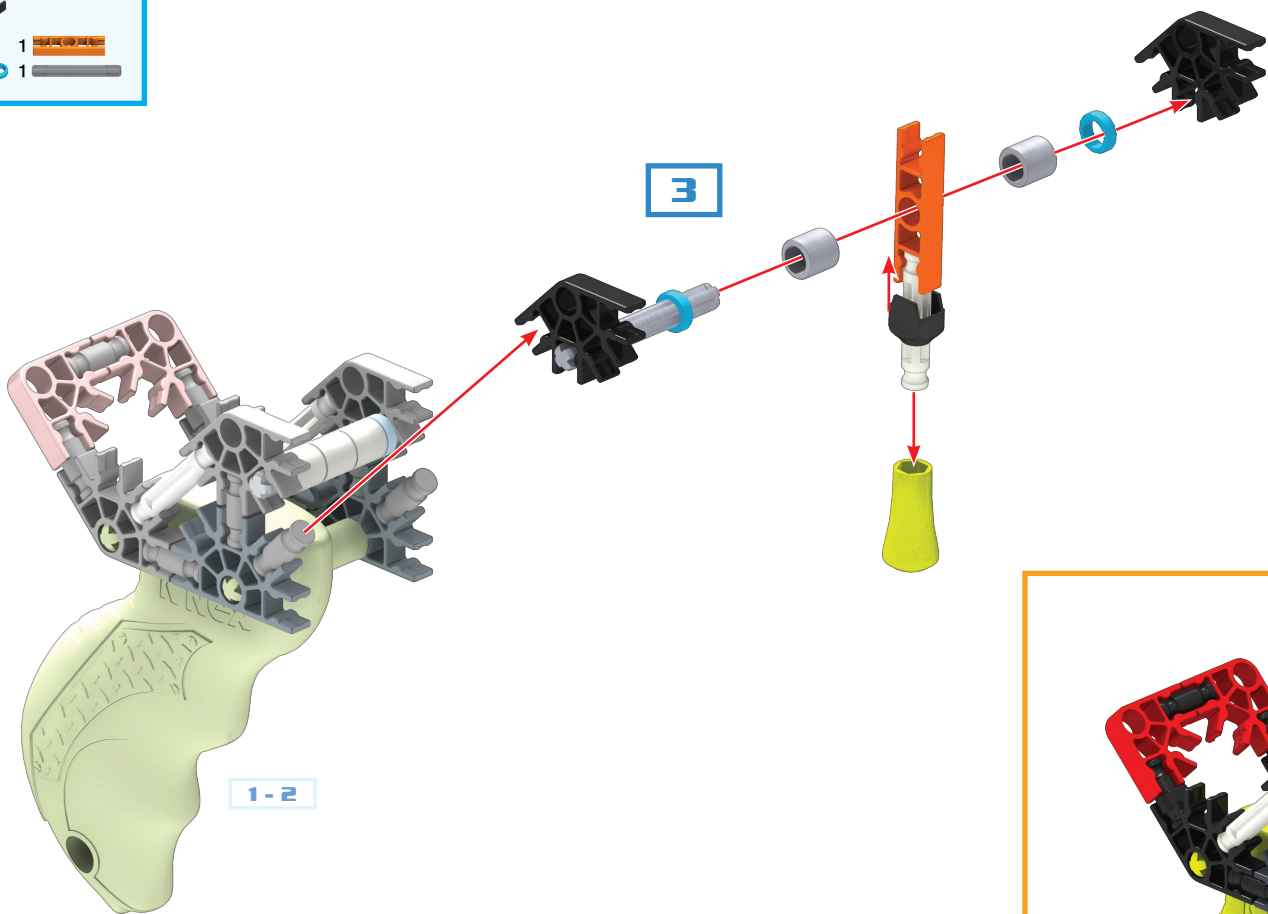

1-2





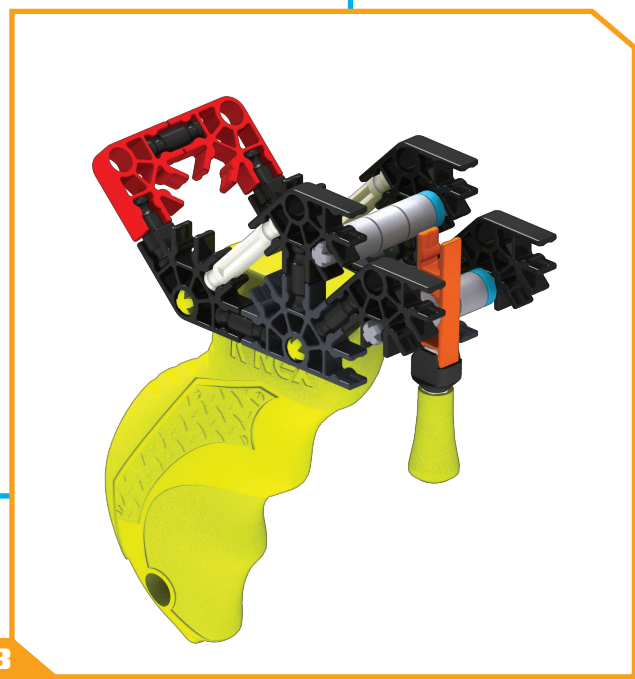

3

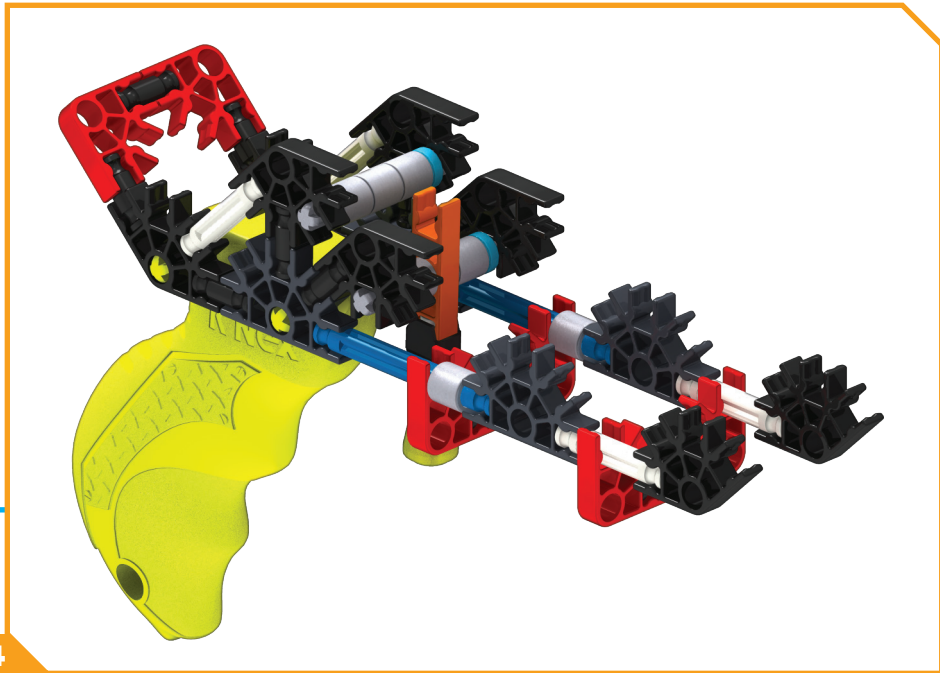
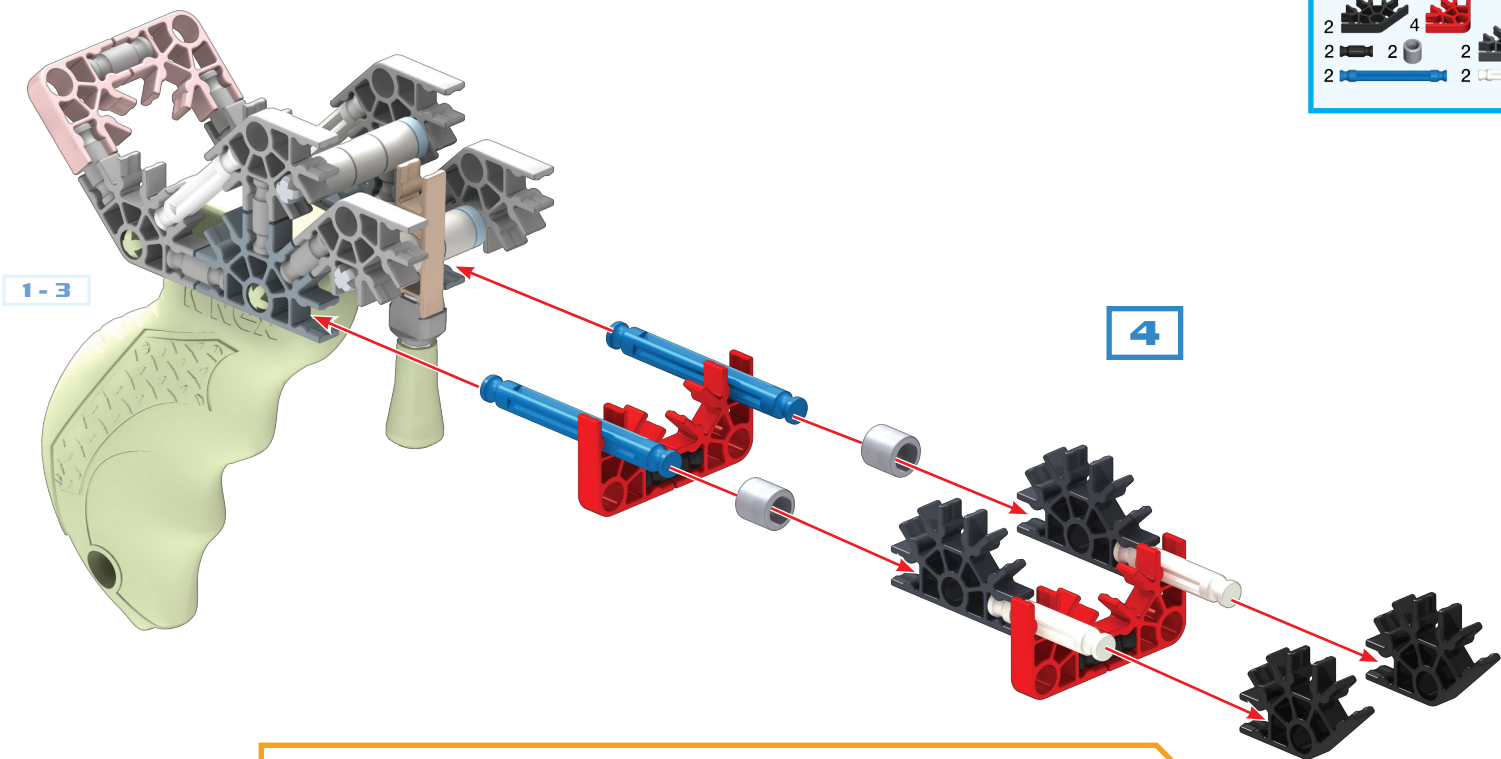
1-3



2		4		2	
2		2		2	
2		2		2	



- 1  4  2 
- 2  4  6 
- 1 

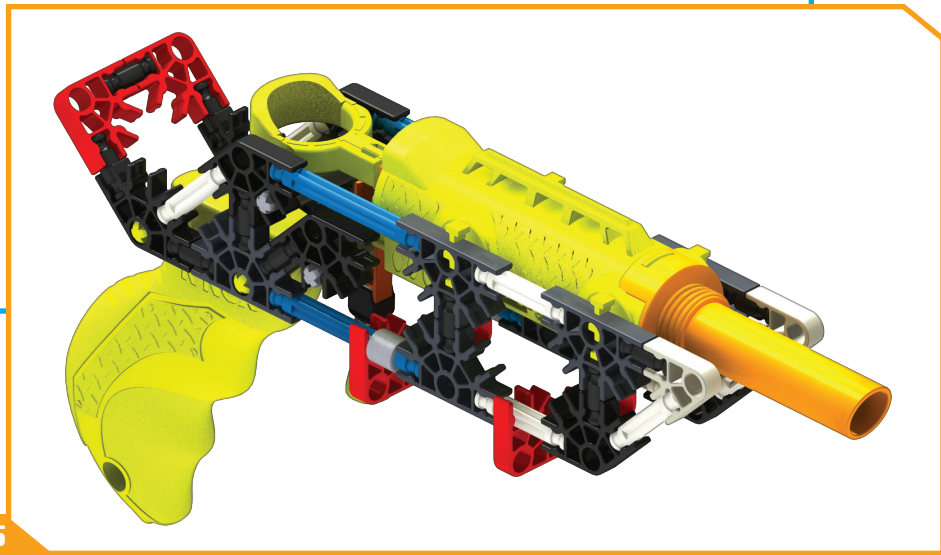
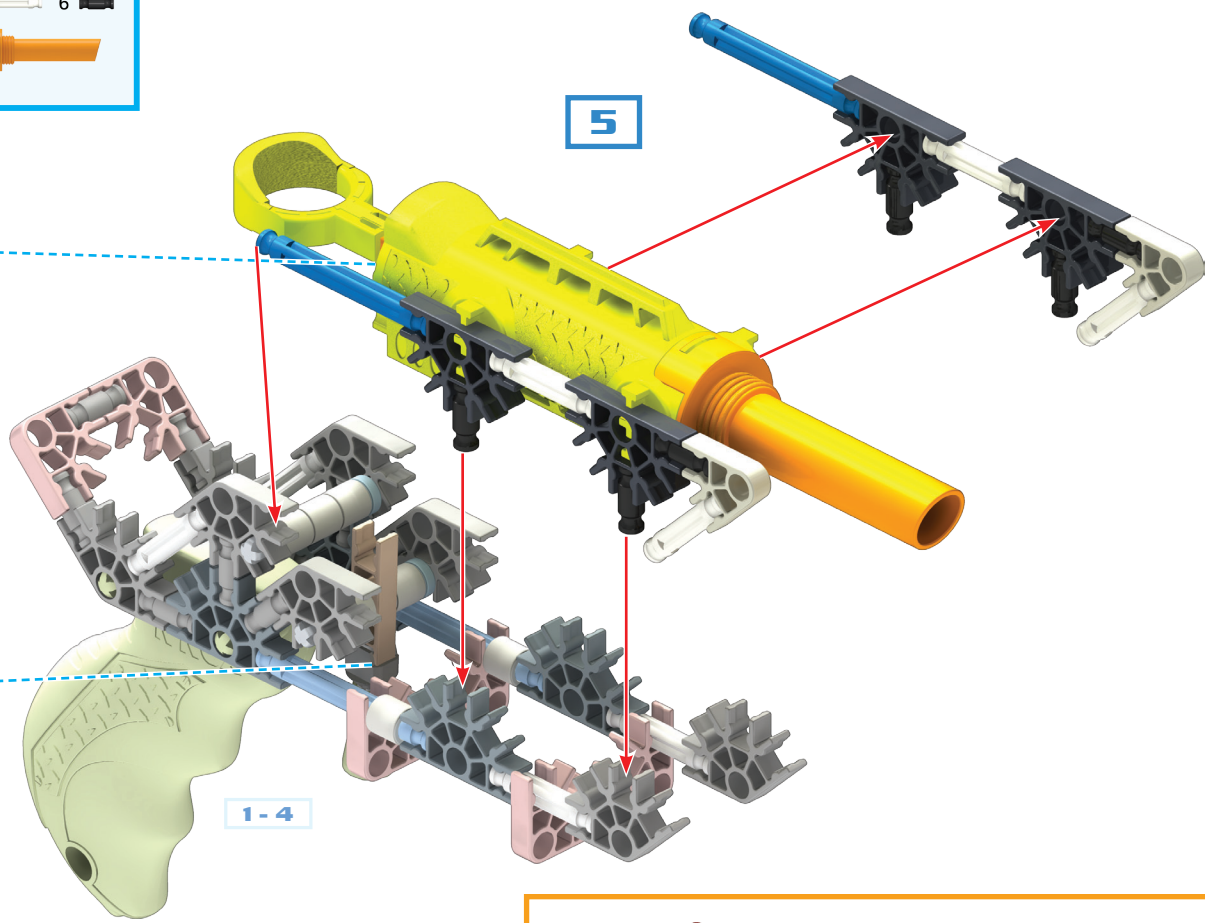
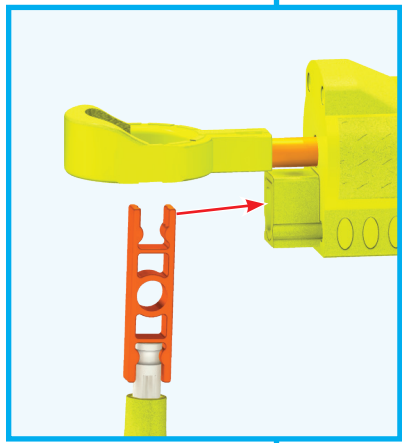

7

3



1-5



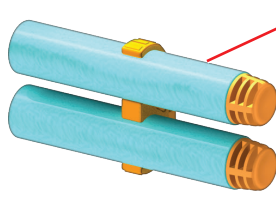
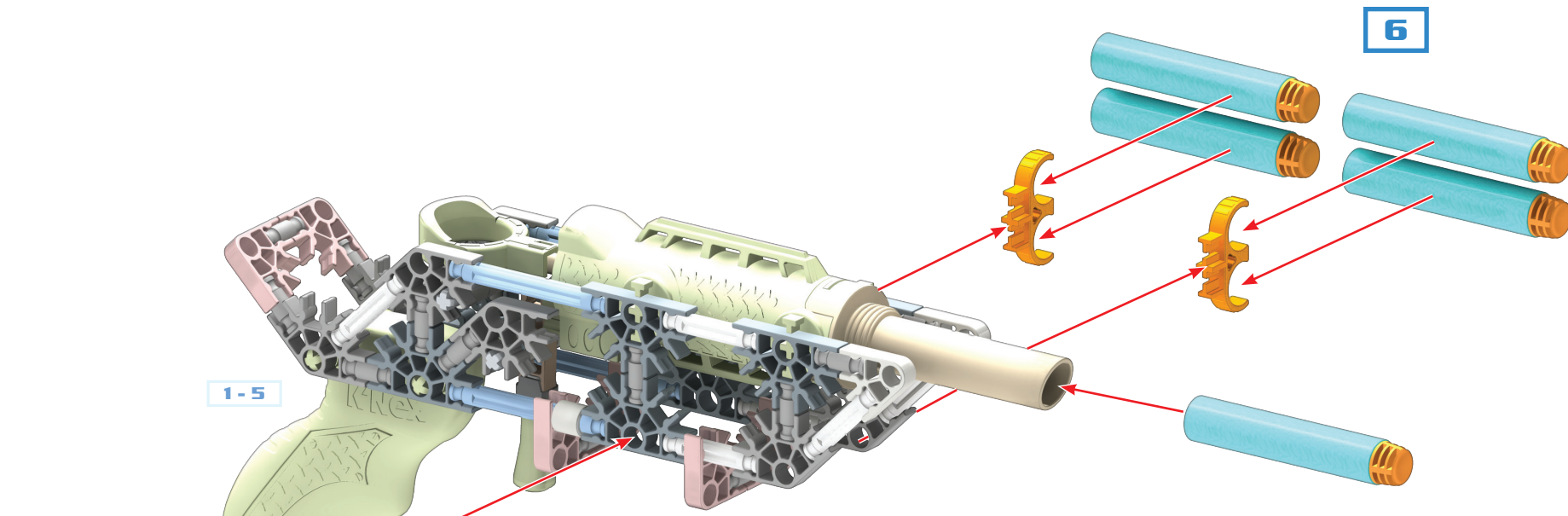

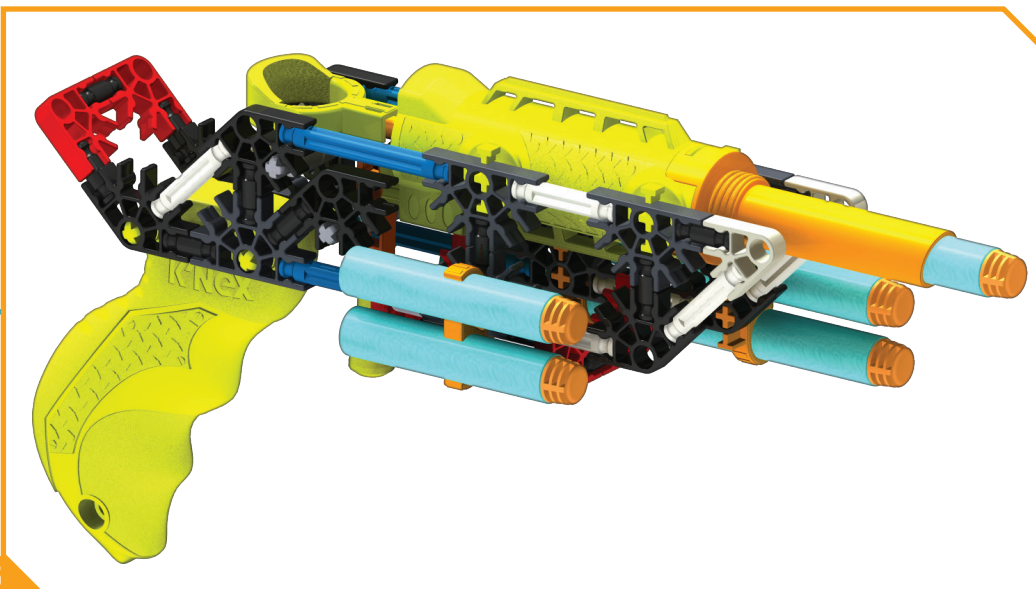

6

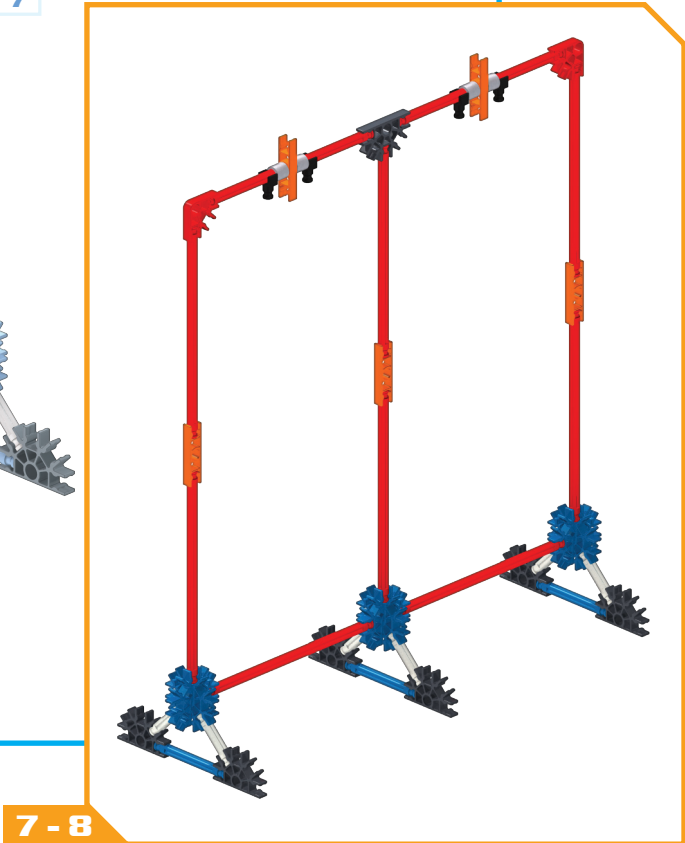
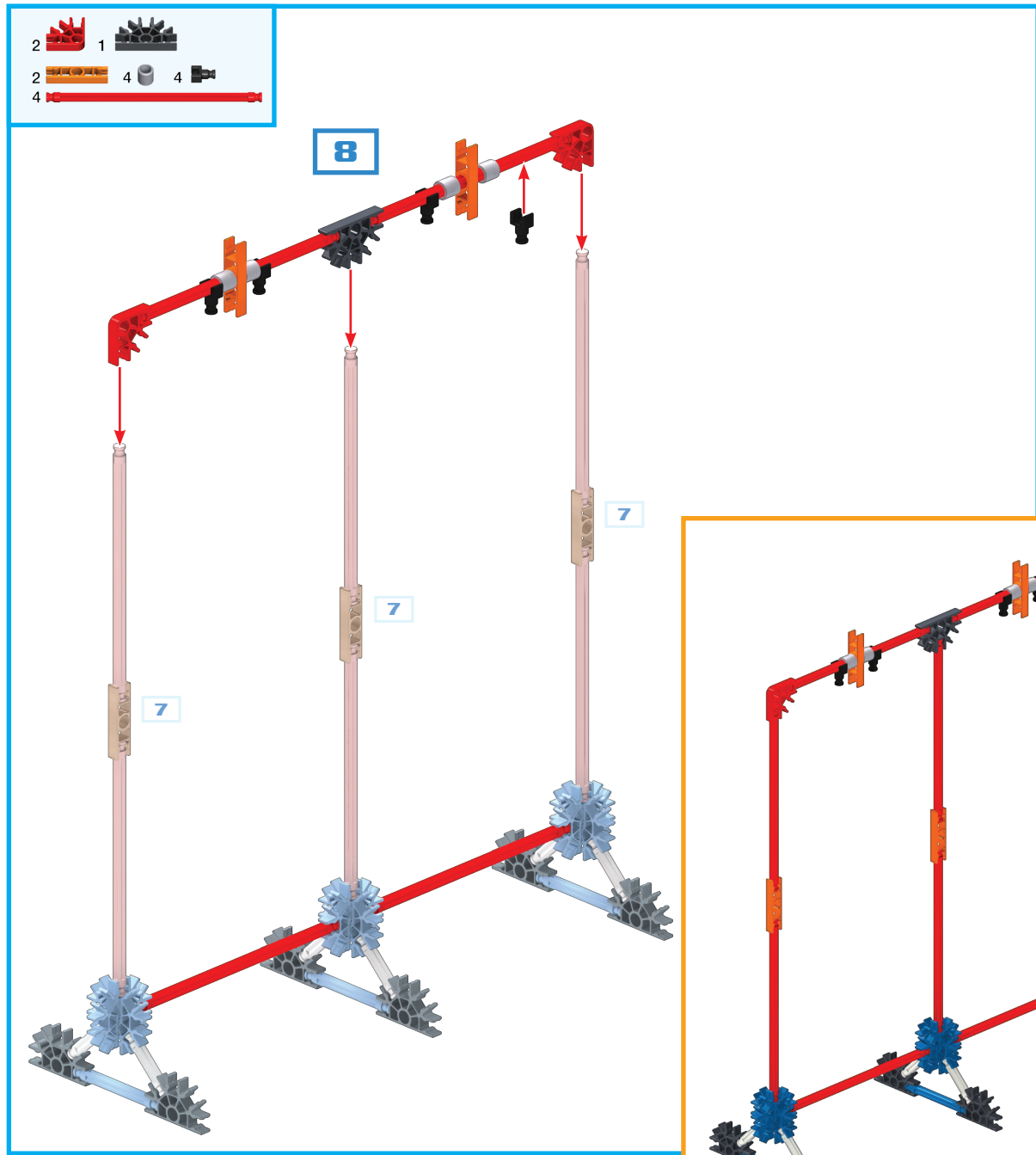
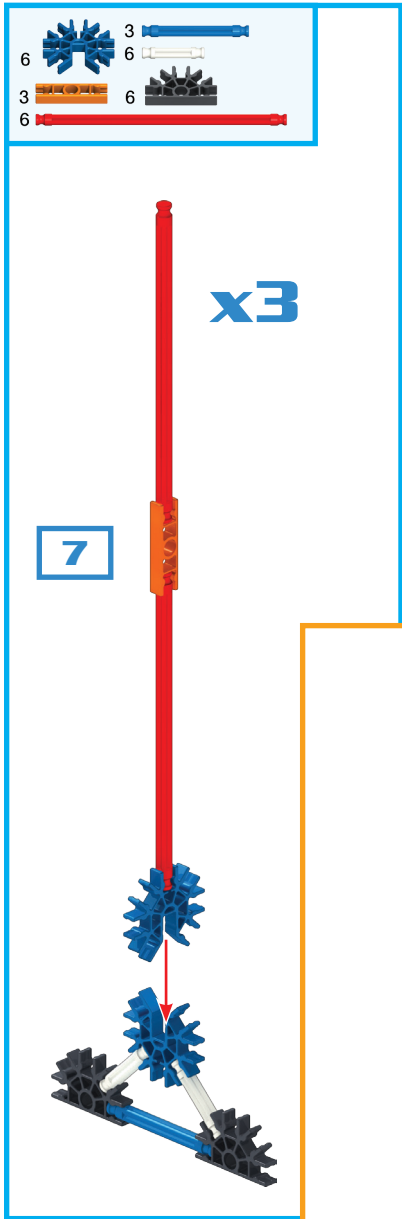

1-6





- 4  8  2 
- 2  2 
- 2  2 

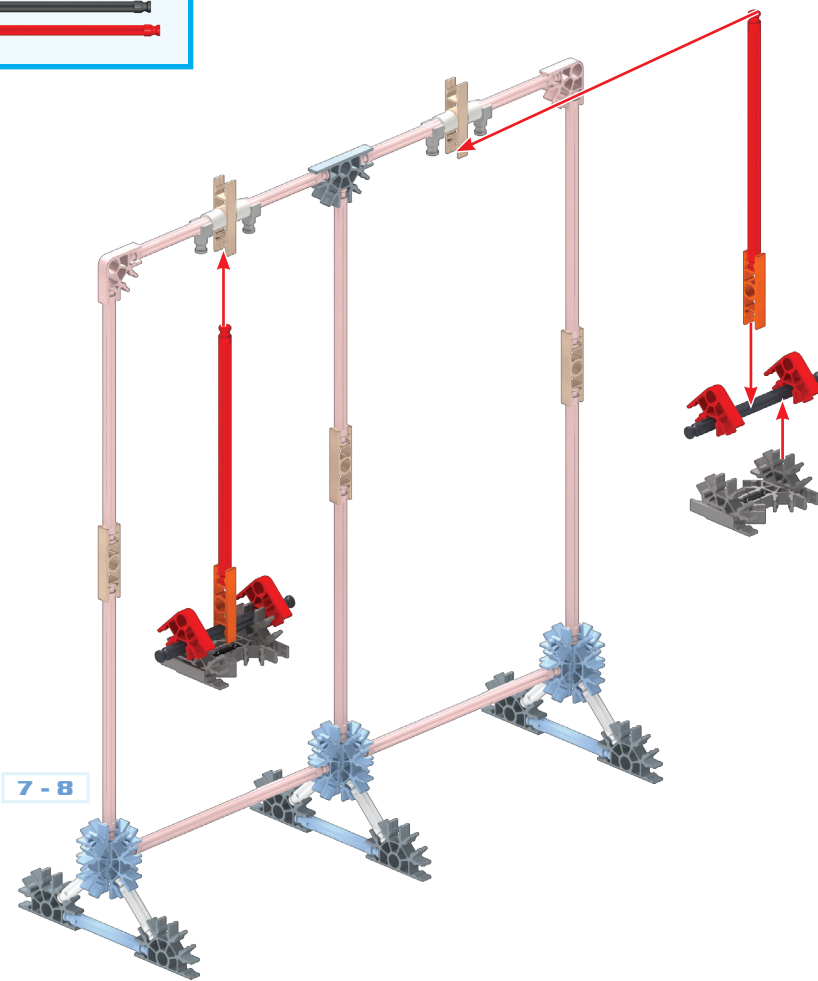

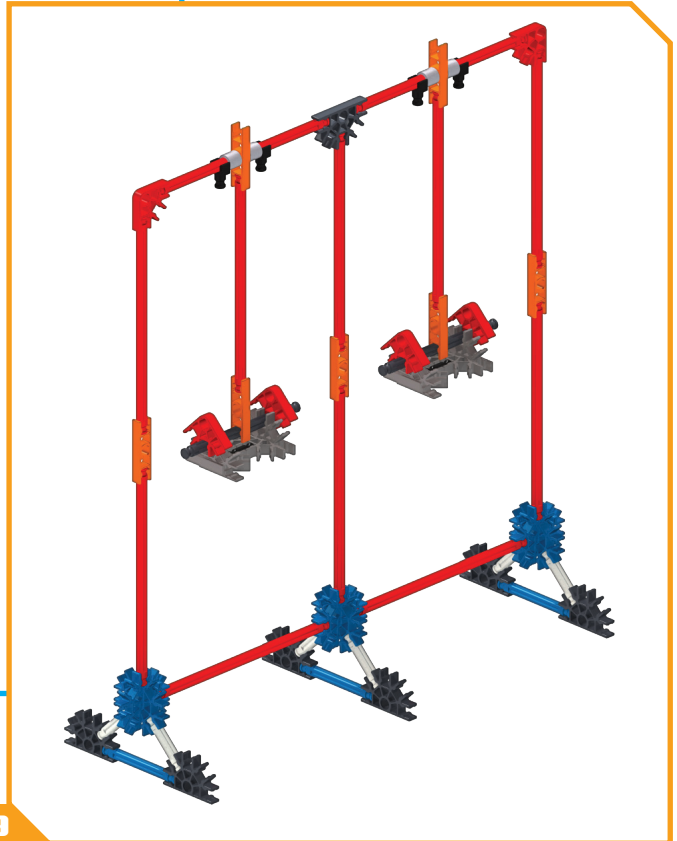

7-8

9



7-9

10

- 2 
- 4 
- 4 

7-9

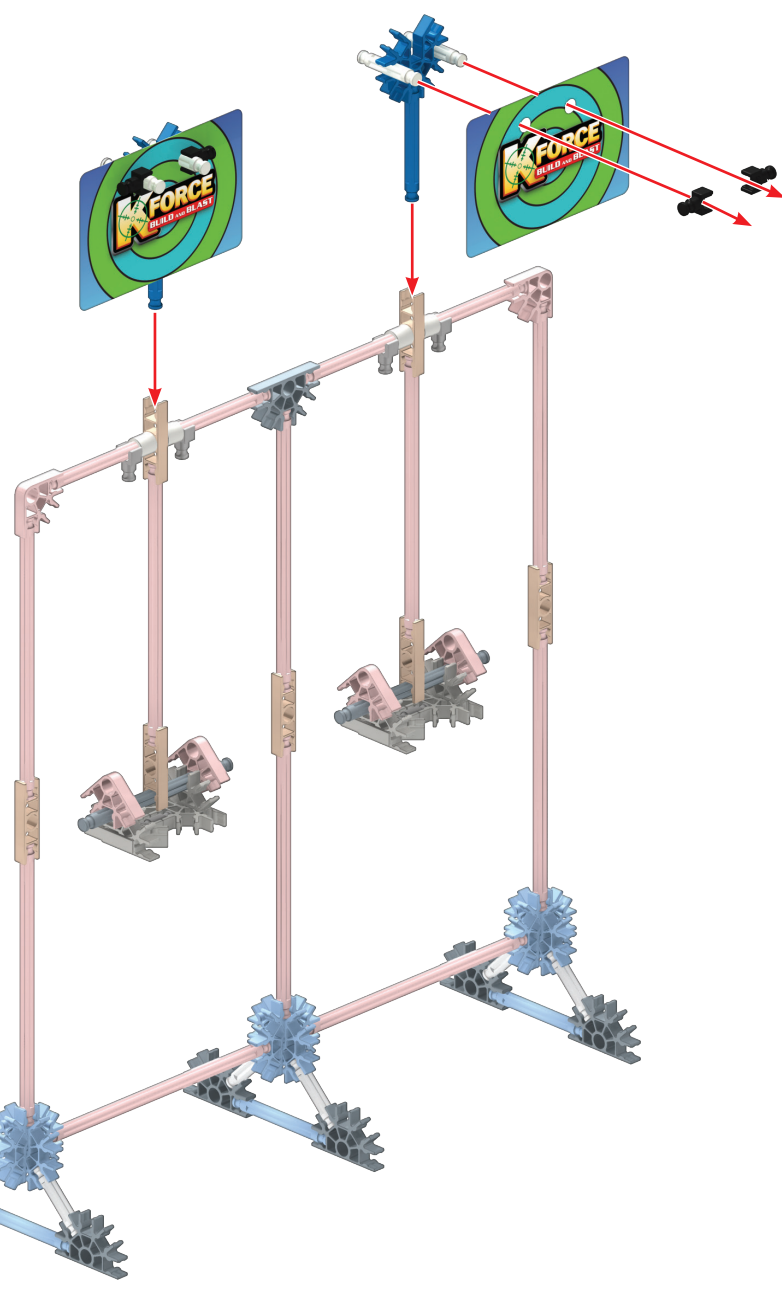

1-10