

K'NEX

Imagine • Build • Play™

5+

FIRE RESCUE™

10 MODEL
BUILDING
SET™

MOTOR!
Moteur



⚠ WARNING:

⚠ AVERTISSEMENT:

CHOKING HAZARD - Small parts.
Not for children under 3 years.

DANGER D'ÉTOUFFEMENT - Pièces de petite taille.
Ne pas donner aux enfants de moins de 3 ans.

61024/71184

K'NEX

BUILDING BASICS

Start Building

To begin your model, find step number **1** and follow the numbers. Each piece has its own shape and color. Look at the pictures, find the pieces that match what you see, and connect them together. It helps to face your model in the same direction as the instructions while you build. The arrows show you where the parts connect, but not all connection points have arrows. The faded color parts are the ones you have already put together.

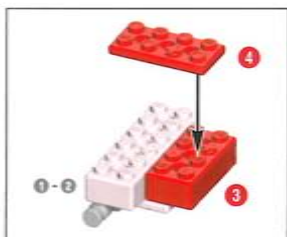
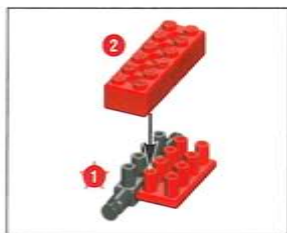

Connectors

You can slide these special connectors together. Push tightly until you hear a "click". Pay close attention to the instructions and position them horizontally or vertically exactly as they are shown.

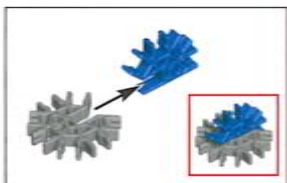
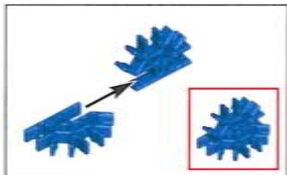
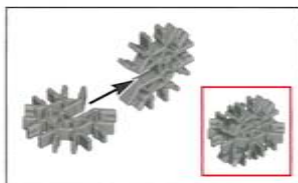

K'NEX Brick Separator Tool

Use this tool to pull K'NEX bricks apart.

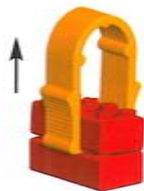

Stickers

Use this chart when applying the stickers to the bricks in your set.

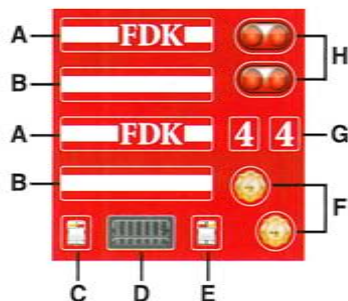

Spring Motor

CAUTION: Keep hands, face, hair, and clothing away from all moving parts. Toy will go in the direction of the arrow on the motor. Wind until you hear a clicking. Then release. Do not over wind.



FIRE COPTER

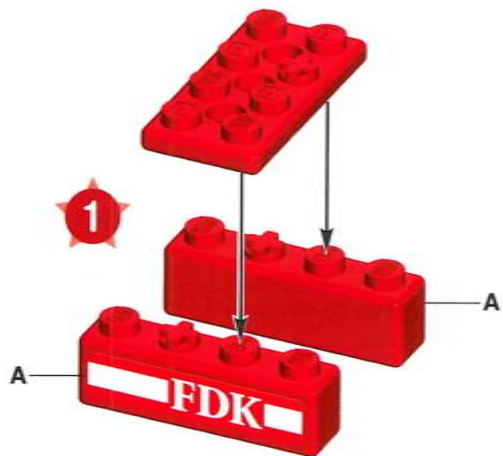
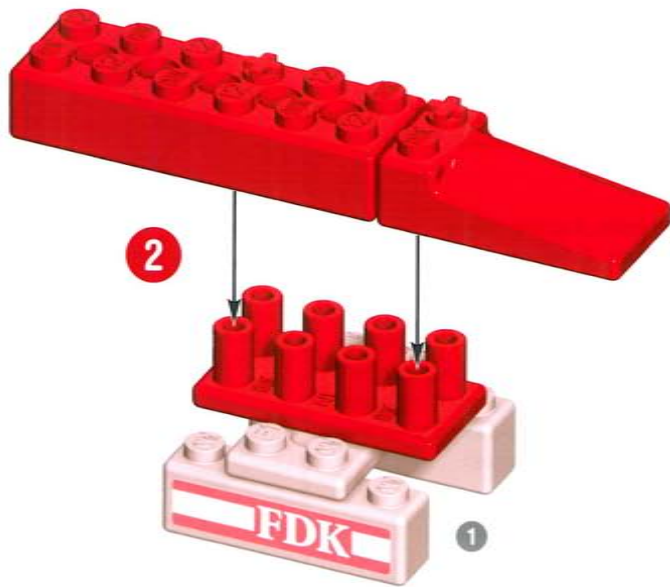

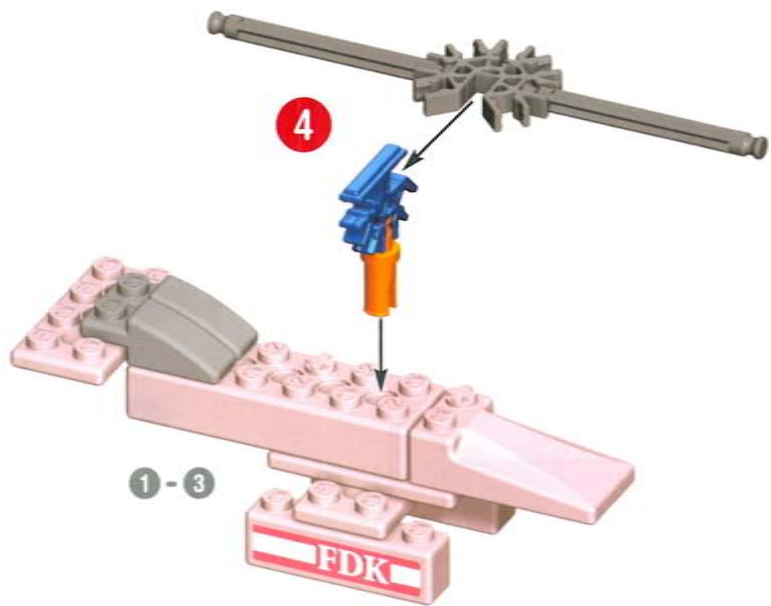
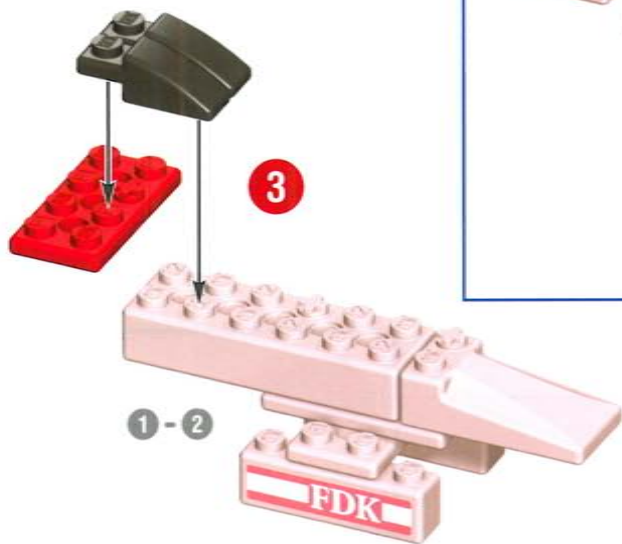

SMOKE JUMPER

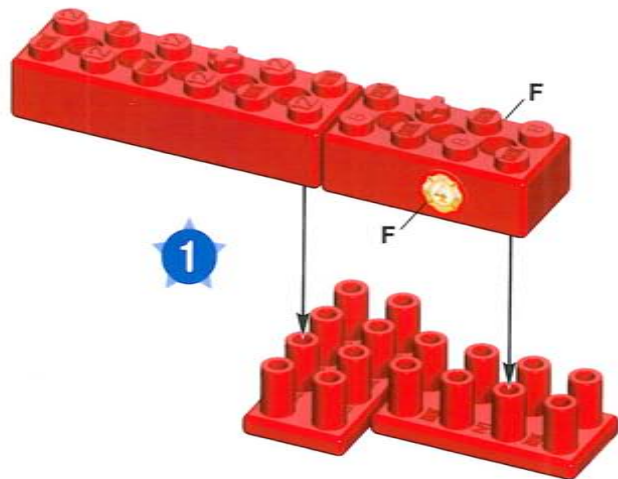
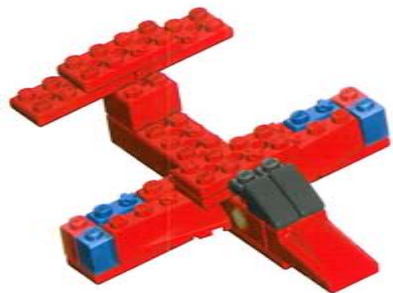

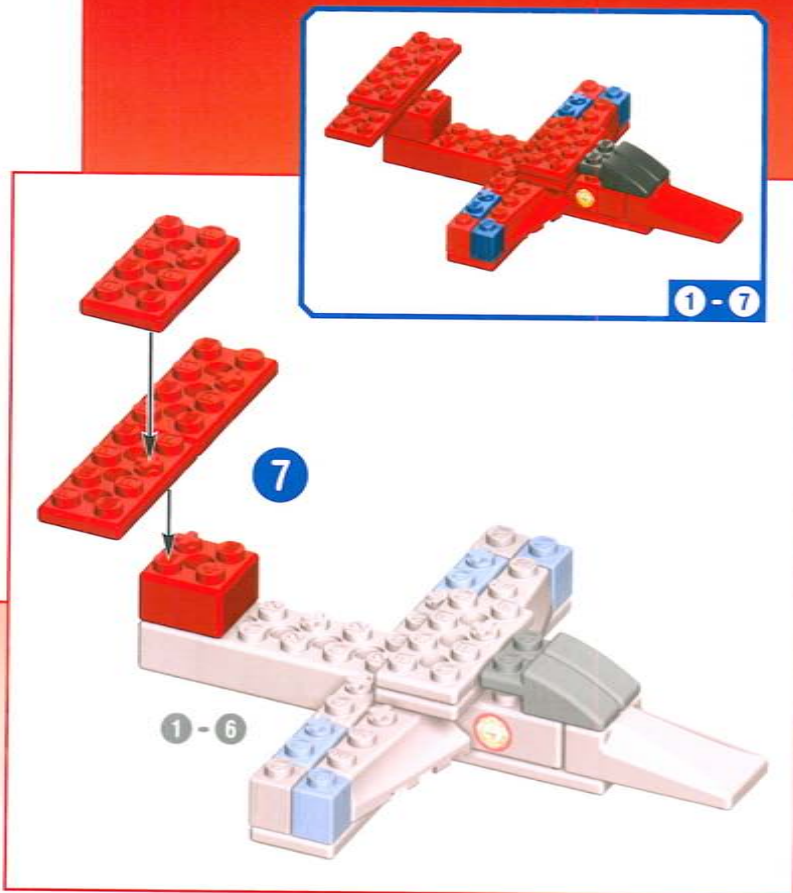
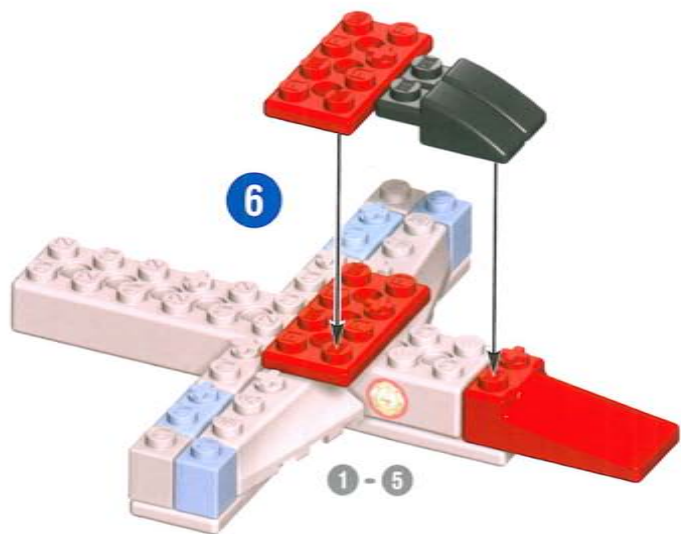

HOVER RESCUE

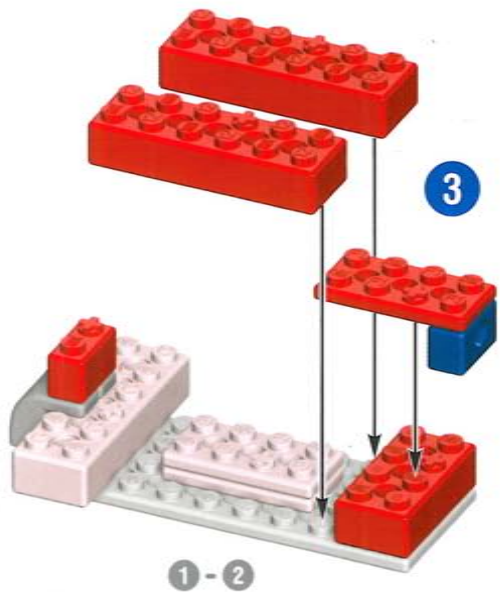
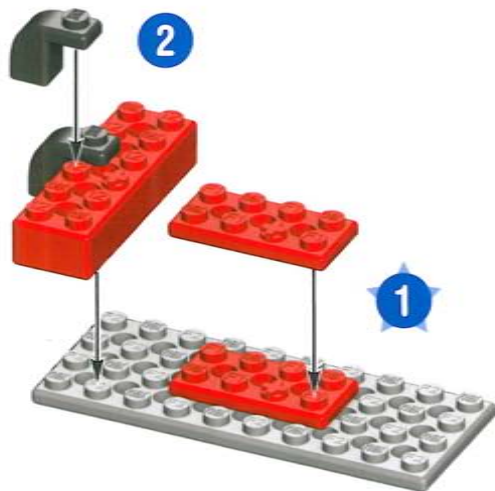
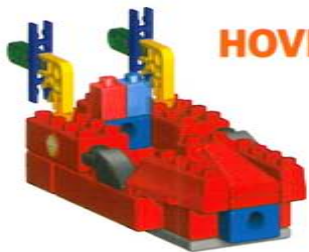

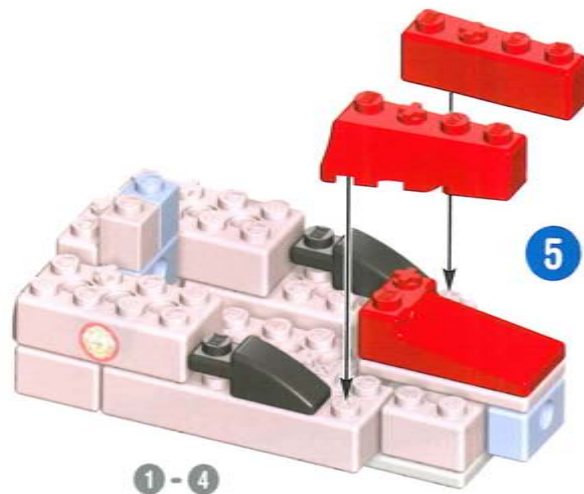
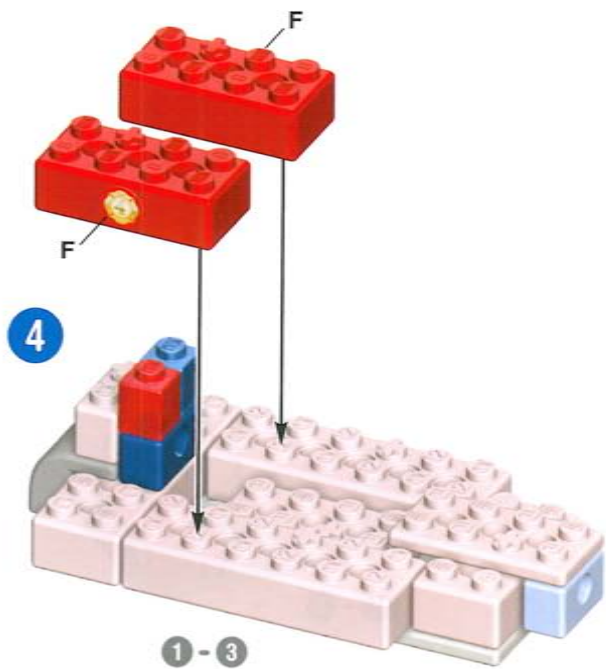

x2

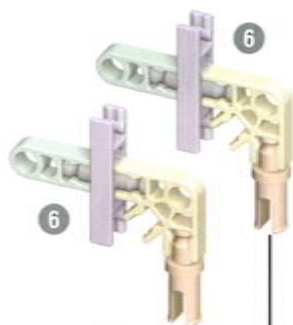
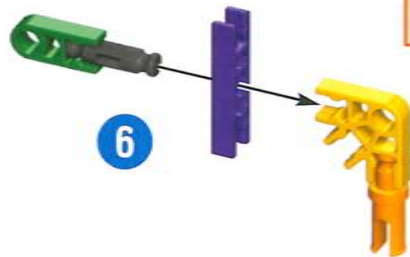

7



ATV

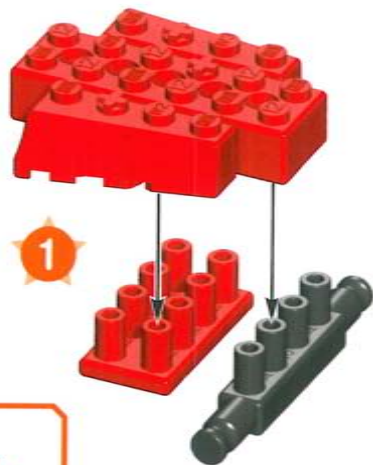

1



1

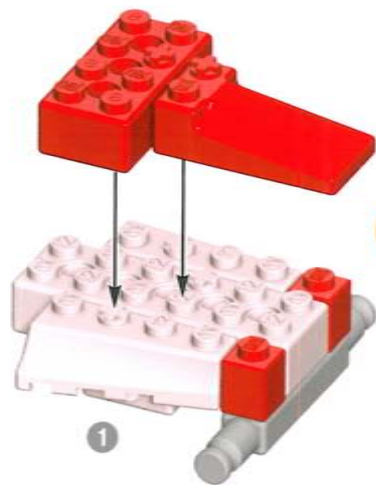

2



1-2

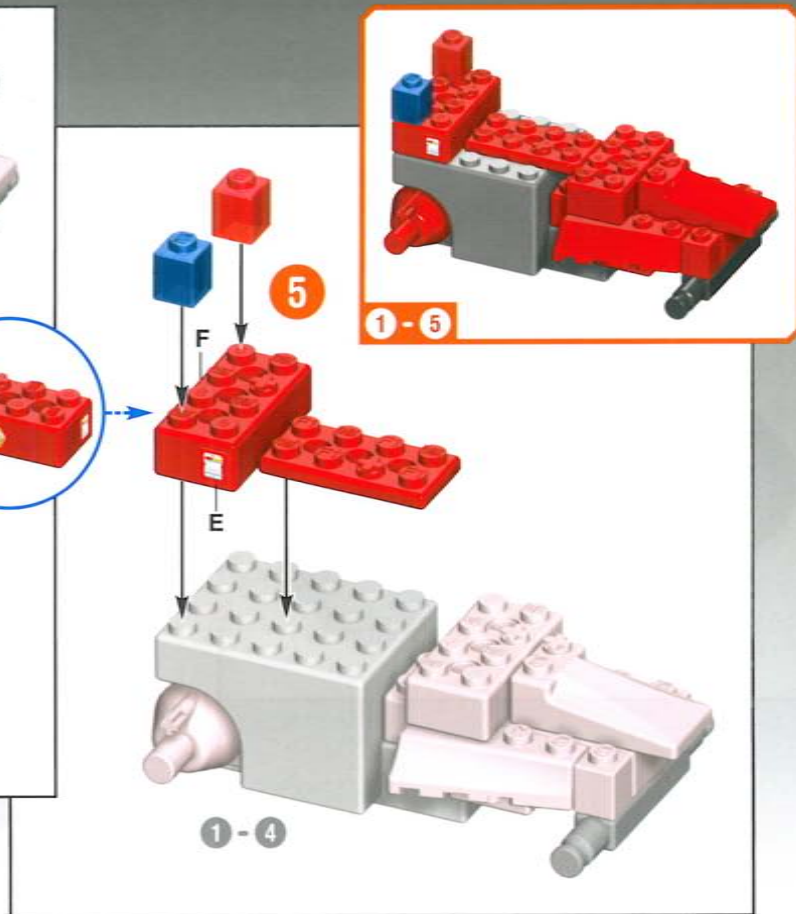
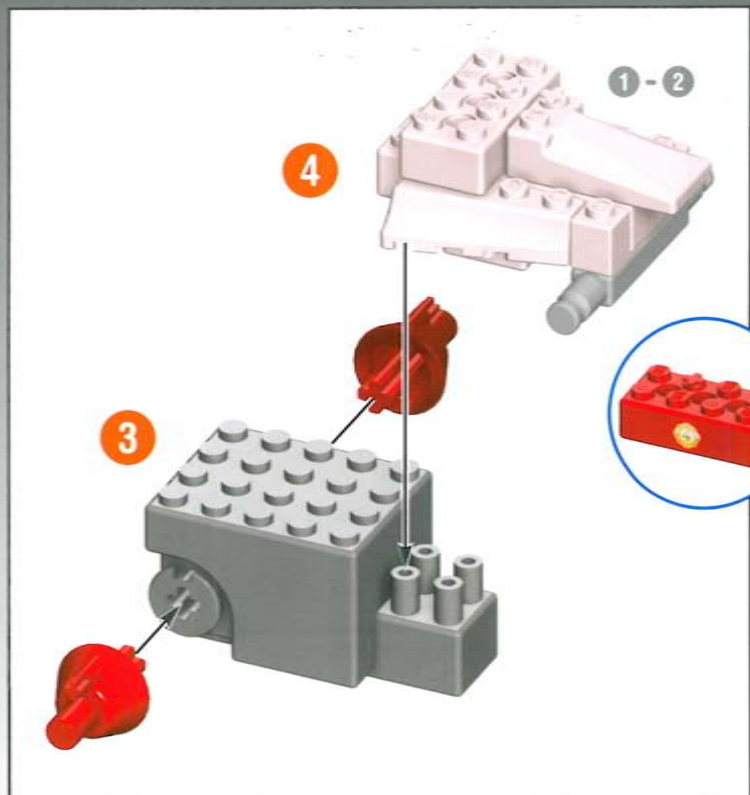





FIRE TRUCK

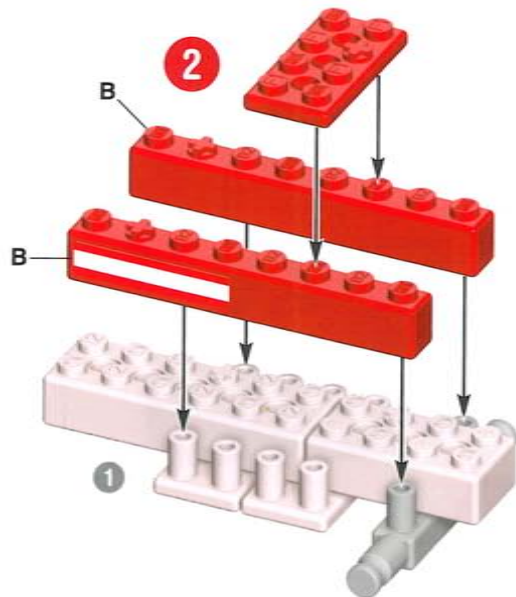
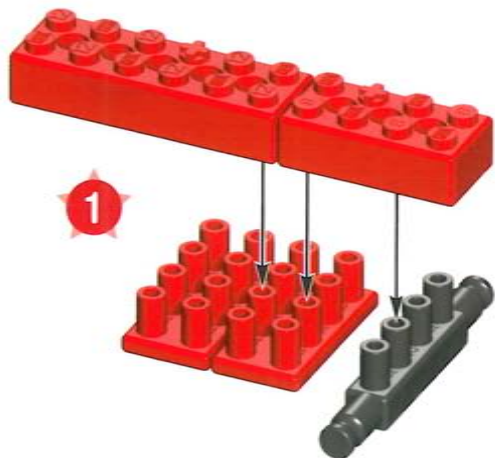

1 - 2



1 - 2

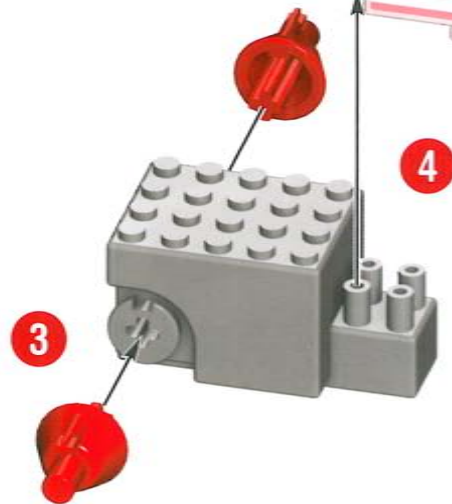

4

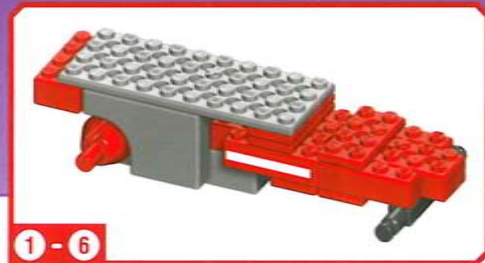

1 - 6

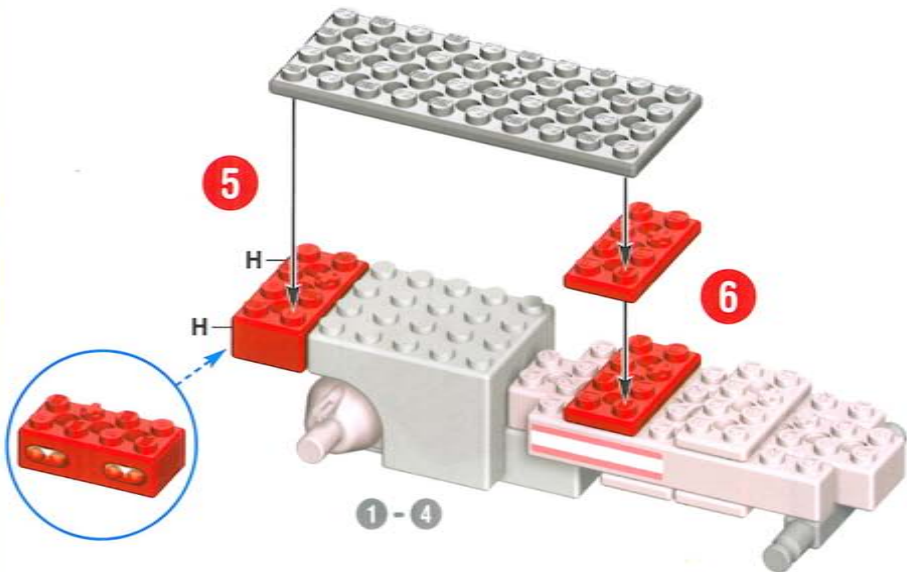

5

6

1 - 4

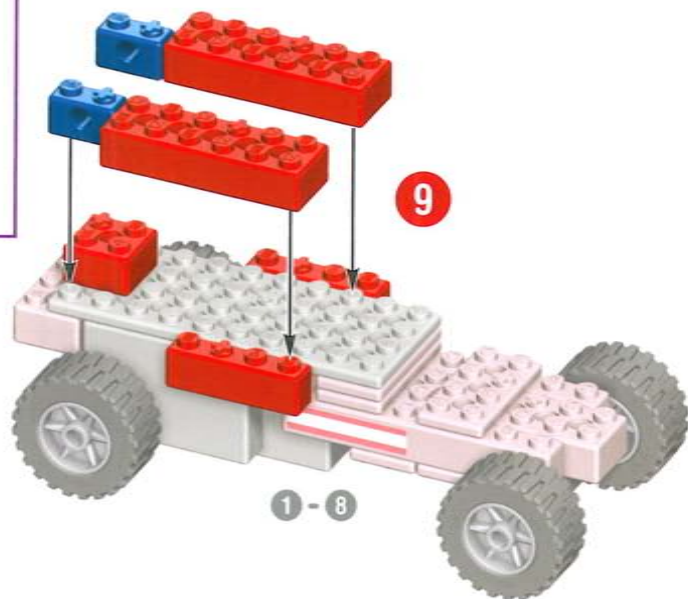

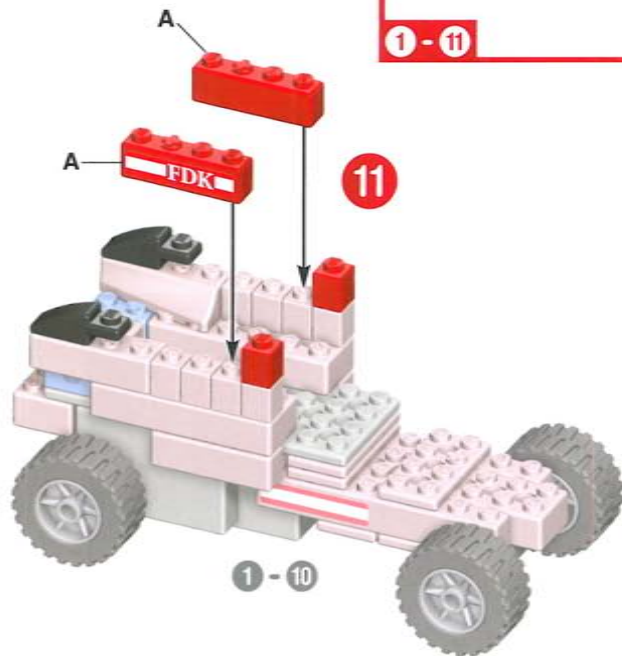
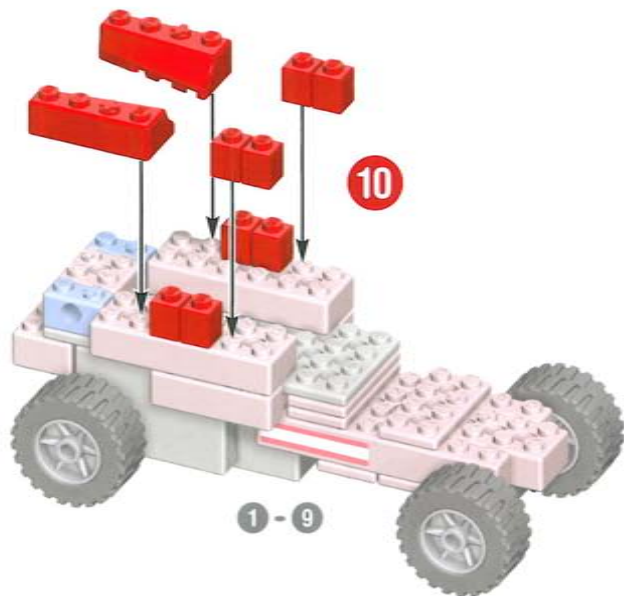

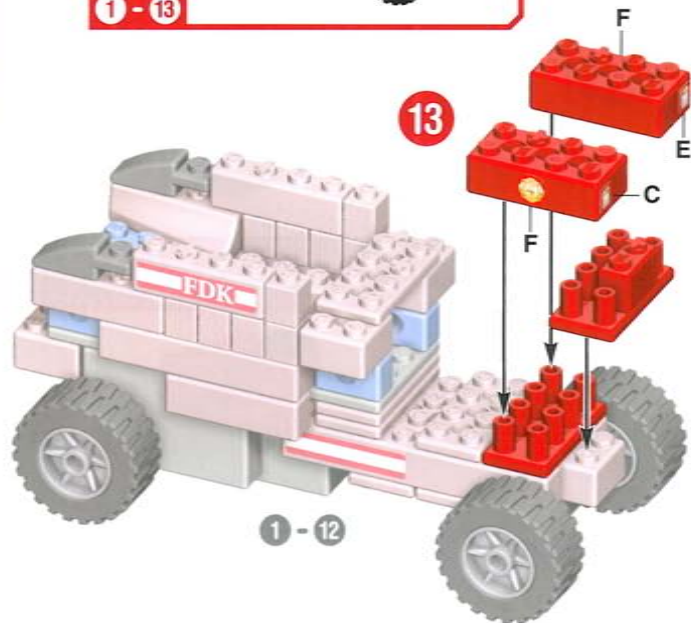
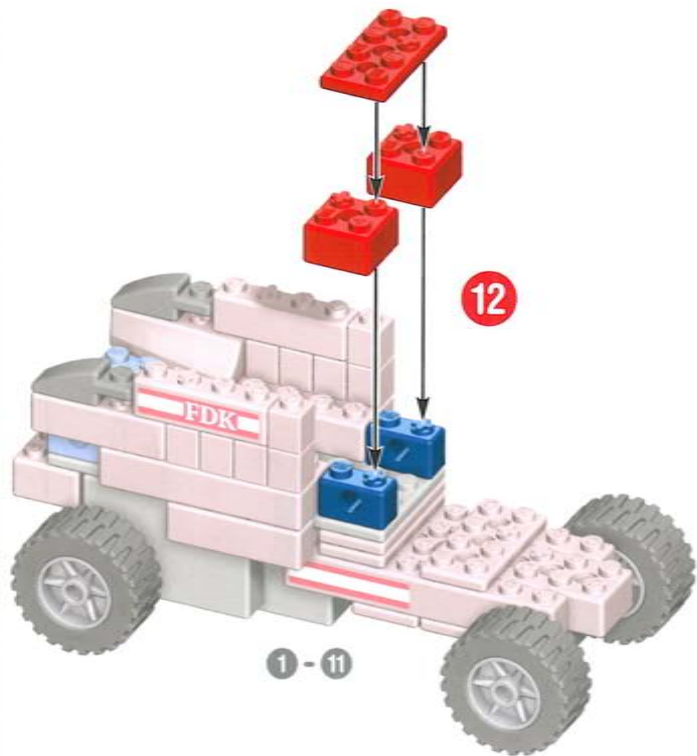

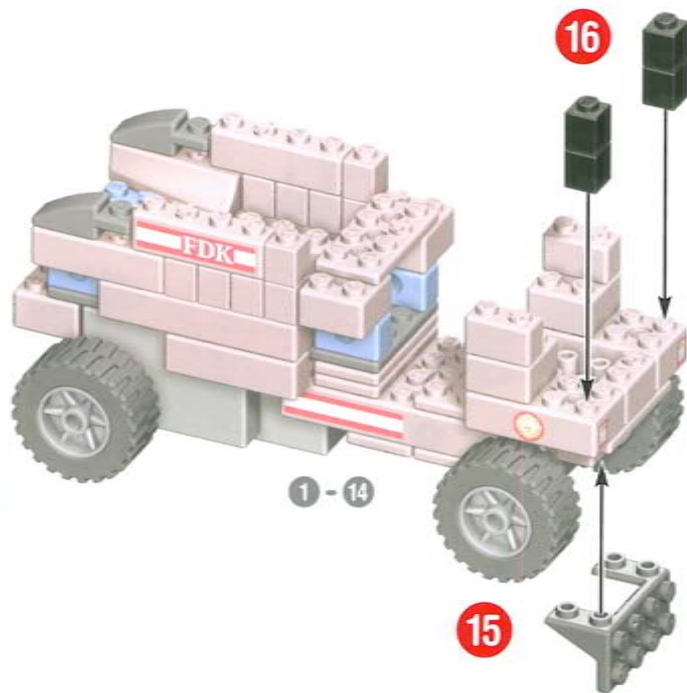
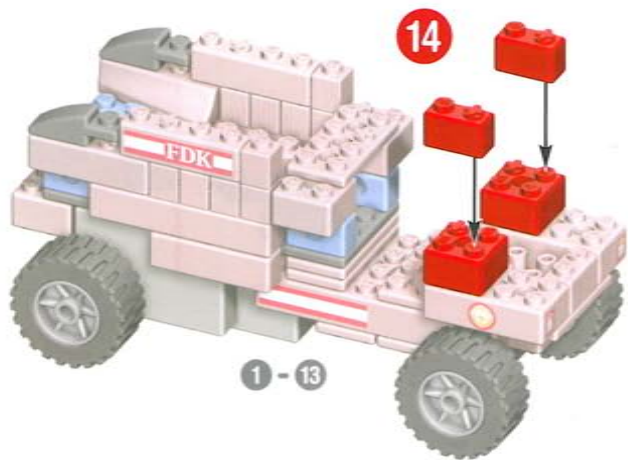

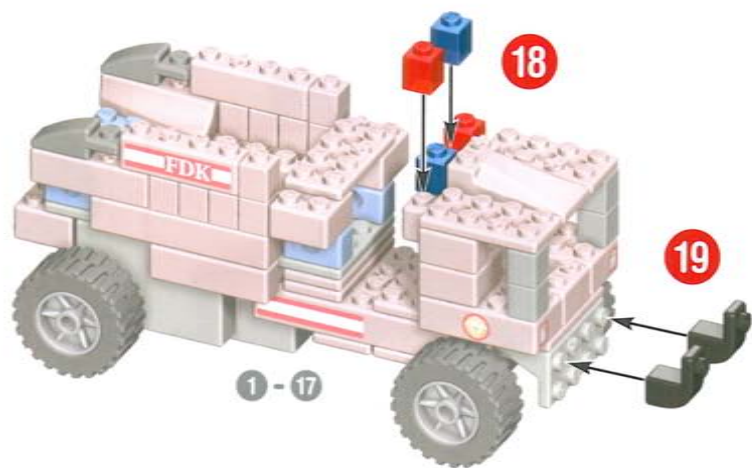
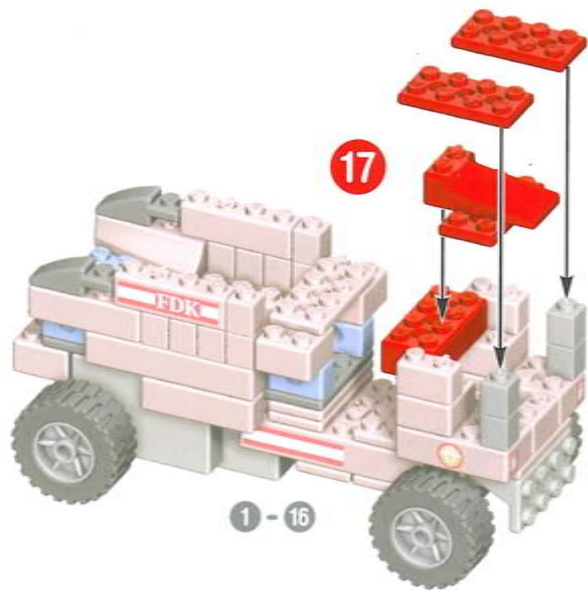

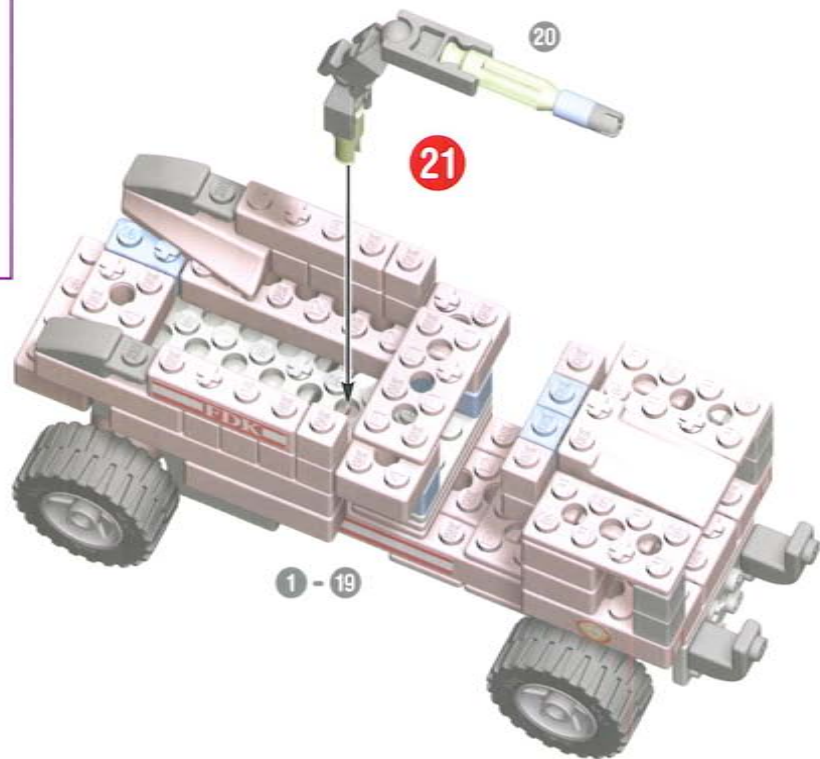
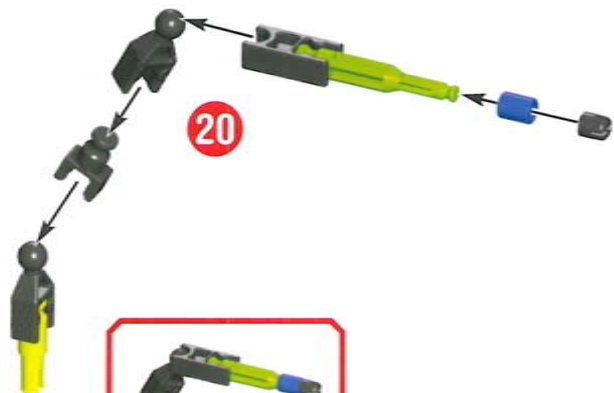

x2

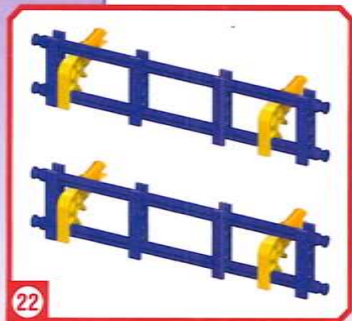

22



1 - 24

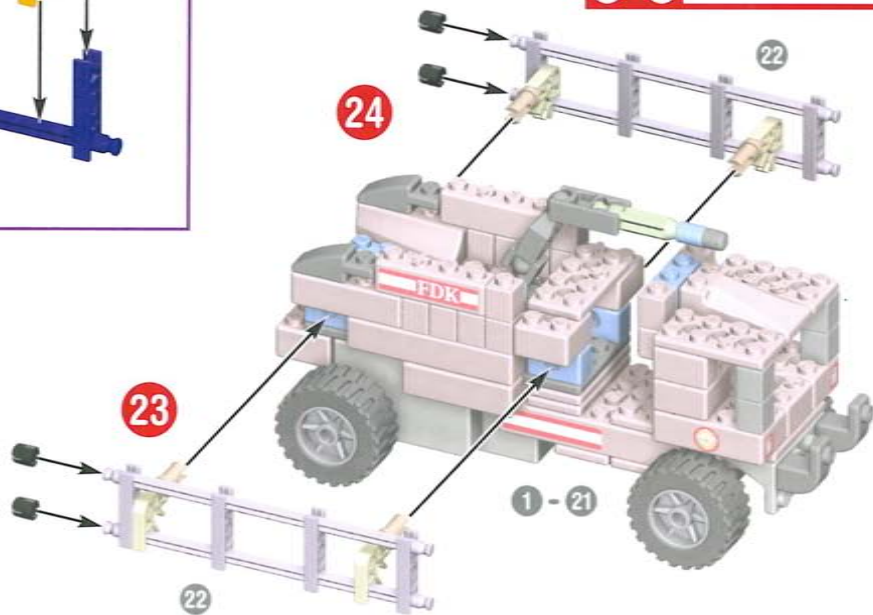

24

23

22

1 - 21

FIRE RESCUE™ Building Ideas



HYDRANT



TOOL TRUCK



FIRST RESPONSE



Visit www.knex.com/instructions
and enter code **61024** for instructions of
these Building Ideas.



RESCUE SUV



FIRE RESCUE™ **Building Ideas**

FIRE POLICE TRUCK



Visit www.knex.com/instructions
and enter code **61024** for instructions of
these Building Ideas.

FR Liste des pièces

Avant de commencer à construire, assure-toi de comparer les pièces dans ta boîte à la liste de pièces fournie ici. S'il manque quelque chose, téléphone-nous ou écris-nous en te servant des informations figurant au verso de la notice. Nous sommes là pour t'aider !

Notions de base K'NEX pour le montage

Commence la construction

Pour commencer ton modèle, trouve l'étape numéro 1 et suis les numéros. Chaque pièce a sa propre forme et sa propre couleur. Regarde les illustrations, trouve les pièces qui correspondent à ce que tu vois et assemble-les. Pour t'aider pendant que tu construis, oriente ton modèle dans le même sens que les instructions. Les flèches t'indiquent où les pièces s'assemblent, mais les points de raccordement n'ont pas tous des flèches. Les pièces de couleur délavée sont celles que tu as déjà assemblées.

Connecteurs

Tu peux assembler ces connecteurs tout à fait uniques en les faisant glisser l'un avec l'autre. Pousse fort jusqu'à ce que tu entendes un « clic ». Lis les instructions attentivement et positionne-les horizontalement ou verticalement, en suivant exactement les illustrations.

Outil pour séparer les briques

Sers-toi de cet outil pour détacher les briques K'NEX.

Designs

Utilise ce graphique quand vous appuyez sur ces designs sur votre modèle.

Moteur

ATTENTION : Garde les cheveux, les doigts, la figure et les vêtements à l'écart de toutes les pièces mobiles. Le jouet ira dans le sens de la flèche située sur le dessus du moteur. Remonte jusqu'à ce que tu entendes un clic, puis relâche. Ne remonte pas trop.

Idées de jouet

Visite knex.com/instructions et entre le code **61024** pour trouver des instructions pour ces idées de jouet.

Pour d'autres instructions K'NEX

Visite knex.com/instructions et clique sur « **combo builds** » pour d'autres instructions K'NEX.

ES Lista de piezas

Antes de empezar con la construcción, asegúrate de comparar las piezas en tu conjunto con la lista de las piezas aquí. Si faltan algunas, llámanos o escríbenos siguiendo las instrucciones en la página trasera. Estamos aquí para ayudarte.

Consejos básicos de construcción de K'NEX

A construir

Para empezar tu modelo, es necesario buscar el paso número 1 y seguir los números. Cada pedazo tiene su propia forma y su propio color. Mira las imágenes, busca los pedazos que corresponden con lo que se ve y conecta los. Durante la construcción, te ayudará si tienes el modelo en la misma dirección que las instrucciones. Las flechas muestran donde las partes se conectan; sin embargo, no todos los puntos de conexión tienen flechas. Las partes descoloradas son las que ya se han conectado.

Conectores

Se puede juntar estos conectores especiales deslizándolos. Empujar ligeramente hasta oír un "clic". Hace falta

prestar mucha atención a las instrucciones y posicionar los conectores horizontal o verticalmente exactamente tal como se muestran.

Separador de ladrillos

Esta herramienta se utiliza para separar los ladrillos K'NEX.

Adhesivas

Use este cuadro cuando usted presiona estas etiquetas adhesivas en el modelo.

Motor

PRECAUCIÓN: Mantén el cabello, los dedos, la cara y la ropa alejada de las piezas móviles.

El juguete va en la dirección que indica la flecha que está en la parte superior del motor. Dale cuerda hasta que oigas un clic. Luego suéltalo. No des demasiada cuerda.

Ideas de juguete

Visitar knex.com/instructions y entrar el código **61024** para buscar instrucciones para estas ideas de juguete.

Para más instrucciones de K'NEX

Visitar knex.com/instructions y hacer clic en "**combo builds**" para más instrucciones de K'NEX.

DE Teilleiste

Bevor du mit dem Bauen anfängst, solltest du prüfen ob die Teile in deinem Bausatz mit denen auf dieser Teilleiste übereinstimmen. Falls etwas fehlt, rufe uns an oder schreibe uns (siehe Rückseite). Wir sind für dich da!

Grundlegende Bauanleitungen für K'NEX

Los geht's mit dem Bauen

Beginne mit dem Bauen des Modells beim 1. Schritt und folge den Zahlen. Jedes Teil hat seine eigene Form und Farbe. Schau die Bilder an, suche nach den passenden Teilen zu den Bildern und füge sie richtig zusammen. Halte dein Modell während des Zusammenbaus möglichst genau so wie in der Anleitung. Die Pfeile deuten an, wo die Teile zusammengefügt werden. Allerdings haben nicht alle Verbindungspunkte Pfeile. Die bereits zusammengefügt Teile sind in blassen Farben abgebildet.

Verbindungsstücke

Diese besonderen Verbindungsstücke kannst du zusammenschieben. Drücke sie fest, bis du ein Klicken hörst. Achte genau auf die Anleitung und positioniere die Verbindungsstücke genau wie in der Abbildung.

Stein-Separator

Mit diesem Werkzeug werden K'NEX-Steine auseinander gezogen.

Aufkleber

Schau Sie auf dieses Bild, bevor Sie die Aufkleber beifügen.

Motor

VORSICHT: Haare, Finger, Gesicht und Kleidungsstücke nicht mit beweglichen Teilen in Berührung kommen lassen.

Das Spielzeug bewegt sich in Richtung des Pfeils am Motor oben. Ziehe es so weit auf, bis ein Klicken zu hören ist. Lasse es dann los. Nicht überdrehen!

Spielideen

Besuche knex.com/instructions gib den Code **61024** ein, um eine Anweisung für diese Spielideen zu erhalten.

Für weitere K'NEX-Anleitungen

Besuche knex.com/instructions und klicke auf „**Combo Builds**“ für weitere K'NEX-Anleitungen.

IT Elenco delle parti

Prima di cominciare a costruire, accertati di confrontare le parti che sono nel tuo set con l'elenco delle parti qui. Se ne manca una chiamaci o scrivi usando le informazioni che sono nella retrocopertina. Noi siamo qui per aiutarti!

Il fondamentale di costruzione di K'NEX

Cominciare la costruzione

Per cominciare il tuo modello, trova il passo numero 1 e segui i numeri. Ogni pezzo ha la sua forma e il suo colore. Guarda le figure, trova i pezzi che corrispondono a ciò che vedi e congiungili insieme. È un aiuto se tieni il tuo modello di fronte a te nella stessa direzione delle istruzioni mentre costruisci. Le frecce ti indicano dove sono congiunte le parti ma non tutti i punti di congiunzione hanno le frecce. Le parti con i colori sbiaditi sono quelle che hai già messo insieme.

Connettori

Puoi infilare insieme questi connettori speciali. Spingi bene finché non senti un "clic". Fa' ben attenzione alle istruzioni e mettili orizzontalmente o verticalmente esattamente come viene mostrato.

Arnese per separare i mattoncini

Usa questo arnese per smontare i mattoncini K'NEX.

L'adesivo disegni

Guardate questa immagine prima di attaccare l'adesivo disegni.

Motore

ATTENZIONE: Tenere i capelli, le dita, il viso e i vestiti lontano da tutte le parti in movimento.

Il giocattolo andrà nella direzione della freccia sulla parte superiore del motore. Carica fino a che non senti uno scatto. A quel punto fermati. Non caricare eccessivamente.

Idee di giochi

Visita knex.com/instructions e immetti il codice **61024** per trovare le istruzioni per queste idee di giochi.

Per altre istruzioni K'NEX

Visita knex.com/instructions e clicca su "combo builds" per altre istruzioni K'NEX.

PT Lista de peças

Antes de iniciar a construção, certifique-se de que comparas as peças do teu conjunto com a lista das peças aqui. Se faltar alguma peça telefona ou escreve-nos usando as informações indicadas na contracapa. Estamos aqui para te ajudar!

Fundamentos de Construção K'NEX

Inicia a construção

Para iniciars a construção do teu modelo, procura a etapa 1 e segue os números. Cada peça tem a sua própria configuração e cor. Observa as ilustrações, procura as peças que correspondem ao que estás a ver e liga umas às outras. É mais fácil se estiveres virado para o modelo na mesma direção mostrada nas ilustrações durante o processo de construção. As setas mostram os pontos onde as peças são conectadas, mas nem todos os pontos de conexão possuem setas. As peças com cores desbotadas pertencem às secções que já foram coordenadas.

Conectores

Podes fazer deslizar estes conectores especiais em conjunto. Empurra com força até escutares um "estalido". Presta muita atenção às instruções e posiciona-as na horizontal ou na vertical, exactamente como são mostradas.

Ferramenta separadora dos cubos

Usa esta ferramenta para separares os cubos K'NEX

Etiquetas adesivas

A olhada a este quadro antes das etiquetas adesivas é acrescentada ao modelo.

Motor

CUIDADO: Mantém o cabelo, os dedos, a cara e a roupa afastados de todas as peças móveis.

O brinquedo seguirá a direção da seta localizada na parte superior do Motor. Faz rodar até ouvires um estalido e, seguidamente, solta. Não rodes excessivamente.

Ideias de entretenimento

Visita a knex.com/instructions e introduz o código **61024** para obteres instruções para estas ideias de entretenimento.

Para descobrires mais instruções da K'NEX

Visita a knex.com/instructions e faz um clique sobre "combo builds" para descobrires mais instruções.

NL Onderdelenlijst

Voor je begint te bouwen, vergewis je ervan de onderdelen in je geheel na te gaan met de onderdelenlijst hier. Wanneer iets ontbreekt, bel ons op of schrijf ons door gebruik te maken van de informatie op het achterblad. We staan er om je te helpen!

Basisstappen voor K'NEX bouwen

Begin te bouwen

Om je model te beginnen, moet je eerst stap nummer 1 vinden en dan de nummers volgen. Elk stuk heeft zijn eigen vorm en kleur. Kijk naar de prentjes, vind de stukken die overstemmen met wat je ziet, en maak ze aan mekaar vast. Het helpt wanneer je model dezelfde richting volgt als de aanwijzingen terwijl je bouwt.

De pijlen duiden je aan waar de onderdelen zich vasthechten, maar niet alle hechtingspunten hebben pijlen.

De onderdelen met afnemende kleur werden reeds eerder aan mekaar vastgemaakt.

Verbindingstukken

Deze speciale verbindingstukken kunnen in mekaar geschoven worden. Druk ze goed tezamen tot wanneer je een "klik" hoort. Geef goed aandacht aan de aanwijzingen en richt ze horizontaal of verticaal af, precies zoals afgebeeld.

Scheidingsinstrument voor de stenen

Gebruik dit instrument om de K'NEX stenen uit mekaar te halen.

Stickers

Kijk naar deze foto vóór de stickers worden toegevoegd.

Motor

OPGEPAST: Hou het haar, de vingers, het gezicht en kledij verwijderd van alle bewegende onderdelen.

Het speelgoed gaat in de richting van de pijl bovenop de motor. Wind op tot wanneer je het hoort klikken.

Laat dan los. Niet overmatig opwinden.

Spelideeën

Bezoek knex.com/instructions en duid de **61024** code aan om de aanwijzingen voor deze spelideeën terug te vinden.

Voor meer K'NEX aanwijzingen

Bezoek knex.com/instructions en klik op "combo builds" voor meer K'NEX aanwijzingen.

KNEX.COM

K'NEX Customer Service. Call 1-800-KID-KNEX (USA/CAN only); Write to email@knex.com; Visit www.knexus.com
For Customer Service outside USA/CAN contact your local distributor at: <http://www.knexus.com/distributors>
(FR) Le Service clients hors d'USA/CAN, s'il vous plaît contacter le distributeur local.
L'information de distributeur peut être trouvée à <http://www.knexus.com/distributors>
(AZ) (NZ) (UK) (DE) (NL) (BE) (CH) (CL) (PE) <http://www.knexus.com/distributors>
(UK) TOMY Careline, PO Box 20, Totton, Hants, SO40 3YF; Tel 023 8066 2600
(FR) ALLO TOMY SAV, Parc d'affaires International, 74166 ARCHAMPS; Tel 0 820 013 013
(UK) (FR) (DE) (NL) <http://www.tomy.eu>



+



=



Sold separately.
Vendus séparément.
Se venden por separado.
Separat erhältlich.
Venduti separatamente.
Vendidos separadamente.
Afzonderlijk verkocht.

Visit www.knexus.com/instructions
and click on **combo builds**
for instructions.



+



=



Product & colors may vary. Most models can be built one at a time. Standard K'NEX parts made in the USA. Produits et couleurs peuvent varier. La plupart des modèles ne peuvent être construits que un à un. Pièces K'NEX courantes fabriqués aux États-Unis. El producto y los colores pueden variar. La mayoría de los modelos se pueden construir uno a la vez. Piezas estándar de K'NEX hechas en EE.UU. K'NEX and Imagine, Build, Play are registered trademarks of K'NEX Limited Partnership Group. K'NEX et Imagine, Build, Play sont des marques déposées de K'NEX Limited Partnership Group. K'NEX y Imagine, Build, Play son marcas registradas de K'NEX Limited Partnership Group. Manufactured under U.S. Patents/Fabriqués sous brevets américains/Fabricado bajo patentes de EE.UU. 5,061,219; 5,199,919; 5,350,331; 7,267,598; D553,204; D550,784; D550,784; 5,137,486; D393,417; D392,555; D391,843; D550,785; D550,782. Other U.S. and foreign patents pending. Autres brevets américains et étrangers en instance. Otras patentes de EE.UU. y países extranjeros pendientes. Community design/Le dessin ou modèle communautaire: Diseño de comunidad No. 000 645338-001-0002.

©2009 K'NEX Limited Partnership Group
P.O. Box 700
Hatfield, PA 19440-0700



- Identifies Genuine K'NEX Bricks.
- Identifie que ce sont d'authentiques briques K'NEX.
- Identifica los ladrillos genuinos de K'NEX.
- Identifiziert echte K'NEX-Bausteine.
- Edentifica i veri blocchi K'NEX.
- Identifica que são cubos genuínos da K'NEX.



410018-V1-05/09