

Did you install 2 AA (or LR6) batteries in the motor?

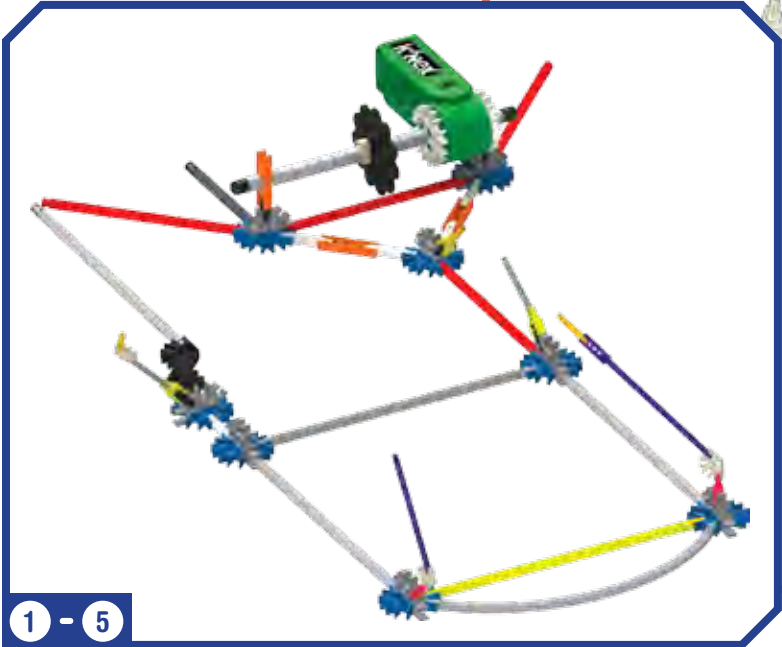

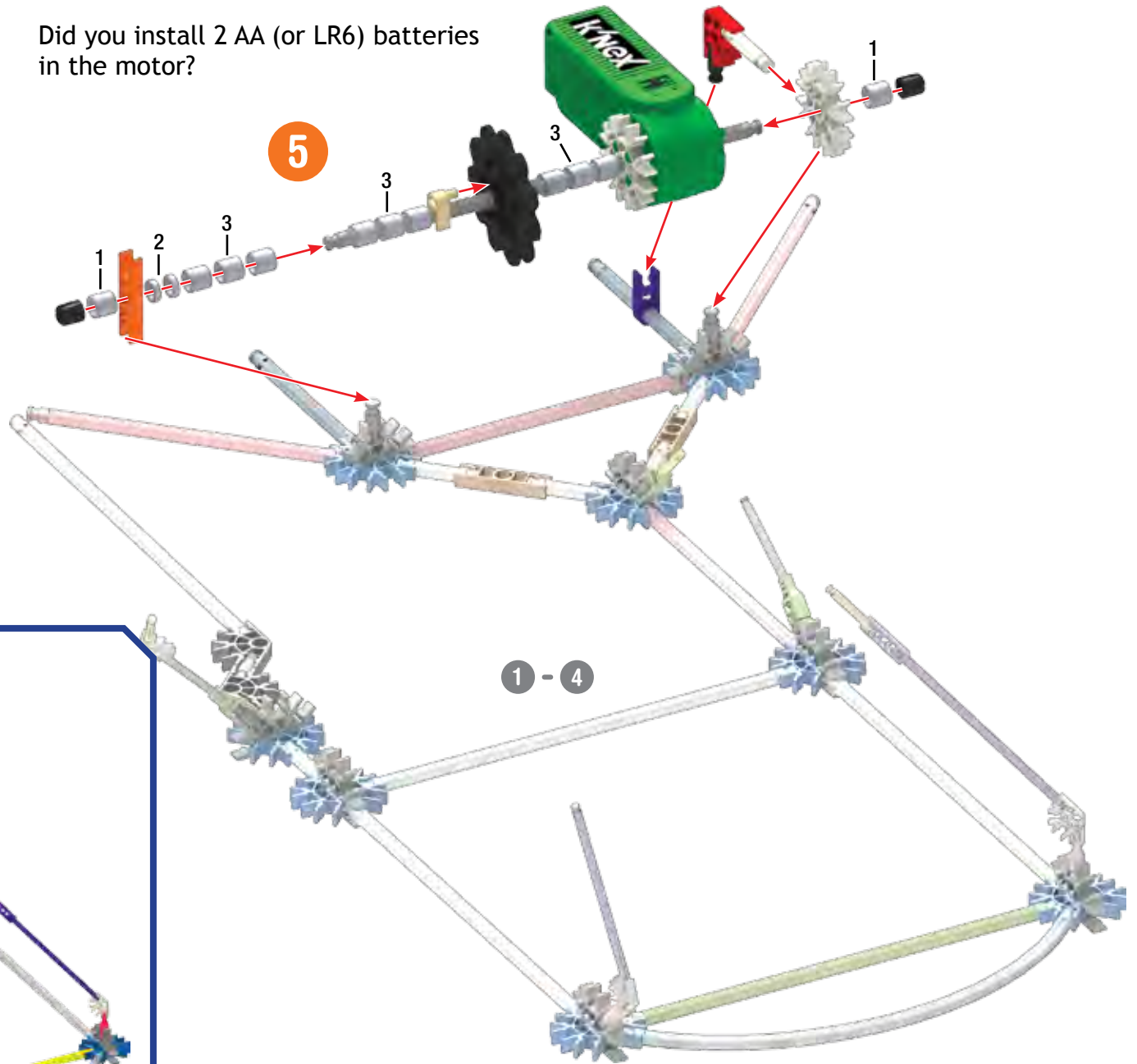

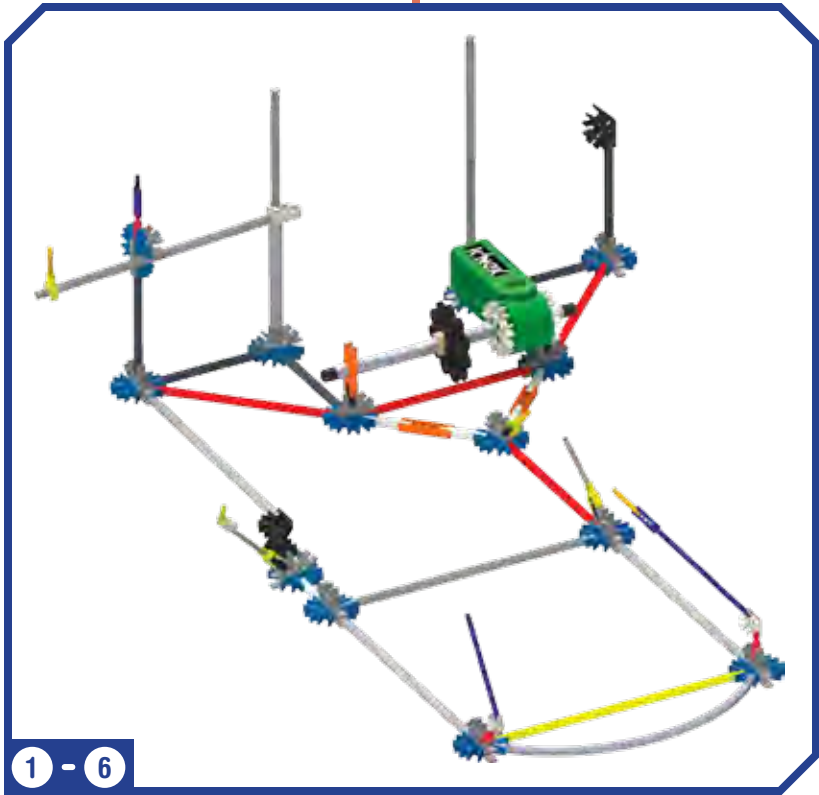

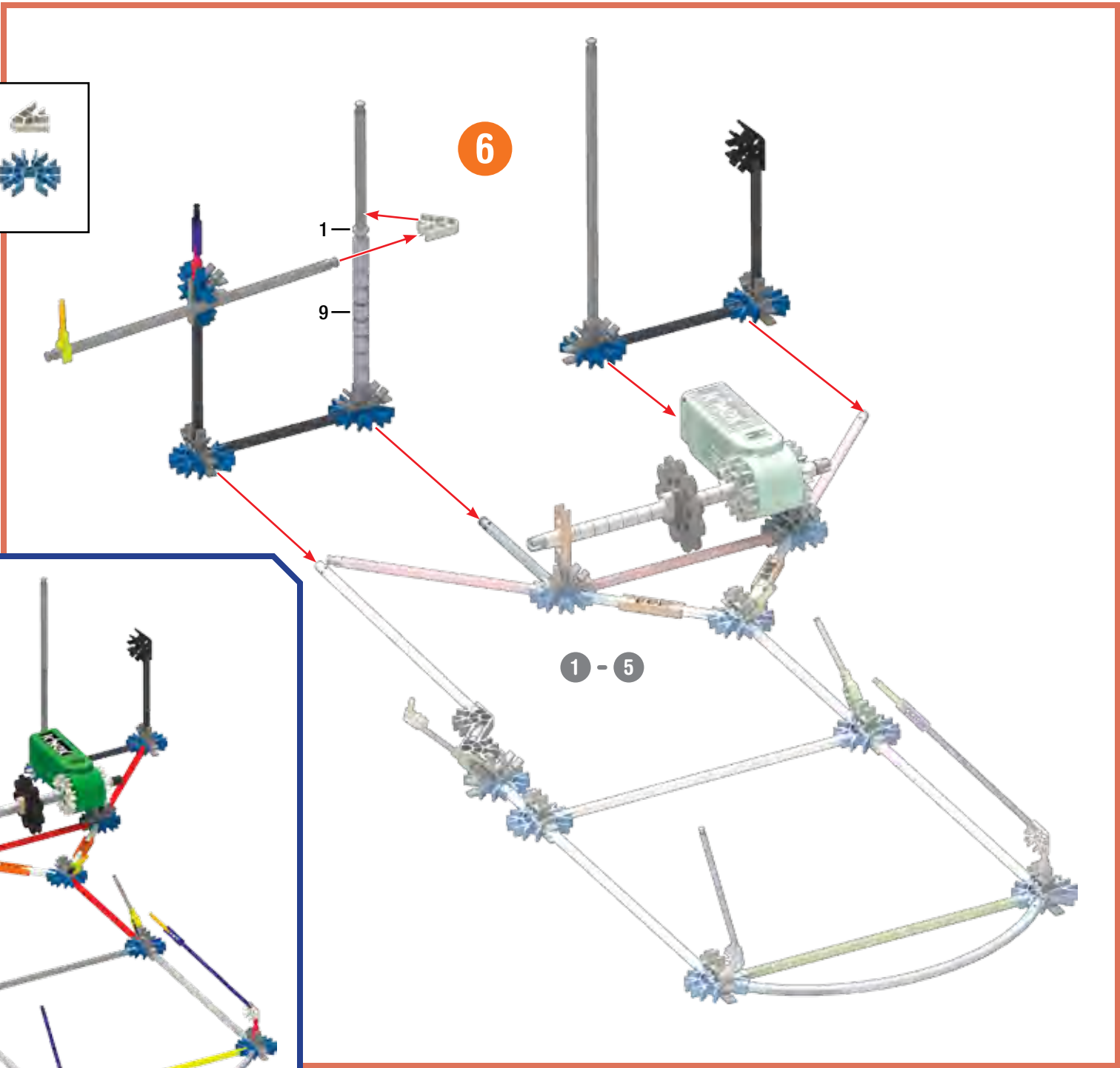
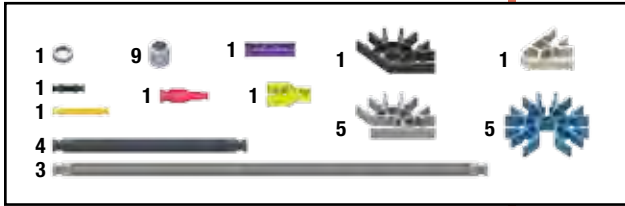
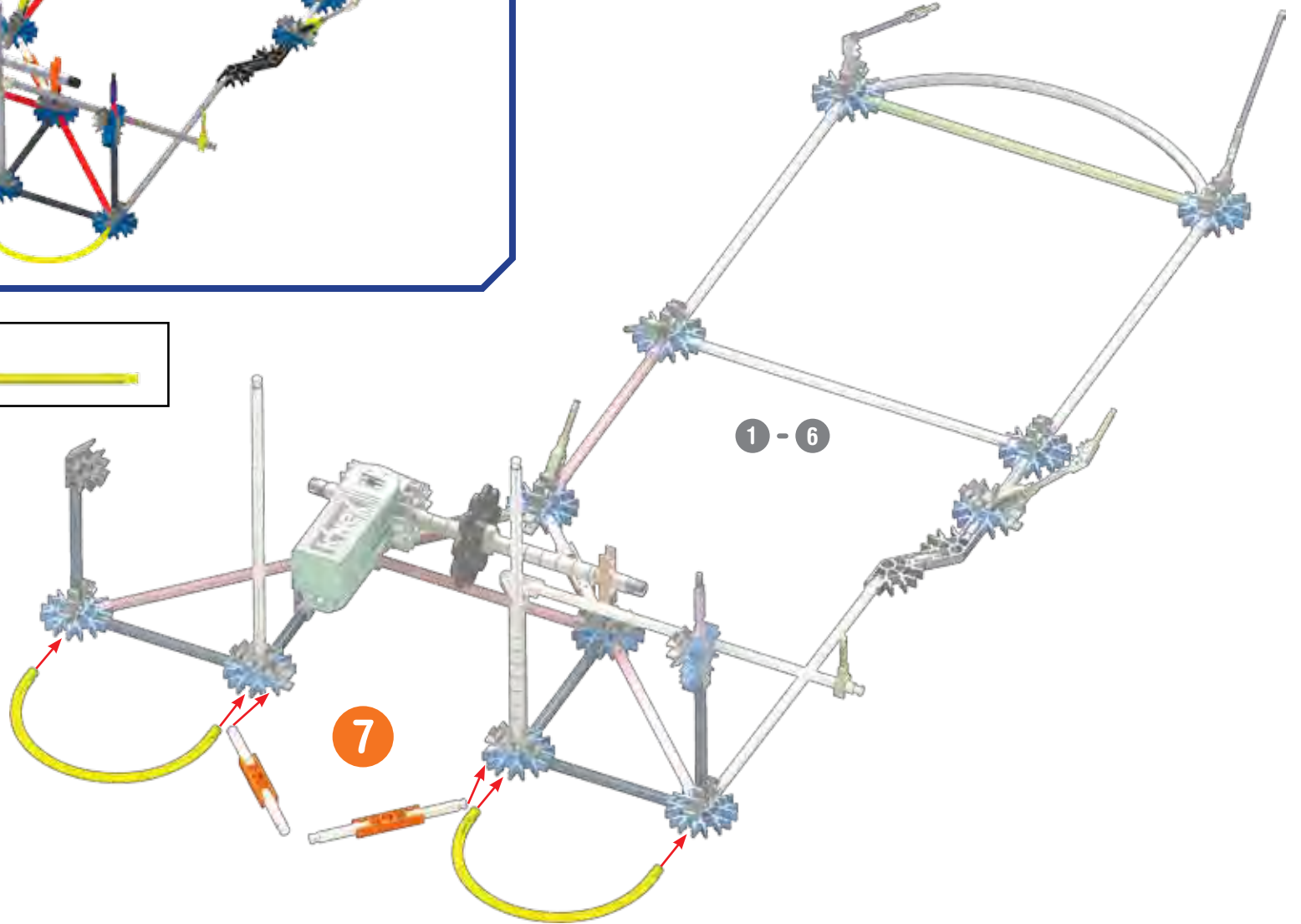
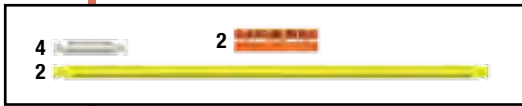
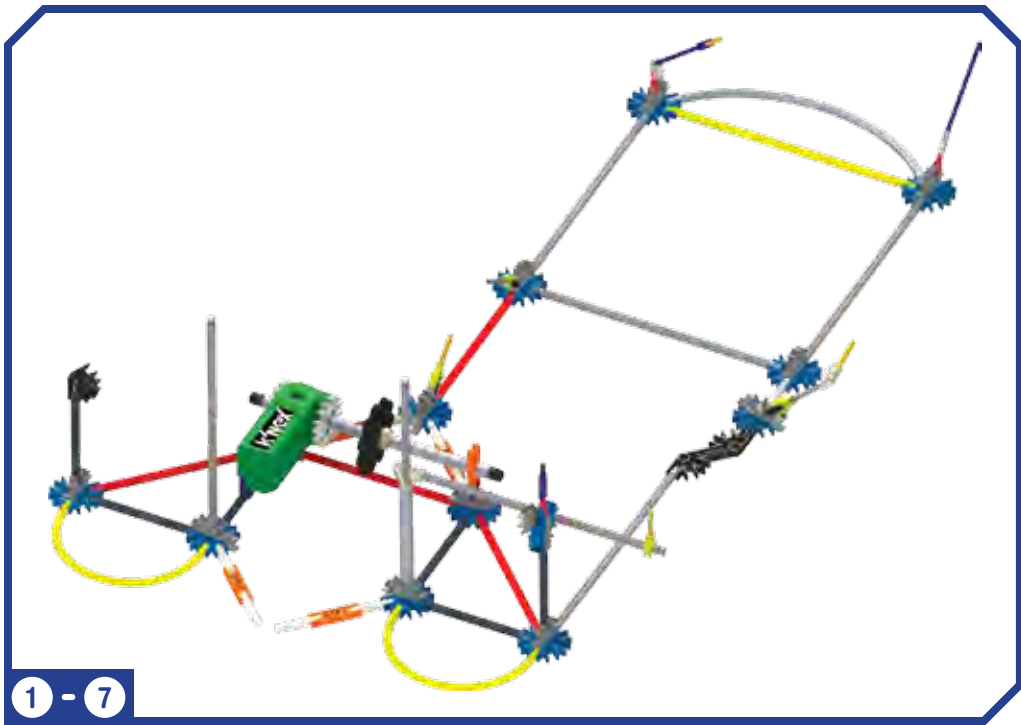
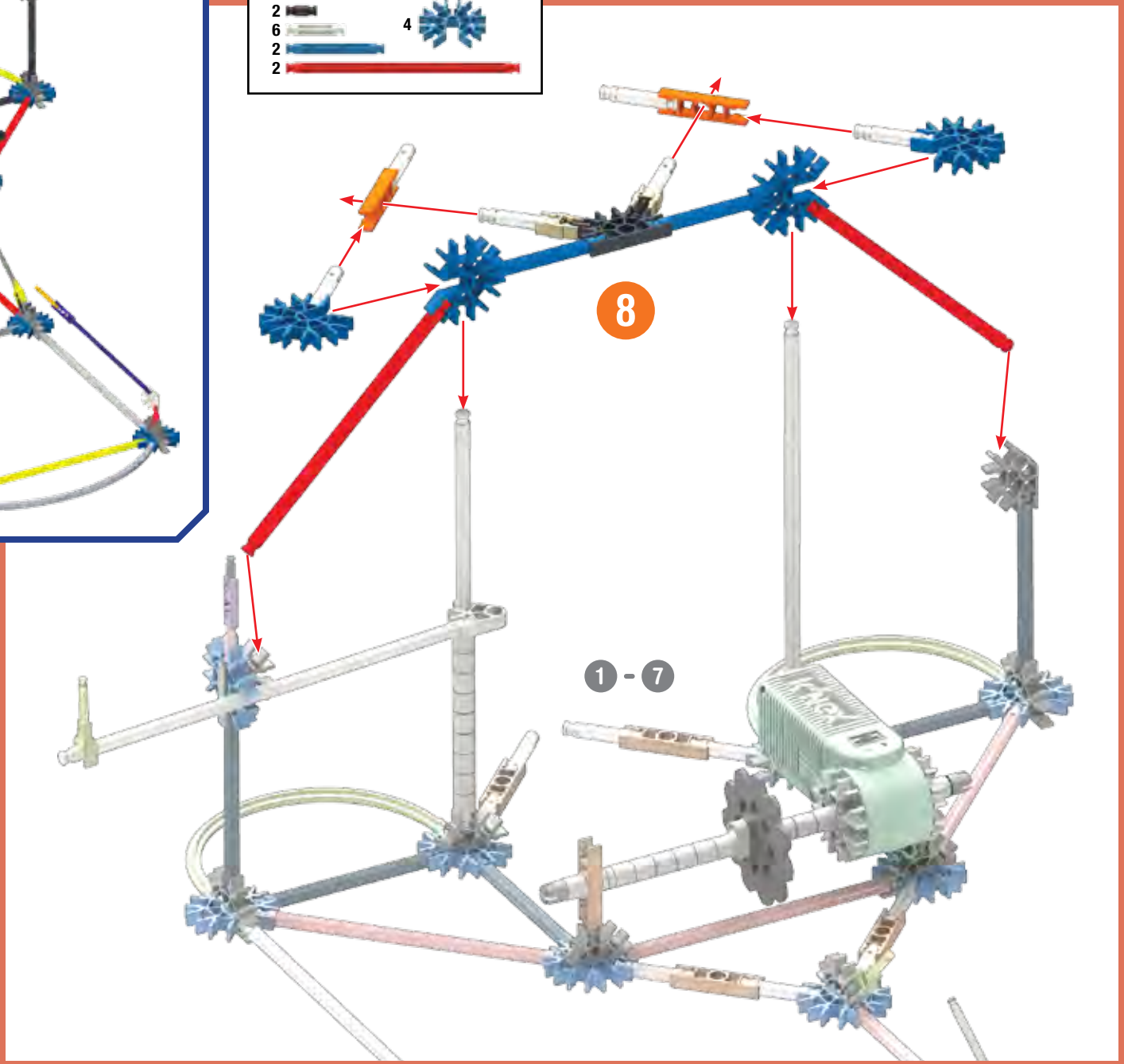
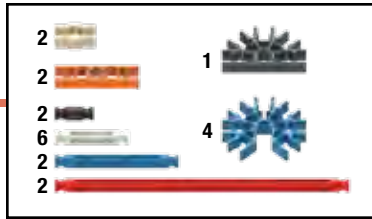
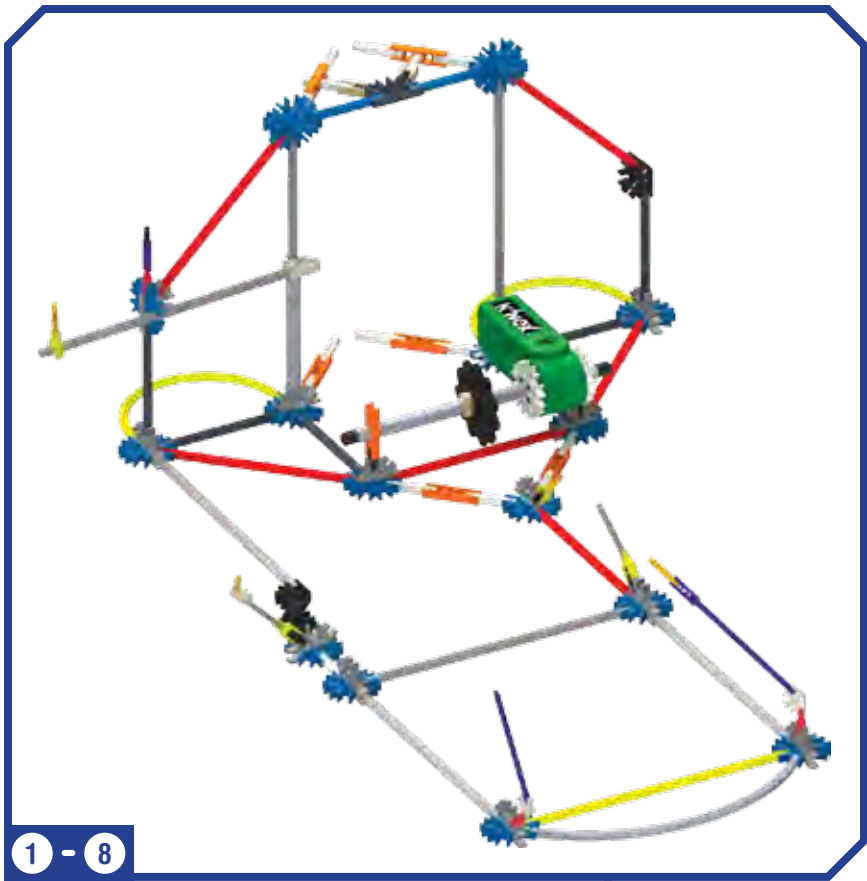

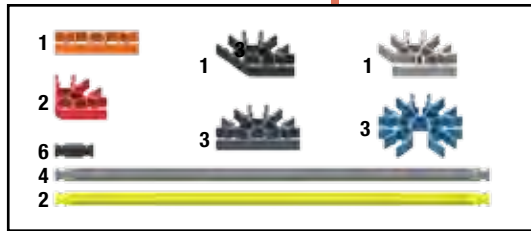

9

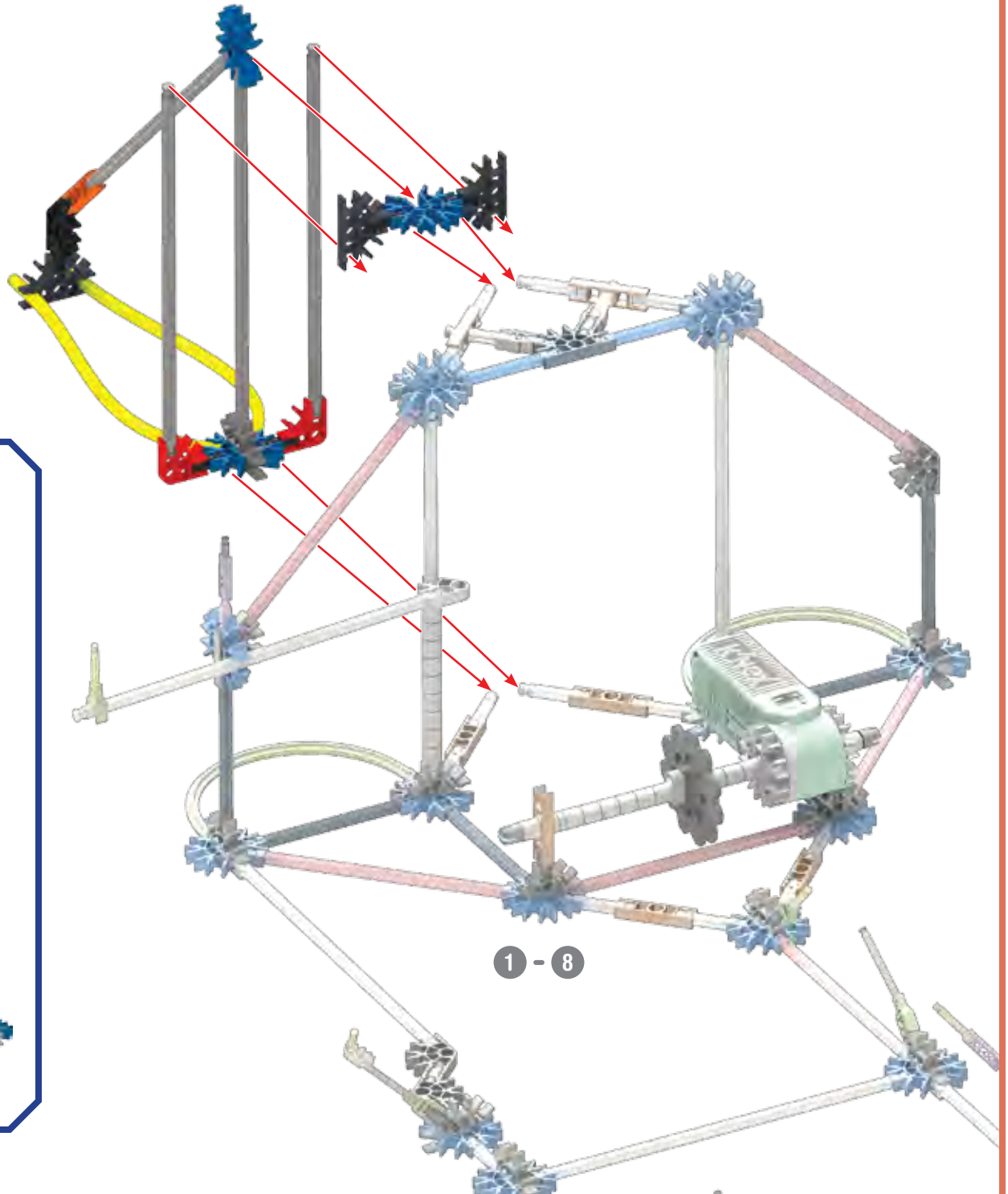

1 - 8

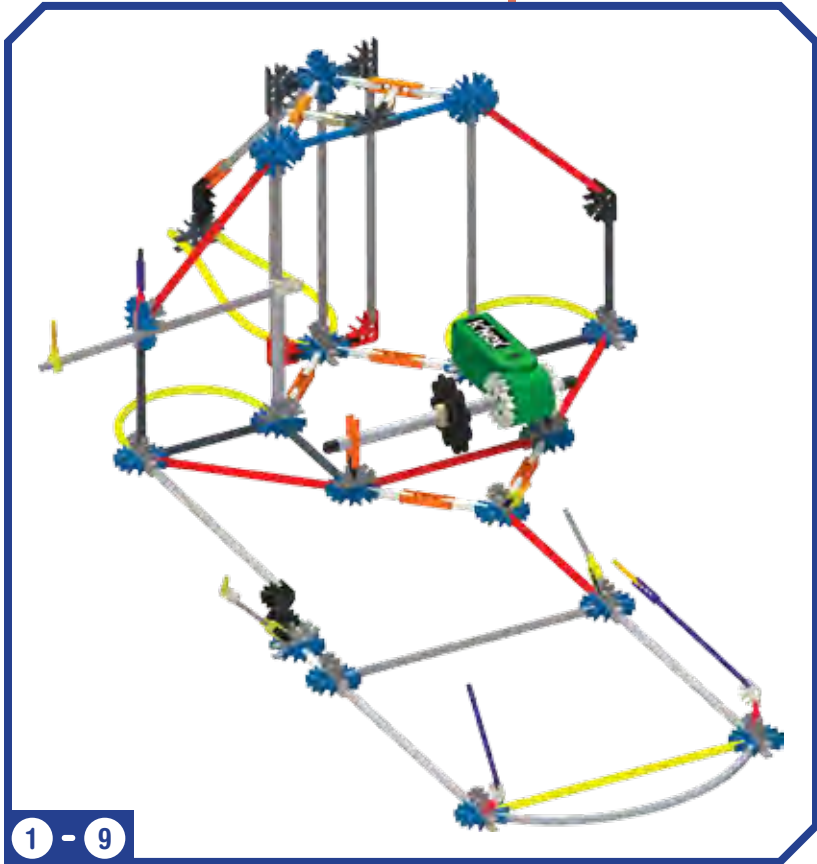

1 - 9

9

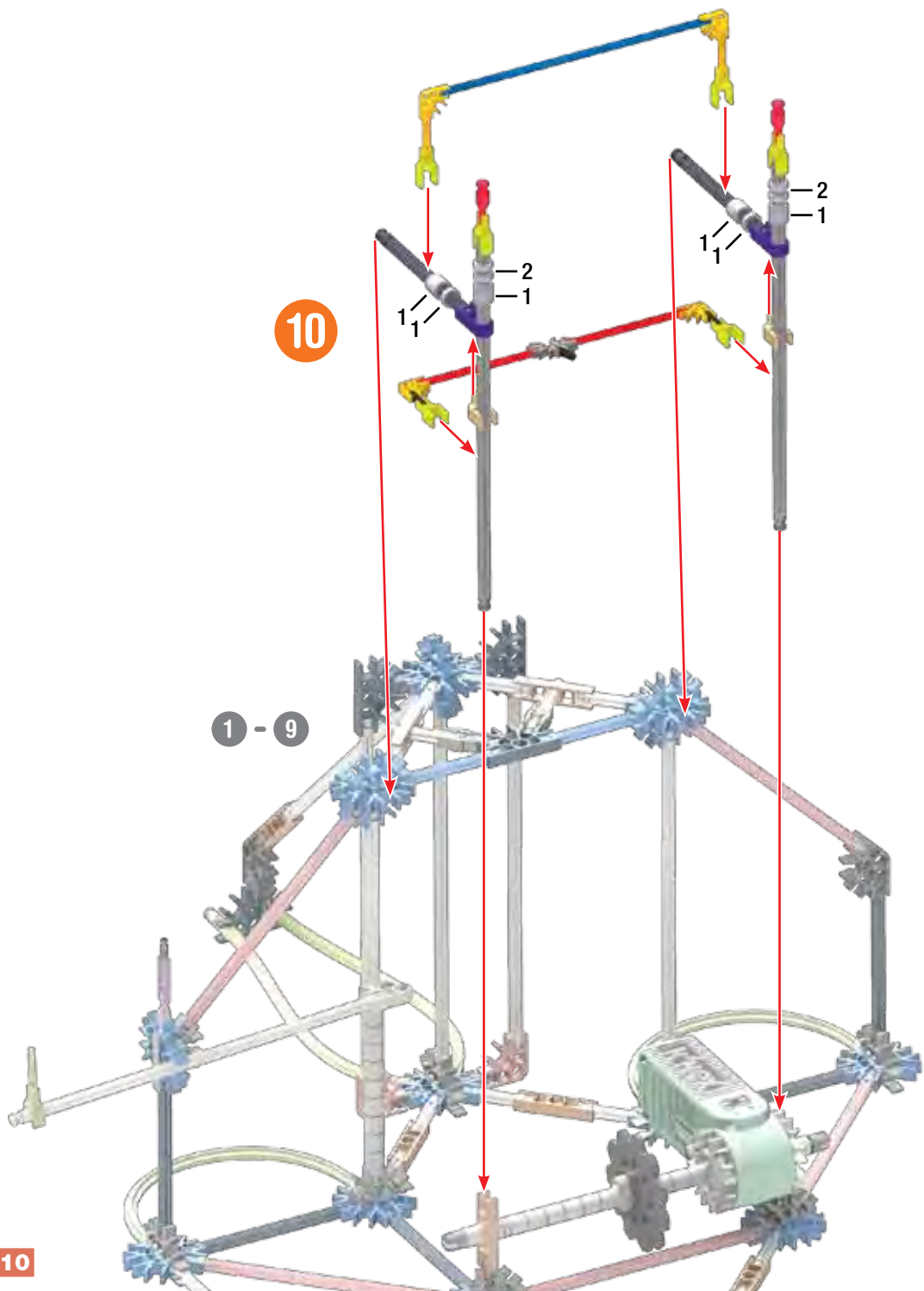

3	6	4	4	2
2				
1				
2	6	1	2	
2				
2				

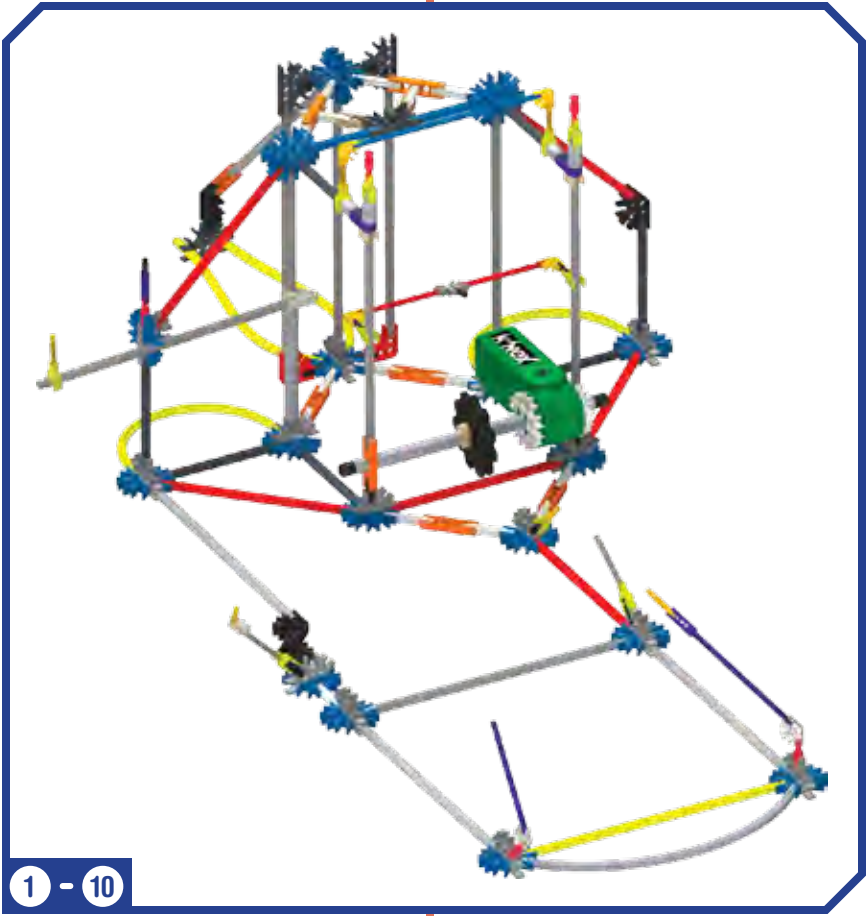

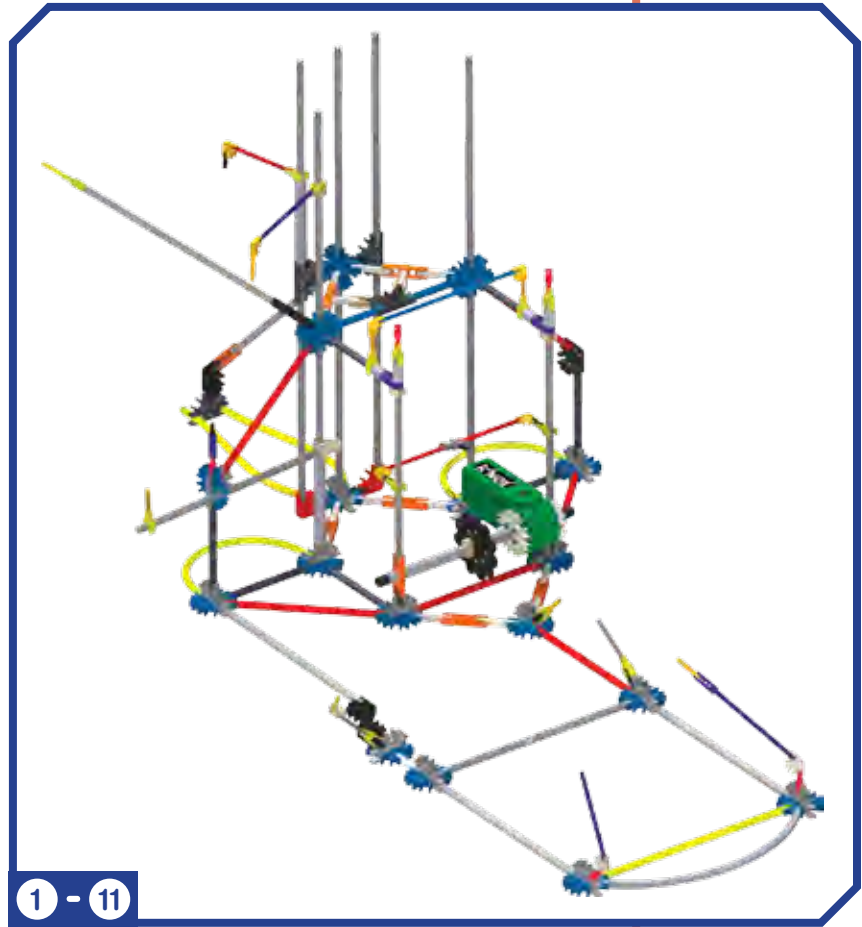
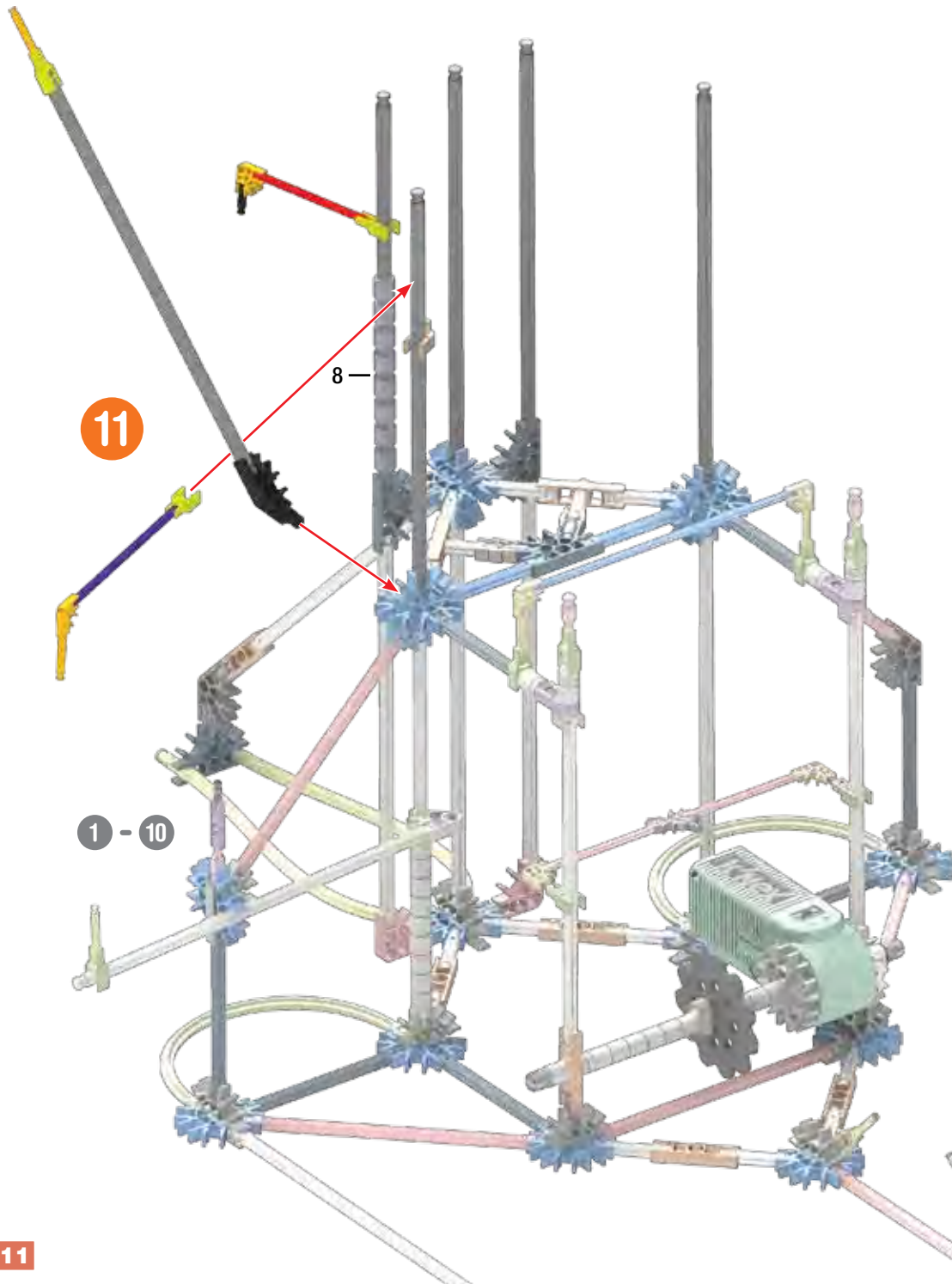

- | | | | |
|---|---|---|---|
| 1 | 8 | 2 | 1 |
| 2 | | | |
| 1 | | | |
| 1 | | | |
| 1 | 3 | | 1 |
| 6 | | | |

1	1	2	3	
4				3
6	2			
2			3	
1				

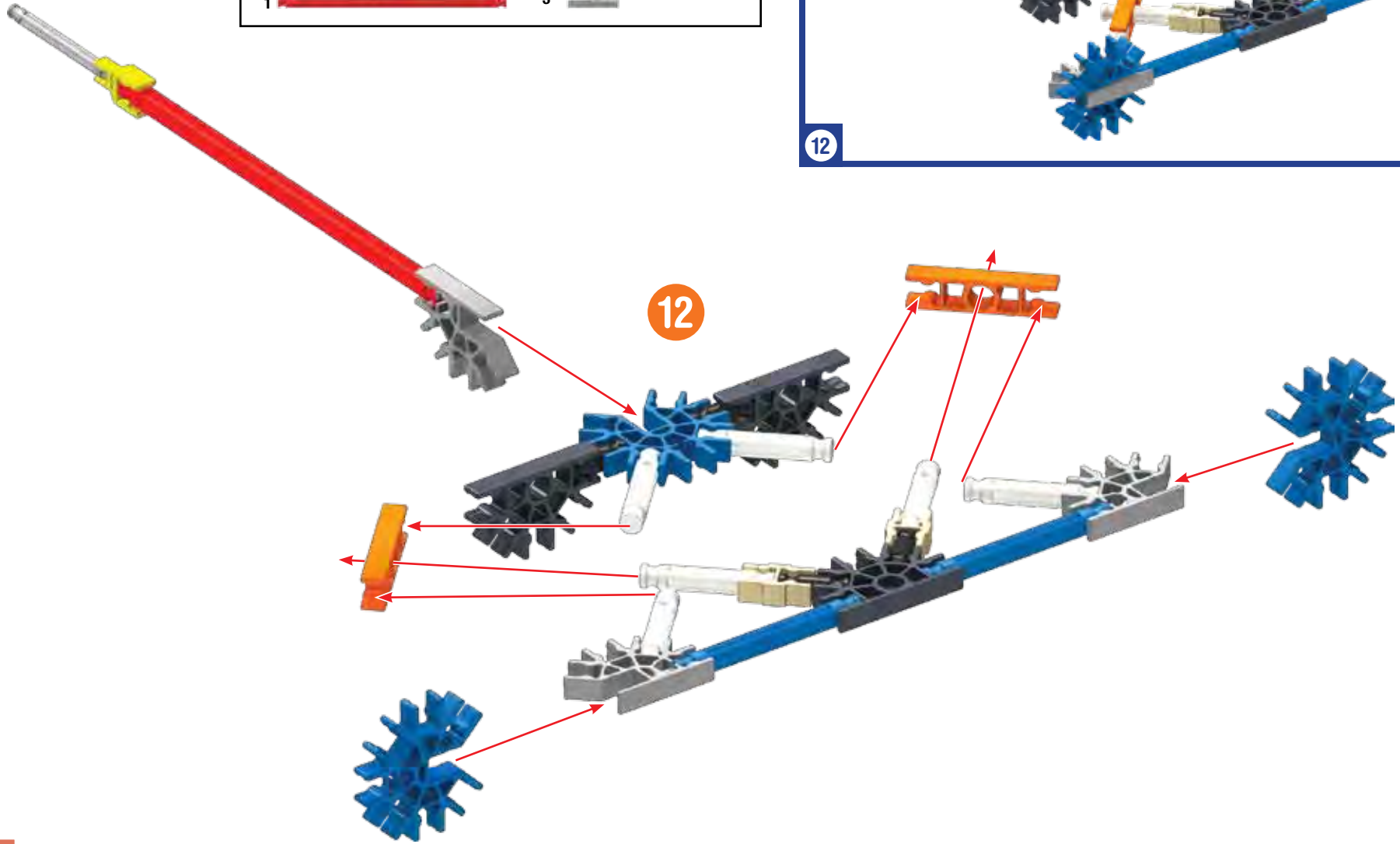
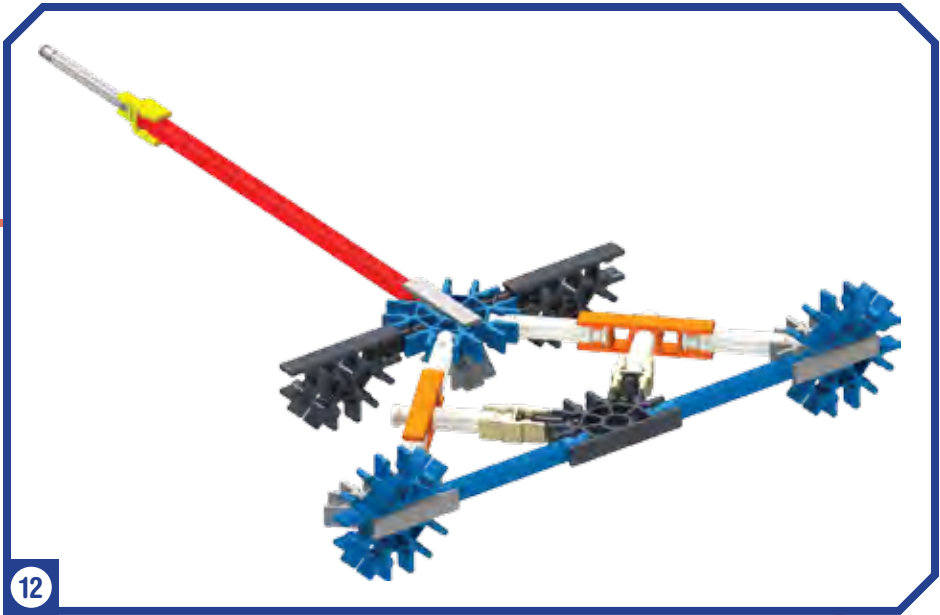

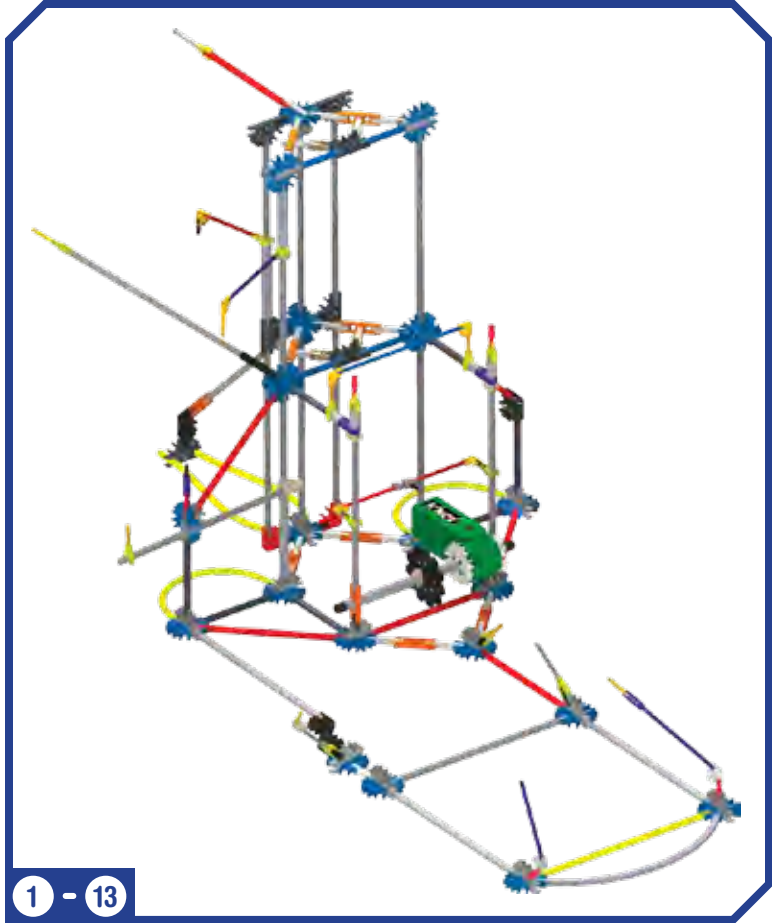
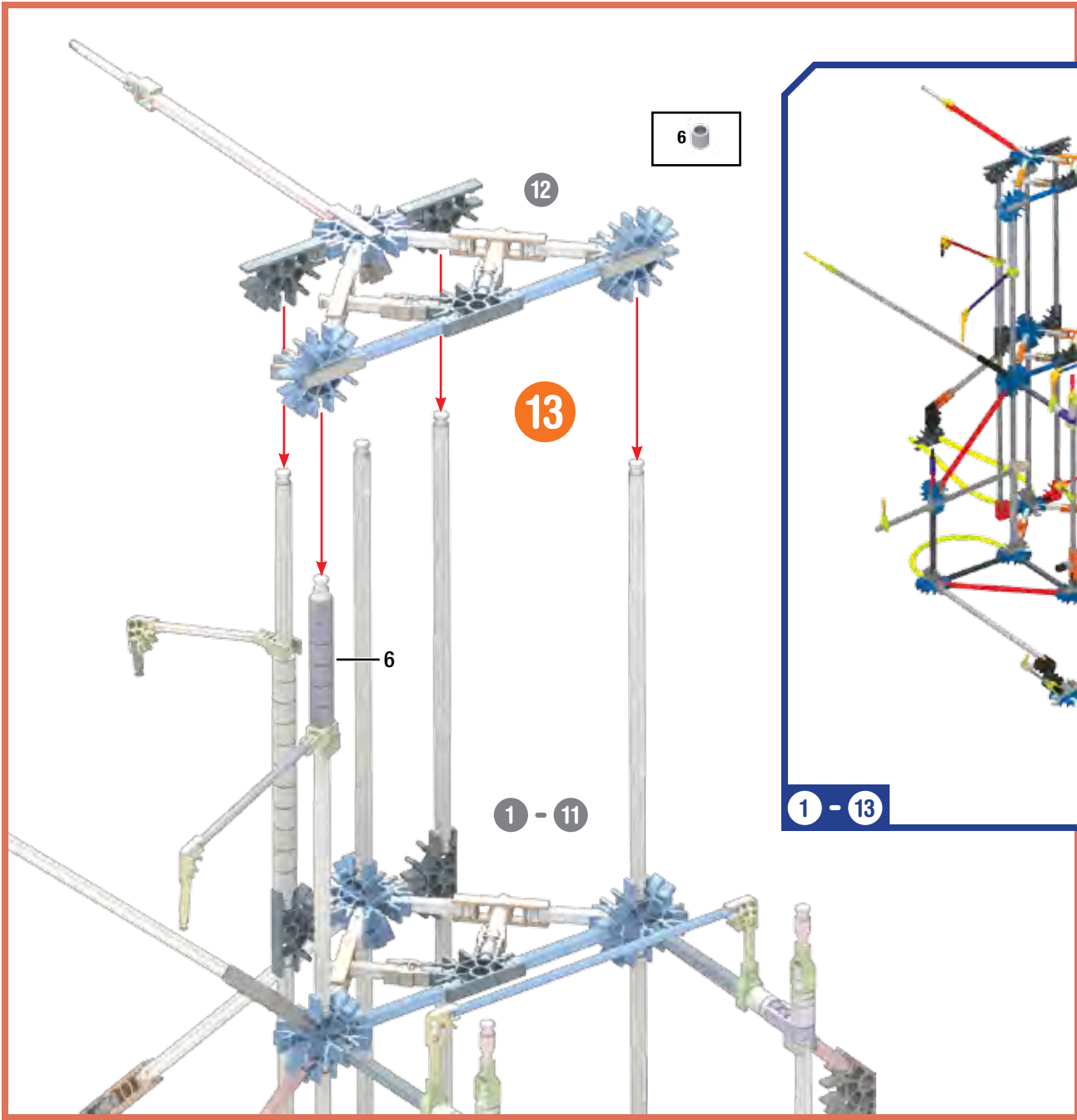

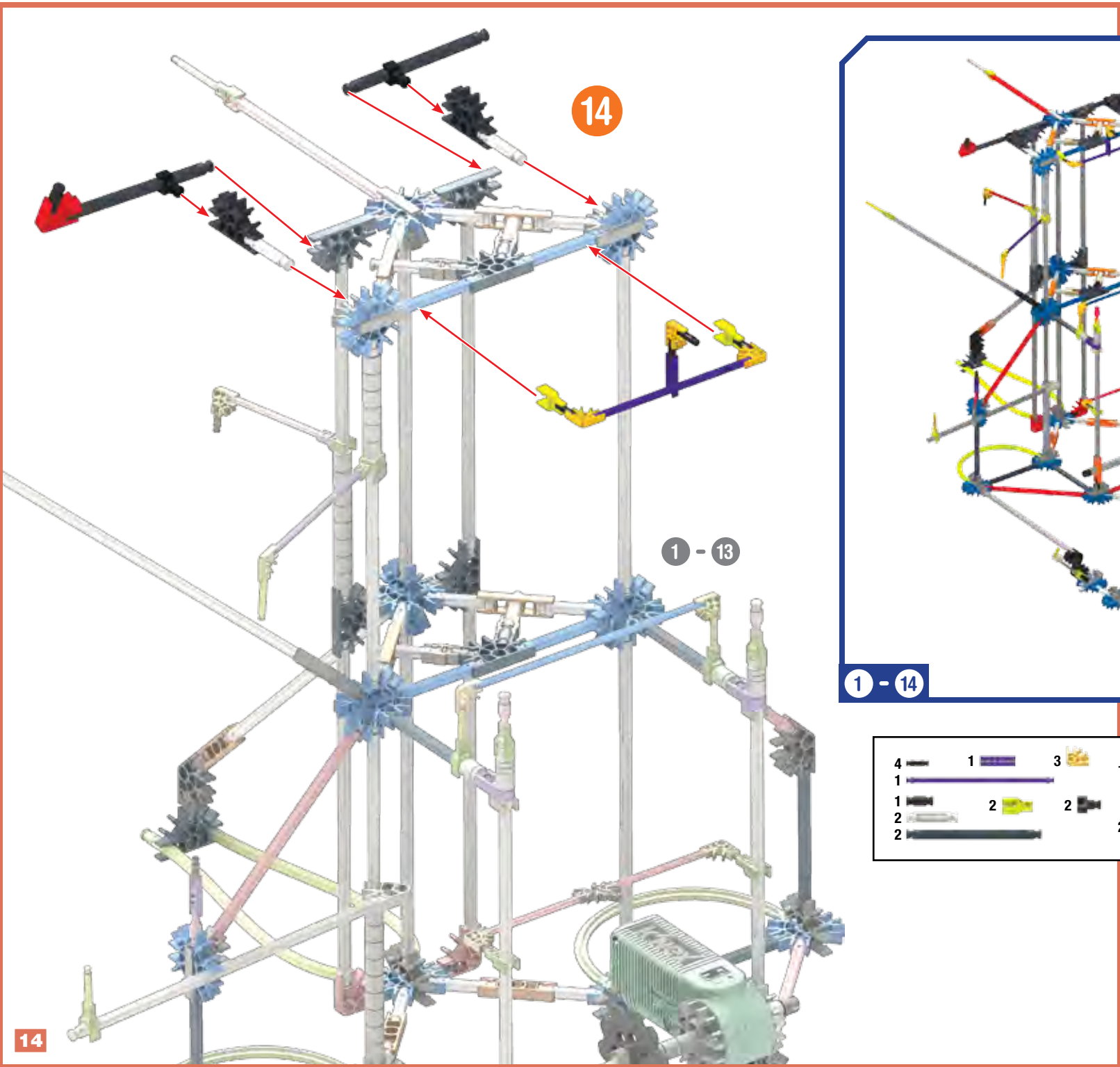

14

14

1 - 13

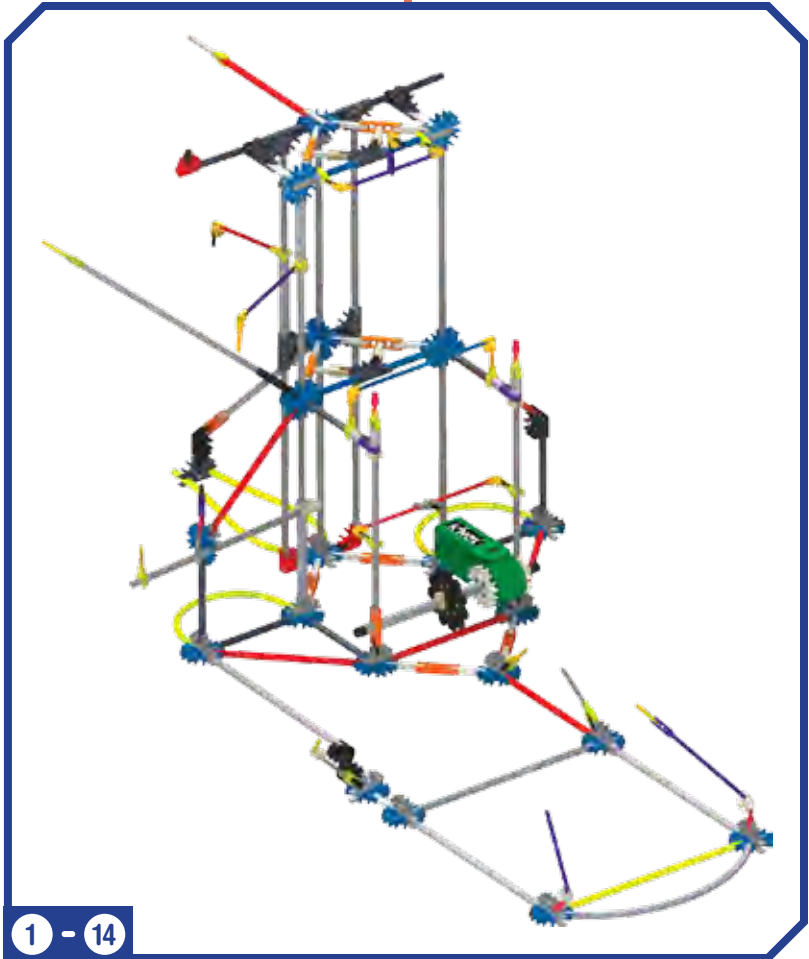

1 - 14

4	1	3	1
1			
1	2	2	
2			2
2			

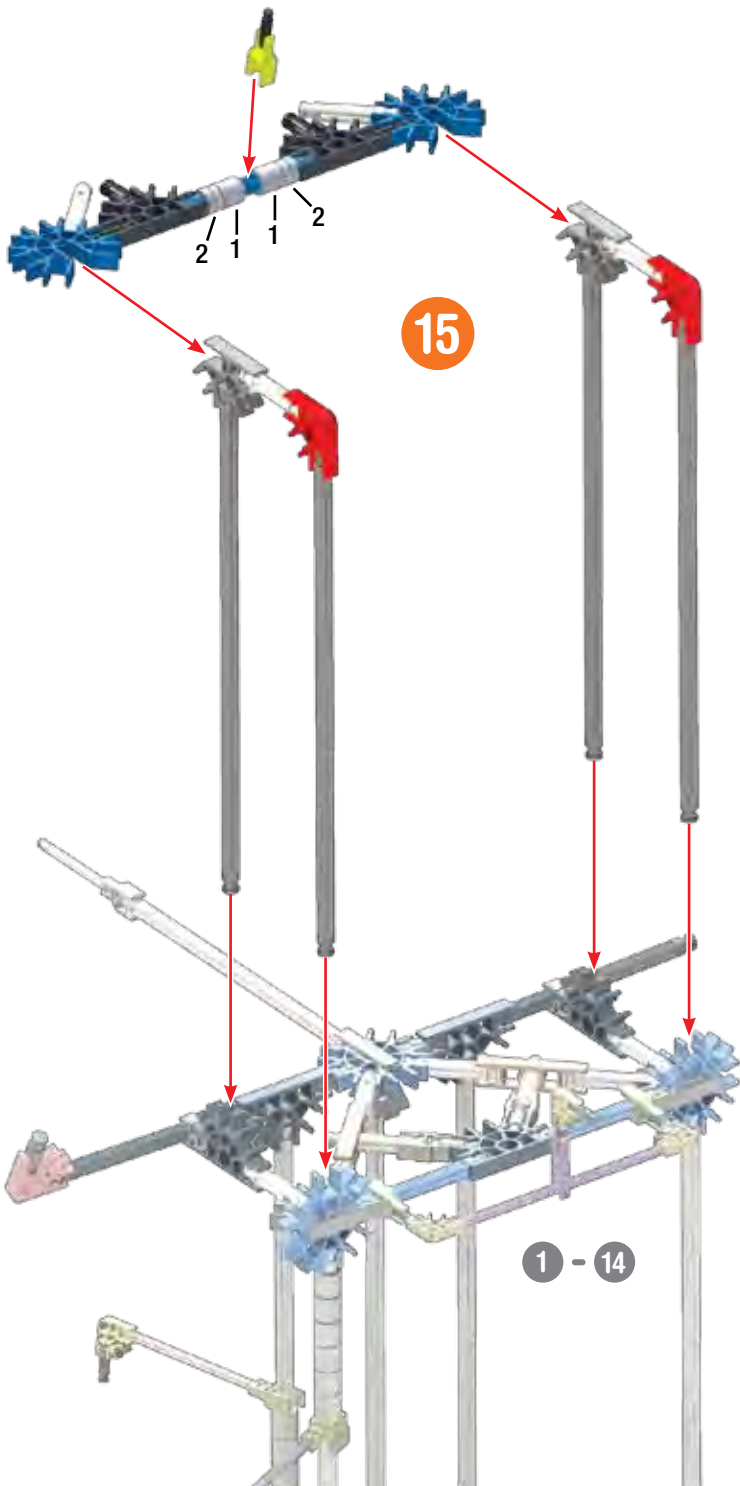

- | | | | | |
|---|---|---|---|---|
| 1 | 1 | 4 | 2 | 2 |
| 4 | | 2 | | 2 |
| 4 | | 2 | | 2 |
| 1 | | | | |
| 4 | | | | |

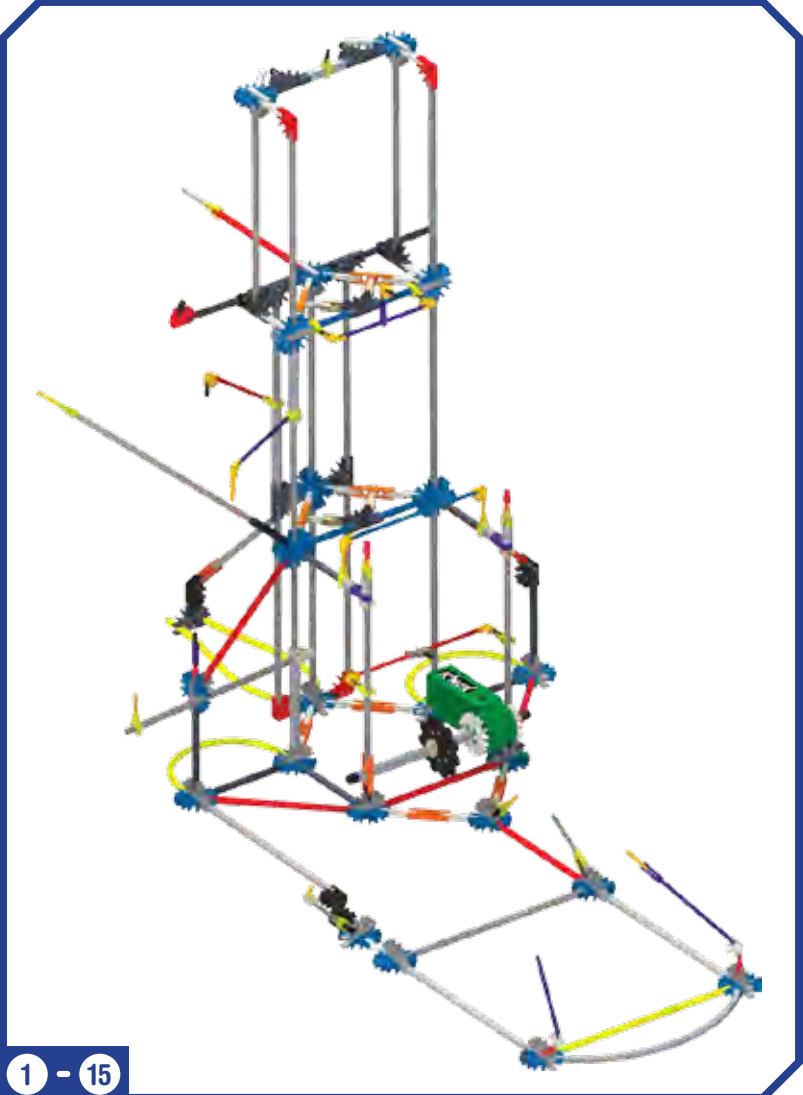

3	2	3	2	1
1	2	2	2	1
2	2	2	2	1
1	2	2	2	1

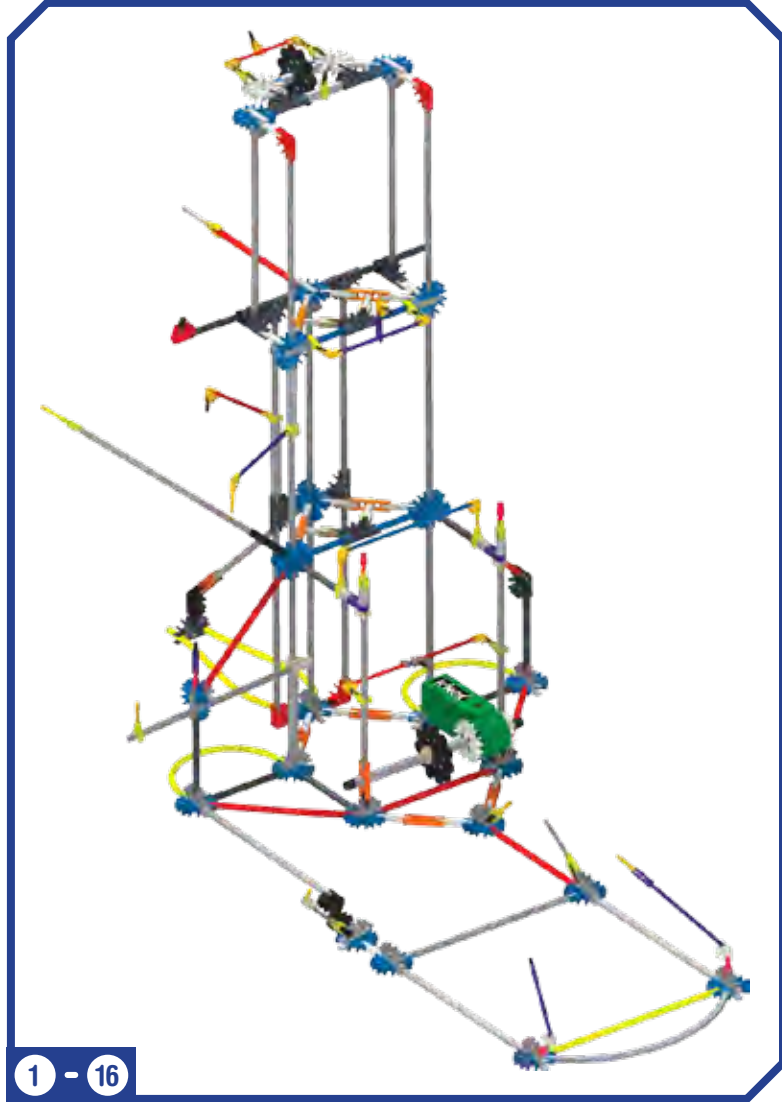
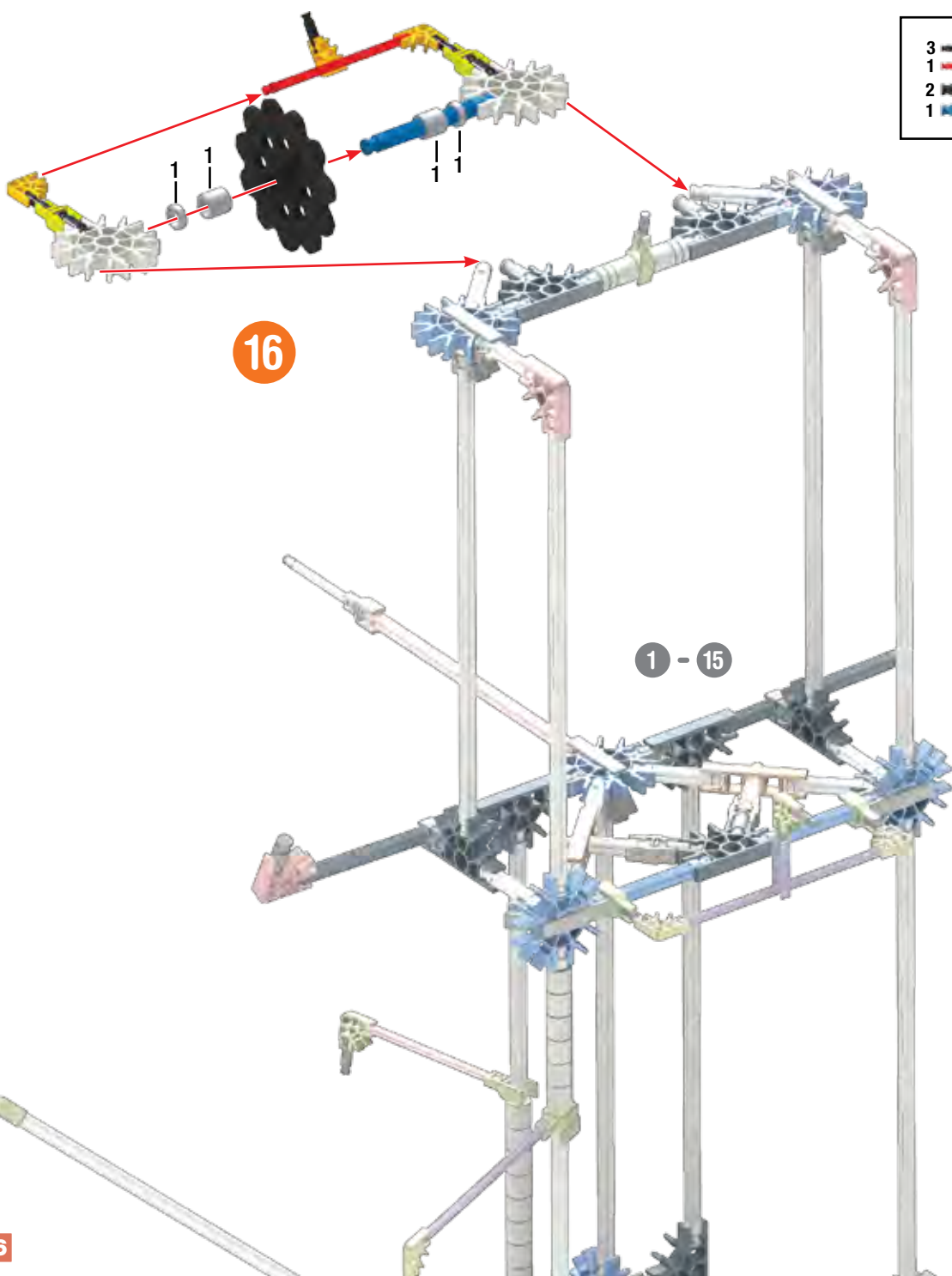

17

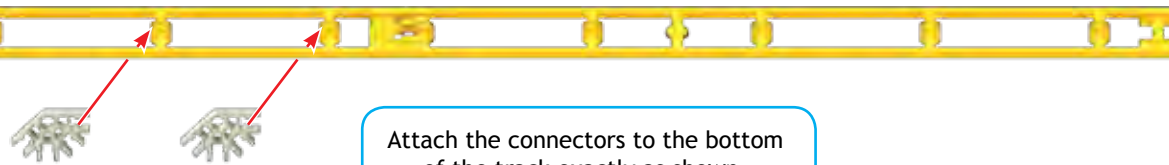

Attach the connectors to the bottom of the track exactly as shown. Be sure to push the connectors on firmly until they “click”.

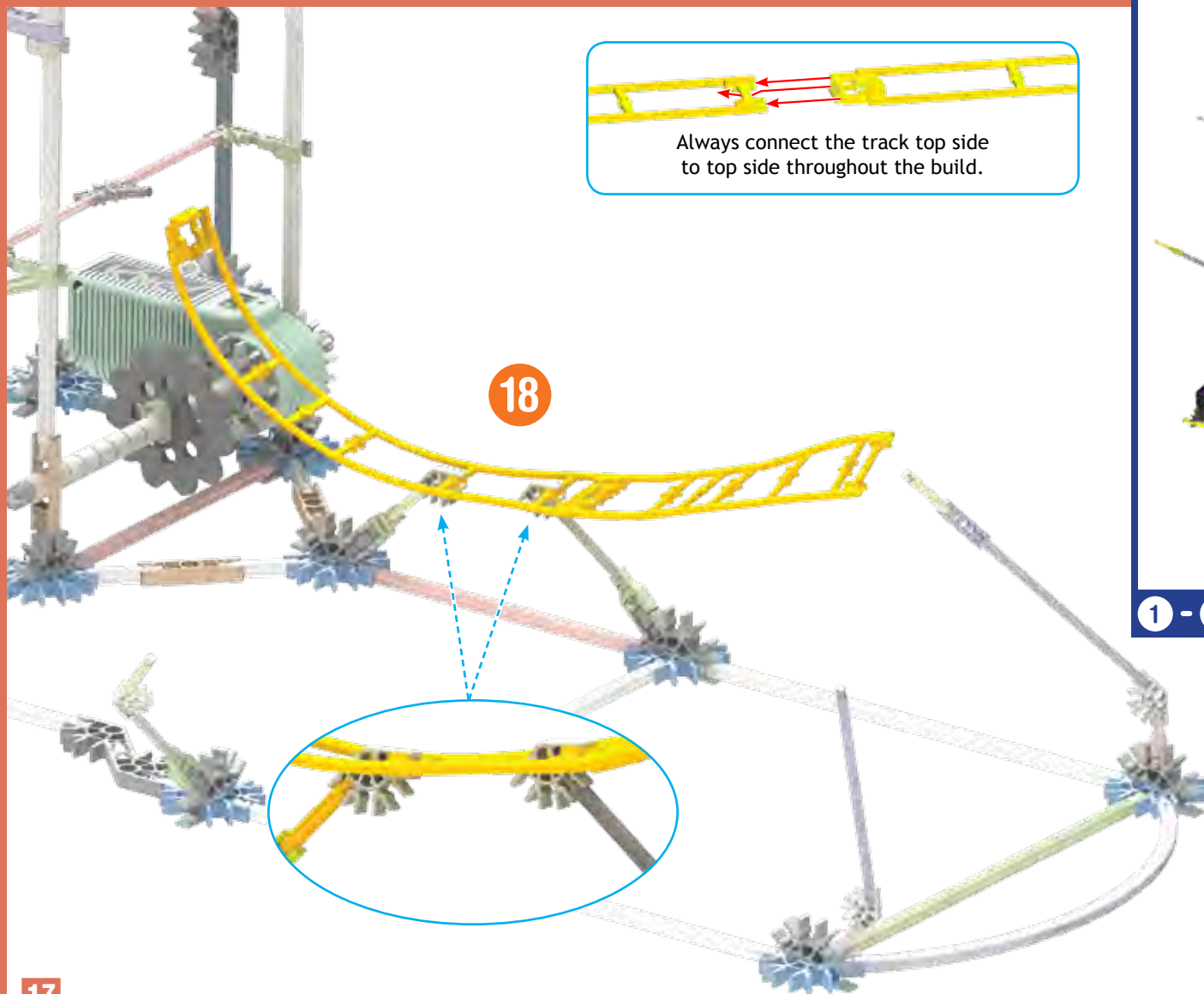

18

Always connect the track top side to top side throughout the build.



1 - 18

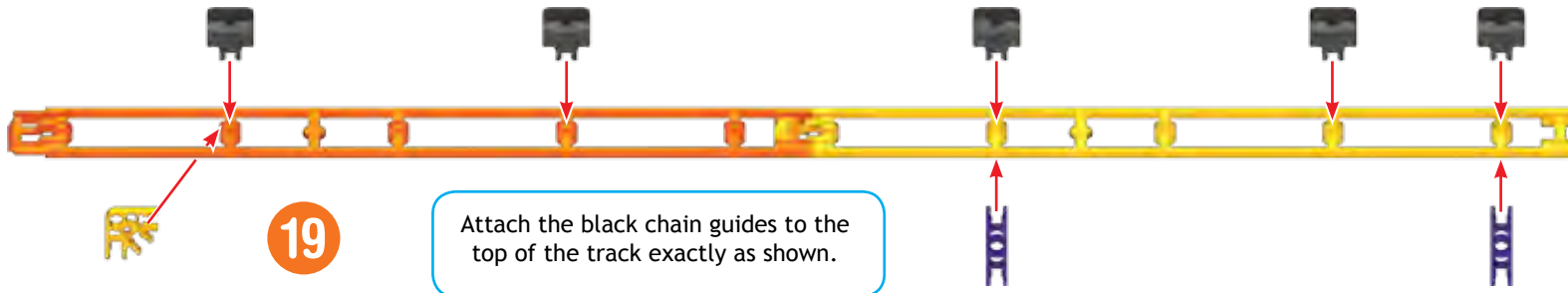

19

Attach the black chain guides to the top of the track exactly as shown.

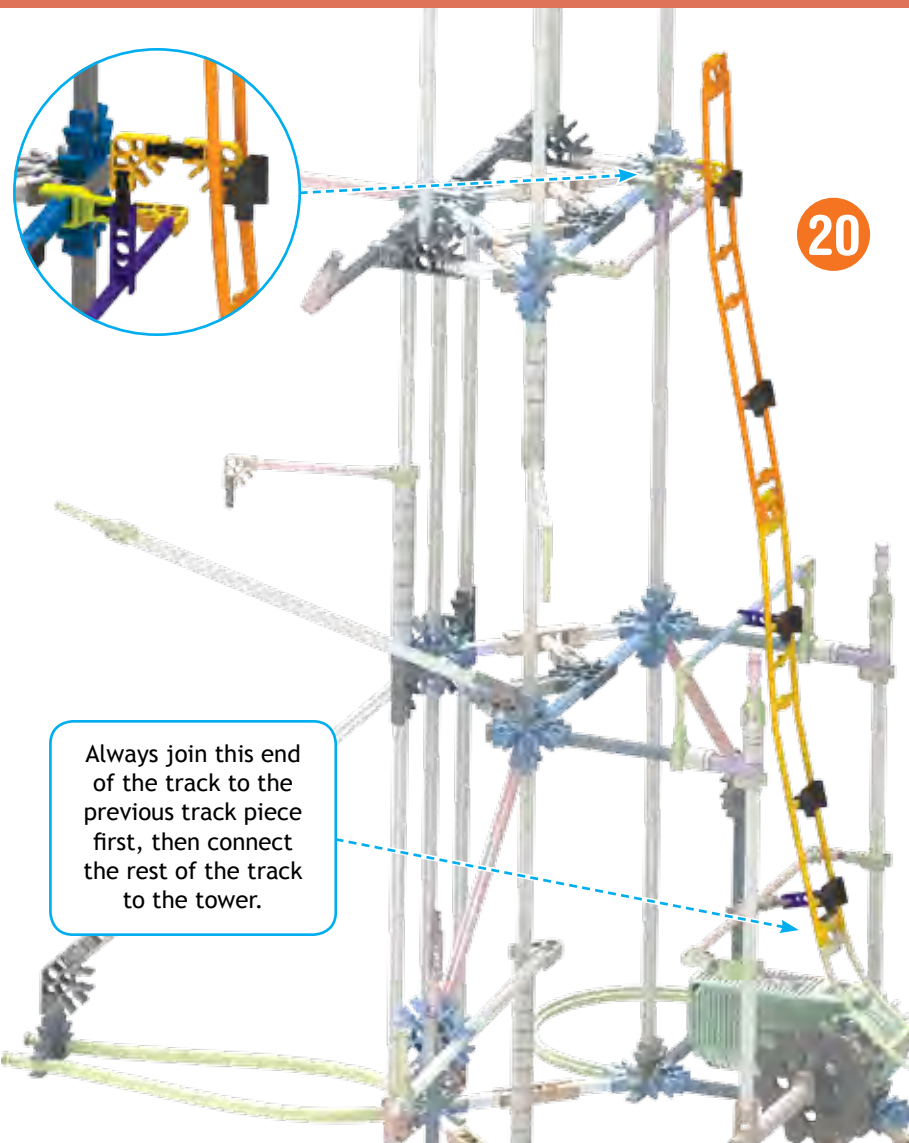

20

Always join this end of the track to the previous track piece first, then connect the rest of the track to the tower.

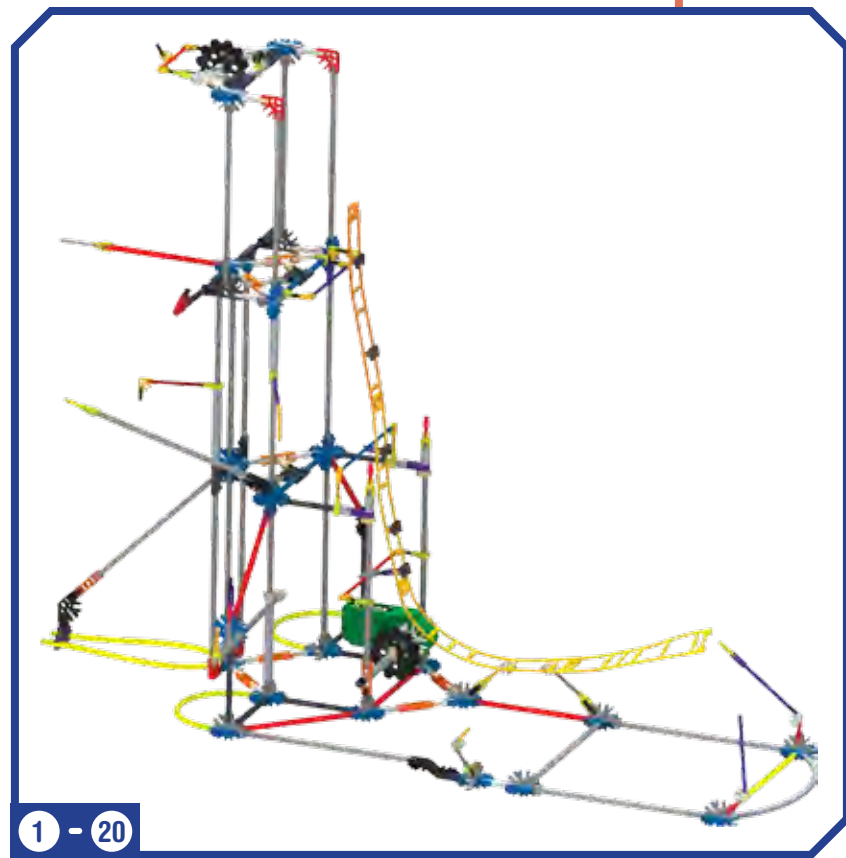

1 - 20

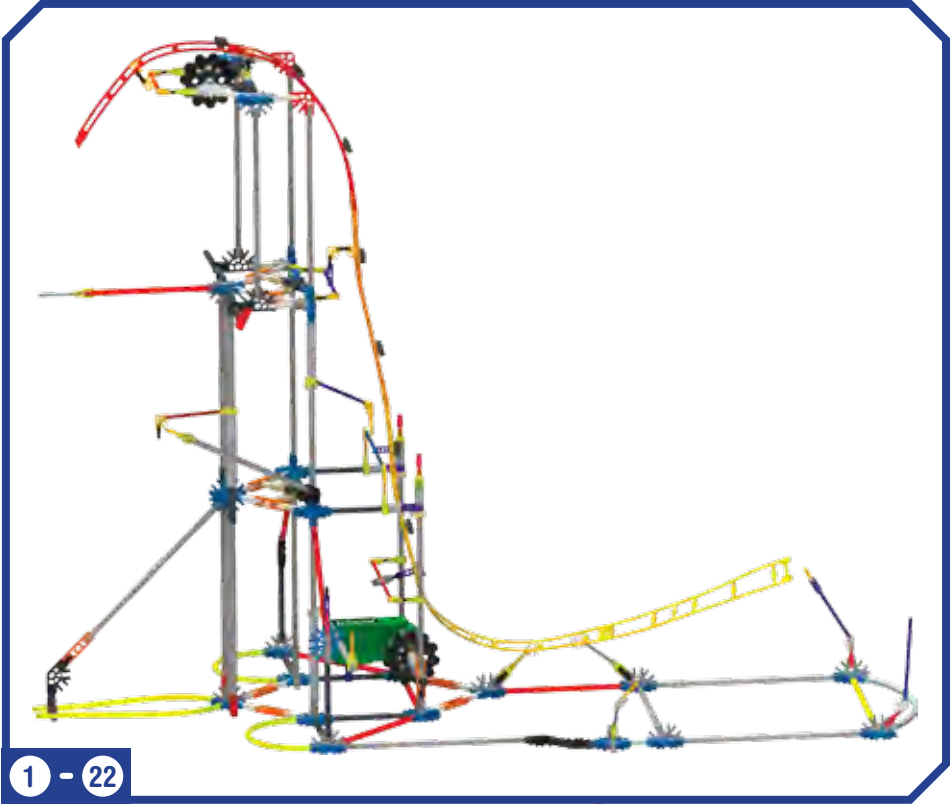
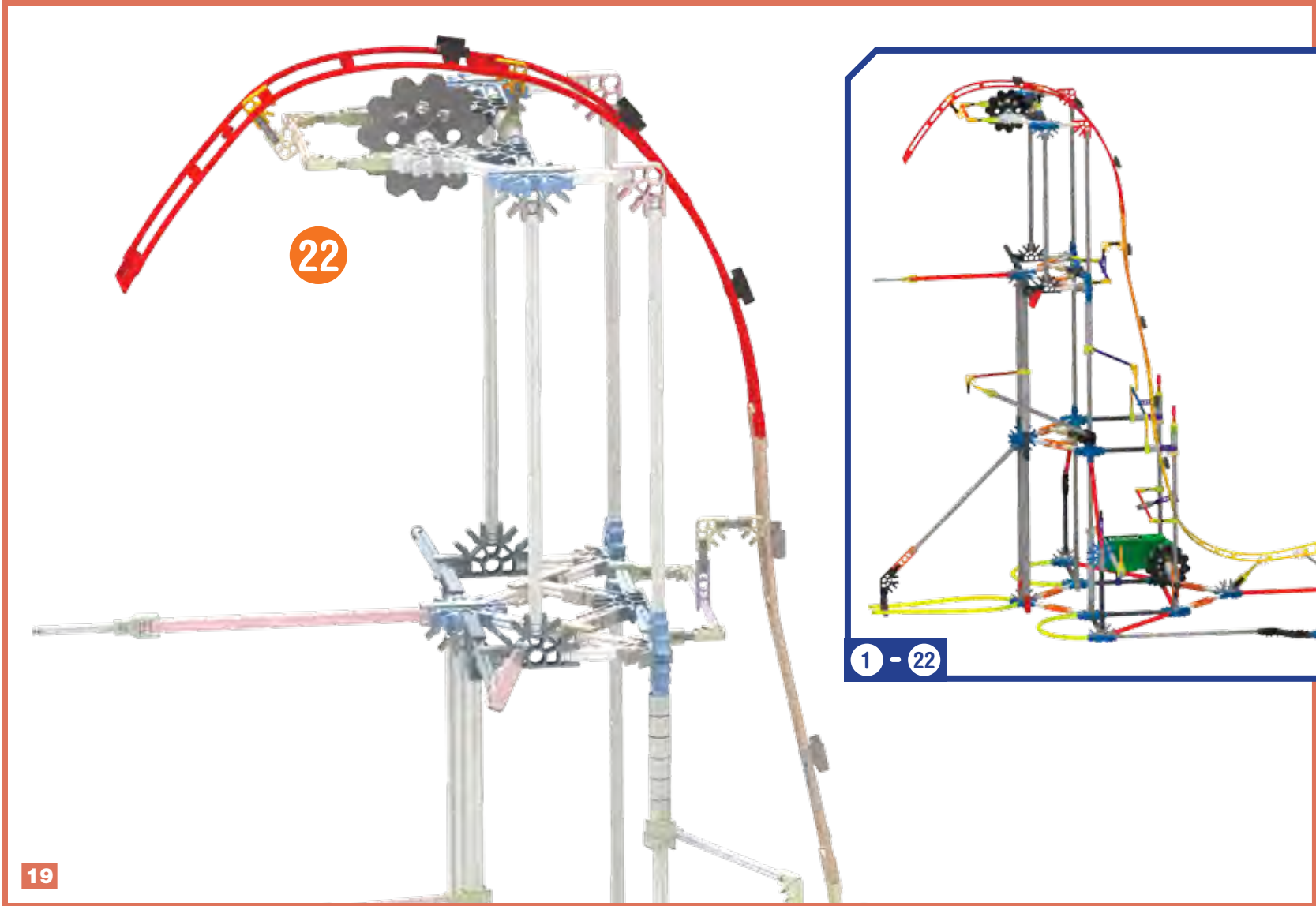
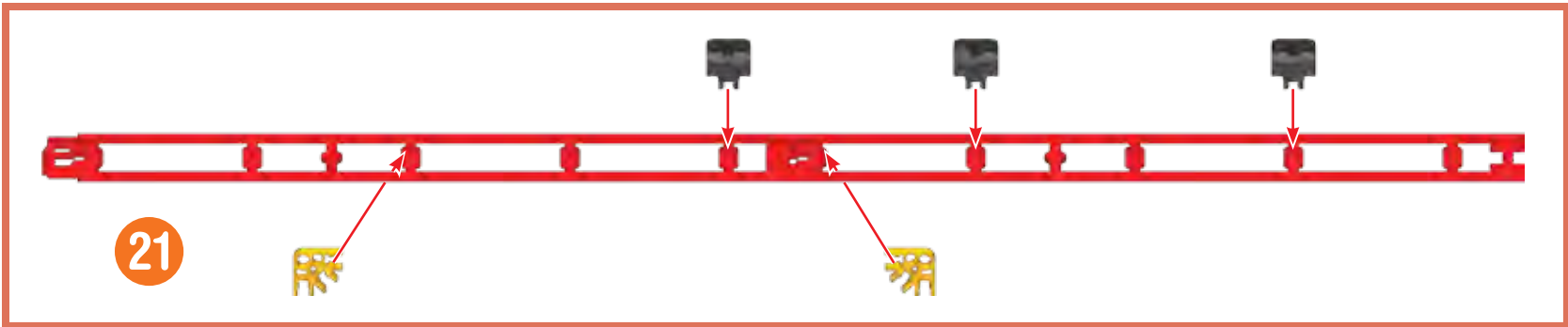

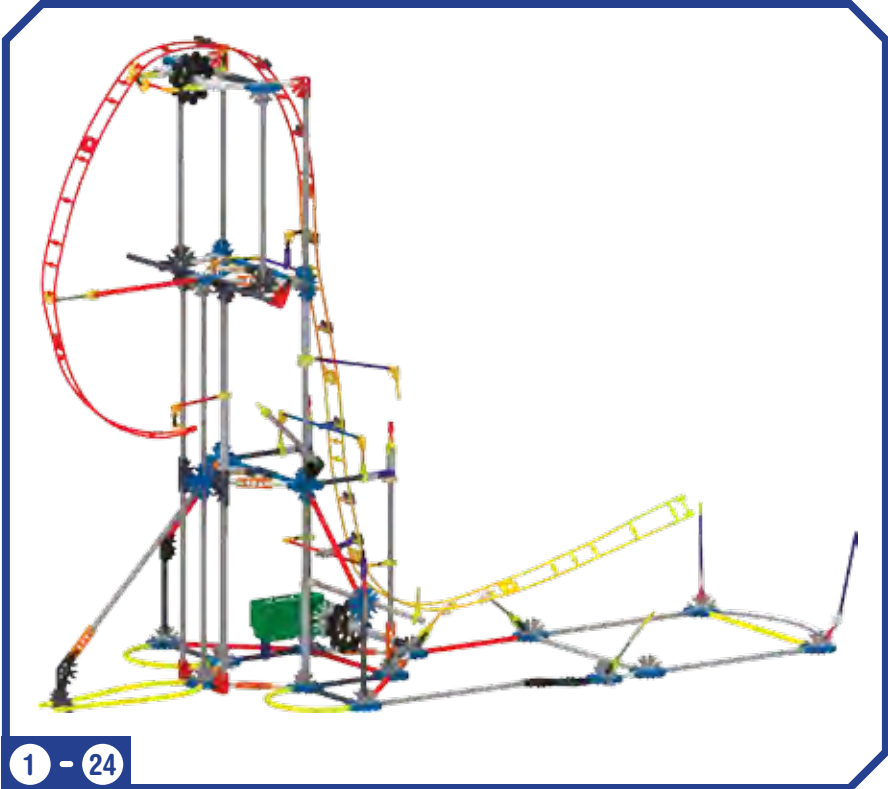

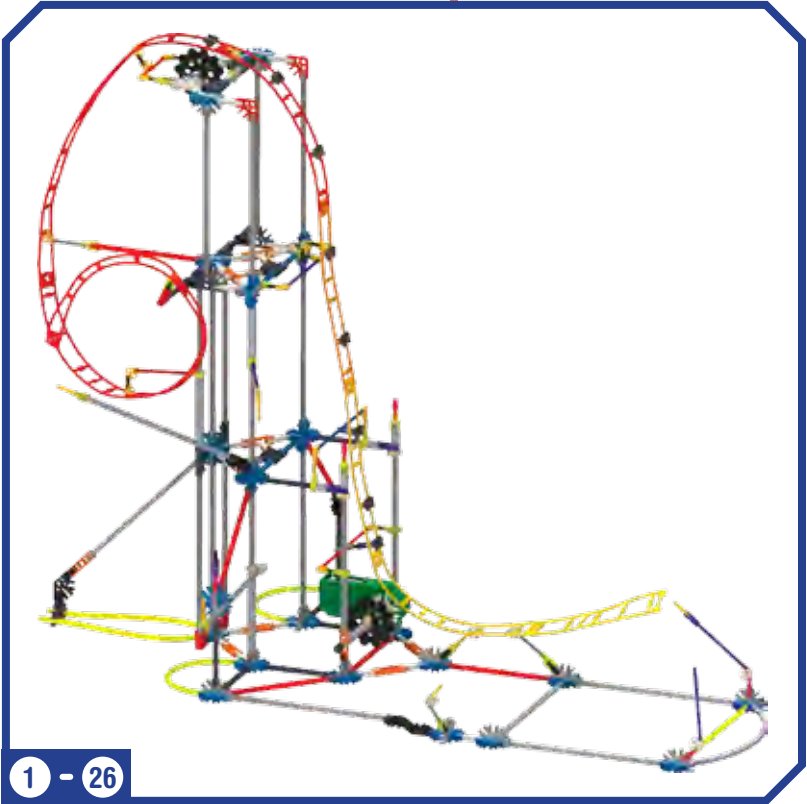
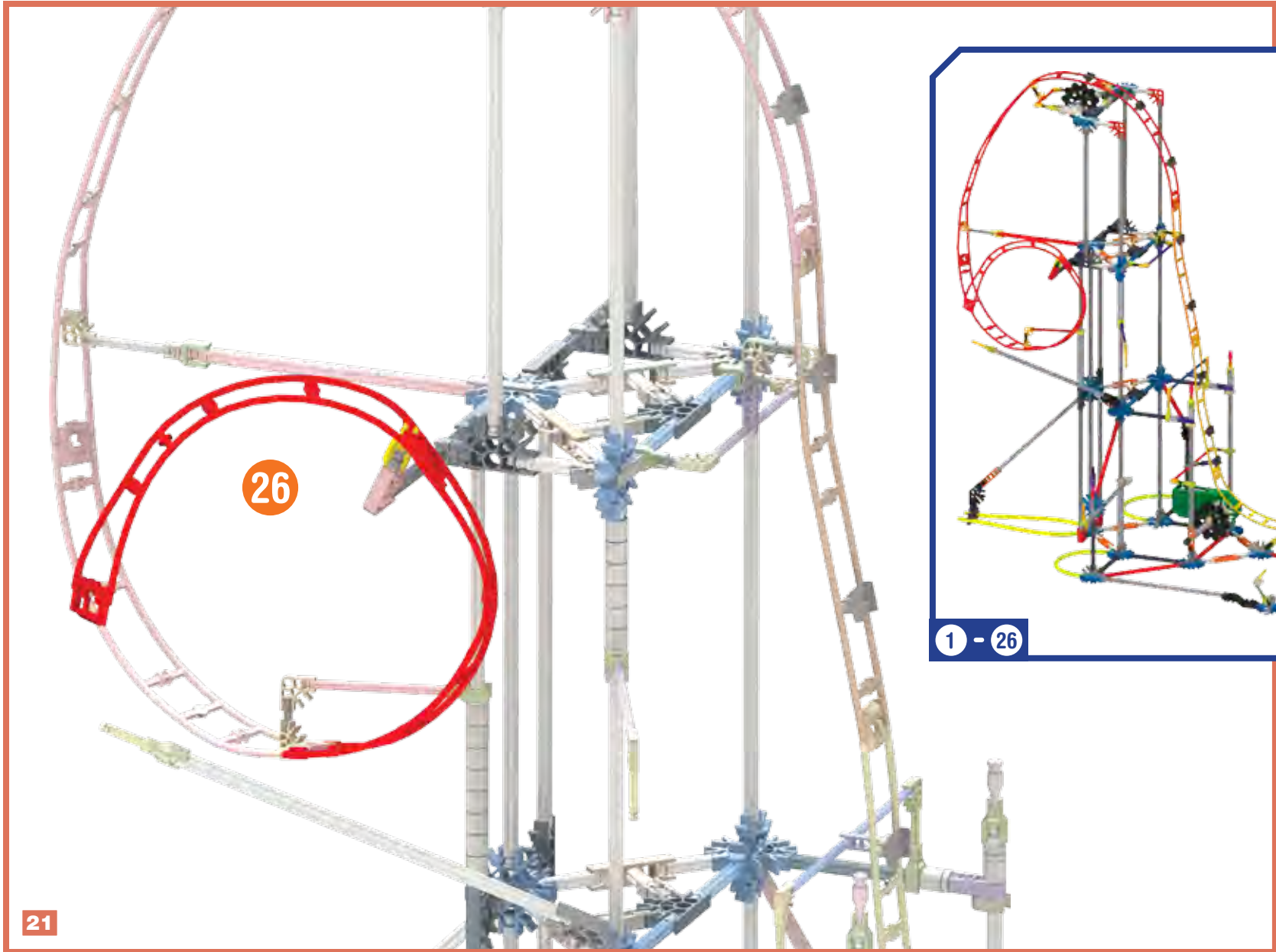
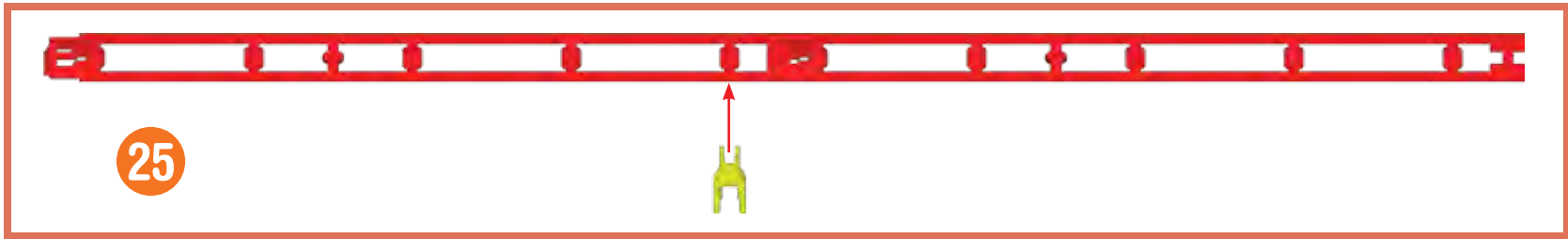

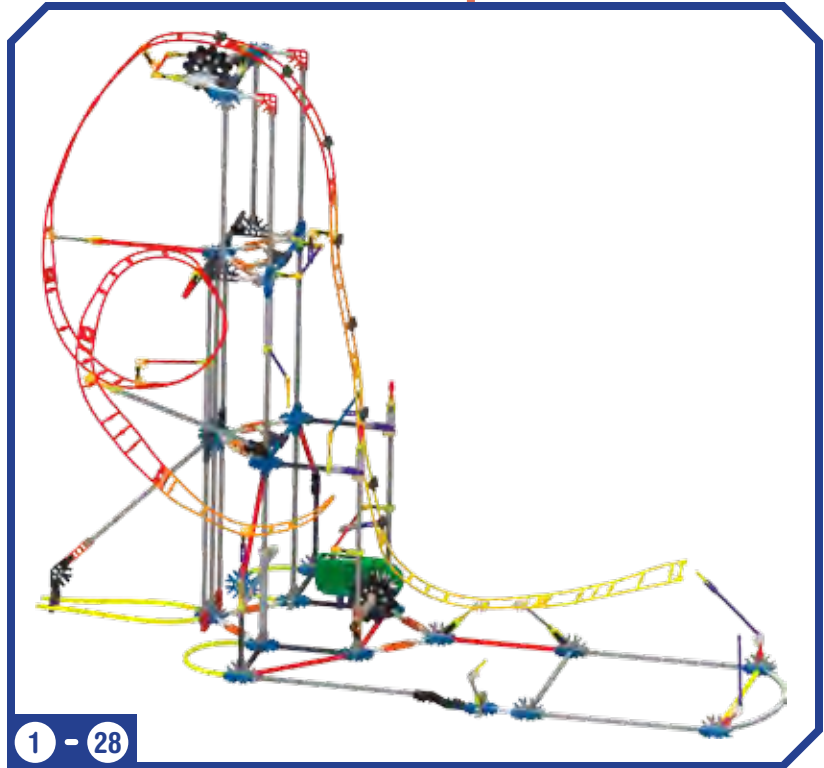
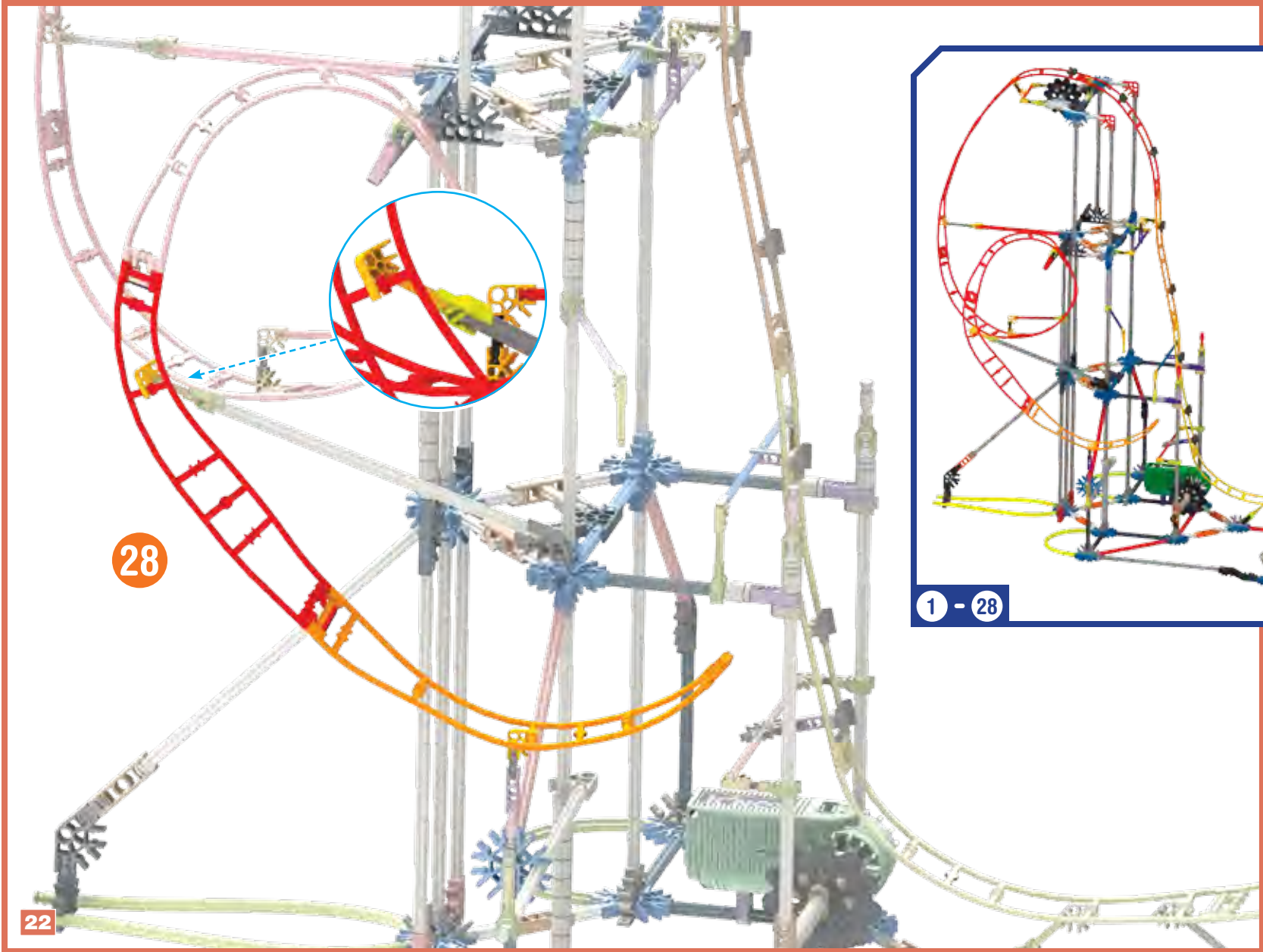

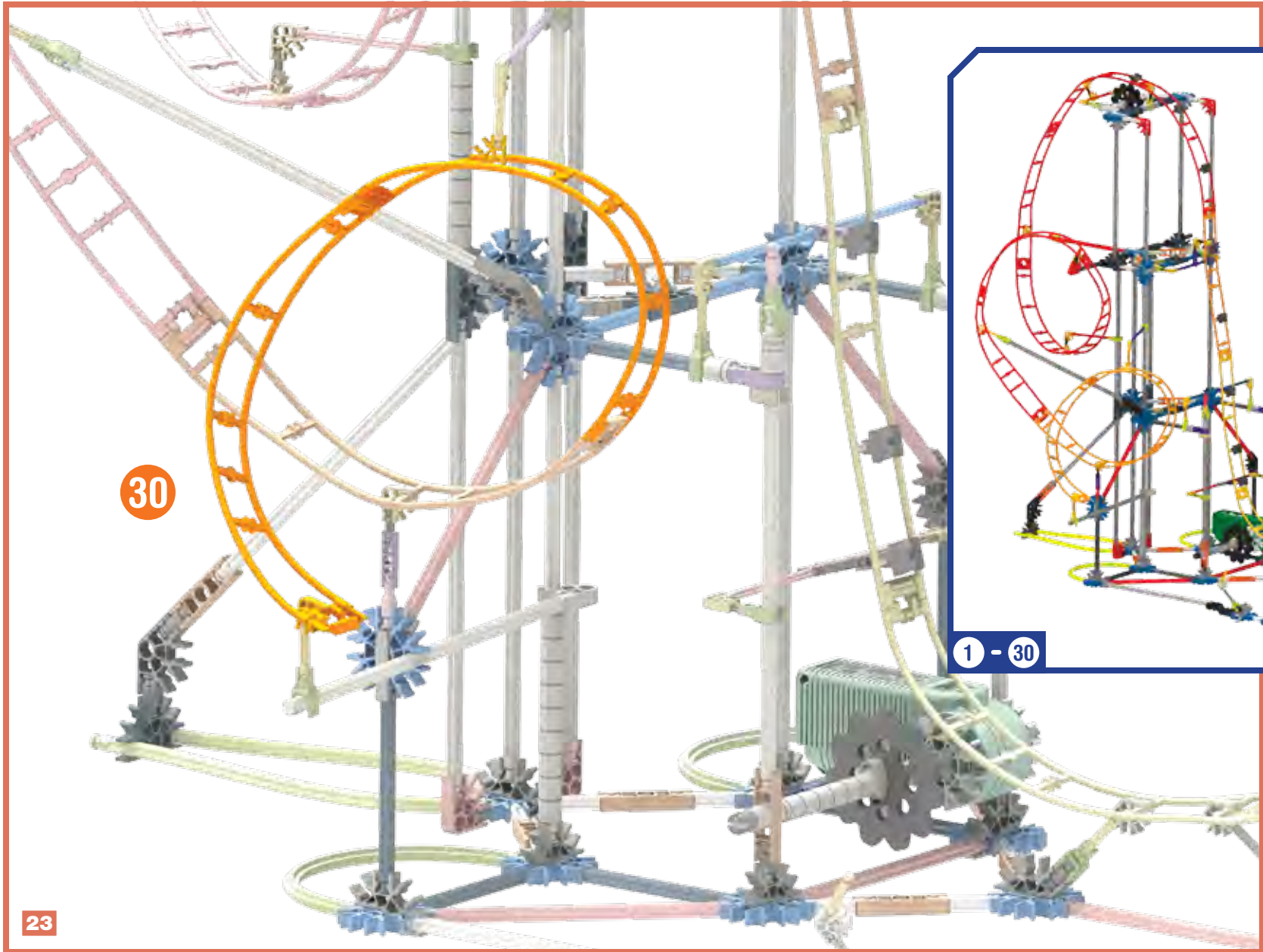

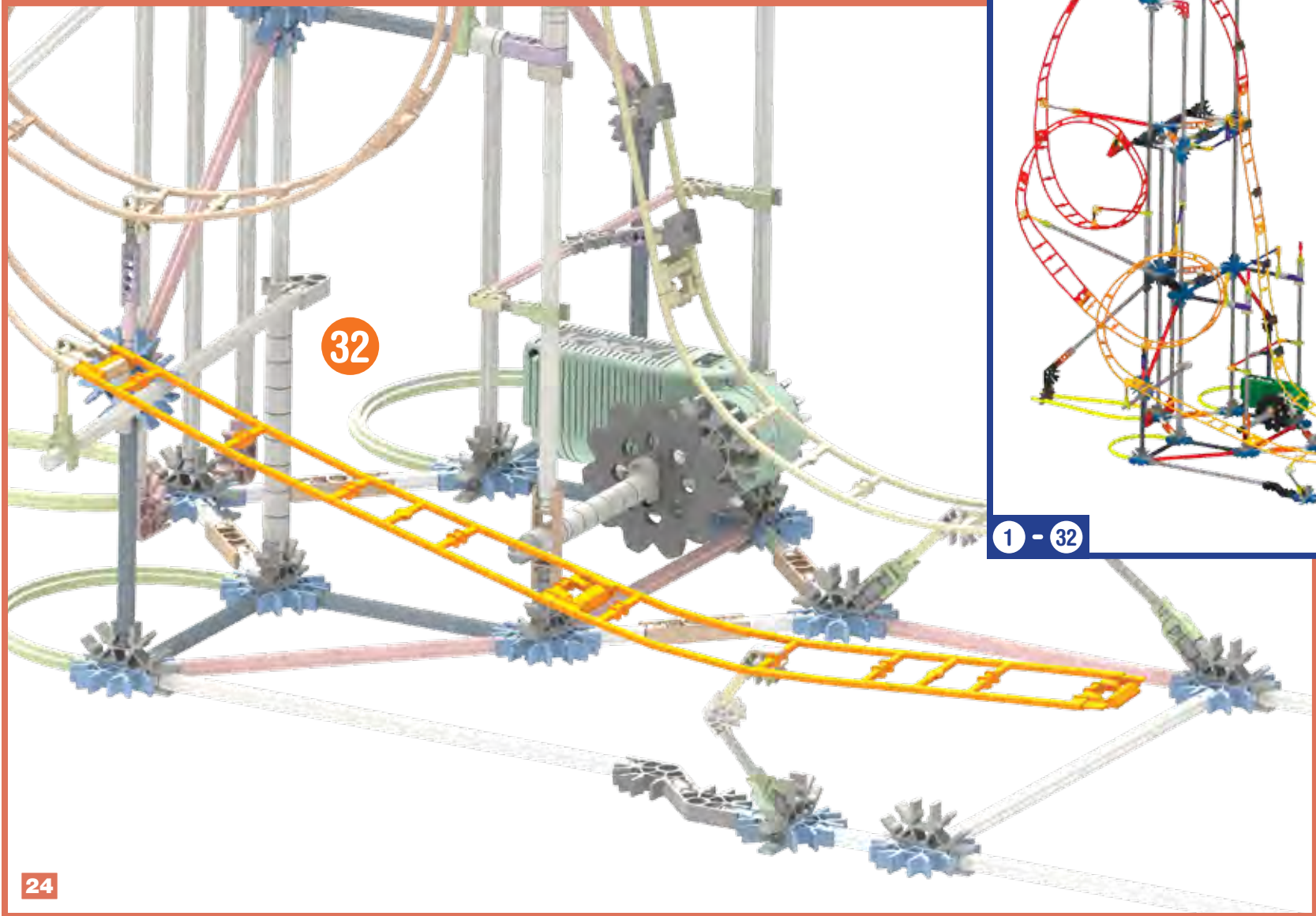

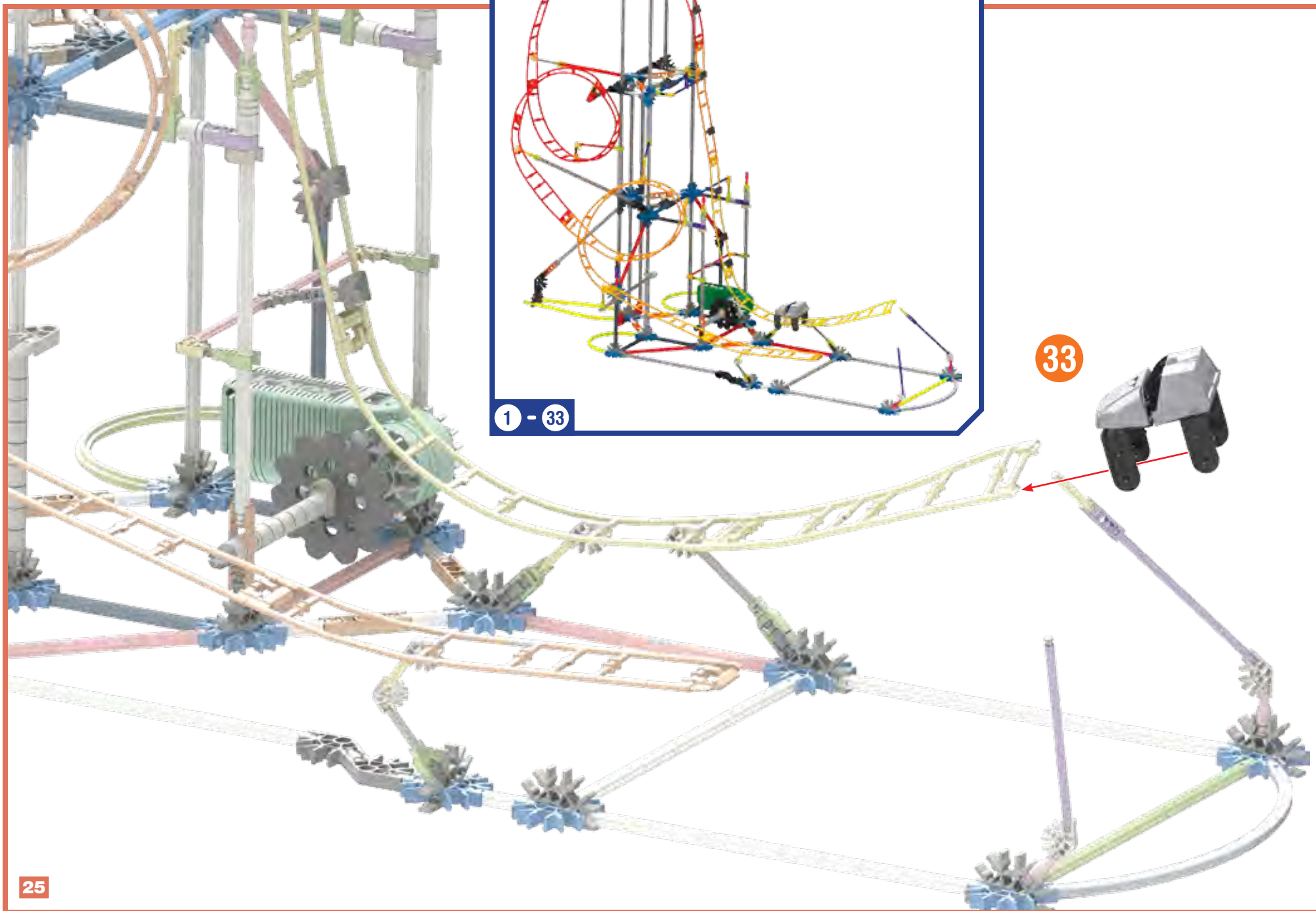

1 - 33

33

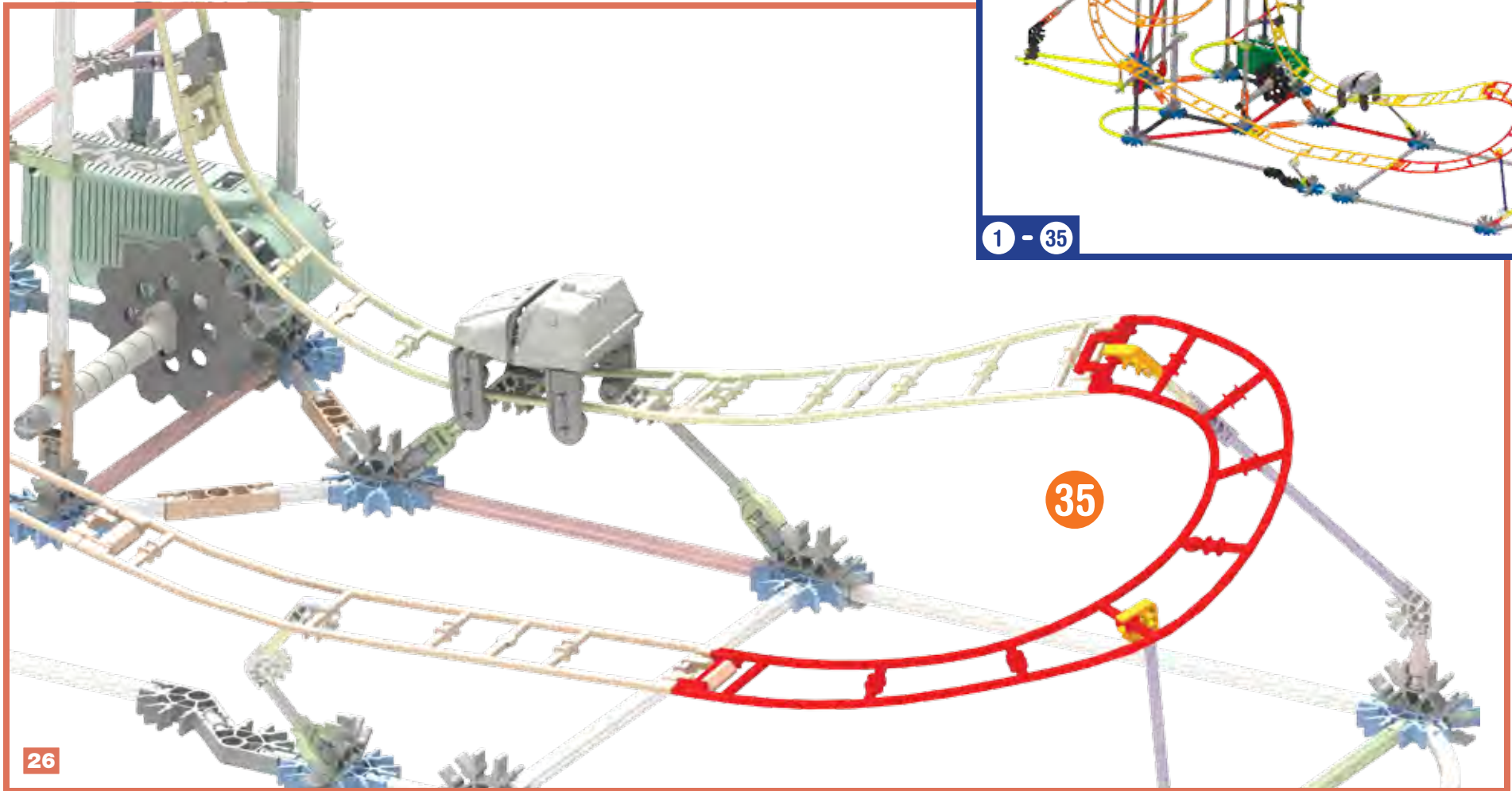
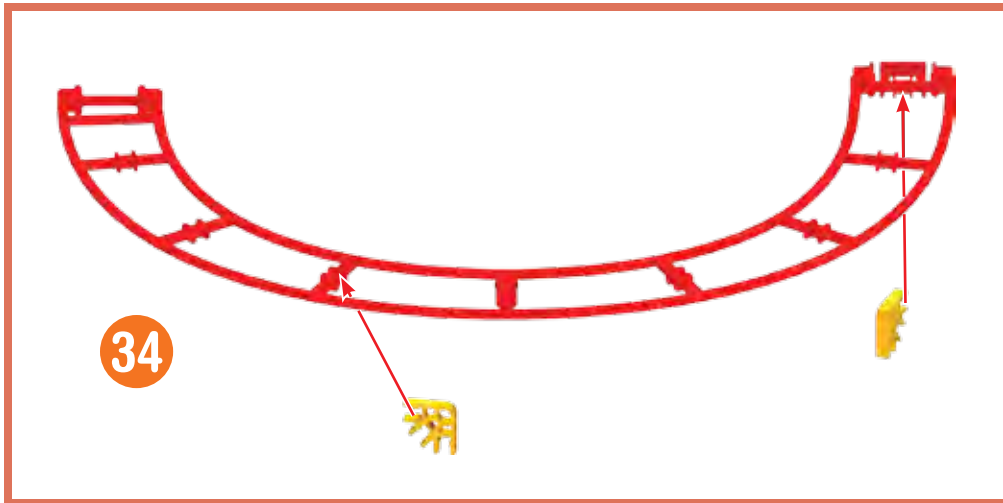



IMPORTANT: Attach all the chain links in the same direction.

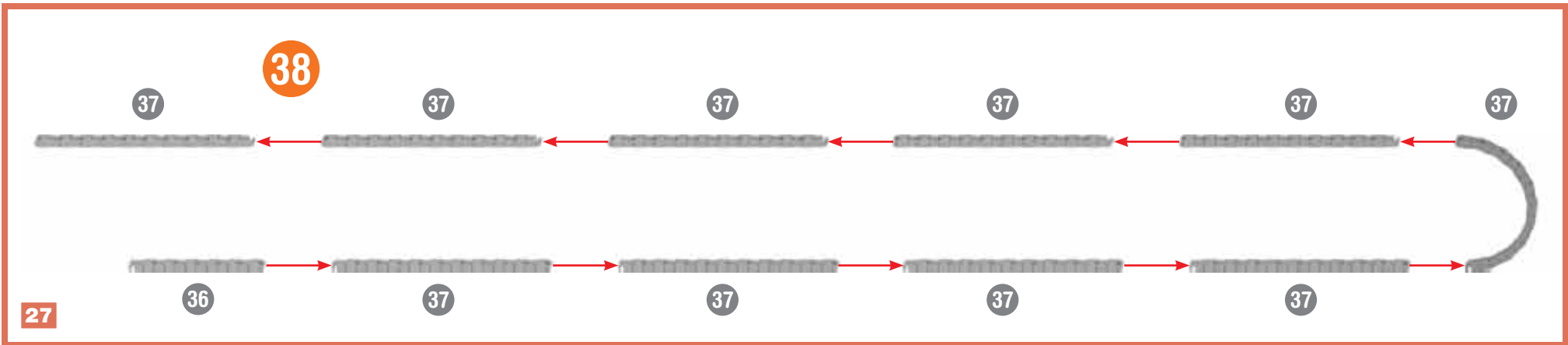

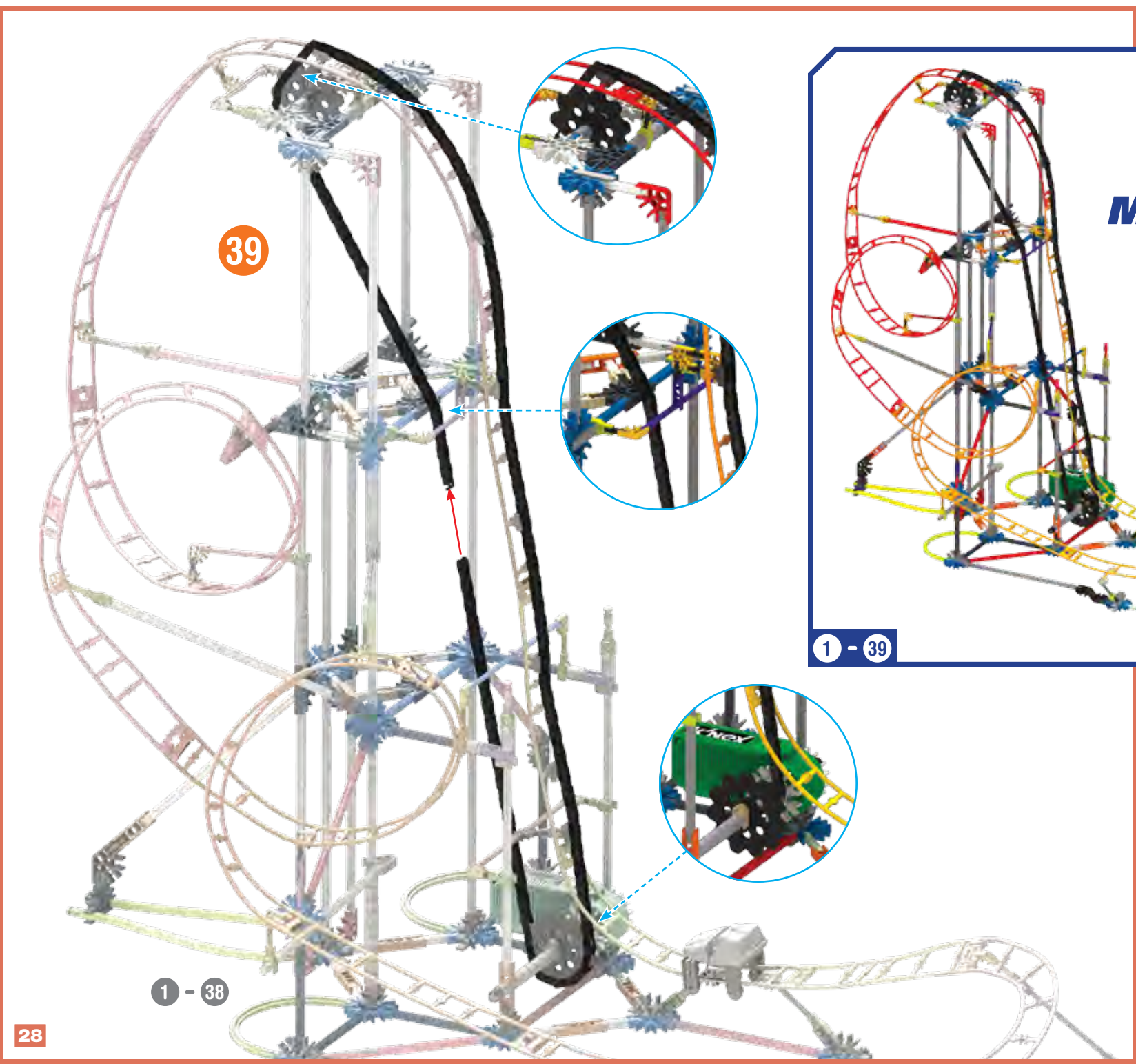

39

1 - 38



K'NEX
MEGA
MONSOON
ROLLER
COASTER

1 - 39