

KNEX

Education®

STEM Building Solution
La Solution de STEM

SIMPLE MACHINES
DELUXE: INCLINED PLANES
MACHINES SIMPLES
SUPER : AVIONS INCLINÉS

9
Models!
Modèles!

KNEX education.com

8+

AGE/ÂGE
ALTER/LEEFTIJD

79520



WARNING:

CHOKING HAZARD - Small parts.
Not for children under 3 years.



ATTENTION :

RISQUE D'ÉTOUFFEMENT. Pièces de petite taille.
Ne convient pas aux enfants de moins de 3 ans.

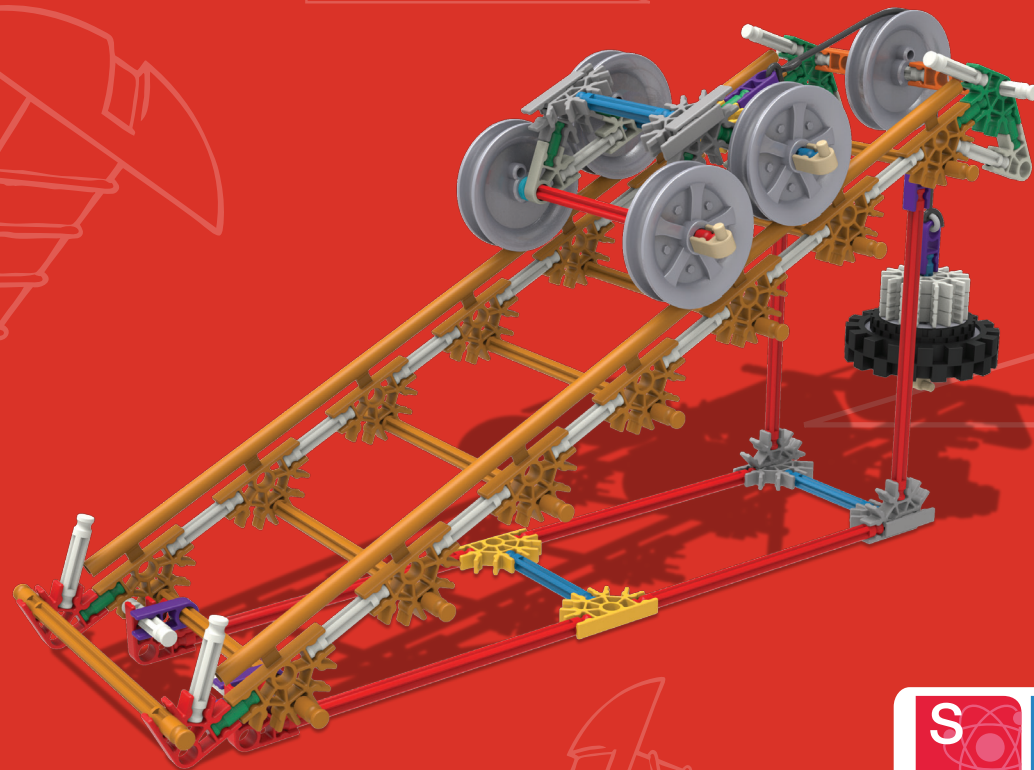

Investigate Inclined Planes!
Enquêter sur les avions inclinés !*



CONTENTS/CONTENUS/INHALT/INHOUD

Roller Coaster Ramps/Rampes de montagnes russes/ Achterbahn Rampen/Achtbaan hellingbanen	3
Moving Truck/Camion mobile/ Fahrender Lastwagen/Bewegende hefttruck	6
Splitting Wedge/Coin fendeur/Spaltkeil/Splitsing wig	9
Chisel/Burin/Meißel/Beitel	10
Axe/Hacha/Axt/Ax	11
Hand Drill/Perceuse à main/ Handbohrmaschine/Handboor	12
Archimedes Screw/Vis d'Archimède/ Archimedische Schraube/Archimedes schroef	13
Propeller/Hélice/Propeller/Propeller	16
Playground Station/Terrain de jeu/Spielplatz Station/ Speeltuinstation	17

(EN) **WARNING:** Not suitable for children under 18 months. Long cord/Long chain. Strangulation hazard.

(DE) **ACHTUNG:** Nicht geeignet für Kinder unter 18 Monate. Lange Schnur / Lange Kette. Strangulierungsgefahr.

(FR) **AVERTISSEMENT :** Ne convient pas aux enfants de moins de 18 mois. Longue corde/Longue chaîne. Risque d'étranglement.

(NL) **WAARSCHUWING:** Niet geschikt voor kinderen onder de 18 maanden. Lang snoer / lange keten. Gevaar voor worging.

CAUTION: Rubber Bands can cause injury from snap-back, breaking, or loss of control. While assembling models shown in instructions, hold Rubber Band tightly, and do not overstretch. Use Rubber Bands only as shown in these instructions. **DO NOT USE FRAYED OR TORN RUBBER BANDS. CAUTION:** Keep Rubber Bands away from face and eyes.

ATTENTION : Les élastiques peuvent causer des blessures en claquant, en se brisant ou quand on les manipule imprudemment. Tenez fermement les élastiques lors de l'assemblage du modèle en veillant à ne pas trop les tendre. Utilisez les élastiques que selon les instructions comme indique. **N'UTILISEZ PAS D'ÉLASTIQUES DISTENDUS OU ABIMÉS. ATTENTION :** Tenez les élastiques à l'écart du visage et des yeux.

VORSICHT: Gummibänder können Verletzungen hervorrufen, wenn sie reißen, zurückspringen oder wenn sie nicht vorsichtig gehandhabt werden. Halten Sie die Gummibänder während des Zusammenbaus der Modelle fest, ohne sie jedoch zu überdehnen. Verwenden Sie die Gummibänder gemäß den Anweisungen. **VERWENDEN SIE NIEMALS AUSGEFRANSTE ODER ZERRISSENE GUMMIBÄNDER. VORSICHT:** Halten Sie Gummibänder weg von Gesicht und Augen.

LET OP: Elastiekjes kunnen letsel veroorzaken als ze wegschieten, kapotgaan of als er achteloos mee wordt omgegaan. Houd elastiekjes goed vast als je modellen bouwt volgens de instructies. Rek ze niet te ver uit. Gebruik elastiekjes uitsluitend zoals in de instructies beschreven staat. **GEBRUIK GEEN GERAFELDE OF GESCHOURDE ELASTIEKJES. LET OP:** houd elastiekjes uit de buurt van het gezicht en de ogen.

⚠ **WARNING:** CHOKING HAZARD – Small Parts. Not for children under 3 years.

⚠ **ATTENTION :** RISQUE D'ÉTOUFFEMENT – Pièces de petite taille. Ne convient pas aux enfants de moins de 3 ans.

⚠ **ACHTUNG:** ERSTICKACHTUNG – Kleinteile. Nicht geeignet für Kinder unter 3 Jahren.

⚠ **WAARSCHUWING:** INSLIKKINGSGEVAAR – Kleine Onderdelen. Niet geschikt voor kinderen jonger dan 3 jaar.

K'NEX Building Basics

To begin your model, find the 1 and follow the numbers. Each piece has its own shape and color. Just look at the pictures, find the pieces in your set that match and then connect them together. Try to face your model in the same direction as the instructions while you build. The arrows show you where the parts connect, but not all connection points have arrows. Faded colors indicate sections previously built; connecting points will be in full color.

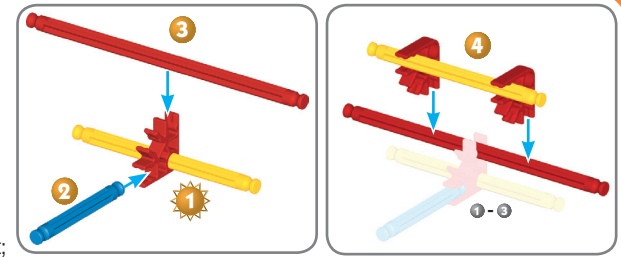

(FR) Notions De Base K'NEX Pour Le Montage

Pour commencer ton modèle, trouve l'étape numéro 1 et suis les numéros. Chaque pièce a sa propre forme et sa propre couleur. Regarde les illustrations, trouve les pièces qui correspondent à ce que tu vois et assemble-les. Pour t'aider pendant que tu construis, oriente ton modèle dans le même sens que les instructions. Les flèches t'indiquent où les pièces s'assemblent, mais les points de raccordement n'ont pas tous des flèches. Les couleurs plus claires indiquent les sections déjà construites. Les points de jonction sont indiqués en couleurs vives.

(DE) Grundlegende Bauanleitungen Für K'NEX

Um mit dem Bauen deines Modells zu beginnen, suche die Nummer 1 und folge den laufenden Nummern. Jedes Teil hat seine eigene Form und Farbe. Schau dir einfach die Abbildungen an, such die Teile in deinem Bausatz, die so aussehen wie das, was du auf der Abbildung siehst und steck sie ineinander. Versuche, dein Modell beim Zusammenbauen so zu orientieren, dass es in die gleiche Richtung weist, wie es in den Anleitungen beschrieben und gezeigt wird. Teile zeigen bereits zusammengebaute Abschnitte an. Die Anbringungspunkte sind in kräftigen Farben dargestellt.

(NL) Bouwen met K'NEX

Om te starten met de bouw van je model begin je bij 1 en volg je de nummers. Elk onderdeel heeft een eigen vorm en kleur. Kijk goed naar de plaatjes. Zoek de onderdelen in je set die overeenstemmen met de onderdelen op de plaatjes en verbind ze met elkaar. Probeer tijdens het bouwen je model in dezelfde richting te laten wijzen als in de instructies. De pijlen geven aan waar je onderdelen met elkaar moet verbinden, al worden niet alle verbindingpunten aangeduid door pijlen. Verbleekte kleuren geven de eerder gebouwde gedeeltes aan; de aansluitpunten worden in felle kleuren weergegeven.

Connectors

You can slide these special connectors together. Push tightly until you hear a "click". Pay close attention to the instructions and position them horizontally or vertically exactly as they are shown.

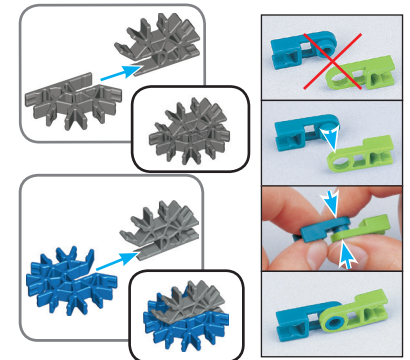

(FR) Connecteurs

Tu peux assembler ces connecteurs tout à fait uniques en les faisant glisser l'un avec l'autre. Pousse fort jusqu'à ce que tu entendes un « clic ». Lis les instructions attentivement et positionne les horizontalement ou verticalement, en suivant exactement les illustrations.

(DE) Verbindungsstücke

Diese besonderen Verbindungsstücke kannst du zusammenschieben. Drücke sie fest, bis du ein Klicken hörst. Achte genau auf die Anleitung und positioniere die Verbindungsstücke genau wie in der Abbildung.

(NL) Verbindingsstukken

Je kunt deze speciale verbindingstukken in elkaar steken. Duw ze stevig tegen elkaar aan tot je een 'klik' hoort. Let goed op de instructies en plaats ze horizontaal en verticaal, precies zoals wordt getoond.

Spacers

There are places in your model where you need to use spacers. Be sure to use the correct color and number of spacers shown in the instructions.

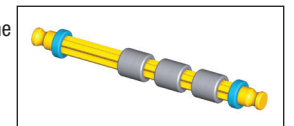

(FR) Espaces

Il y a des endroits sur ton modèle où tu auras besoin de te servir d'espaces. Assure-toi d'utiliser la bonne couleur et le nombre d'espaces indiqué sur les instructions.

(DE) Abstandsstücke

An manchen Stellen in deinem Modell musst du Abstandsstücke einbauen. Achte darauf, die richtige Farbe und Anzahl von Abstandsstücken wie in der Anleitung gezeigt zu verwenden.

(NL) Afstandhouders

Op bepaalde plekken van je model moet je afstandhouders gebruiken. Zorg dat je het juiste aantal afstandhouders gebruikt, zoals wordt getoond in de instructies.

Roller Coaster Ramps

Rampes de montagnes russes

Achterbahn Rampen

Achtbaan hellingbanen

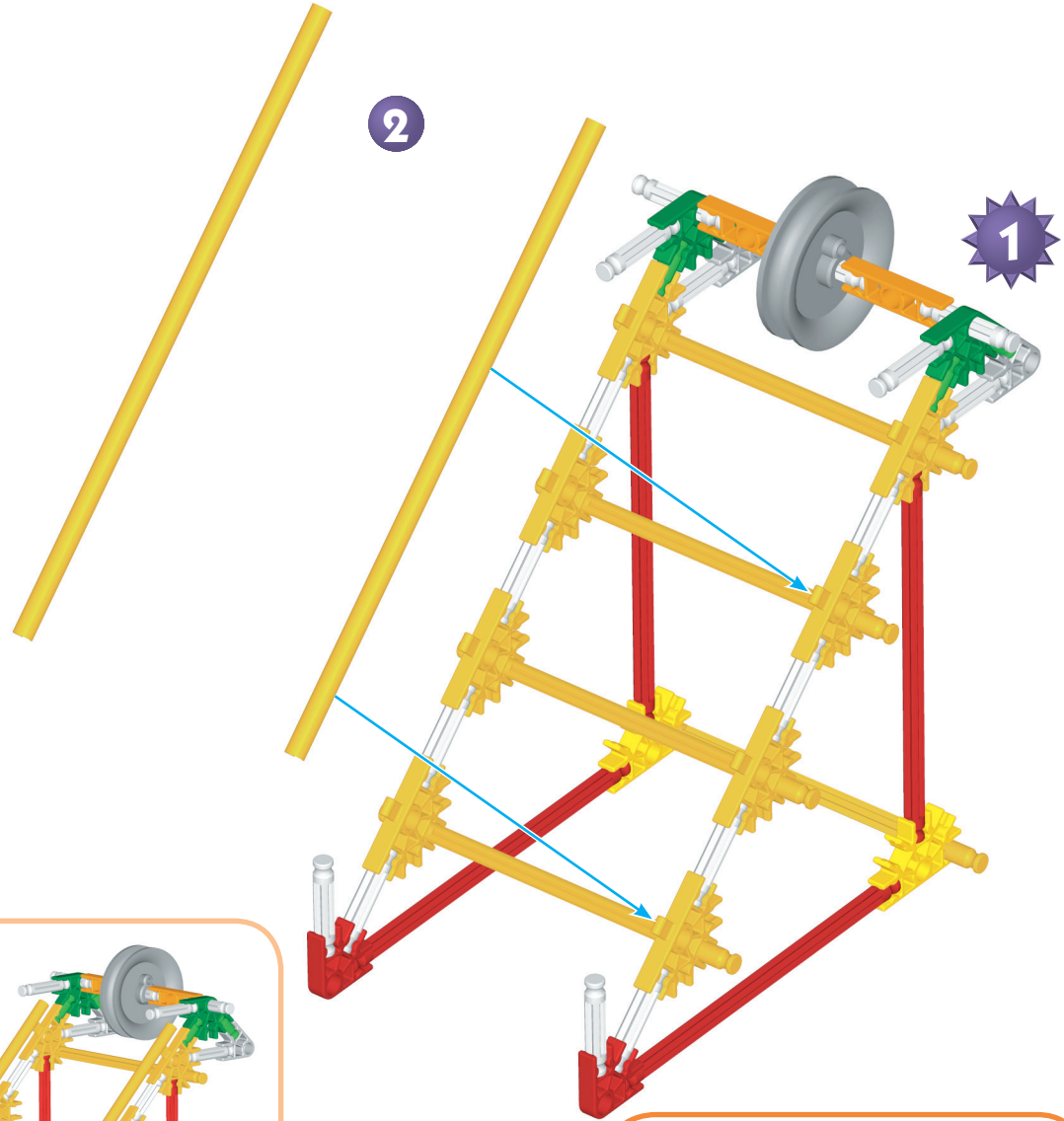
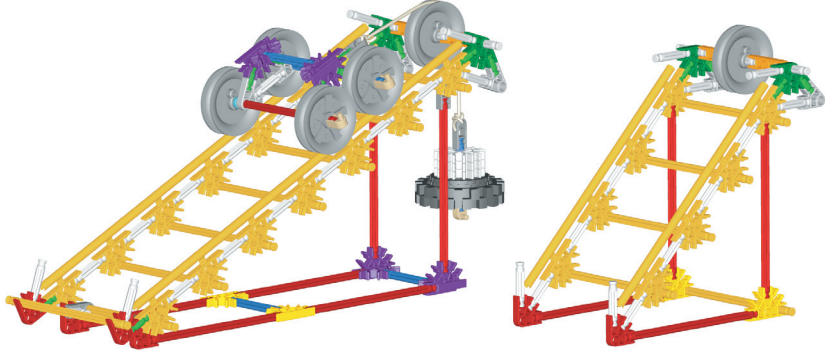

(EN) Keep this important information for future reference. **CAUTION:** Keep hands, face, hair and clothing away from all moving parts. Use care where you use these models. Models could damage furniture or walls, or injure people or pets.

(FR) Gardez précieusement cette notice pour t'y référer ultérieurement.
ATTENTION : Gardez les cheveux, les doigts, le visage et les vêtements à l'écart de toutes les pièces mobiles. Utilisez des soins là où vous utilisez ce modèles. Modèles pourrait endommager les meubles ou les murs, ou blesser des personnes ou des animaux domestiques.

(DE) Informationen für später aufbewahren. **VORSICHT:** Haare, Finger, Gesicht und Kleidungsstücke nicht mit beweglichen Teilen in Berührung kommen lassen. Seien Sie vorsichtig, wo Sie diese Modelle zu verwenden. Die Modelle könnten Möbel und Wände beschädigen oder Personen und Haustiere verletzen.

(NL) Bewaar deze belangrijke informatie, zodat u deze in de toekomst opnieuw kunt raadplegen. **LET OP:** Hou het haar, de vingers, het gezicht en kledij verwijderd van alle bewegende onderdelen. Wees voorzichtig waar u deze modellen te gebruiken. Modellen kunnen meubels of muren beschadigen of verwonden mensen of dieren.

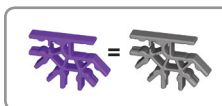

K'NEX Education				
5	4	8	1	
6	5	15	1	
4	22	42	1	
8	8	6	7	
6	3	11	1	
		13	1	
			1	

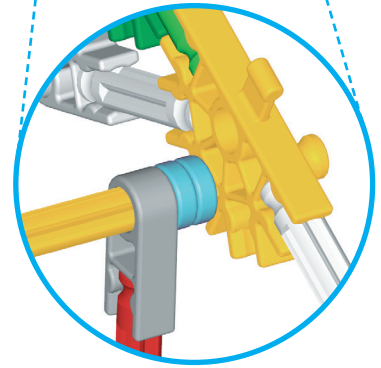
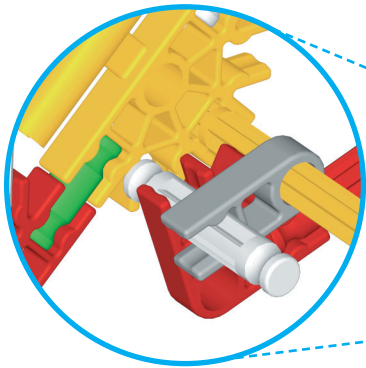
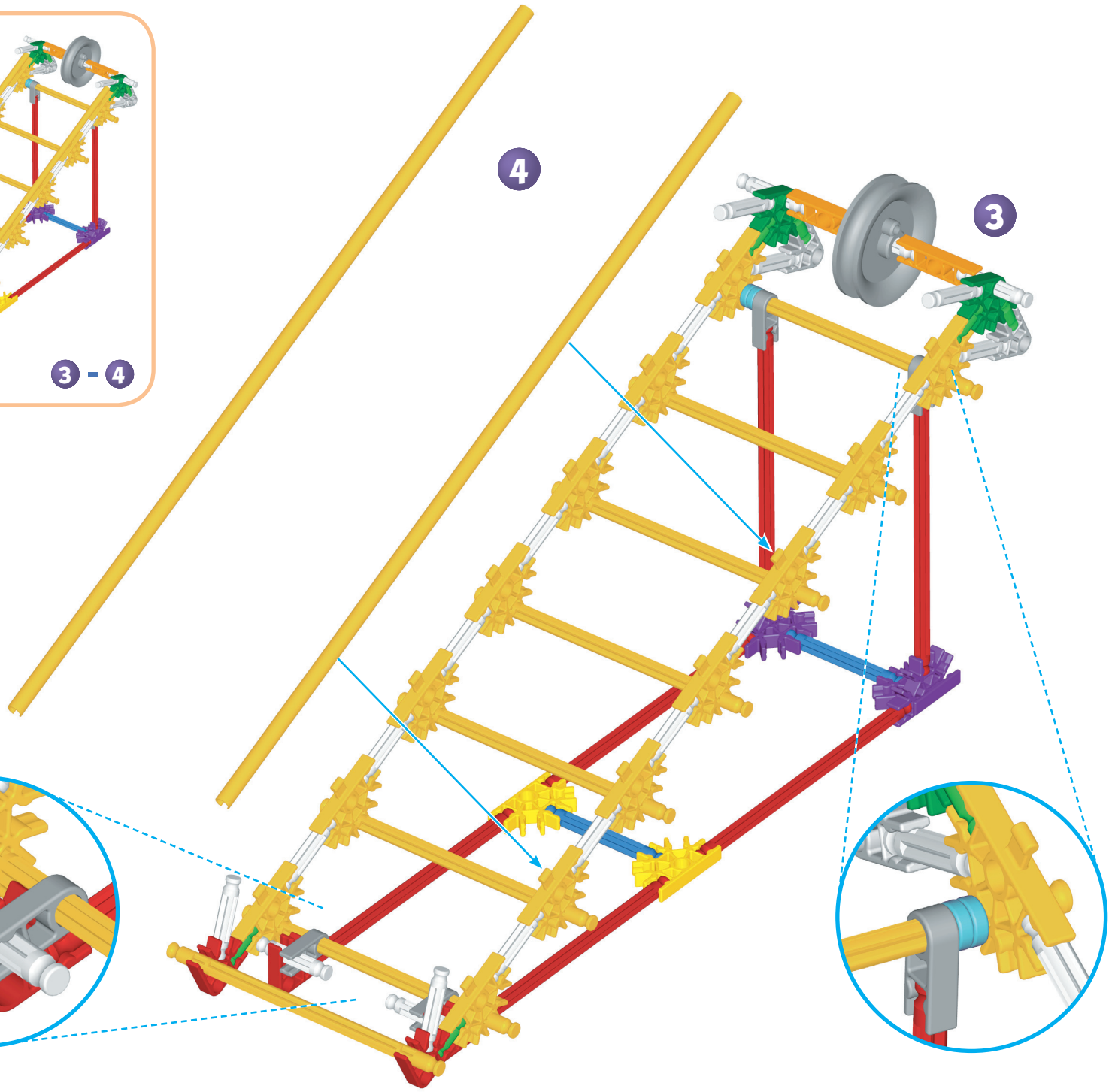

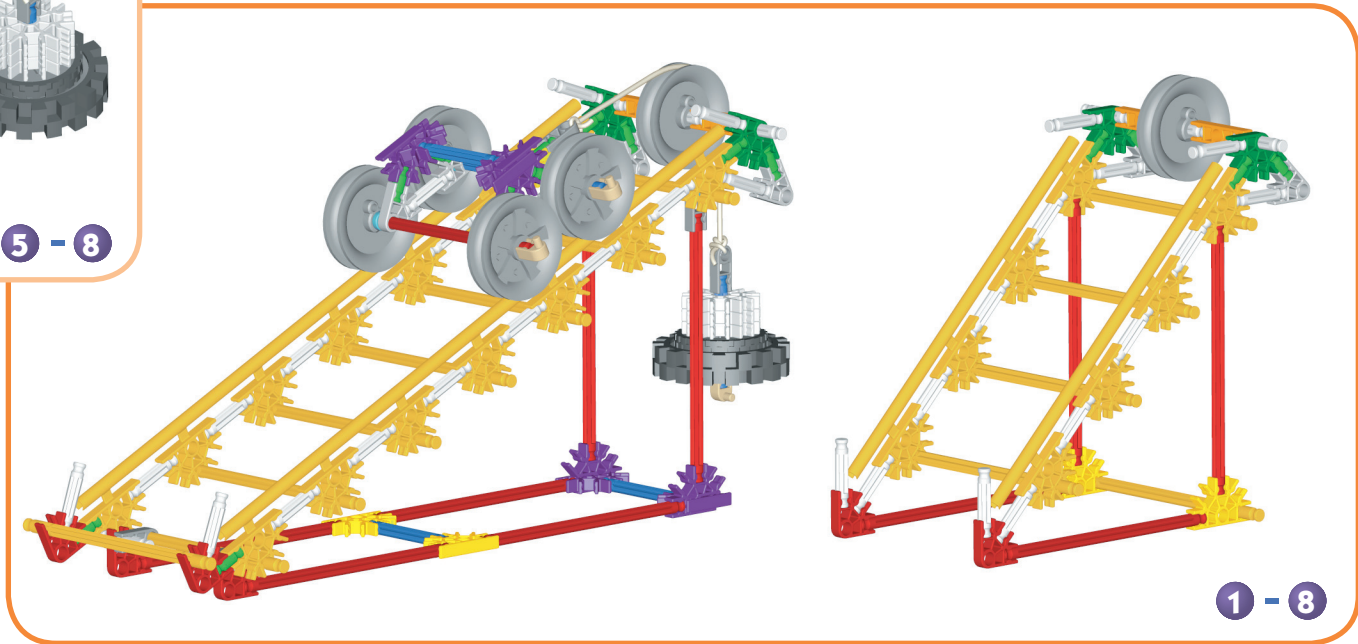
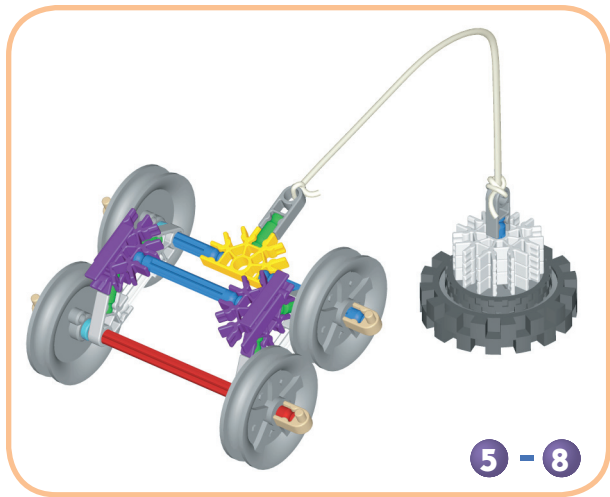
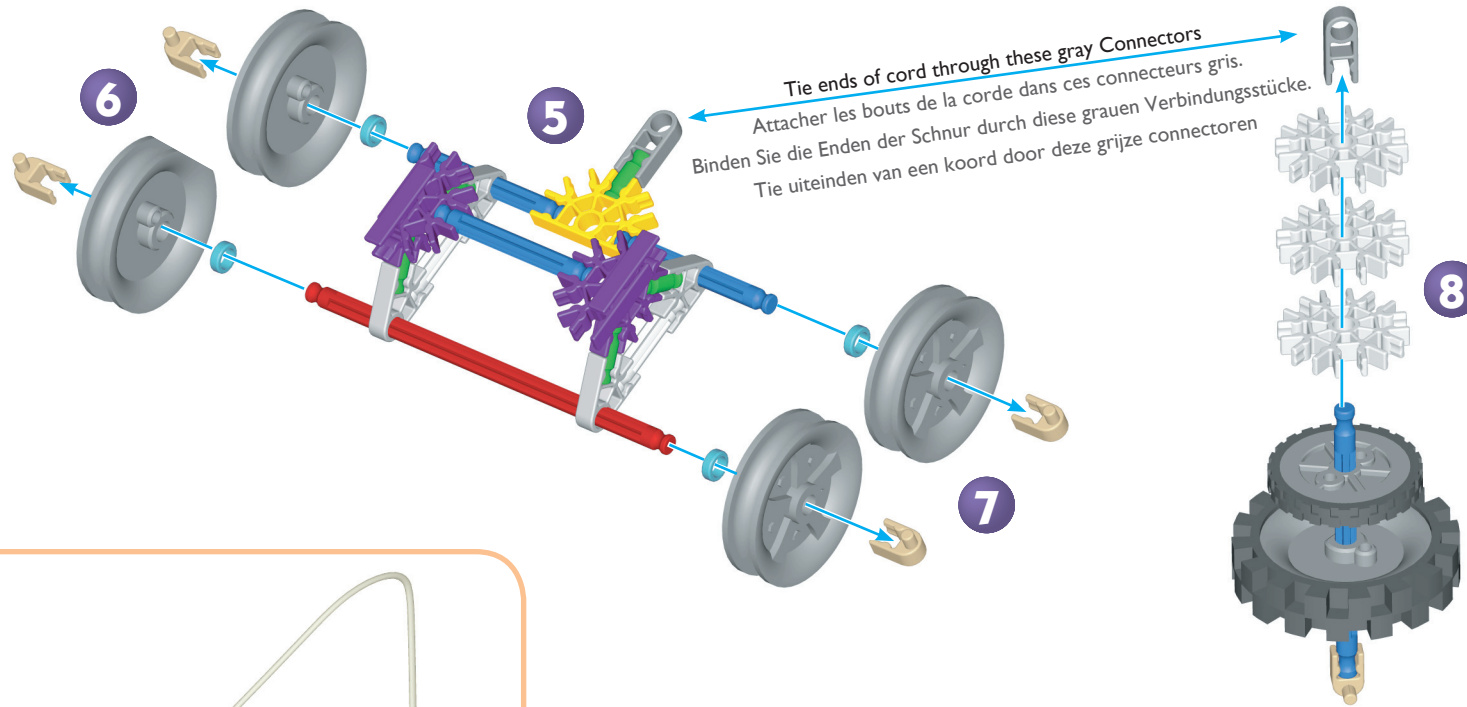

Moving Truck

Camion mobile
Fahrender Lastwagen
Bewegende heftruck

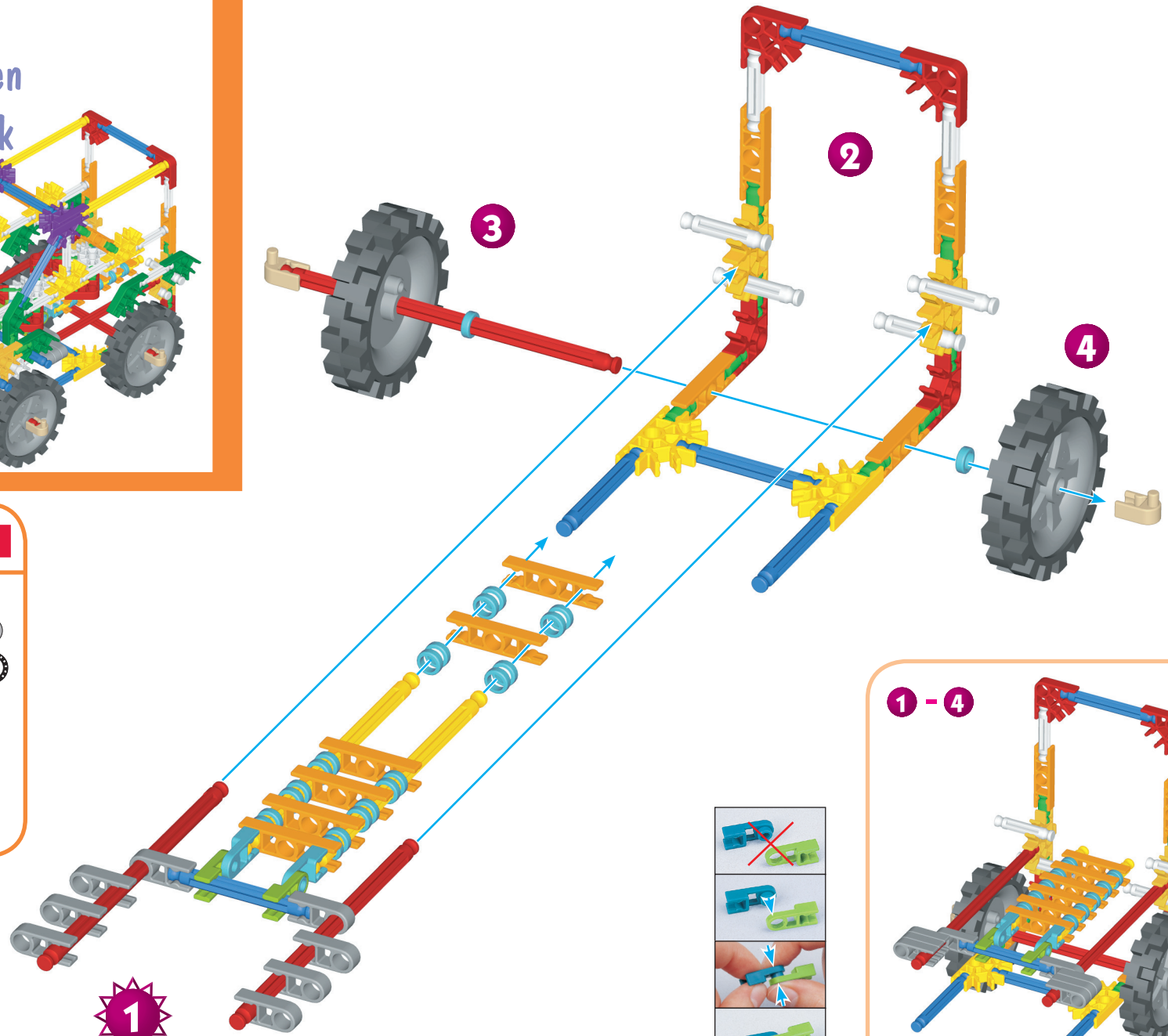

K'NEX Education

- | | | |
|----|----|---|
| 4 | 24 | 2 |
| 8 | 43 | 4 |
| 12 | 28 | 4 |
| 12 | 12 | |
| 8 | 4 | |
| 8 | 4 | |
| 6 | 2 | |
| 10 | 2 | |
| 6 | | |

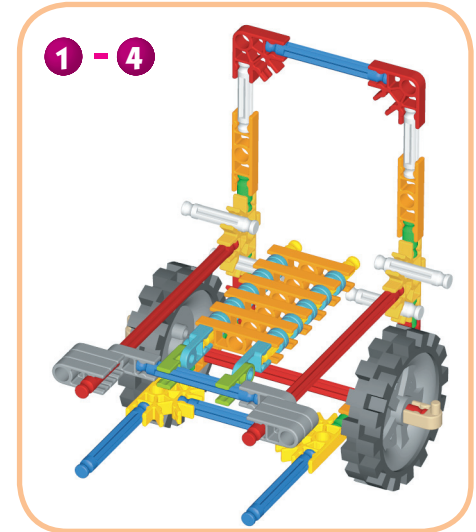
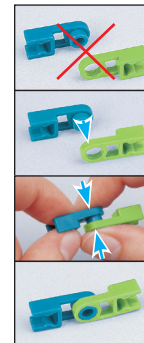

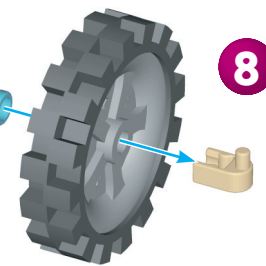
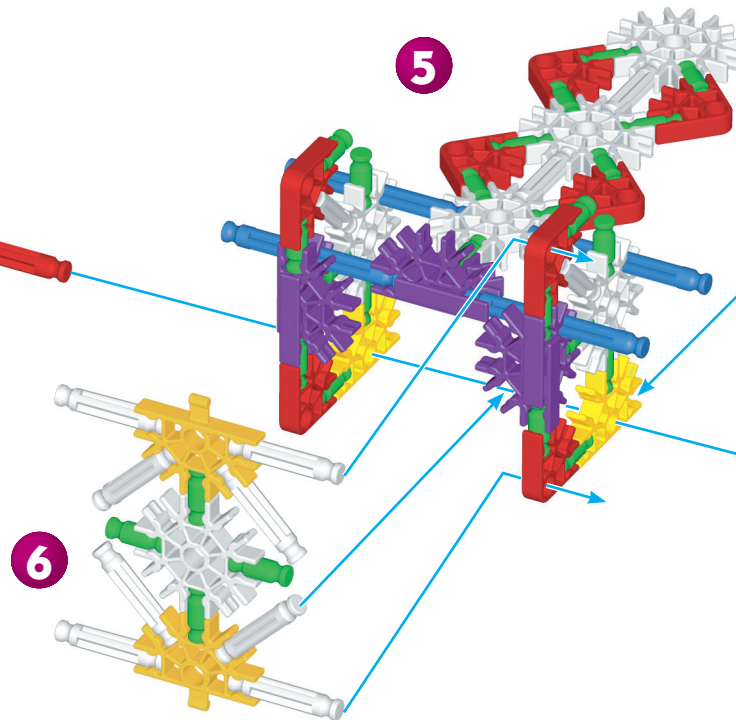
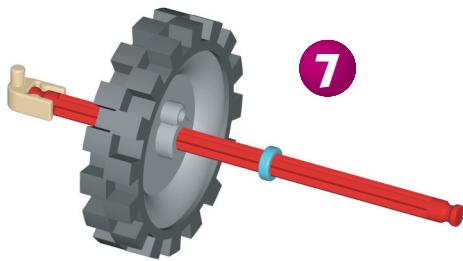
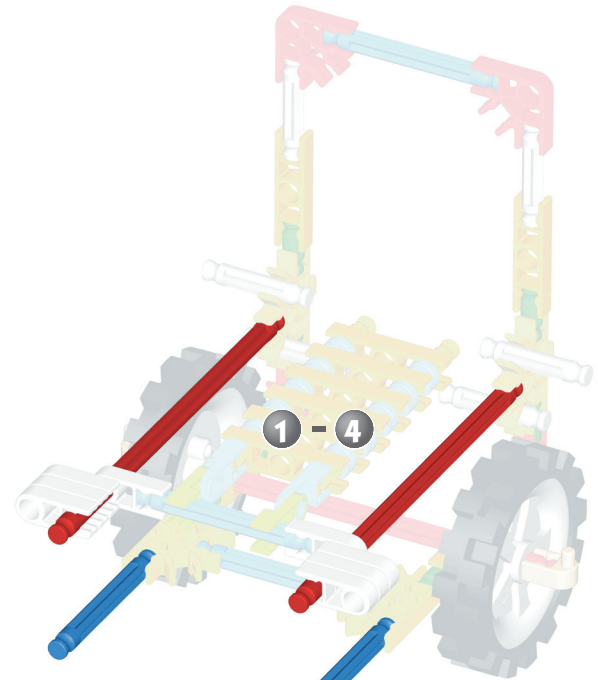
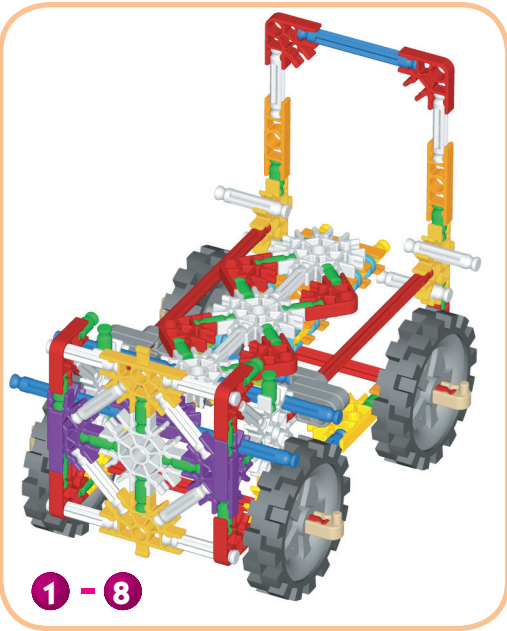

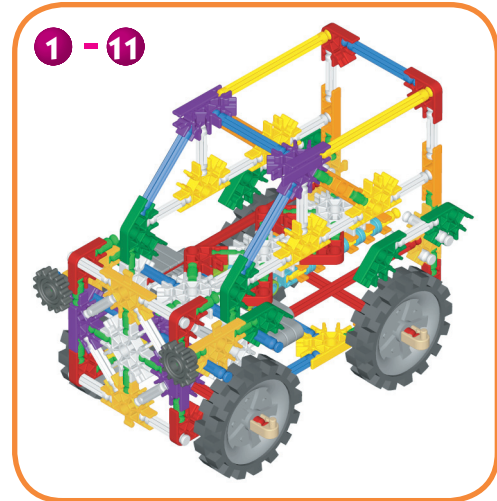
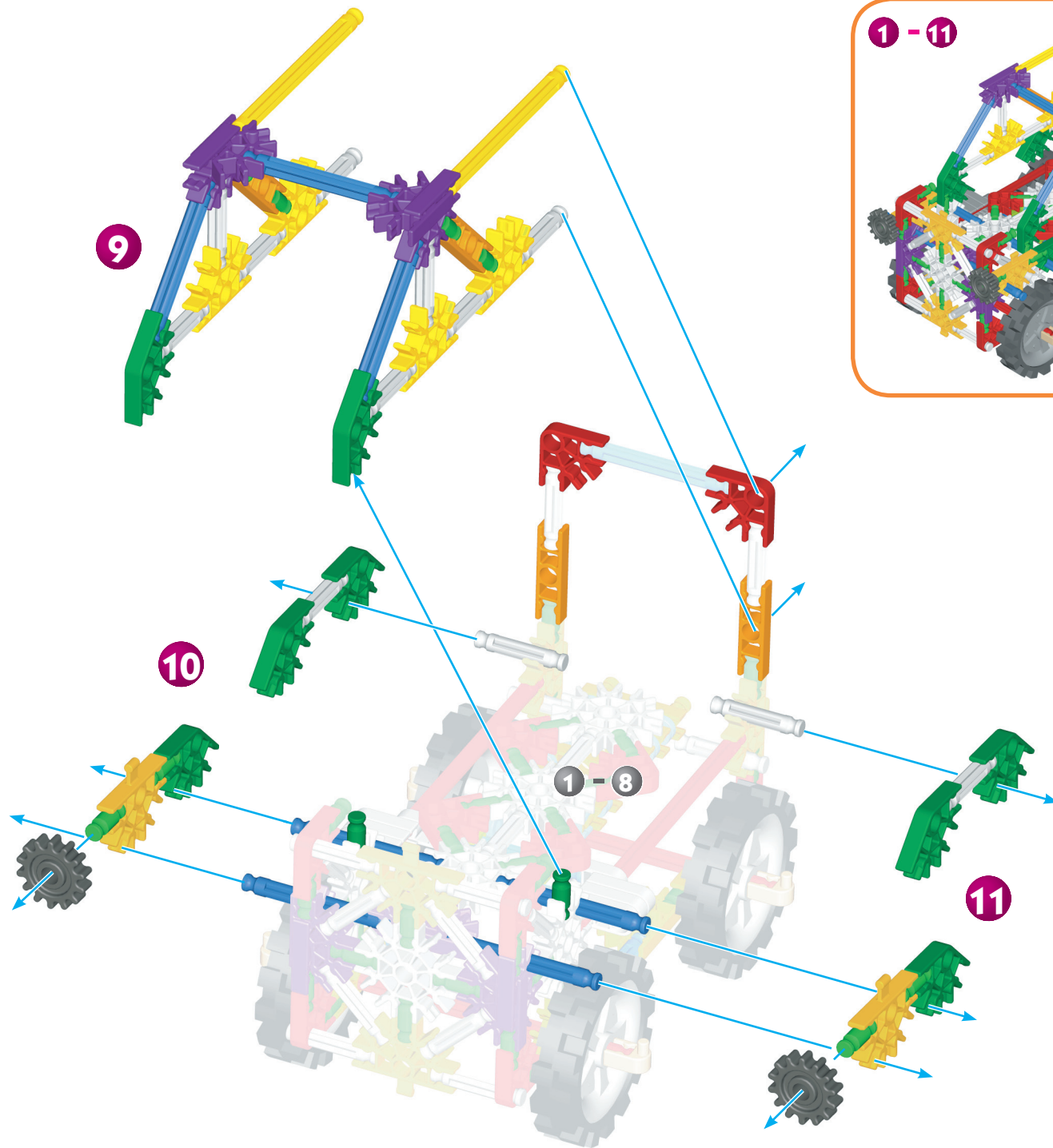

Splitting Wedge

Coin fendeur

Spaltkeil

Splittings wig

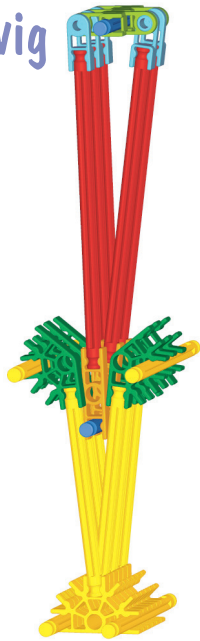

1

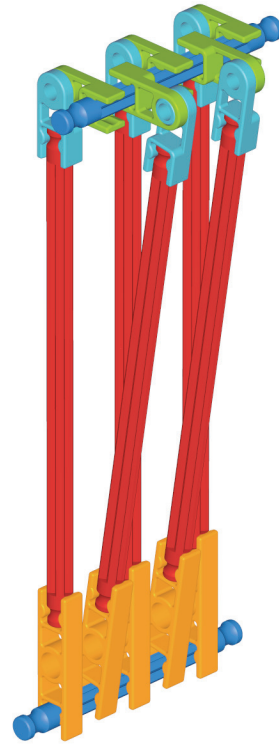

2

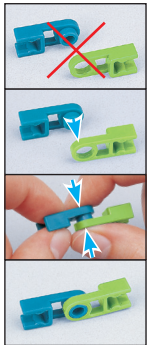
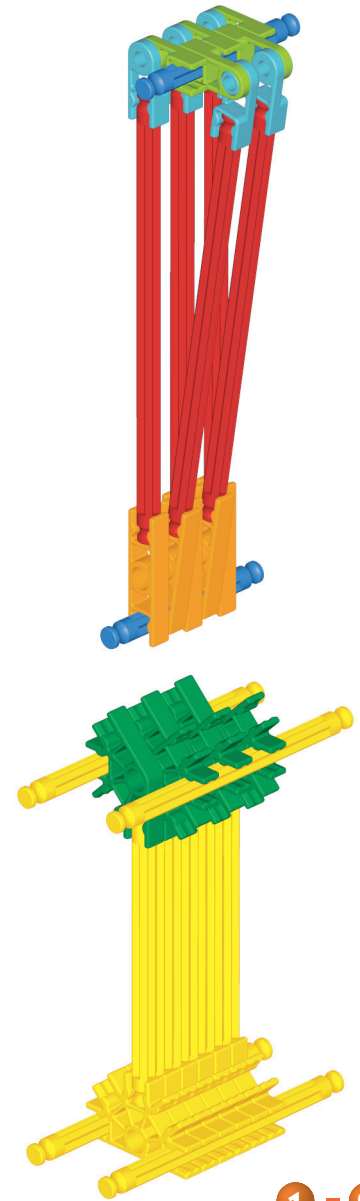
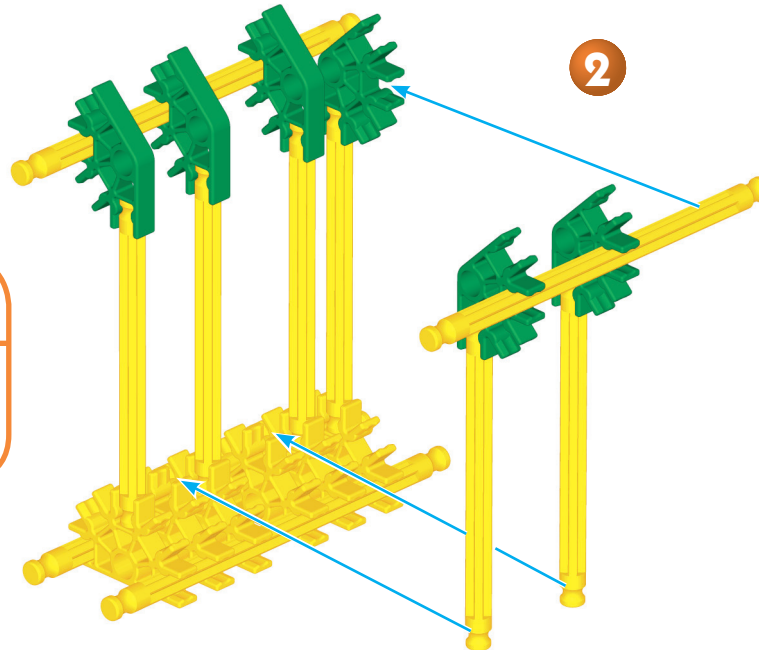

K'NEX Education

5		2		5	
6		10		5	
6		5			





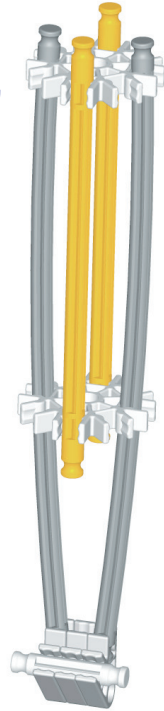

Chisel
Burin
Meißel
Beitel

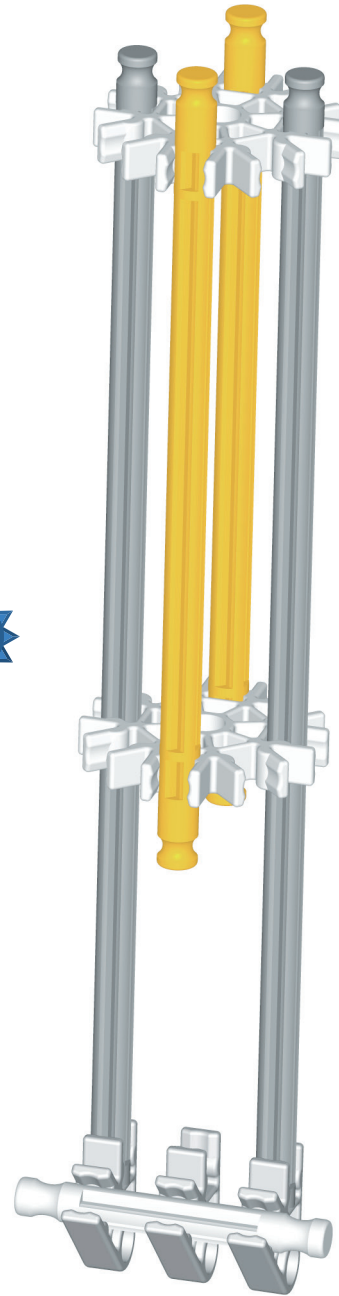

1



K'NEX Education

- | | | | |
|---|-------------------------------------------------------------------------------------|---|-------------------------------------------------------------------------------------|
| 3 |  | 1 |  |
| 2 |  | 2 |  |
| | | 2 |  |

Axe
Hacha
Axt
Ax

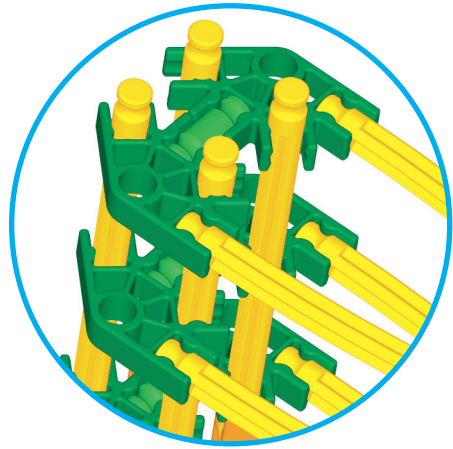
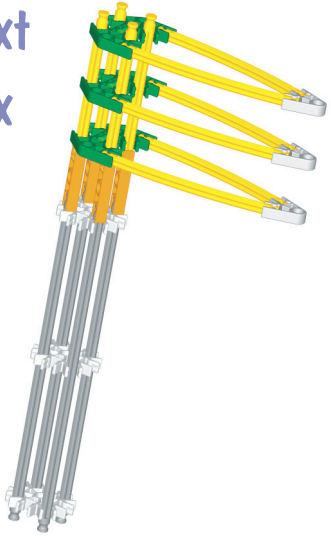

1

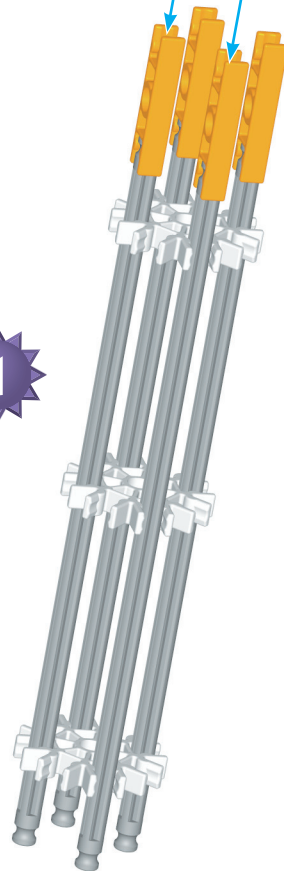

2

3

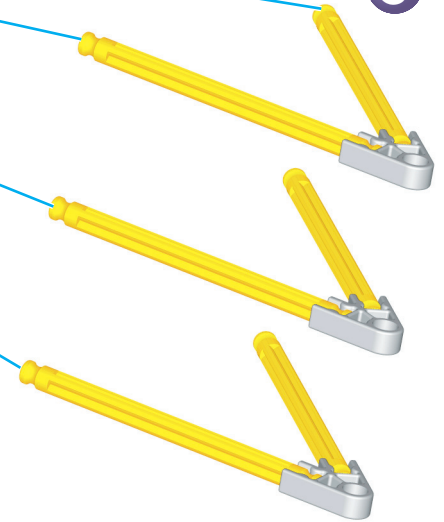

K'NEX Education

4		3	
3		10	
6		4	
3			

Hand Drill

Perceuse à main
Handbohrmaschine
Handboor

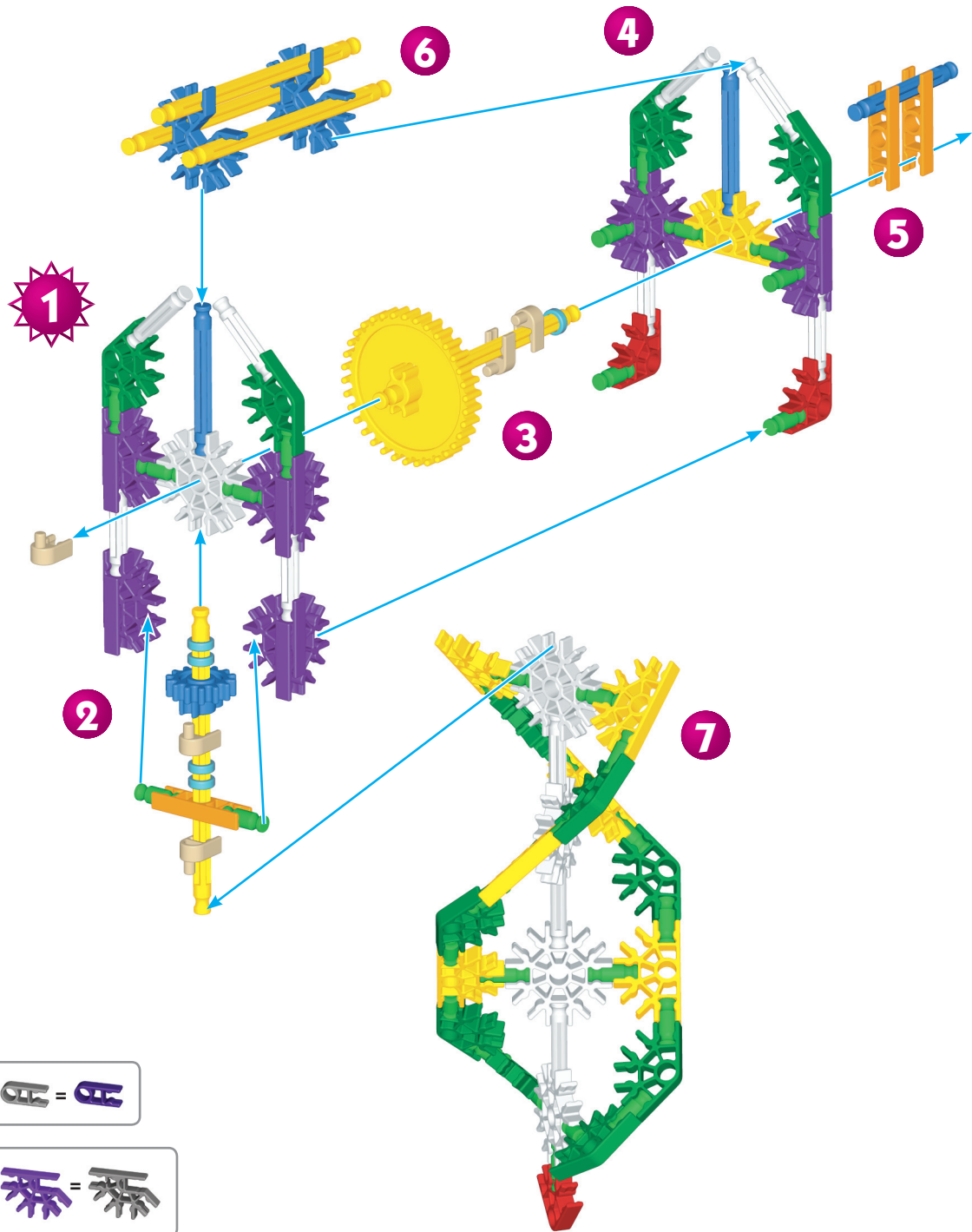

K'NEX Education

5	5	1
3	35	1
3	11	
12	3	
7	5	
12		
2		
5		

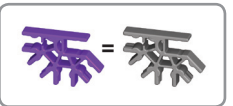

Archimedes Screw

Vis d'Archimède

Archimedische Schraube

Archimedes schroef

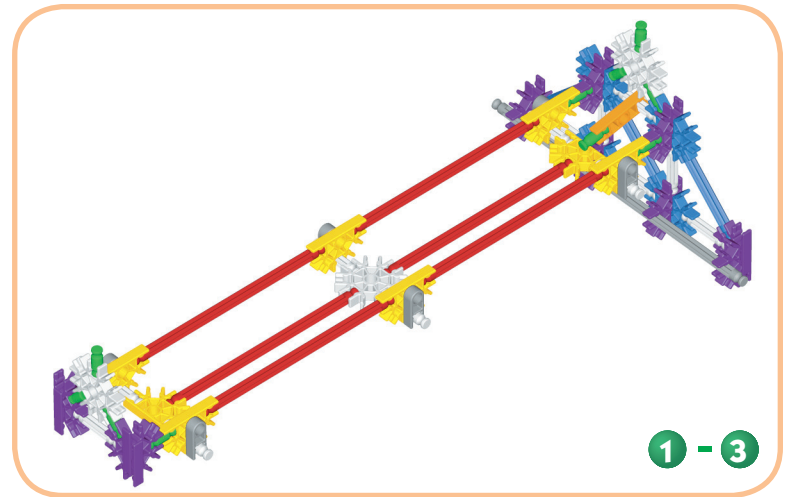
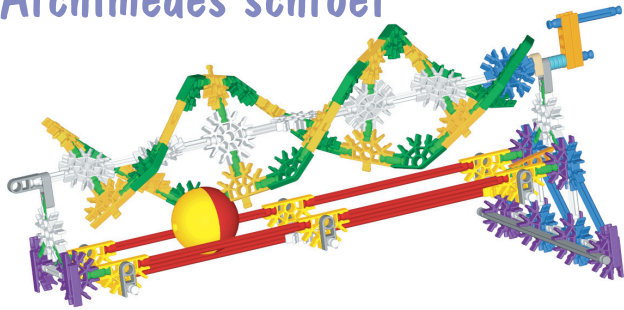

K'NEX Education

1		4		1	
9		49		1	
3		20			
14		5			
8		6			
12		1			
12					
6					
9					

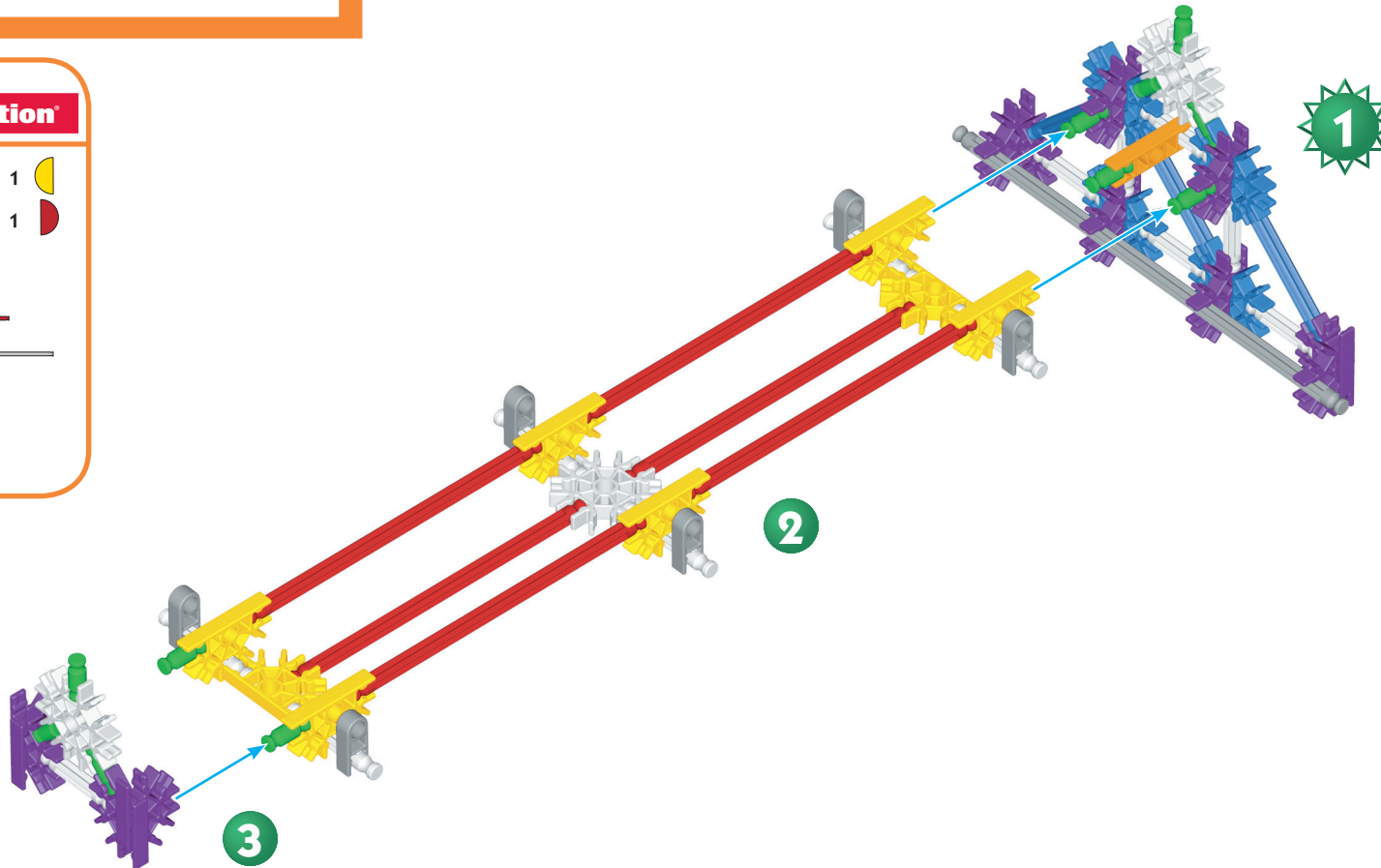

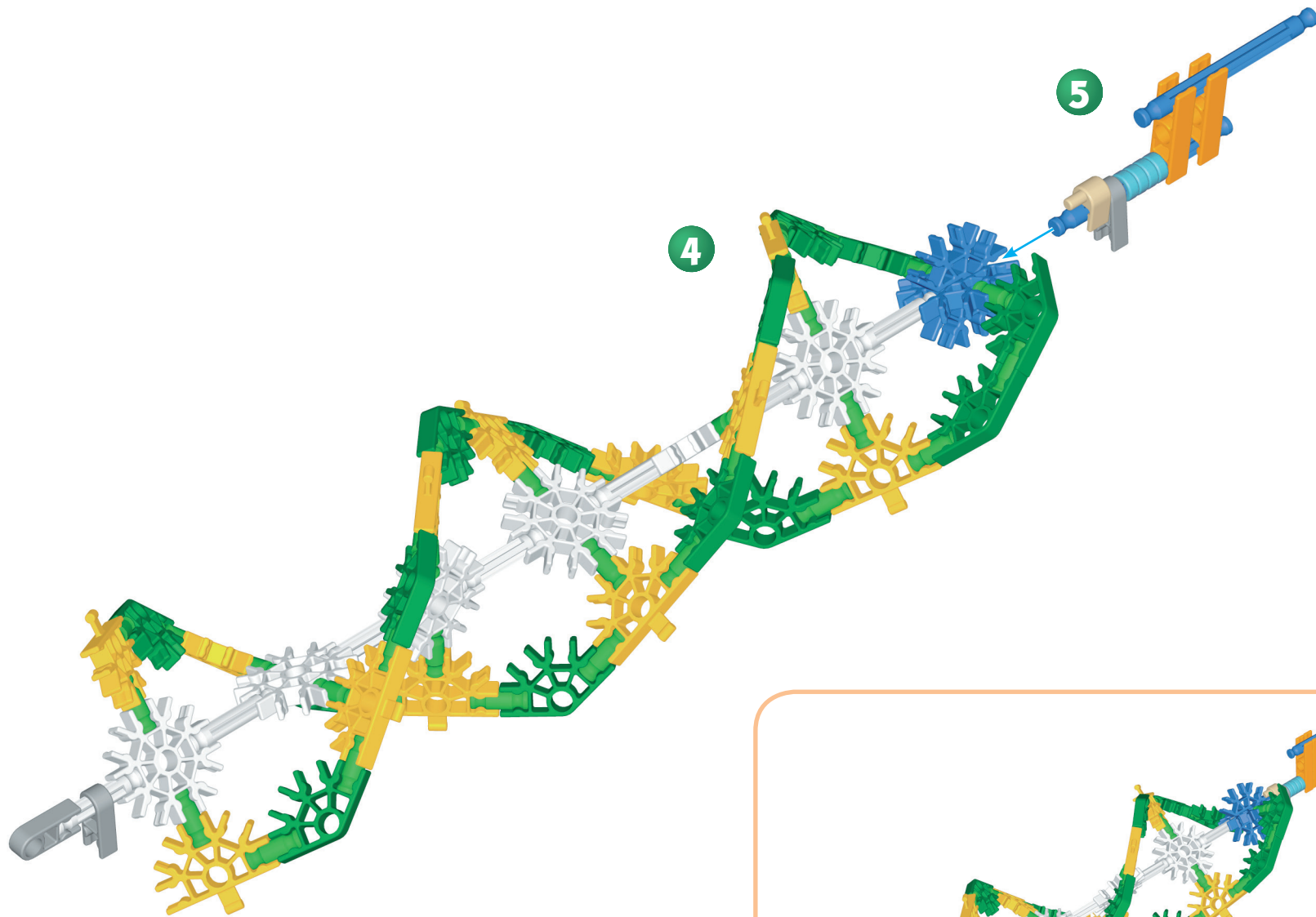

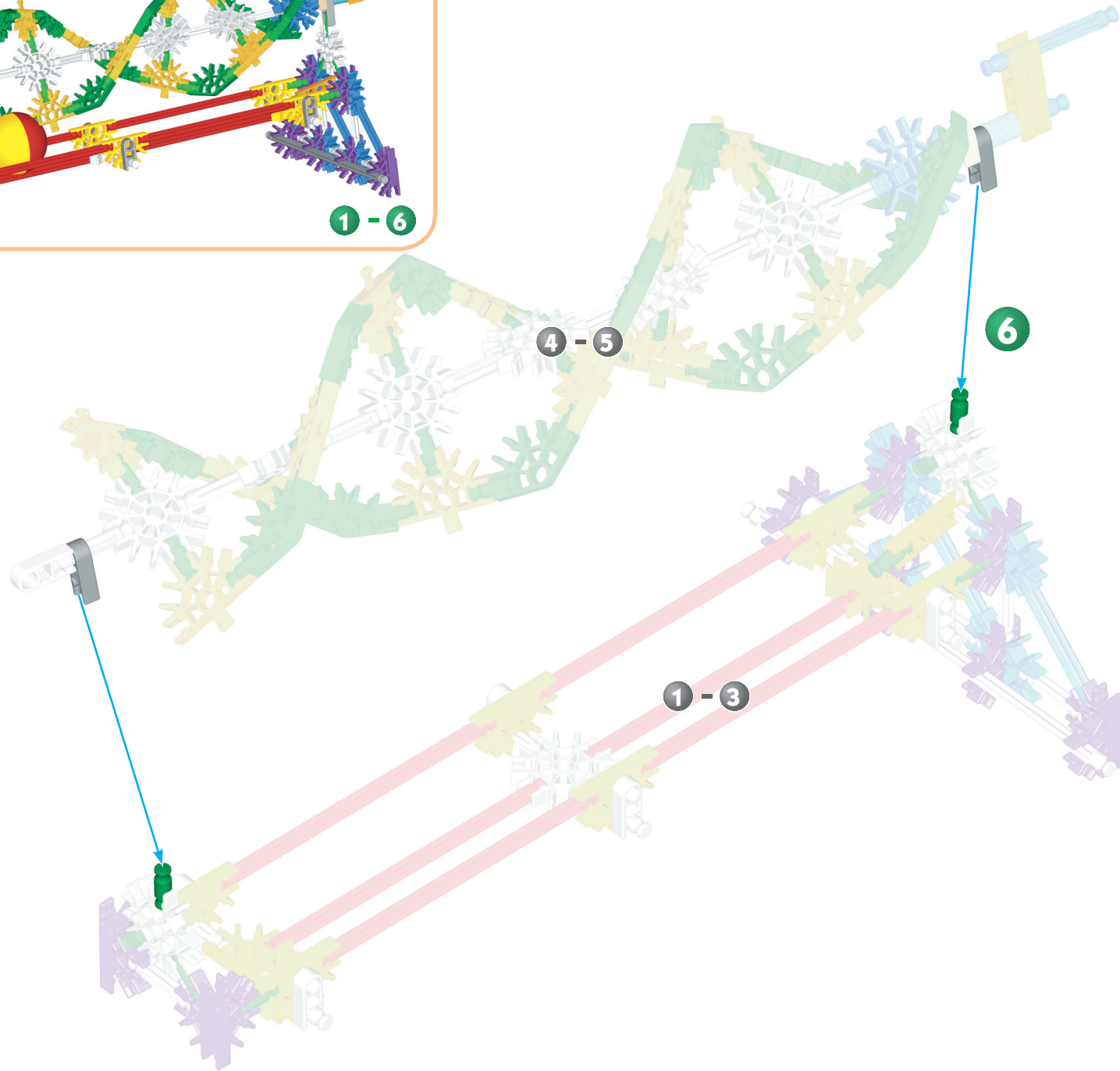
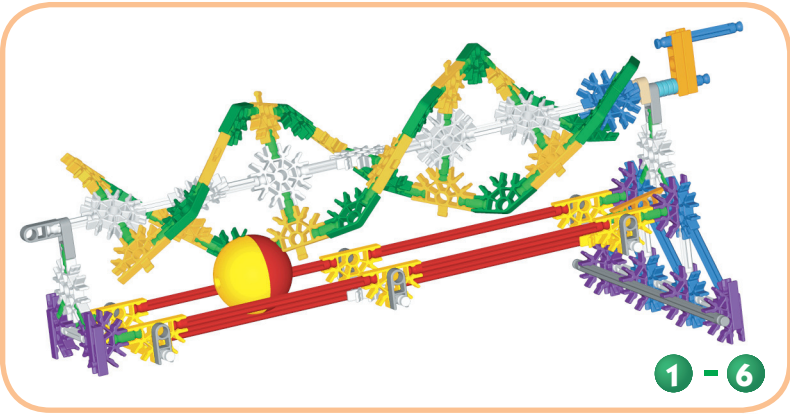

Propeller
 Hélice
 Propeller
 Propeller

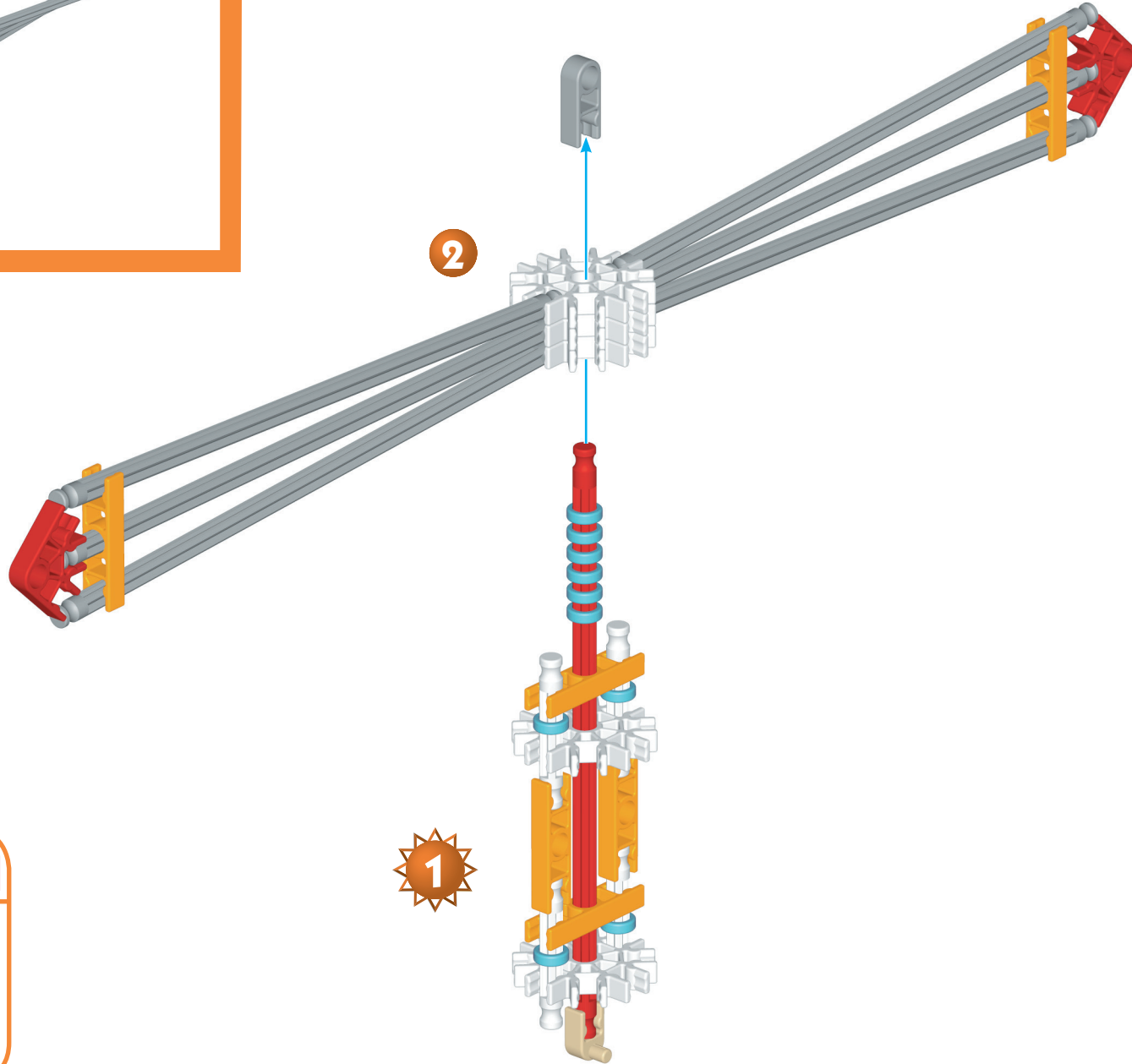
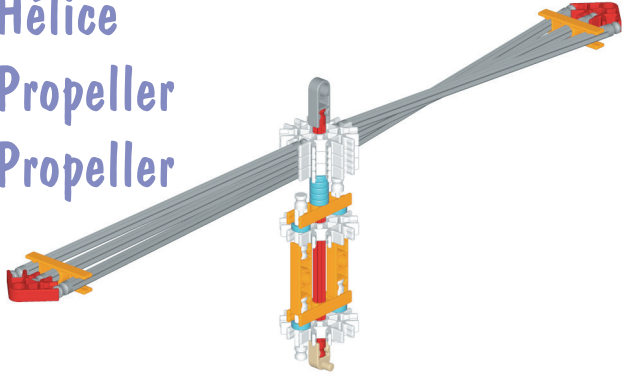

K'NEX Education

- | | | | |
|---|---|----|---|
| 1 | ⇒ | 10 | ○ |
| 1 | ⇒ | 4 | — |
| 6 | ⇒ | 1 | — |
| 2 | ⇒ | 6 | — |
| 5 | ⇒ | | ☼ |

Playground Station Spielplatz Station
 Terrain de jeu Speeltuinstation

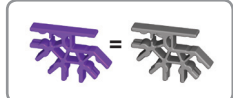
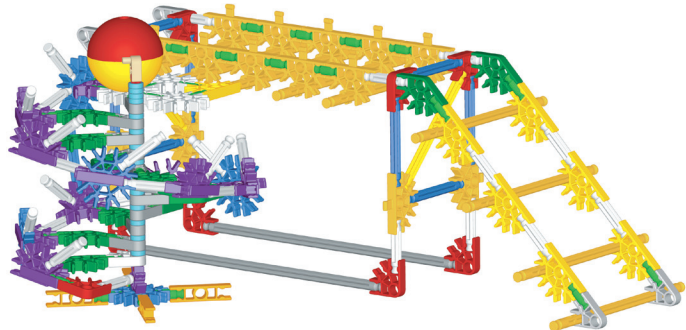

K'NEX Education

1	8	45	14
10	14	34	1
4	19	9	1
5	5	2	
9	3	1	
12		9	
		2	

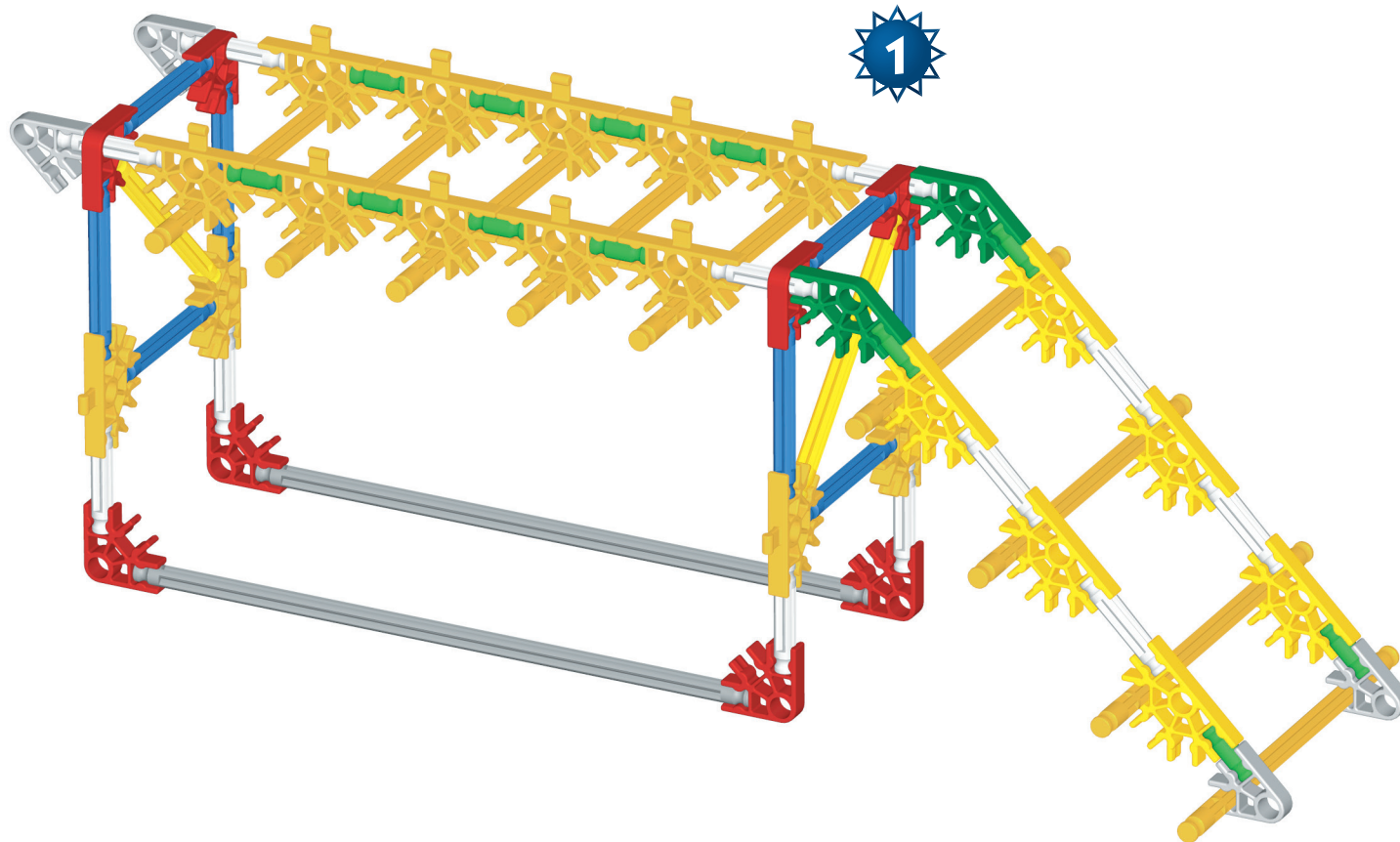

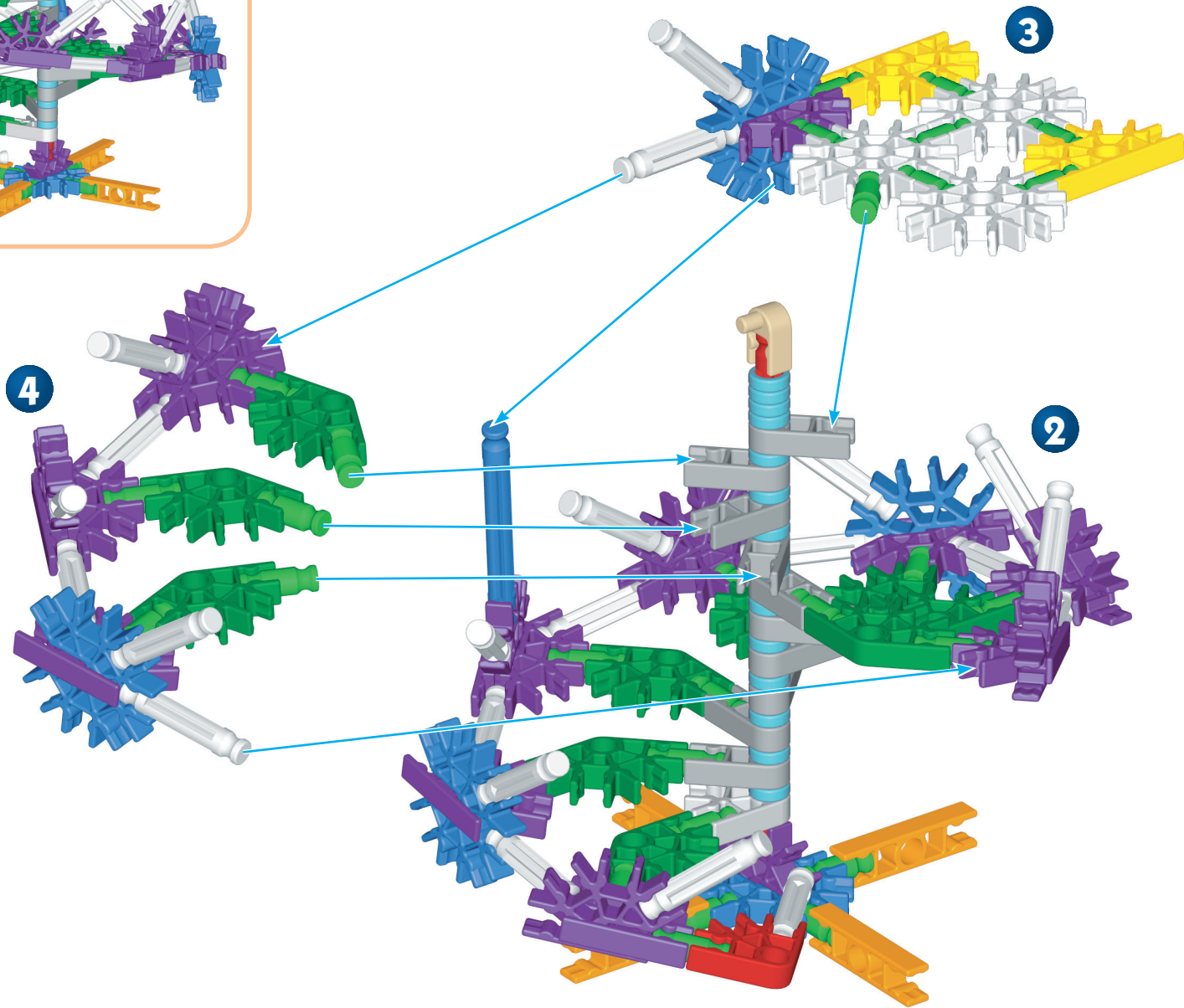
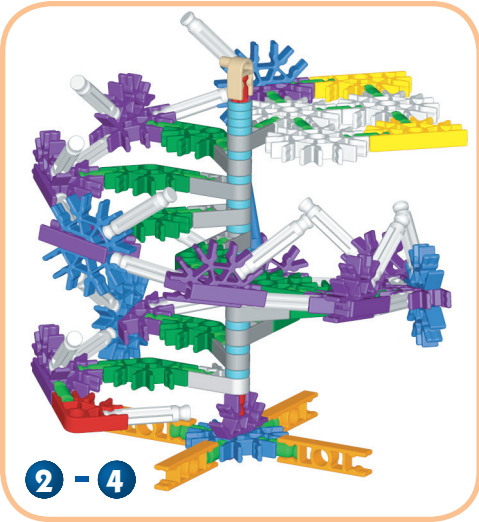

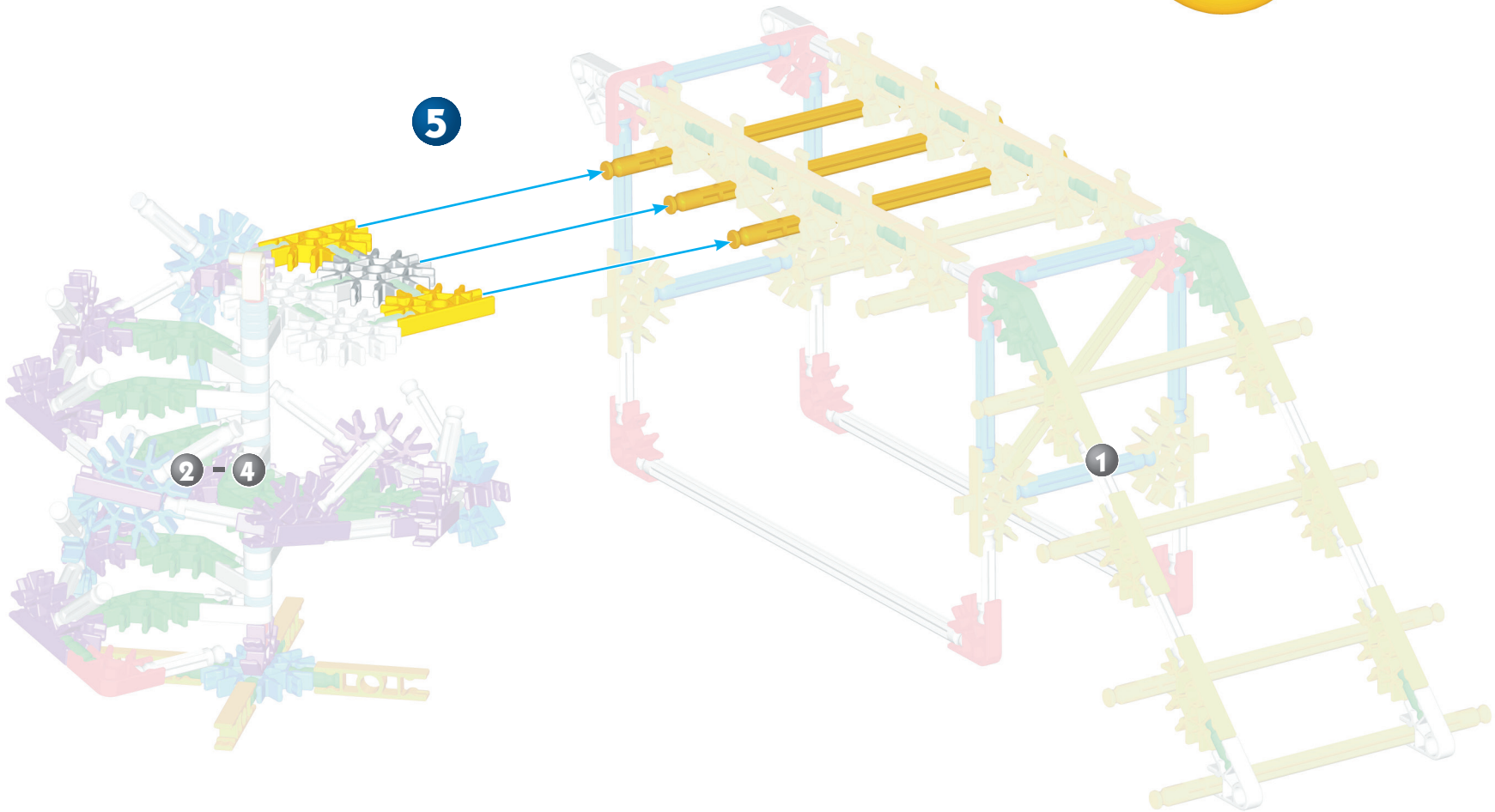
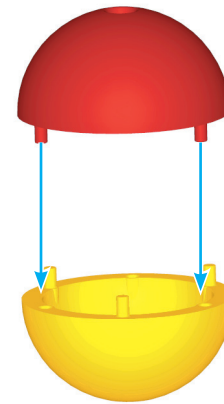
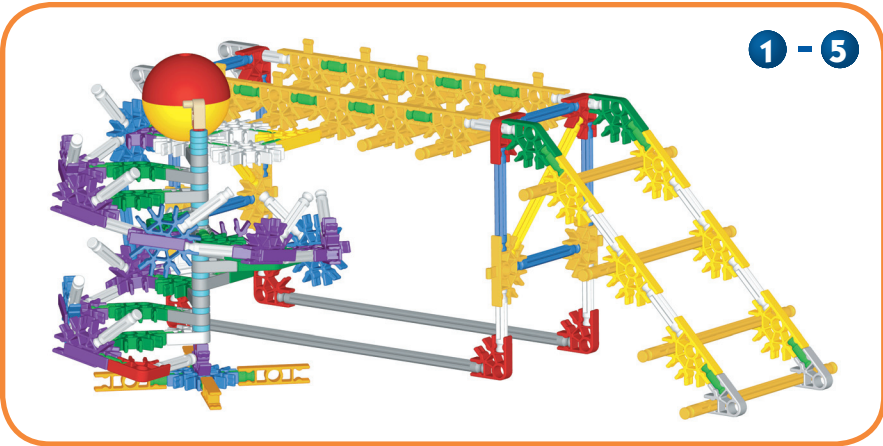

INCLINED PLANES – Parts List
AVIONS INCLINÉS – Liste de Pièces

SCHIEFE EBENEN – Stückliste
HELLENDE VLAKKEN – Onderdelenlijst

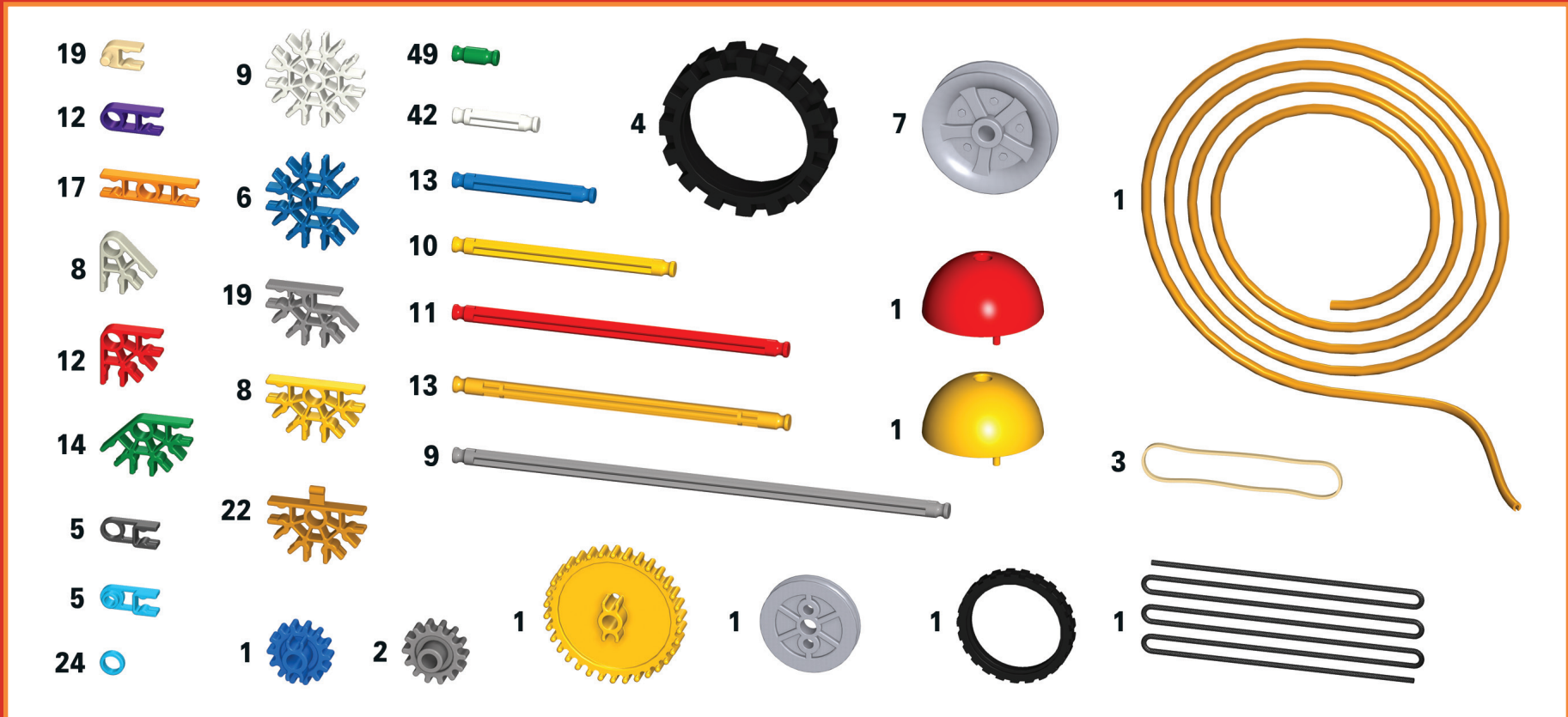

The product and colors may vary. Most models can be built one at a time. K'NEX and K'NEX Education are registered trademarks of K'NEX Limited Partnership Group.

(FR) Le produit et ses couleurs peuvent varier. Les différents modèles ne peuvent être construits qu'un par un. K'NEX et K'NEX Education sont des marques déposées de K'NEX Limited Partnership Group.

(DE) Produkte und Farben können abweichen. Die meisten Modelle können immer nur einzeln gebaut werden. K'NEX und K'NEX Education sind eingetragene Marken von K'NEX Limited Partnership Group.

(NL) Product en kleuren kunnen variëren. De meeste modellen kunnen uitsluitend een voor een worden gebouwd. K'NEX en K'NEX Education zijn gedeponeerde handelsmerken van K'NEX Commanditaire vennootschap Groep.

*Untersuche schiefe Ebenen!
 Onderzoeken hellende vlakken!

‡Modelle!
 Modellen!