

FREEFALL COASTER™

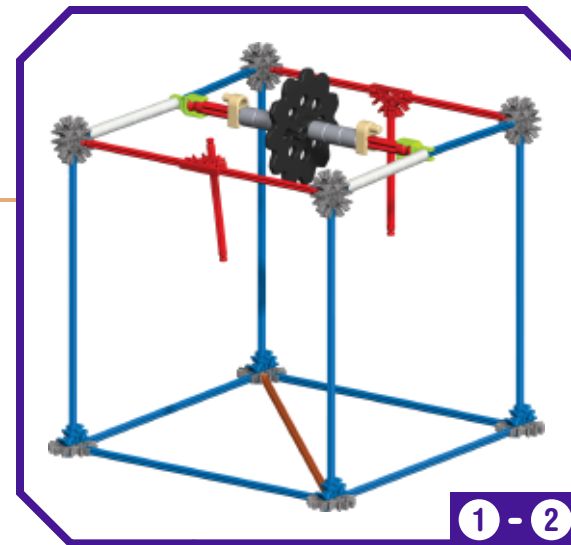

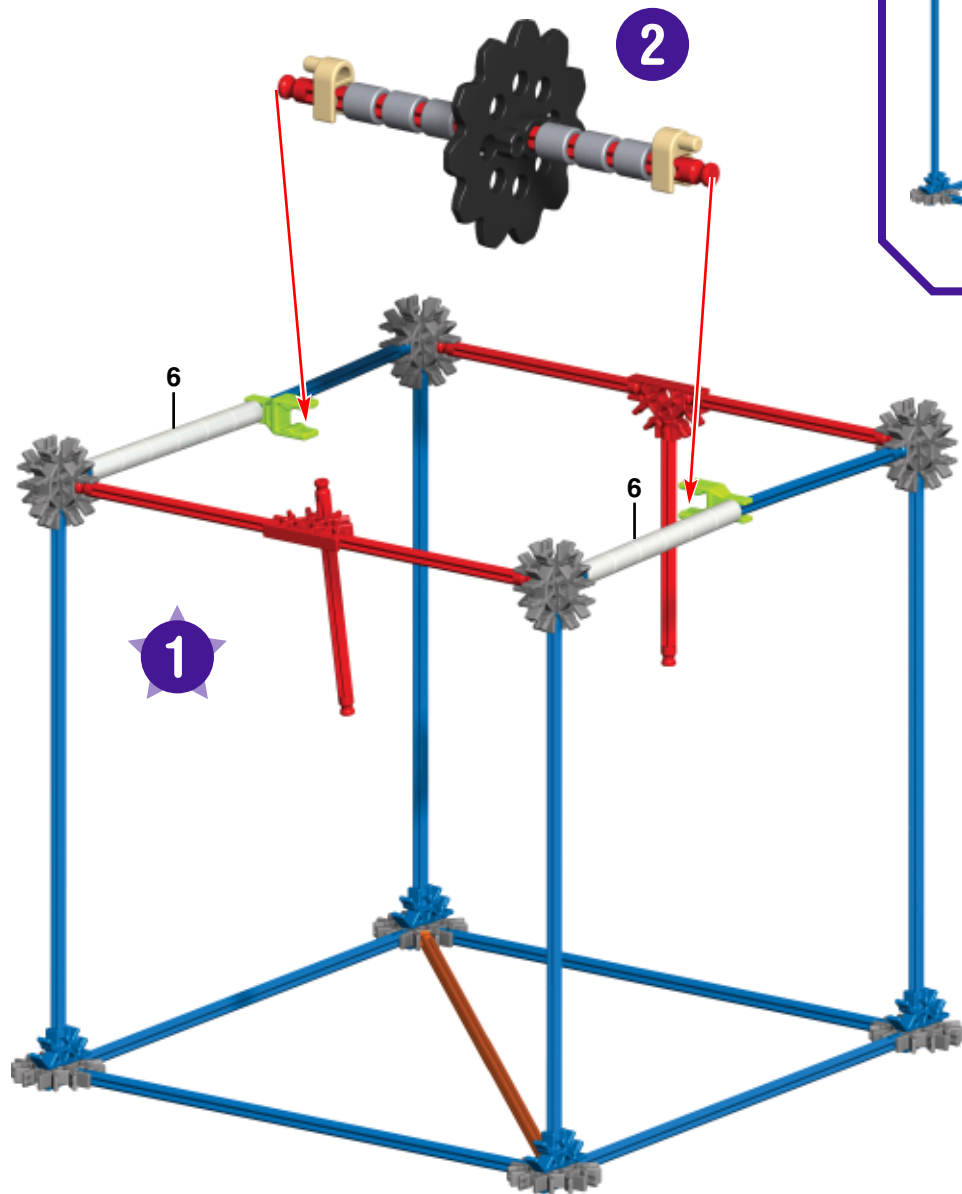

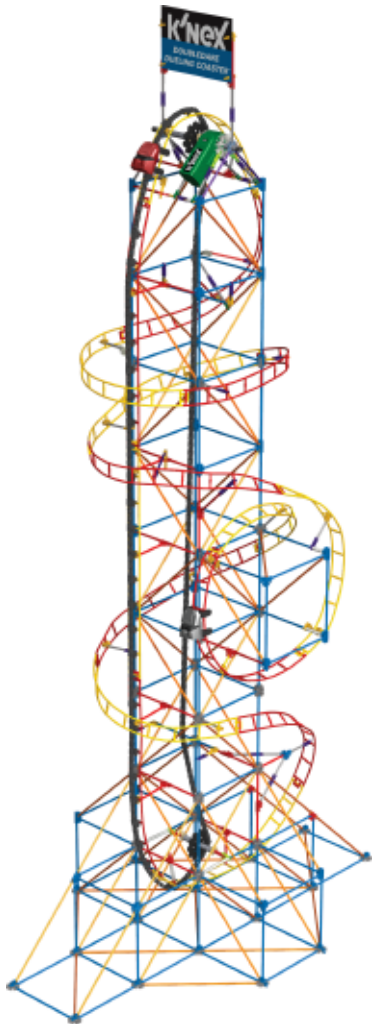

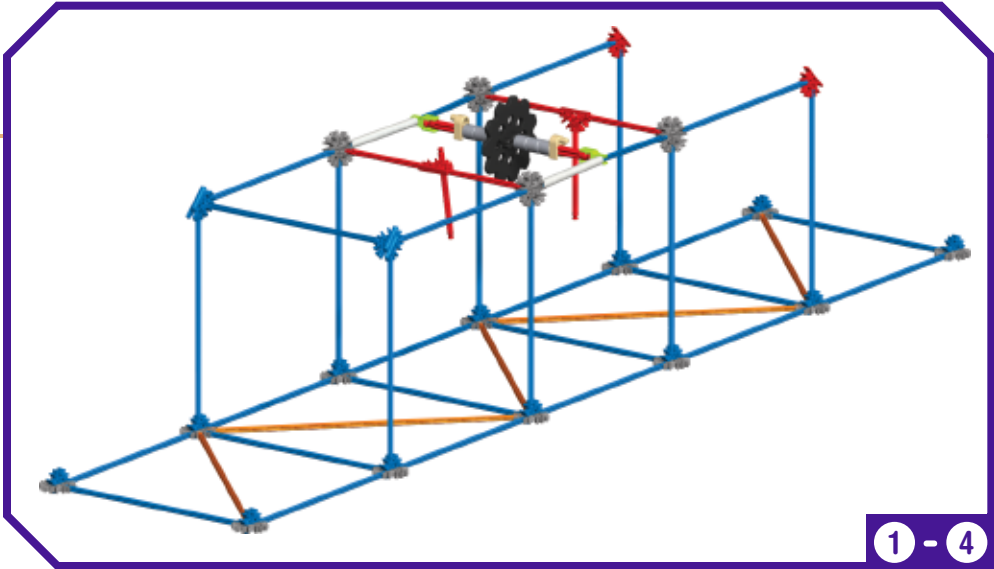
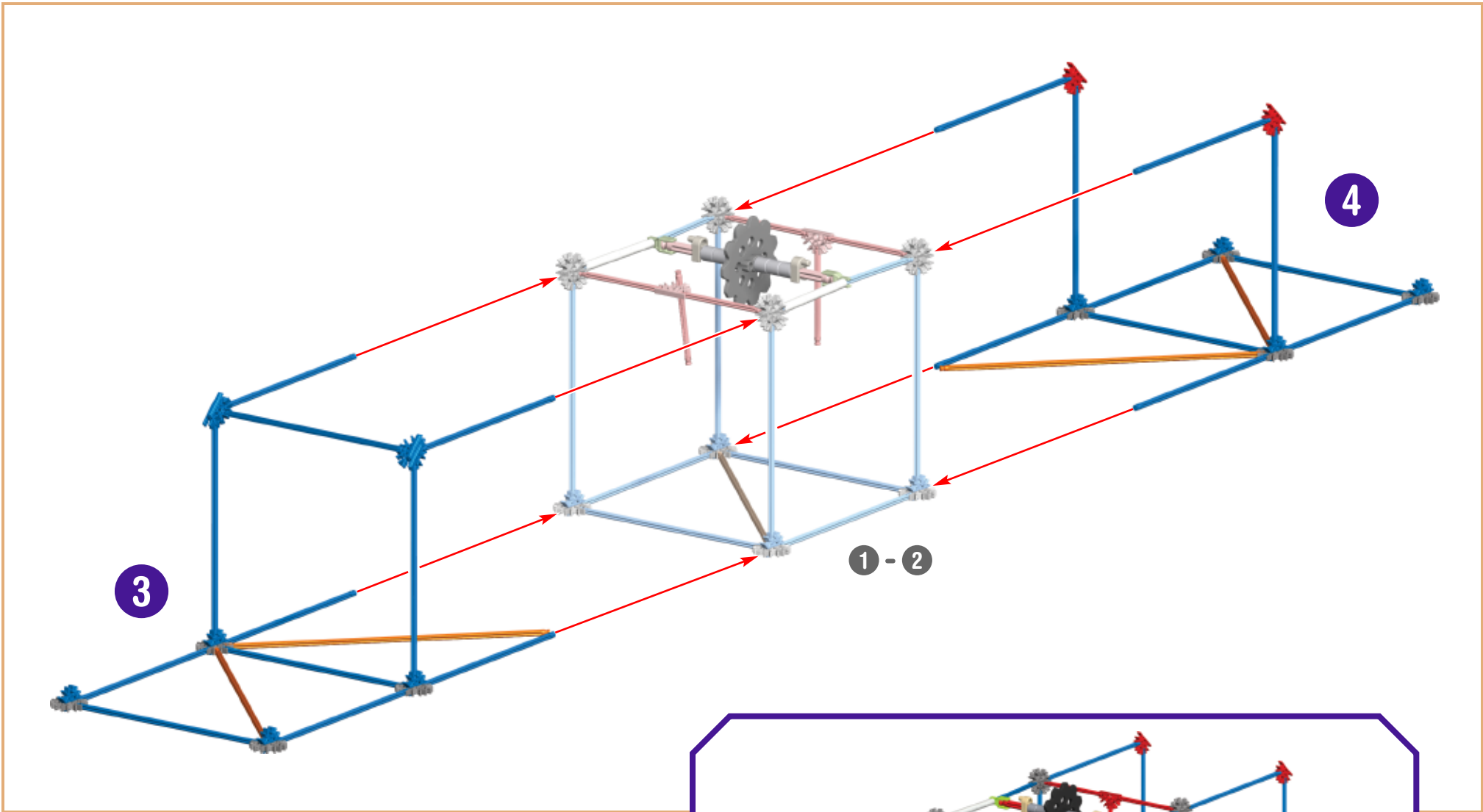
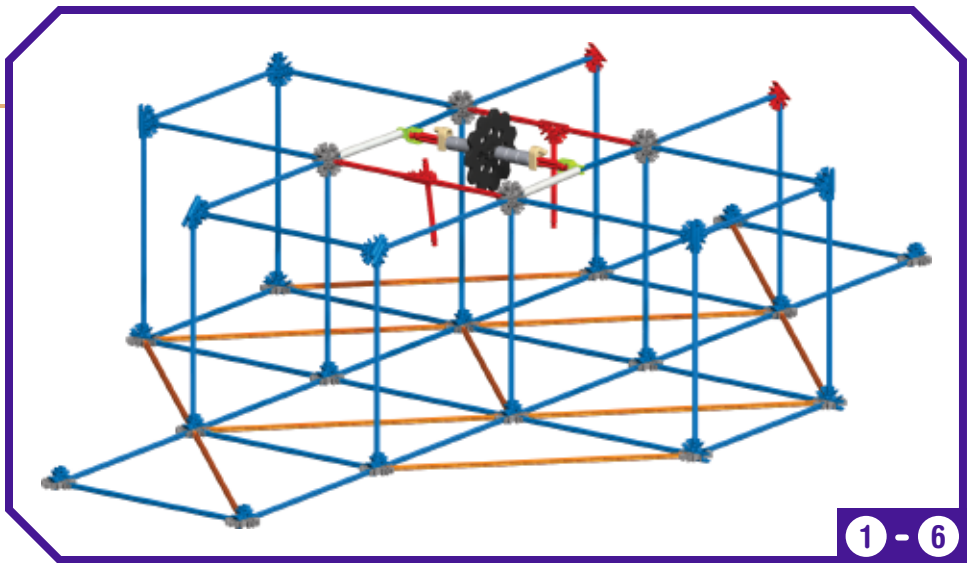
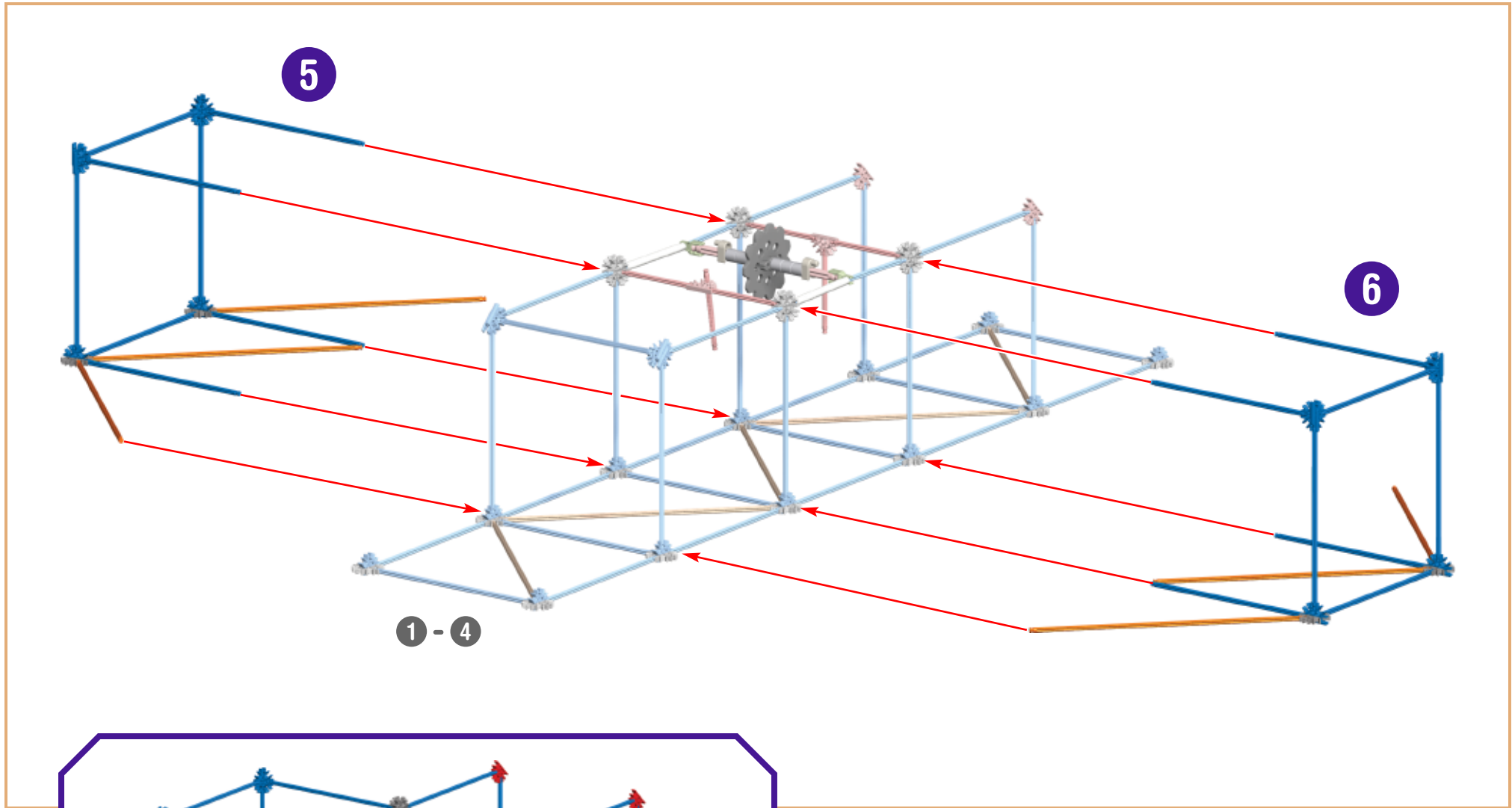
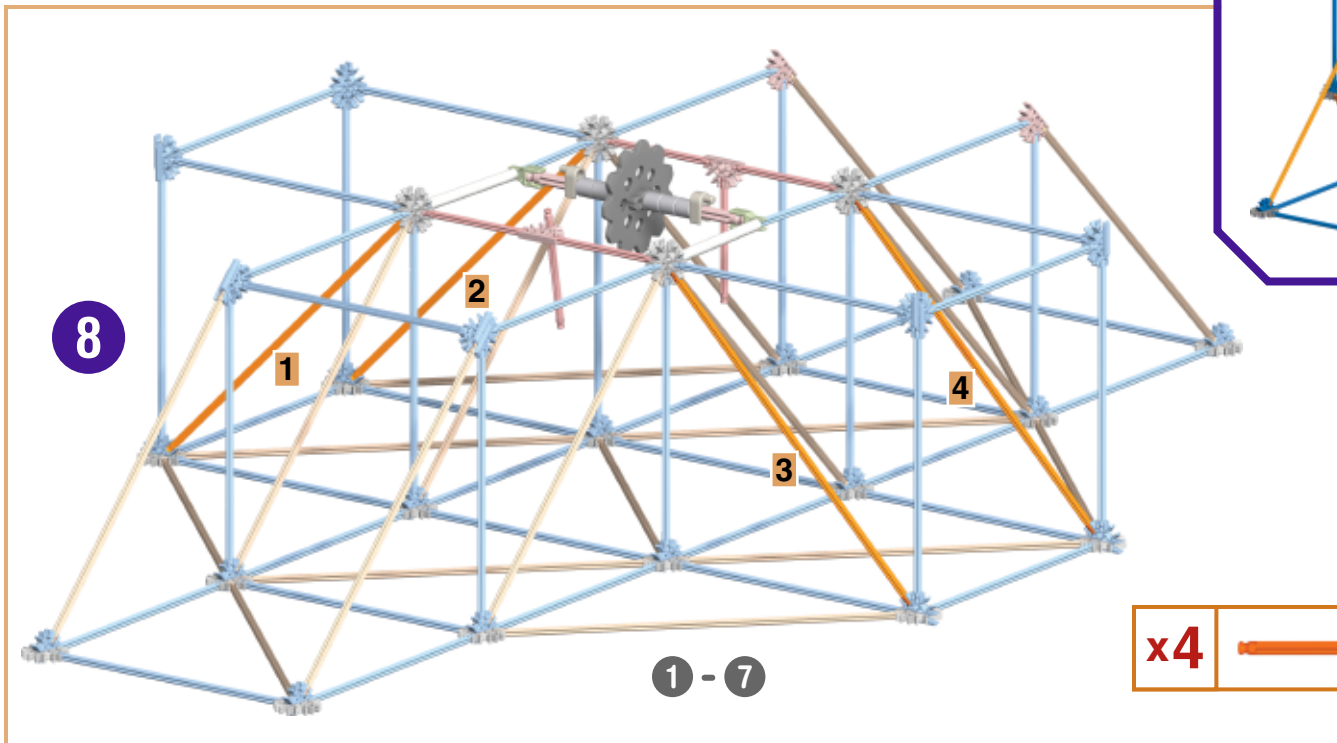
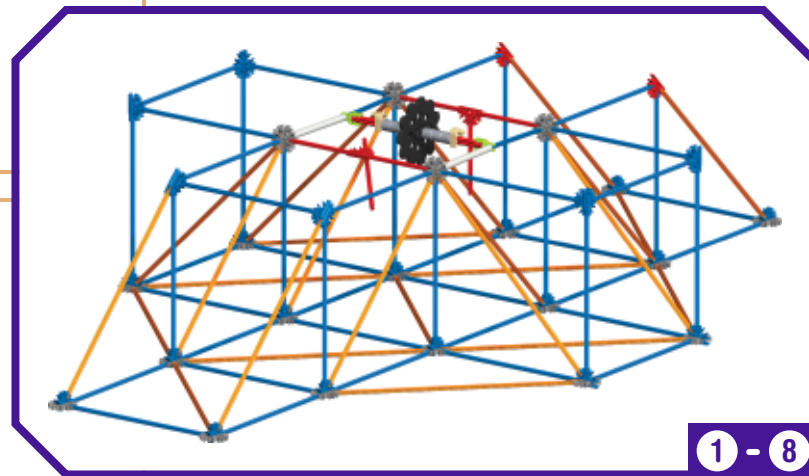
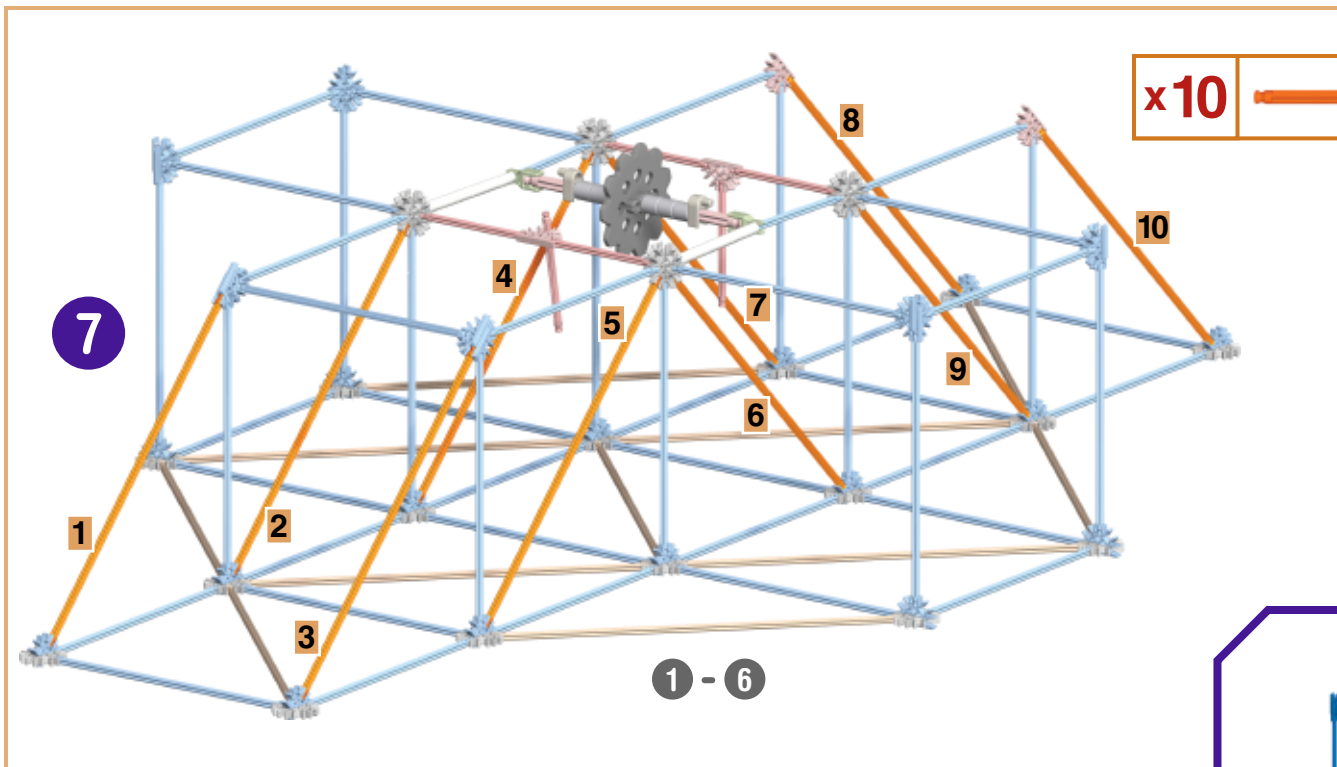

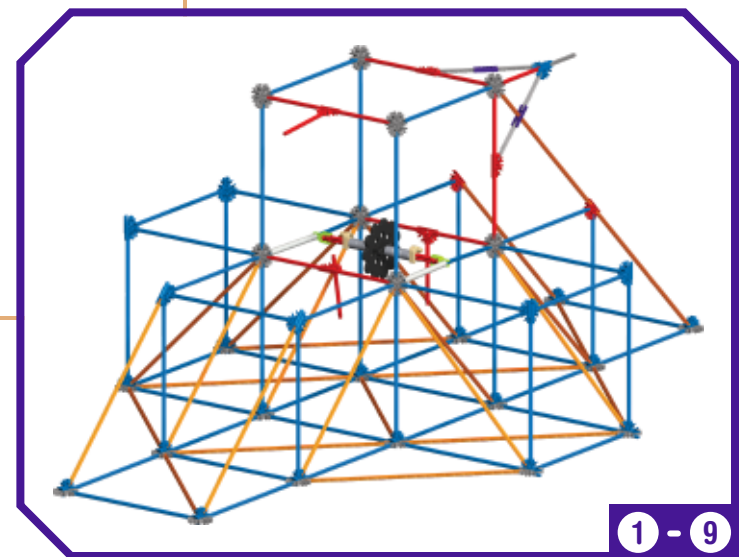
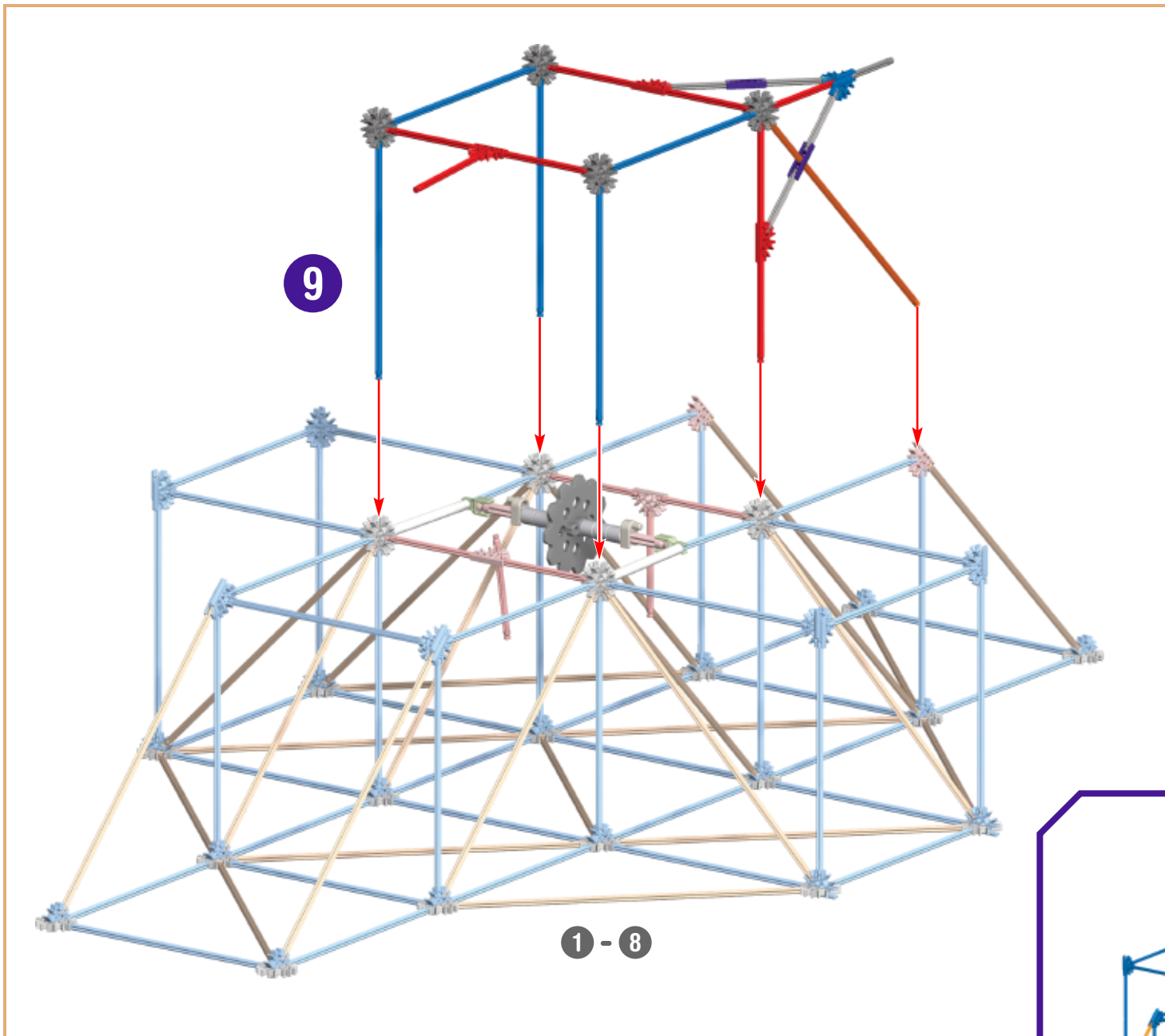

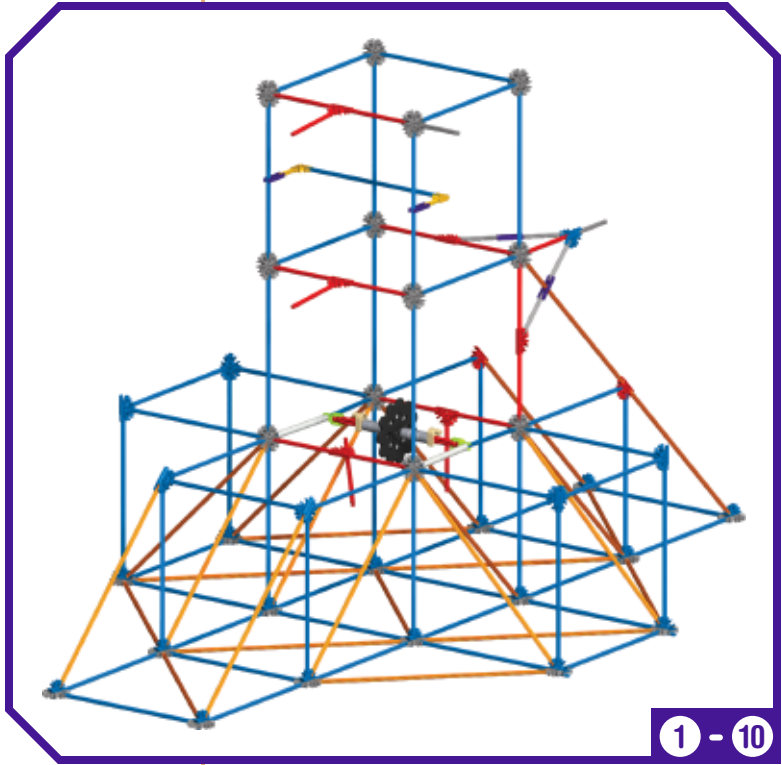
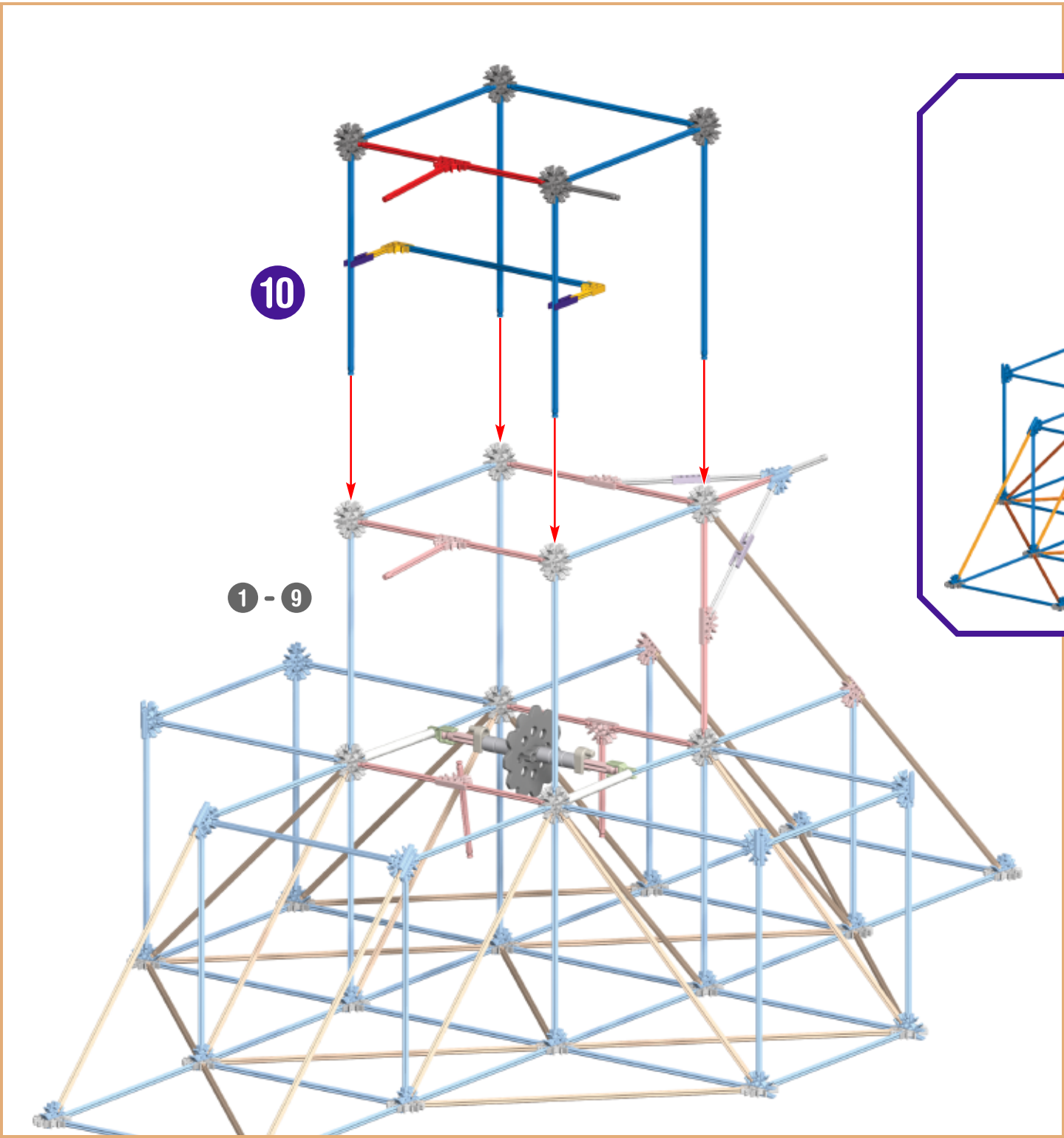

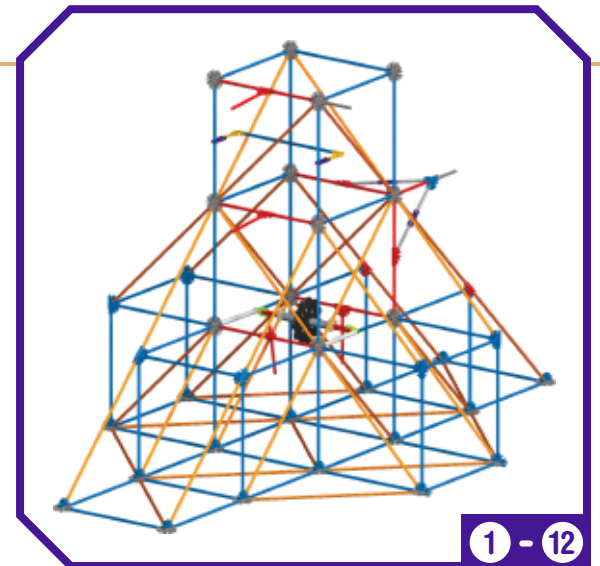
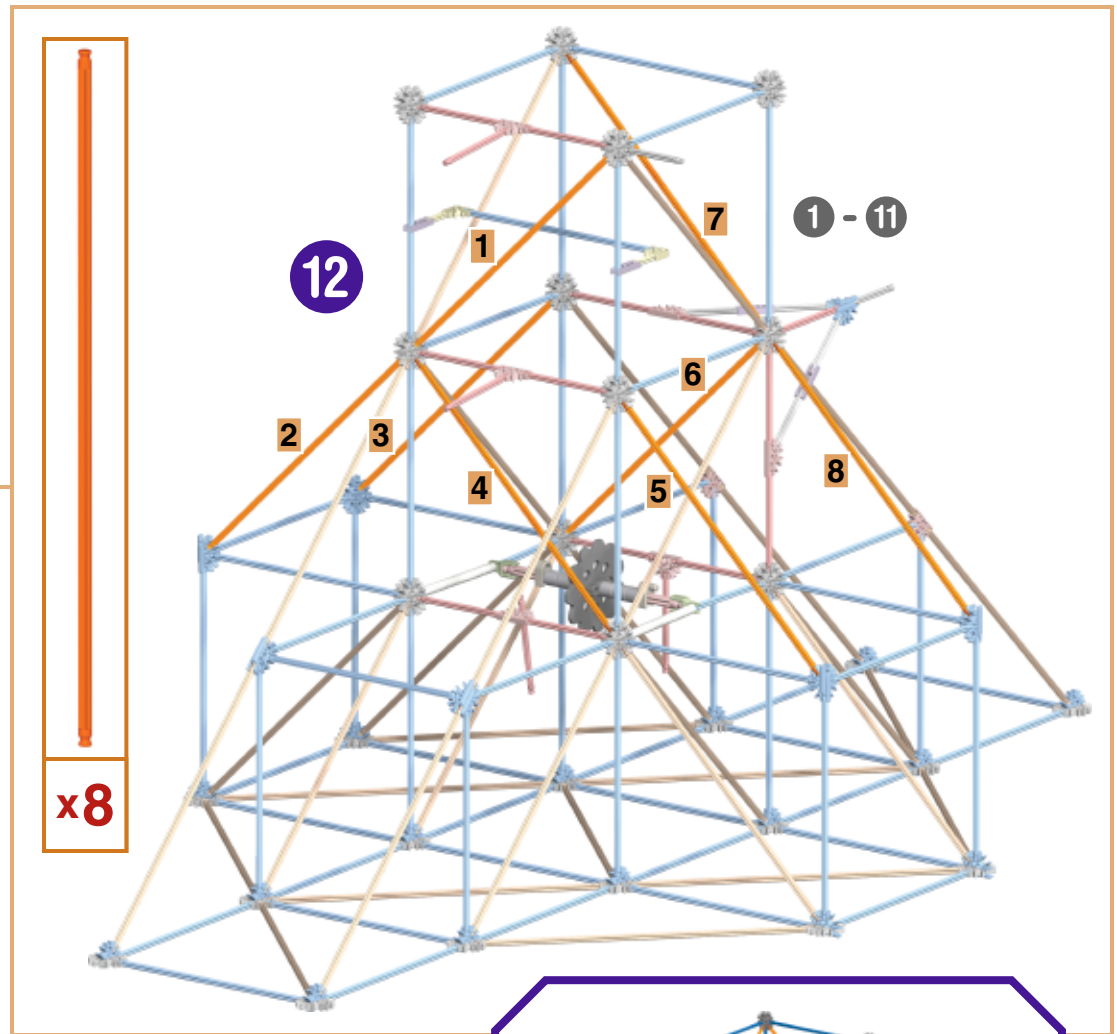
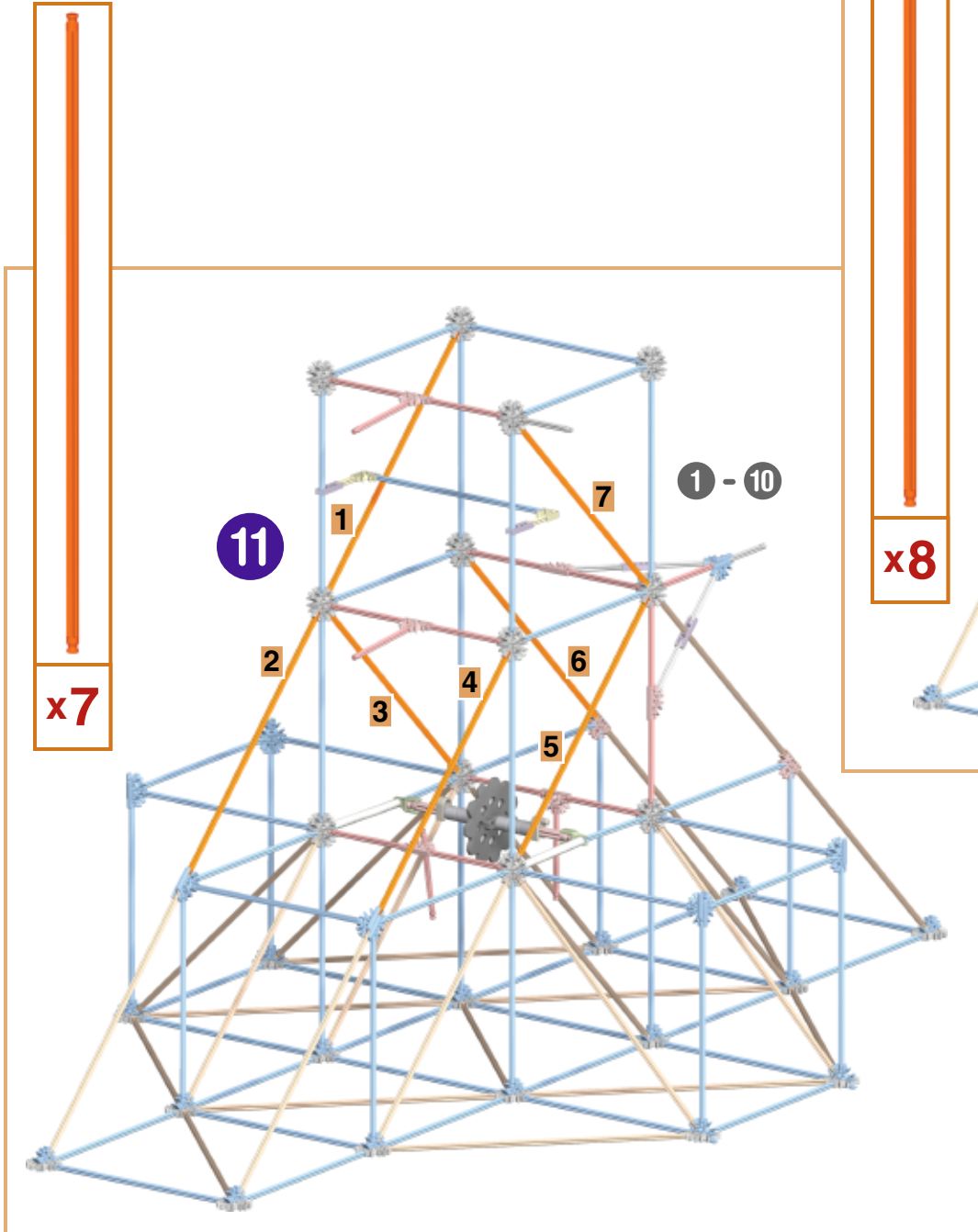



13

1 - 12

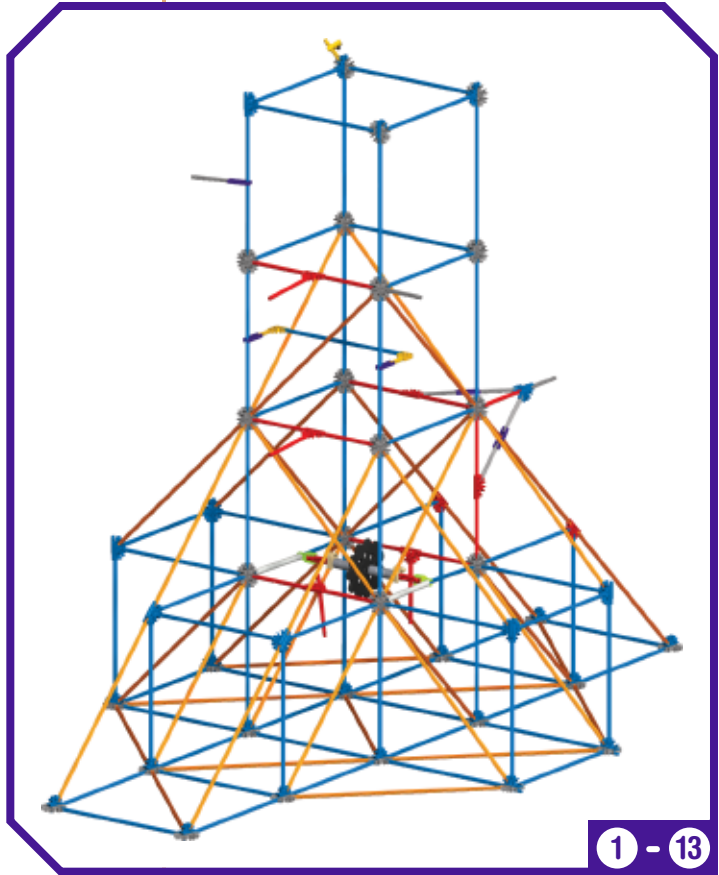

1 - 13

14

1 - 13

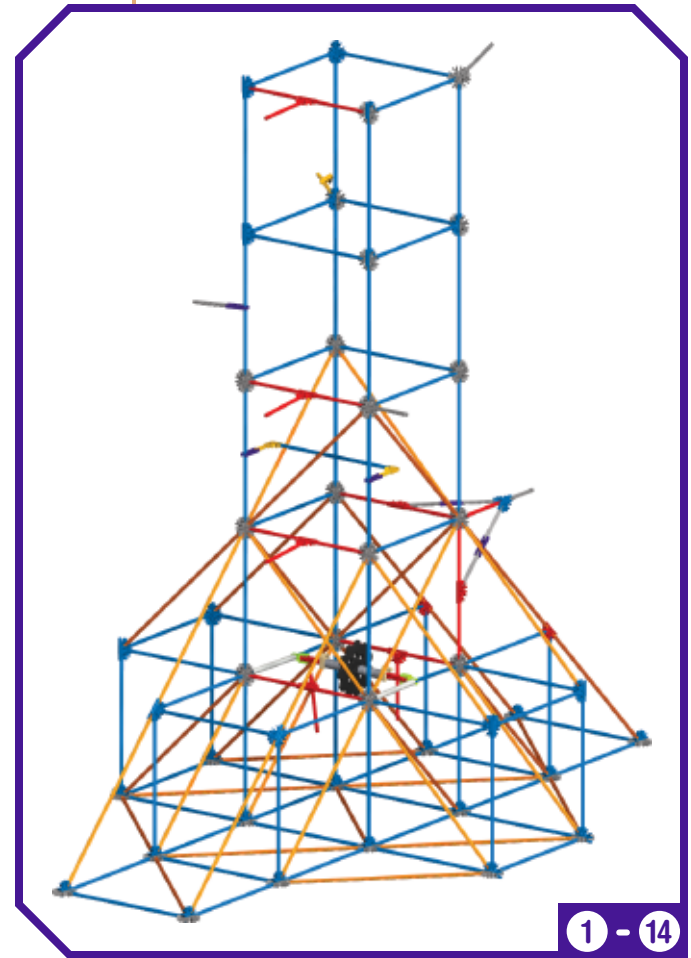
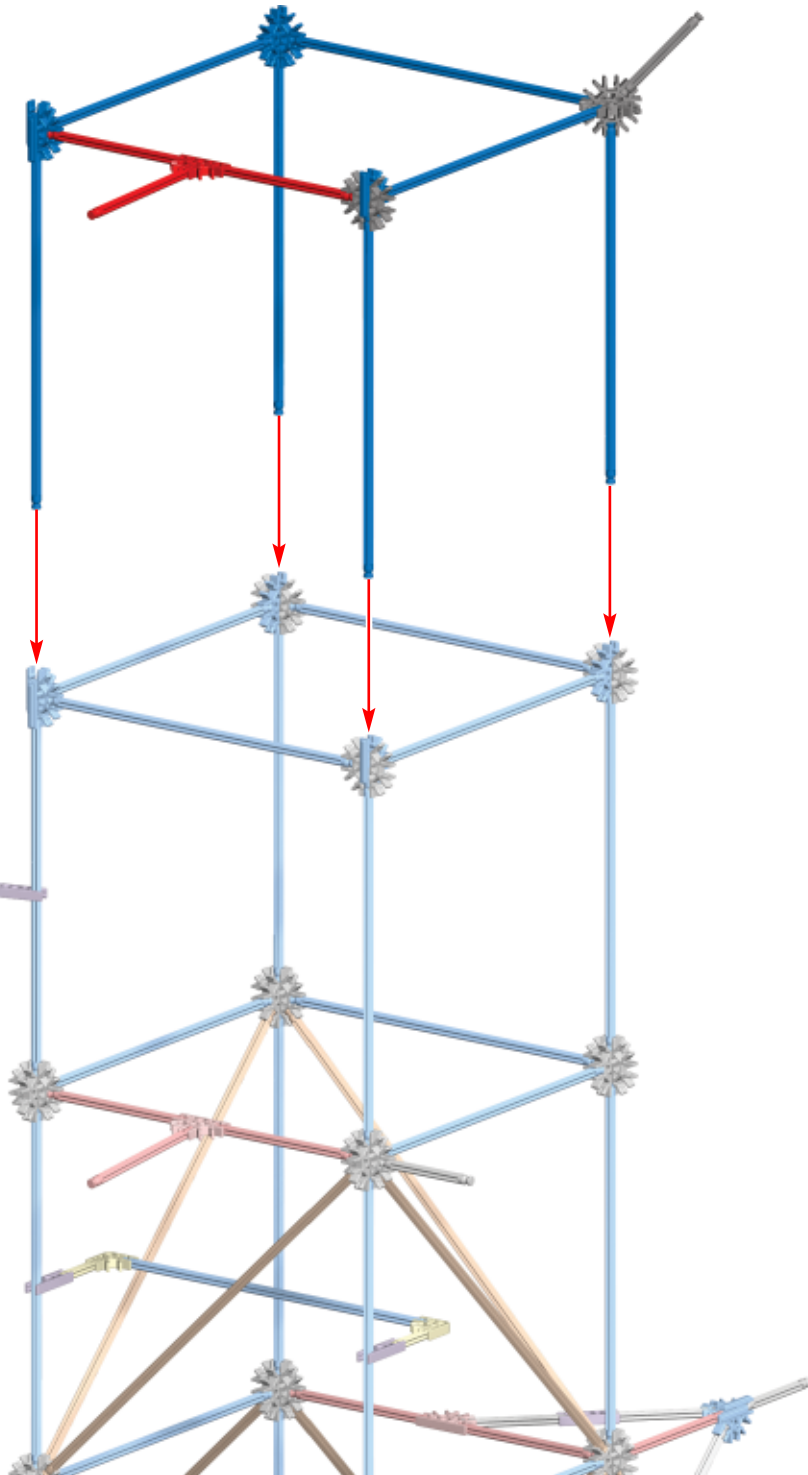

1 - 14

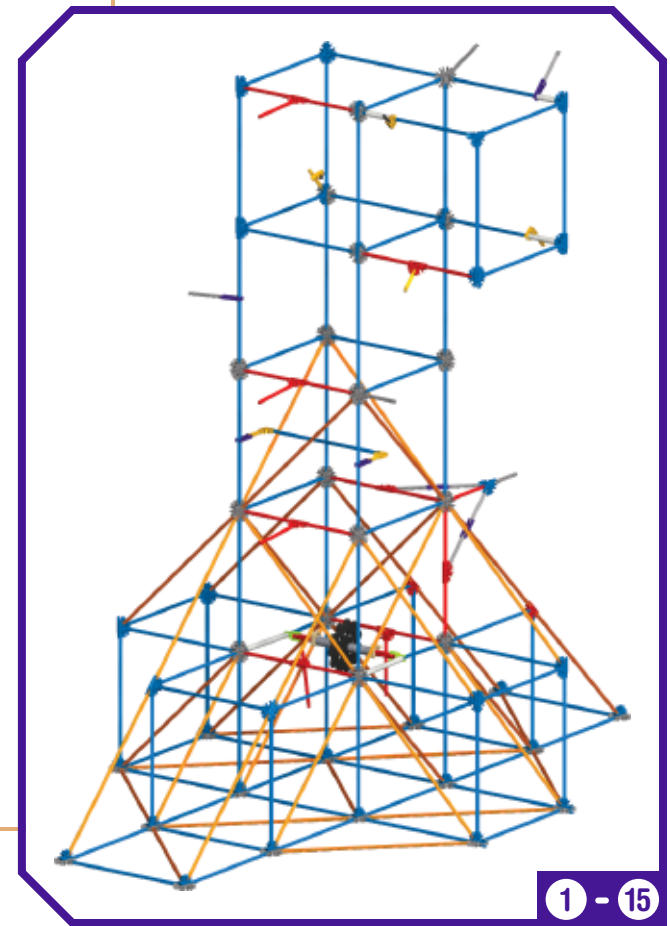
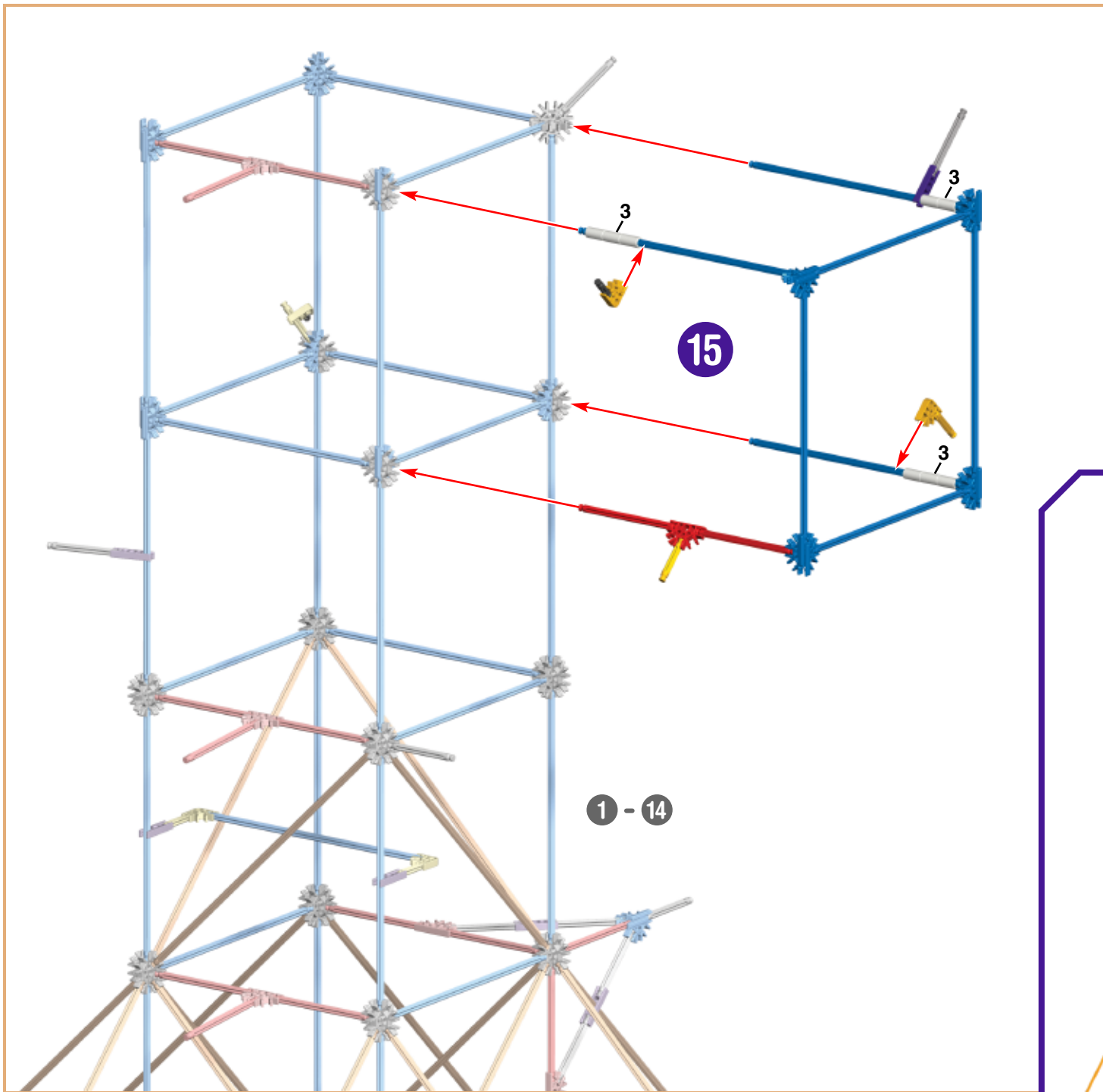

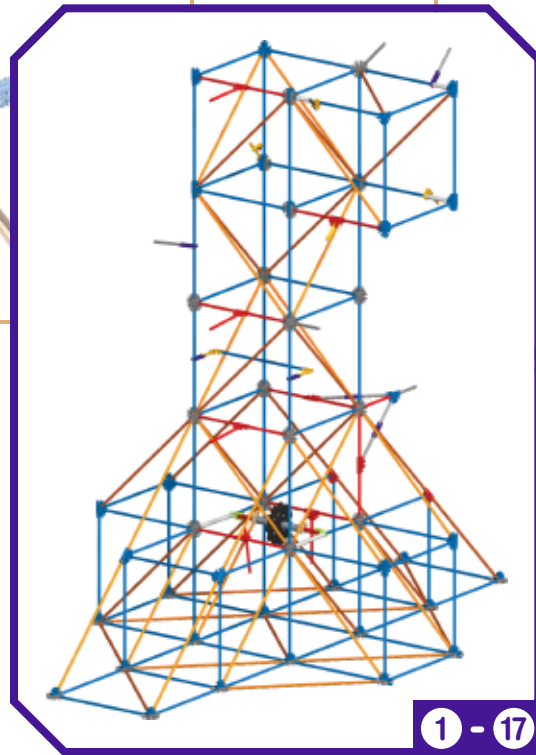
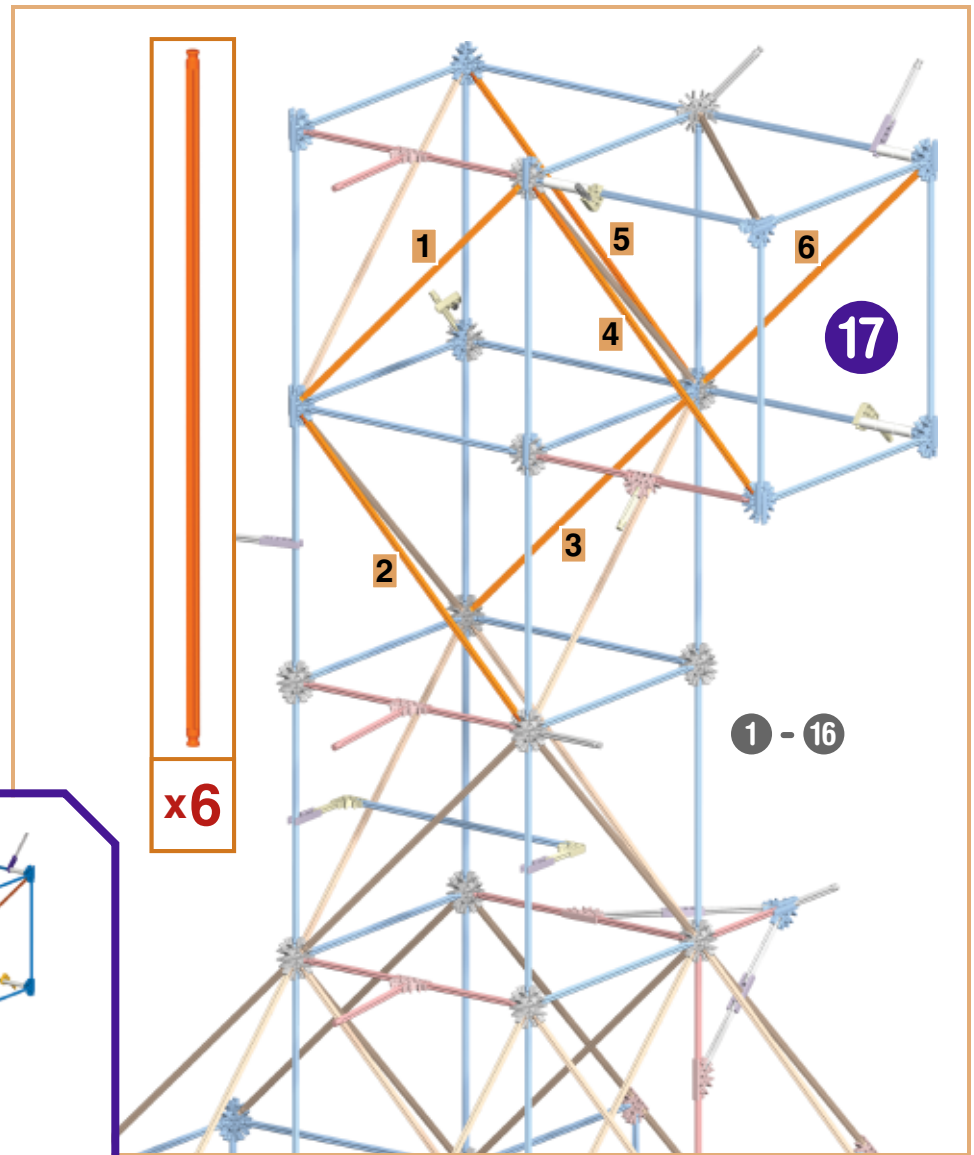
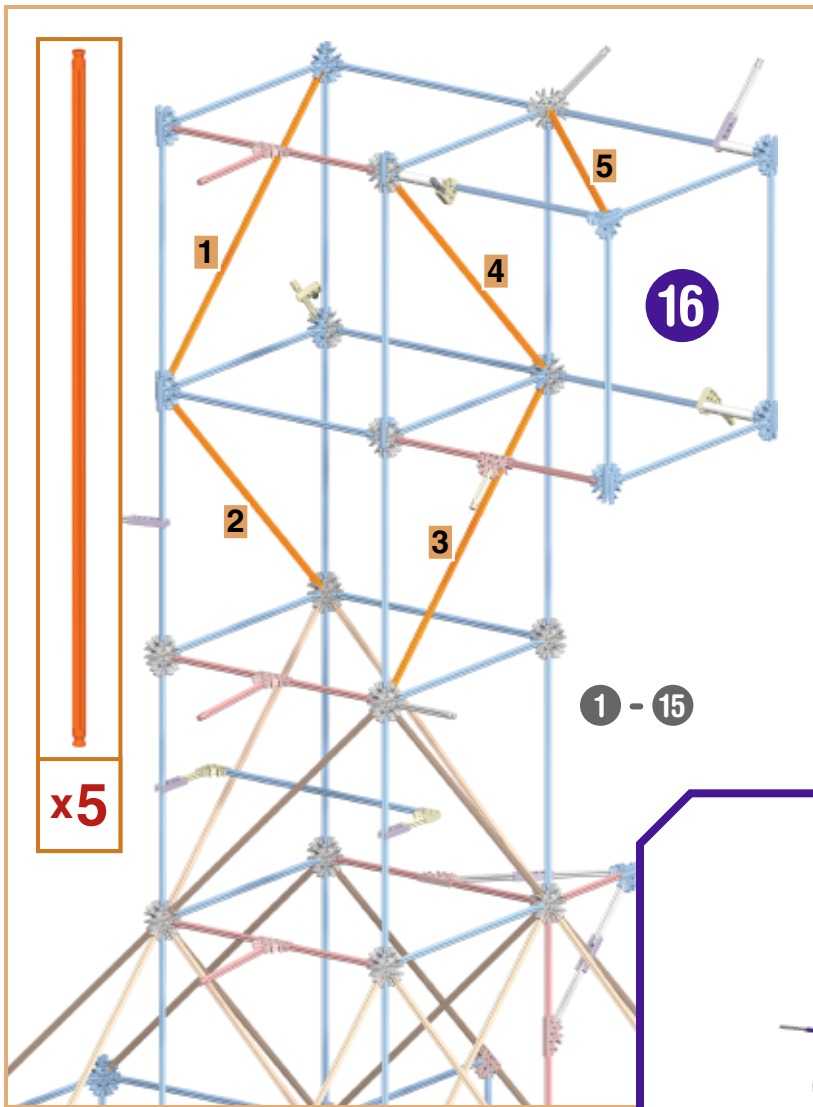

18

1 - 17

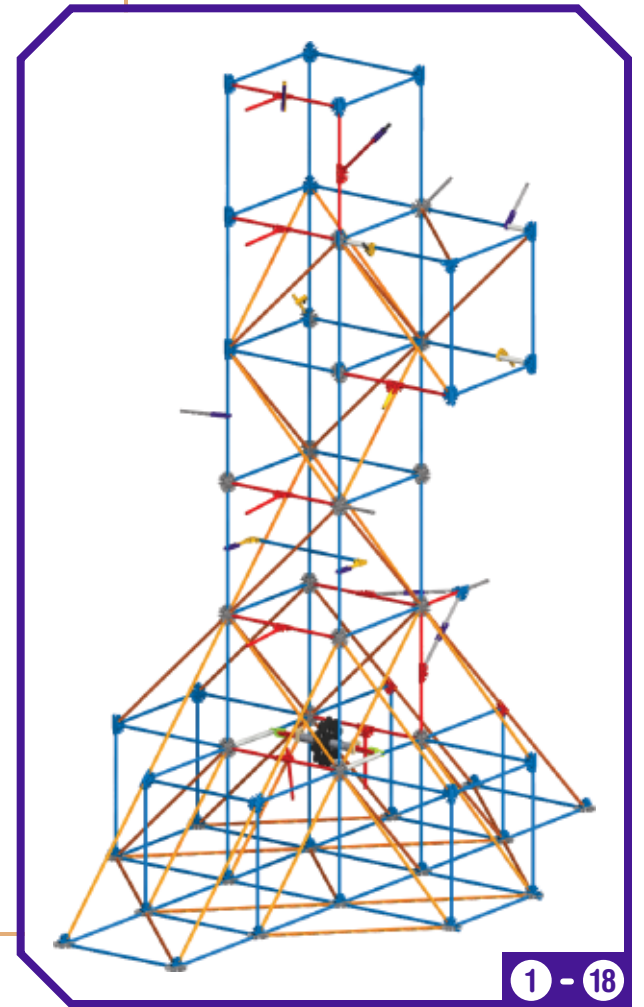
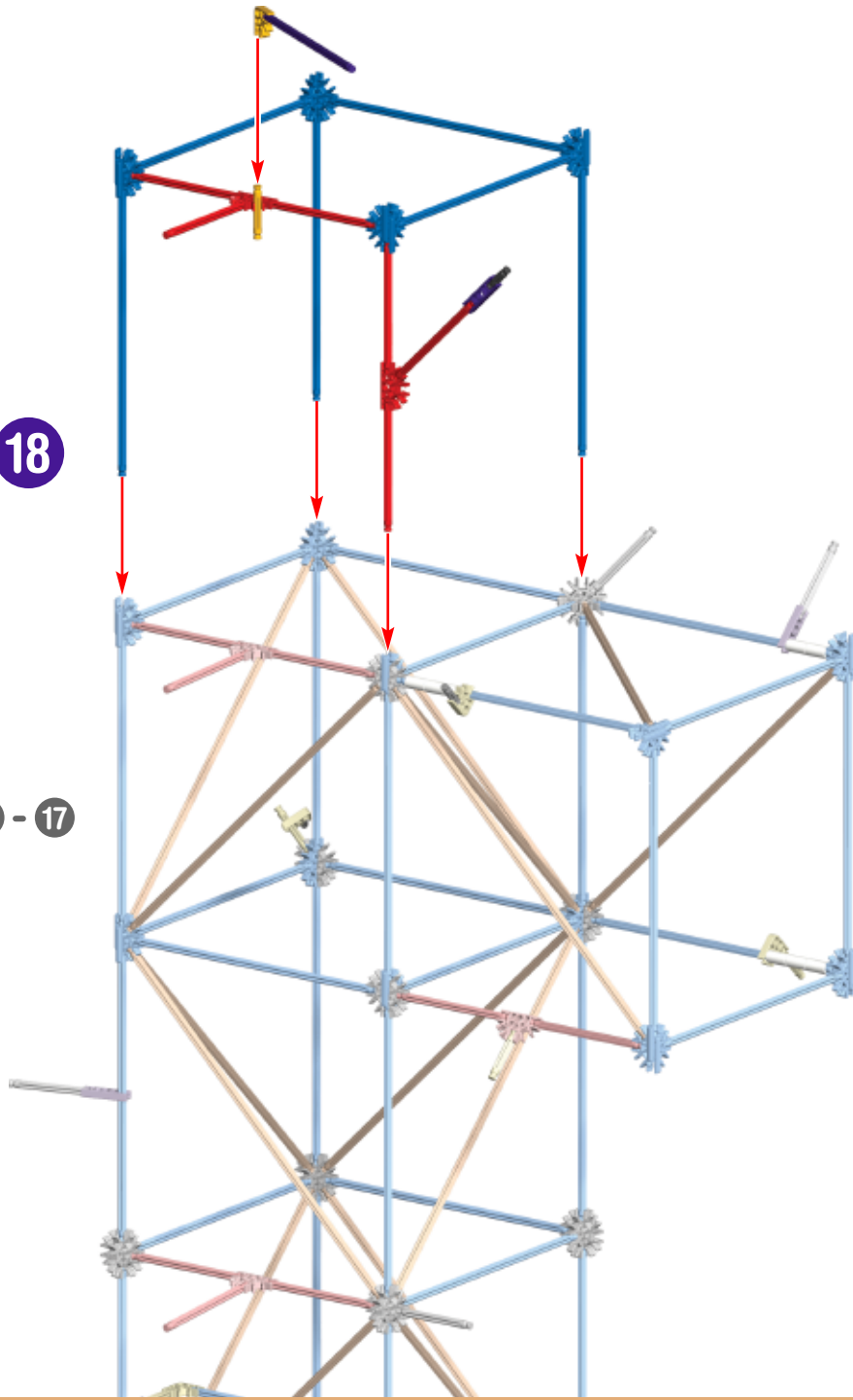

1 - 18

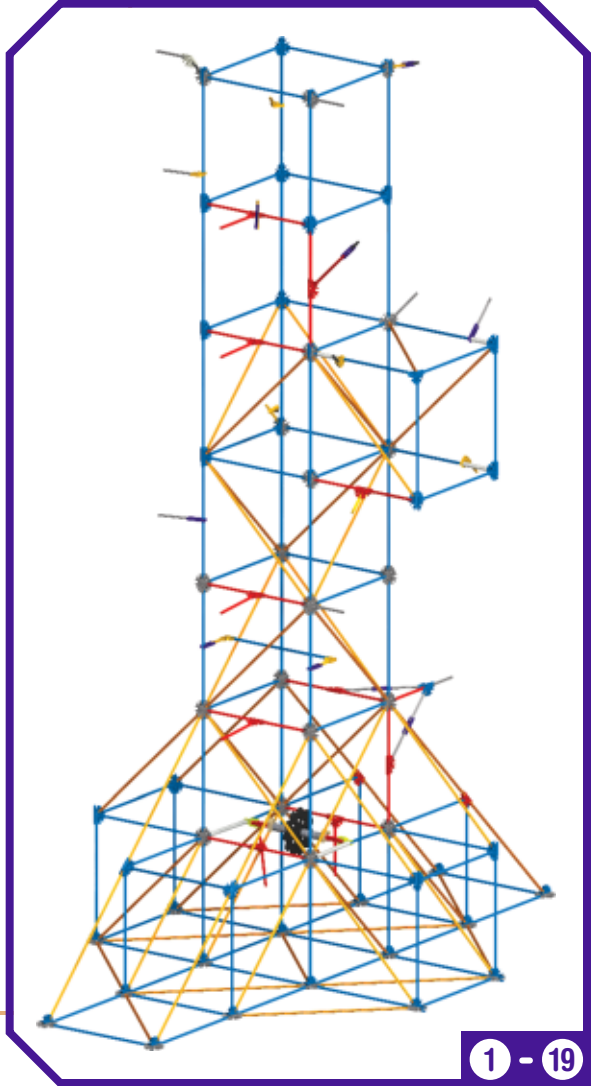
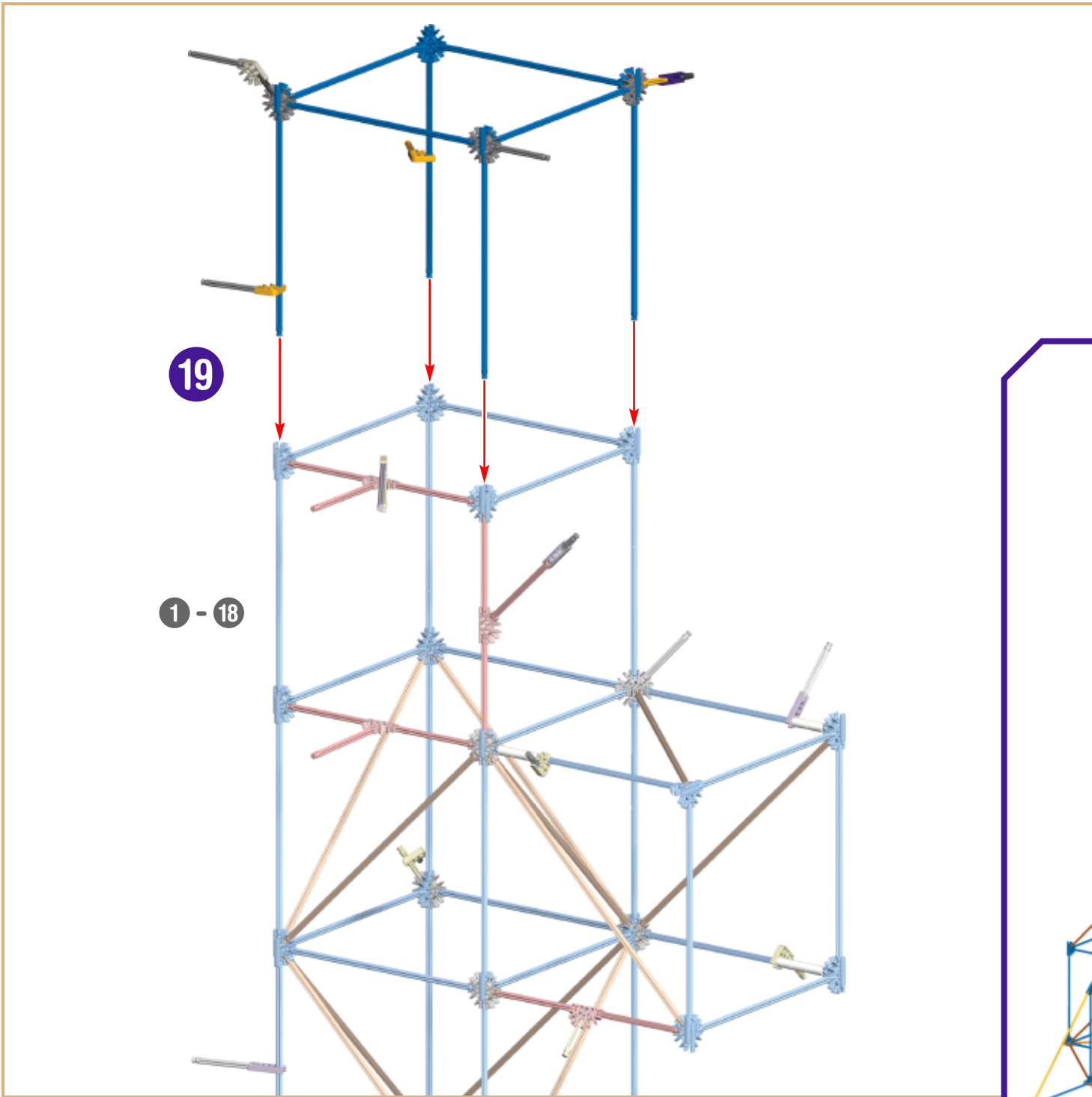

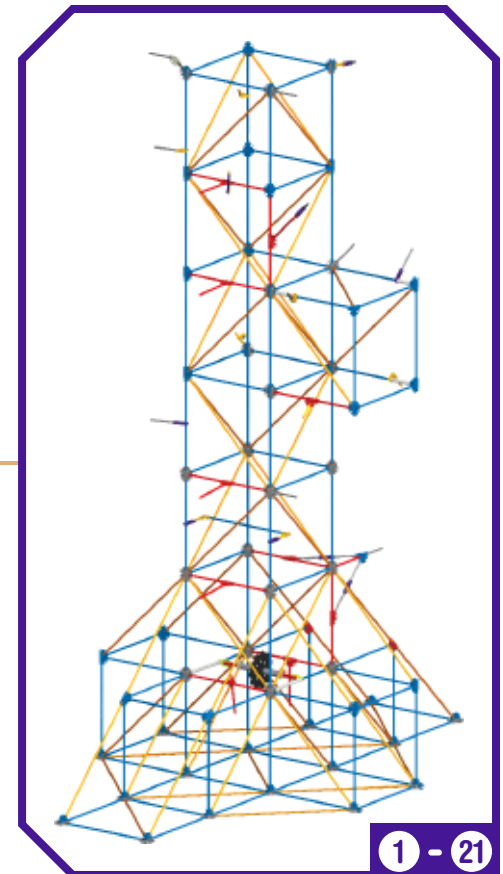
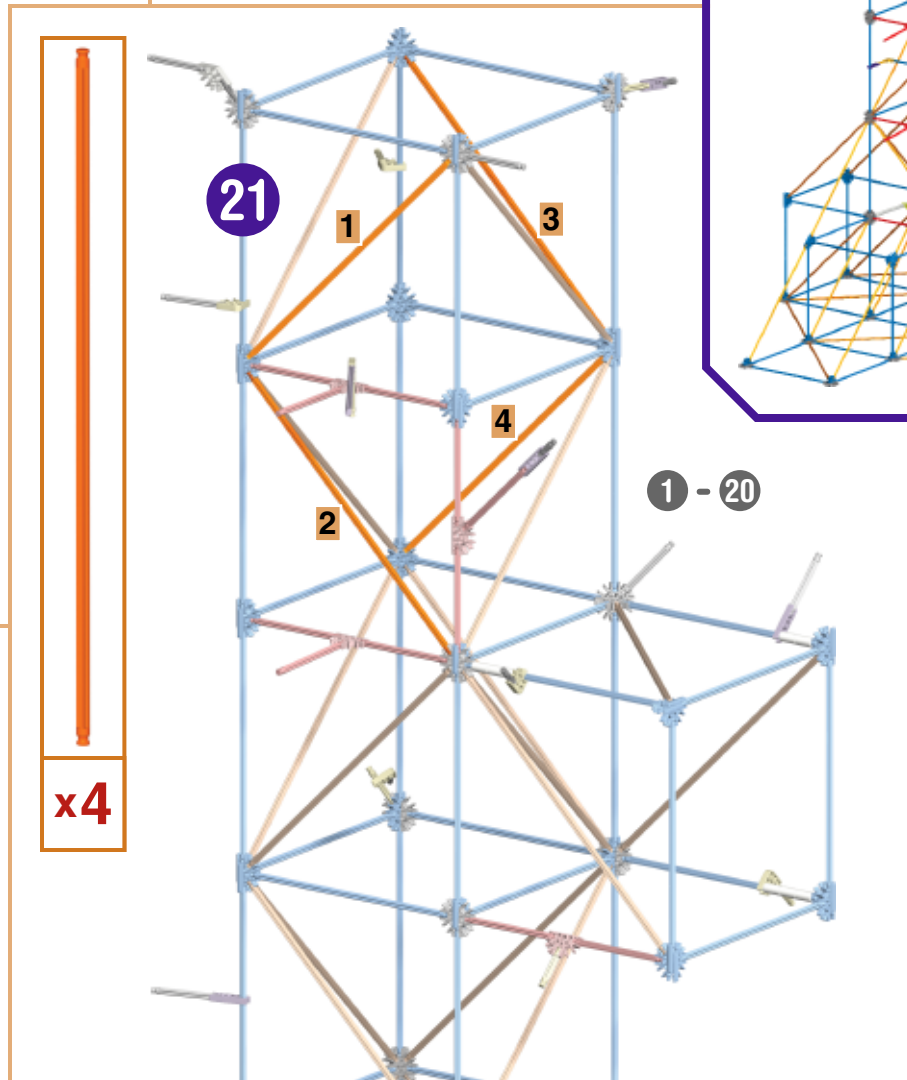
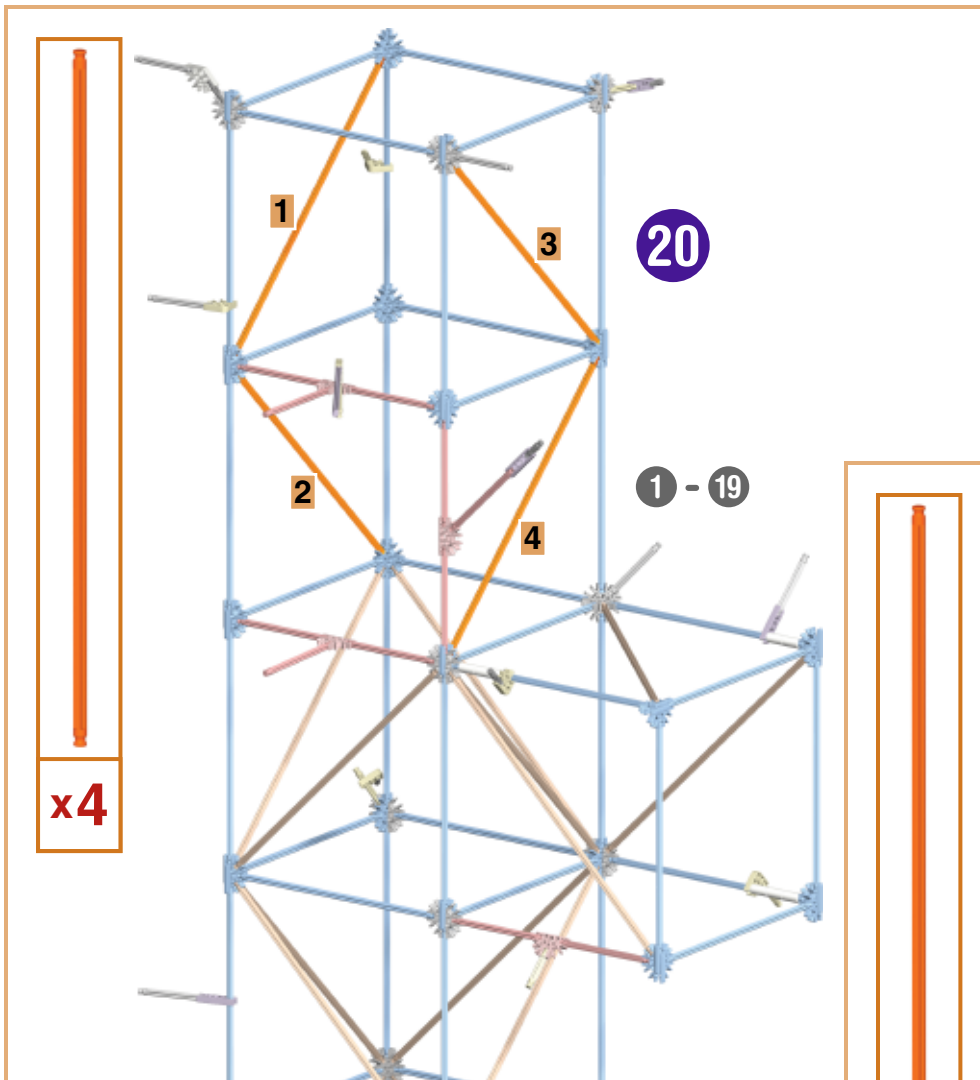

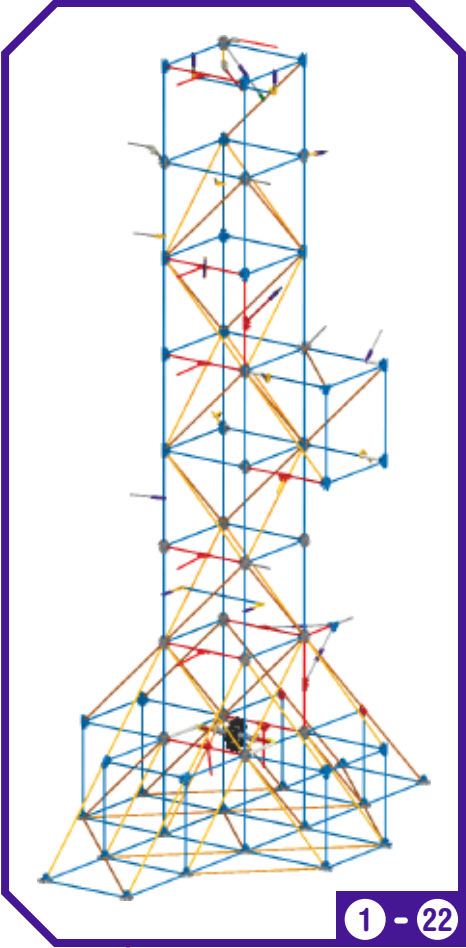
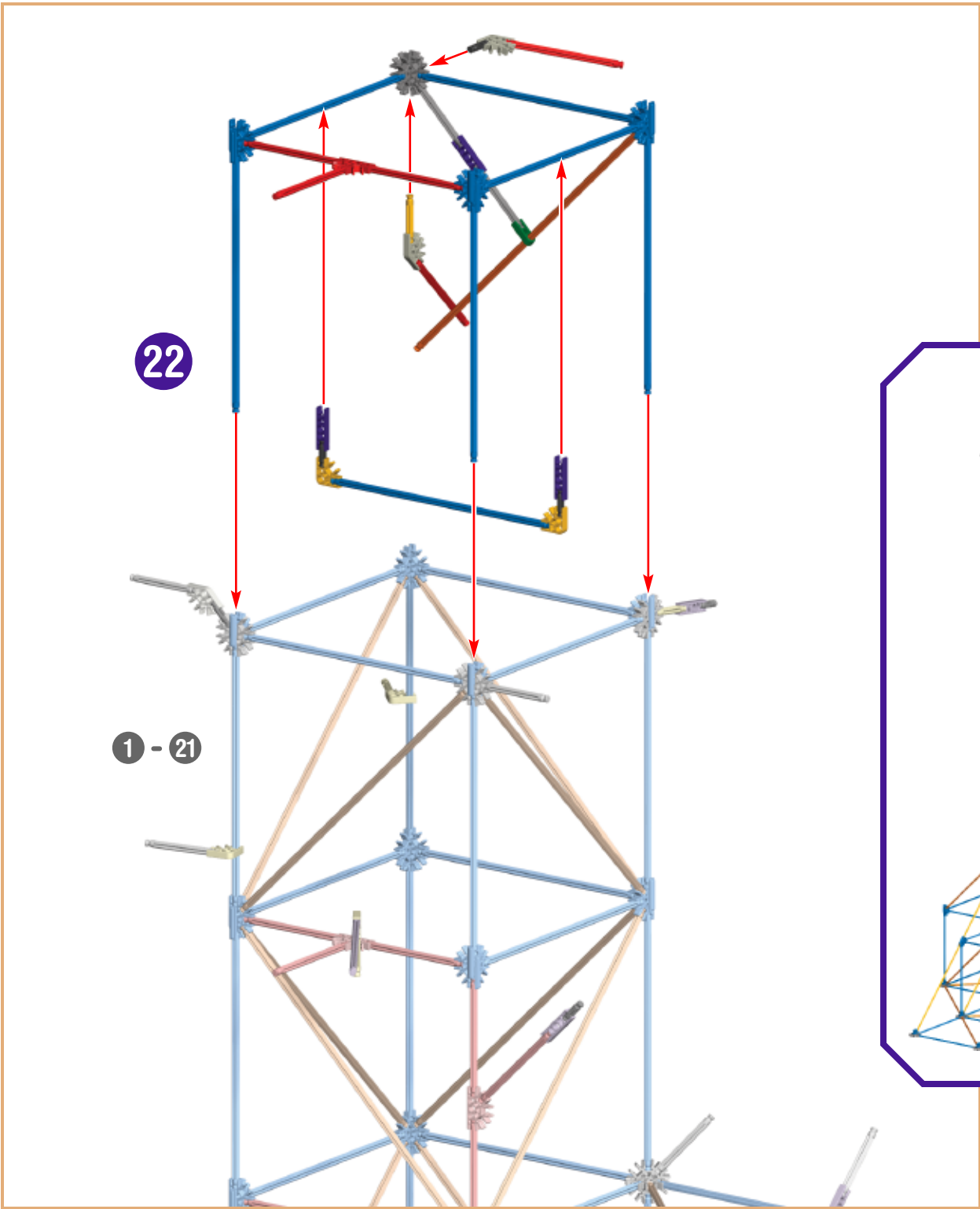

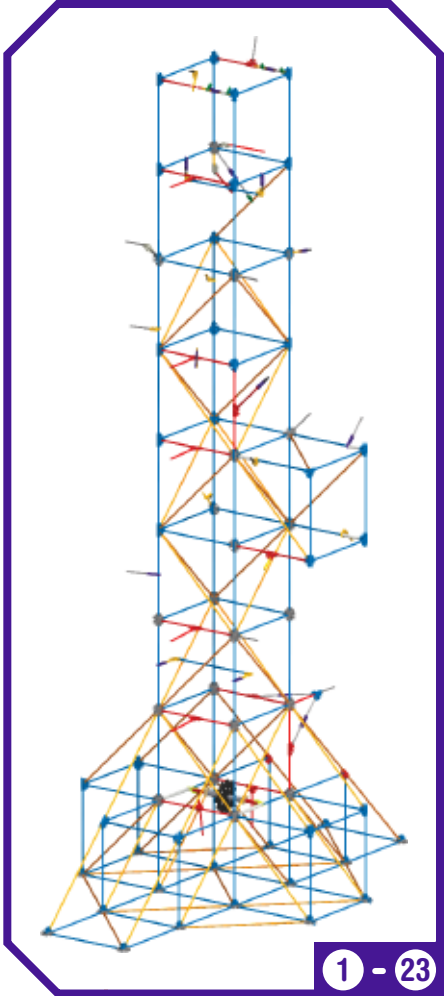
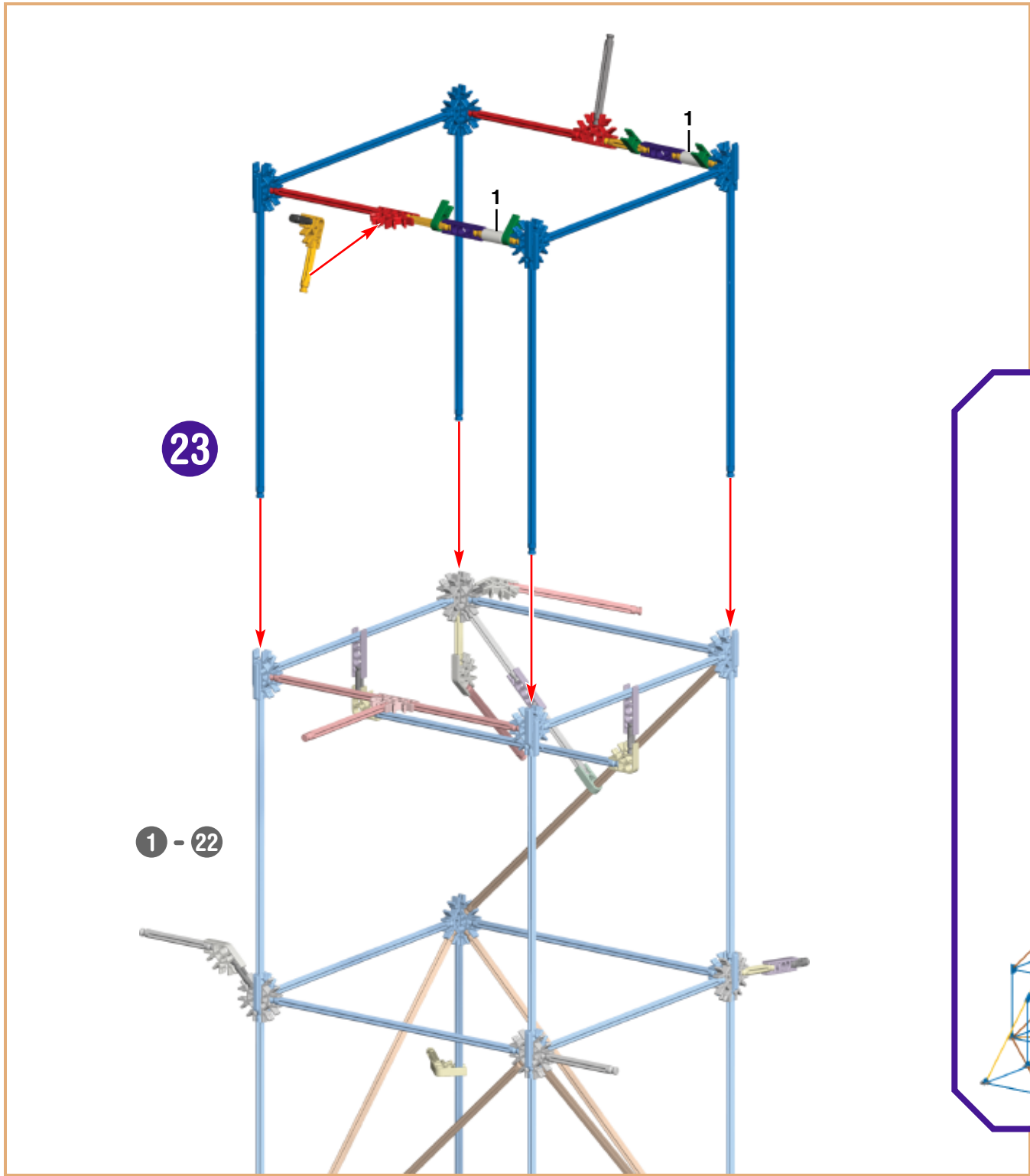

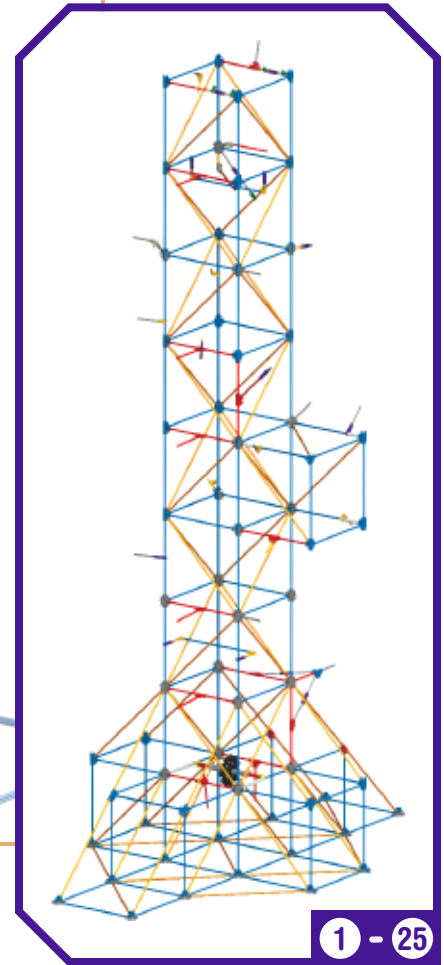
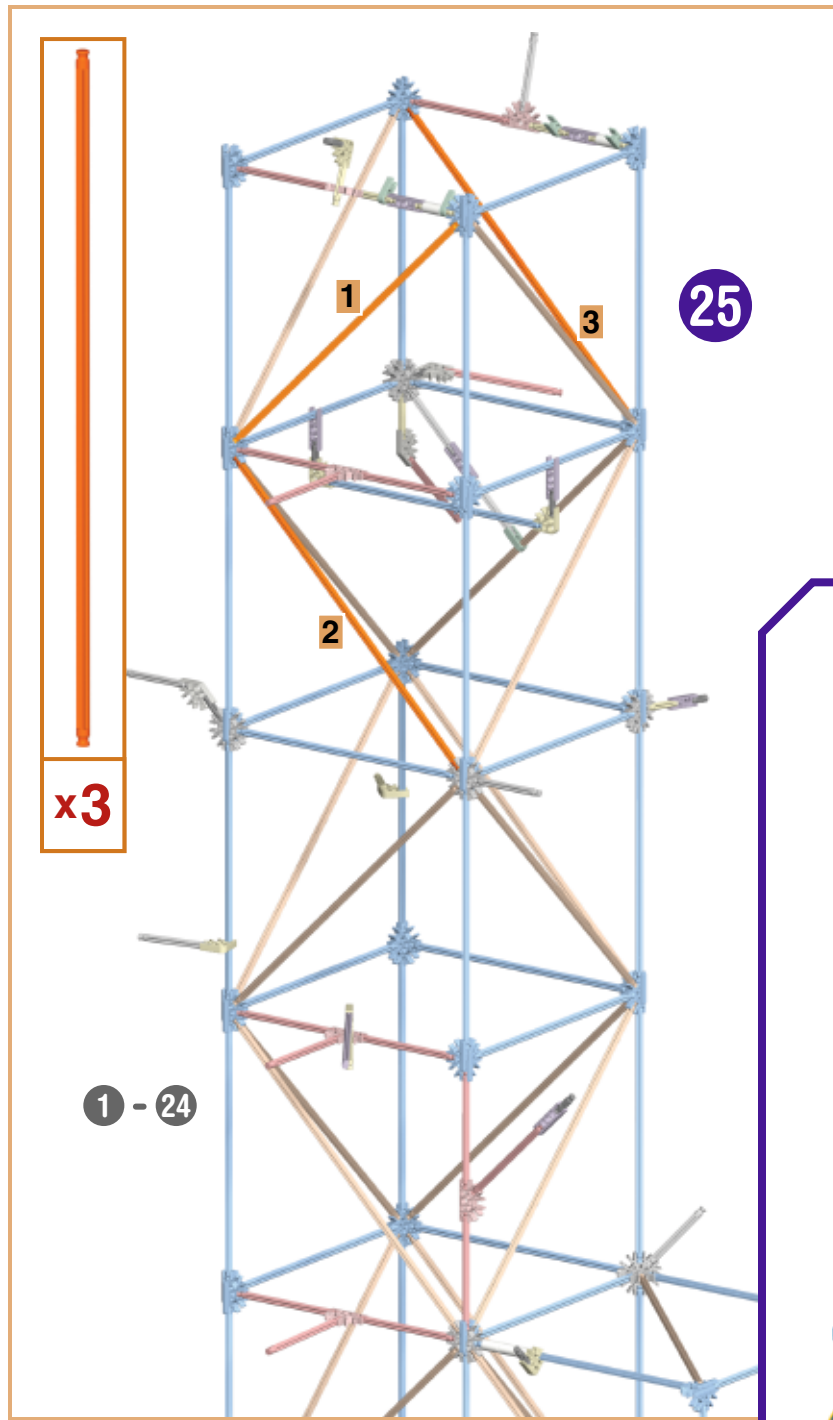
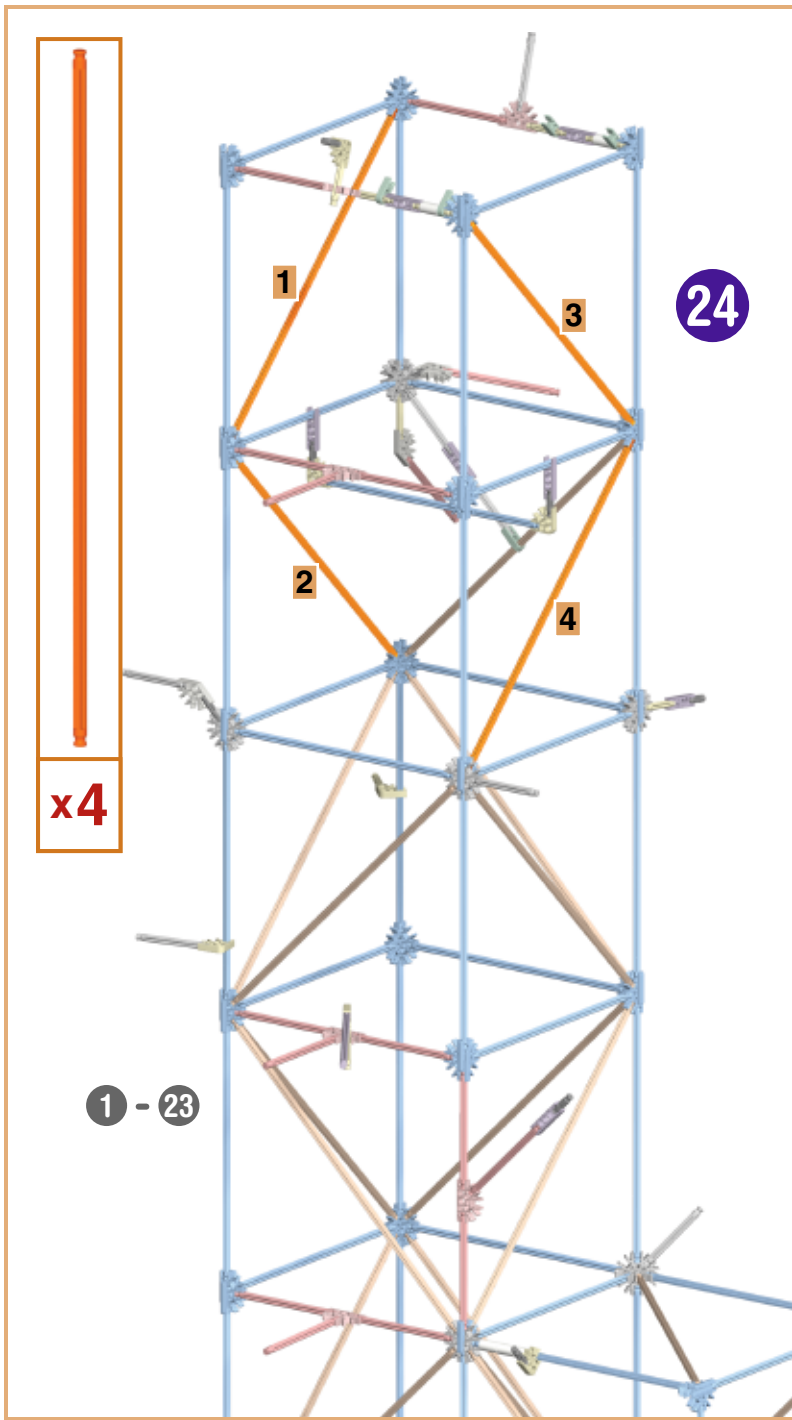

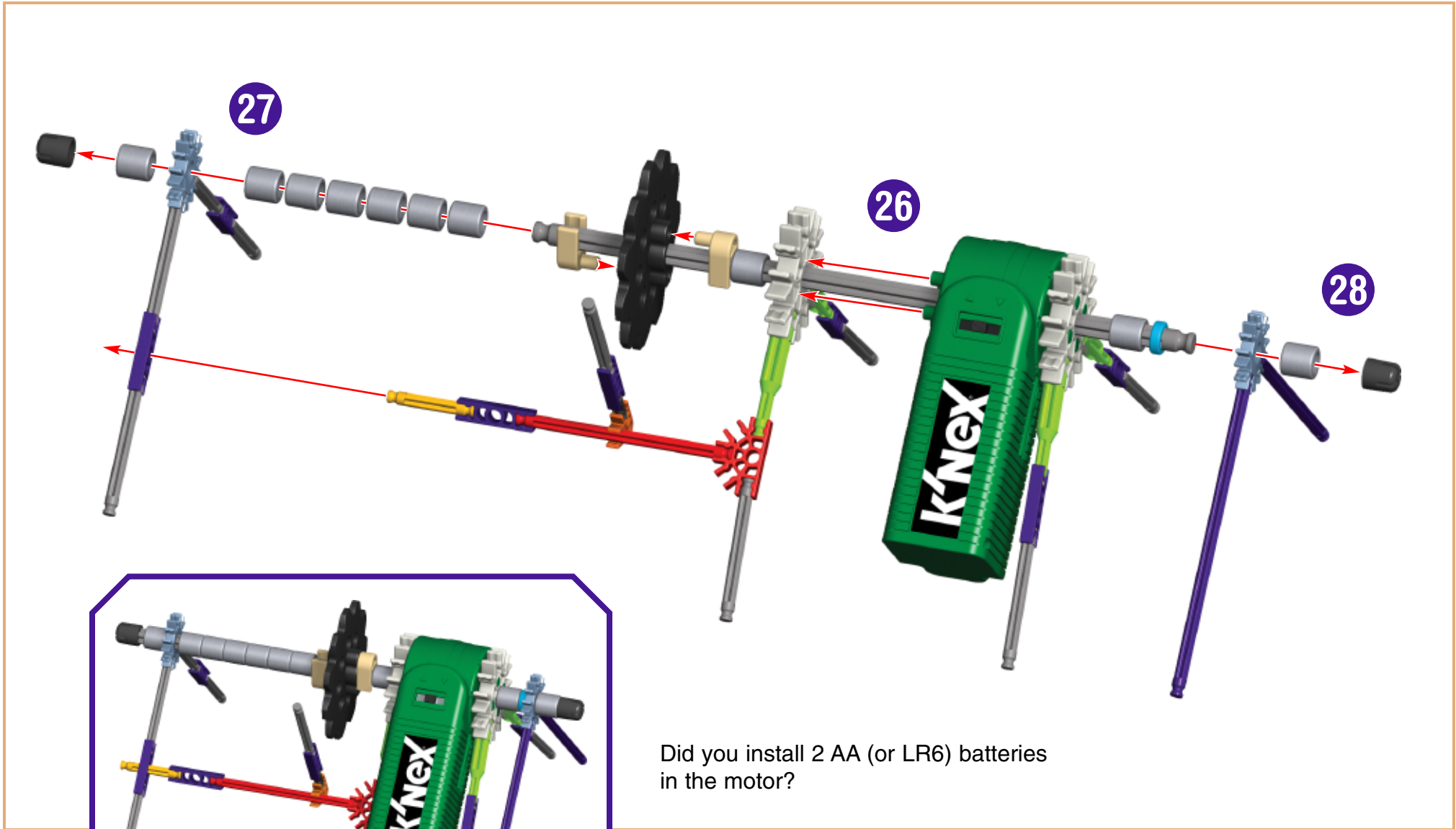

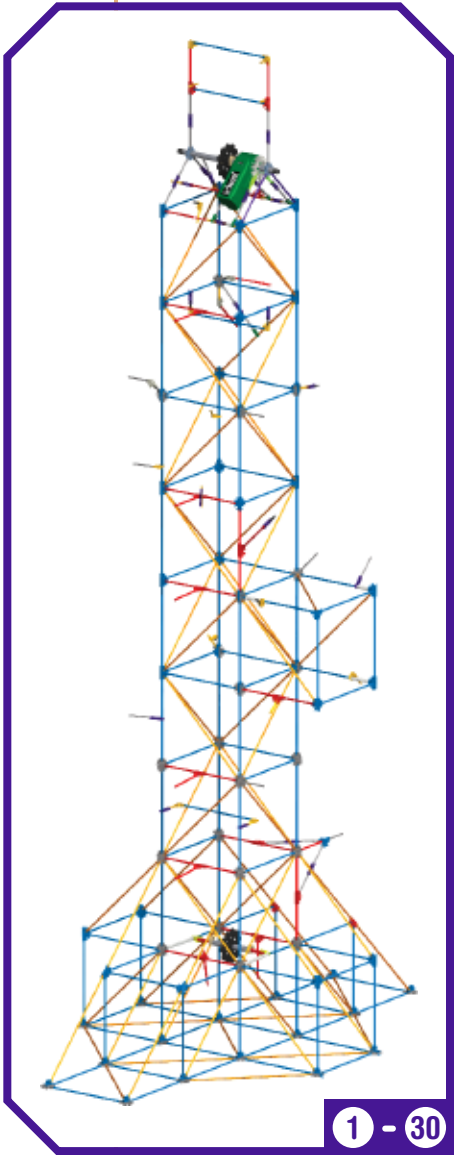
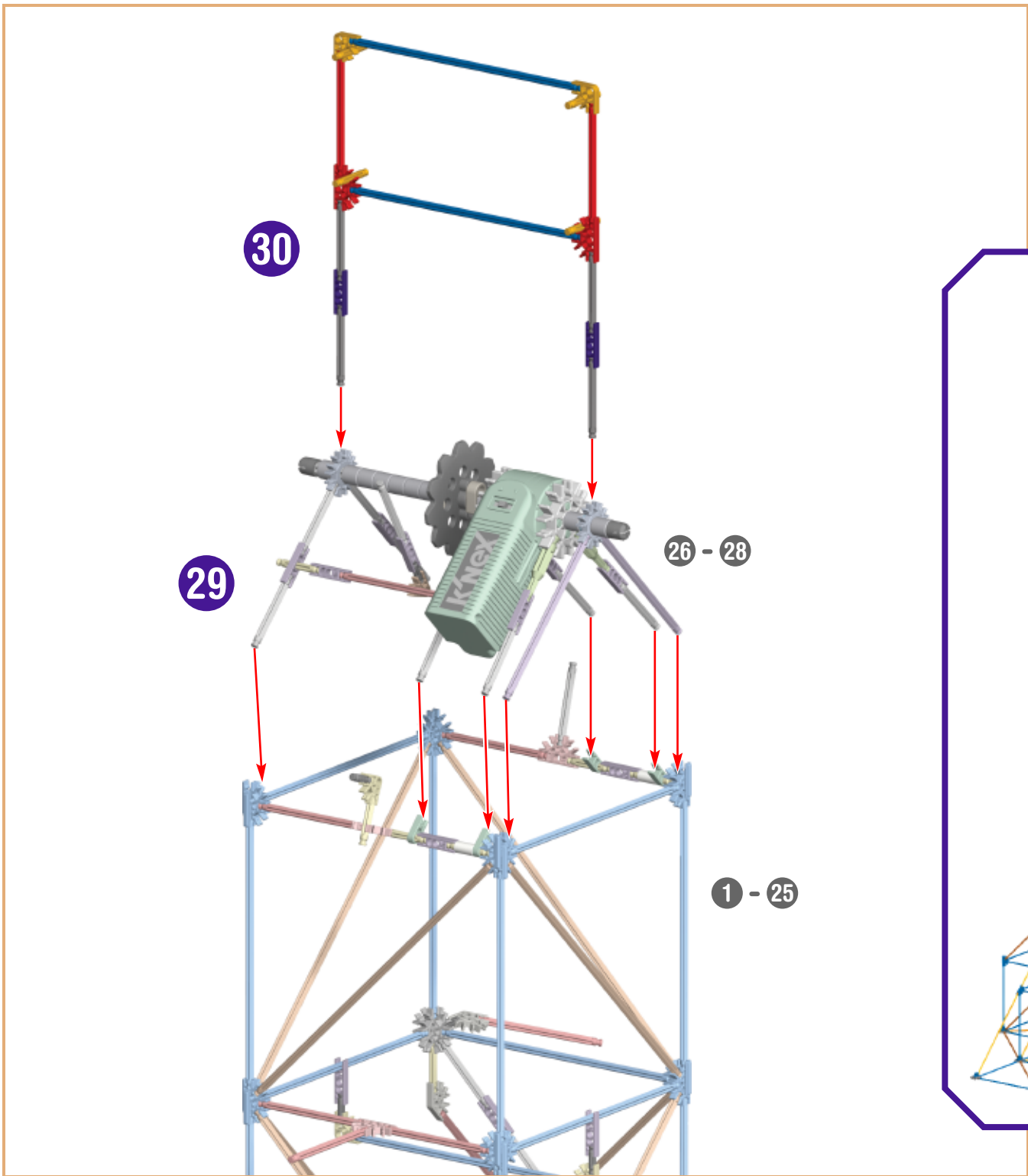

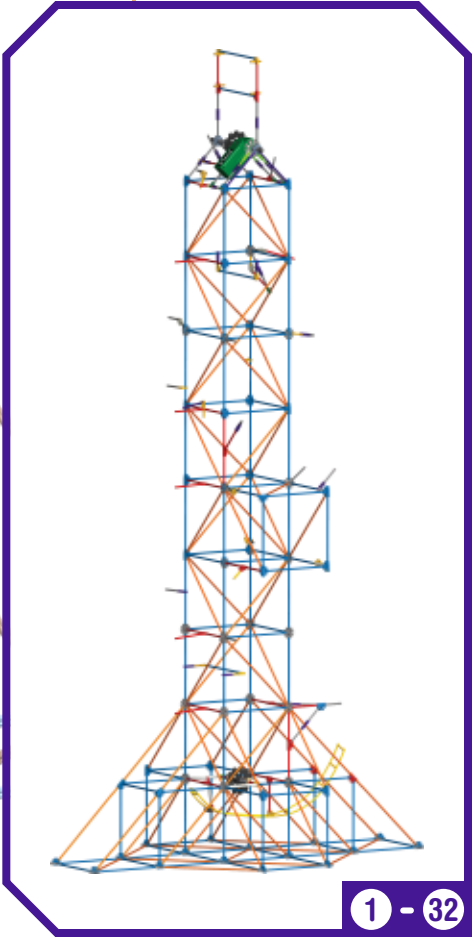
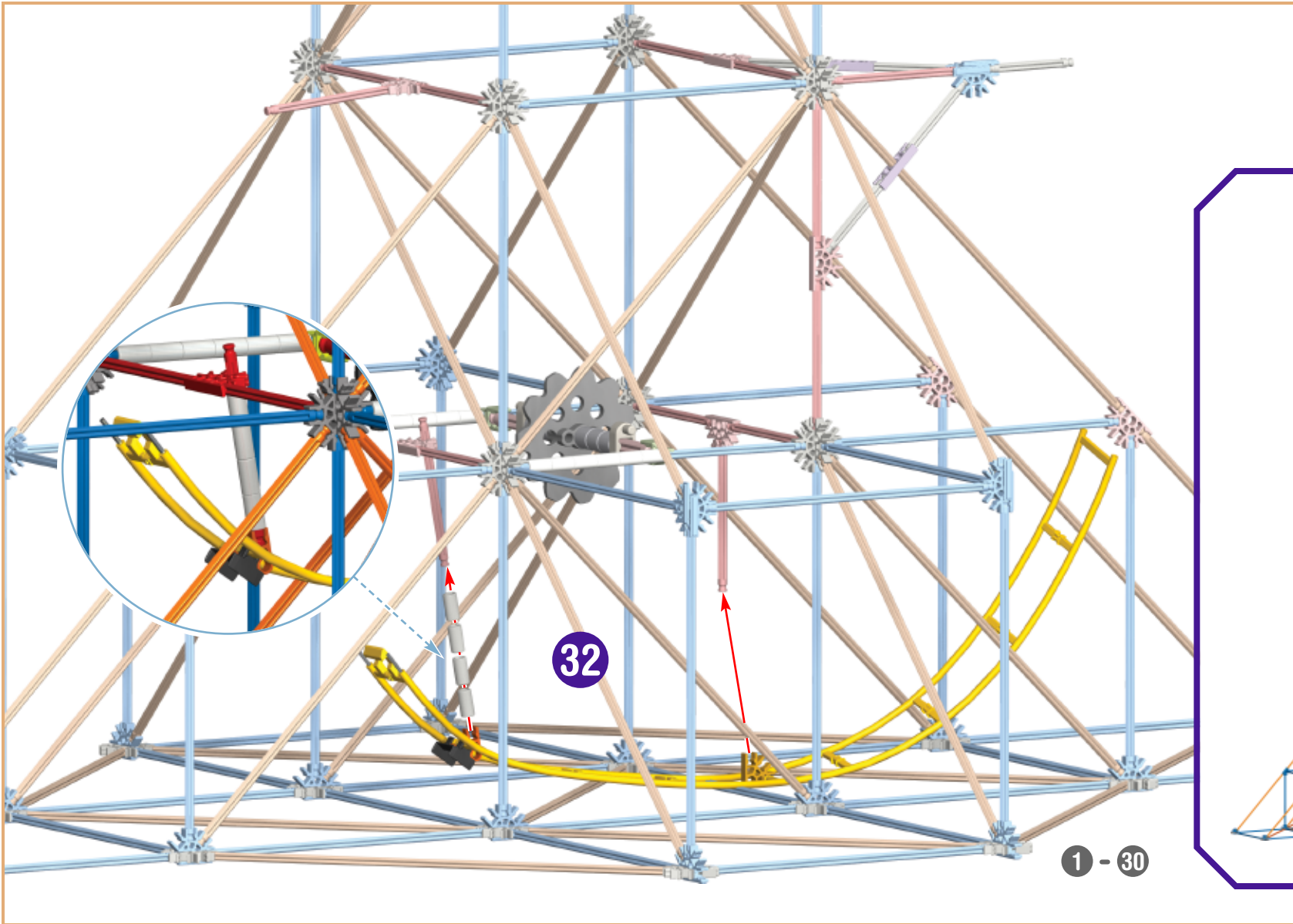
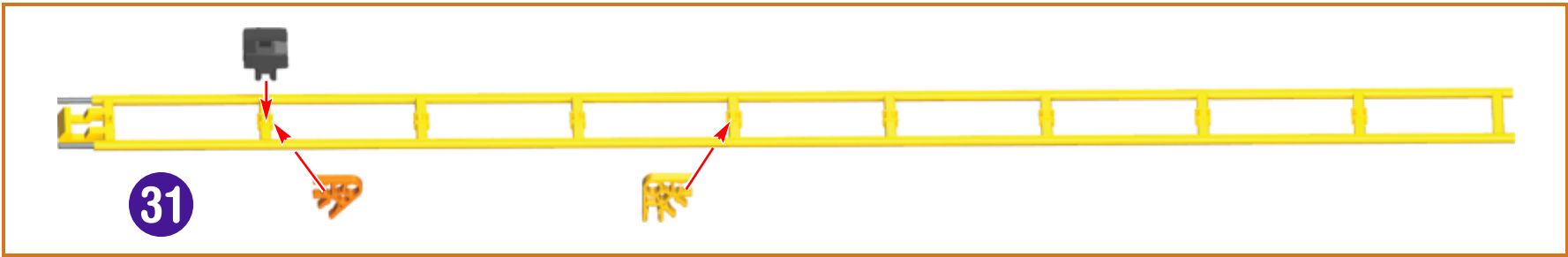

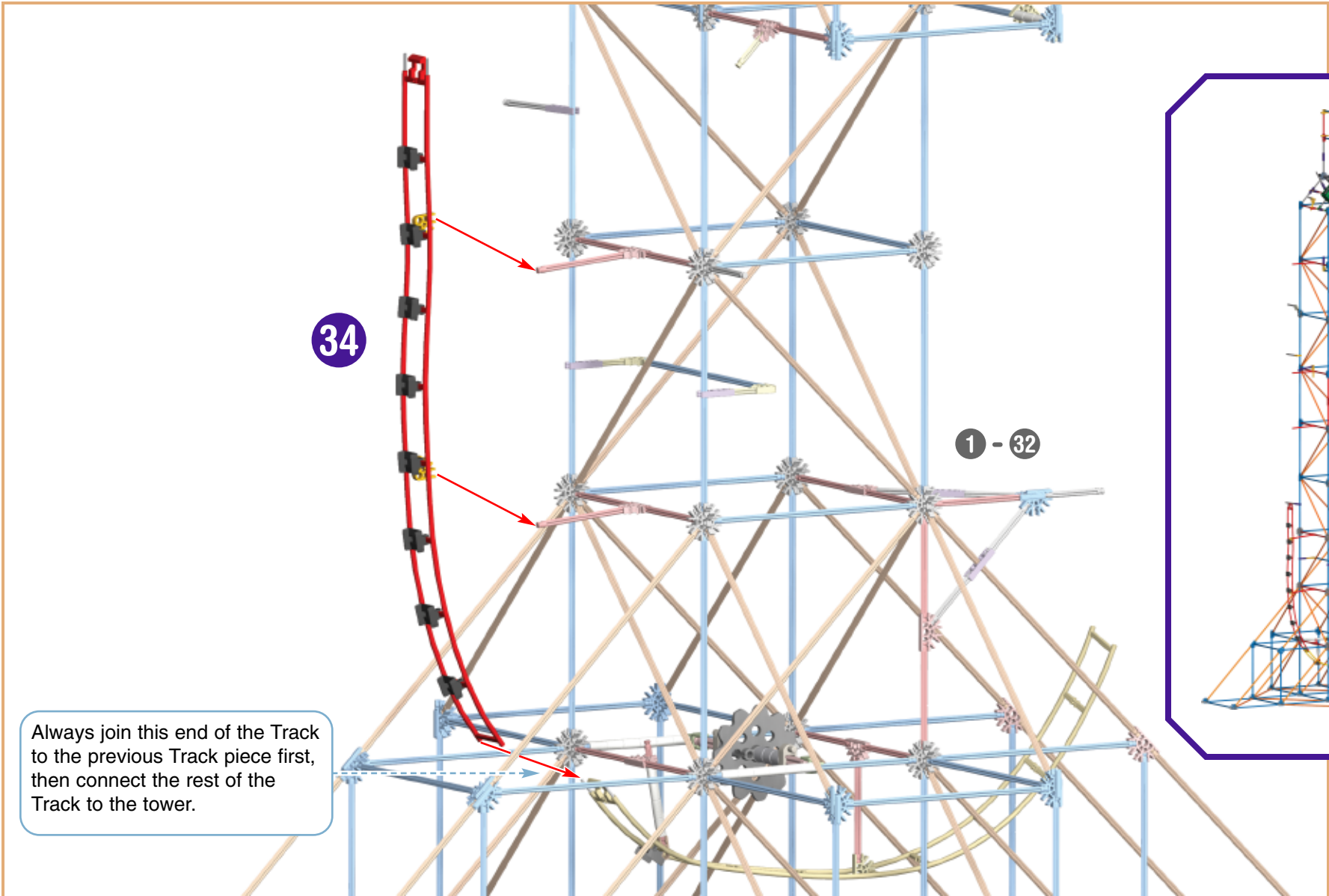
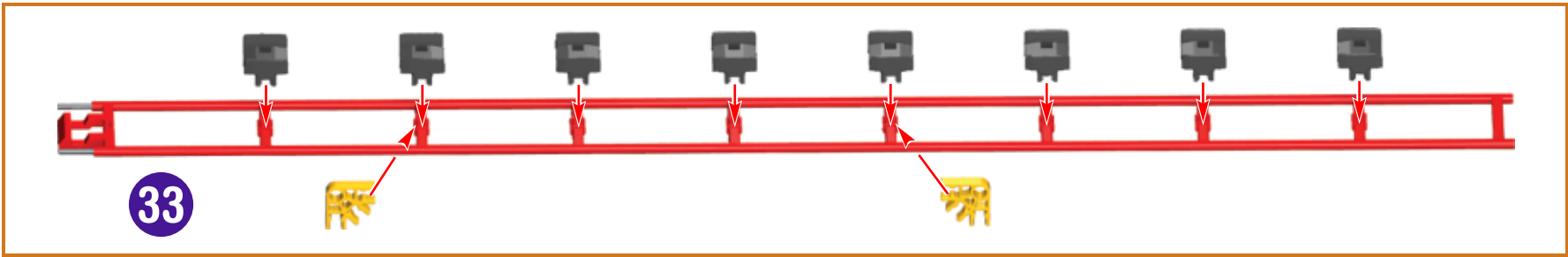

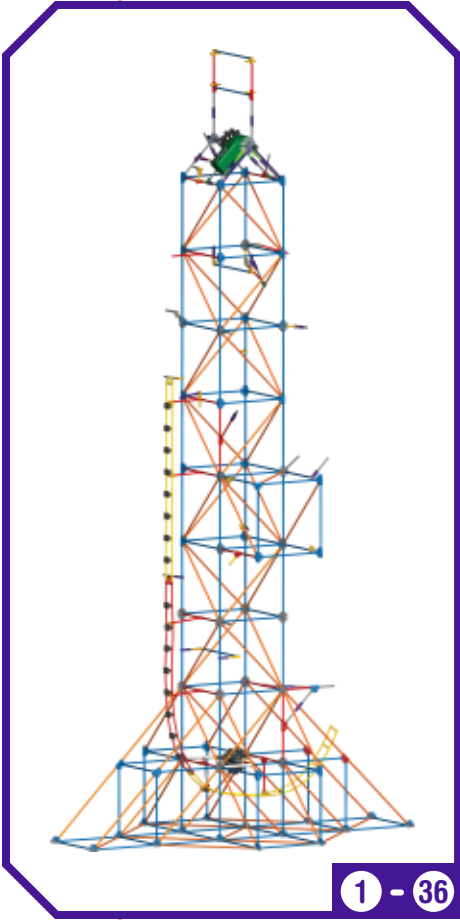
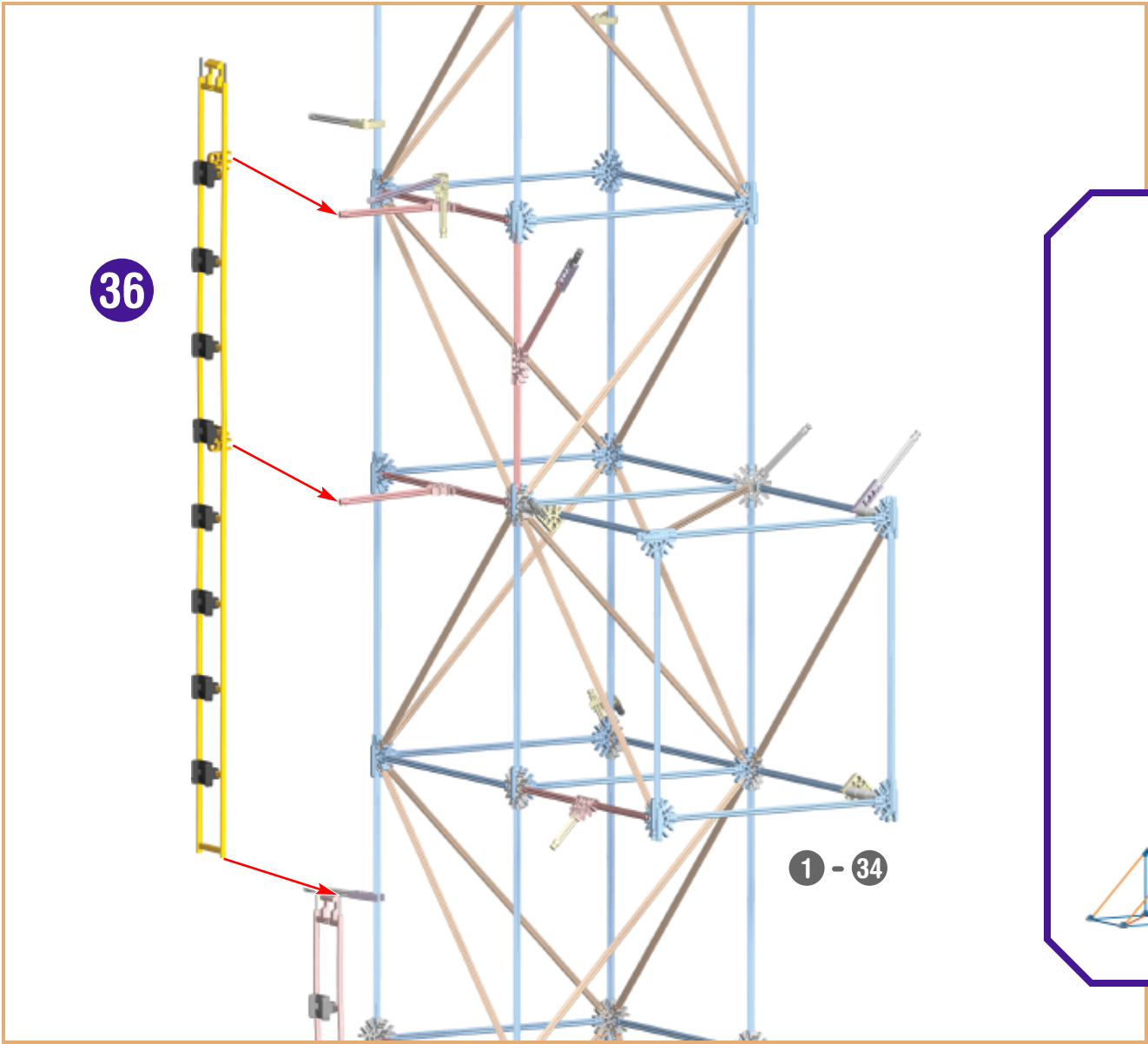
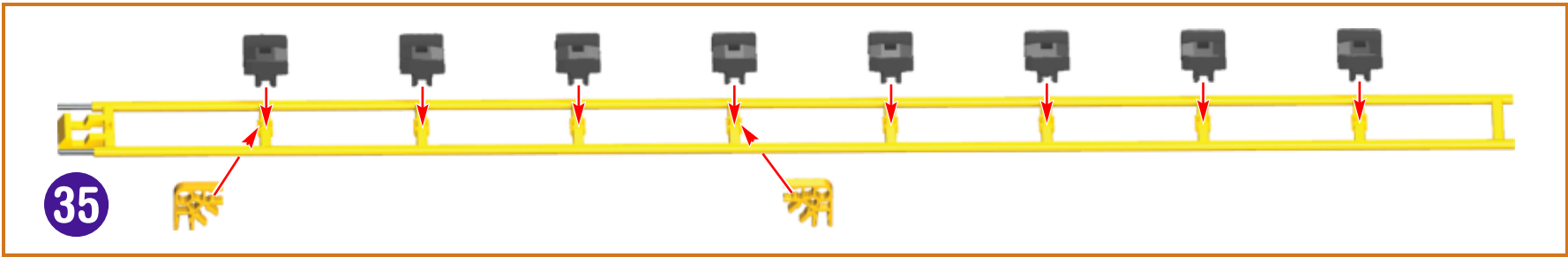

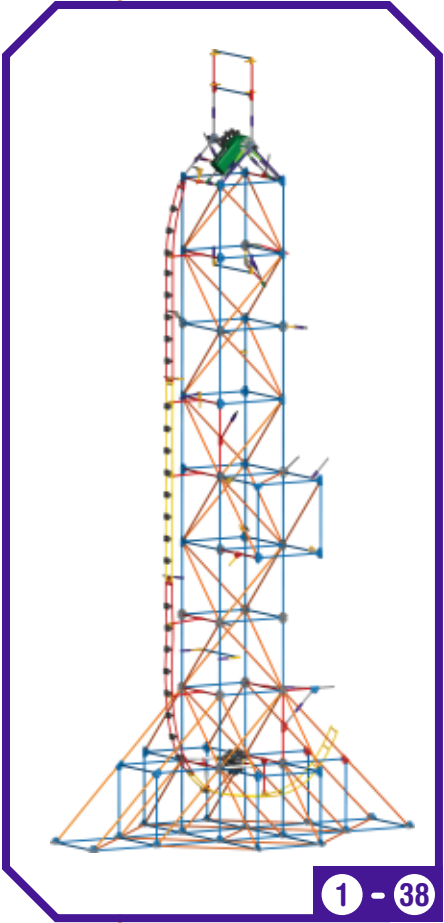
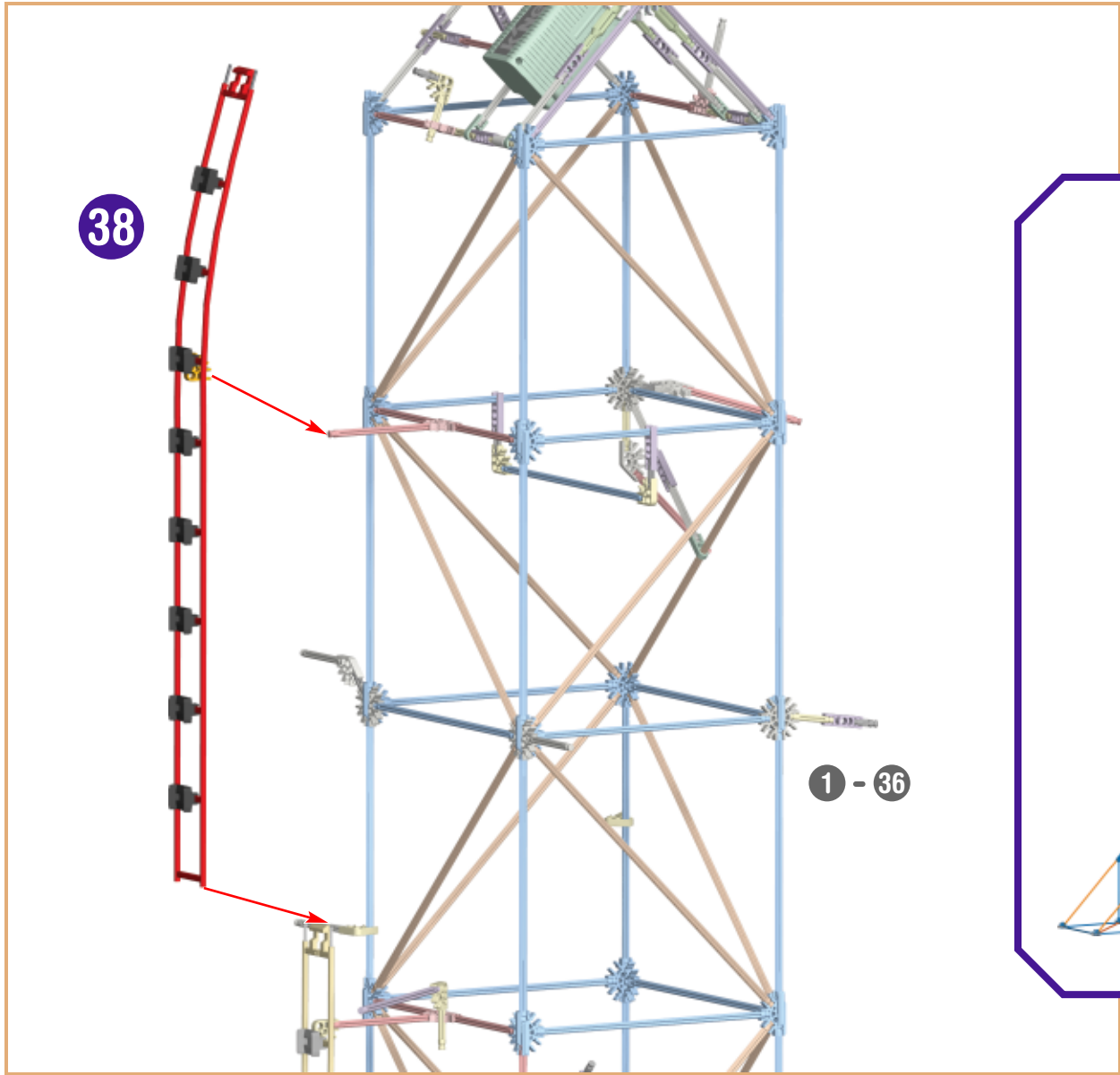
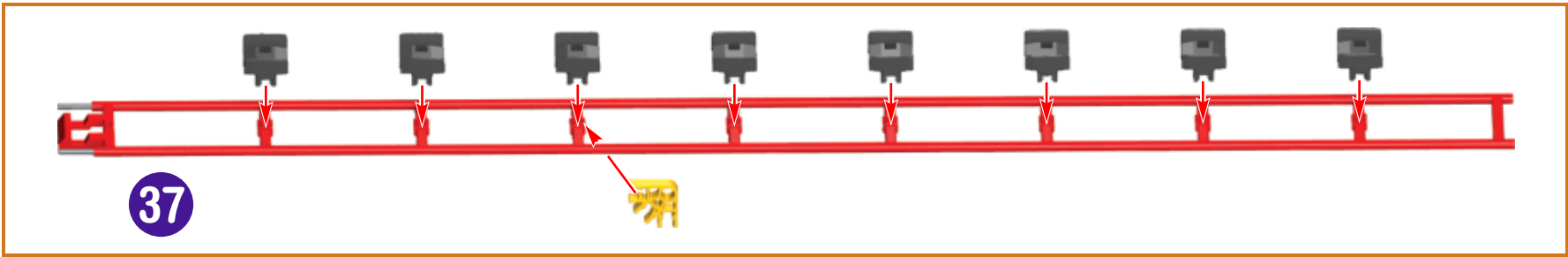

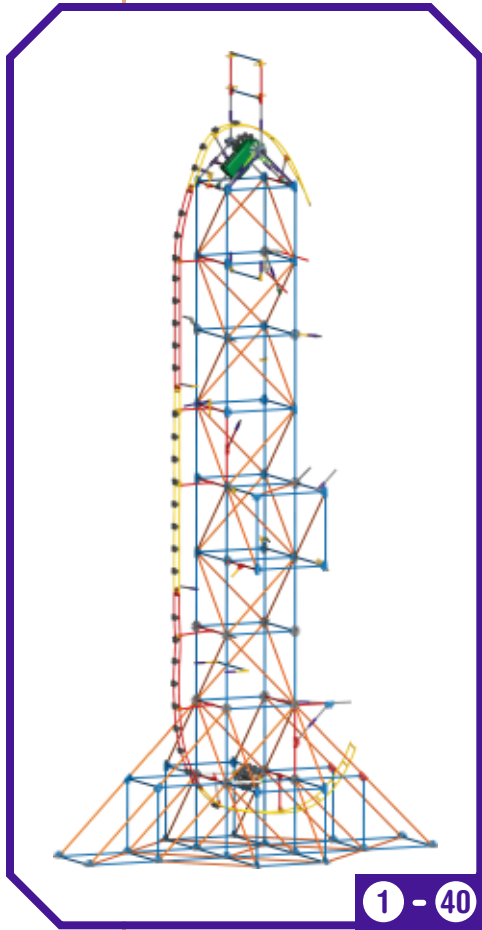
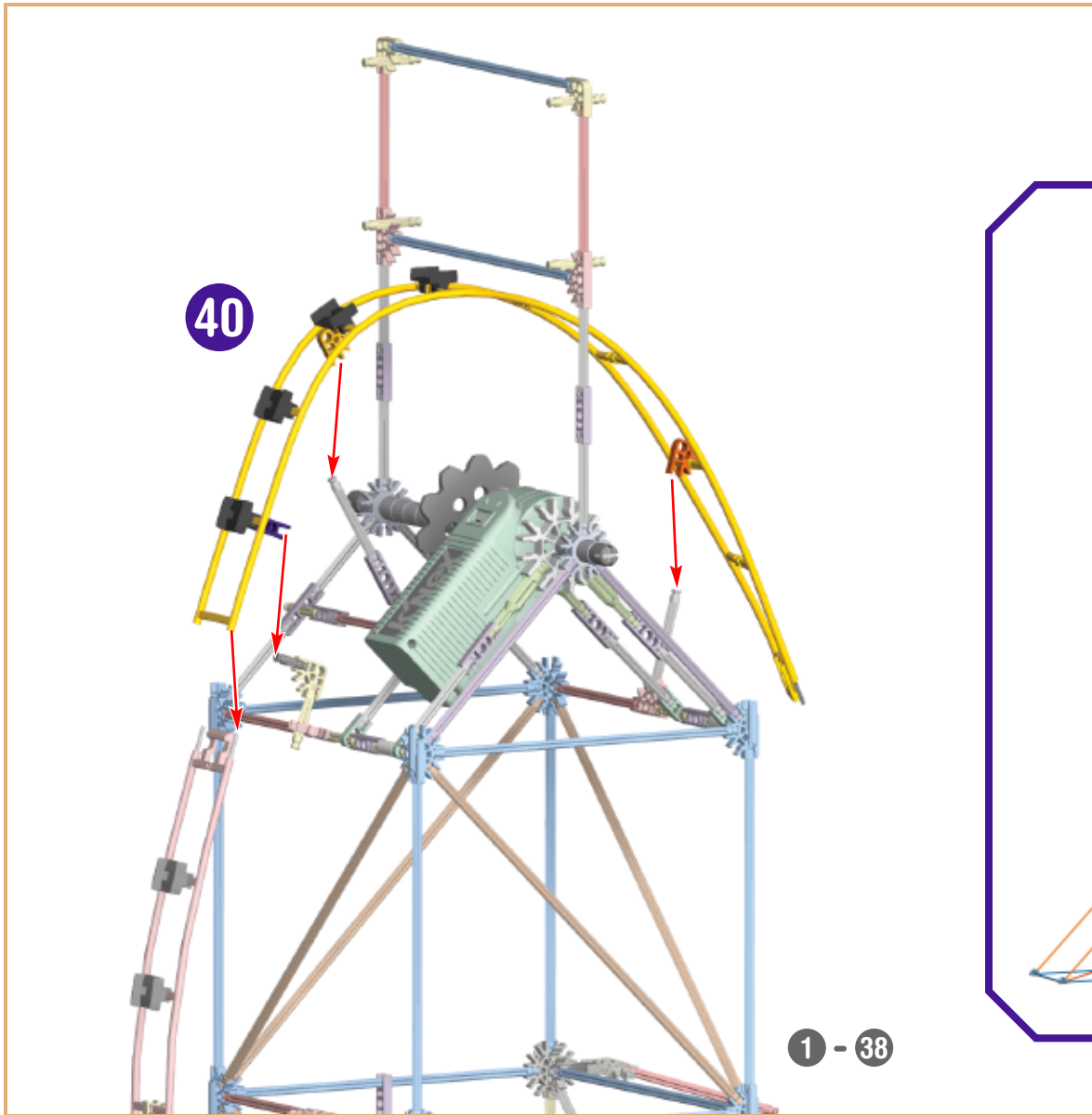
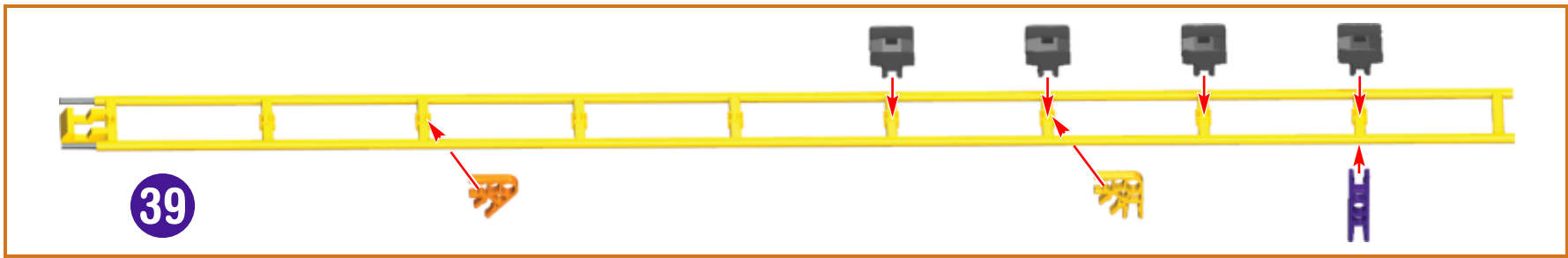

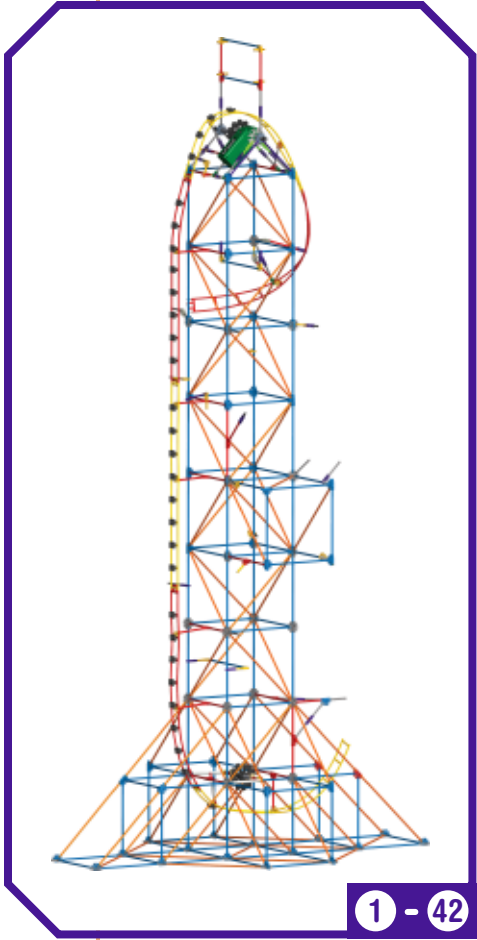
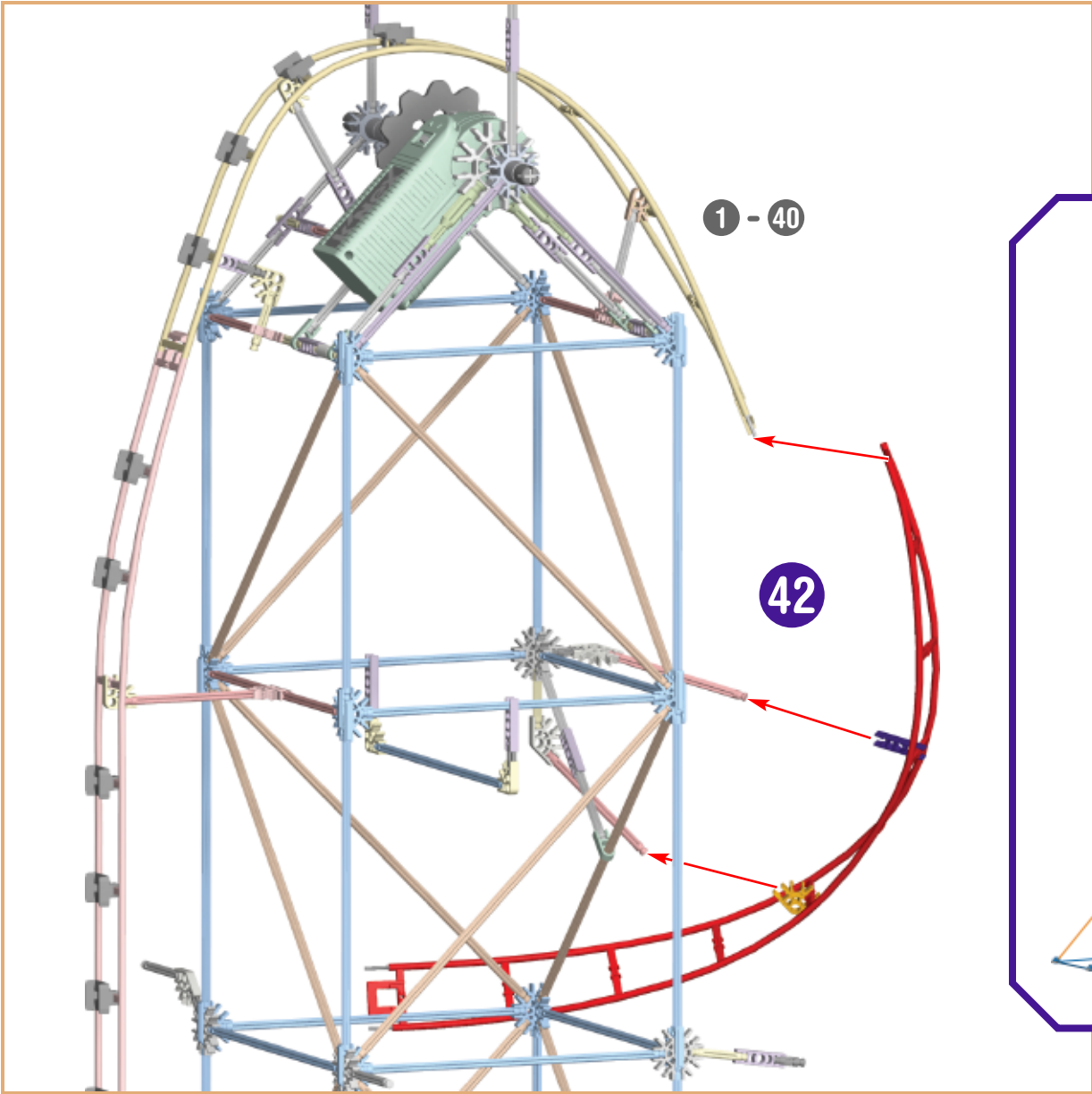
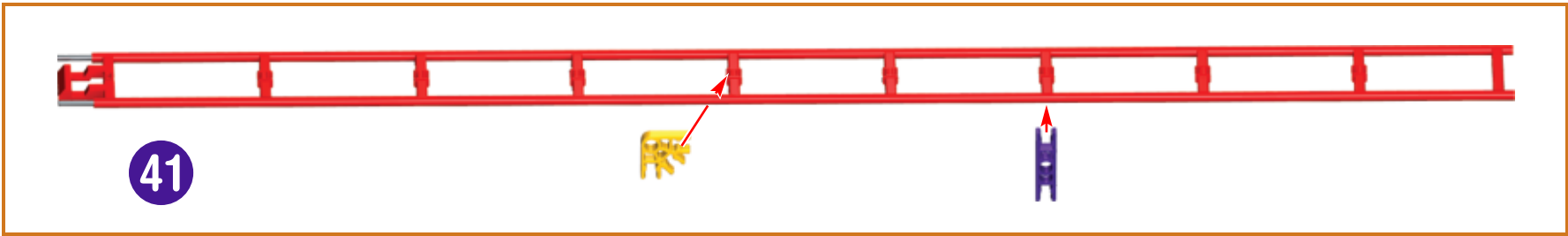

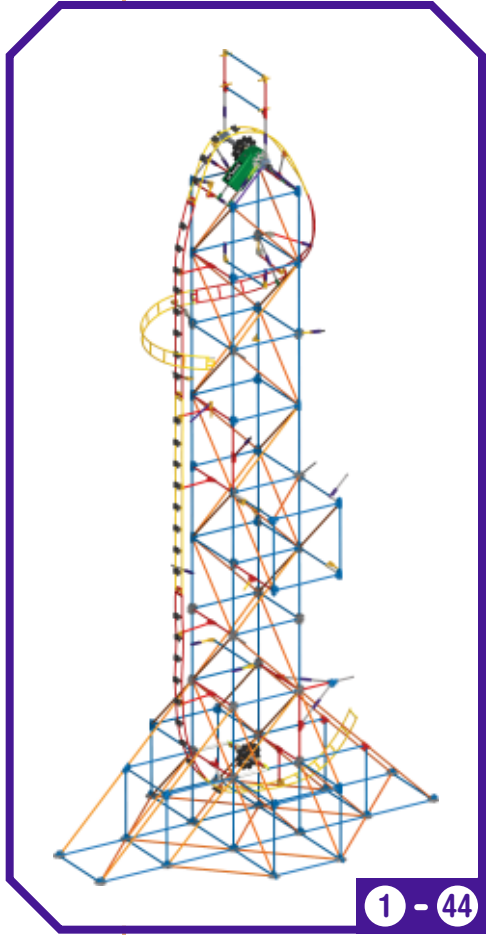
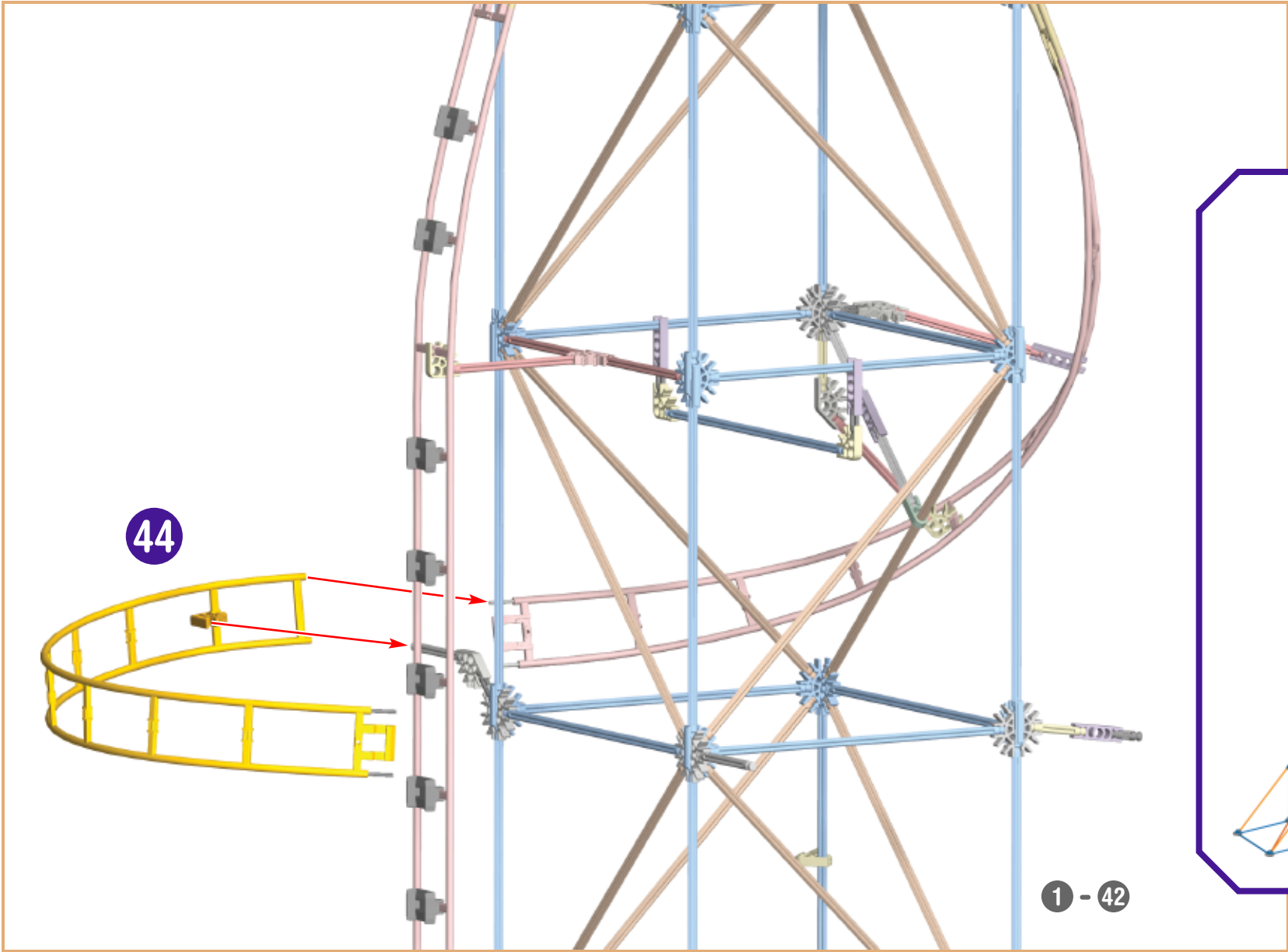
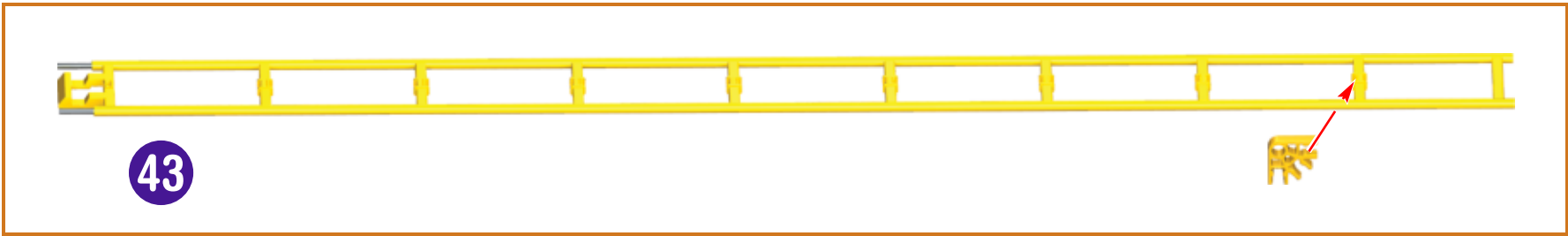

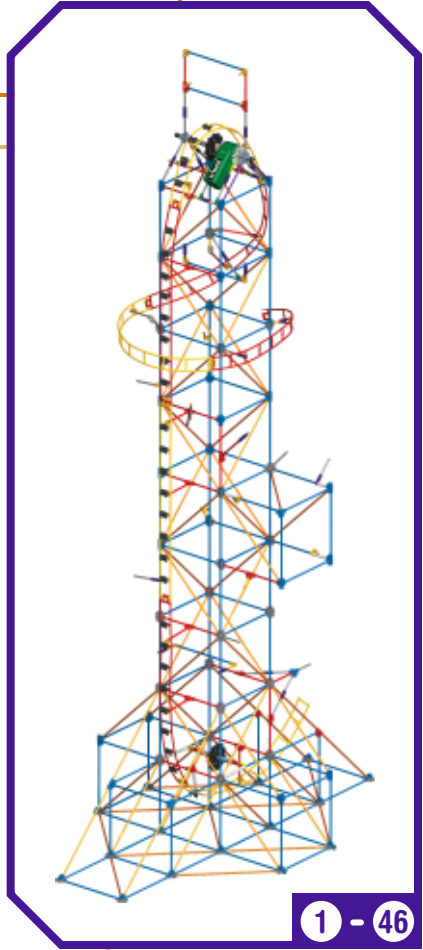
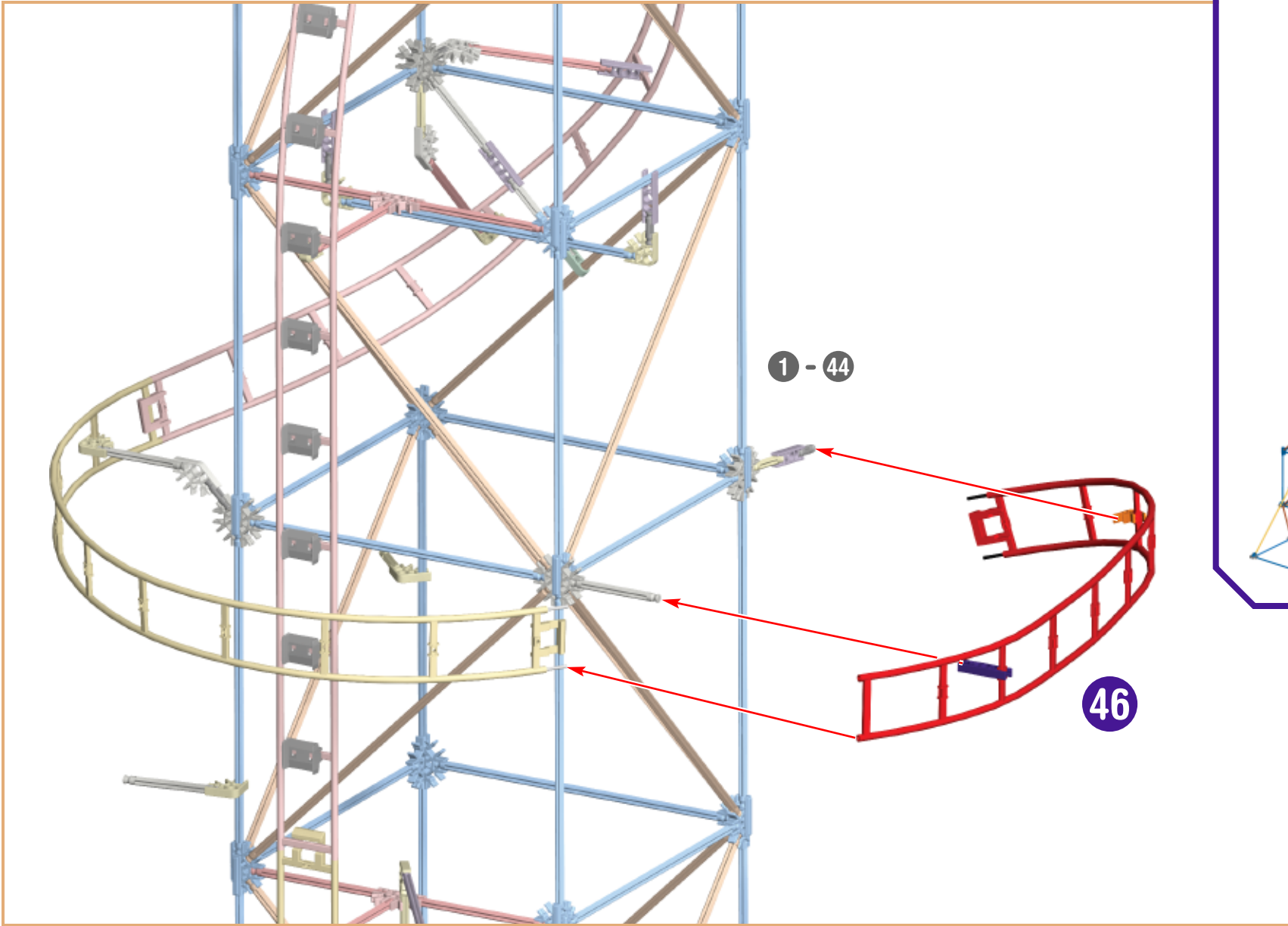
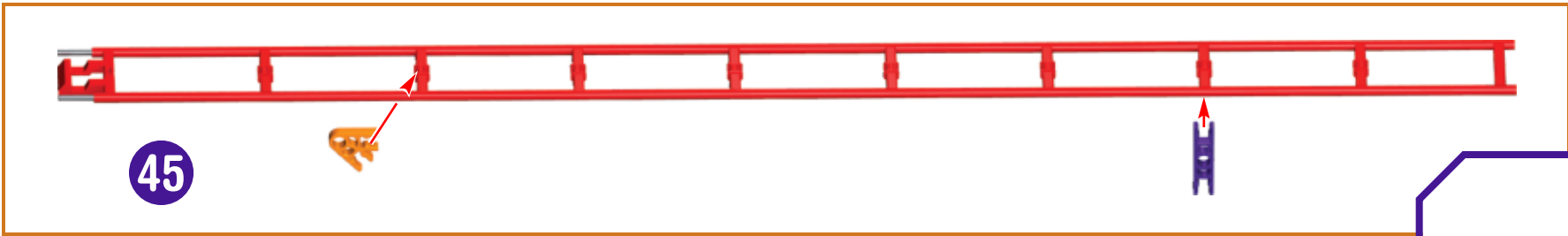

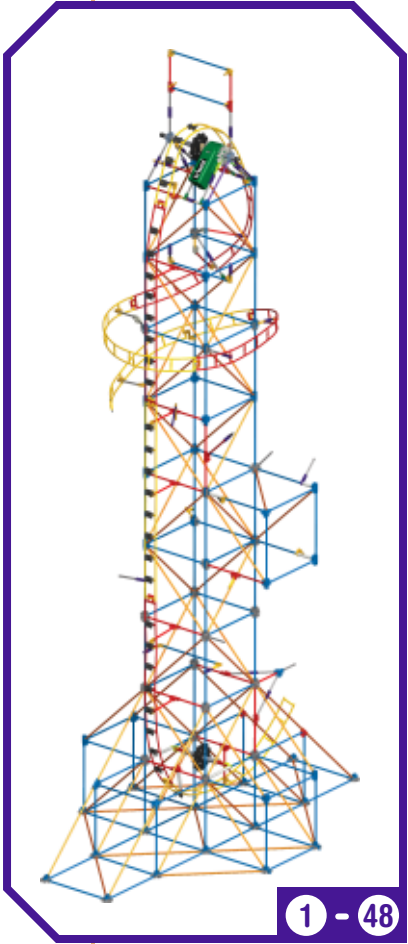
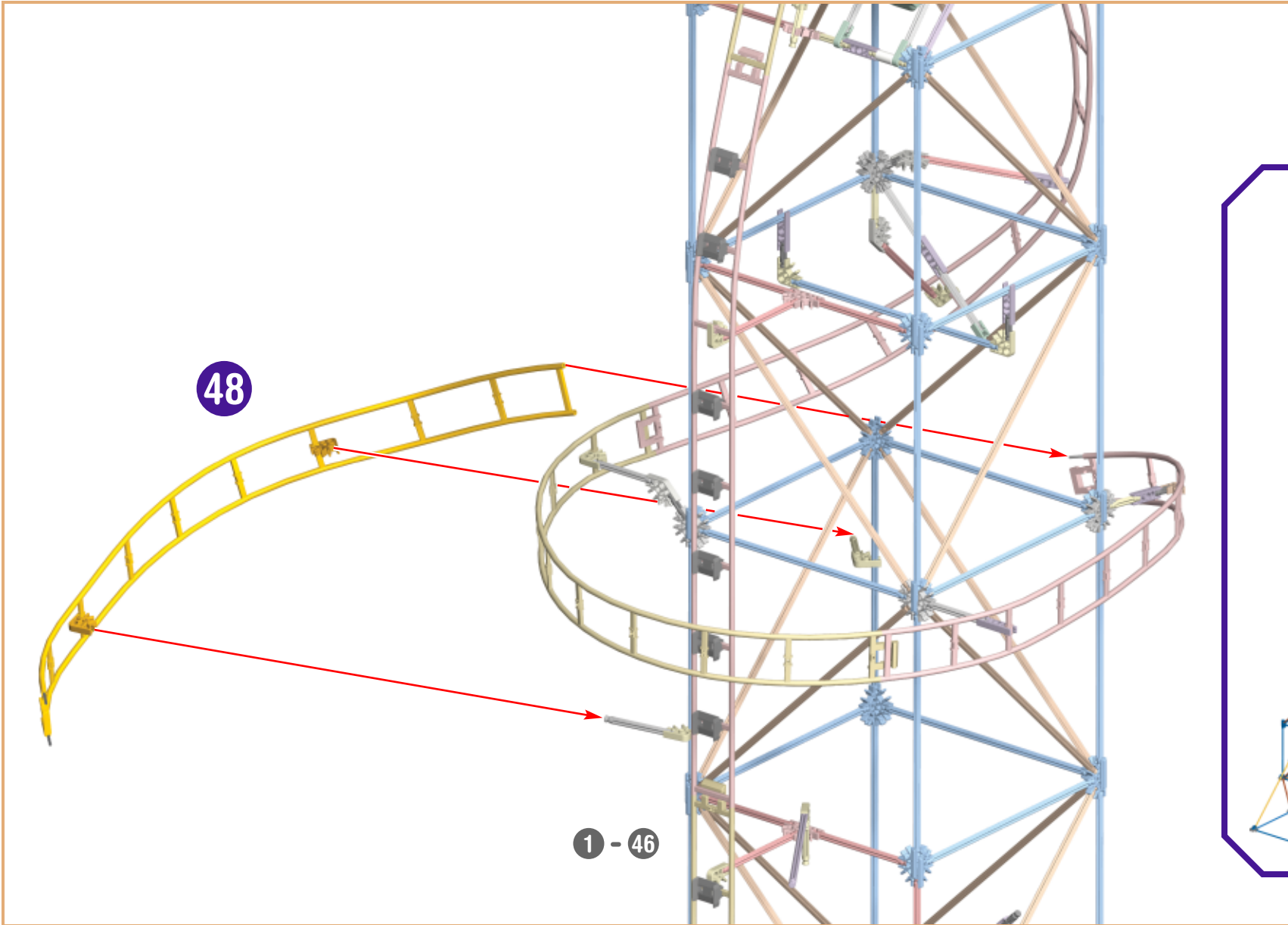
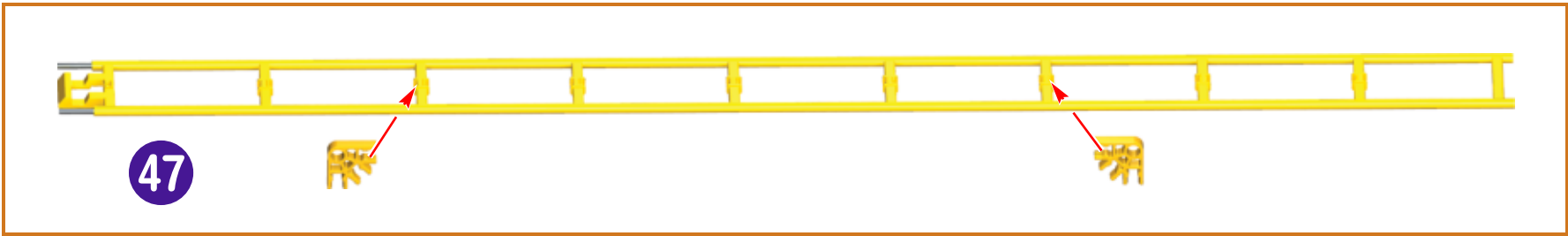

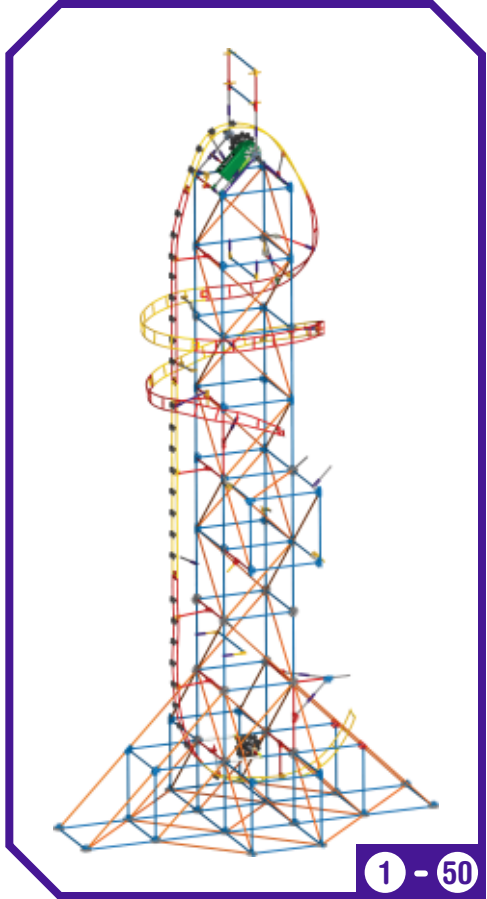
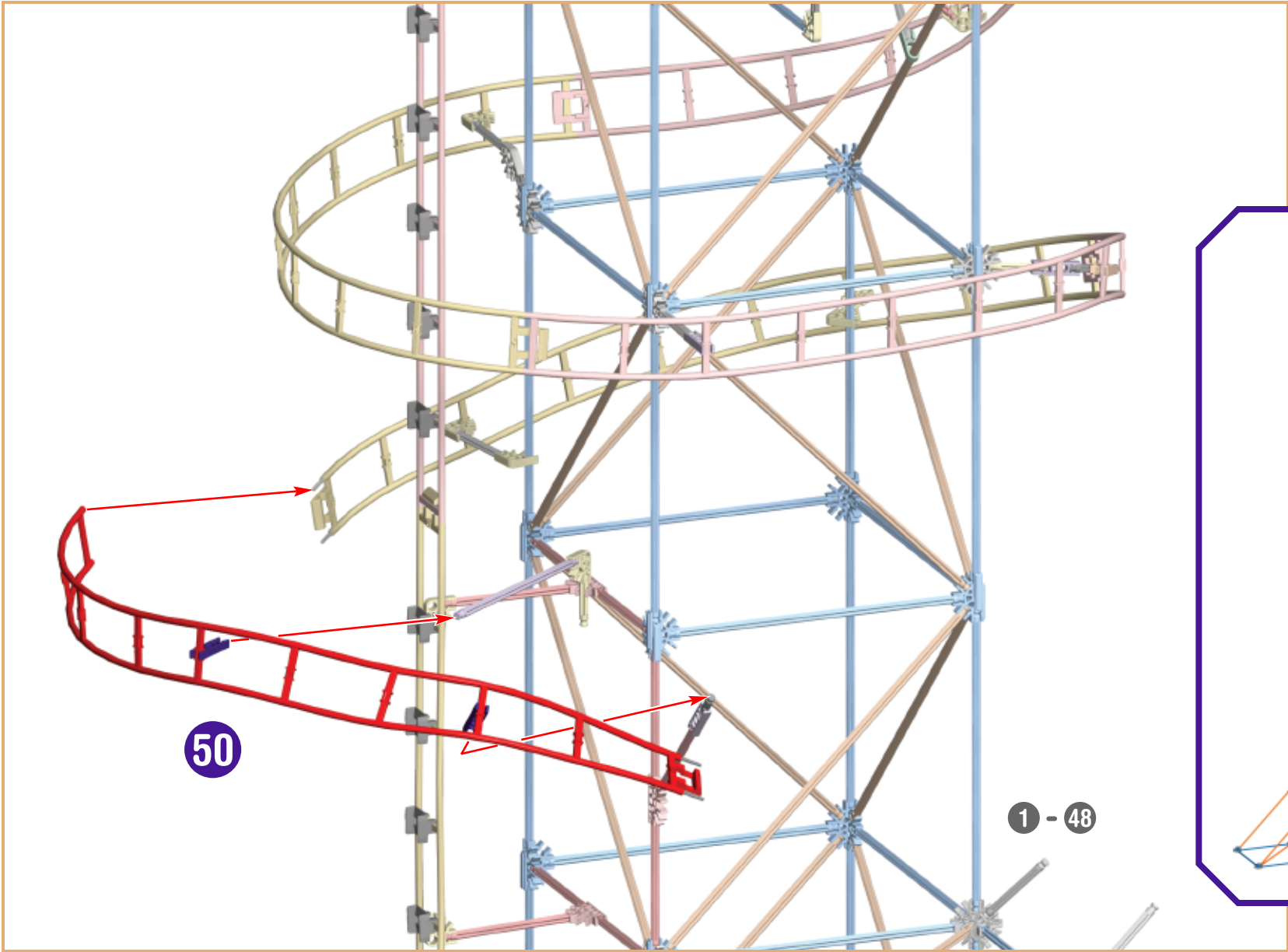
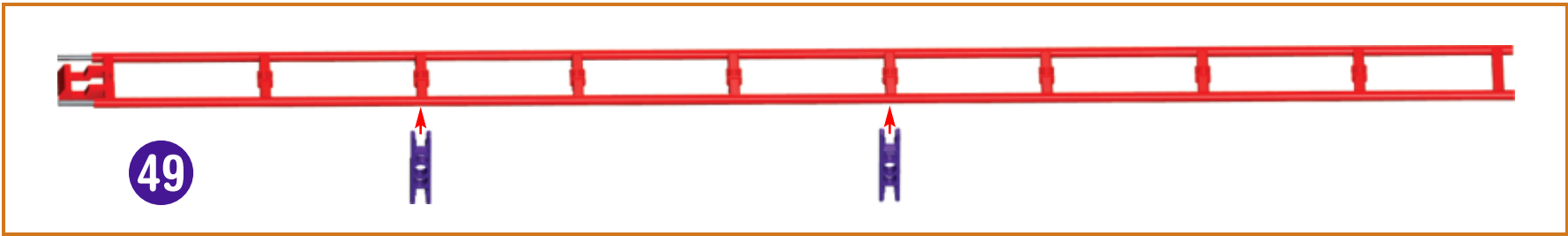

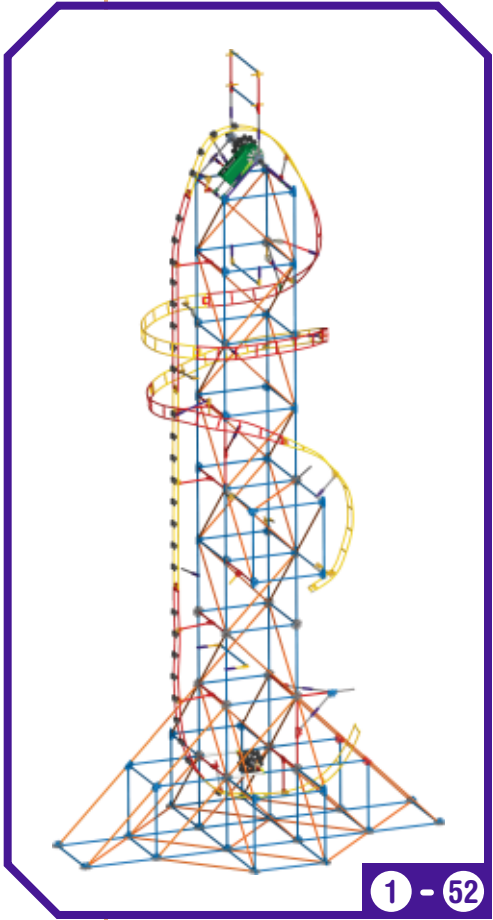
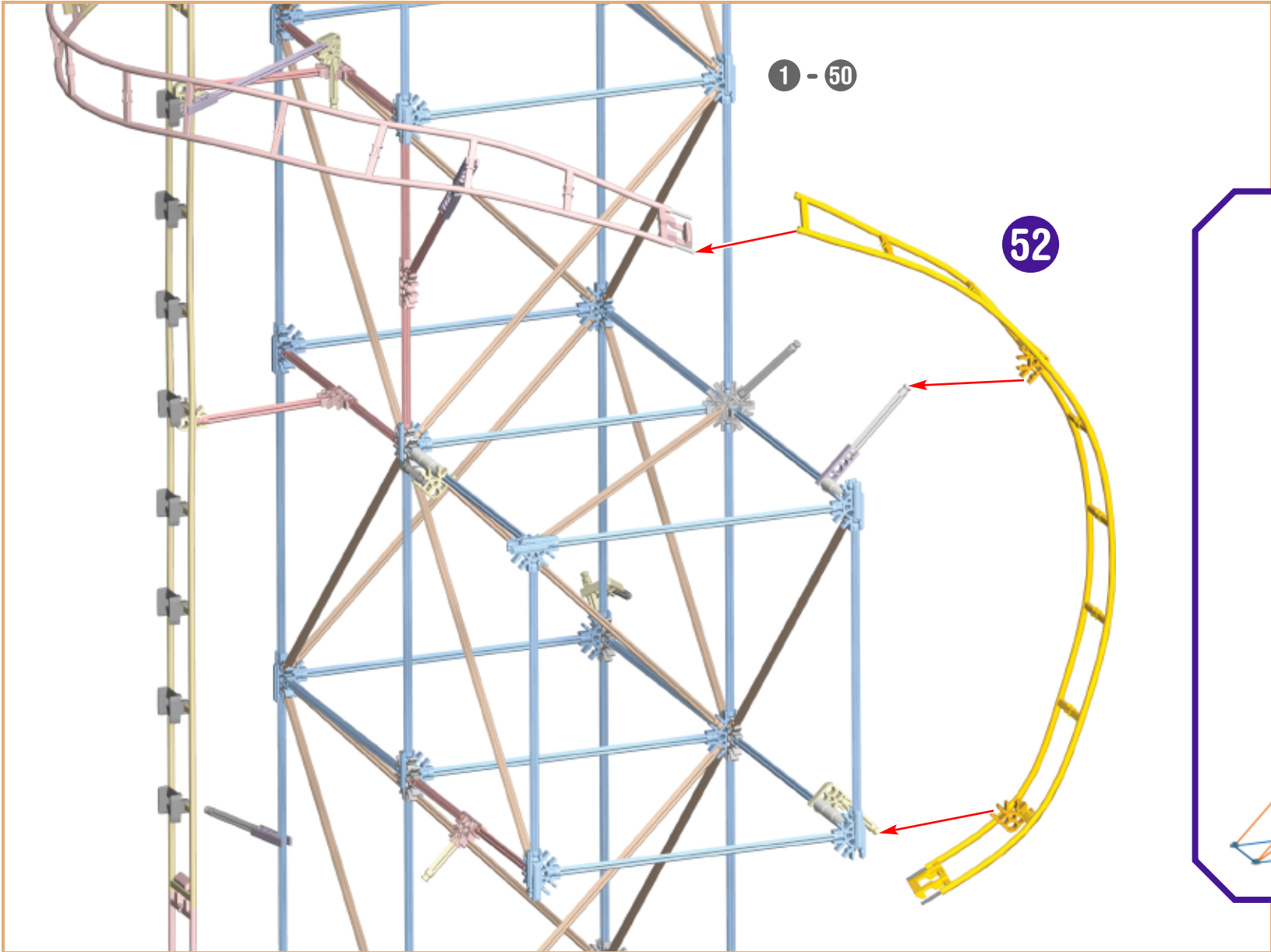
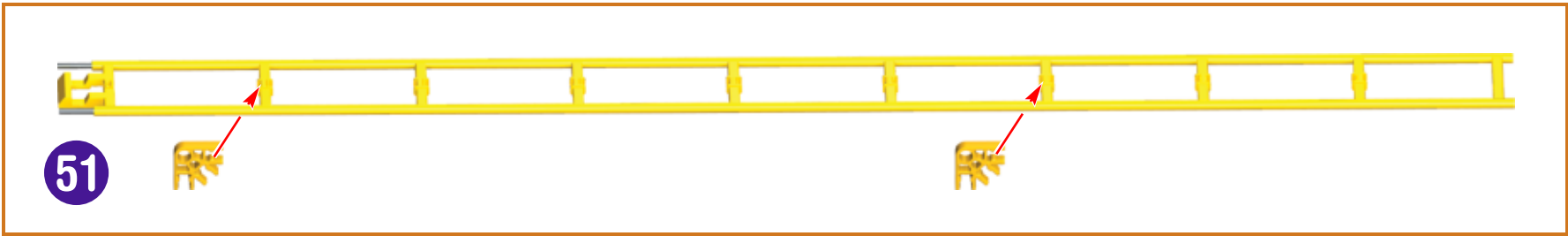

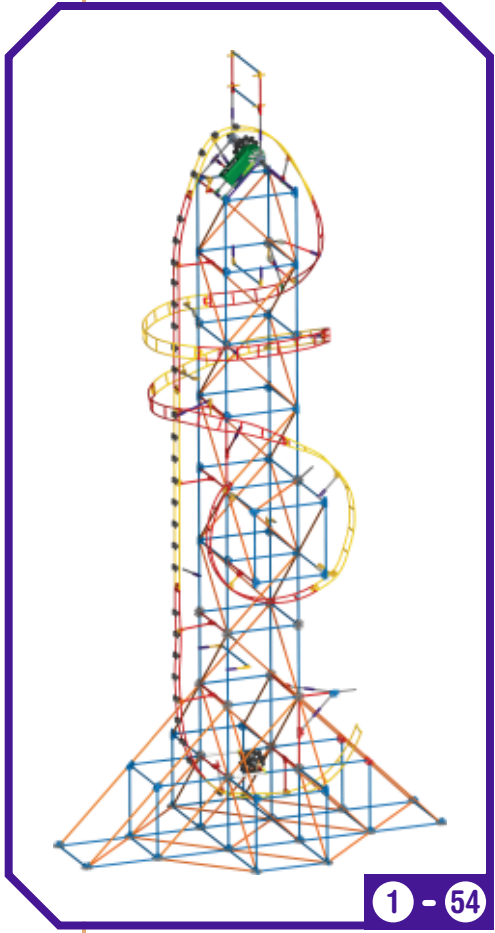
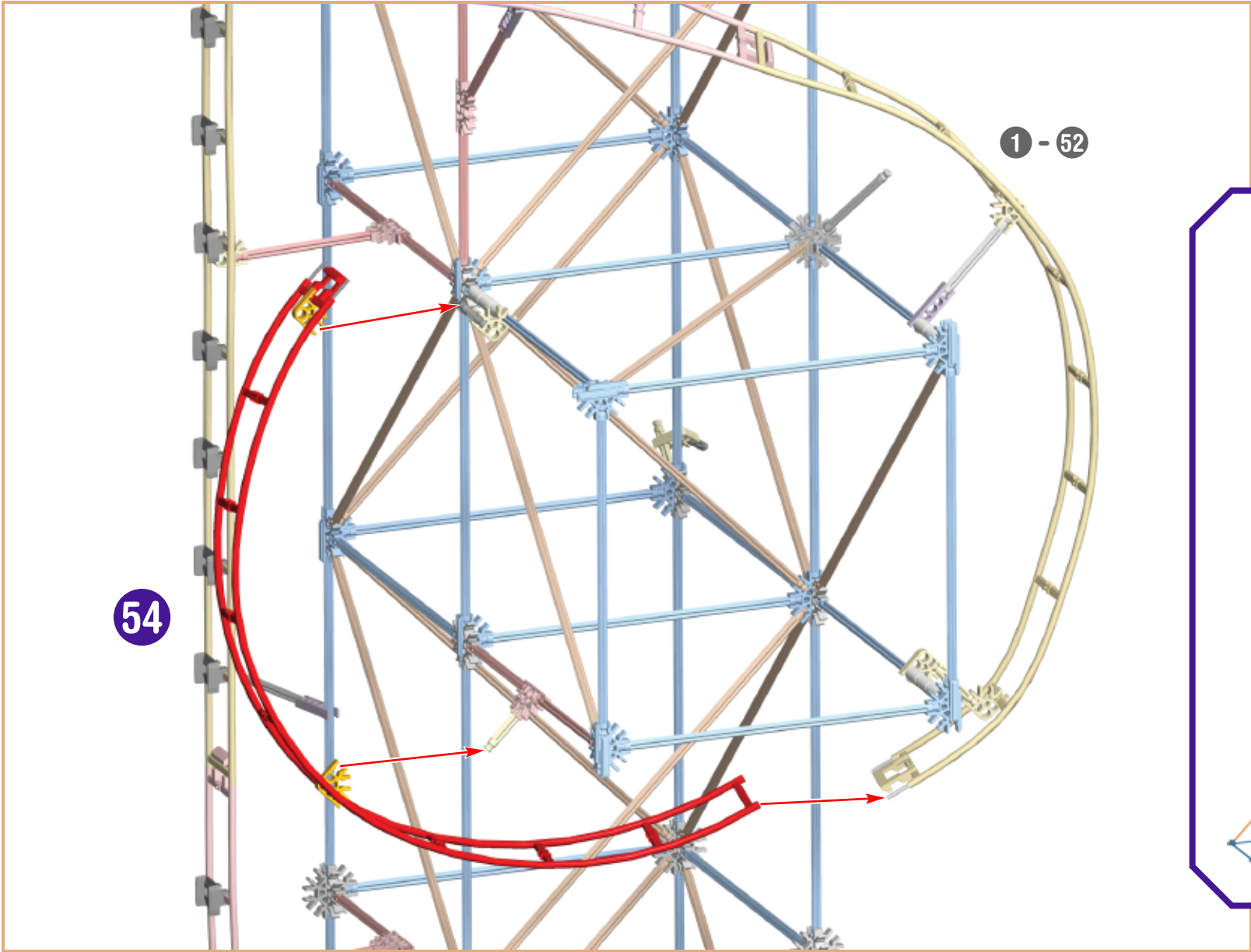
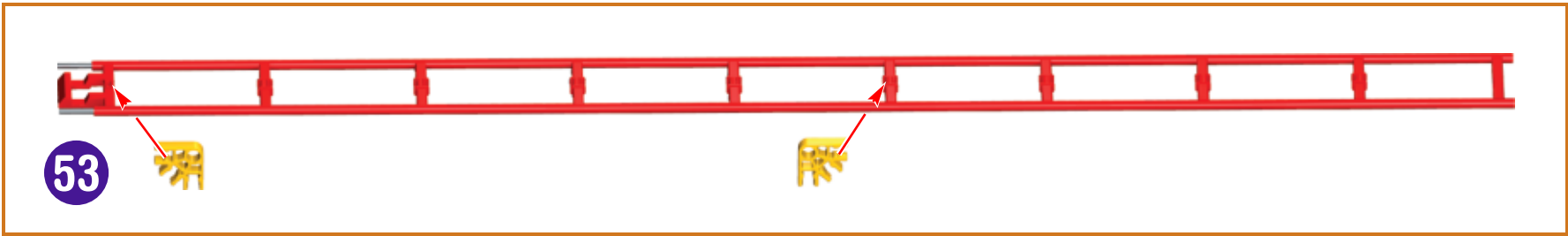

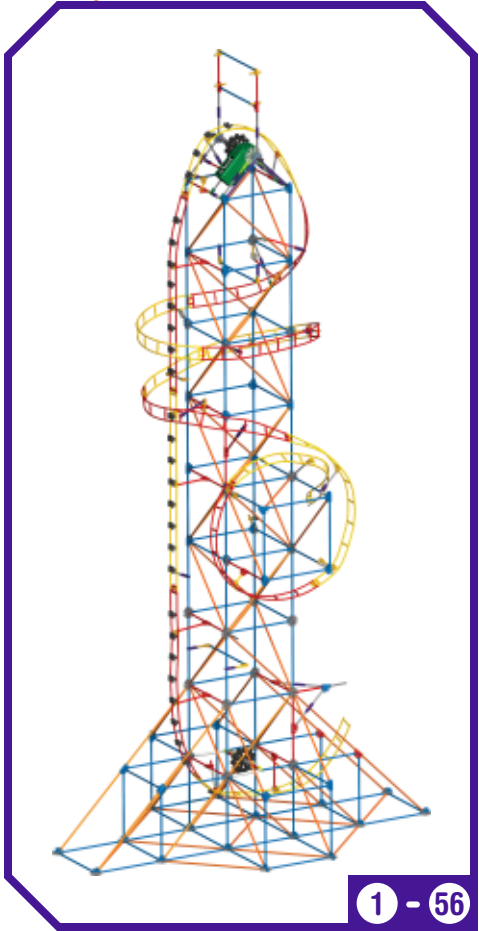
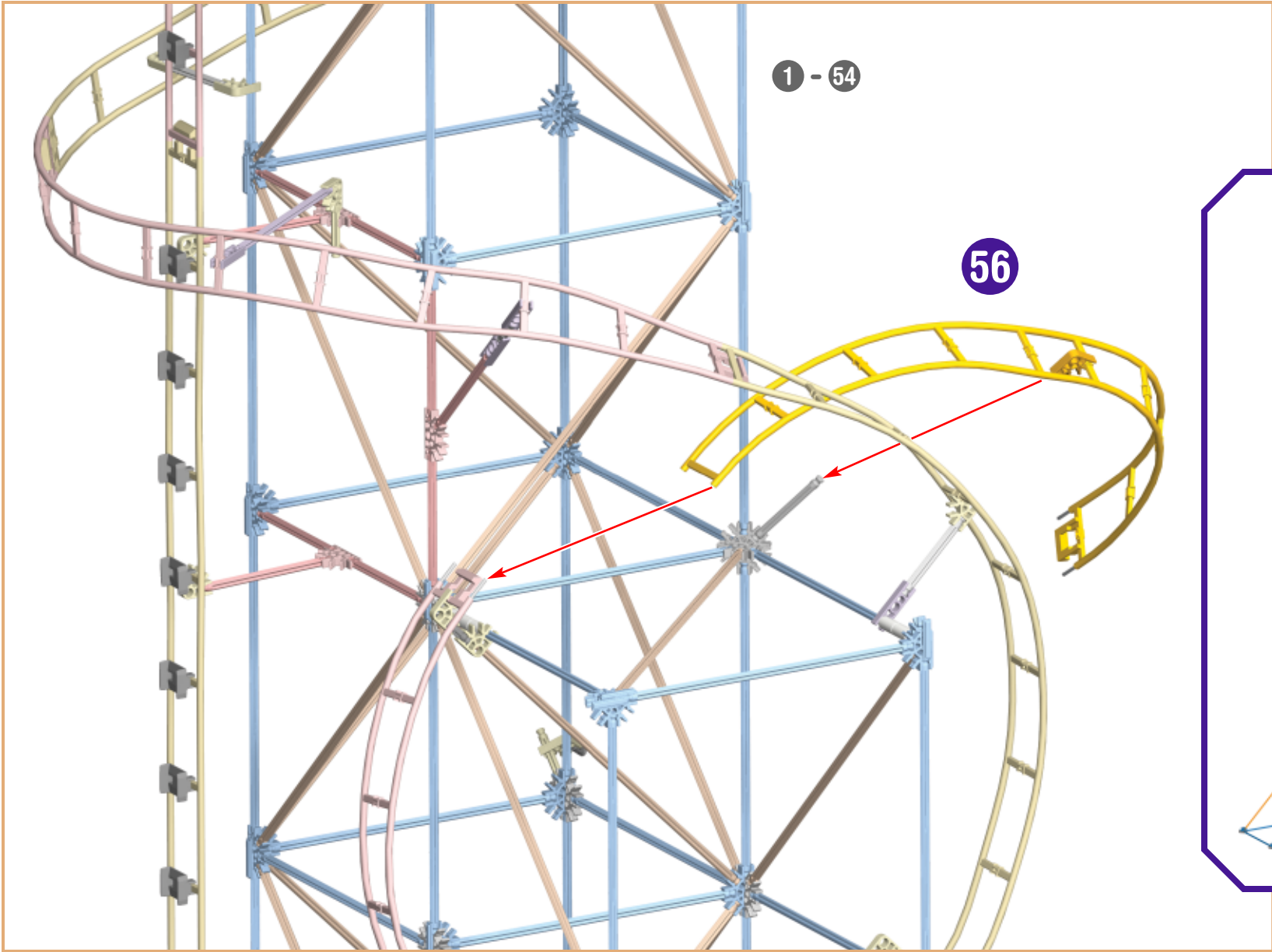
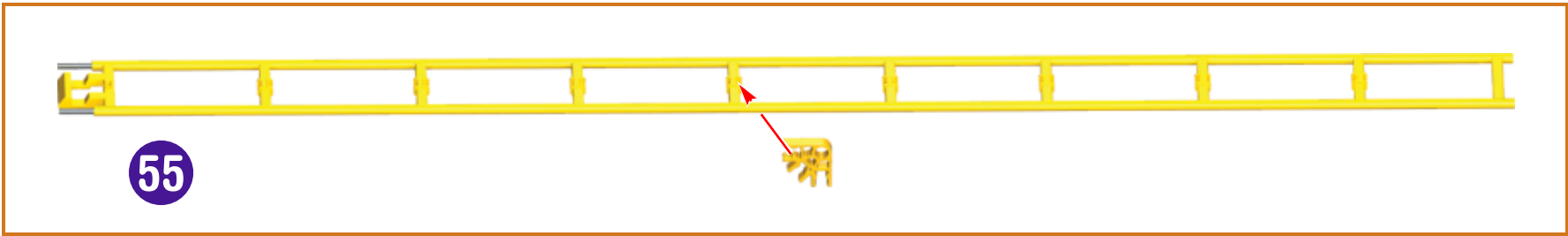

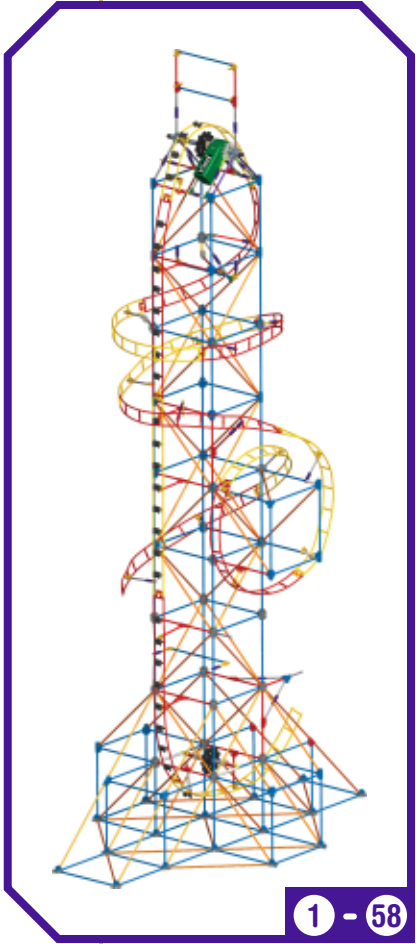
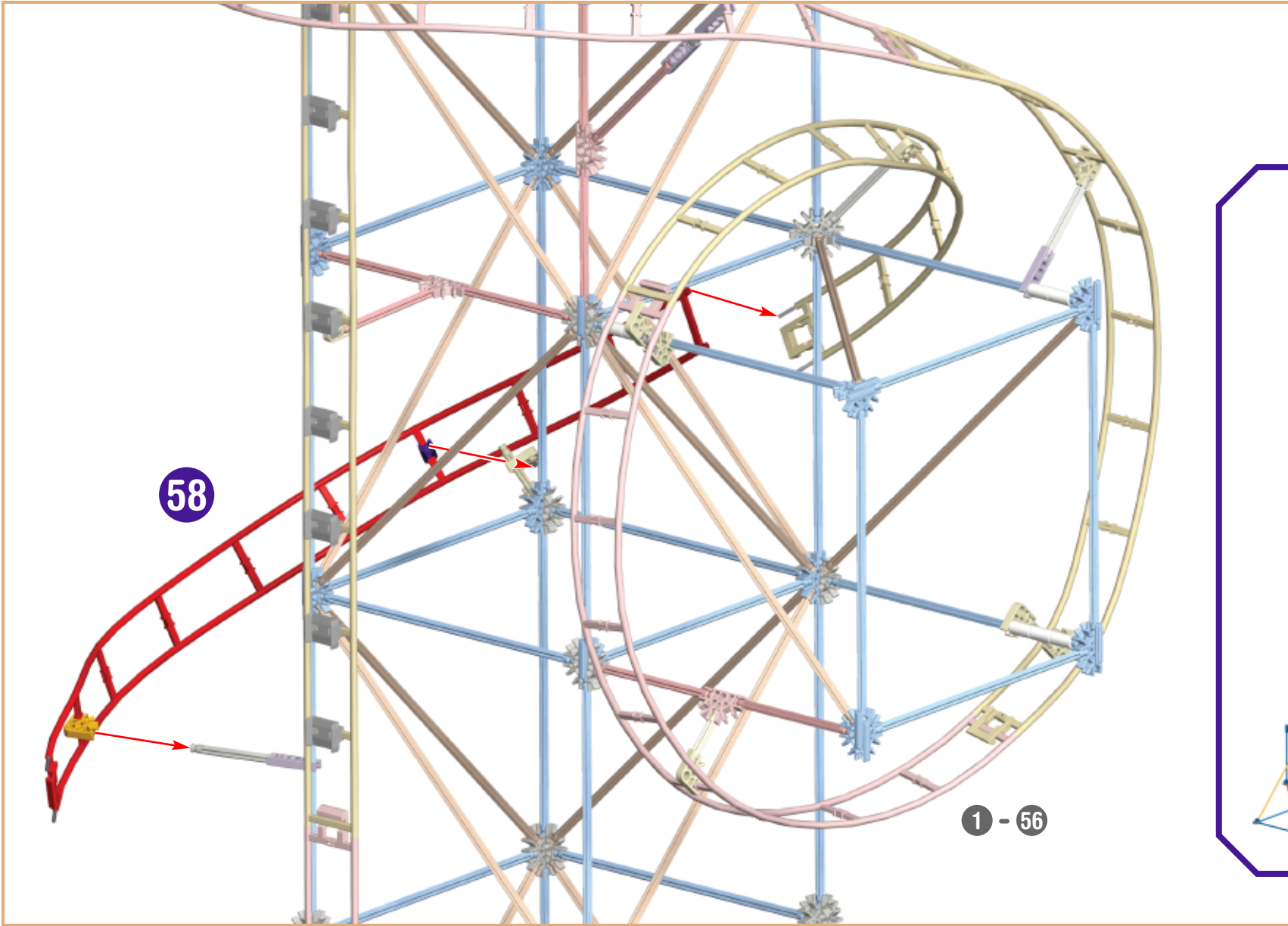
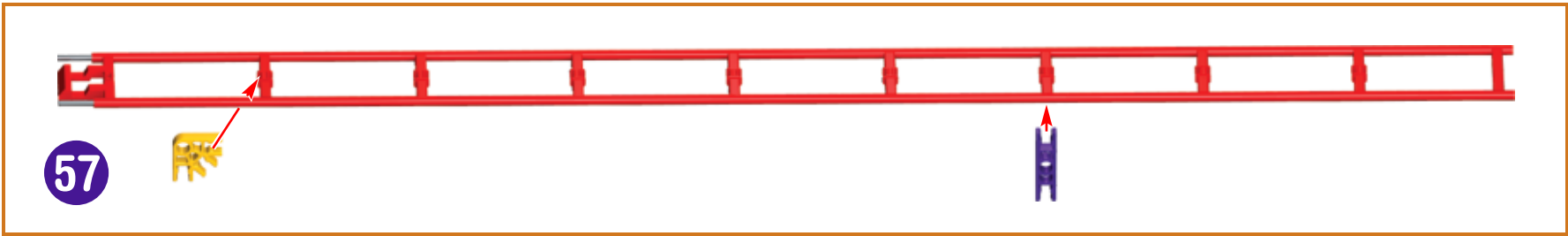

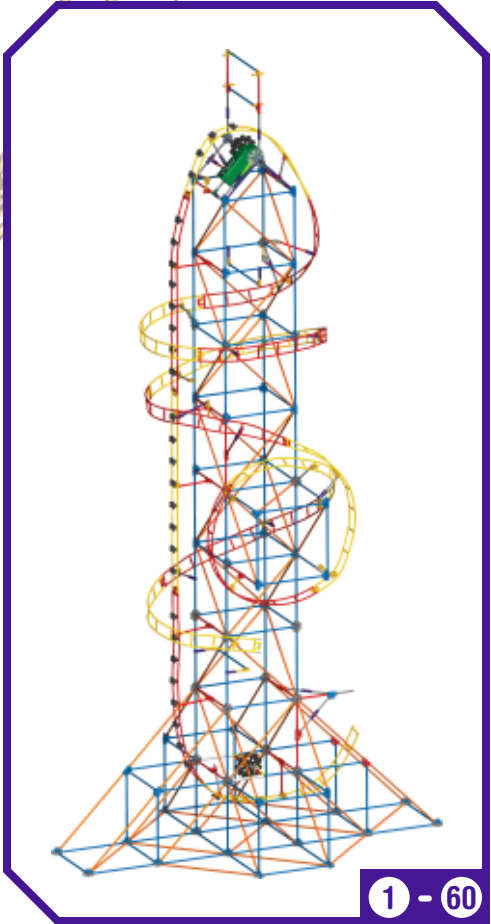
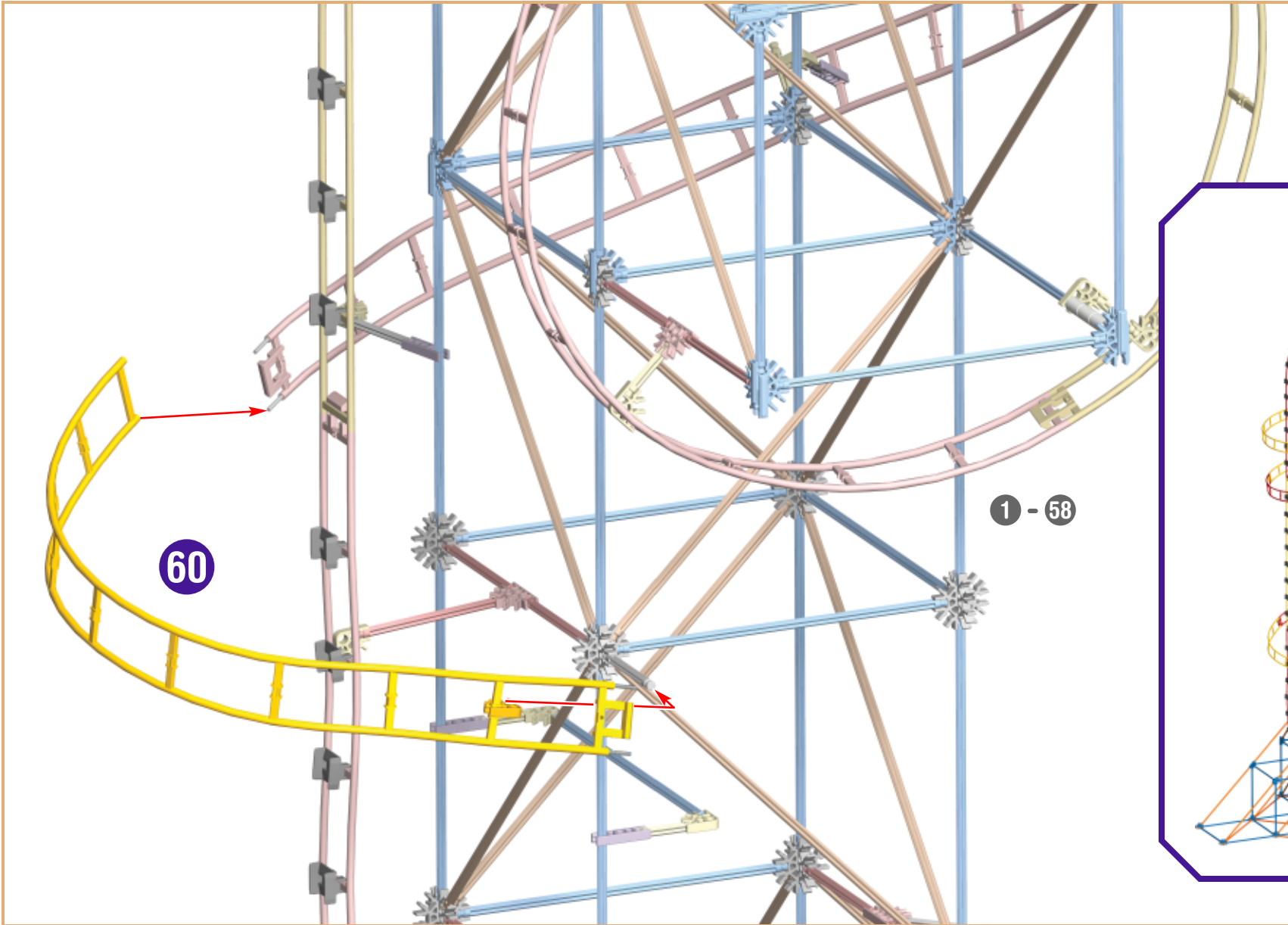
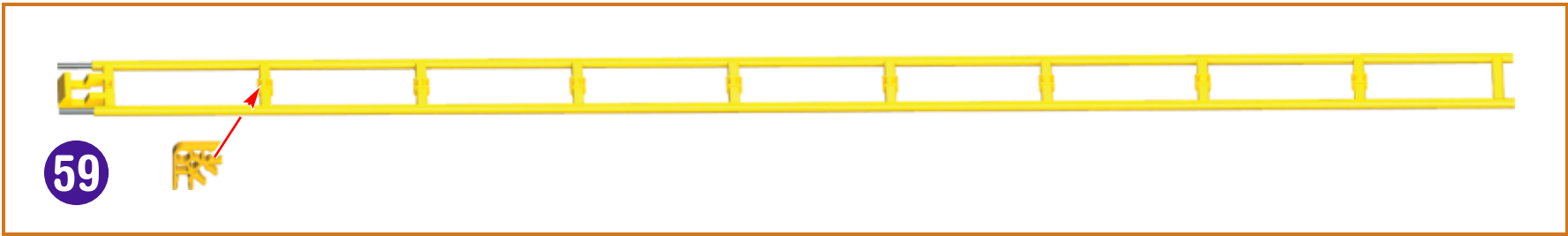

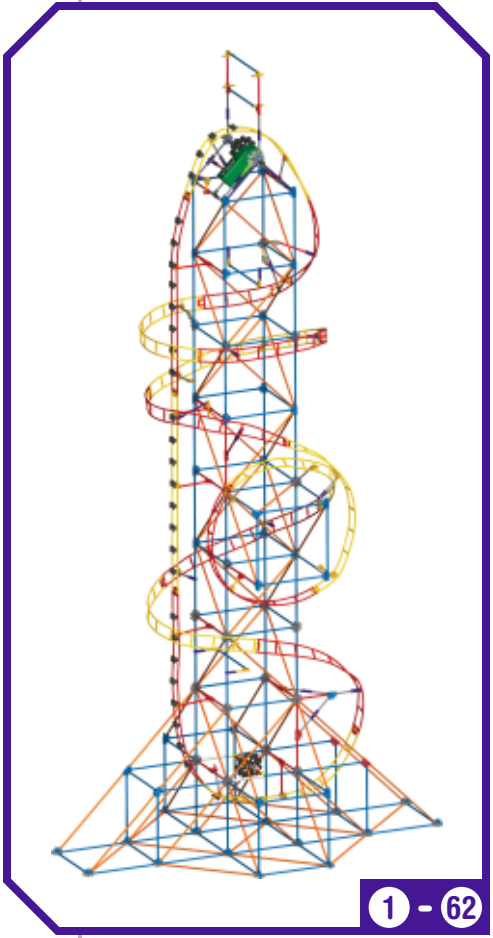
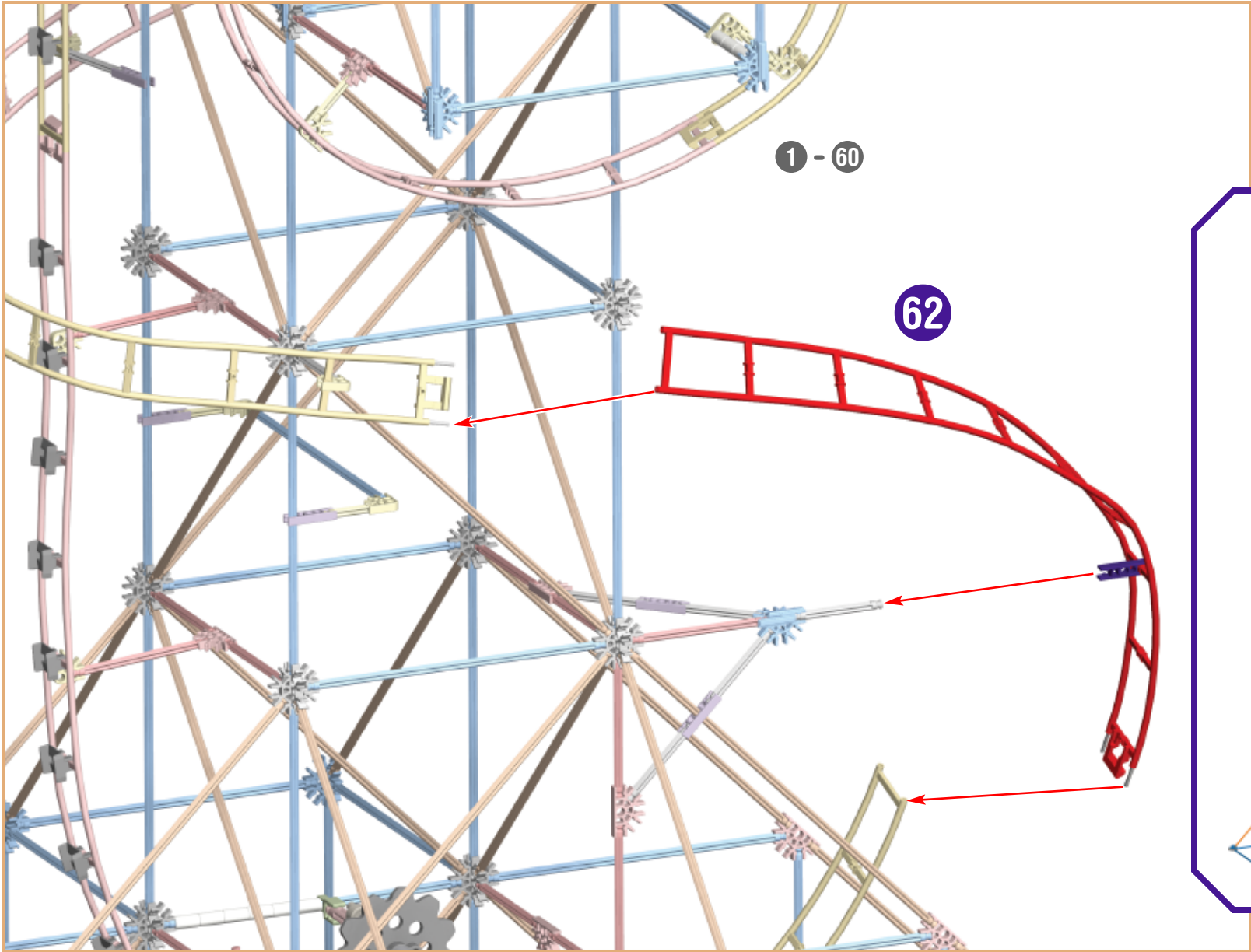
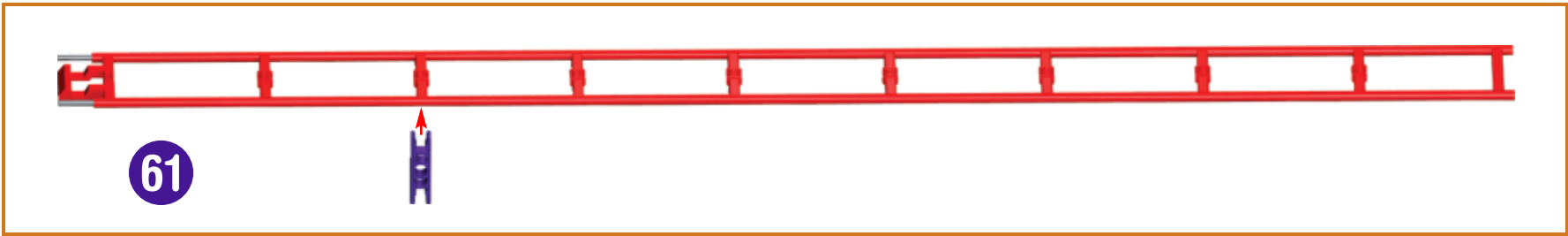

ATTACHING GRAPHIC PANEL

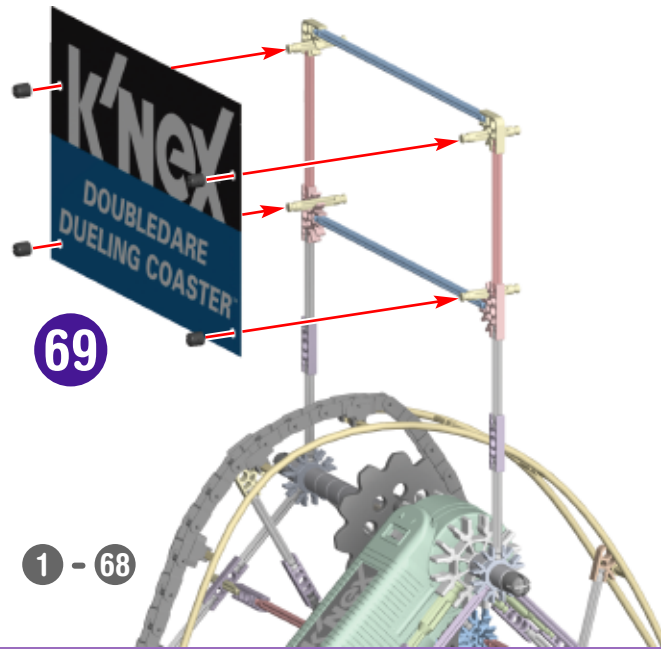

ATTACHING COASTER CARS

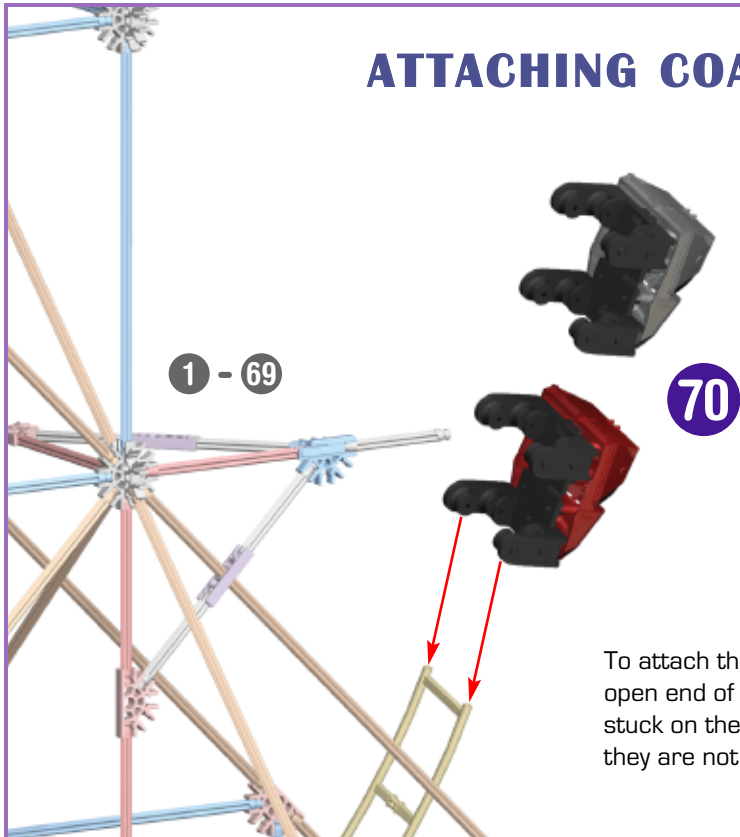

To attach the cars, slide them onto an open end of the track. If the cars get stuck on the way down, make sure they are not hitting any K'NEX parts.

FREEFALL COASTER™

