

DISNEY  
BUILD-IT!

# DISNEY PARKS

AGES  
9+



**MOTOR!**

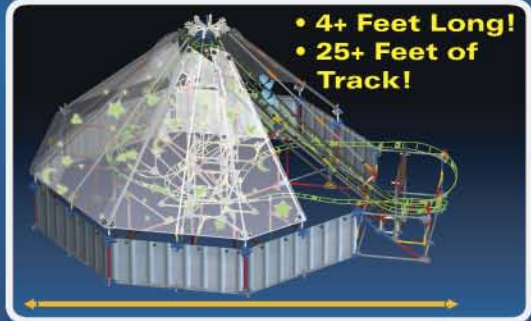

• 4+ Feet Long!  
• 25+ Feet of Track!



Motorized  
Racing  
Action!

60058

**Glow-in-the-Dark Features!**

**4 Figures!**



## Space Mountain<sup>®</sup> Building Set

**WARNING:**  
CHOKING HAZARD - Small parts.  
Not for children under 3 years.

# K'NEX<sup>®</sup>



## Space Mountain<sup>®</sup> Building Set



## IMPORTANT STUFF FOR PARENTS & KIDS

**Keep these instructions in a handy location.  
They contain important safety information.**

**Read all warnings and instructions before you start  
to build and operate the model.**

**⚠ WARNING: CHOKING HAZARD - Small parts. Not for children under 3 years.**

**CAUTION:** Keep hands, face, hair and clothing away from all moving parts.

**CAUTION:** Be careful not to tip the model over. Model should be placed on a flat and hard surface.

- Share the K'NEX experience with your child and make building with K'NEX a family fun adventure.
- Take your time to enjoy the building process. Don't rush!
- While you're building make sure you face your model in the same direction as the pictures show in the instructions.
- Product and colors may vary.

## BATTERY INFORMATION

### Caution: To Avoid Battery Leakage

- Be sure to insert the batteries correctly and always follow the toy and battery manufacturers' instructions.
- Do not mix old and new batteries or alkaline, standard (carbon-zinc) or rechargeable (nickel-cadmium) batteries. Only batteries of the same or equivalent type recommended should be used.
- Always remove weak or dead batteries from the product; do not short-circuit supply terminals.
- Insert batteries with correct polarity (+/-) as shown.

### Important Tips

- Alkaline batteries AA (LR6) are recommended.
- Rechargeable batteries are not recommended.
- Remove rechargeable batteries from toy before charging; they must be charged only under adult supervision.
- Non-rechargeable batteries must not be recharged.
- Keep components free of dust; do not immerse or use in water.
- Do not dispose of batteries in a fire; they could leak or explode and cause injury.
- Remove all batteries if the toy will not be used for a long period of time.
- Do not put rods smaller than 2 inches in any openings of the motor; they will damage the motor, and cannot be removed.
- Help the environment by disposing of your product and packaging responsibly. The wheelie bin symbol indicates that the product and batteries must not be disposed of in the domestic waste as they contain substances which can be damaging to the environment and health. Please use designated collection points or recycling facilities when disposing of the item or batteries.

### How to Insert and Remove Batteries

- Use a small Phillips head screwdriver to loosen the screw. Insert 2 fresh AA batteries (LR6) into the compartment with the correct polarity (+/-) as shown here.

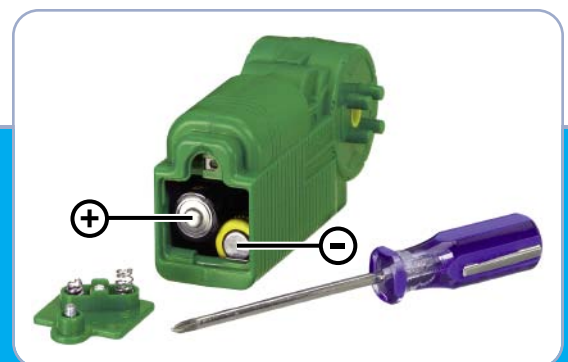

Disney.com  
Disney Theme Park Merchandise  
Lake Buena Vista, FL 32830  
©DISNEY

Go to **KNEX.COM** for Instruction Updates

# K'NEX BUILDING BASICS

## Start Building

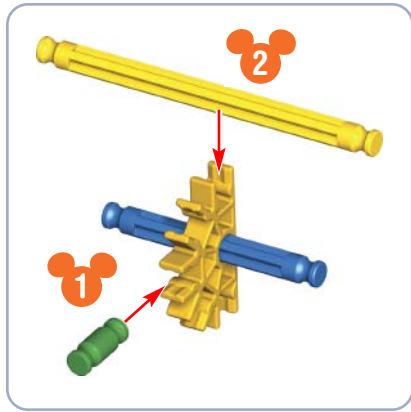

To begin your model, find the **1** and follow the numbers. Each piece has its own shape and color. Just look at the pictures, find the pieces in your set that match and then connect them together. Try to face your model in the same direction as the instructions while you build. The arrows show you where the parts connect, but not all connections points have arrows.

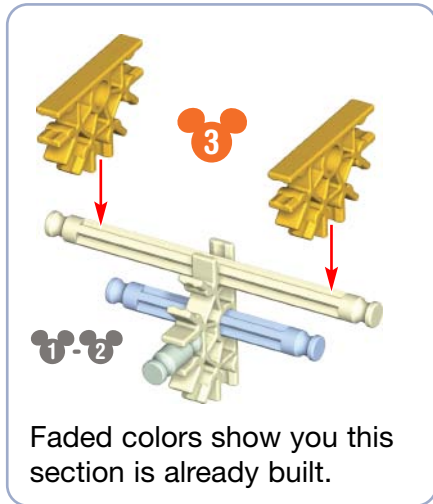

## Parts List

Before you start building, be sure to compare the parts in your set with the parts list here. If anything is missing, call or write to us using the information on the back cover. We are here to help you!

35	2	47	12	4	86
89		32			
49		69	44	43	82
48			20	40	11
68					
111					
14	38	4			
244	5	40	12		
2	3	37	17		
5			6		

**FABRIC PANELS**

See page 73 for attaching to model.

## Spacers

There are places in your model where you need to add blue and silver spacers. Be sure to use the right color and count them carefully.

## Panels/Stickers

See pages 67, 68 and 74 for attaching to model.

## Connectors

There are blue and gray connectors with special long slots. They slide together as you see in the pictures. Push these parts together until you hear a "click."

## Figure Assembly



Space Mountain®  
Building Set

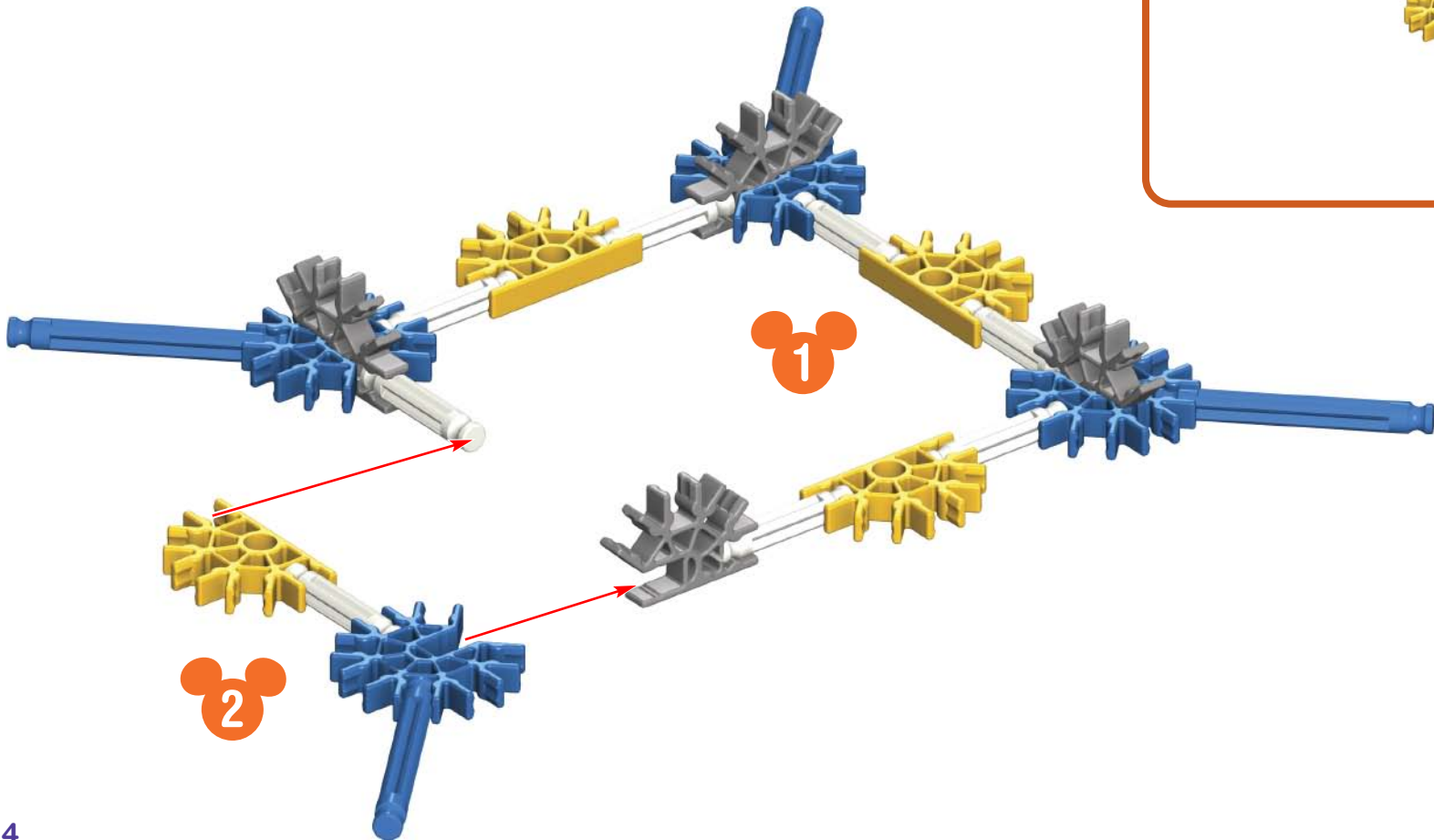
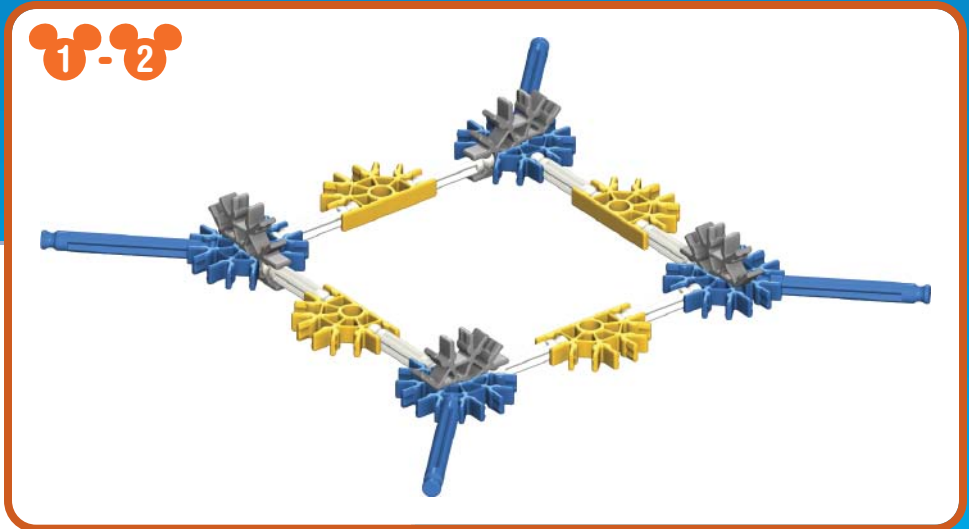

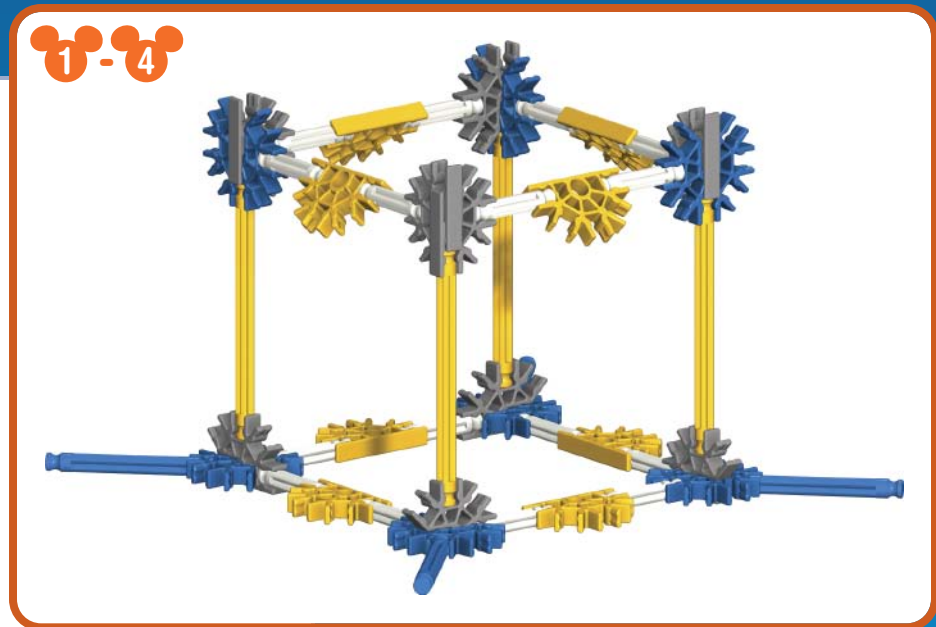
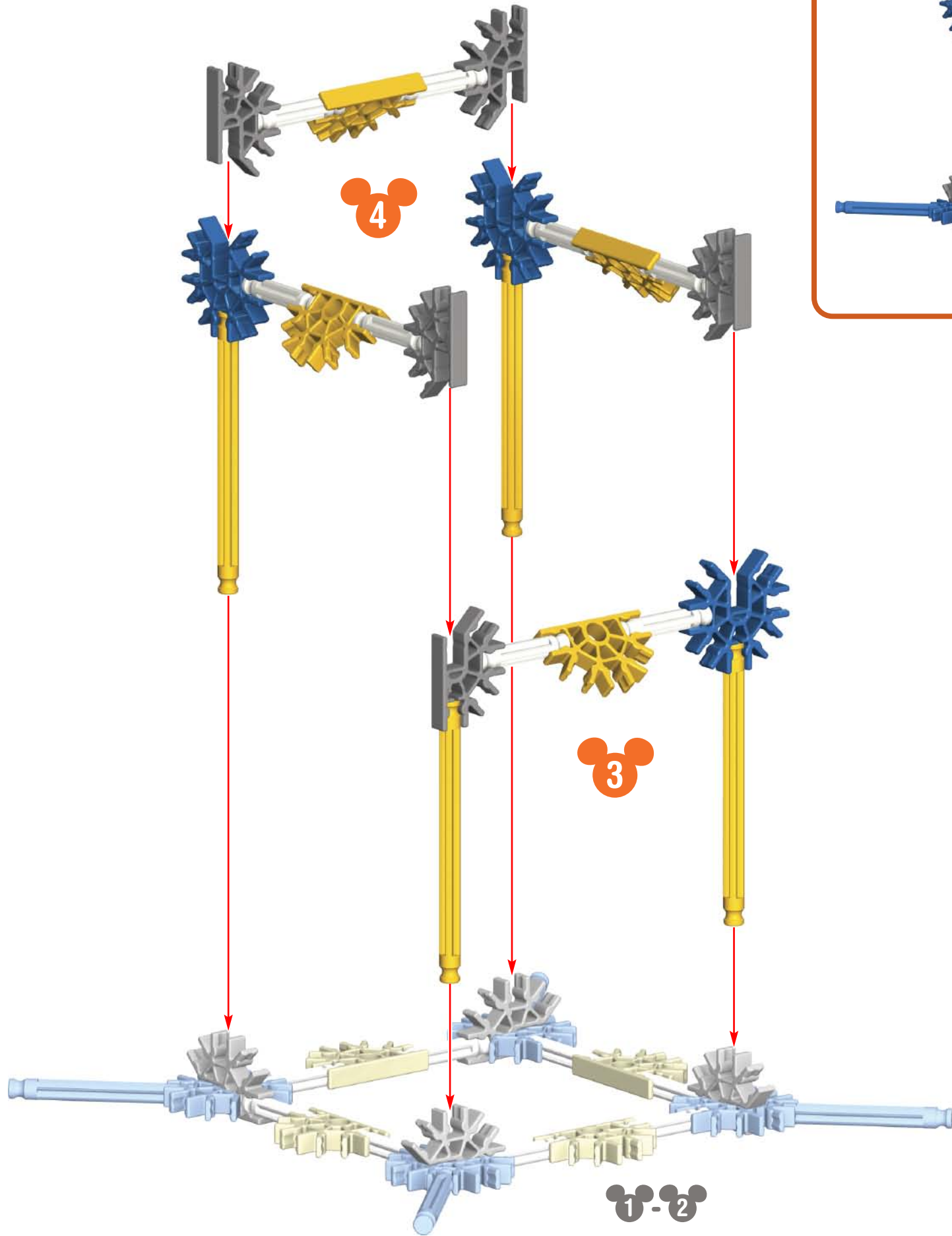

1-6

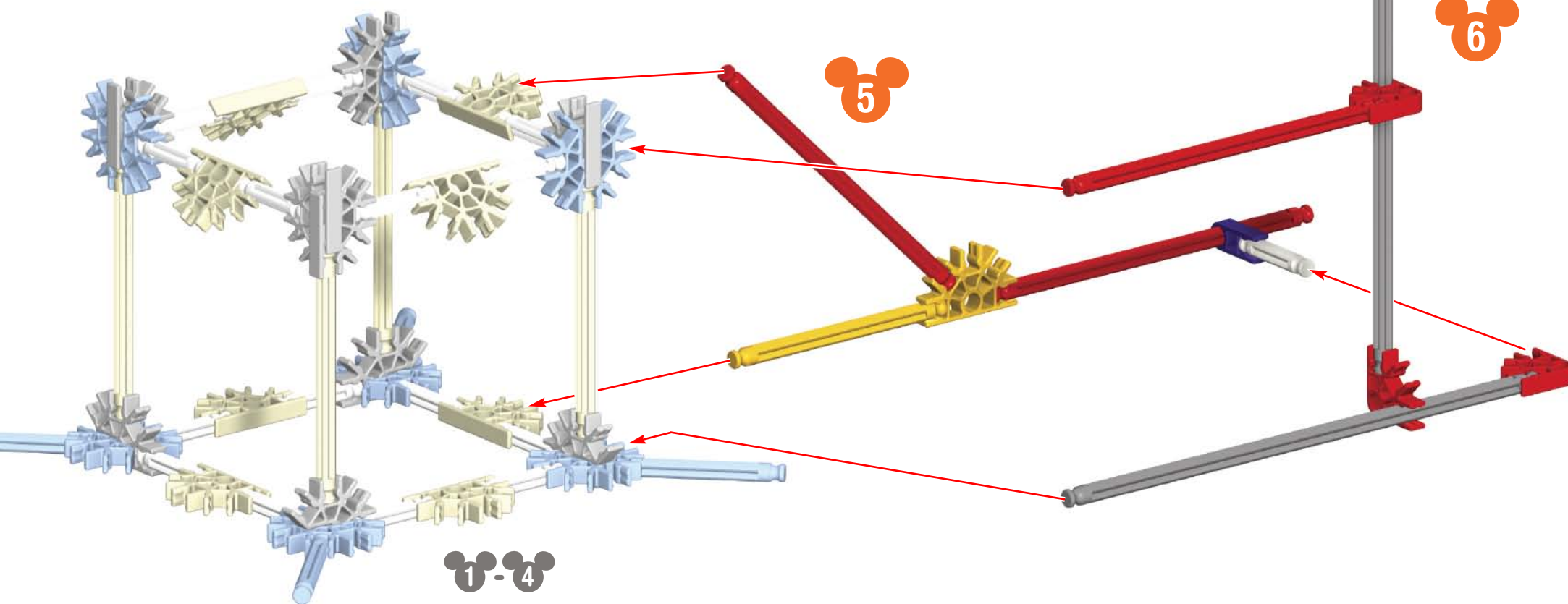
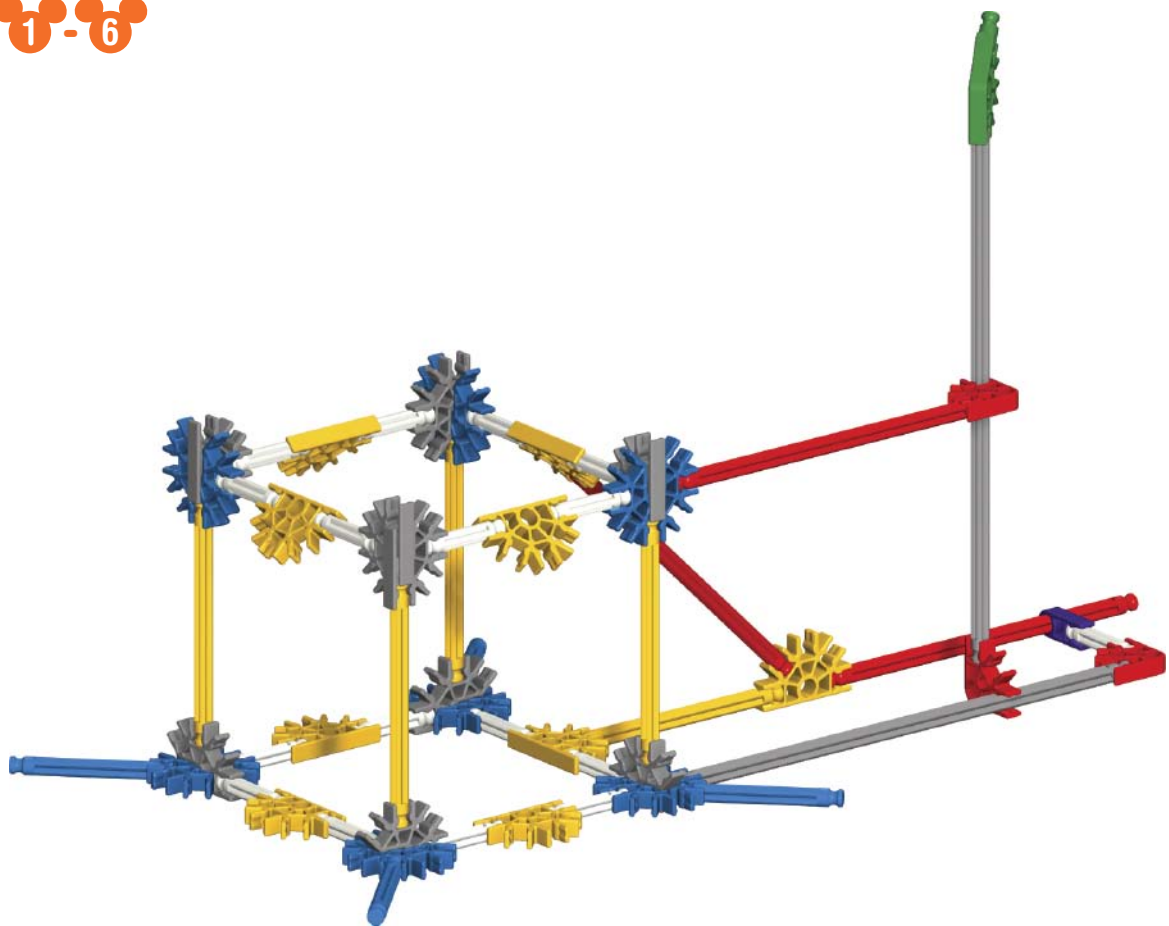

5

6

1-4

1-8

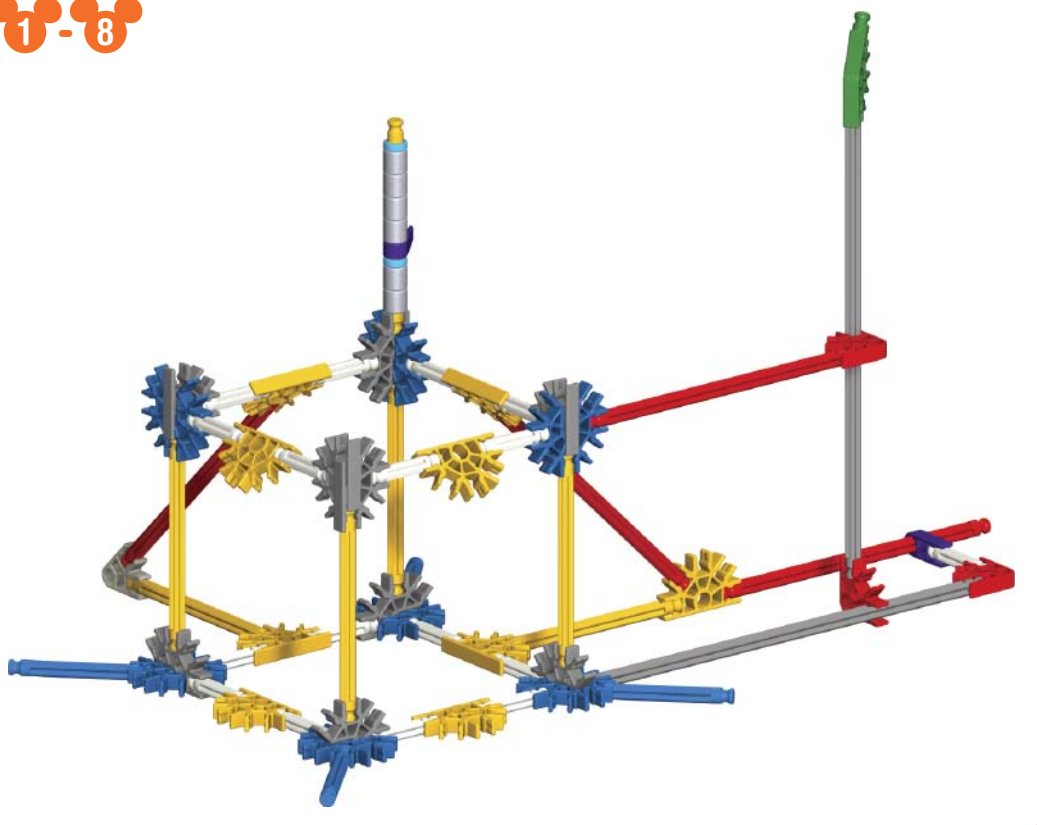

8

7

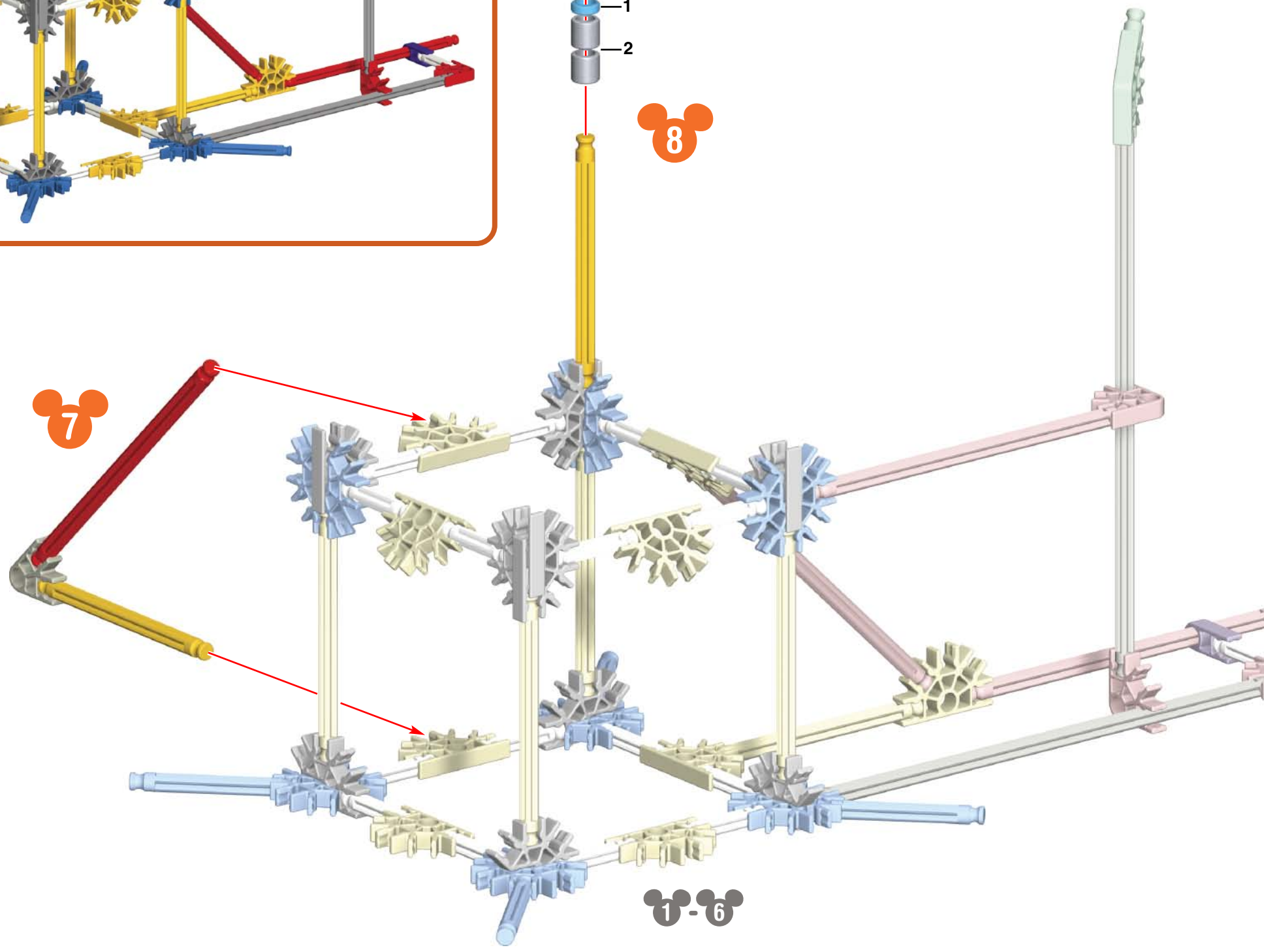

1-6

1-10

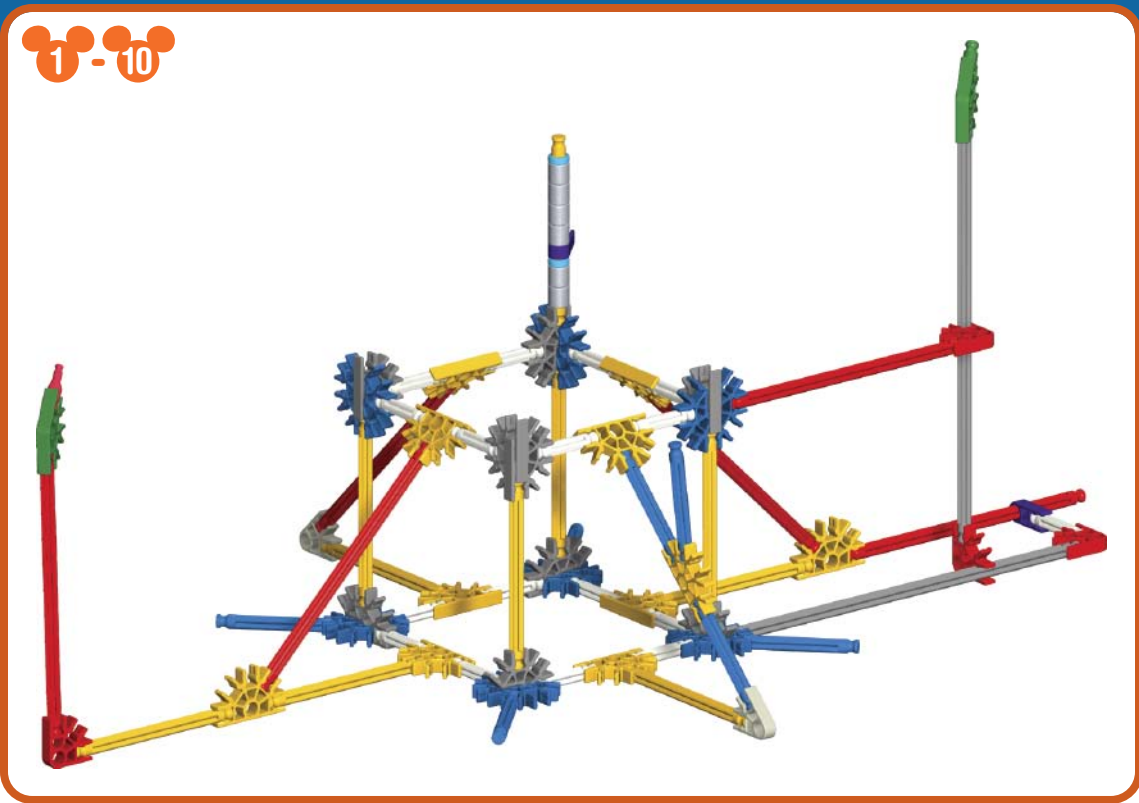

1-8

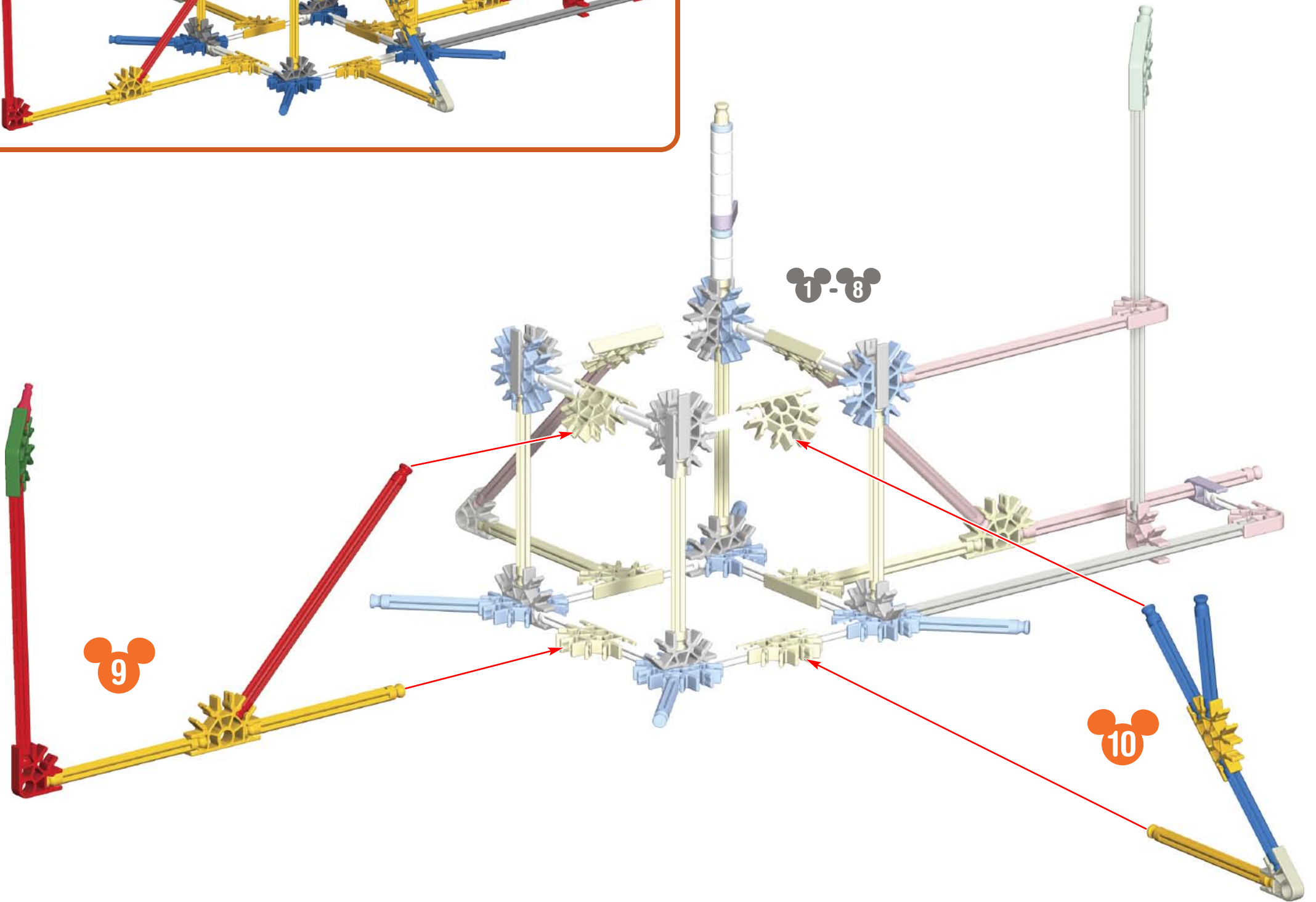

9

10

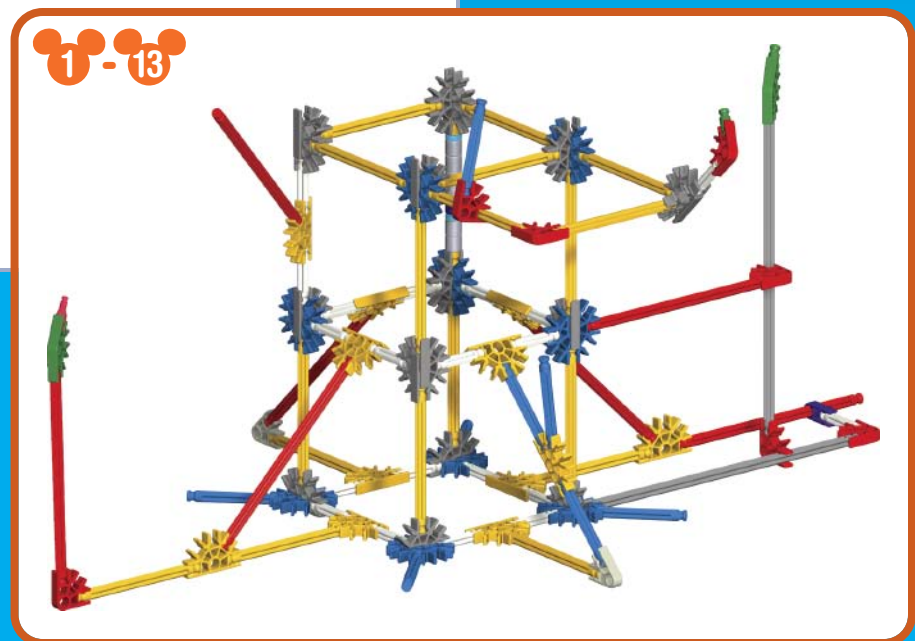
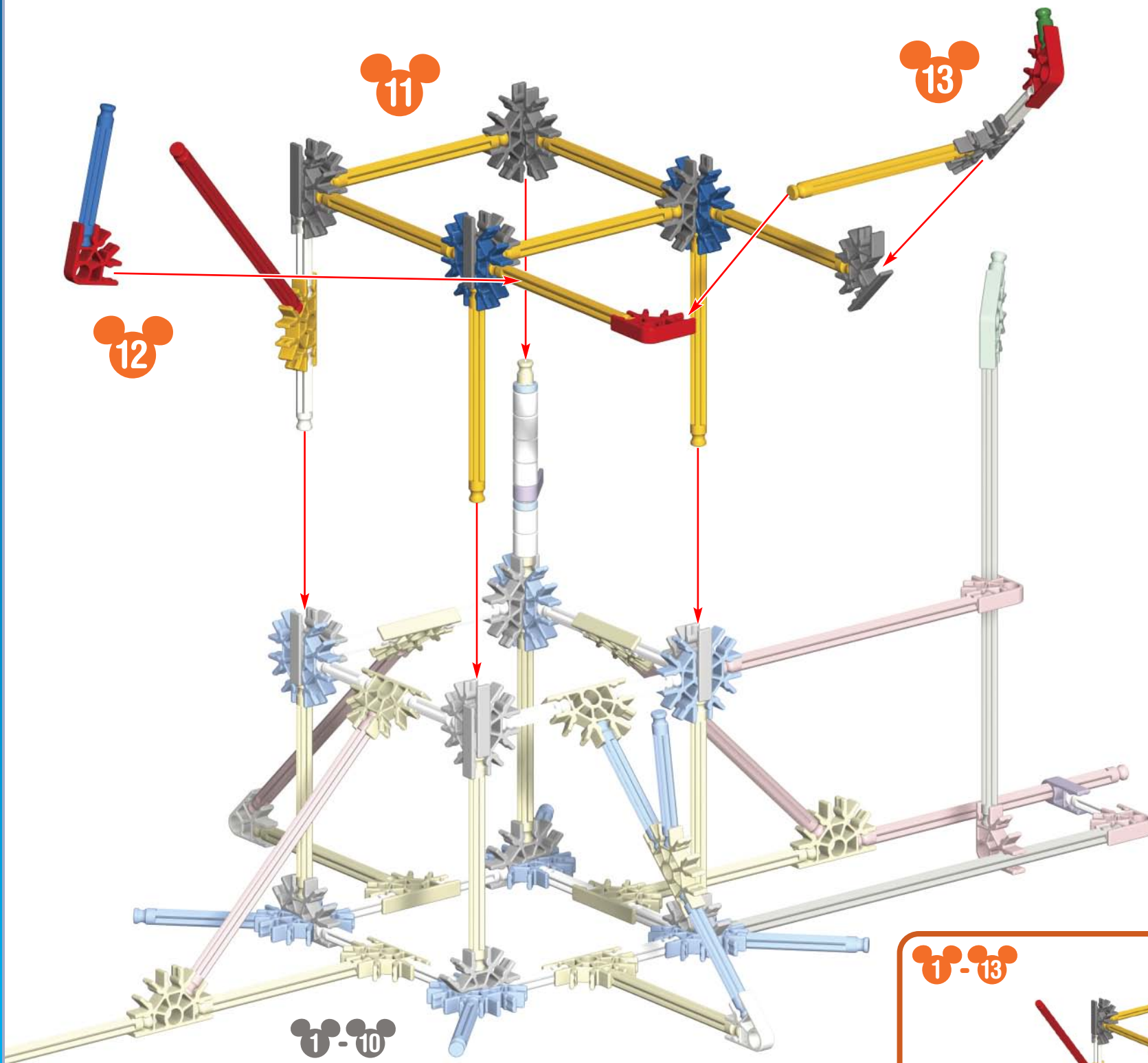

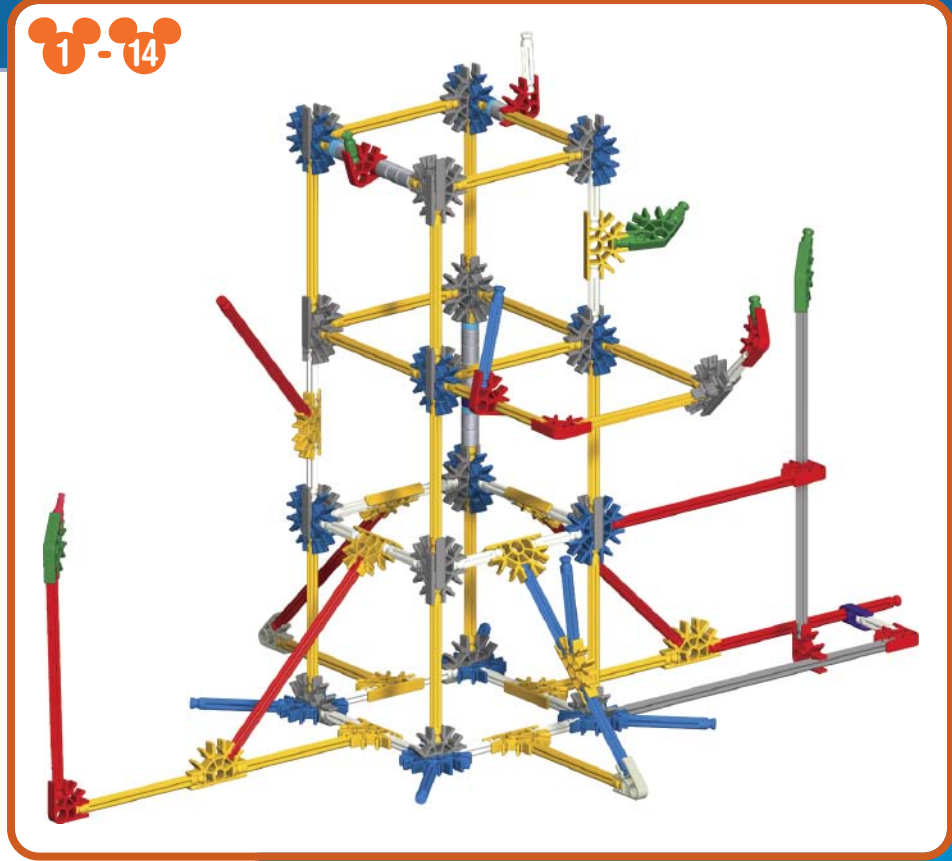
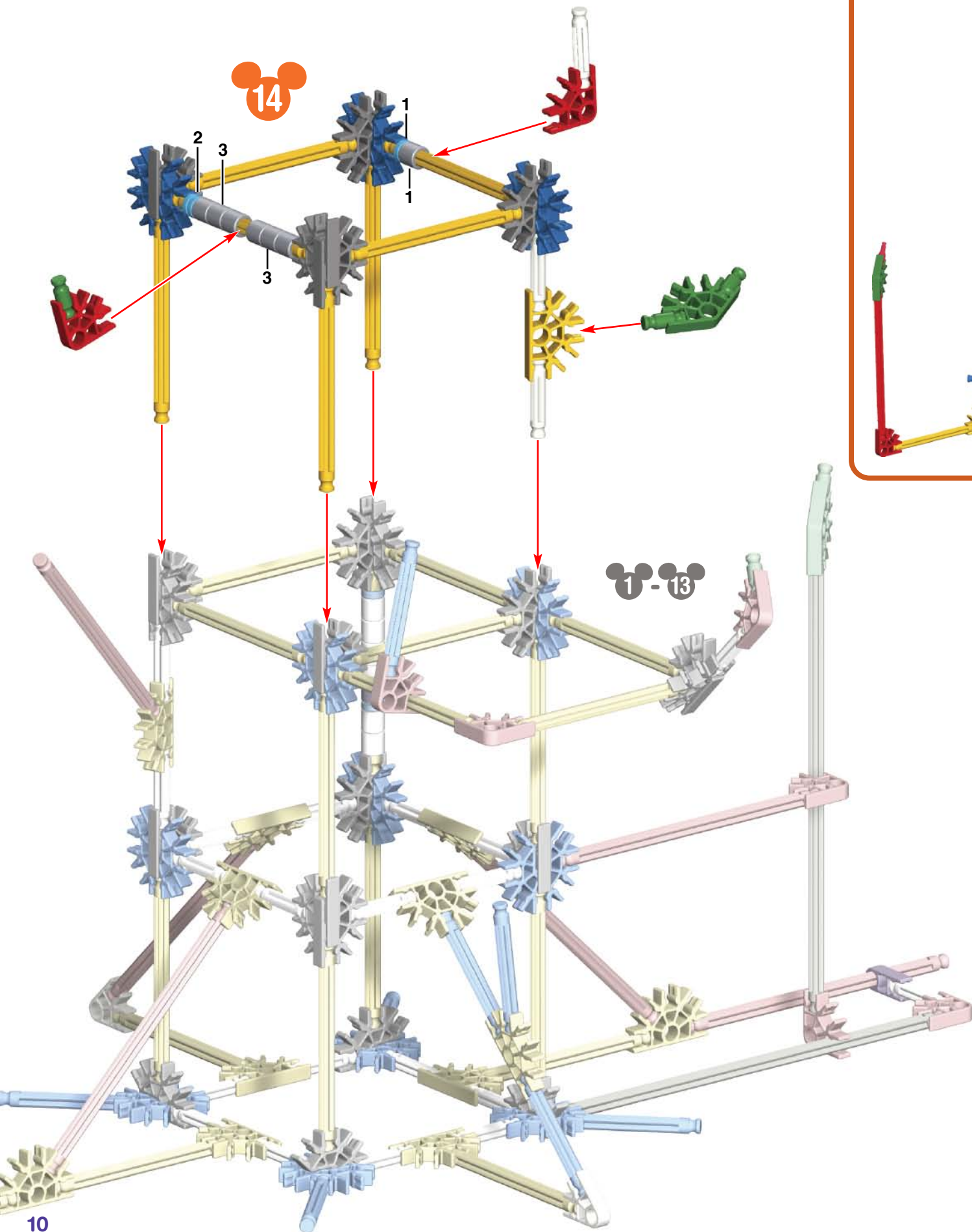

1-13

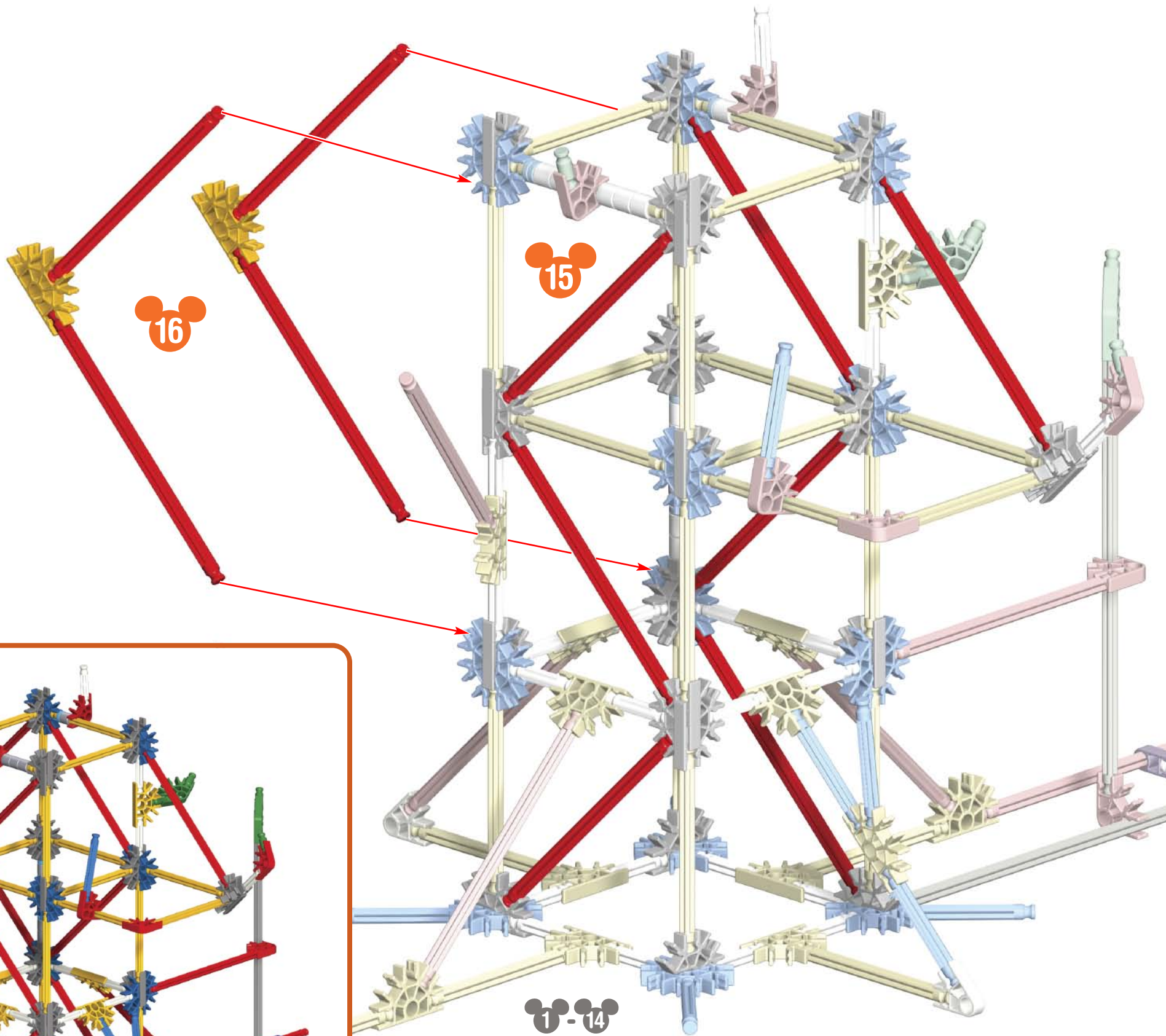

16

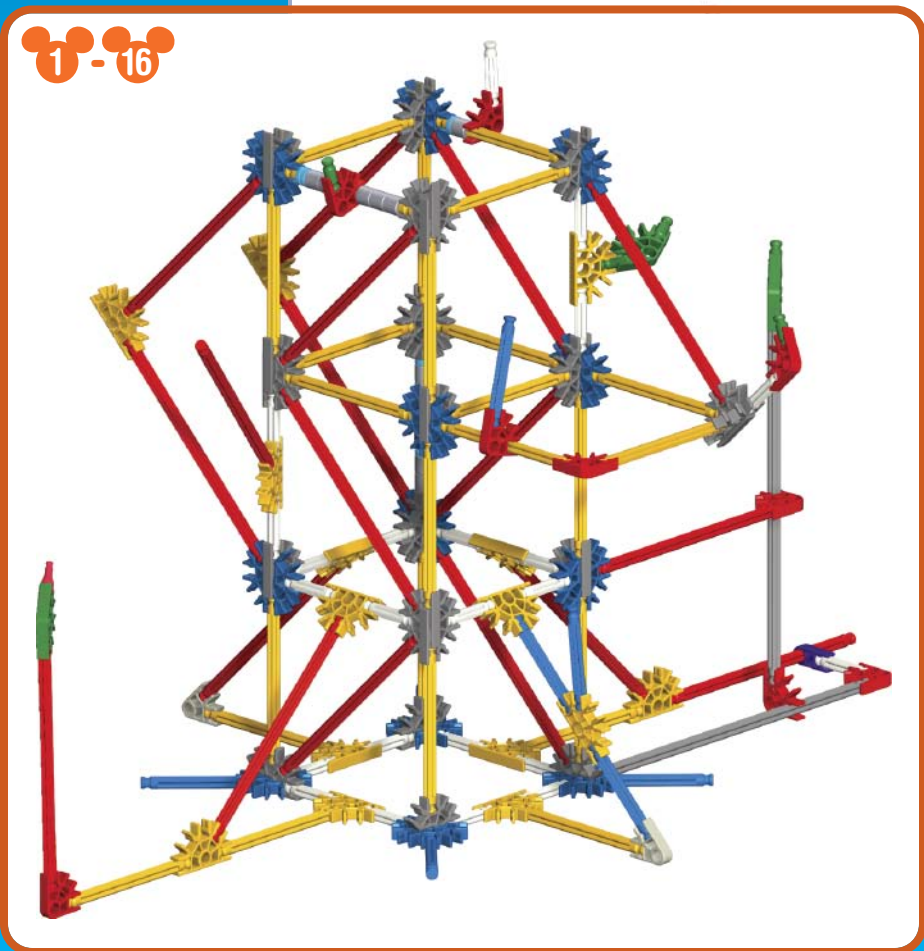

1-14

18

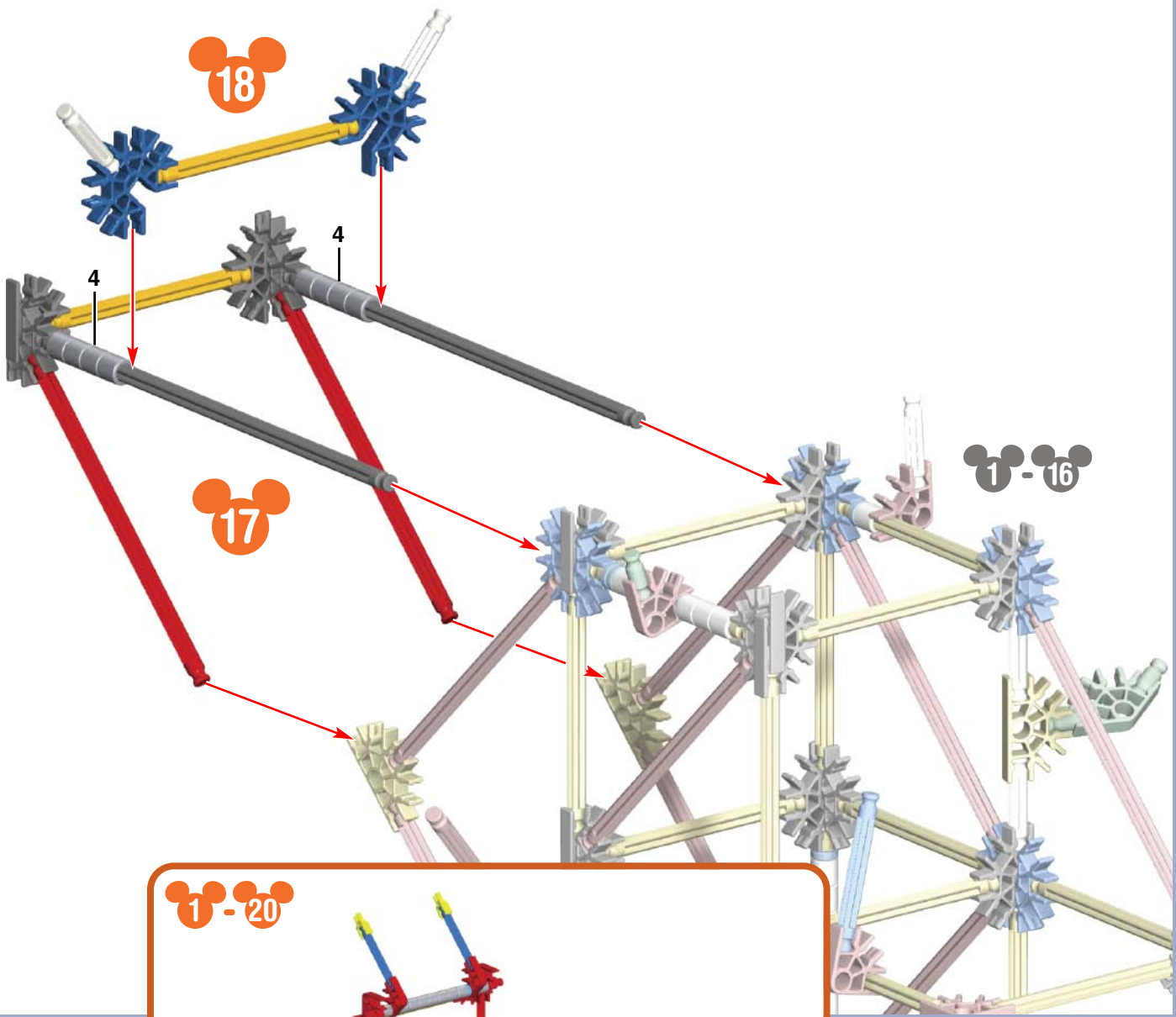

17

1-16

20

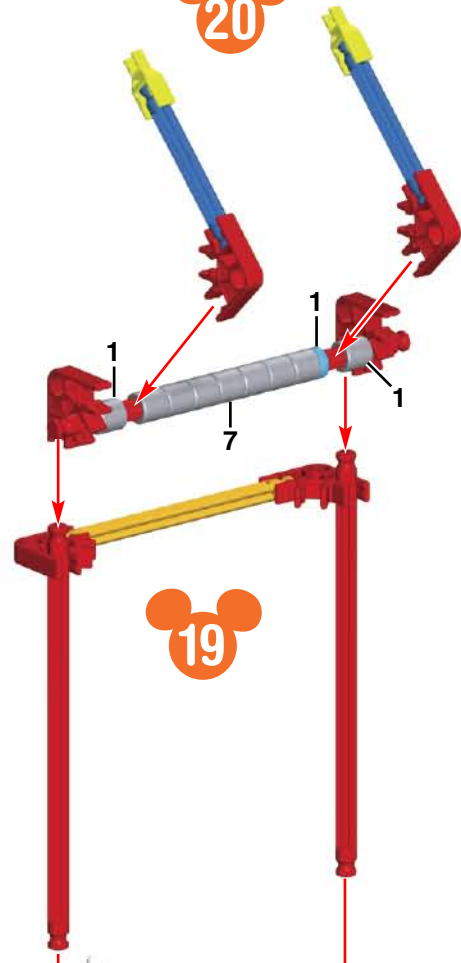

19

1-20

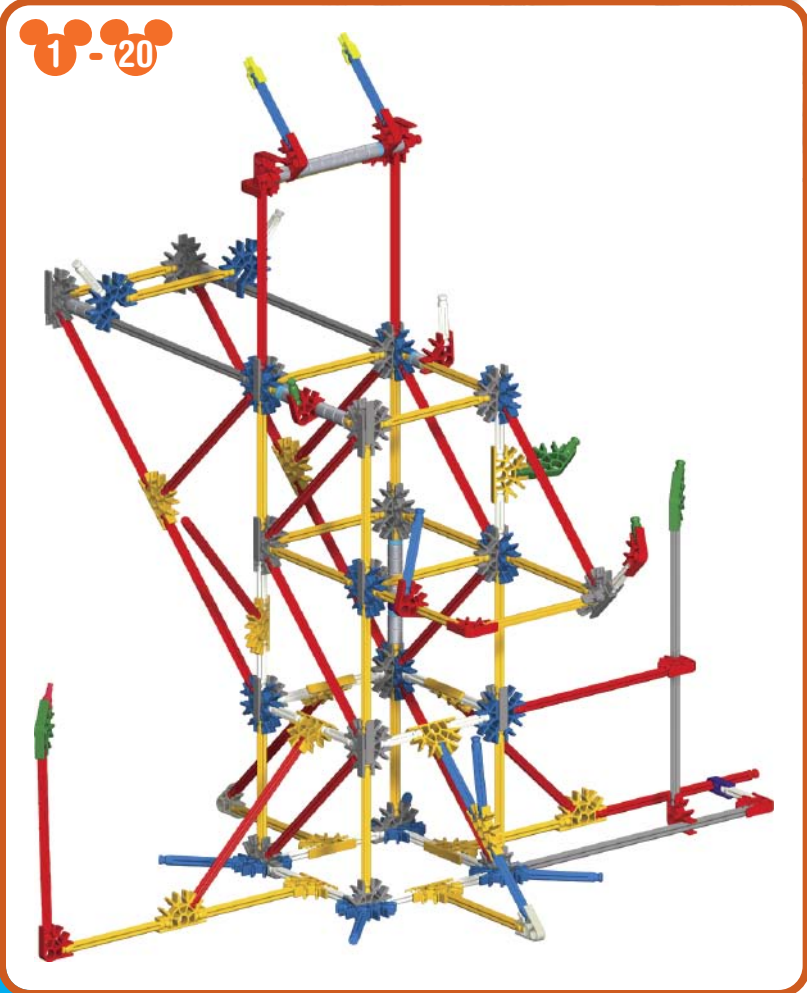

1-18

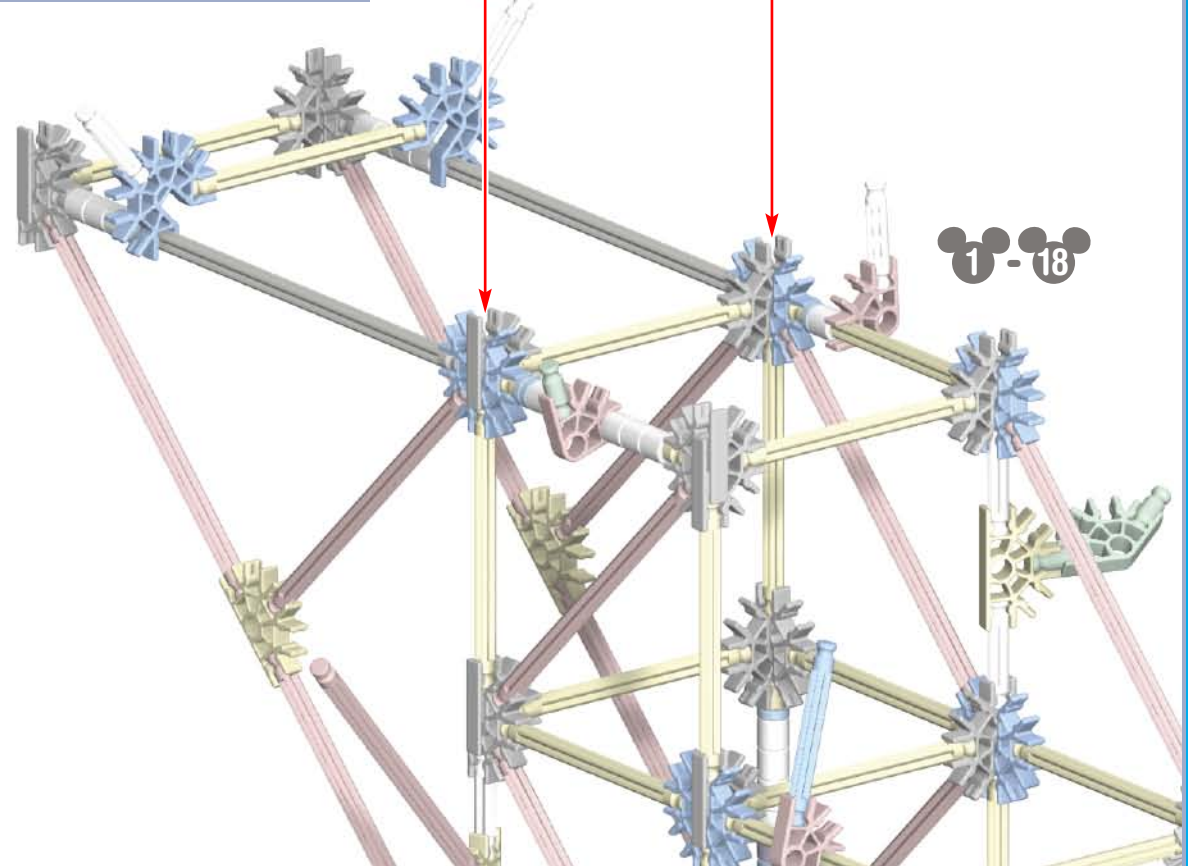



Did you install 2 AA (or LR6) batteries in the motor?

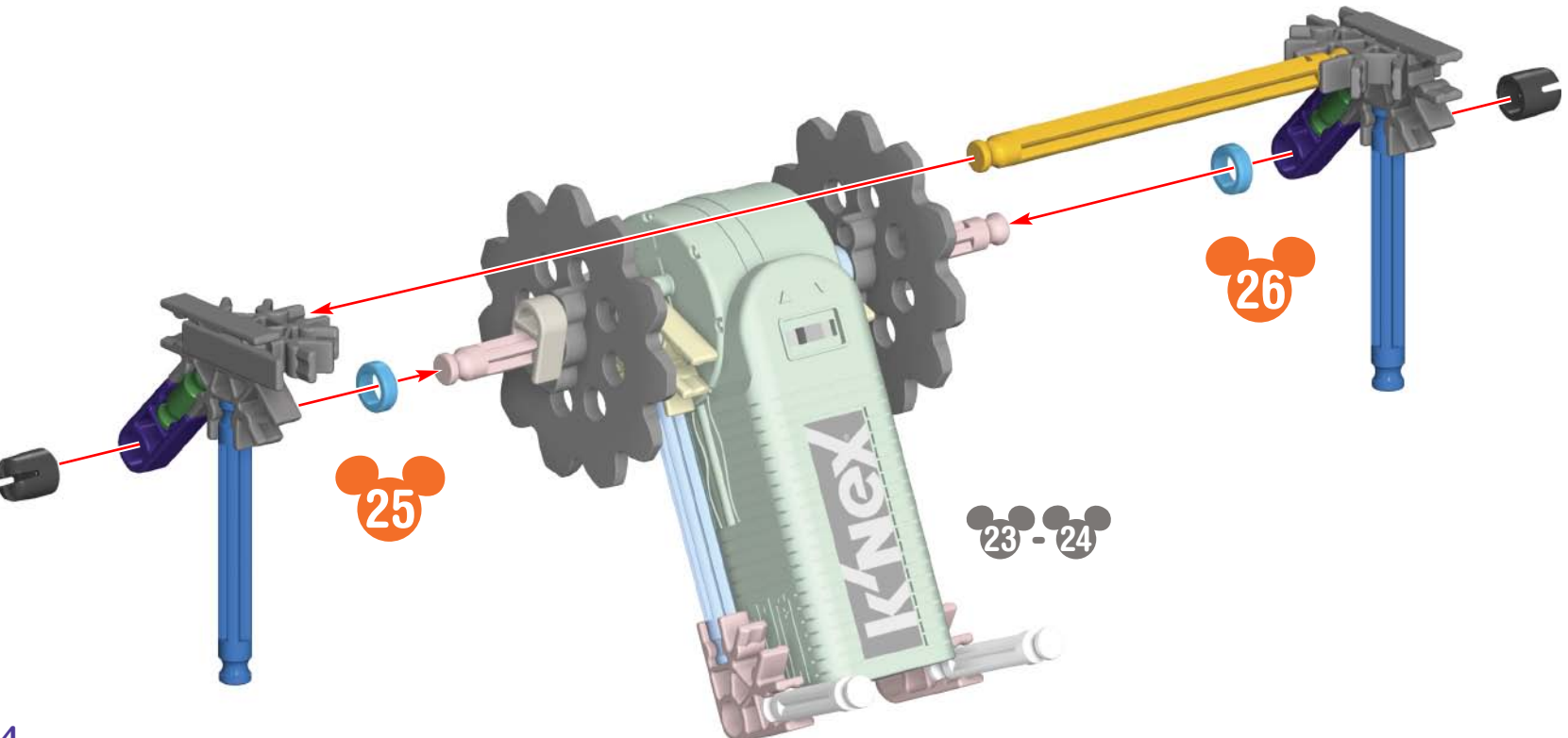
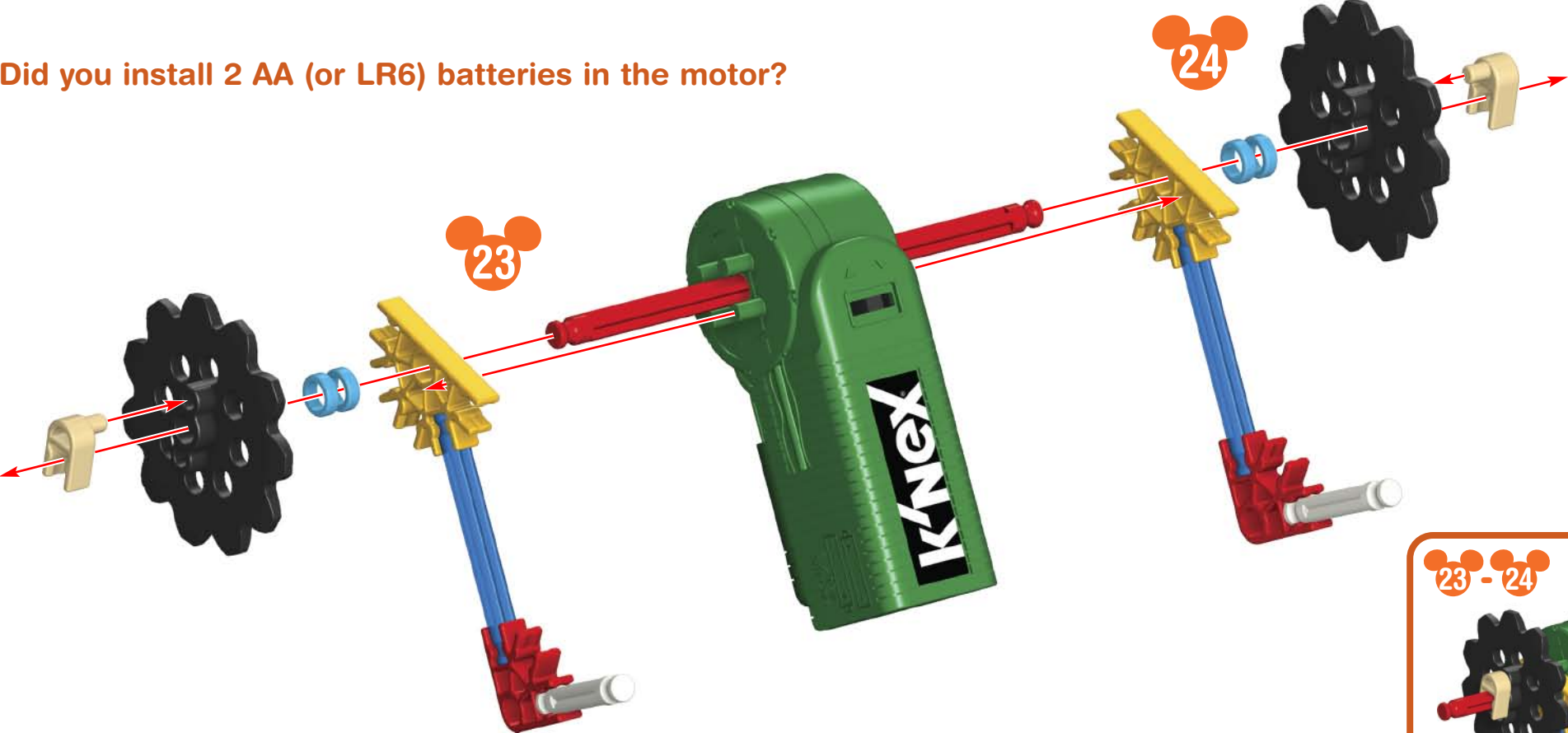

23-26

27

1-22

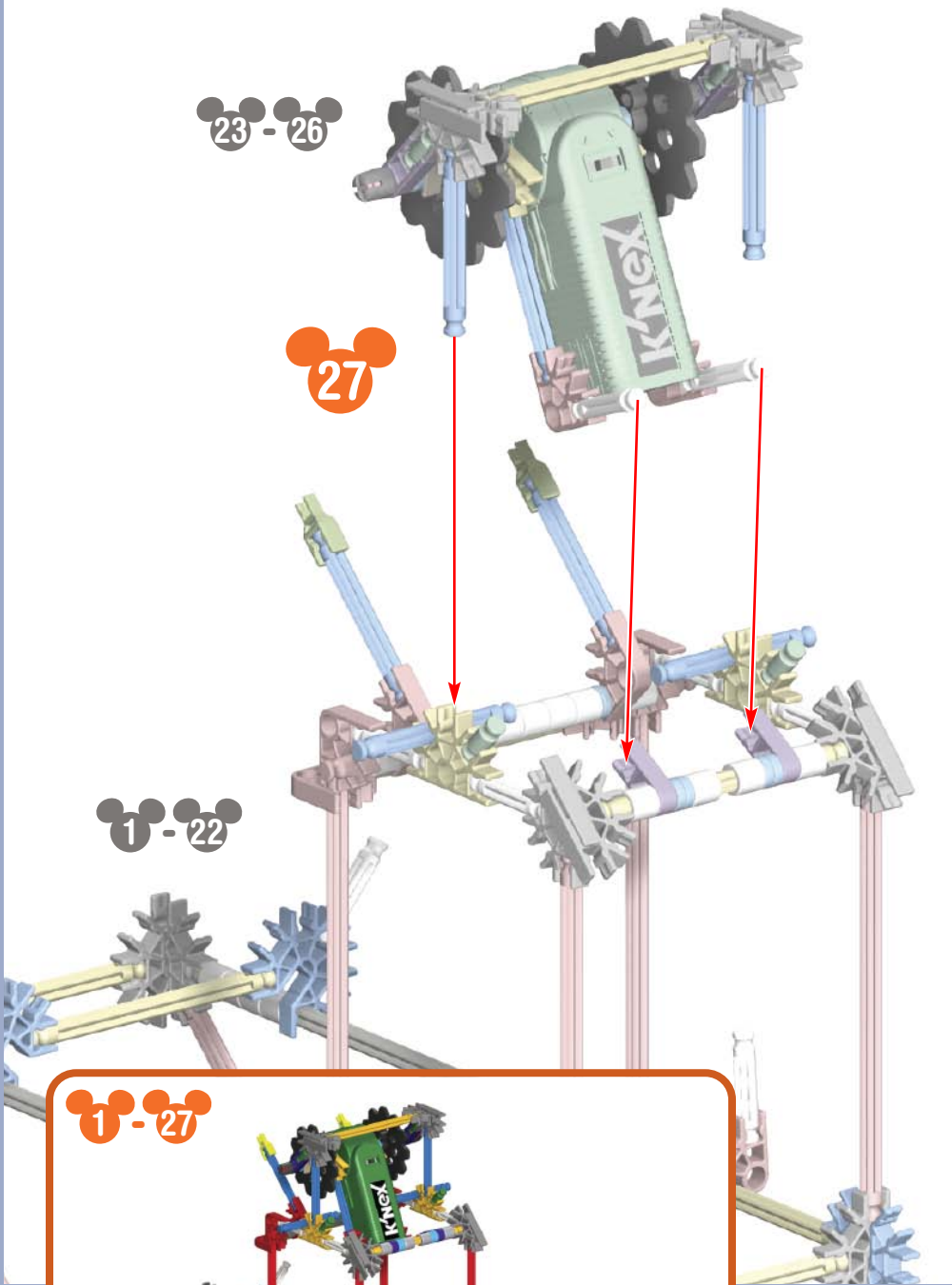

1-27

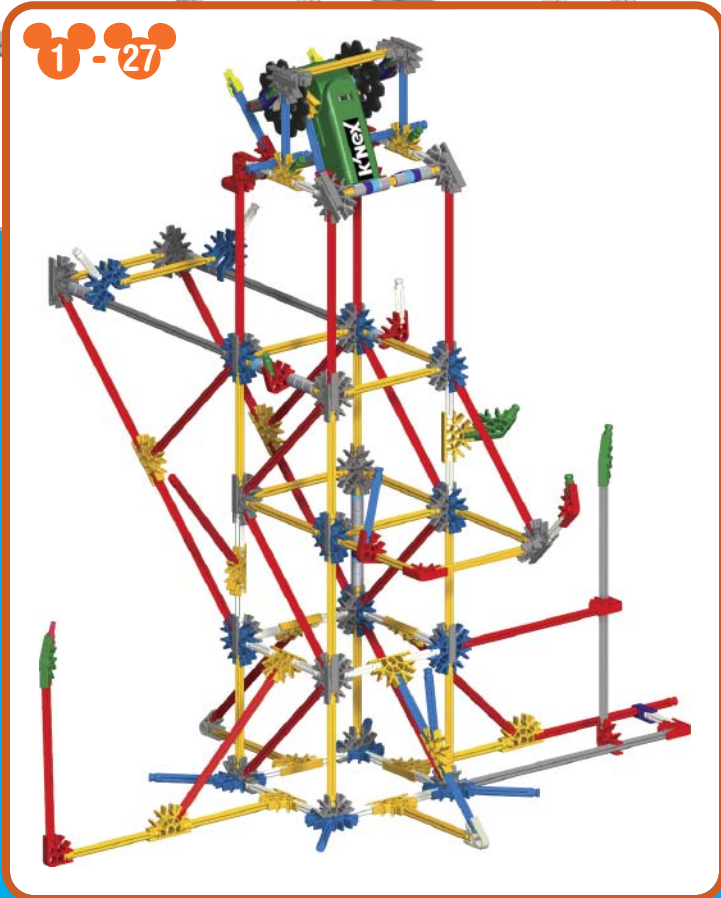

28

6

1-27

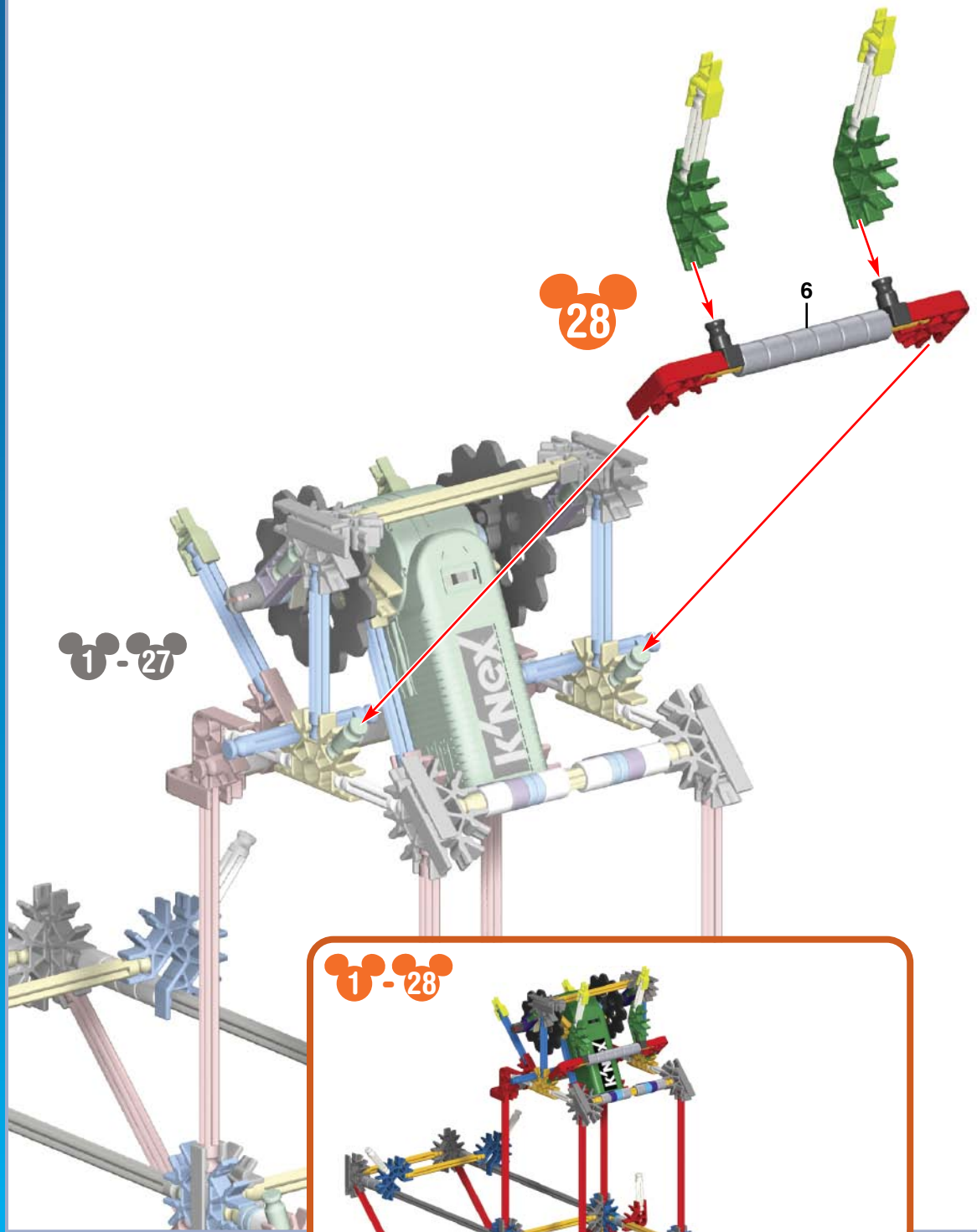

1-28

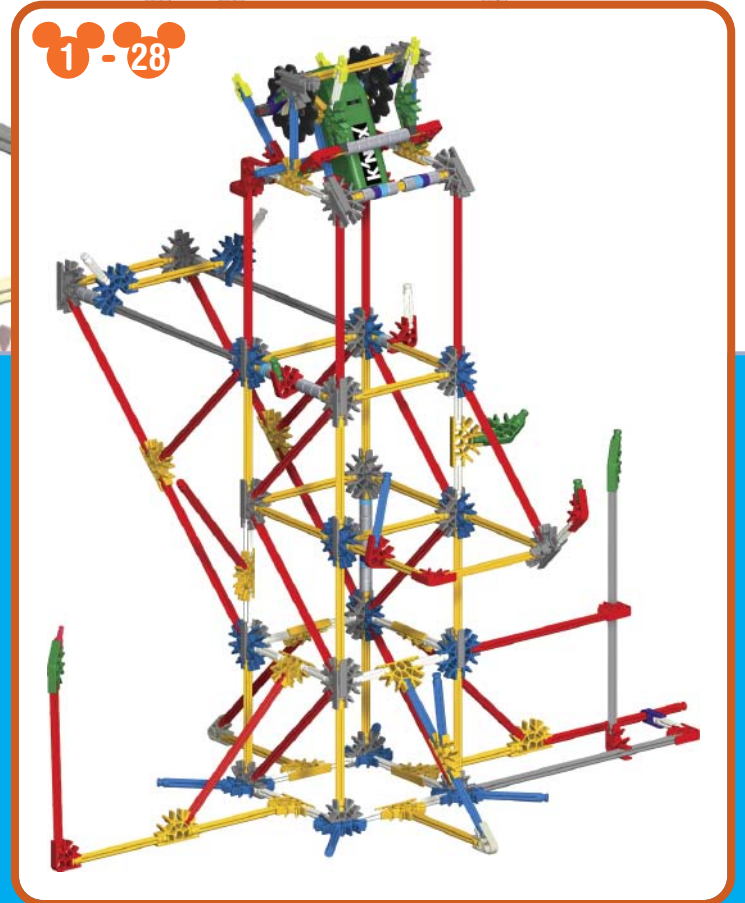



1-32

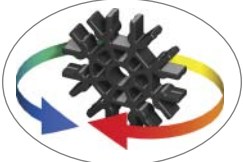
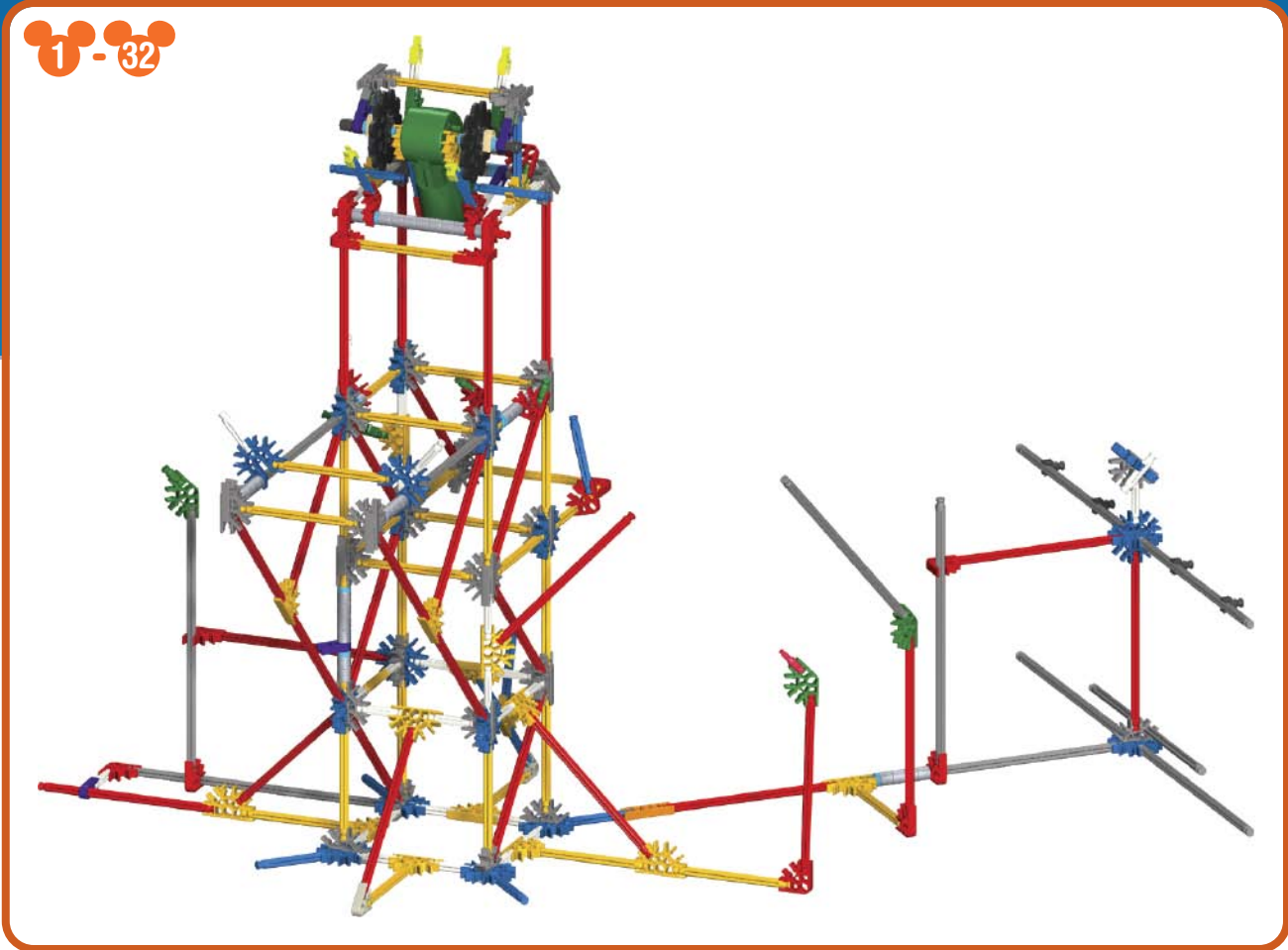

Rotate model

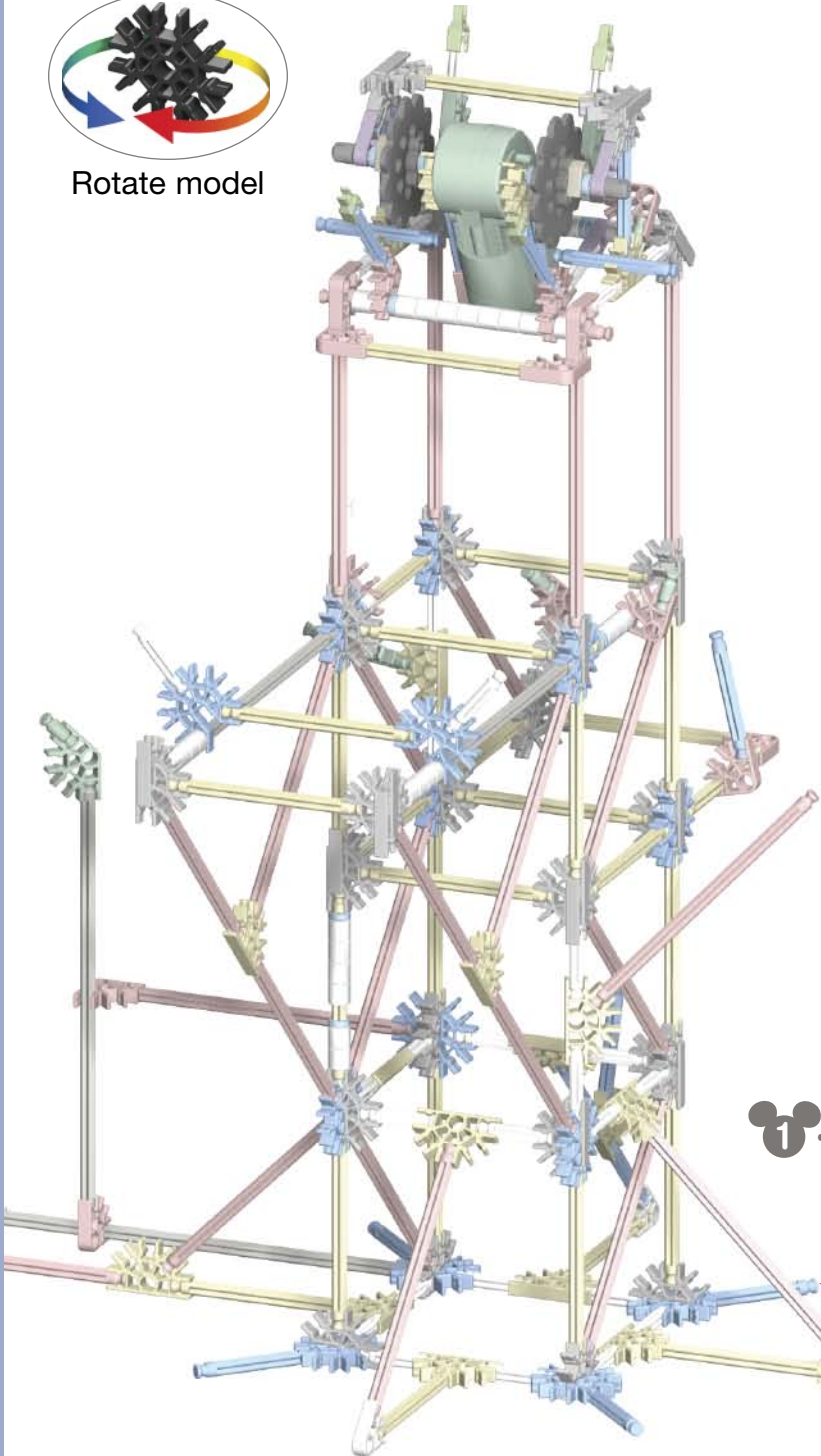

1-28

32

29-31

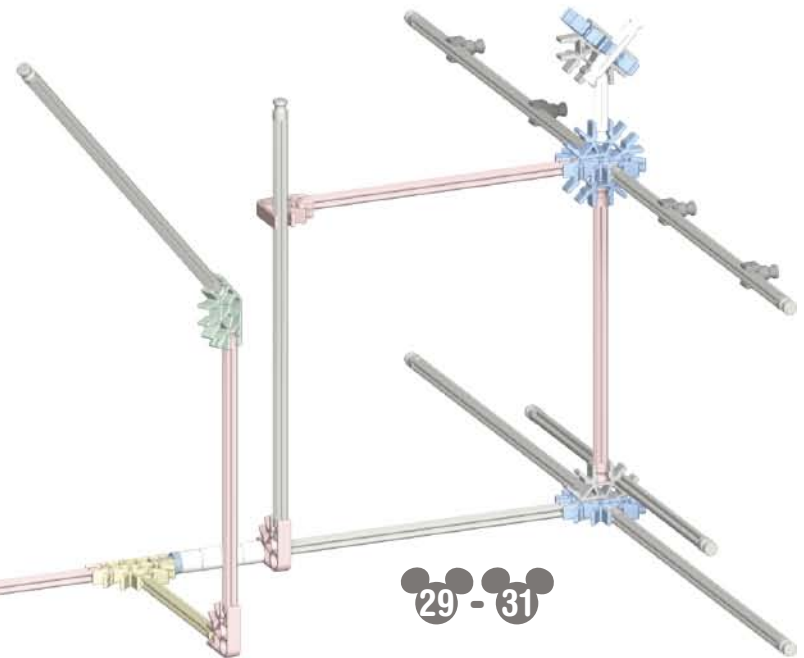

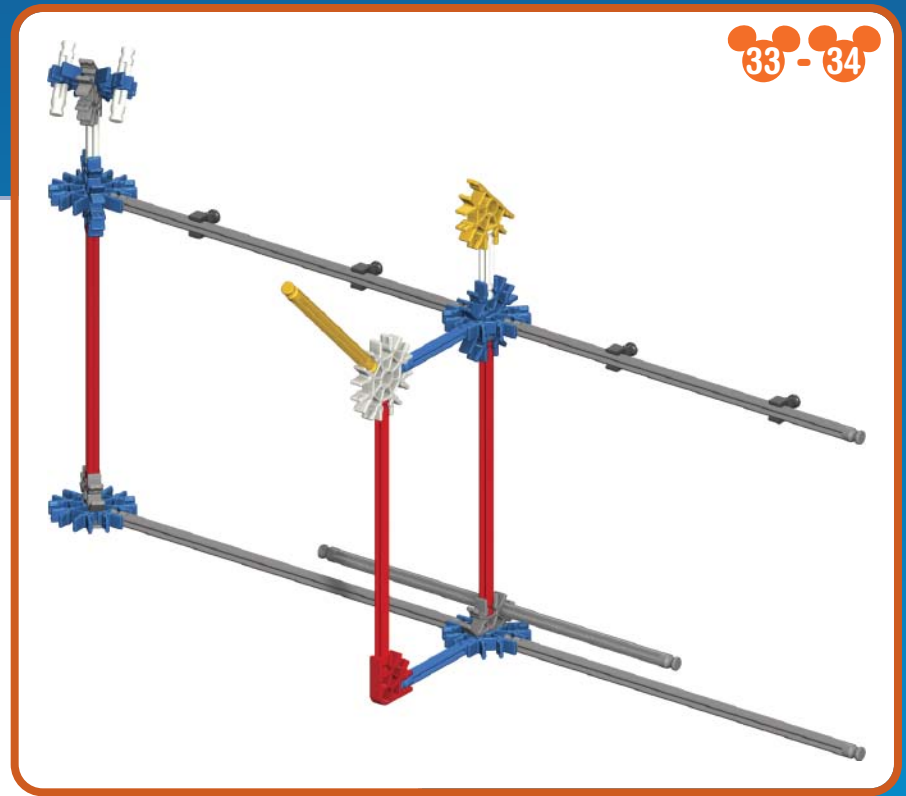
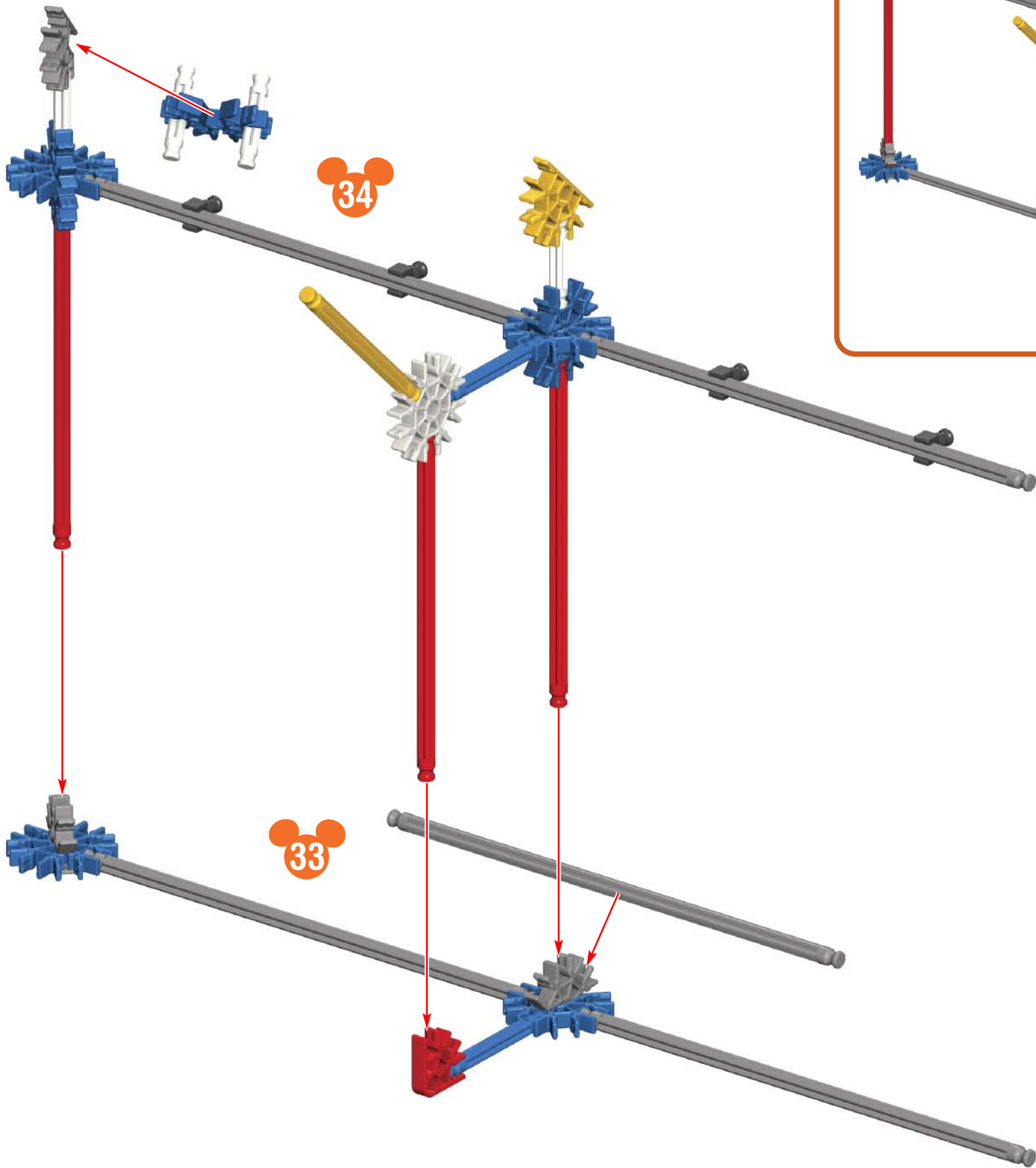

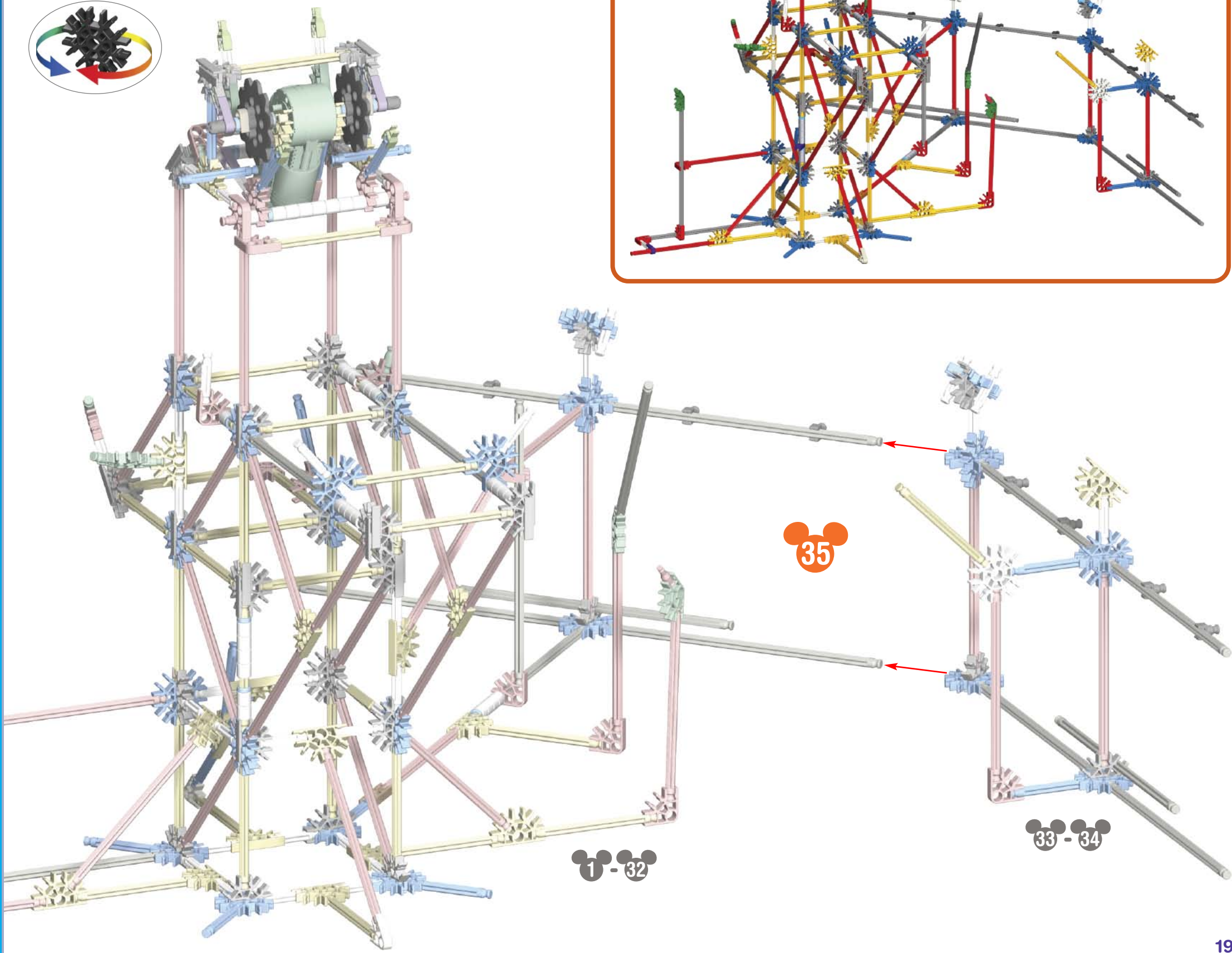
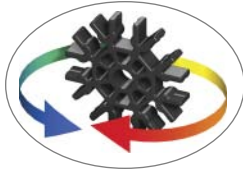
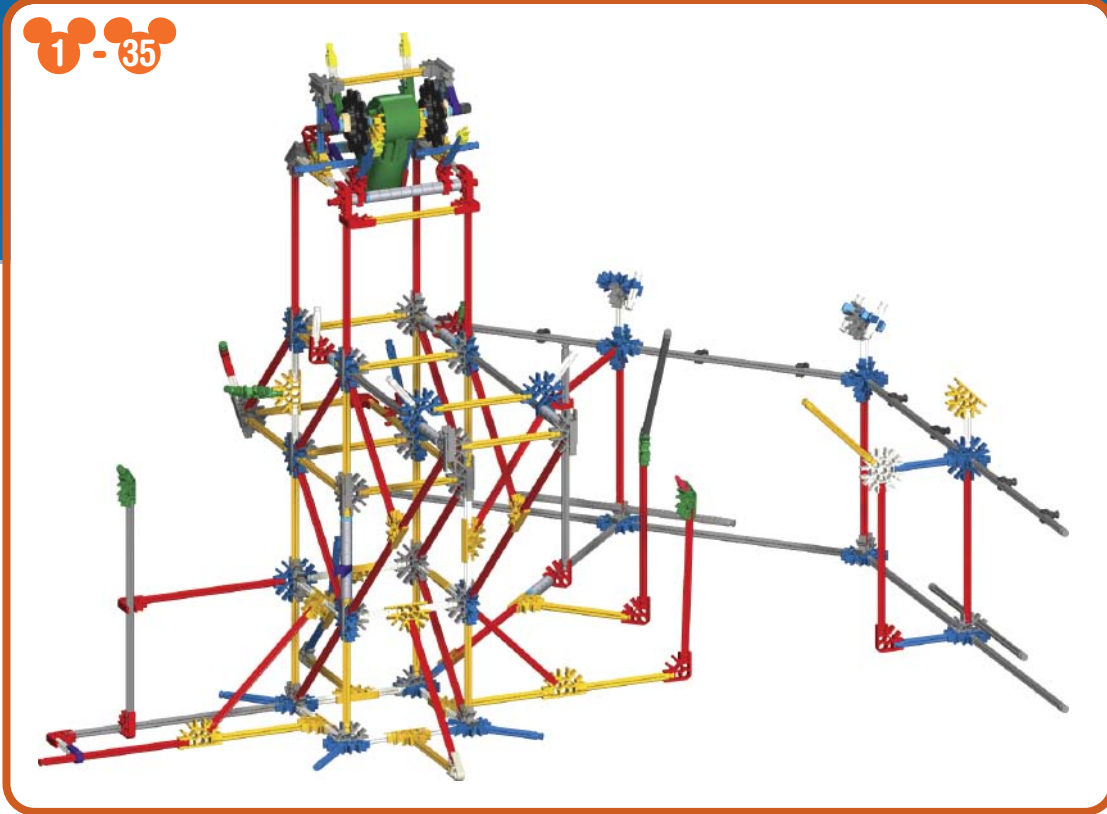



1-40

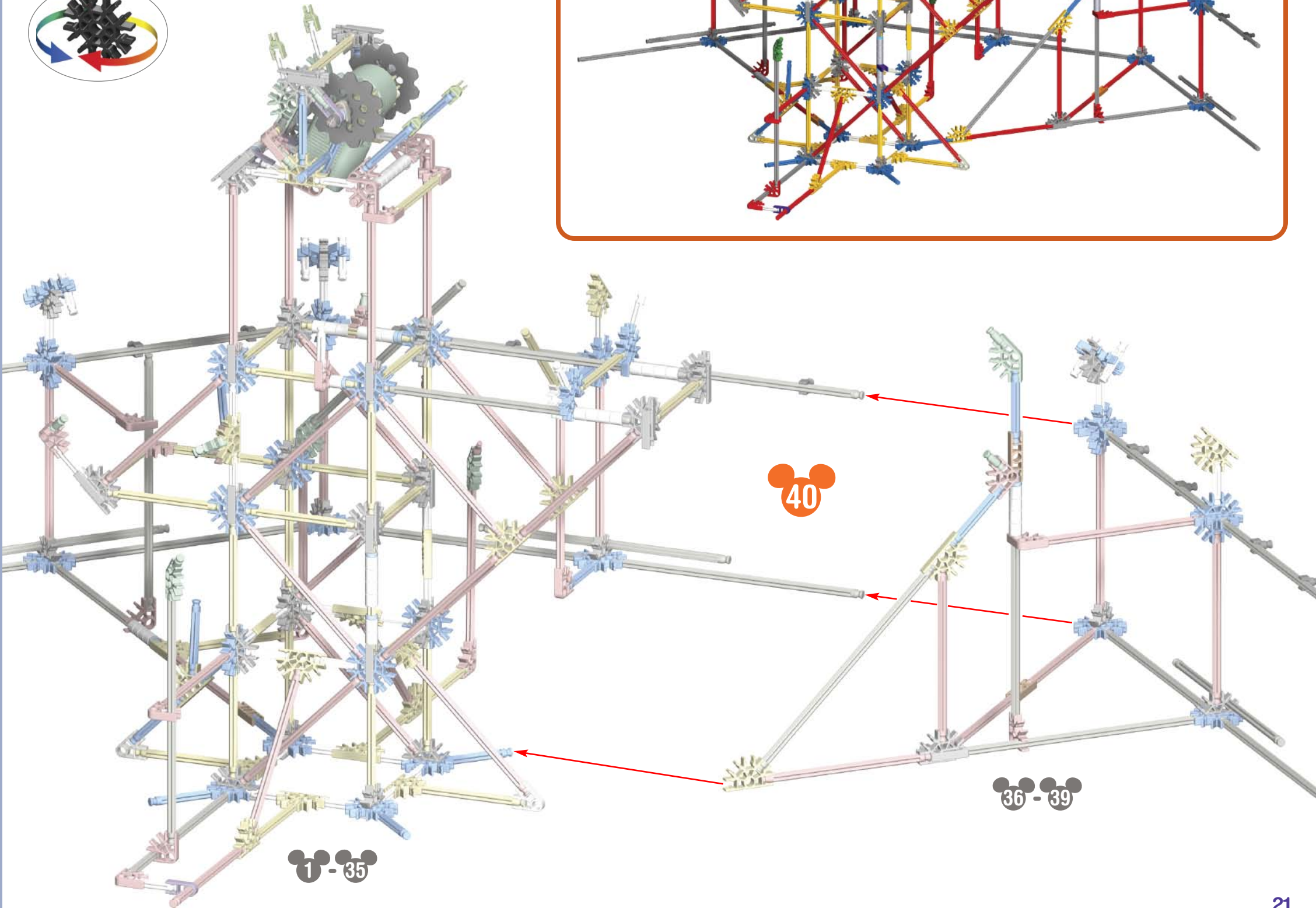

1-35

40

36-39

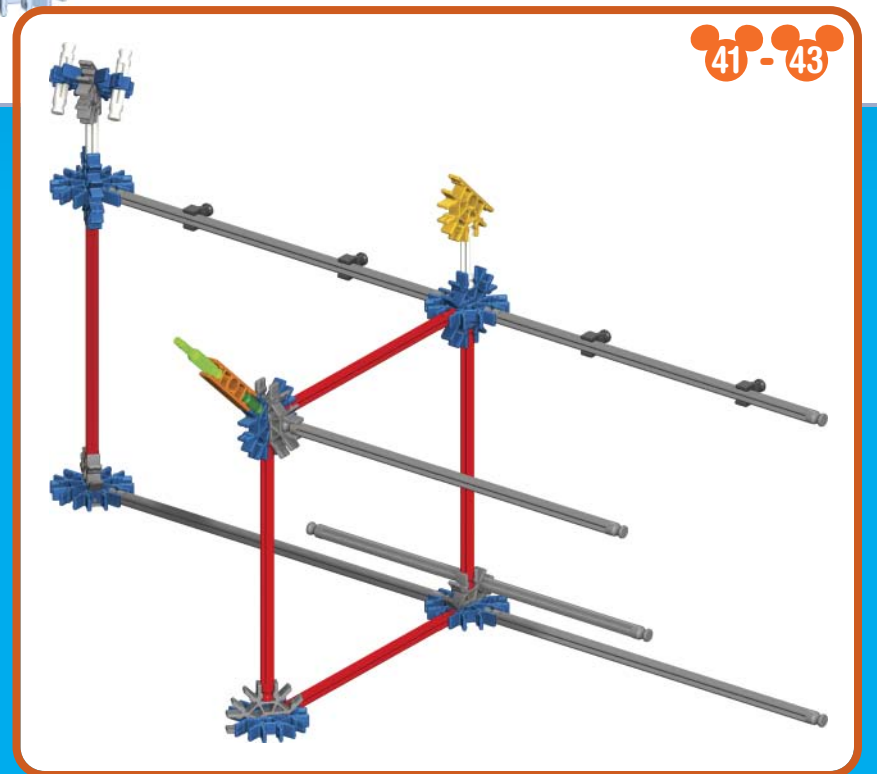
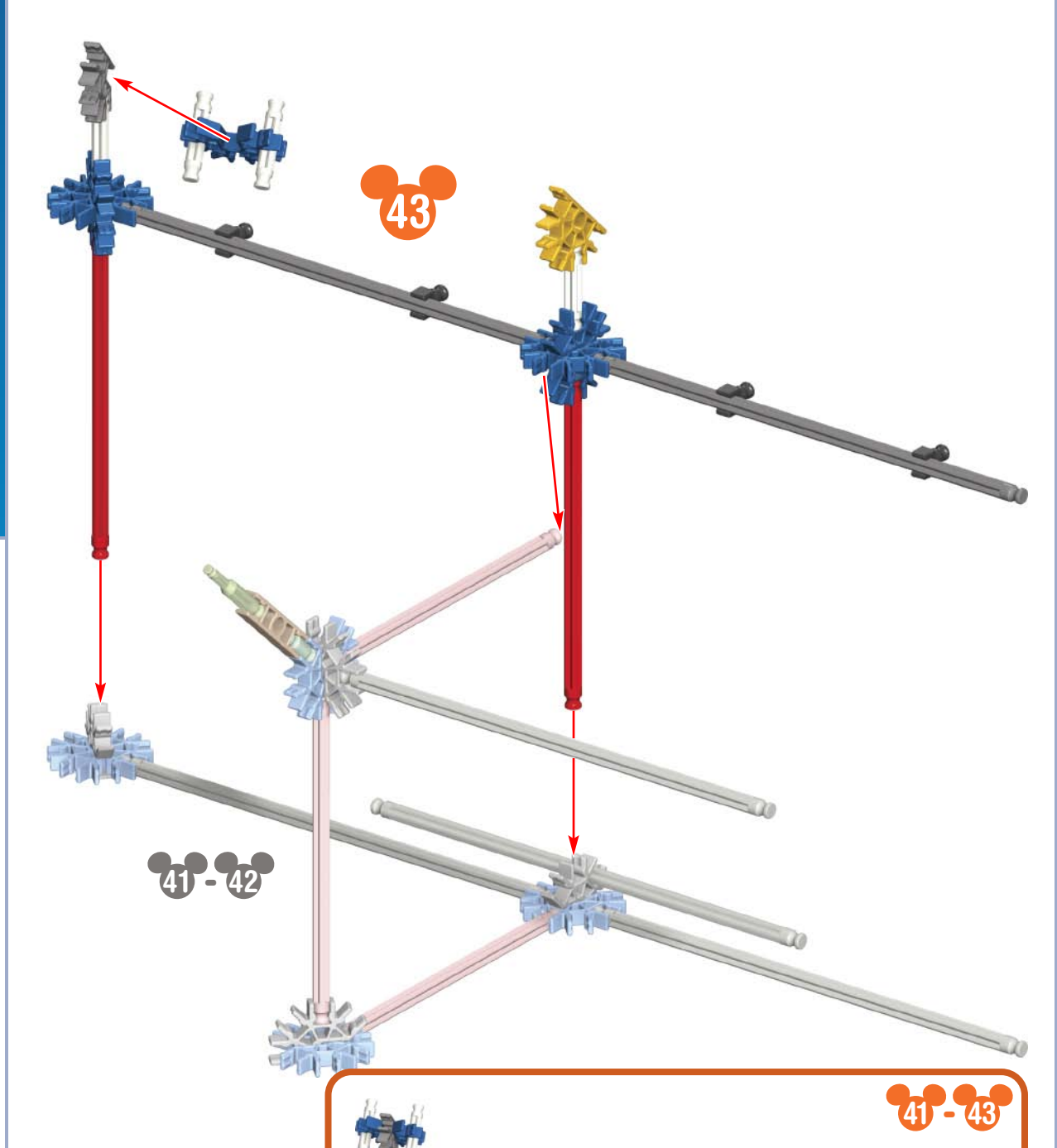
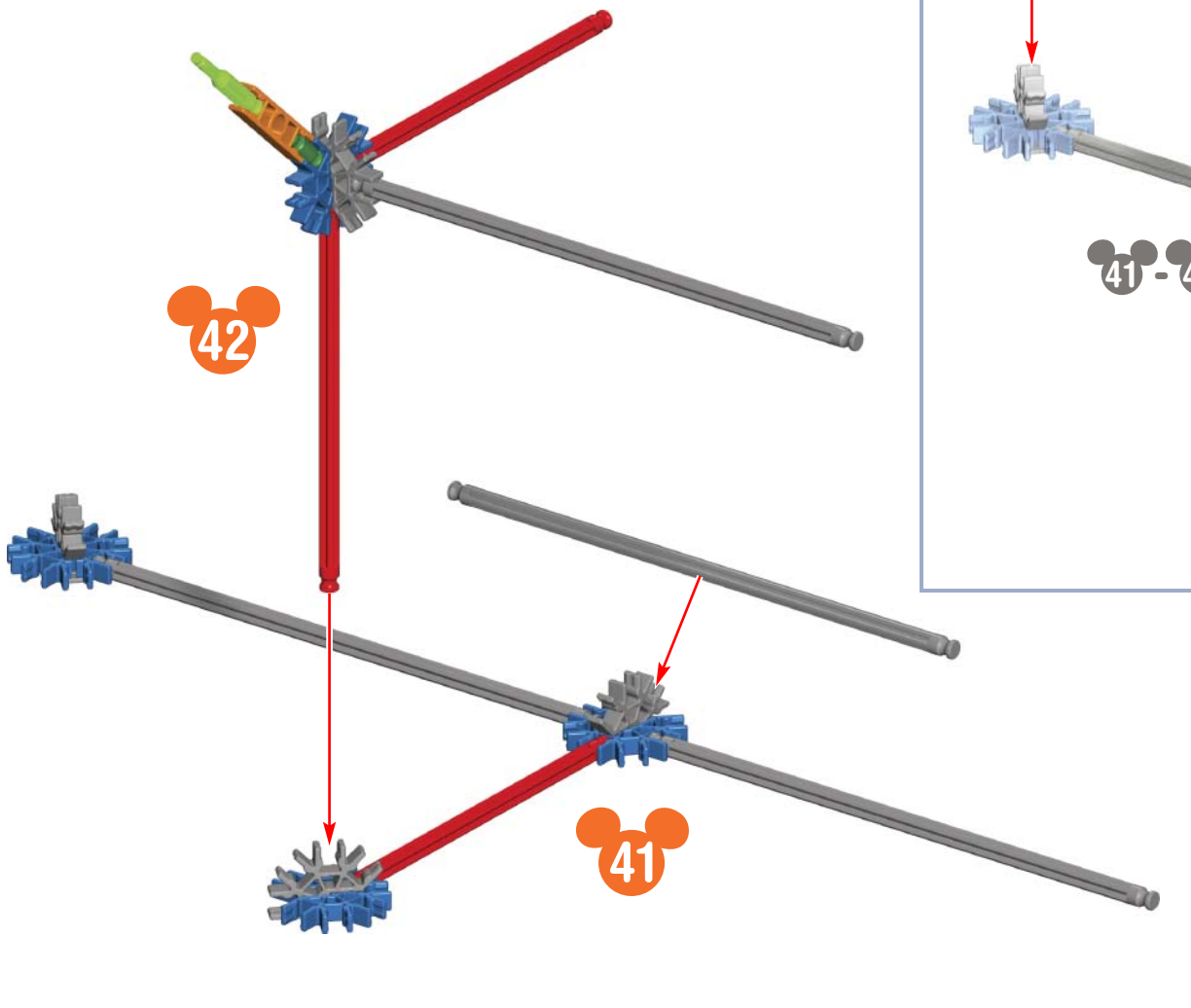
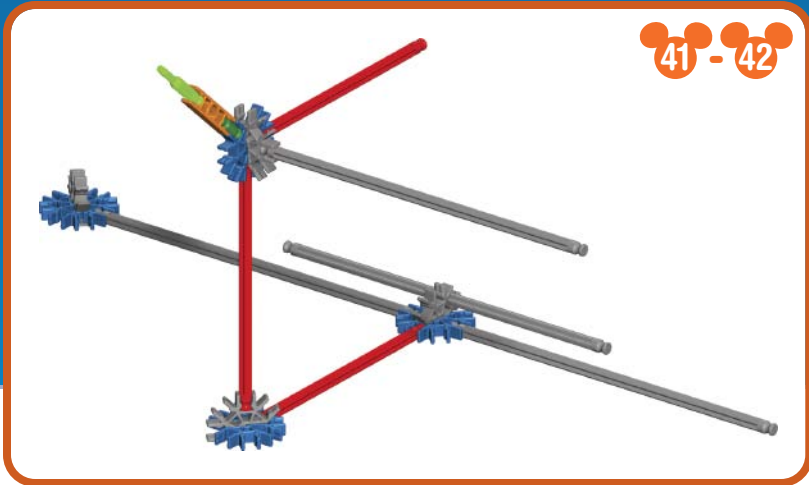

1-44

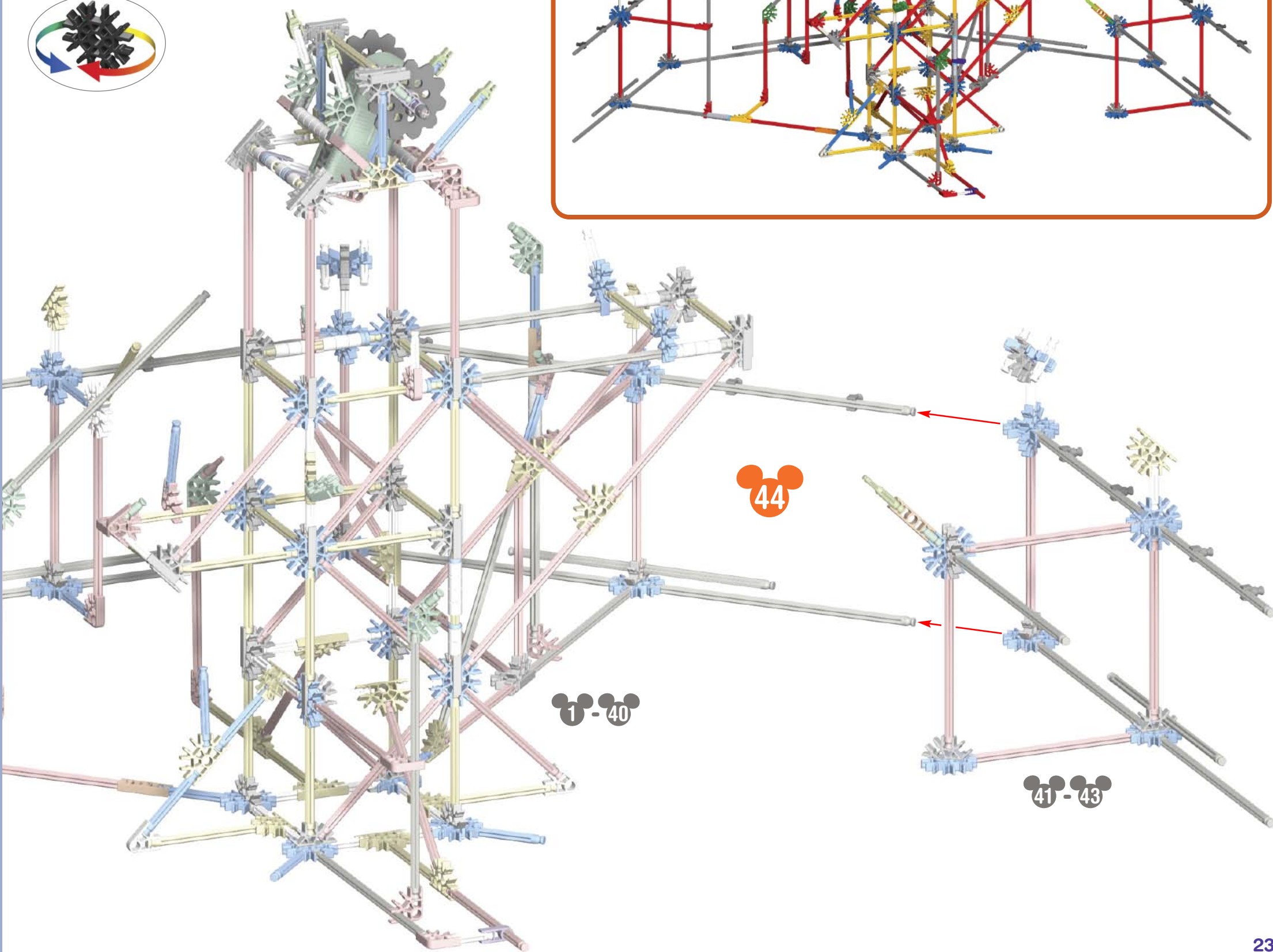
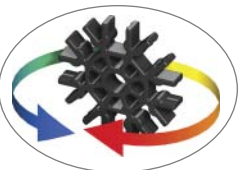

44

1-40

41-43

46

2

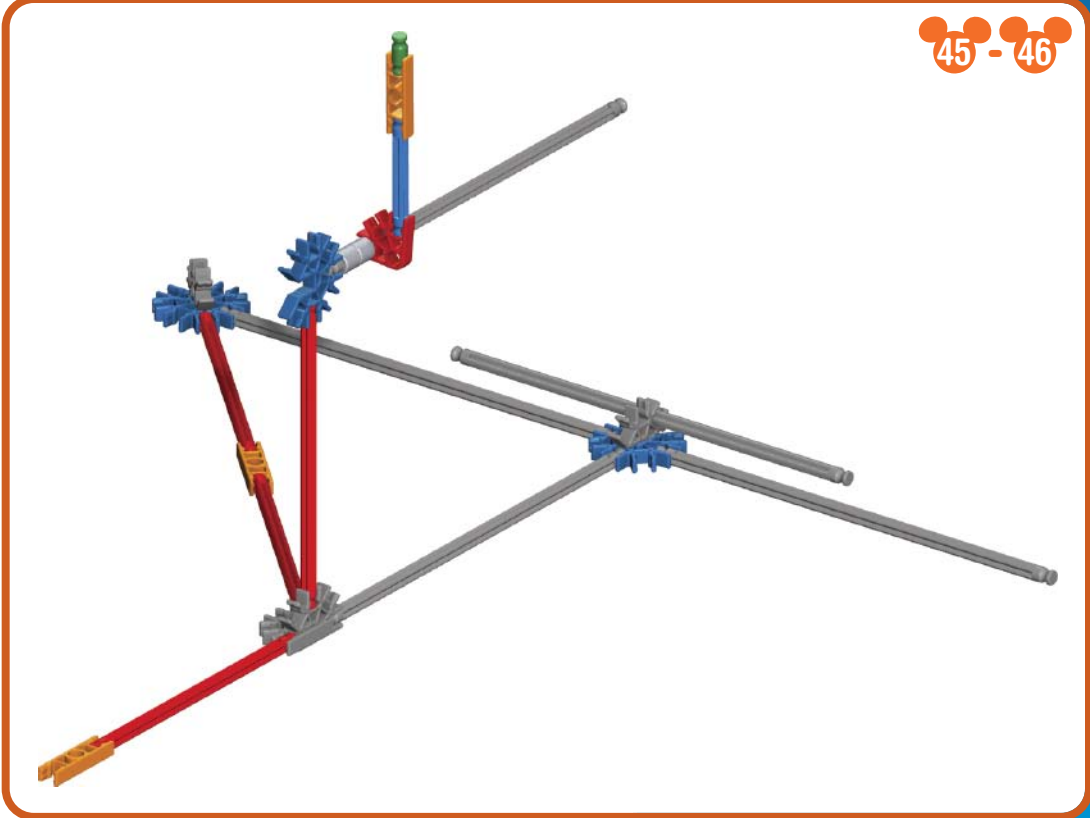

45

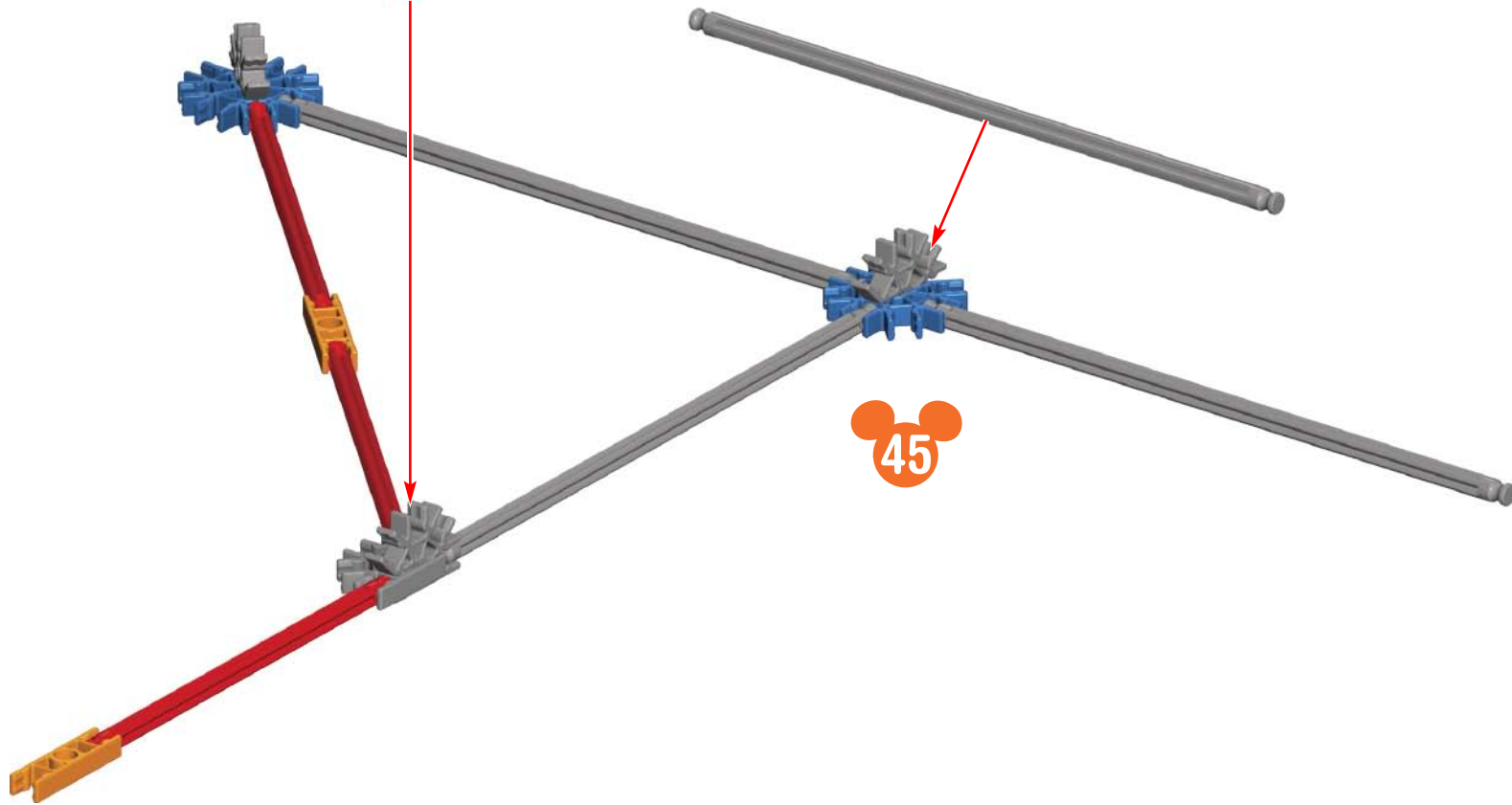

47

48

45 - 46

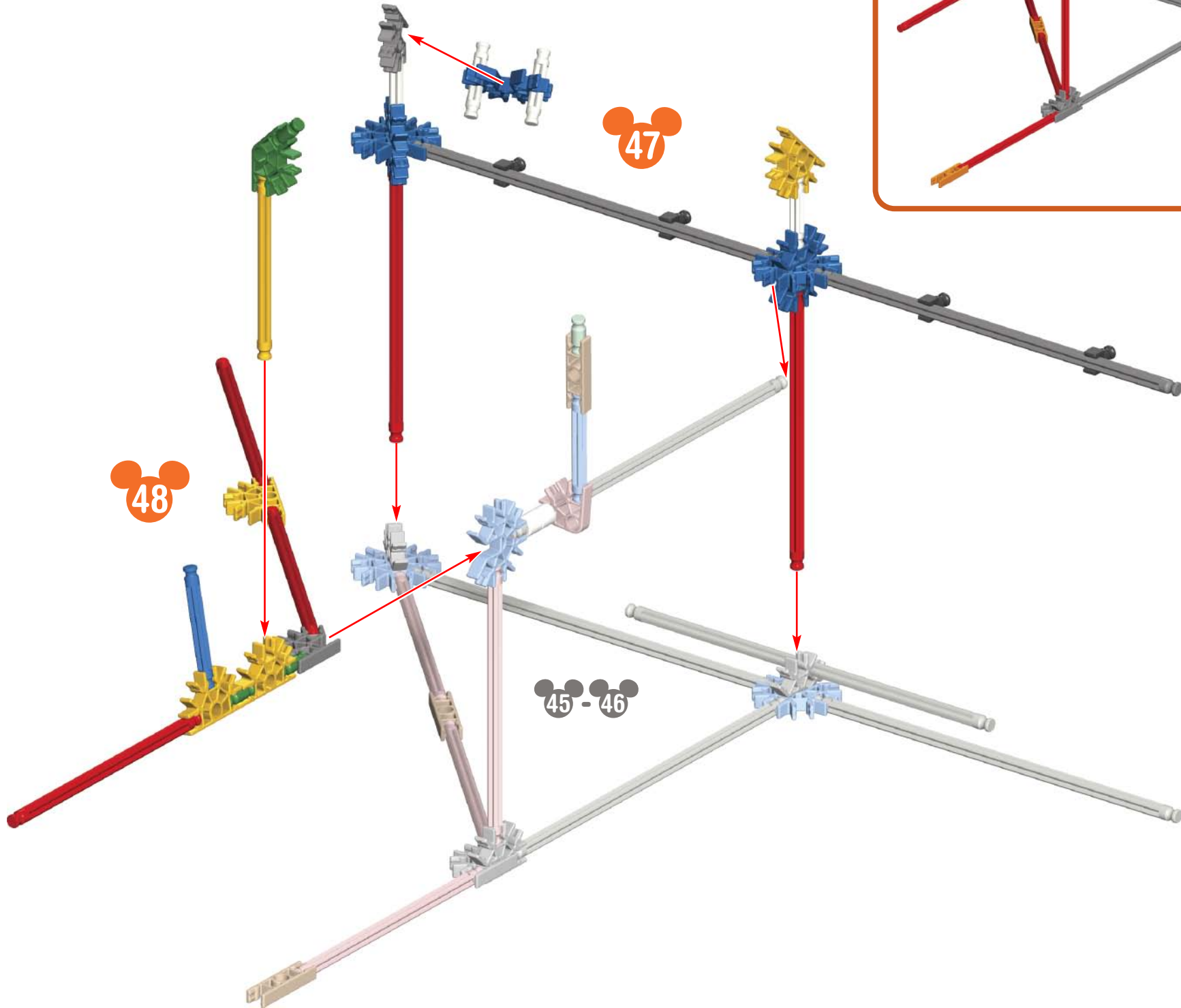
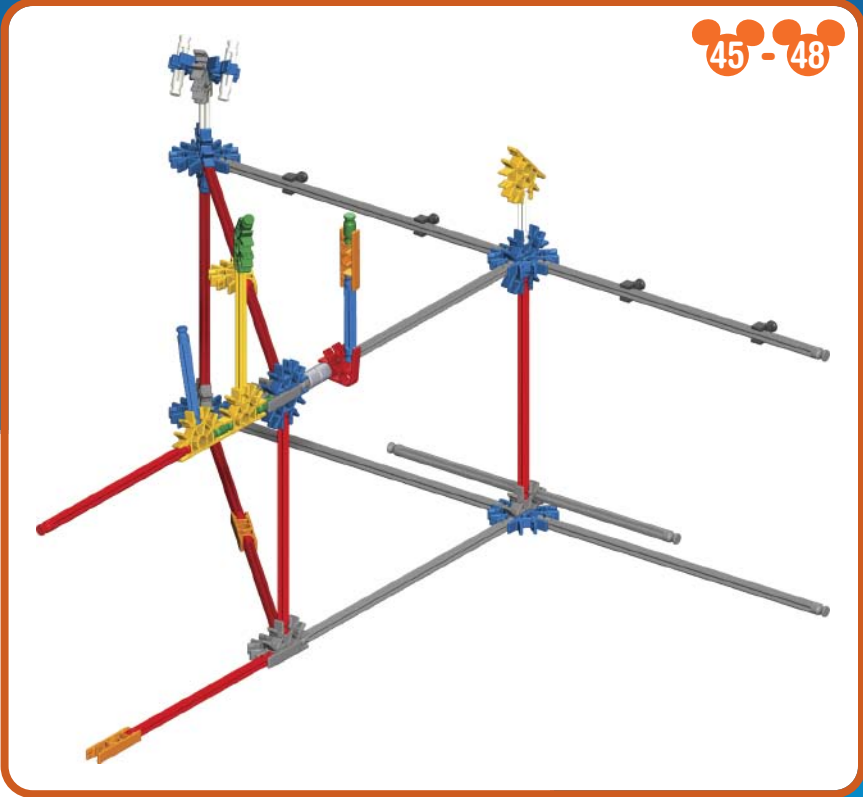

1-49

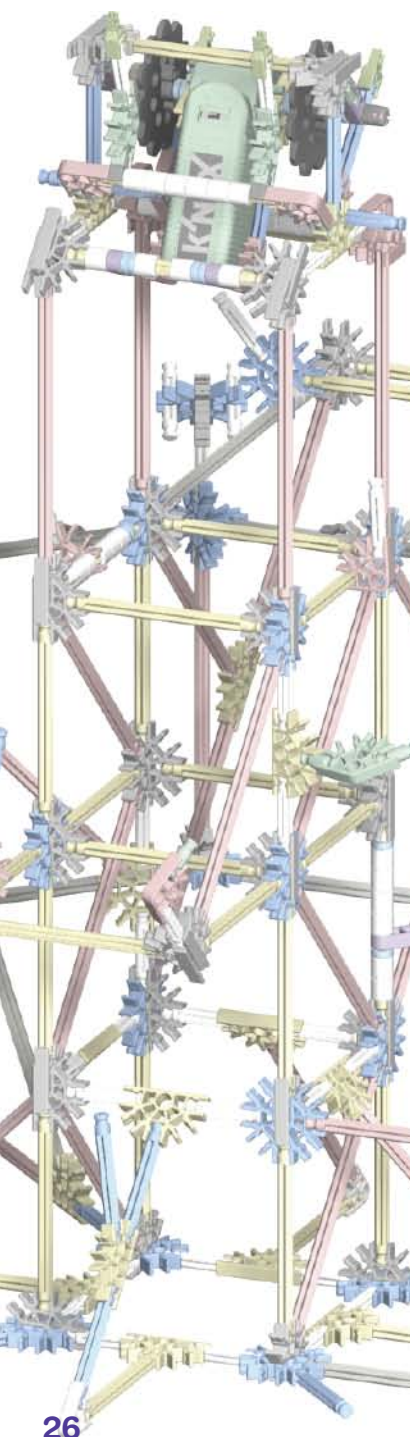
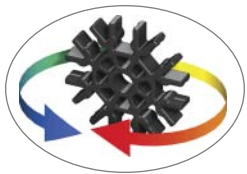

49

1-44

45-48

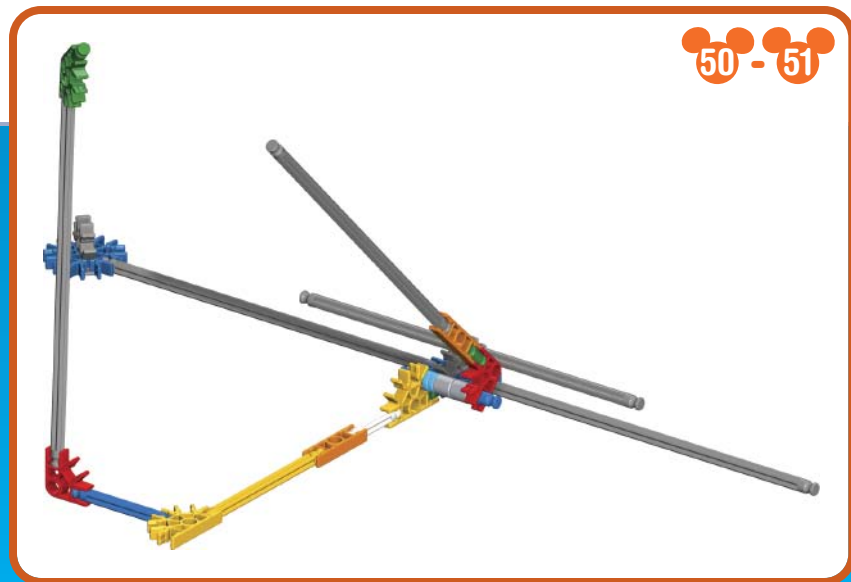
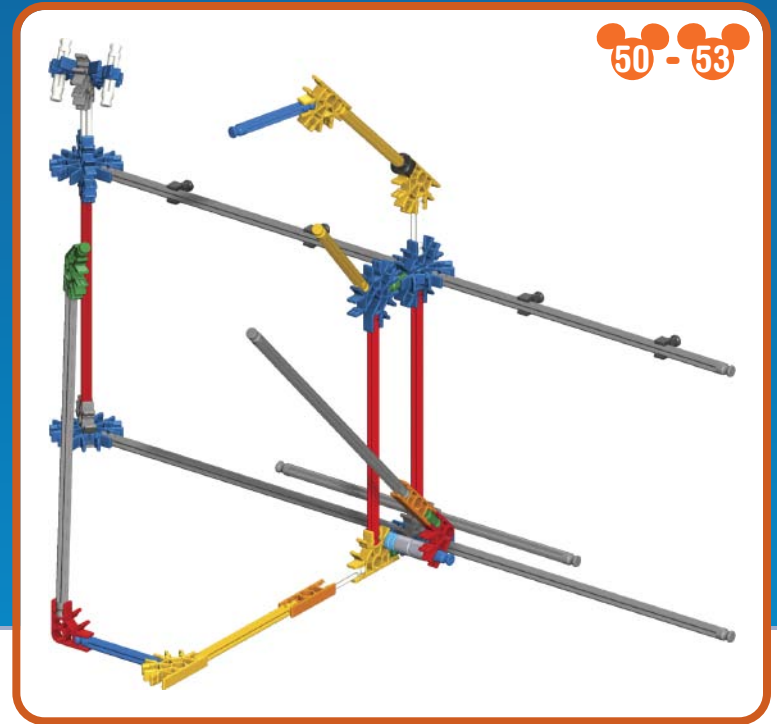
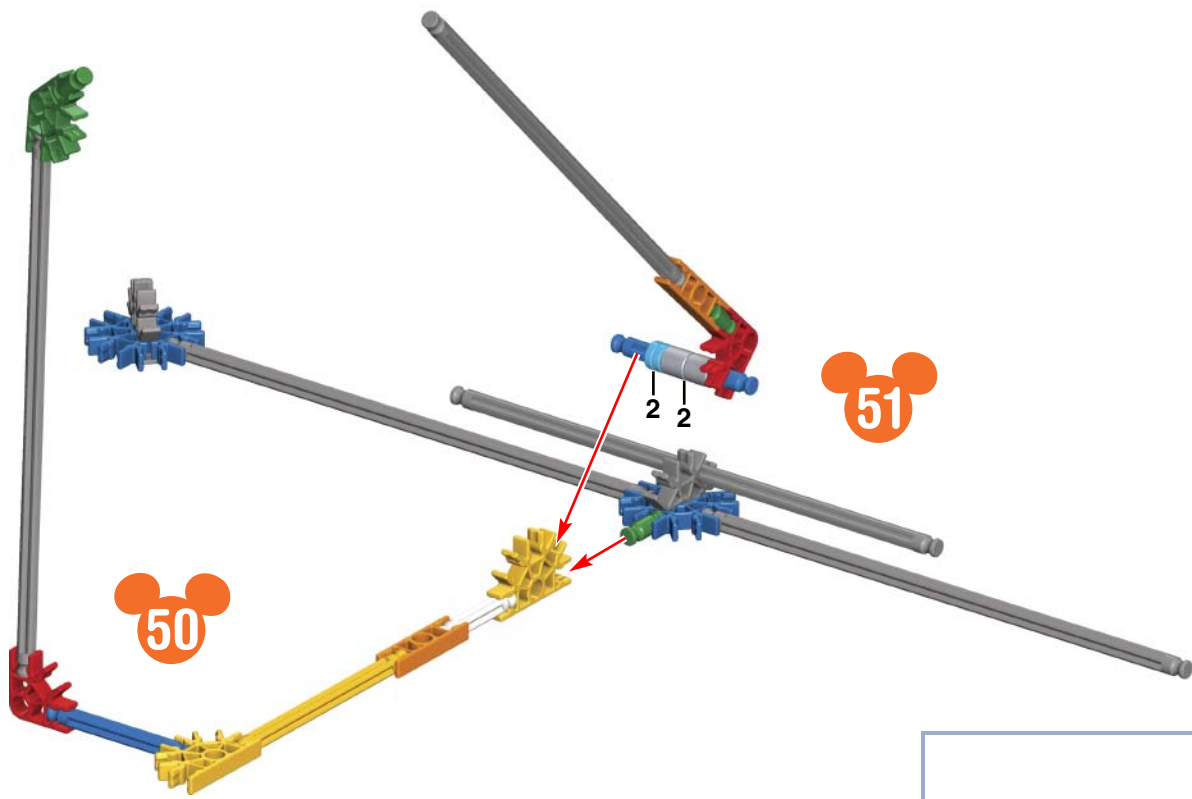

1-54

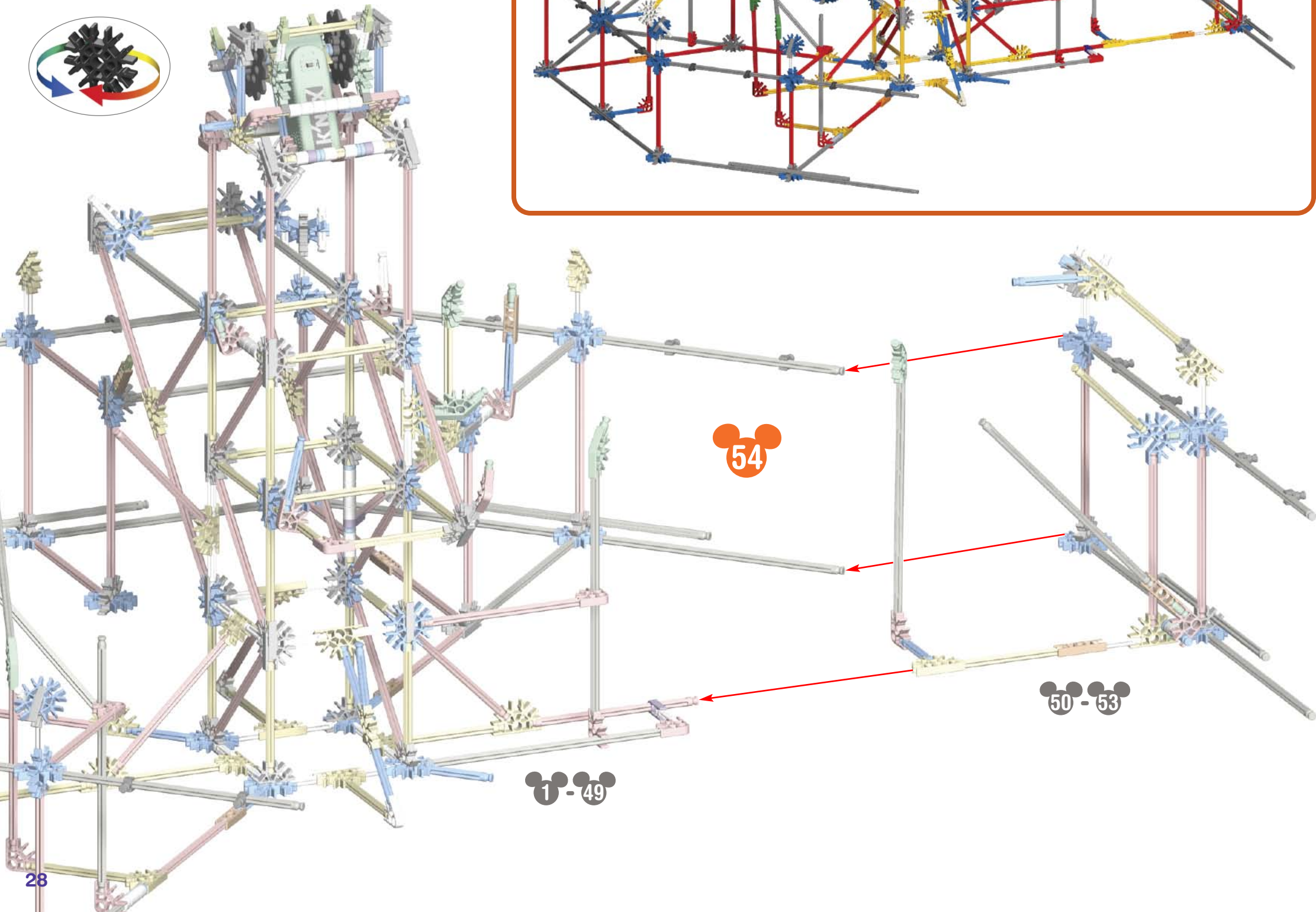
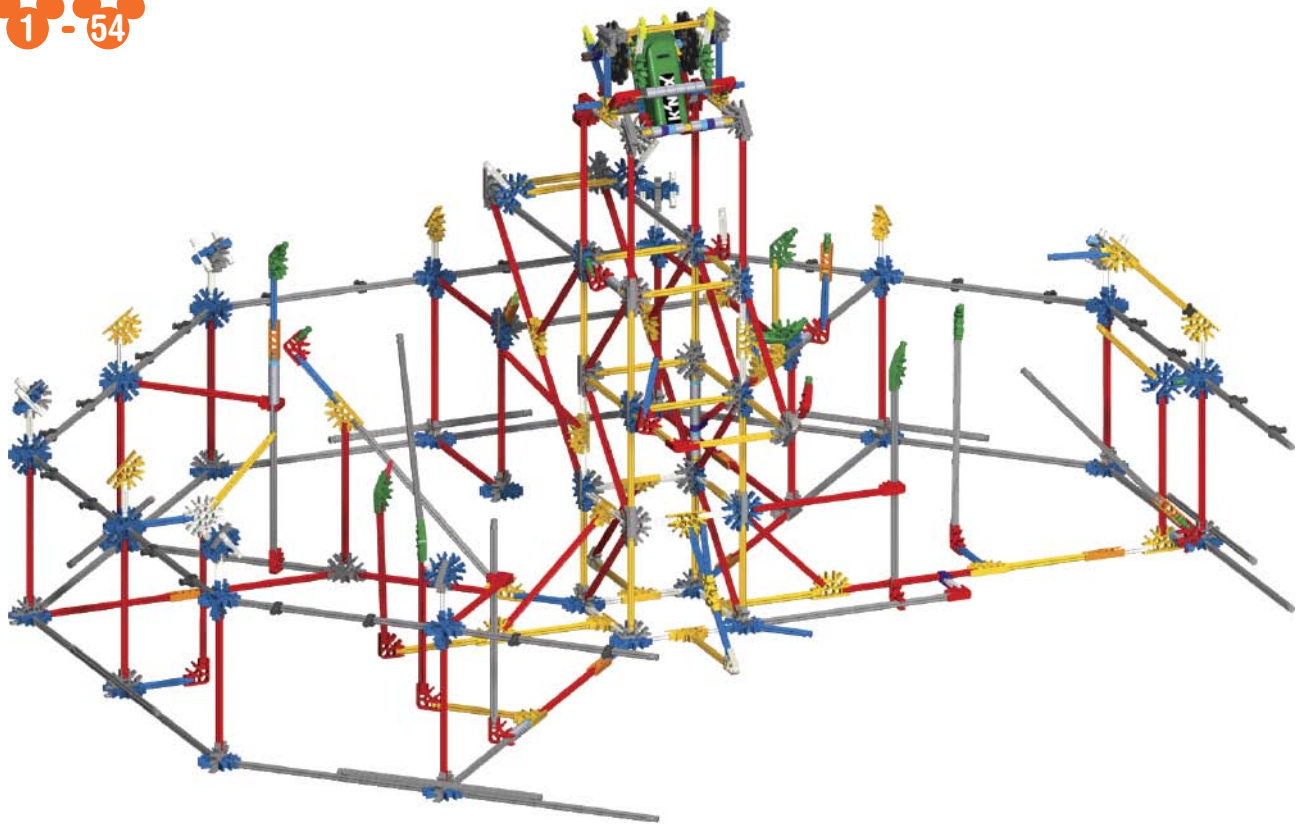

54

50-53

1-49

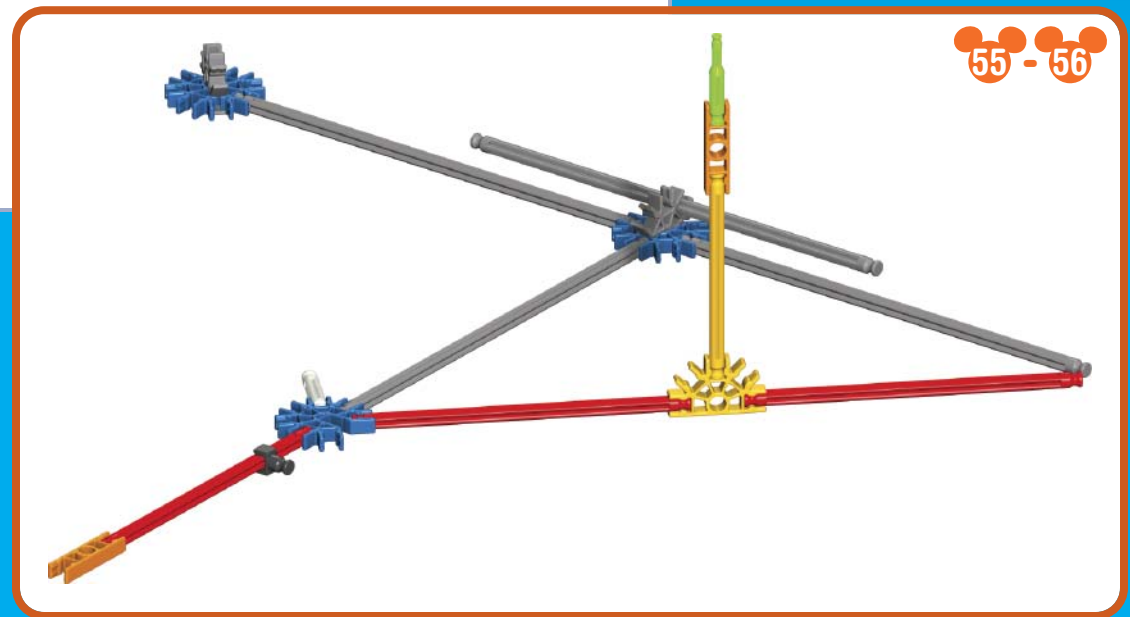
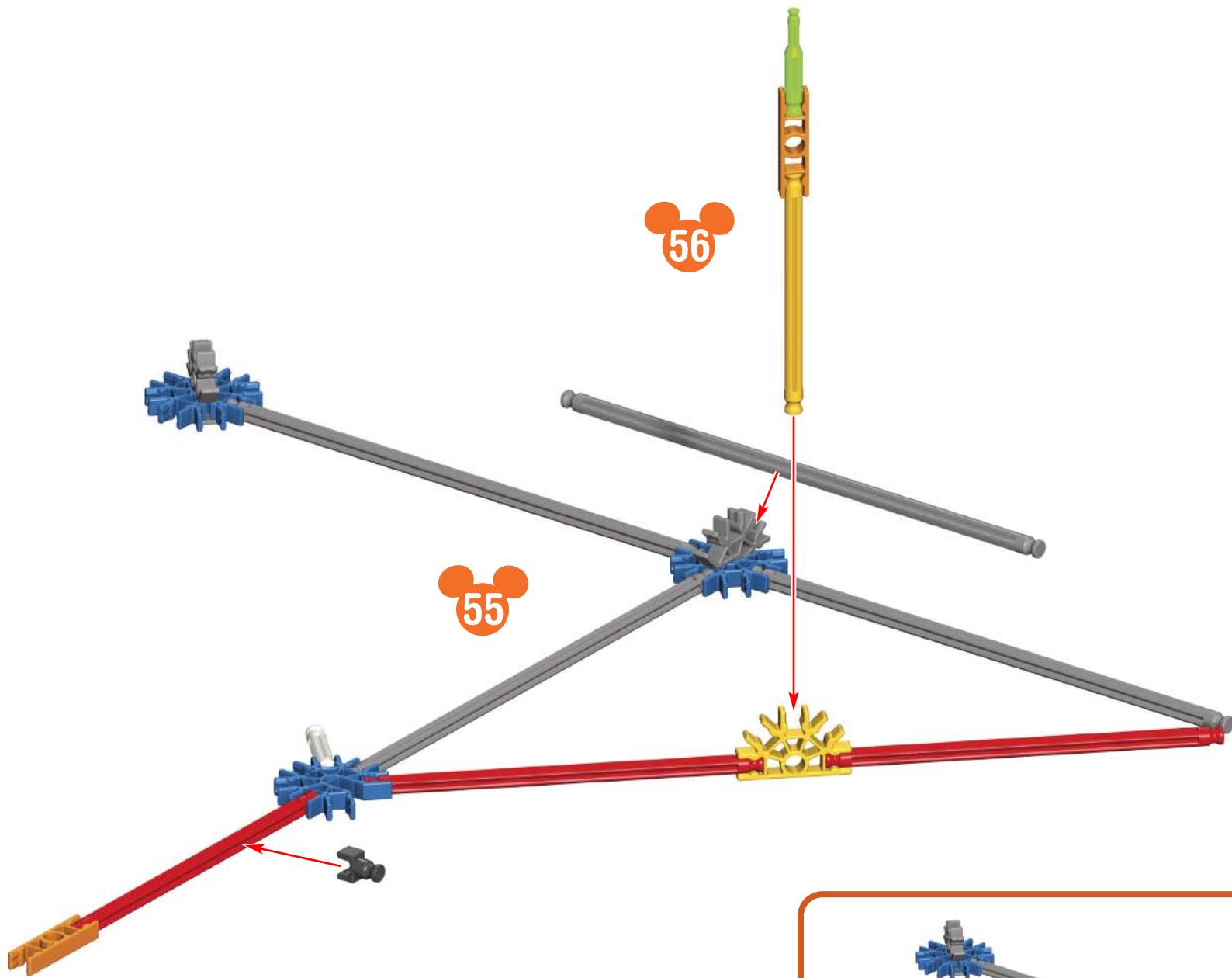

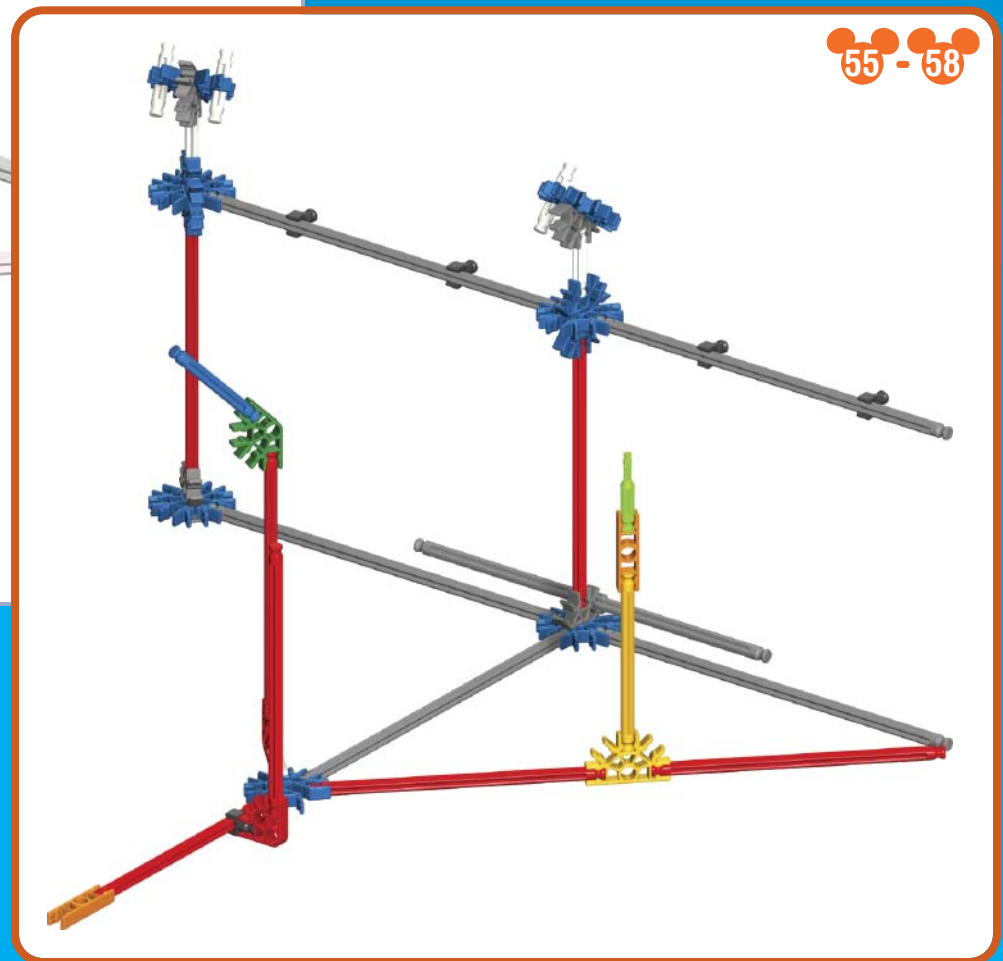
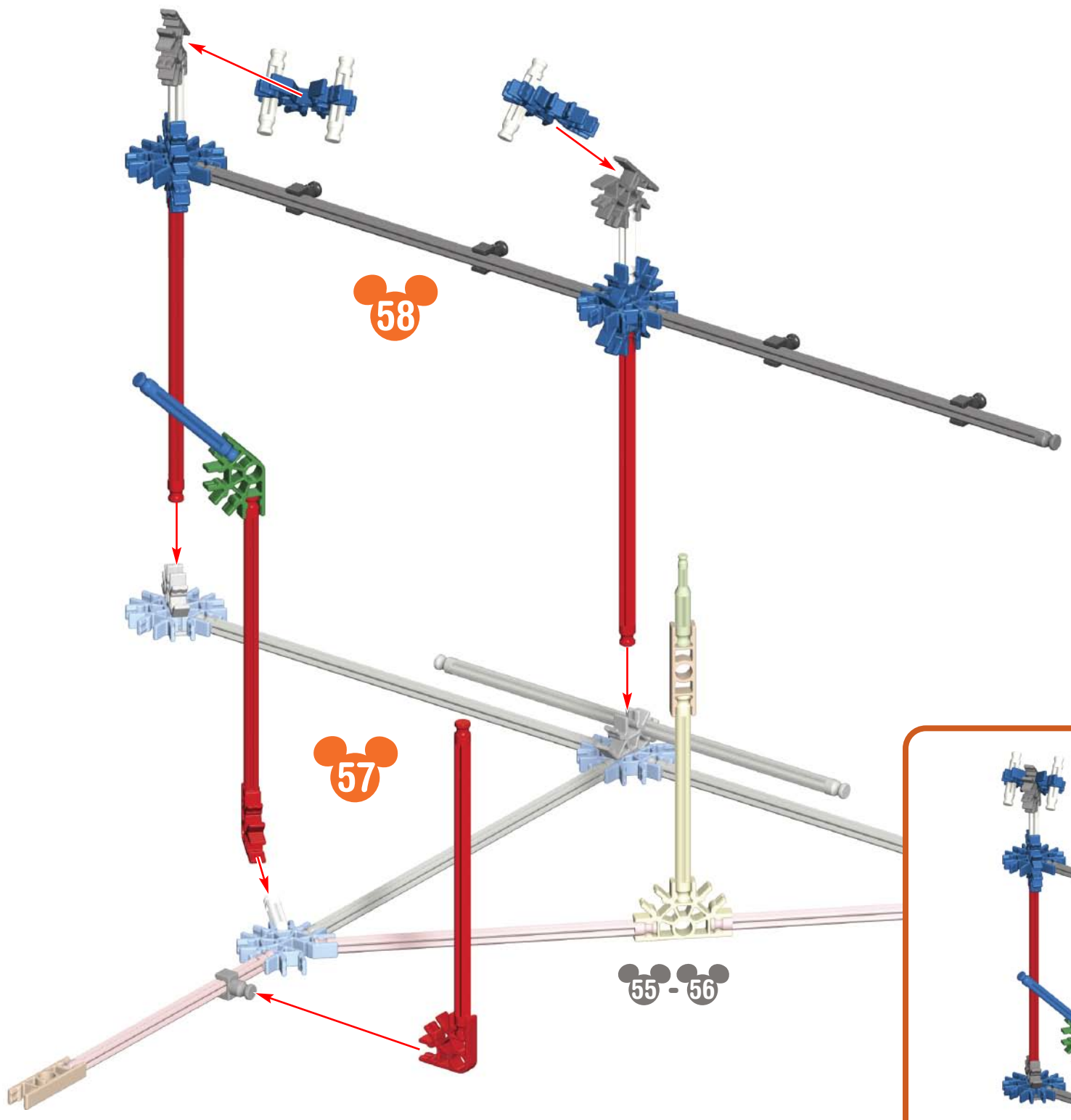

1-59

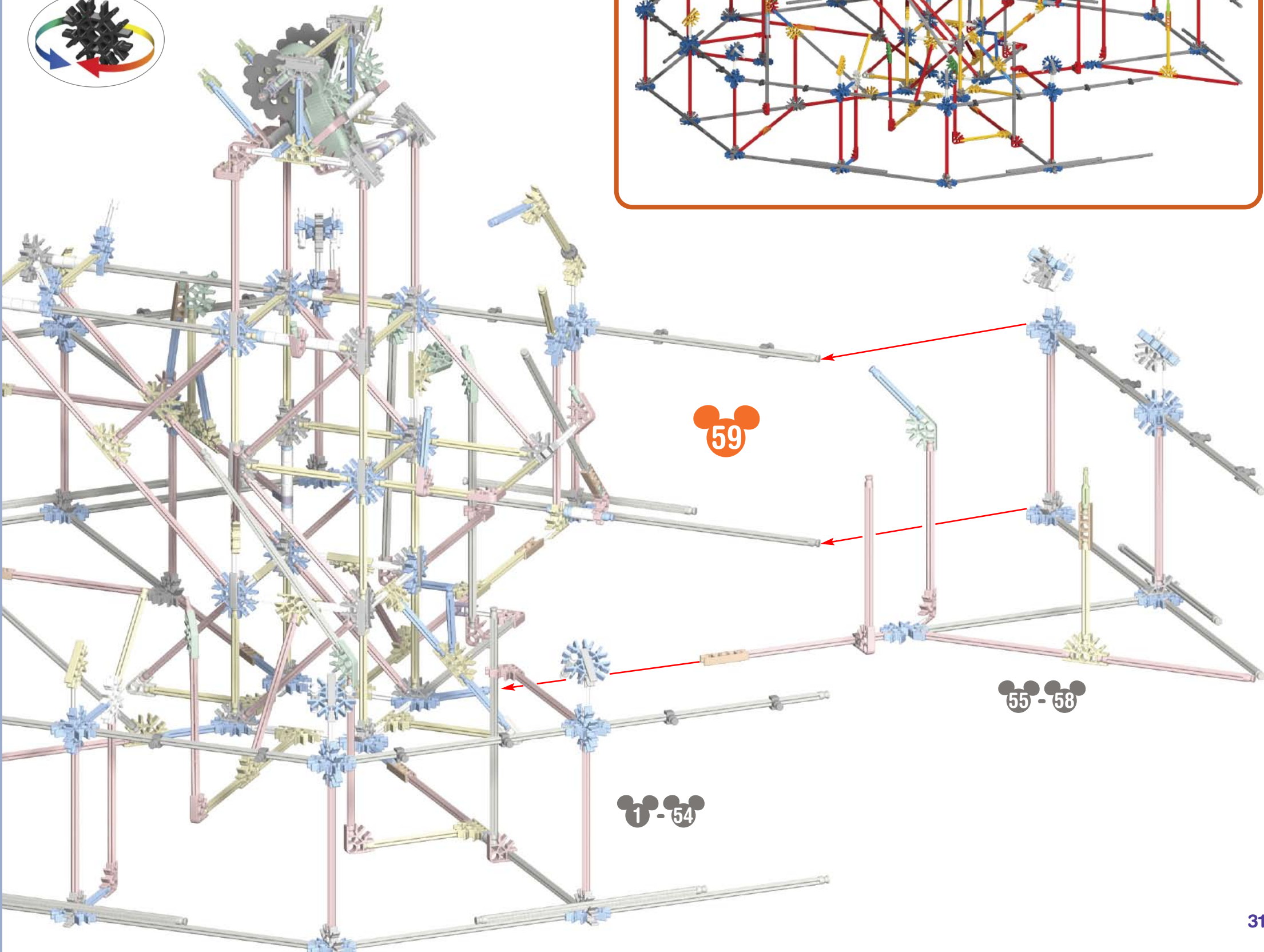

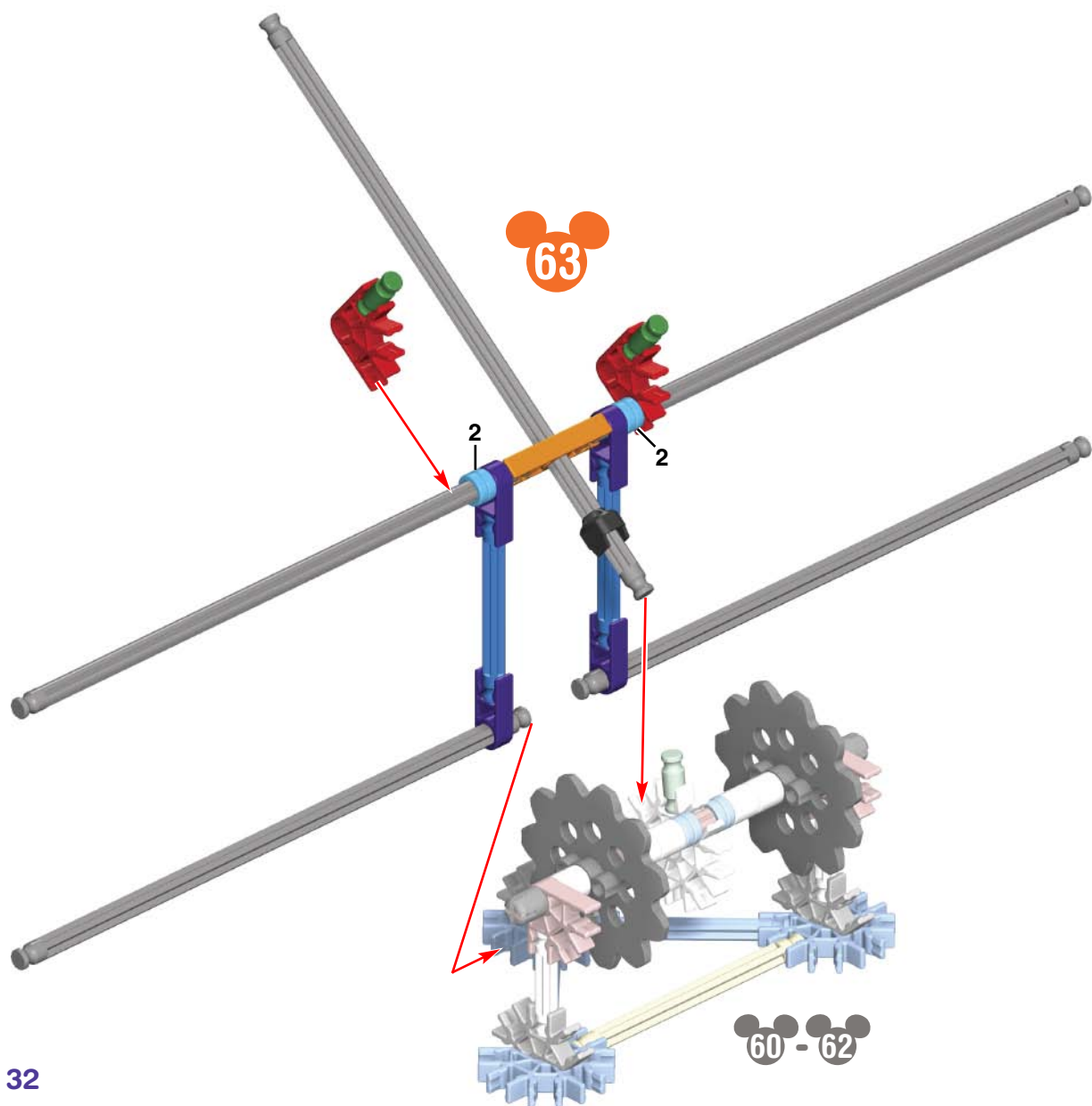
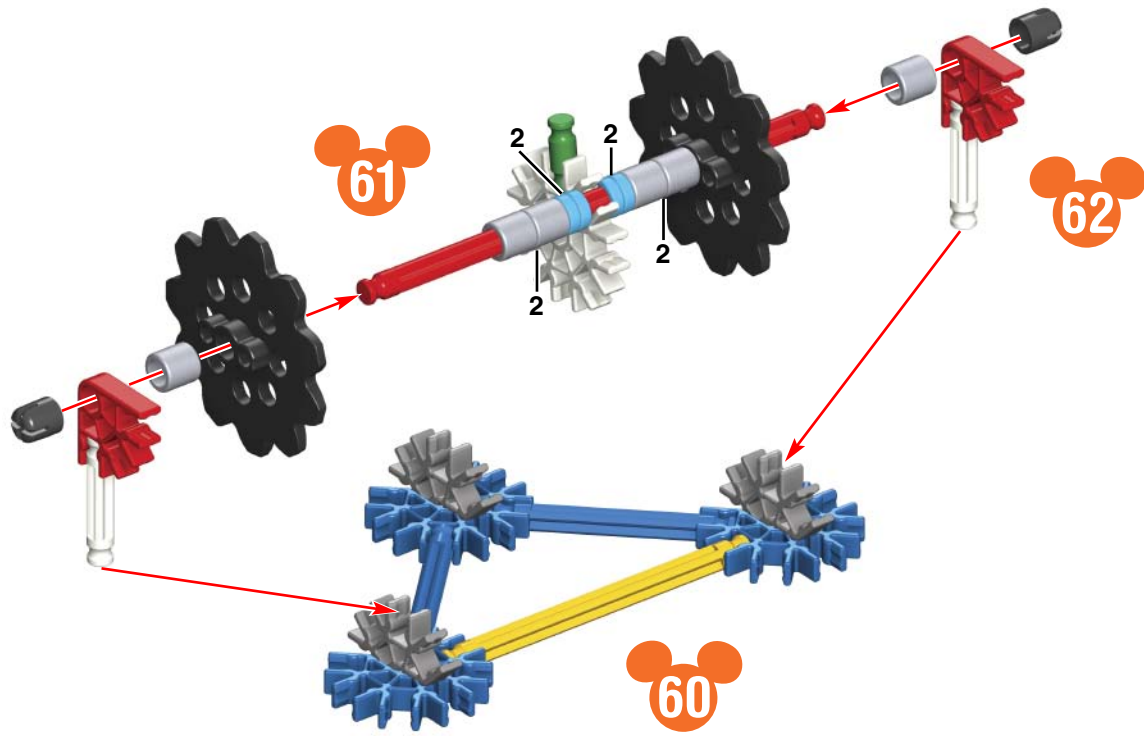

60-65

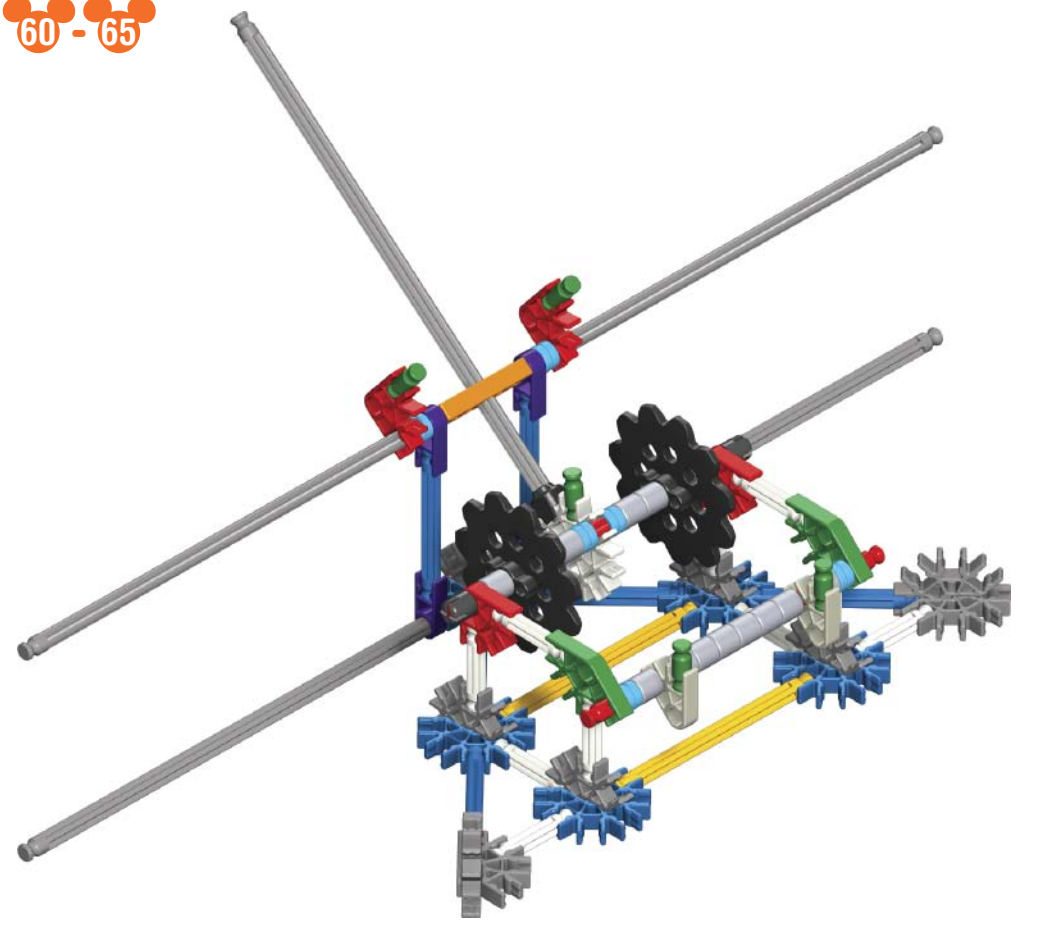

60-63

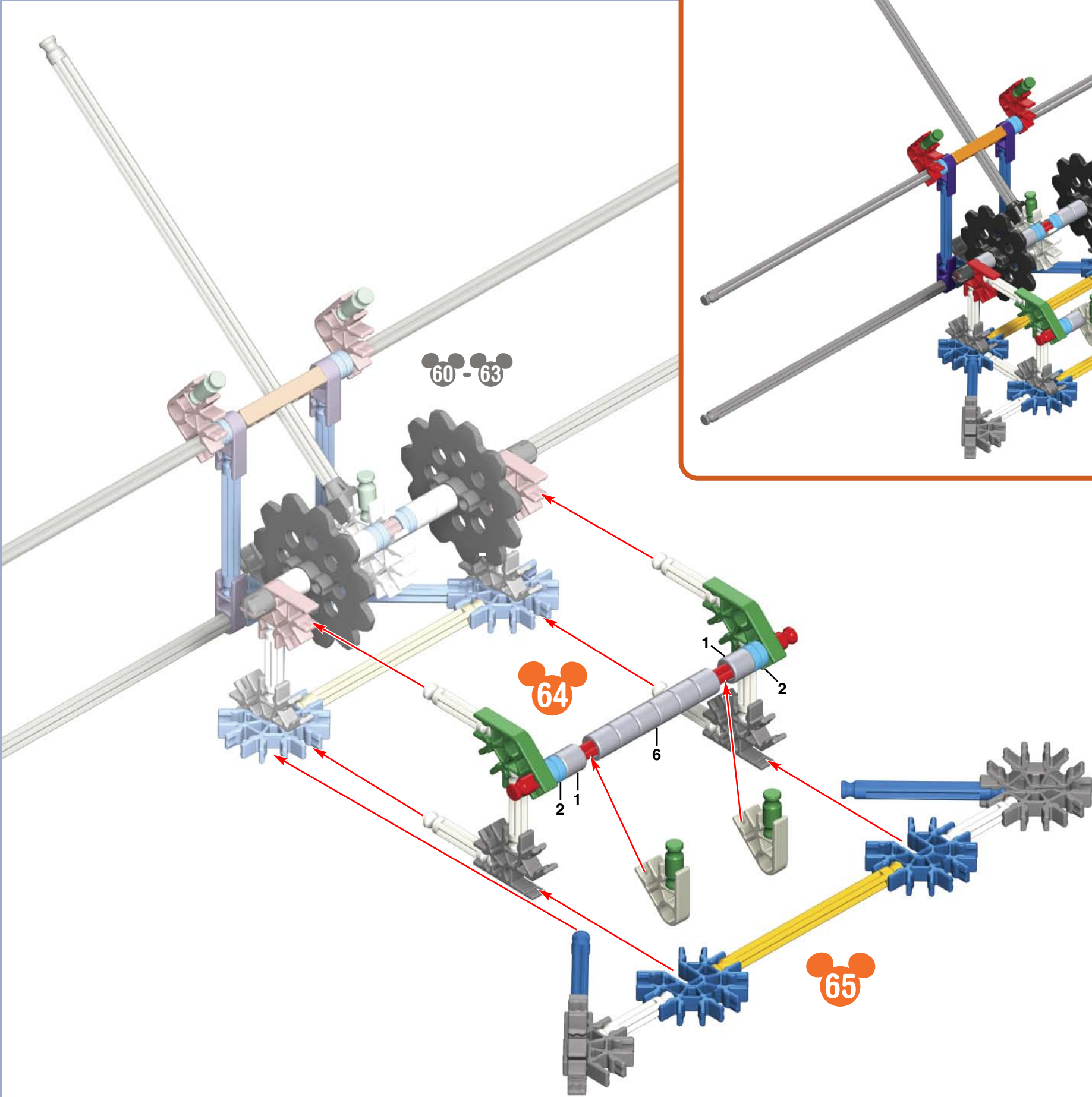

64

65

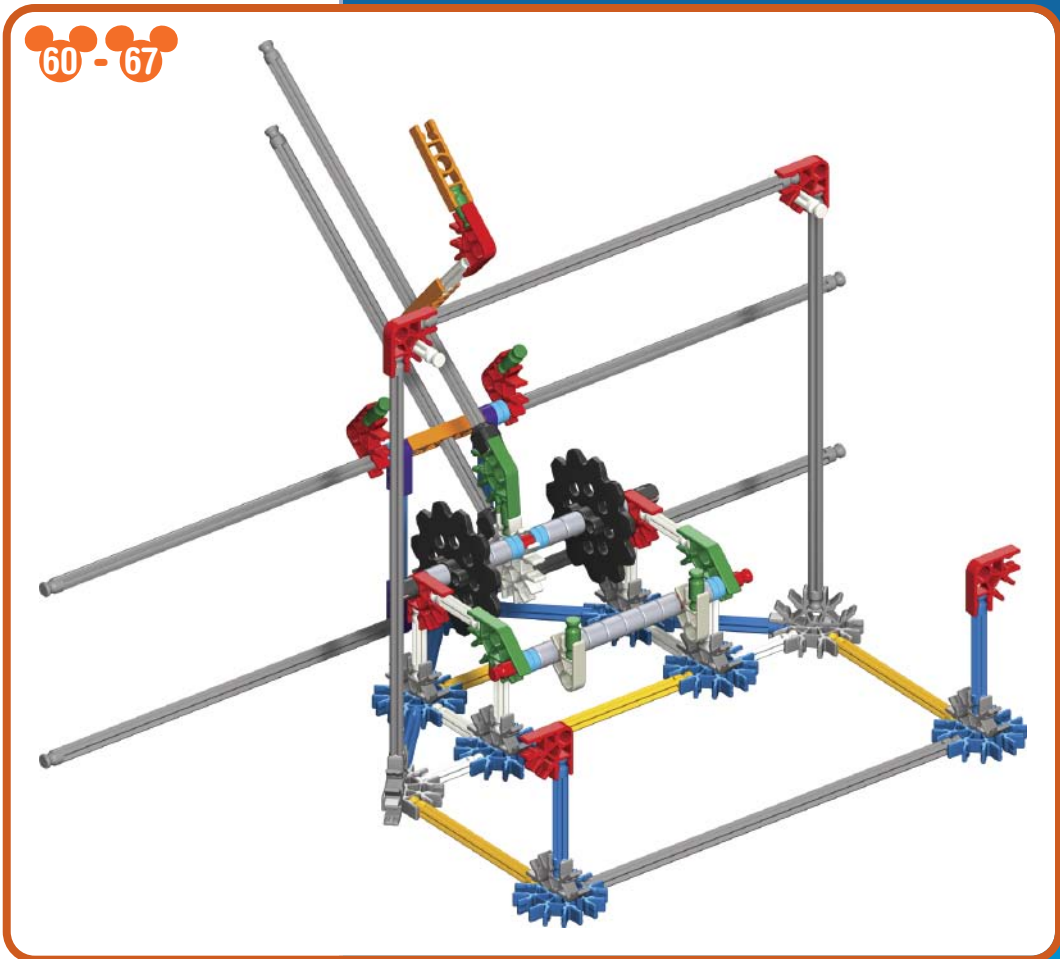
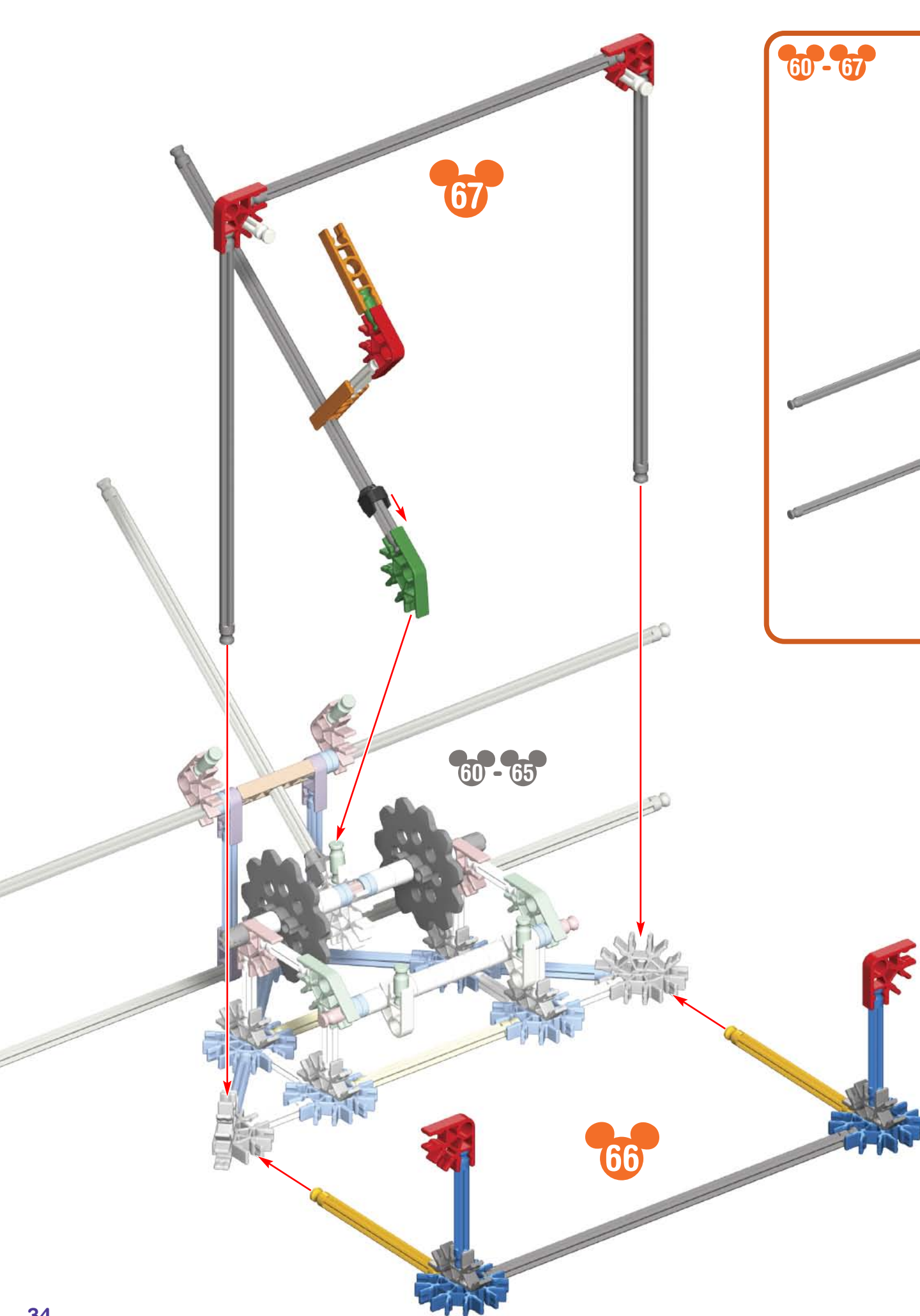

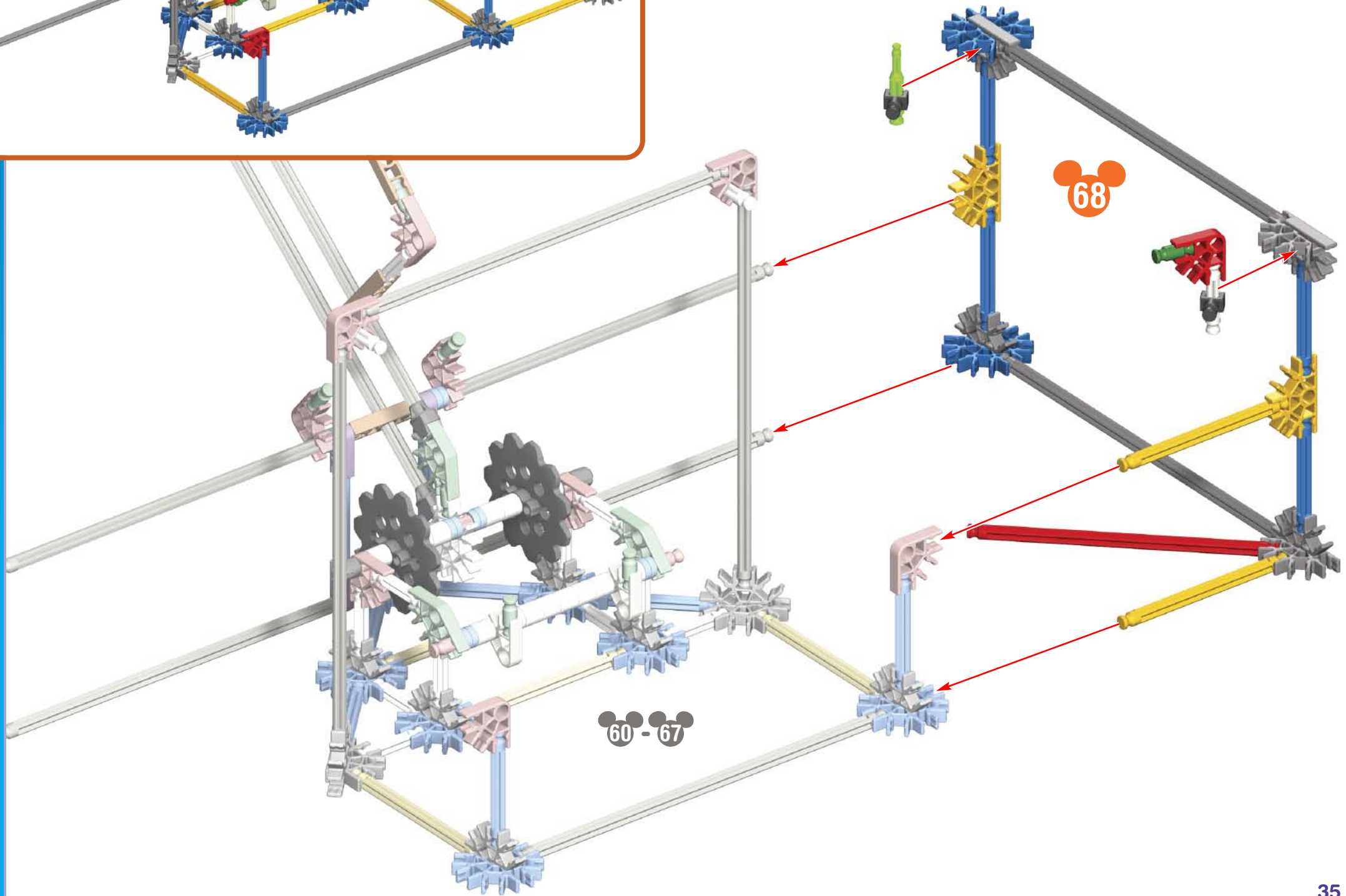
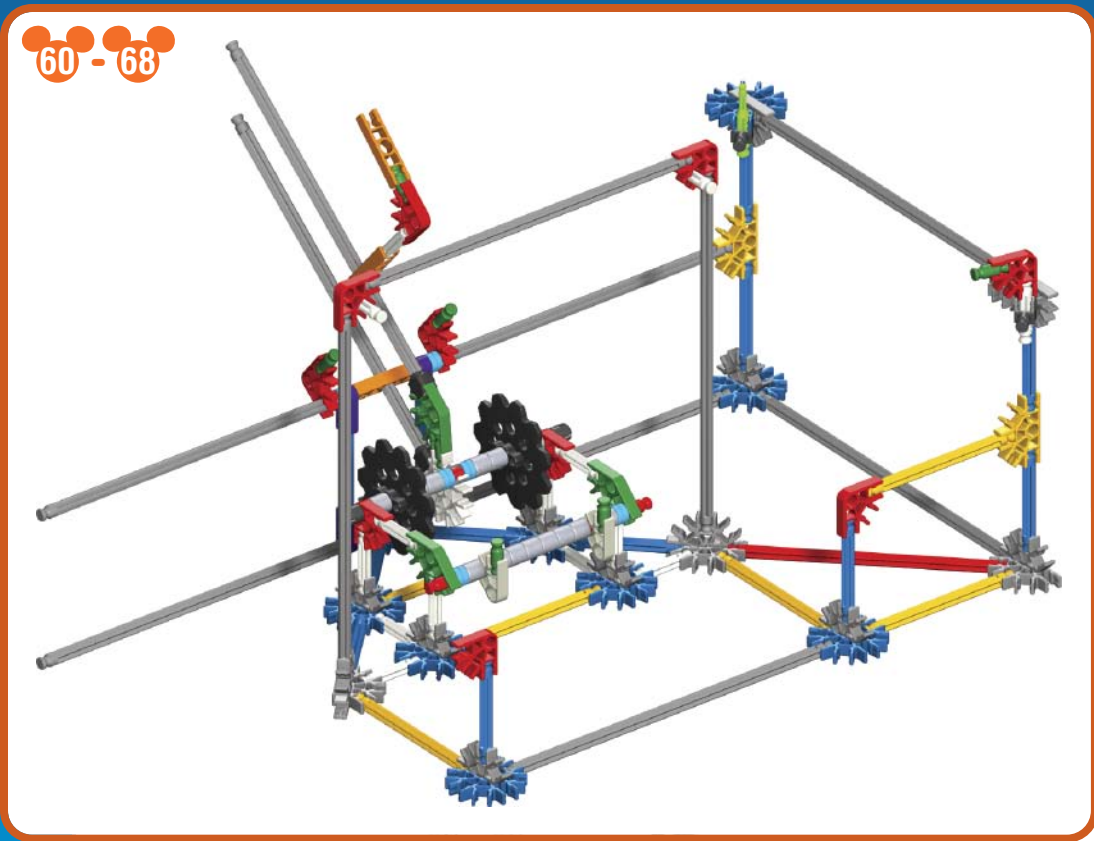

60-69

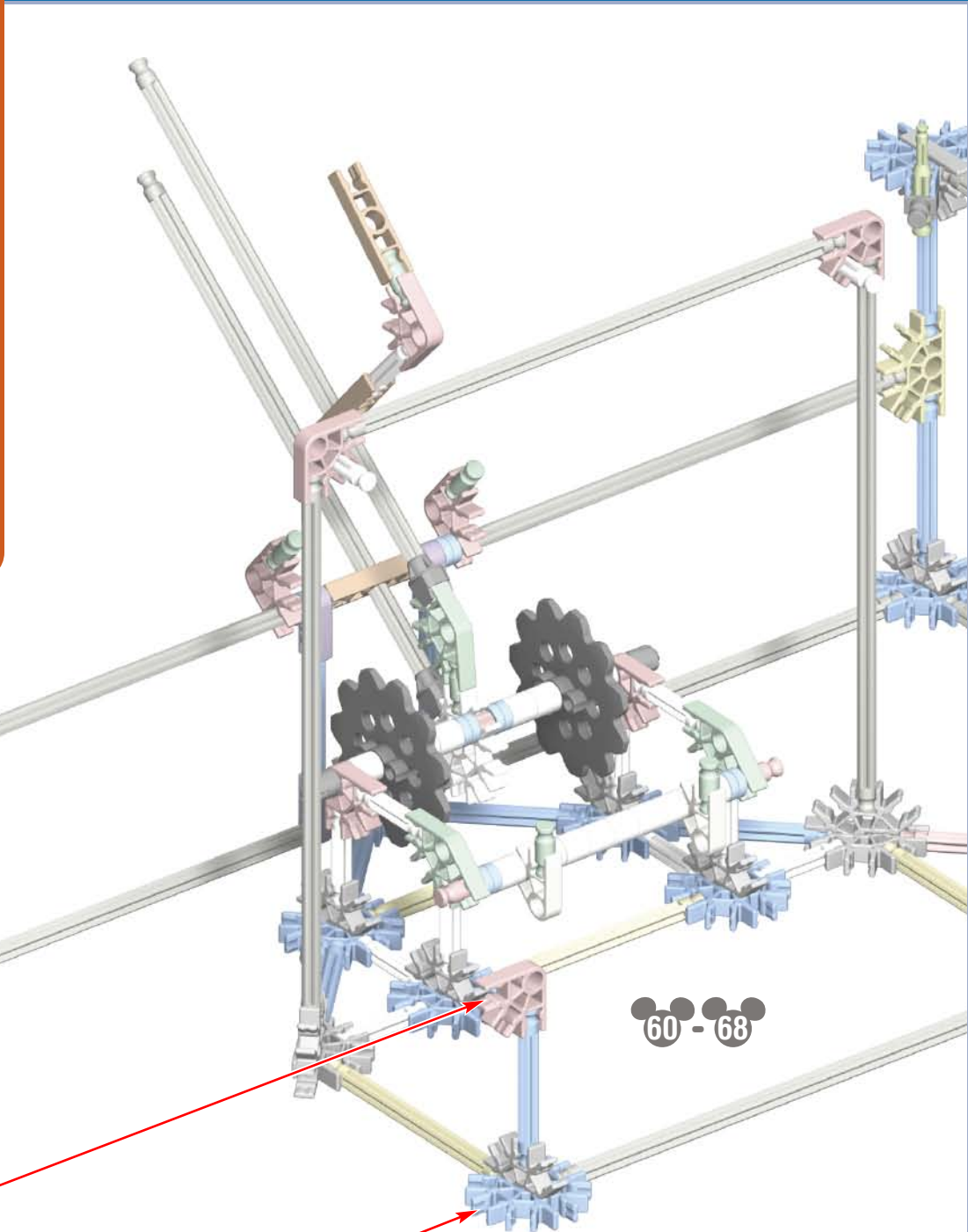
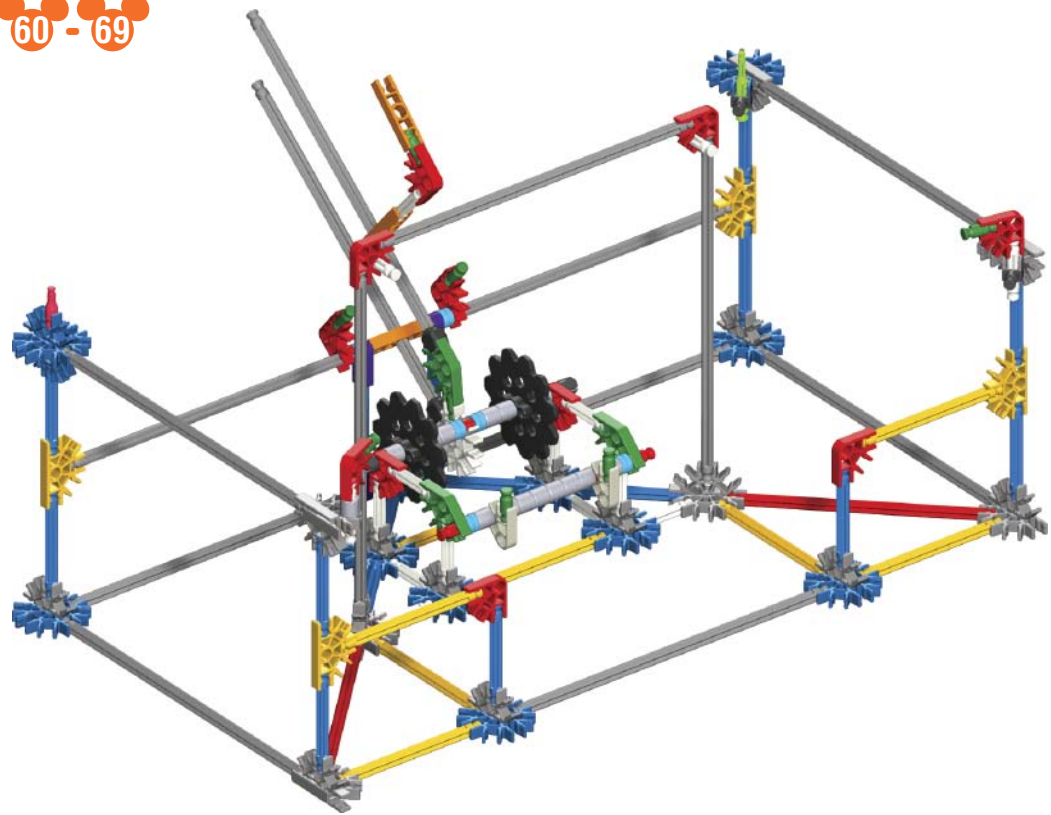

60-68

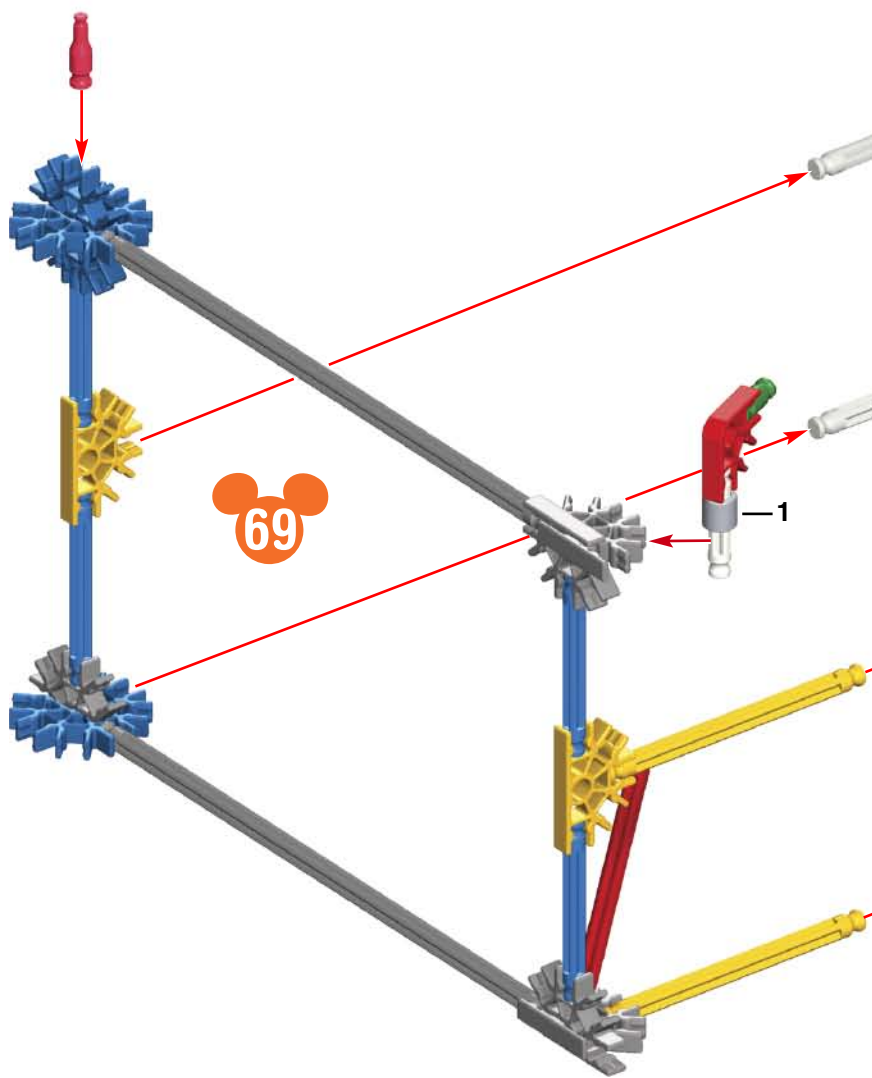

69

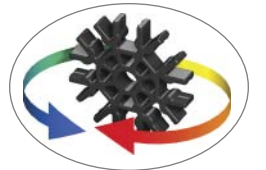
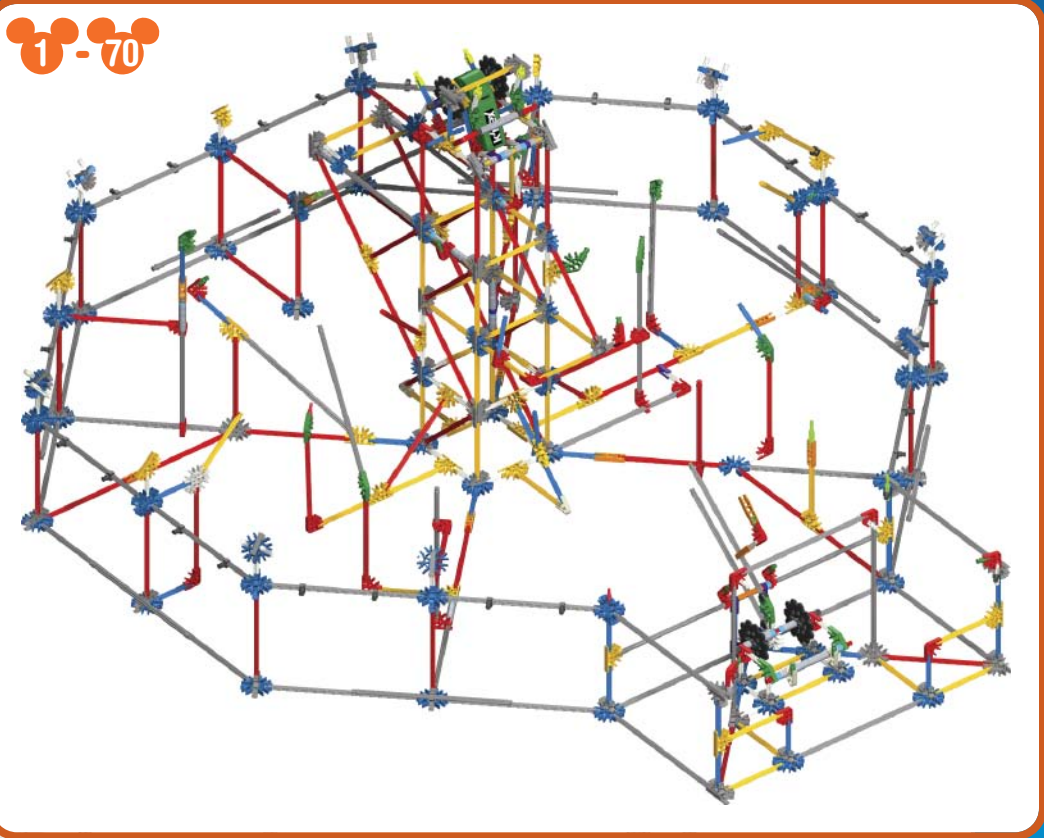
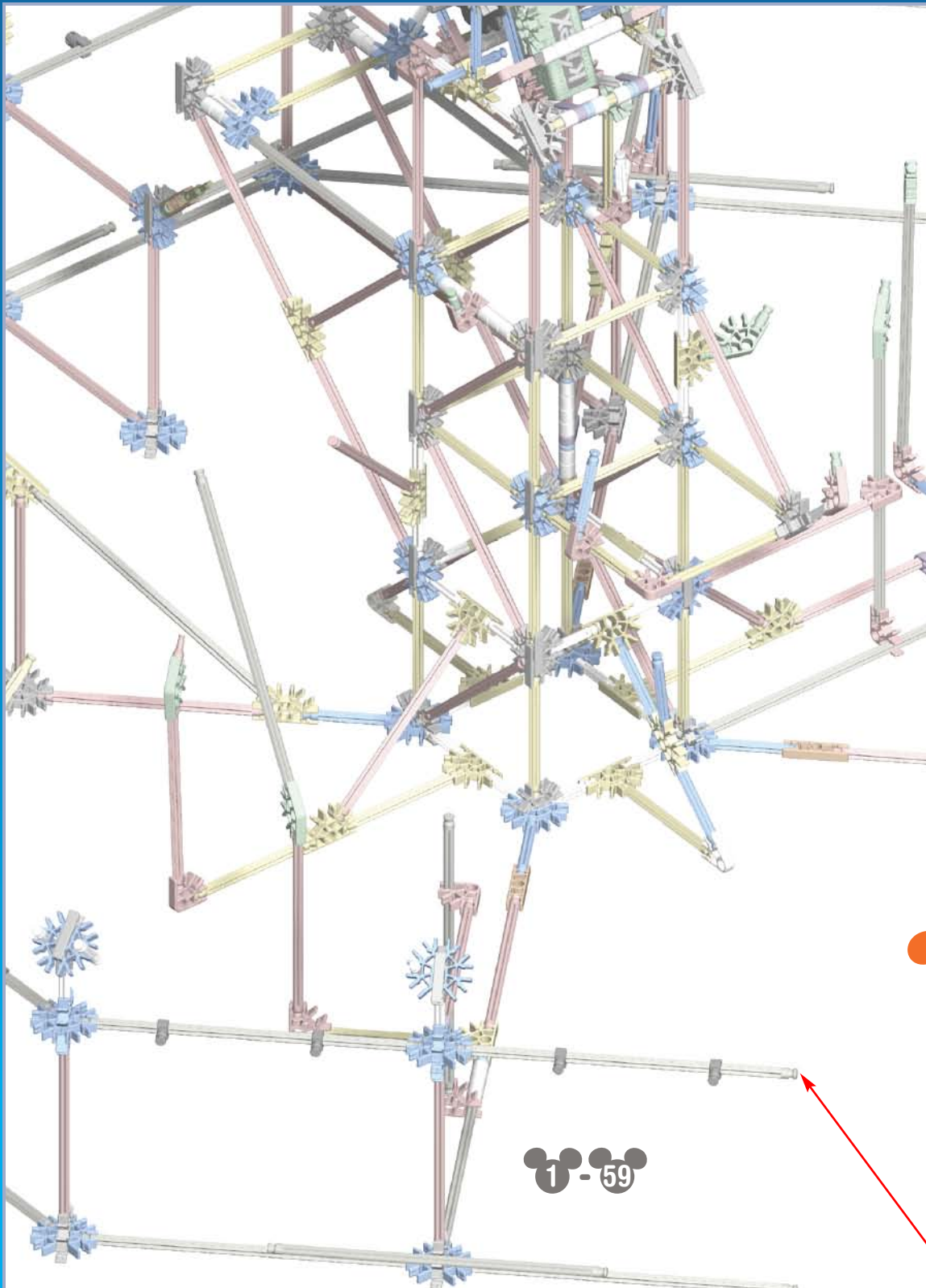

1-59

70

60-69

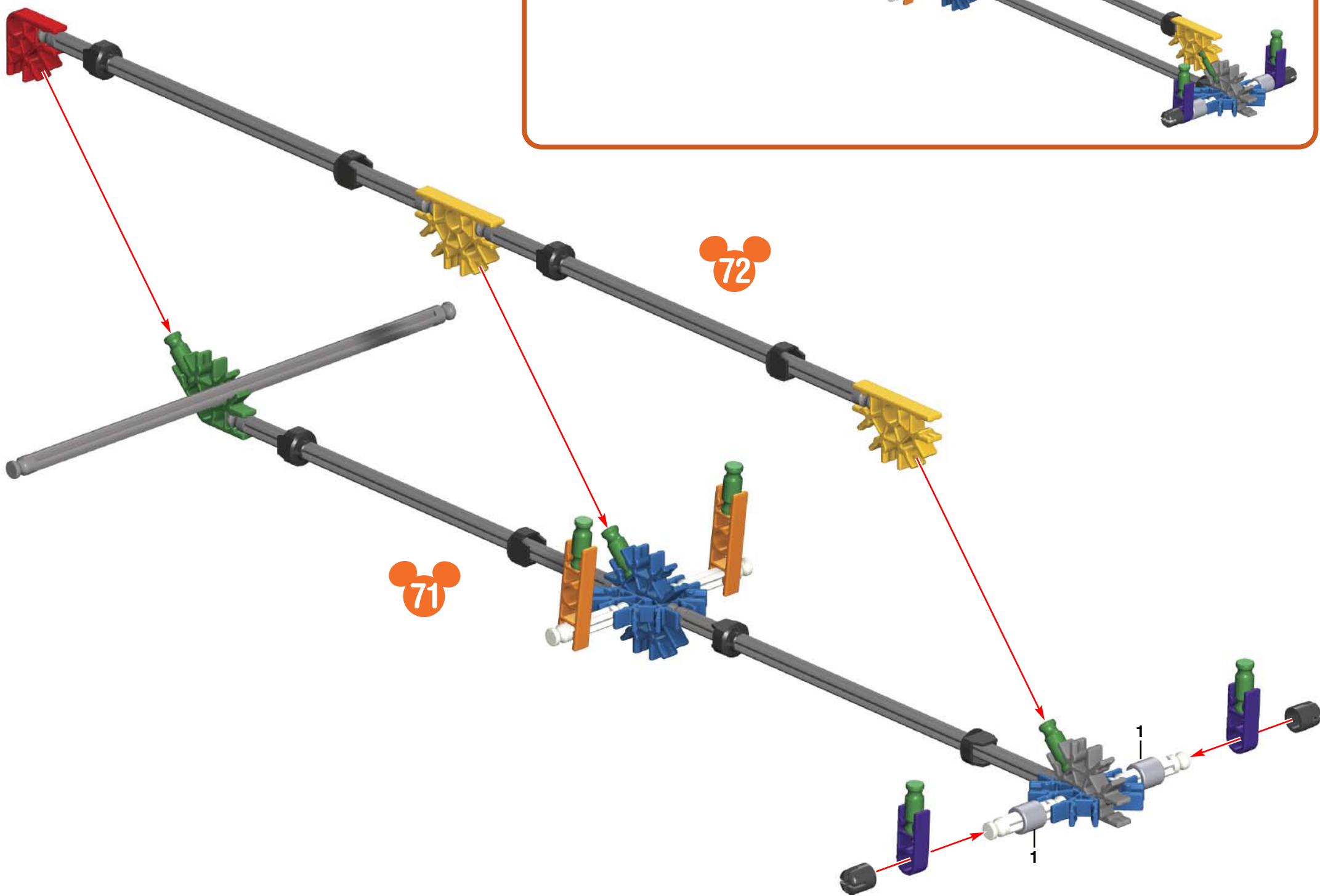

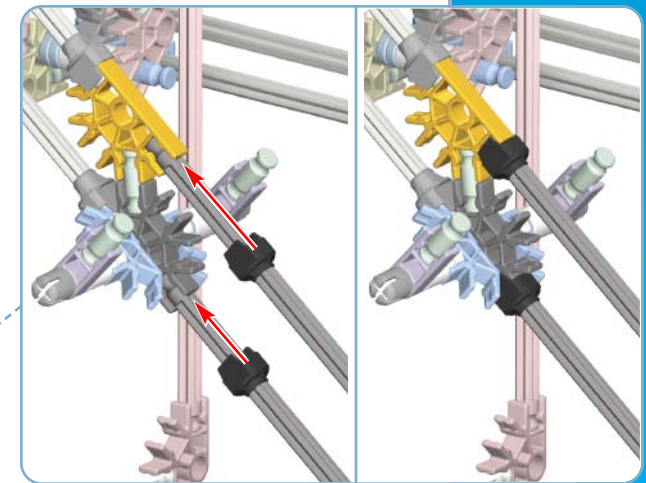
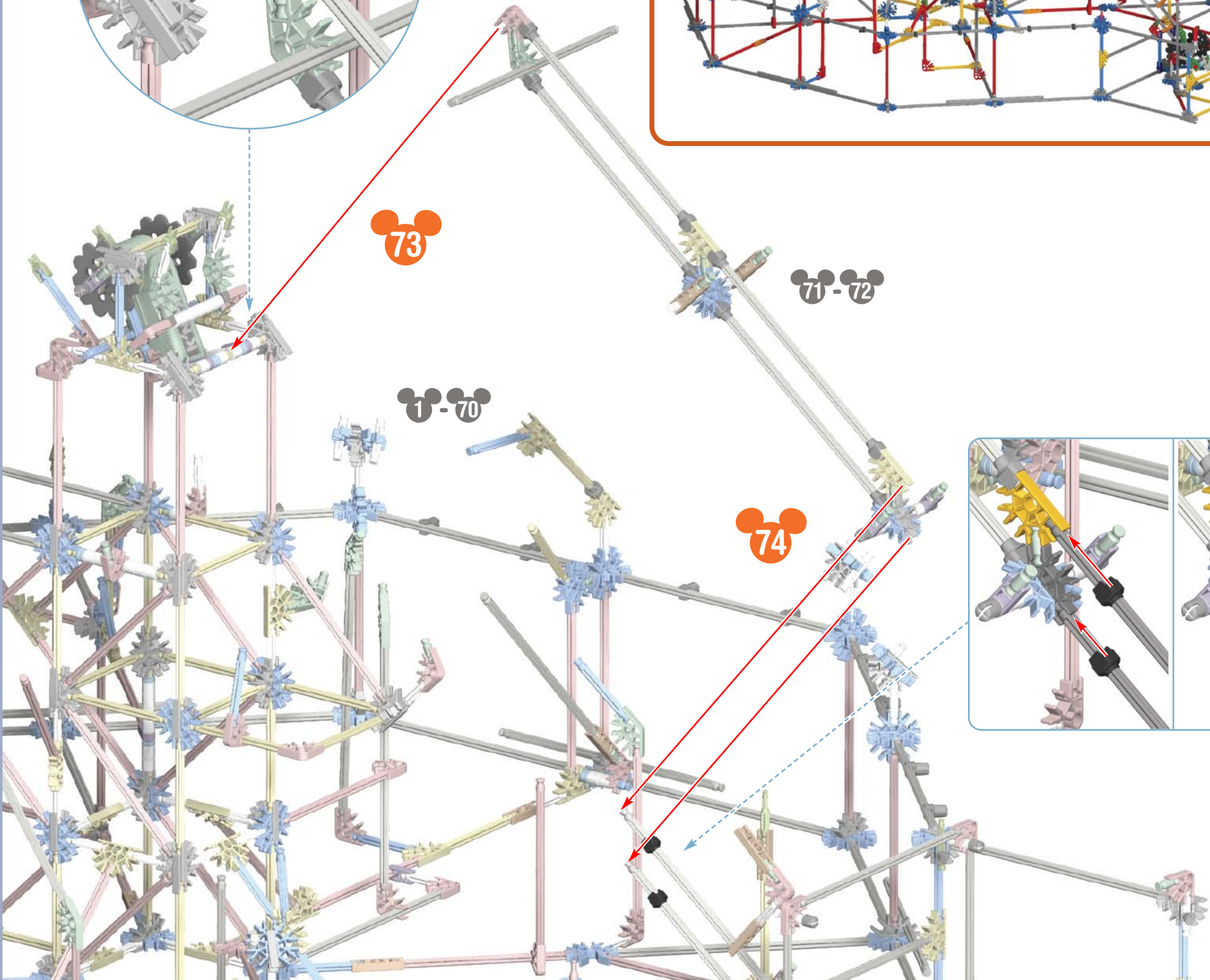
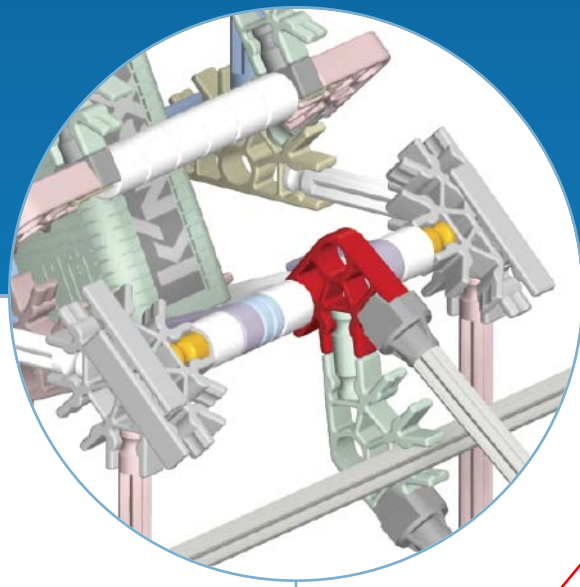

## Track Building Tips:

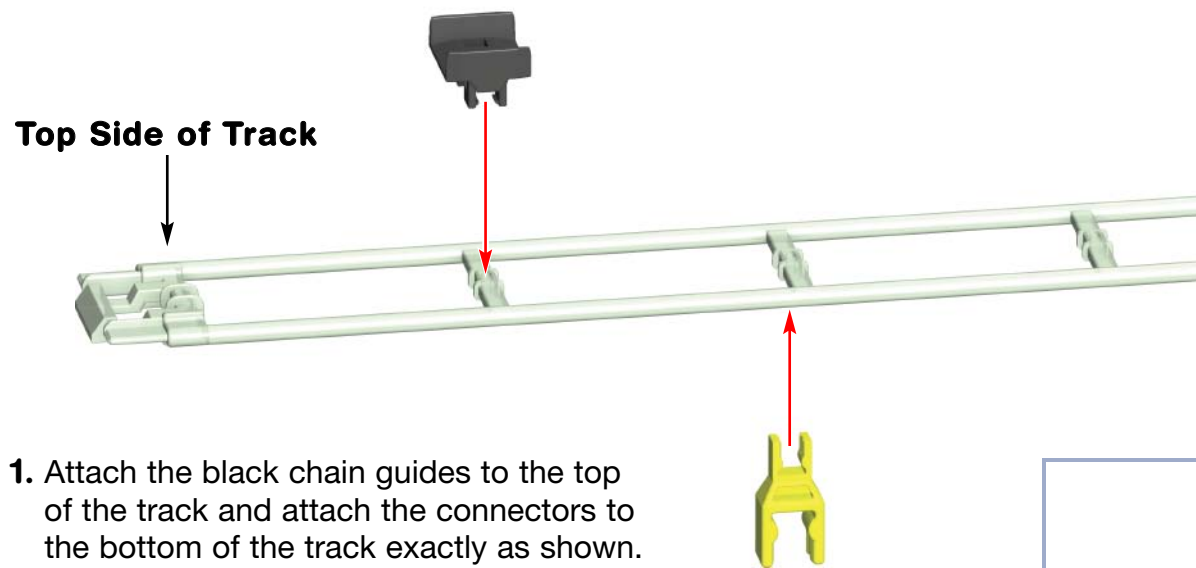

3. Always connect the track top side to top side throughout the build.

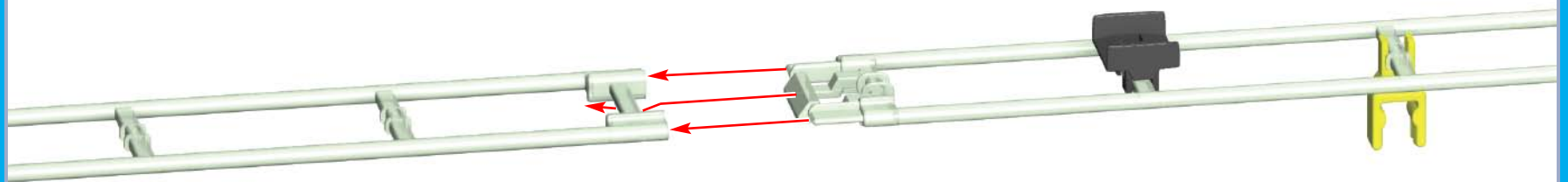

# Track A

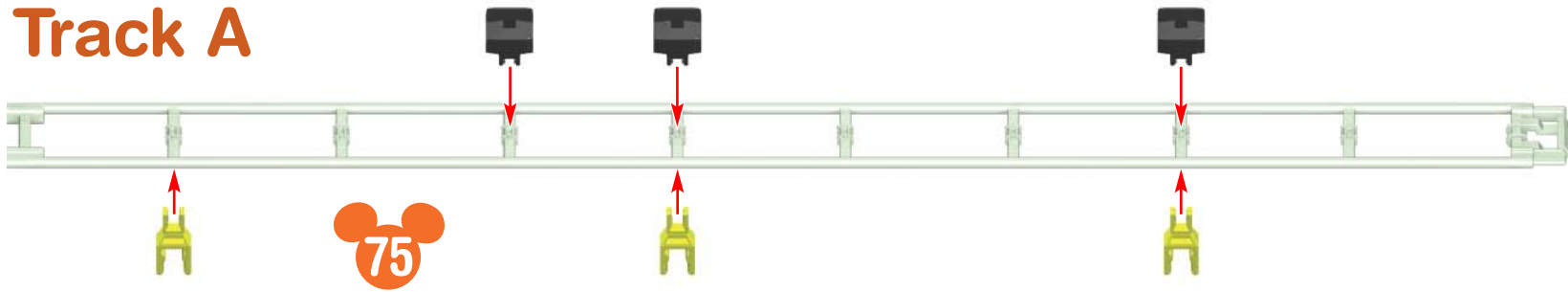

1-76



76

1-74

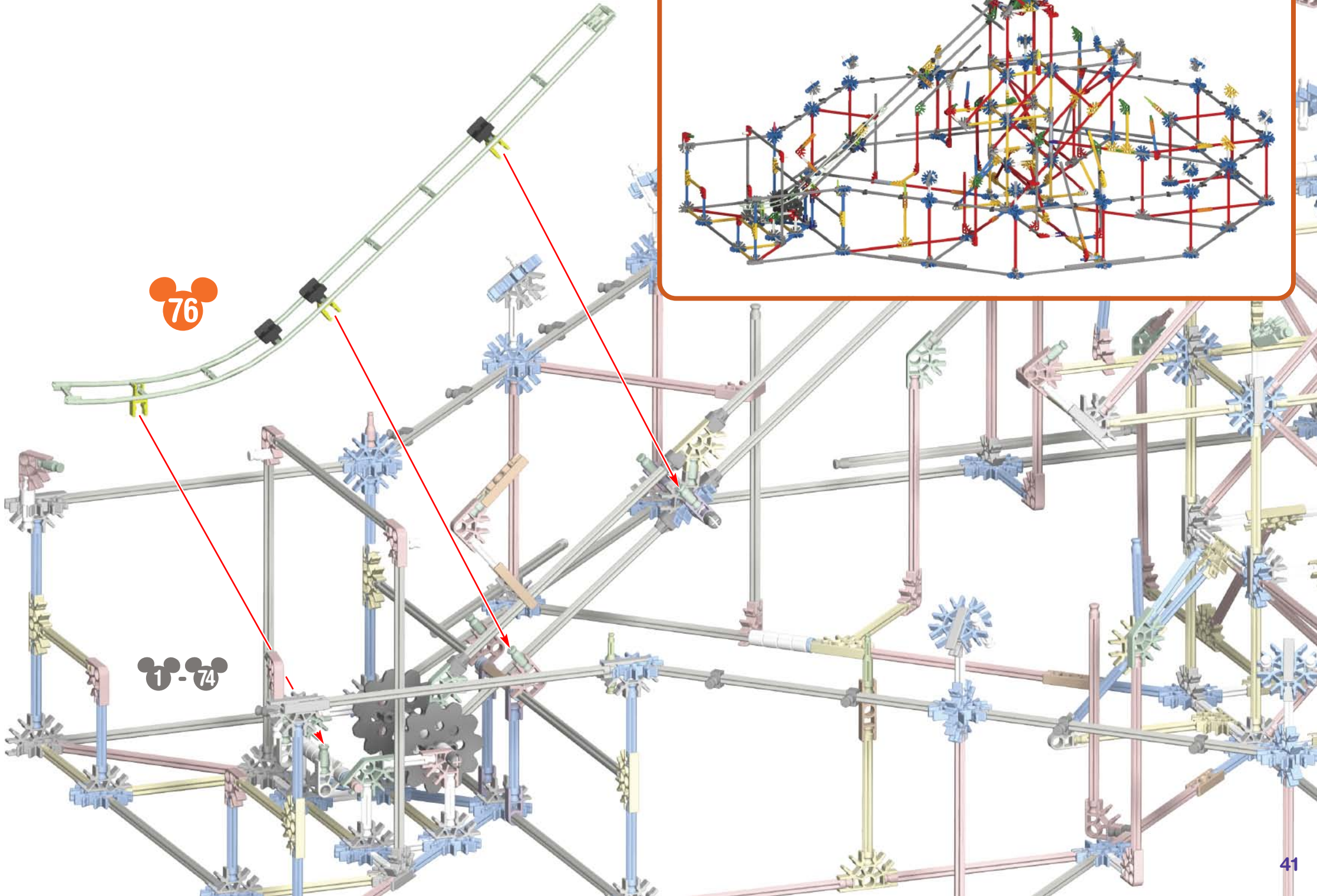

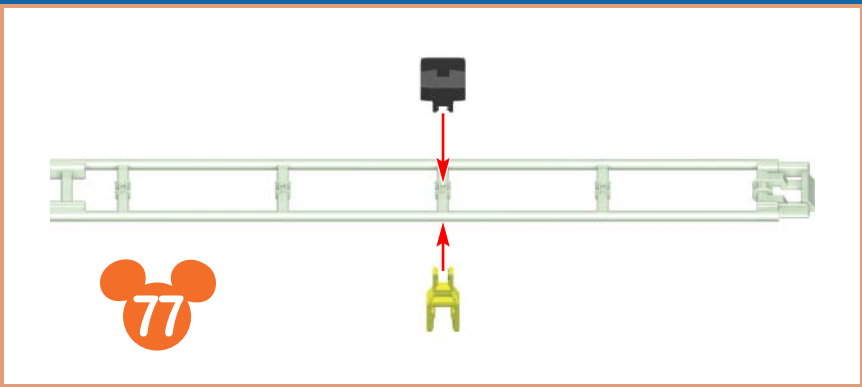

Always join this end of the track to the previous track piece first, then connect the rest of the track to the tower.

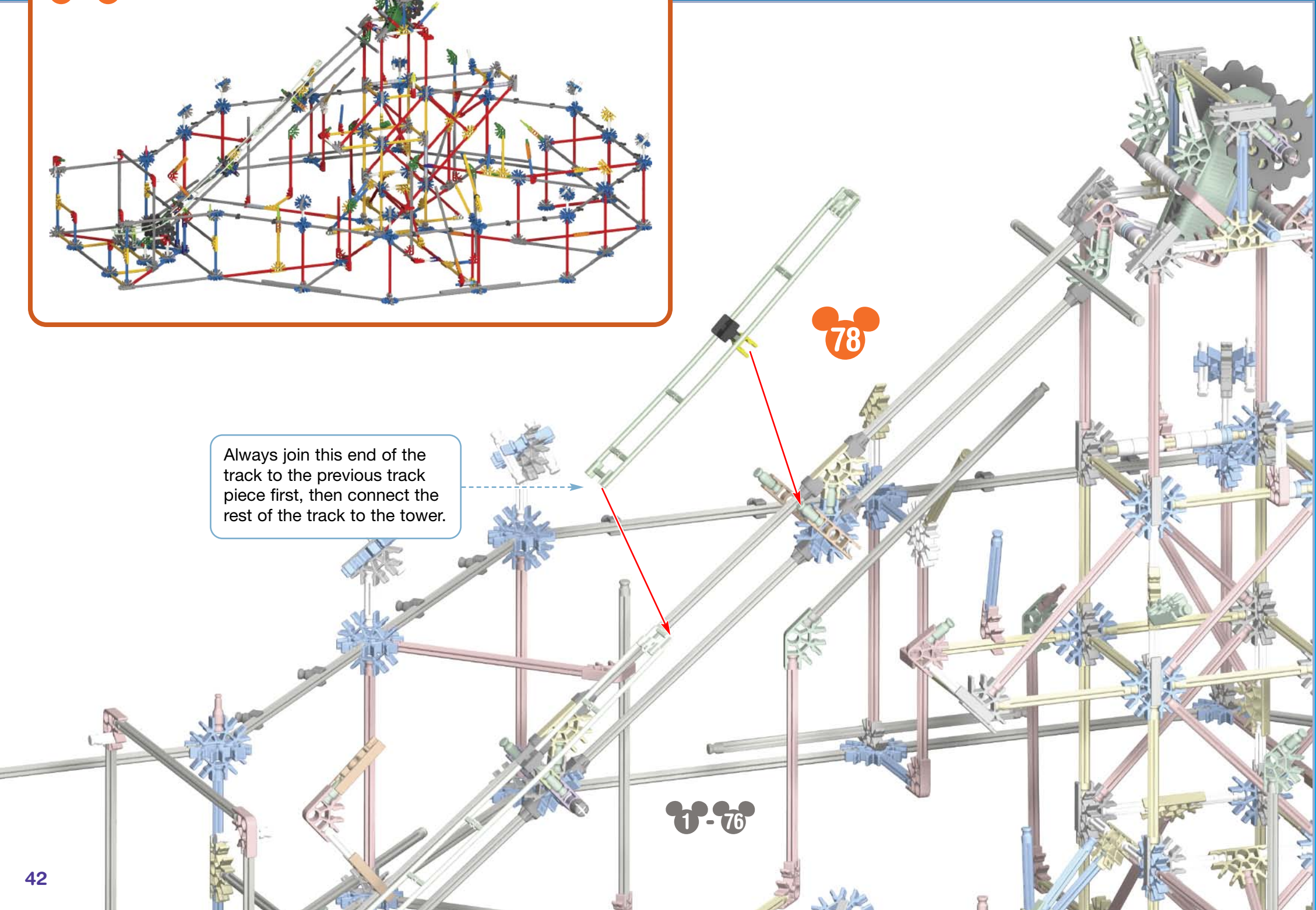

1-76

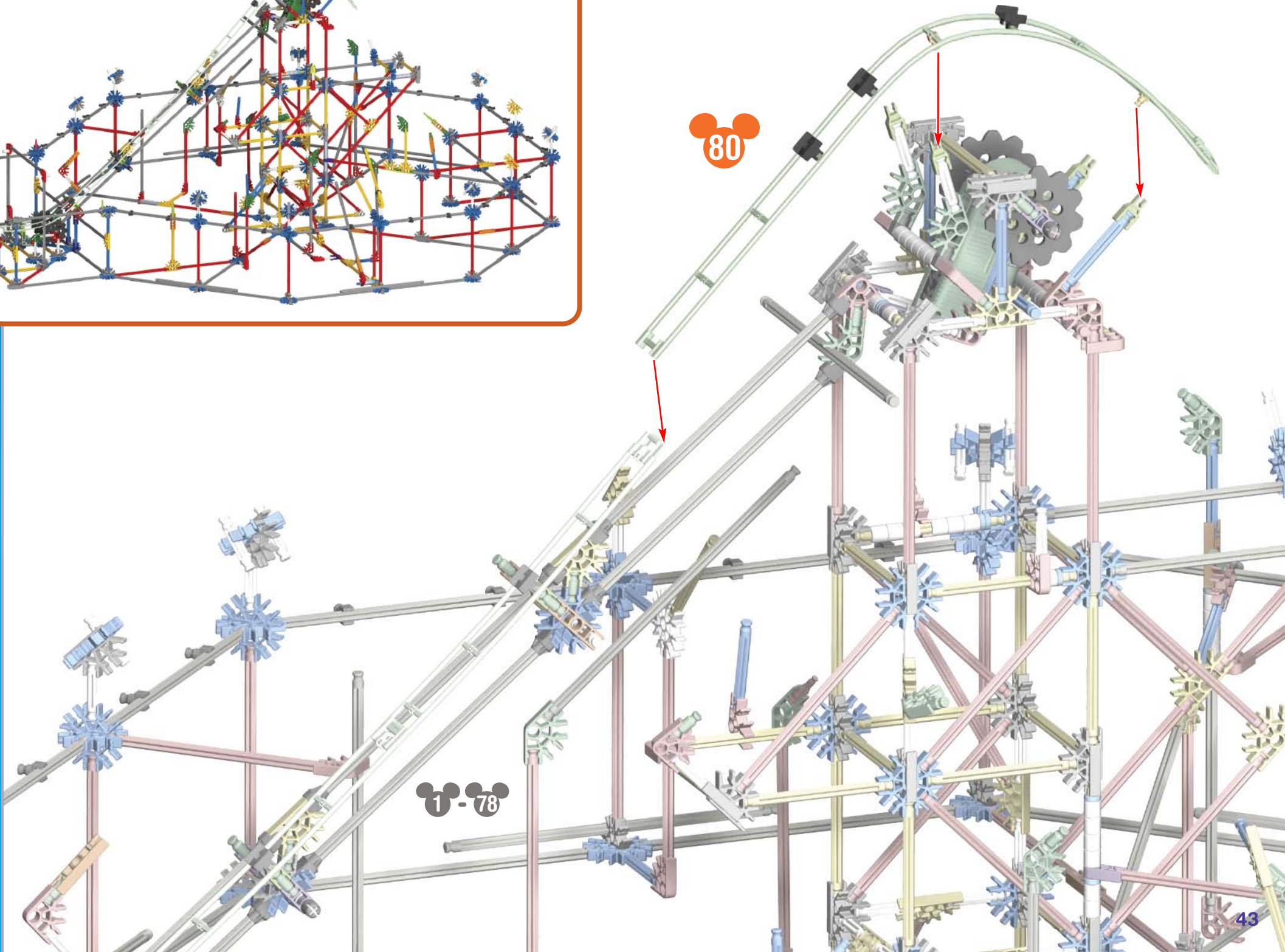
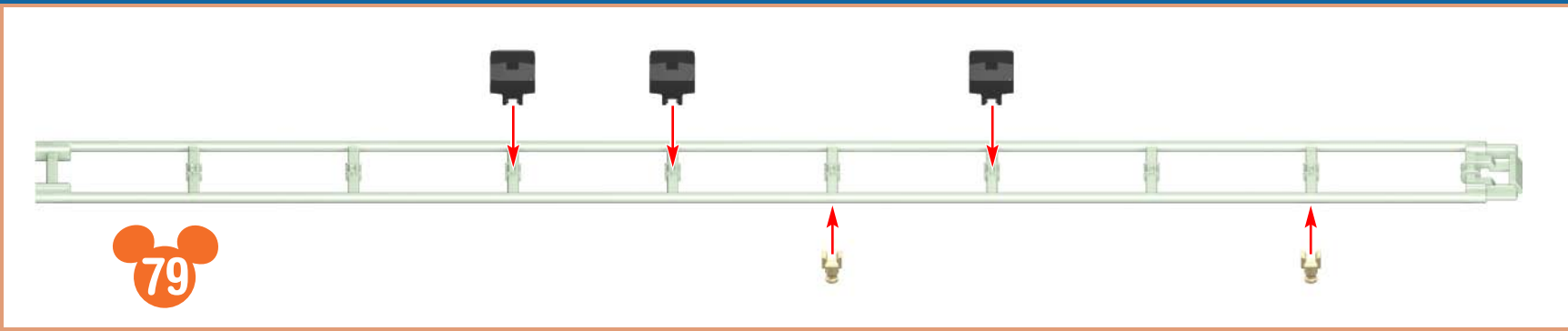

1-78

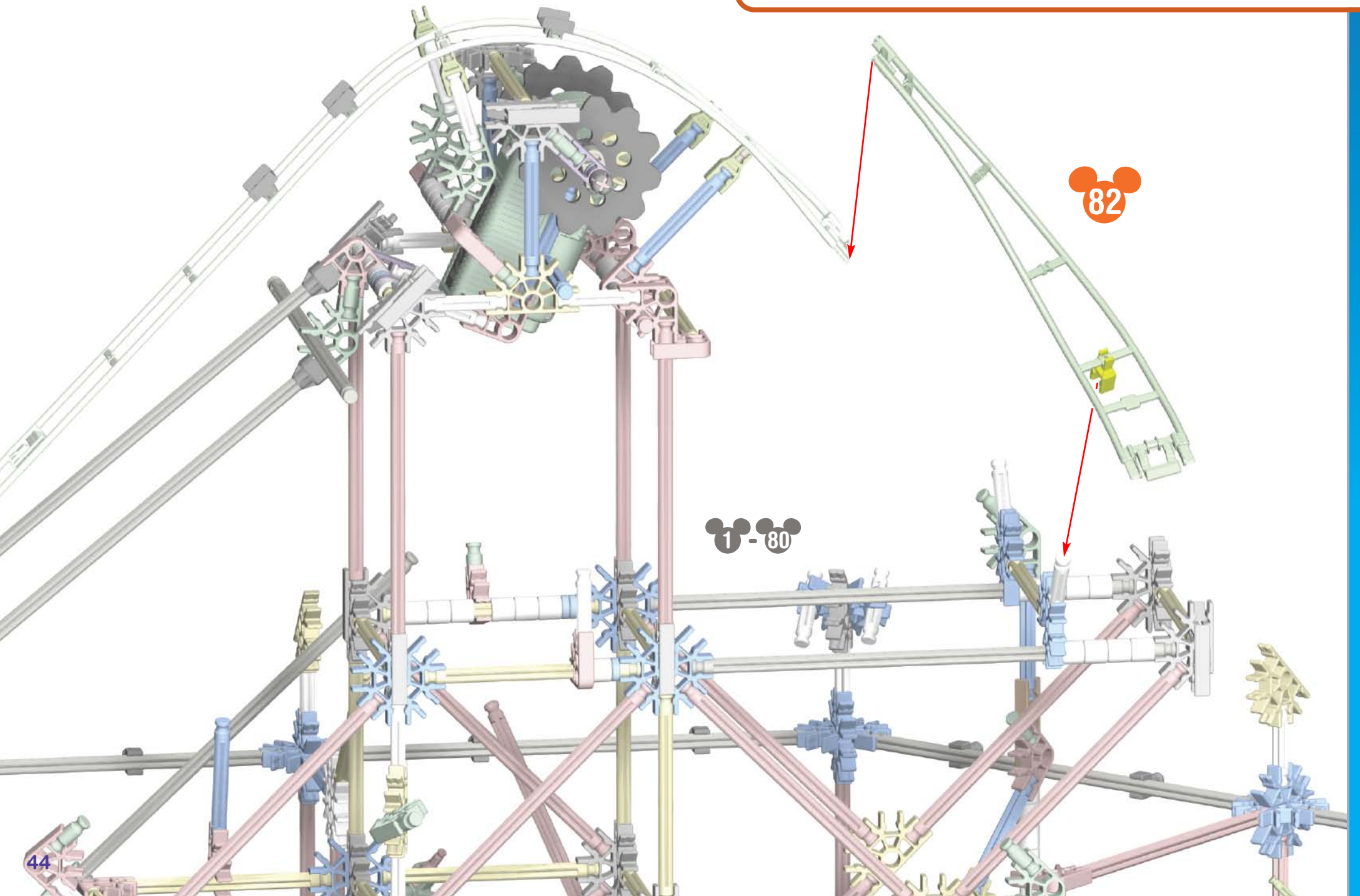
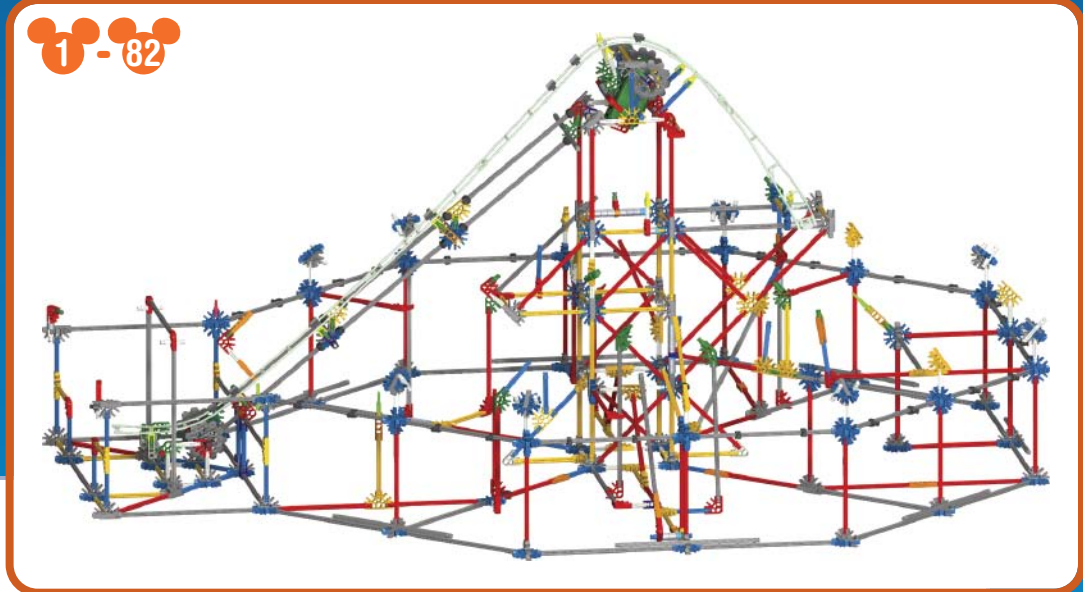
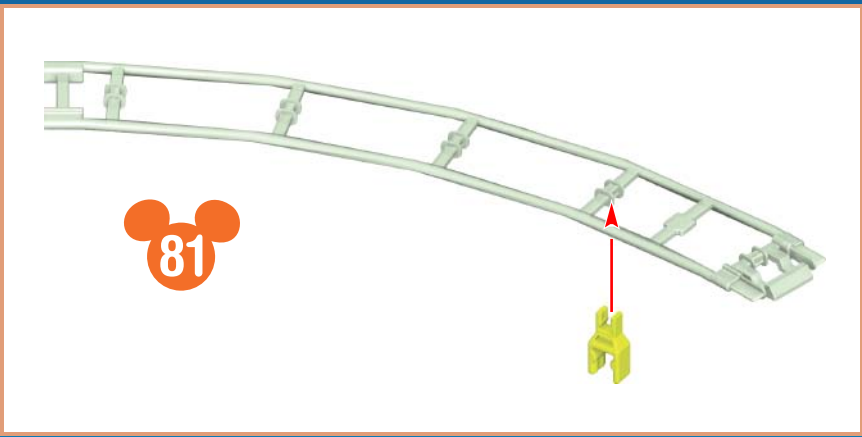

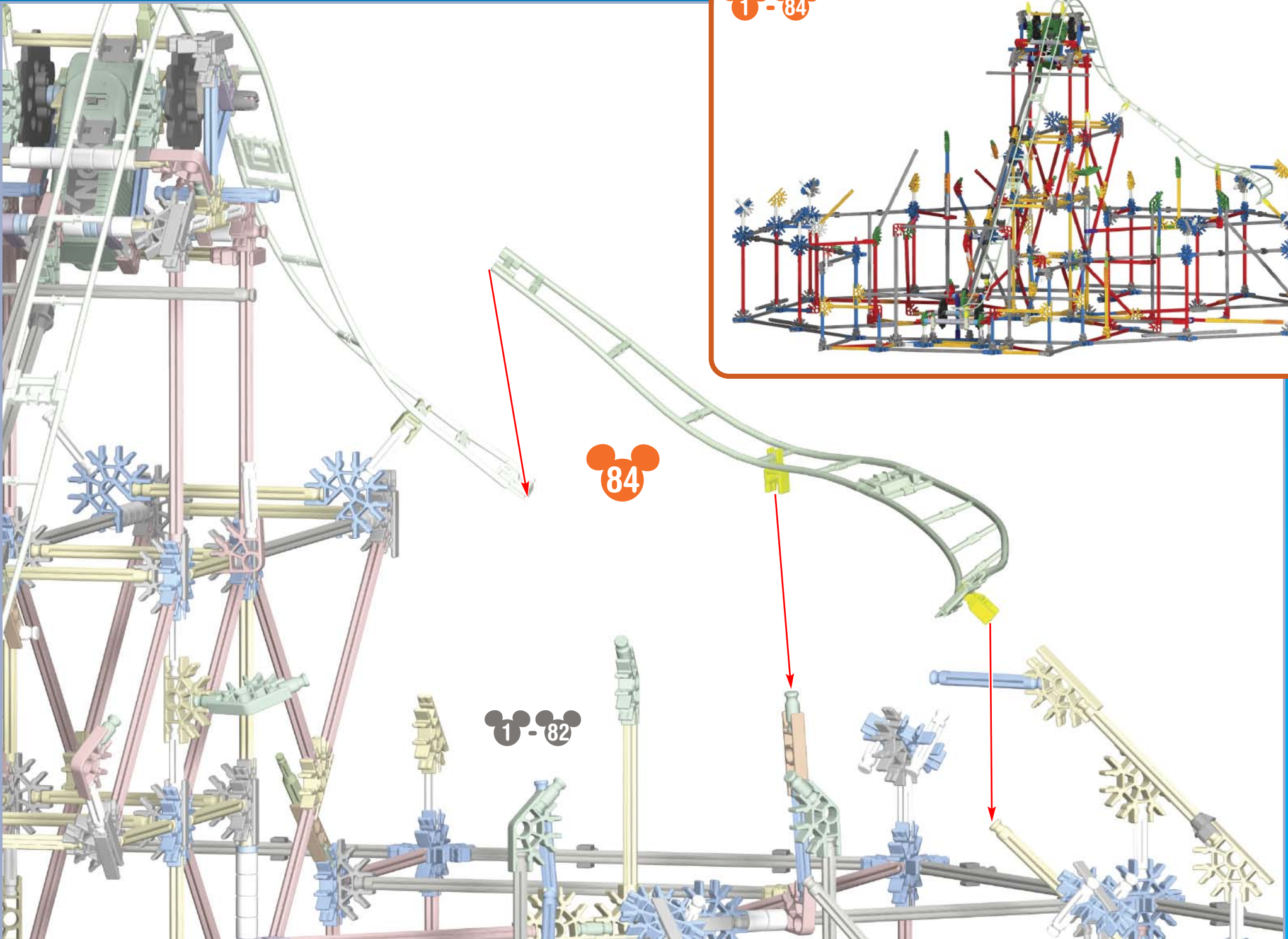
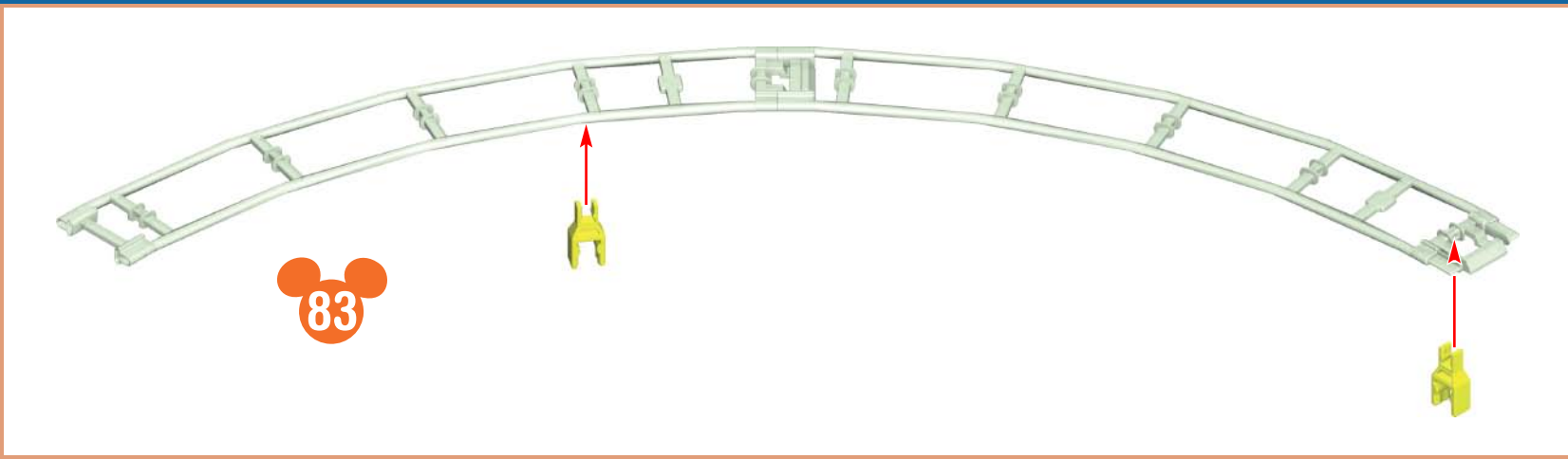

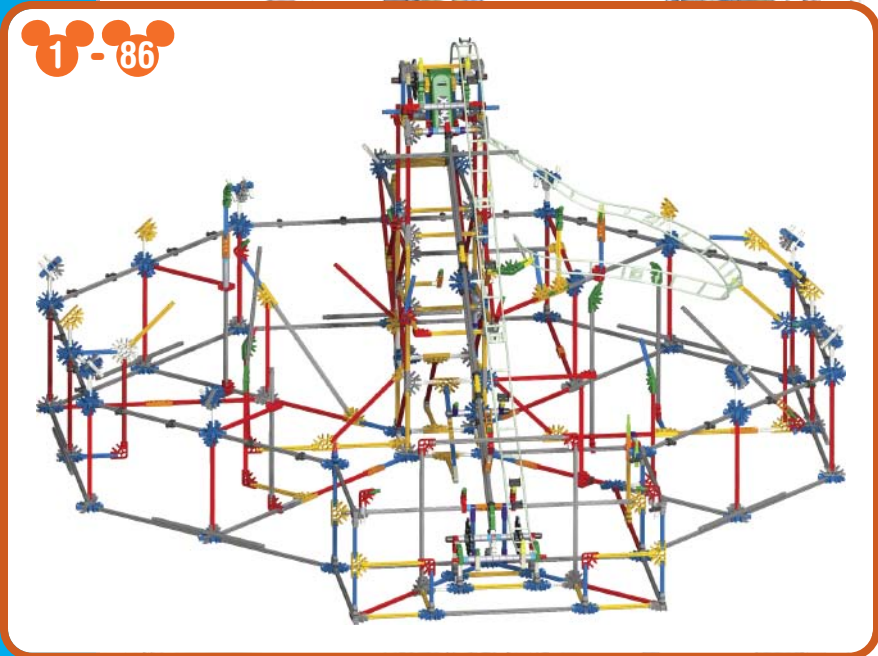
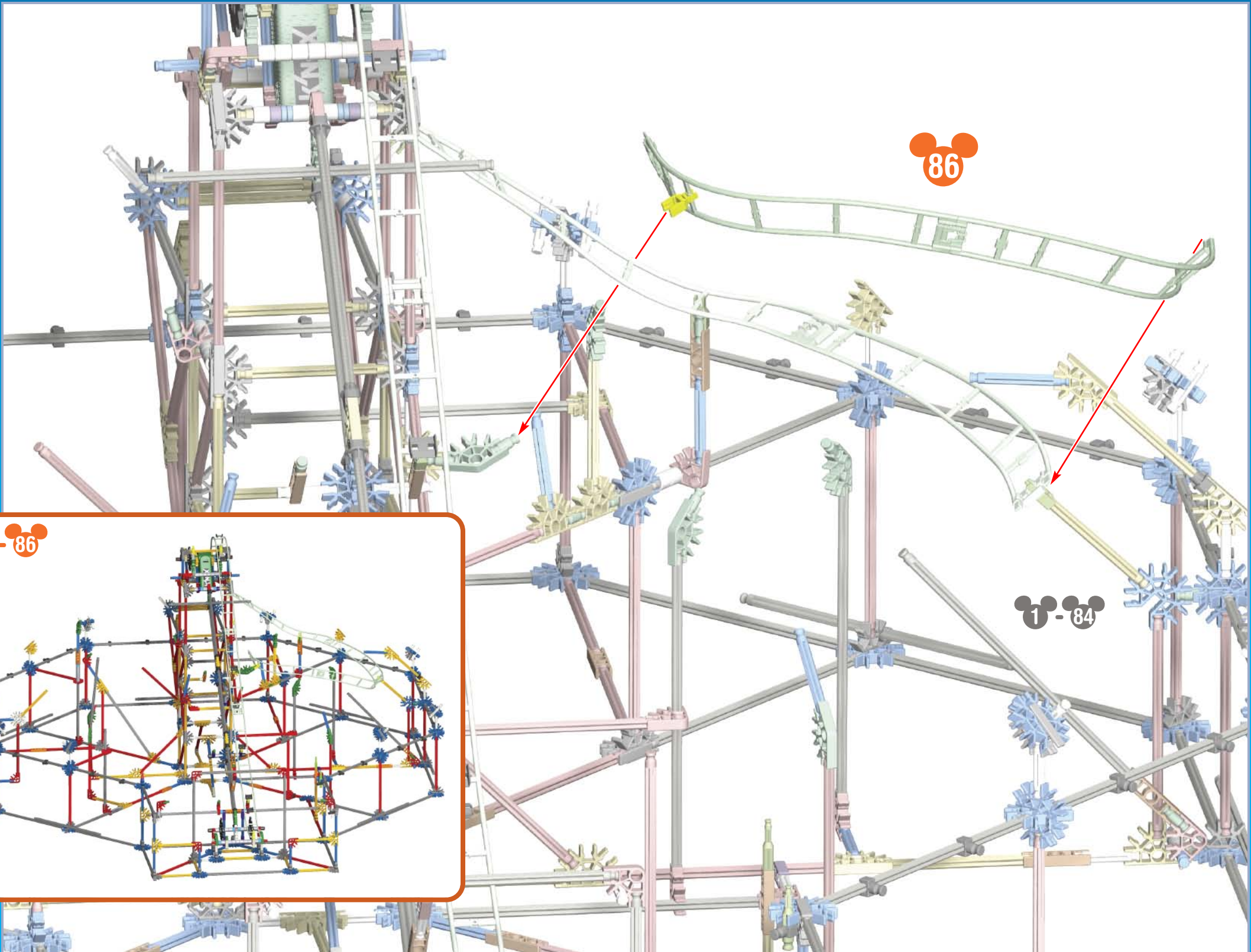
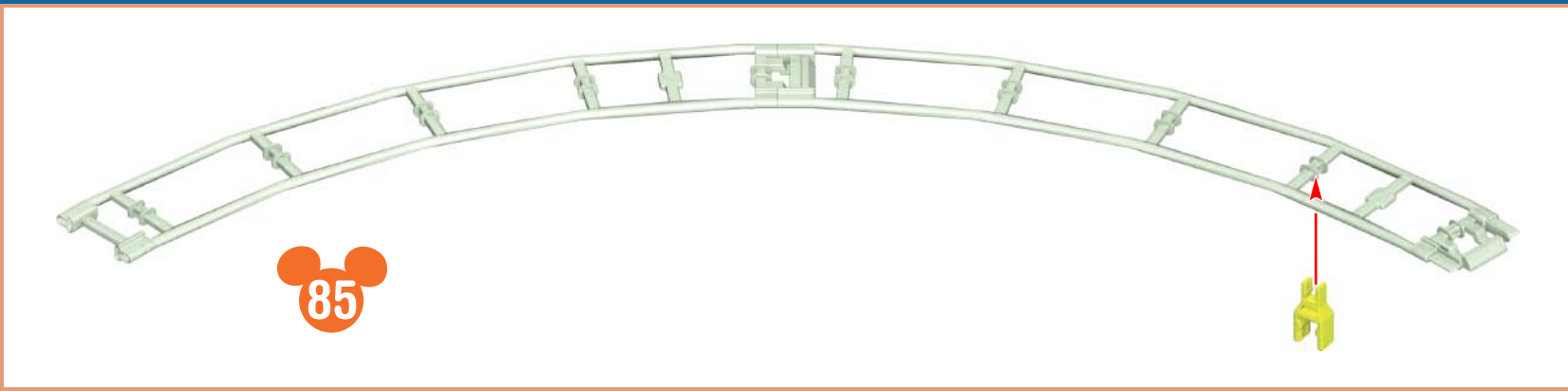

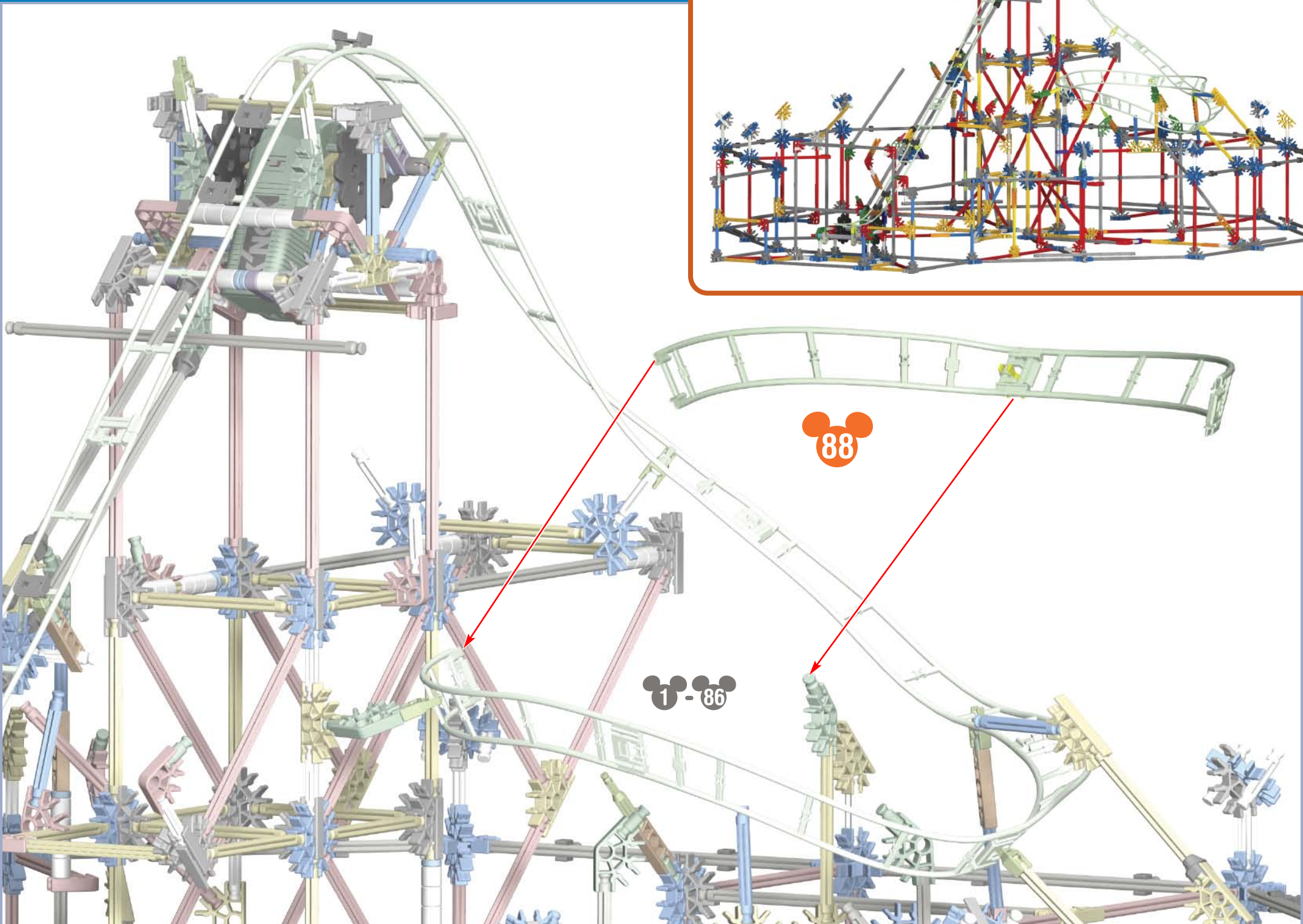
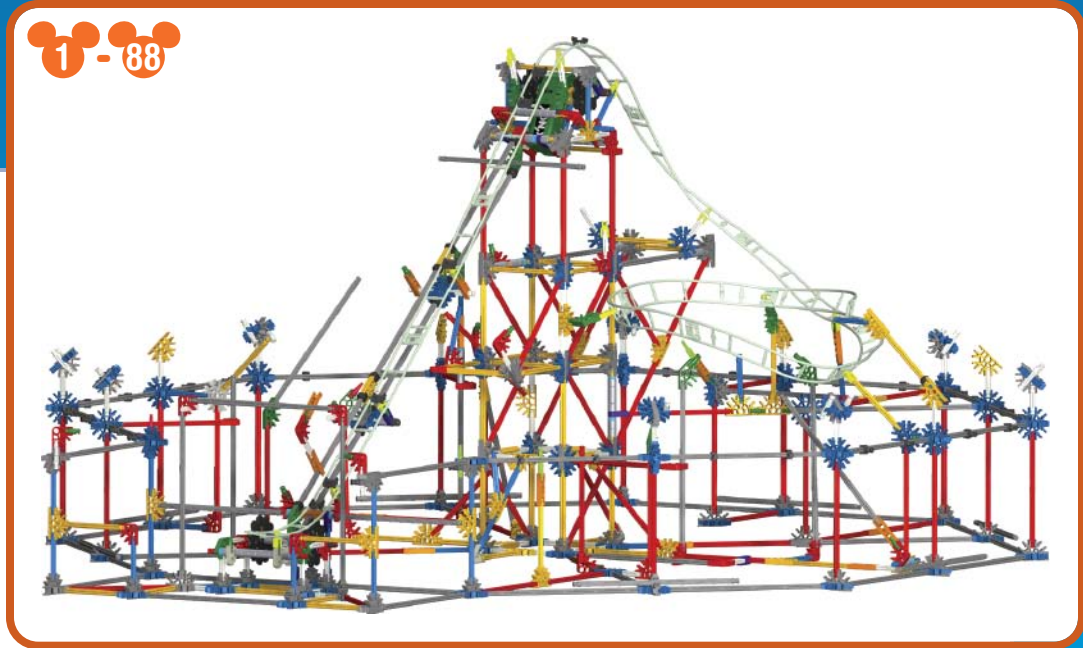
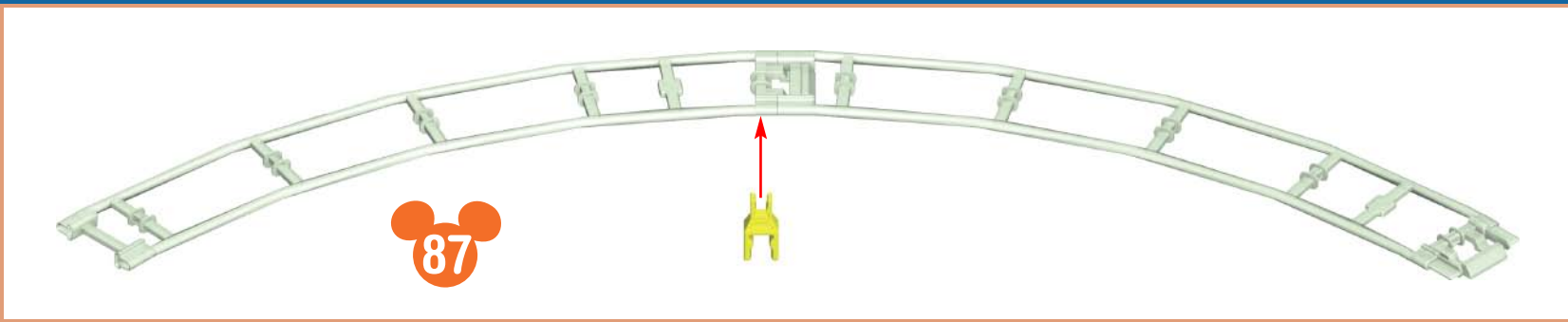

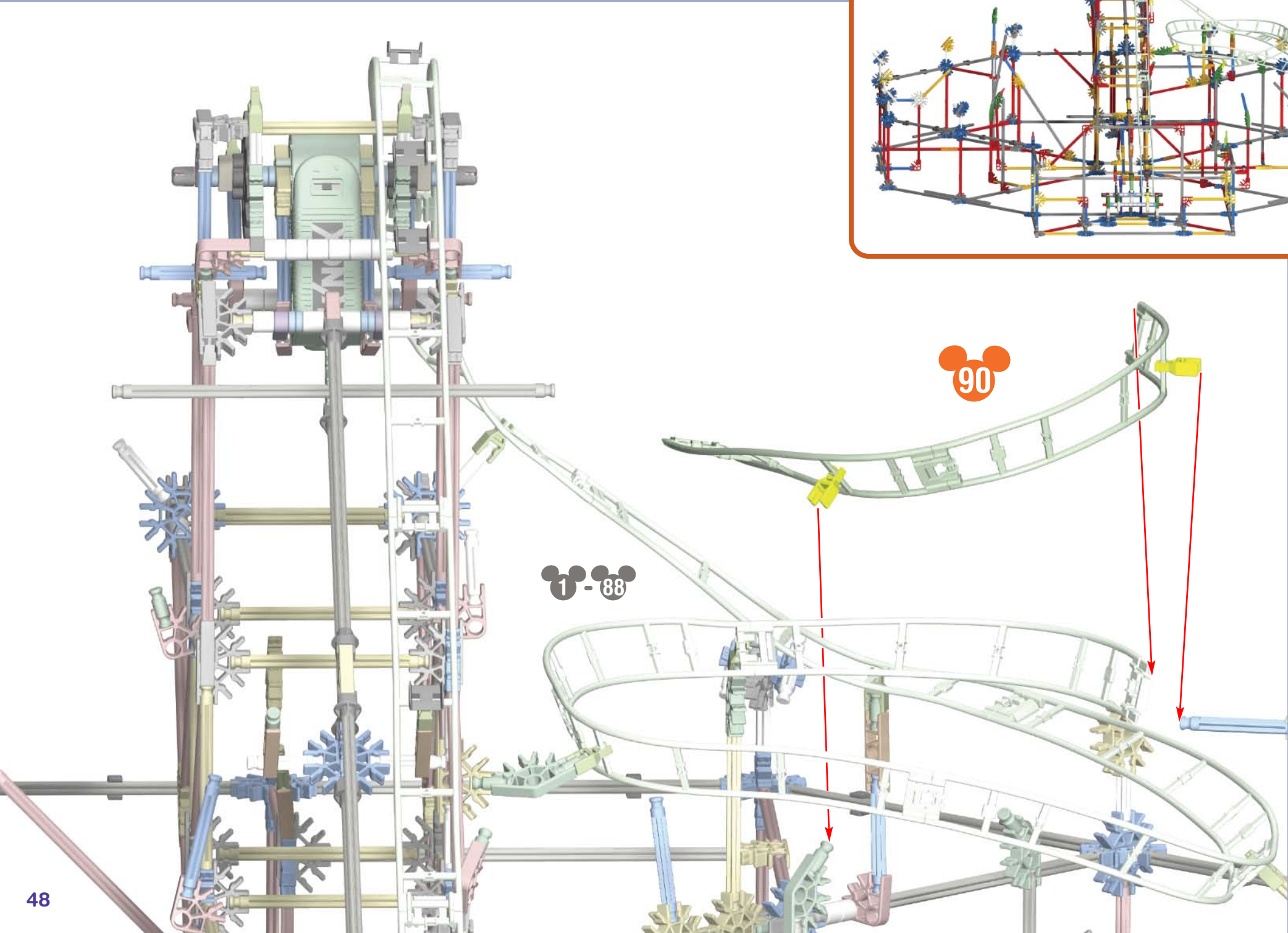
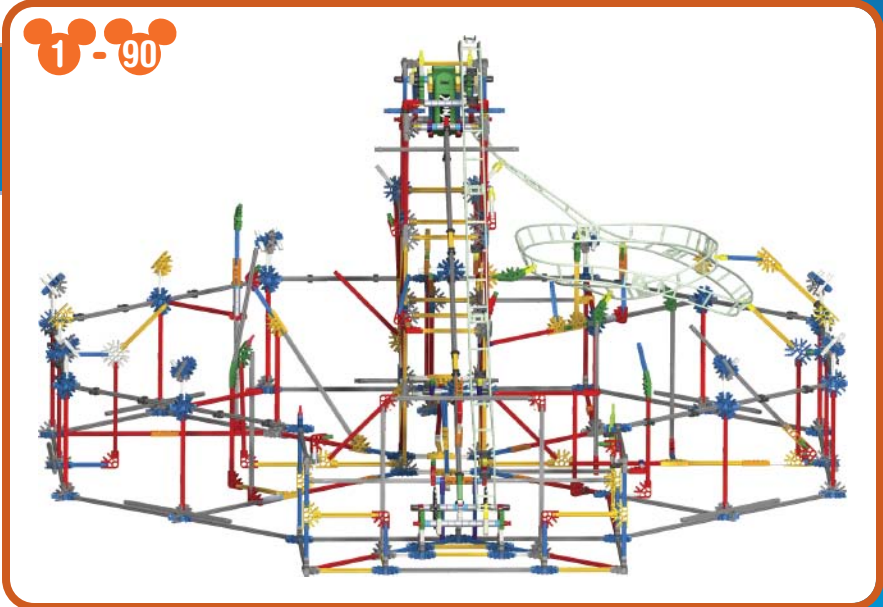
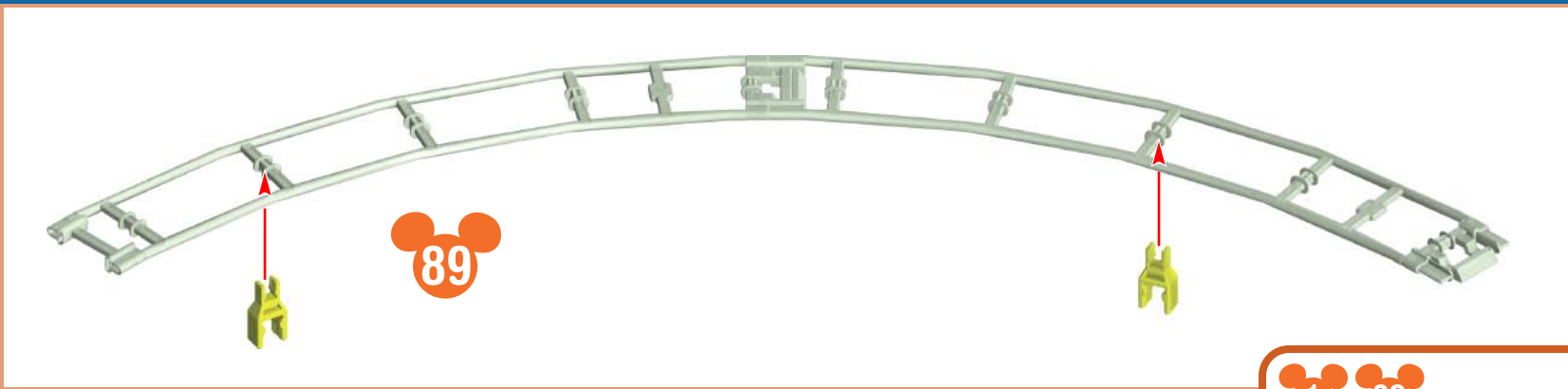

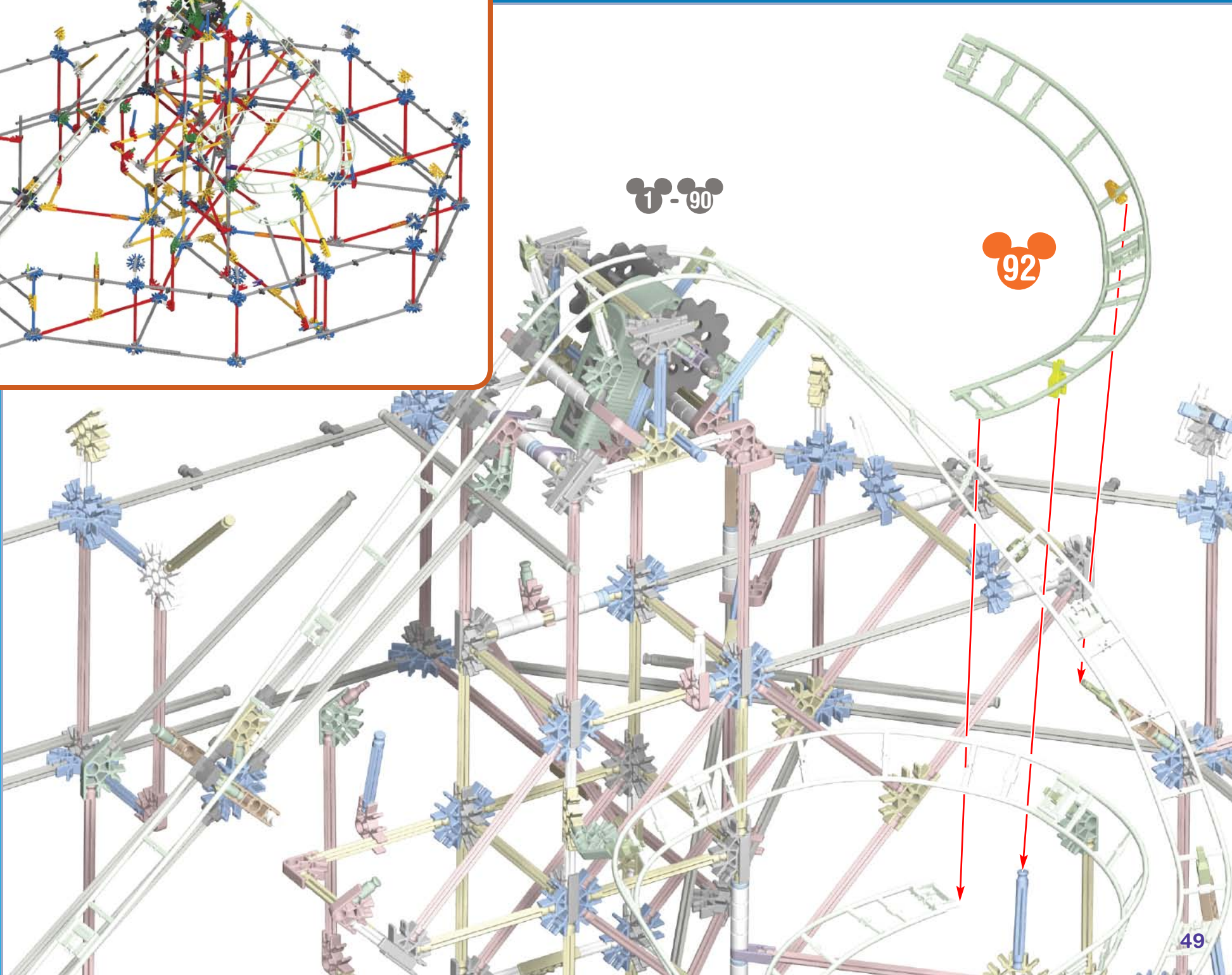
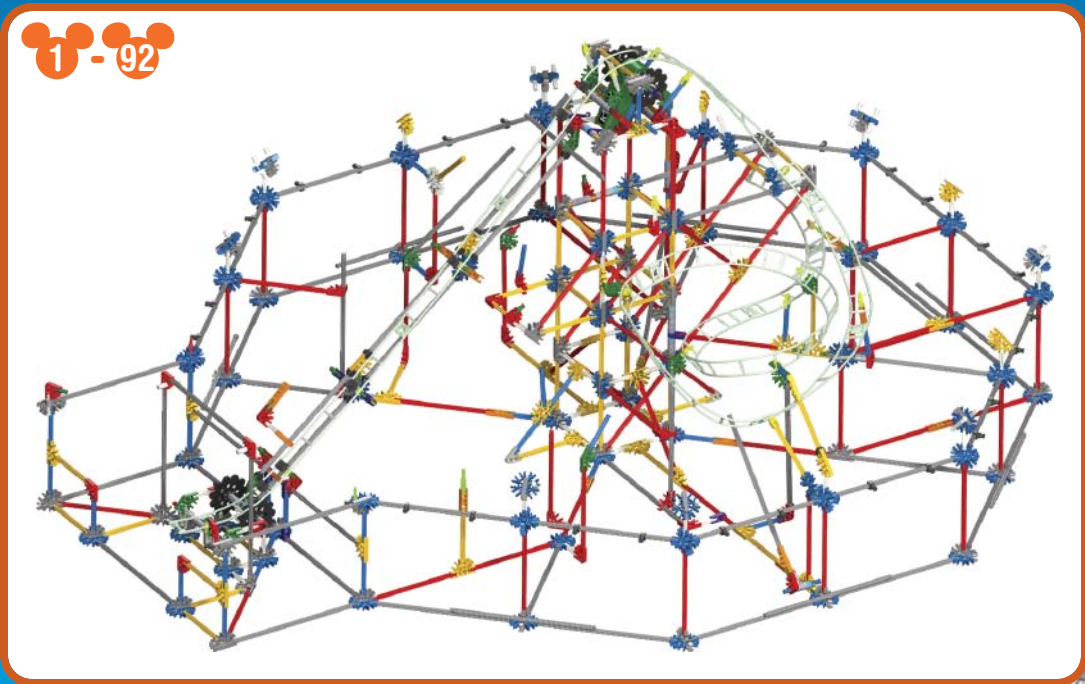
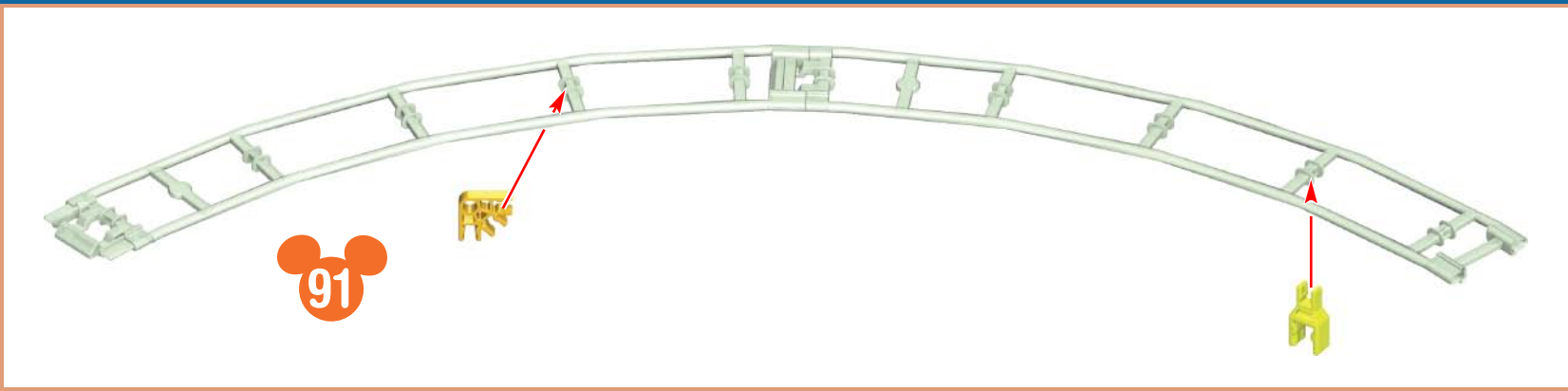

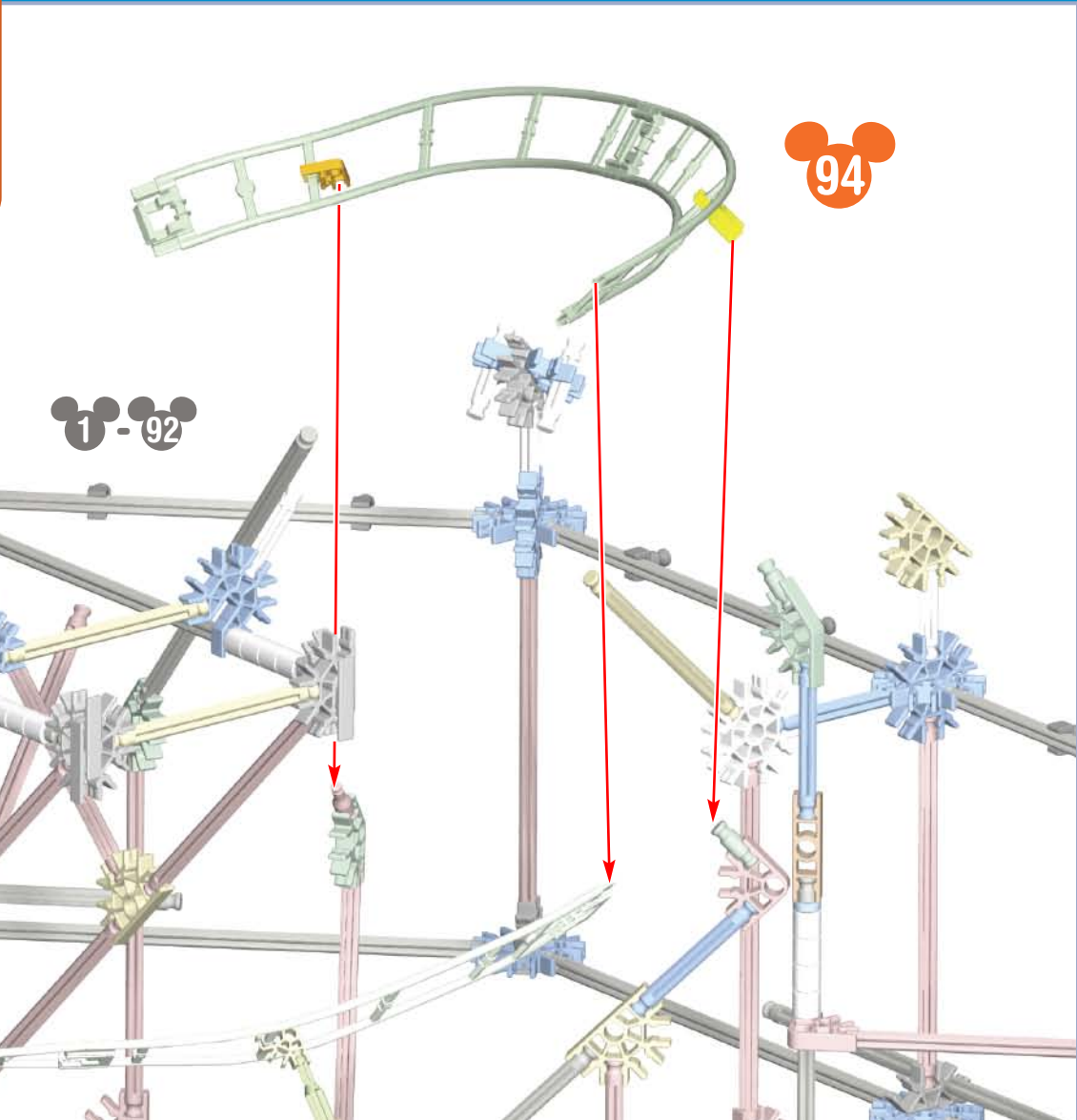
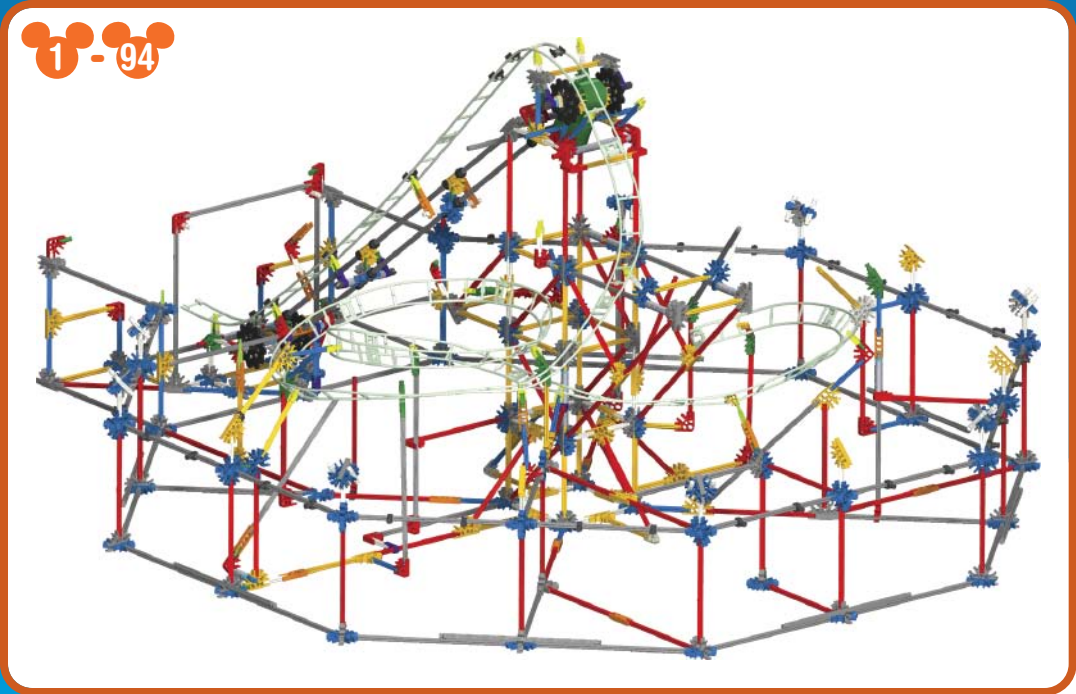
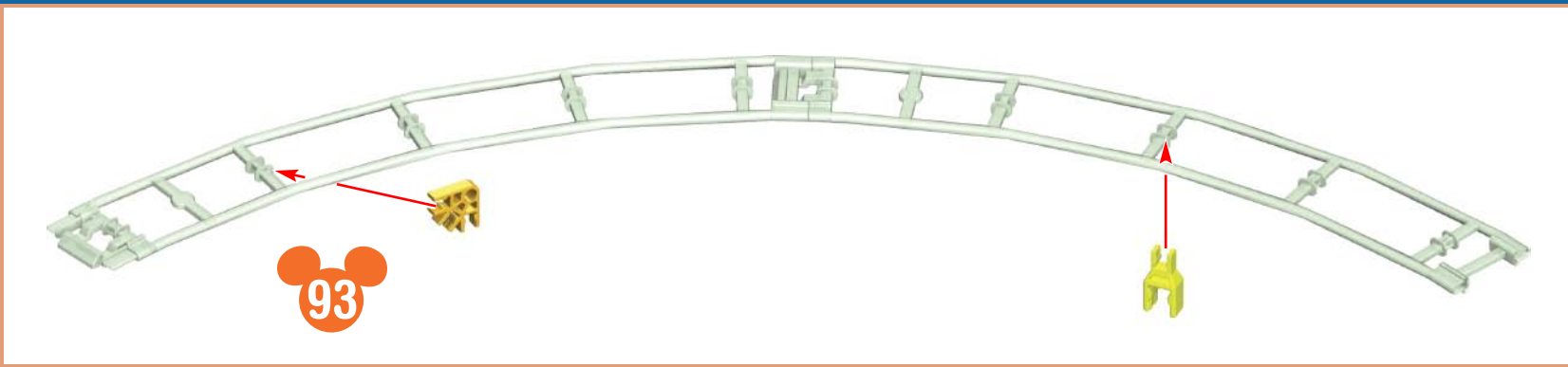

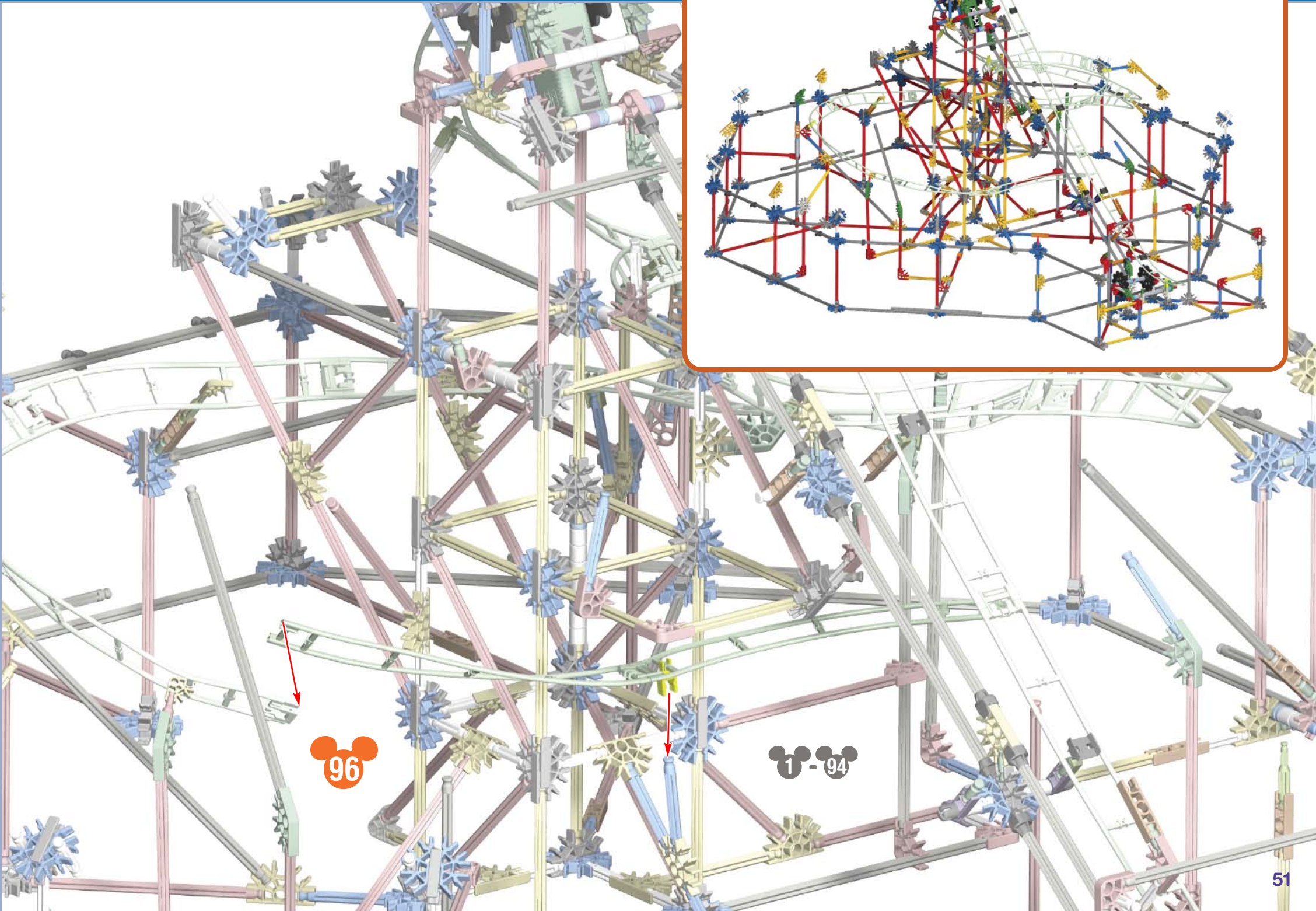
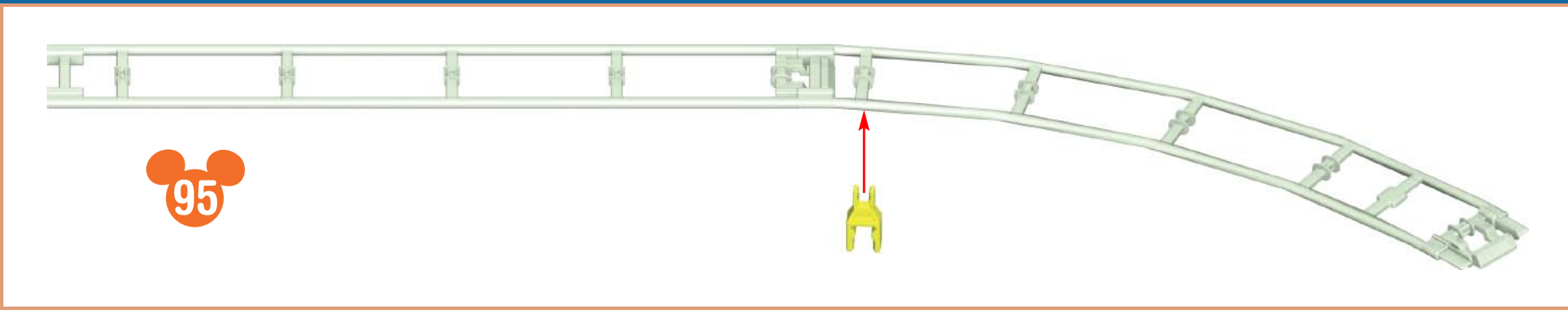

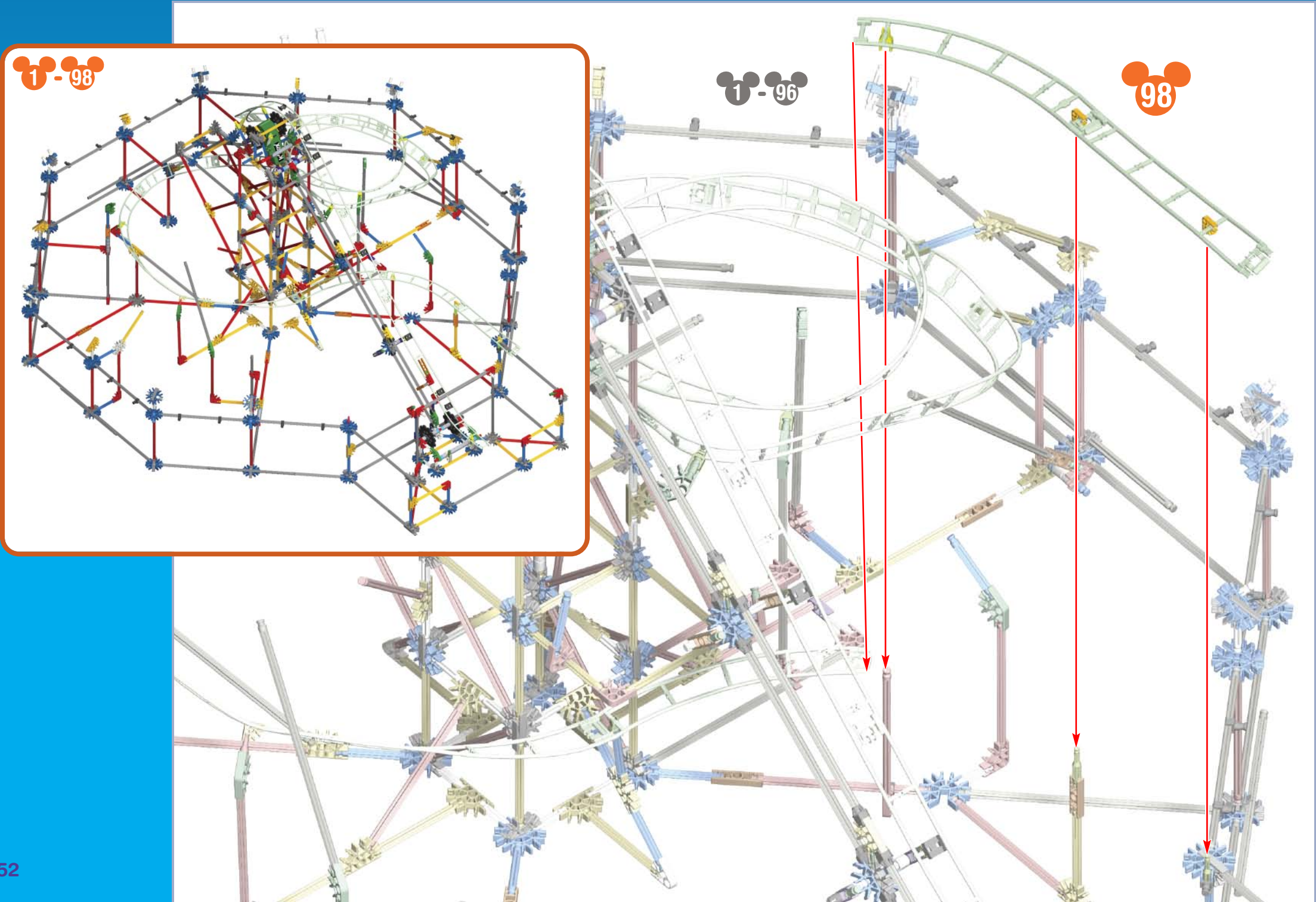
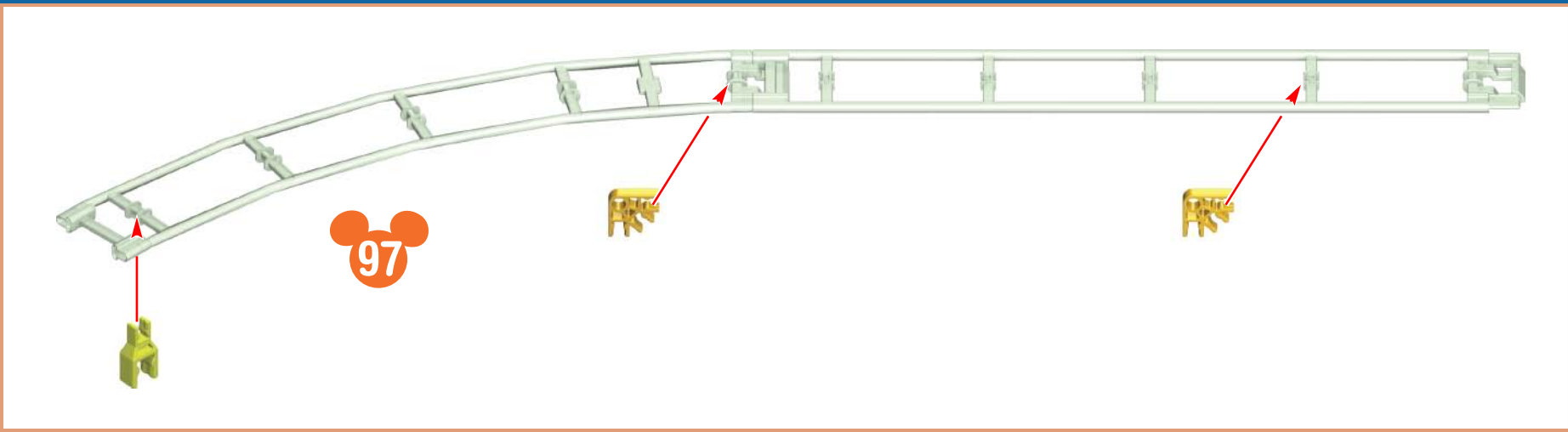

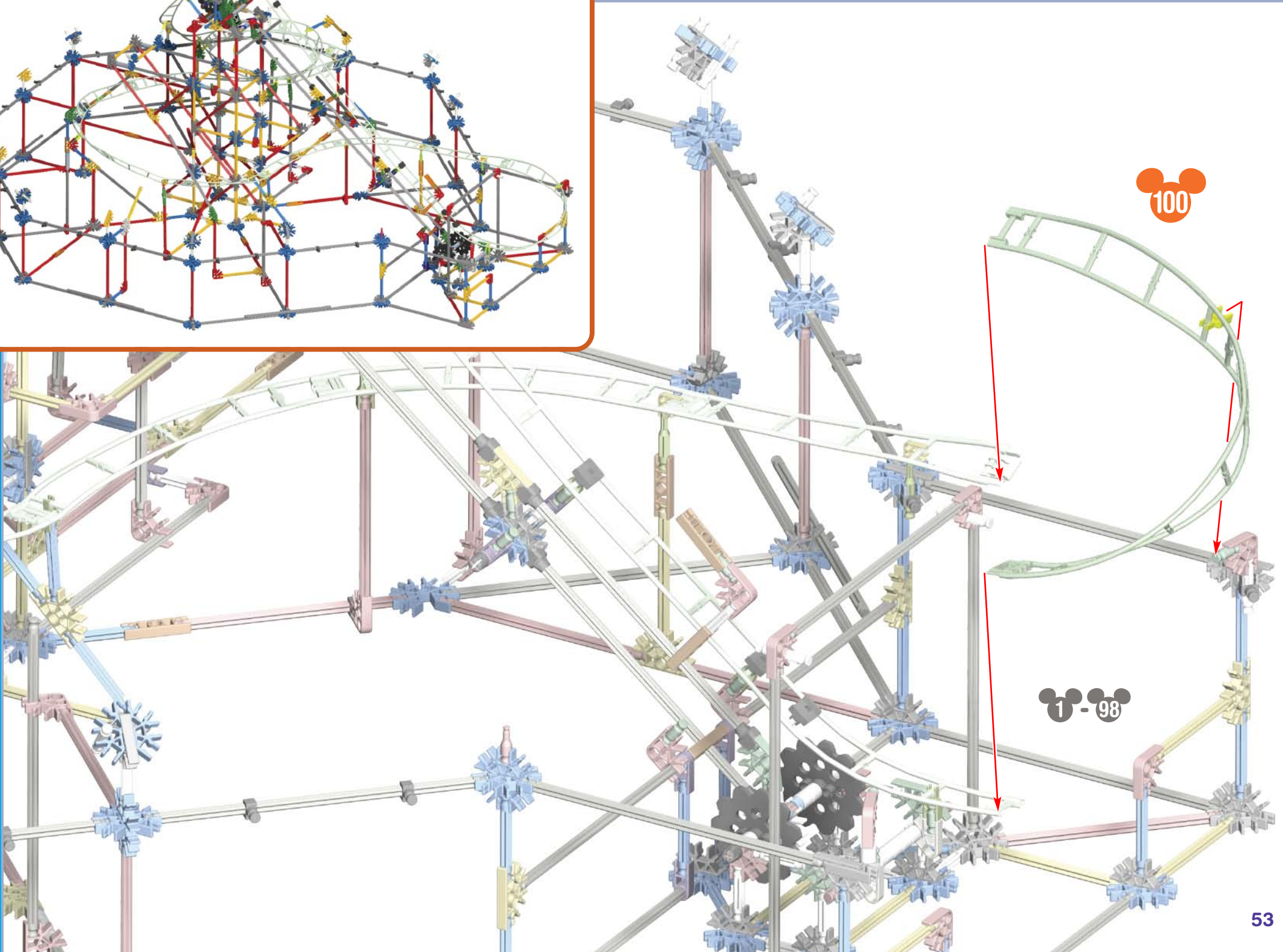
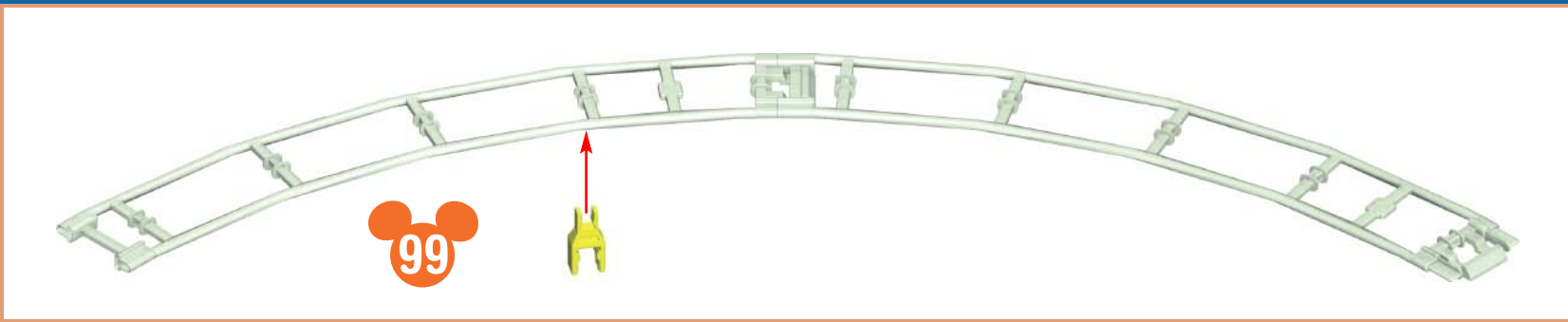

# Track B

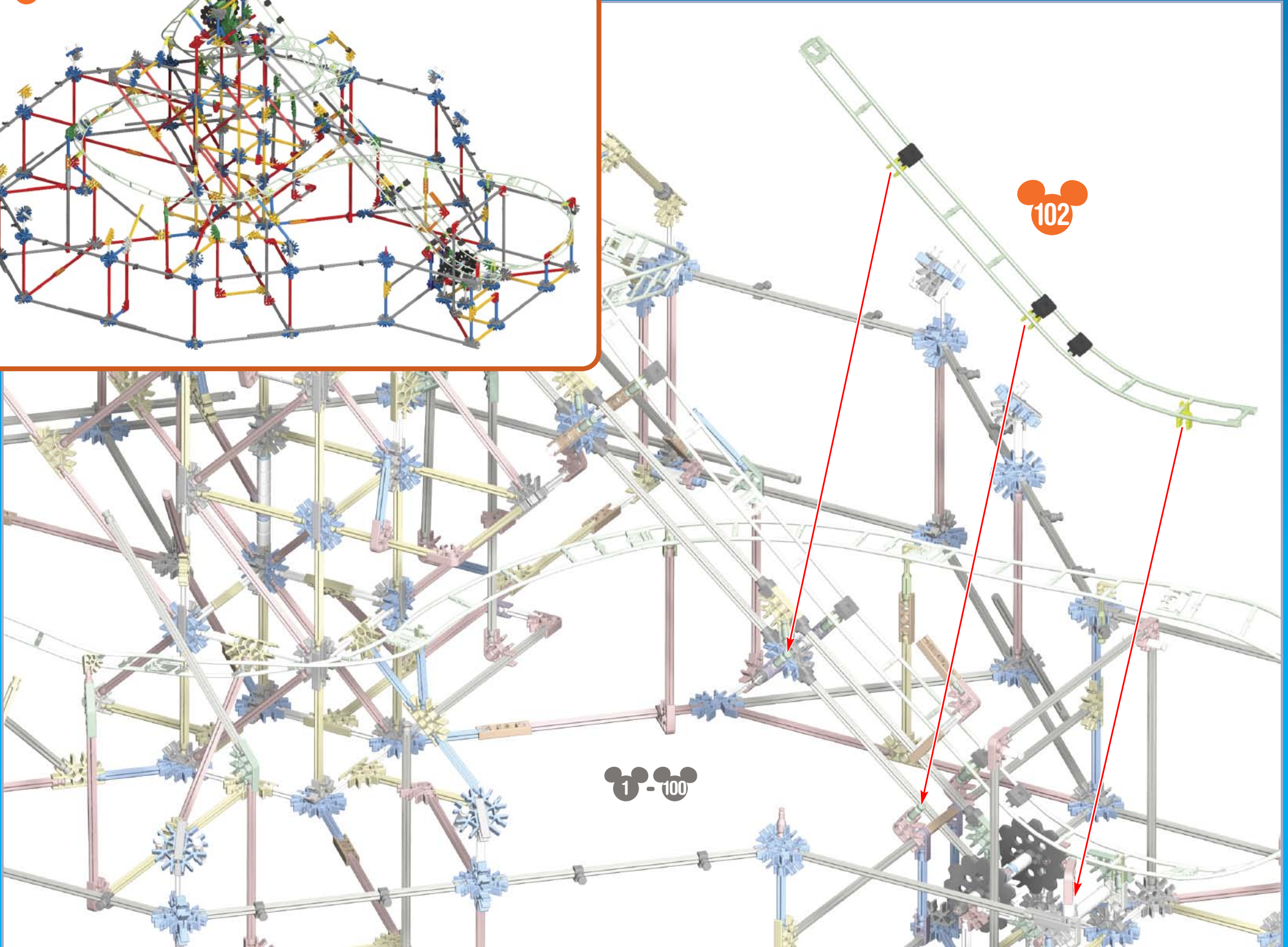
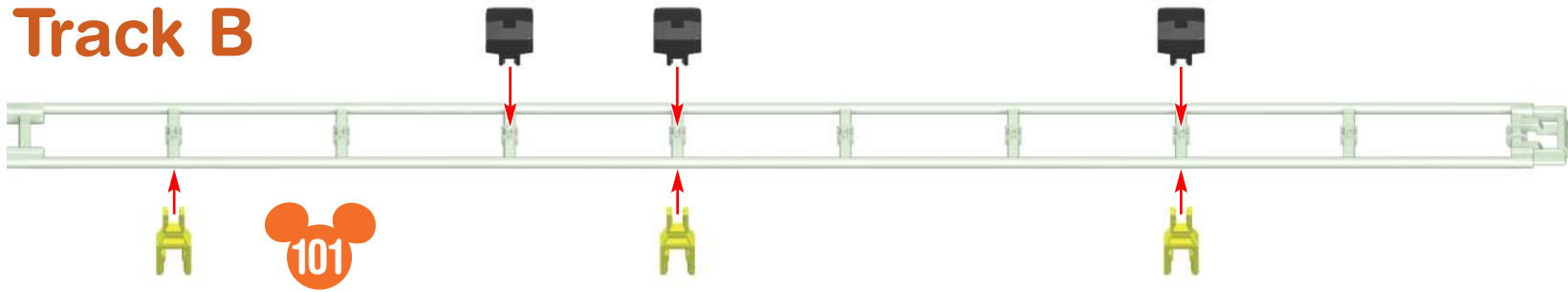

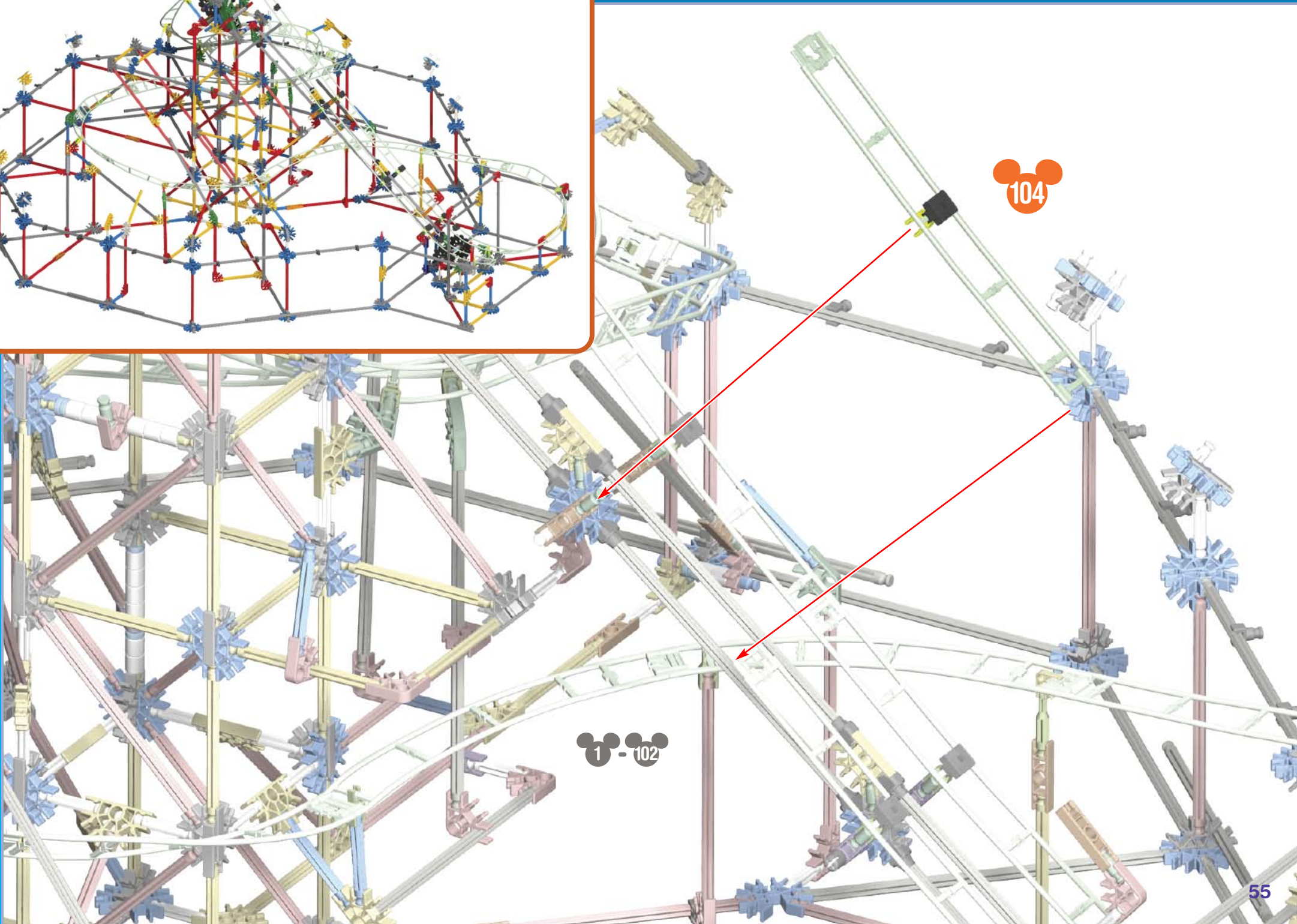
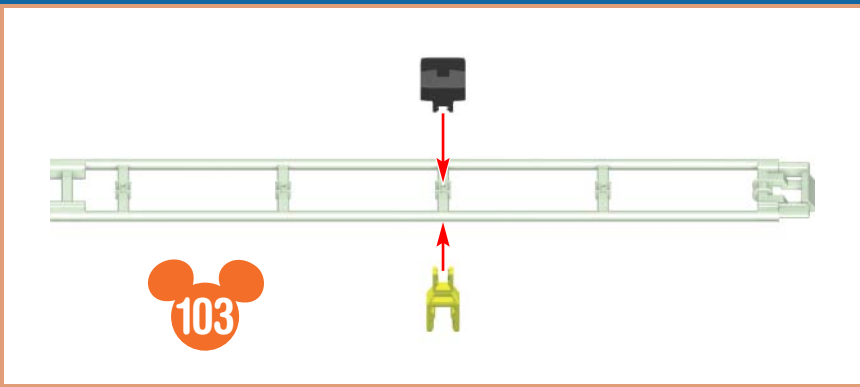

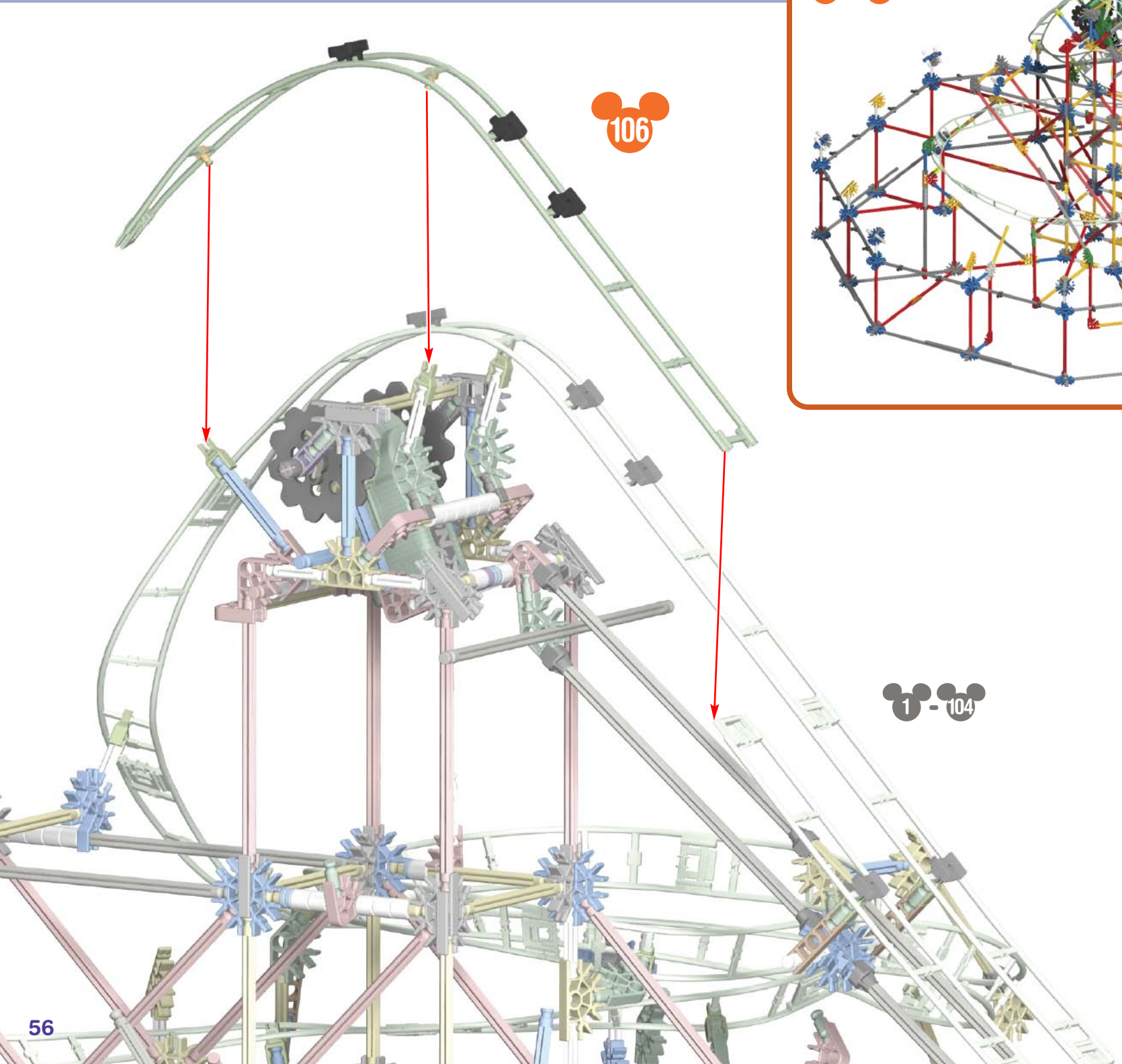
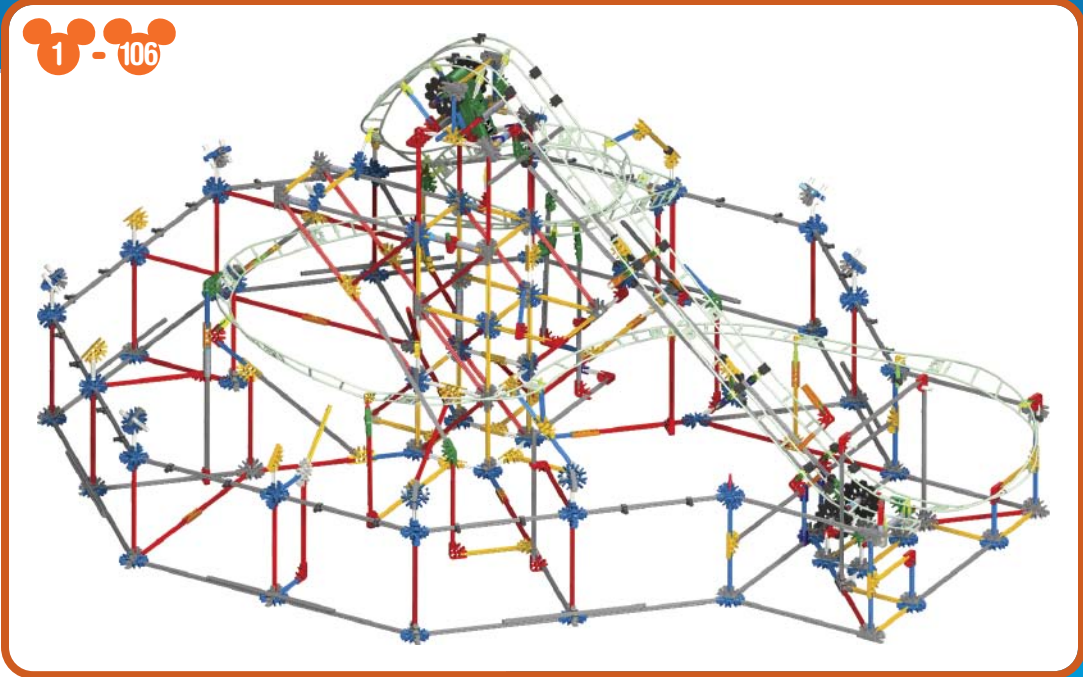
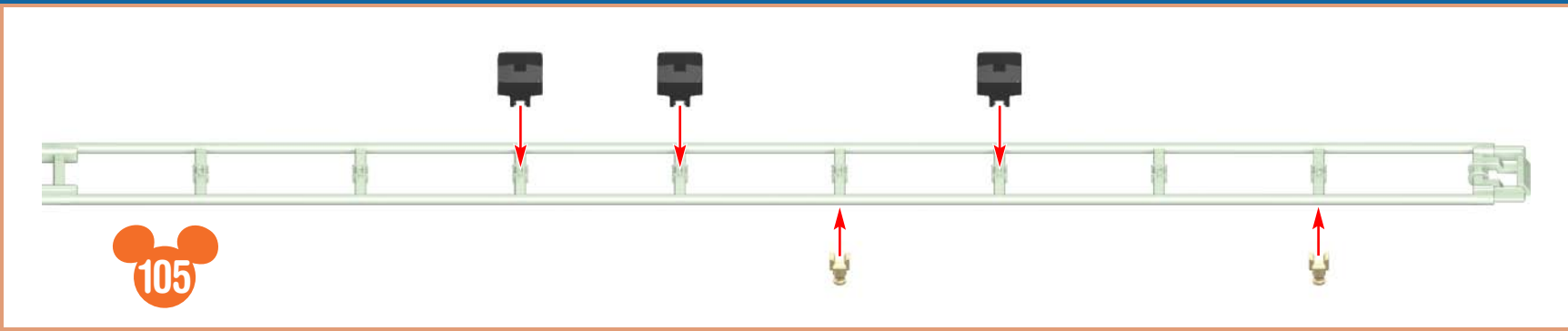

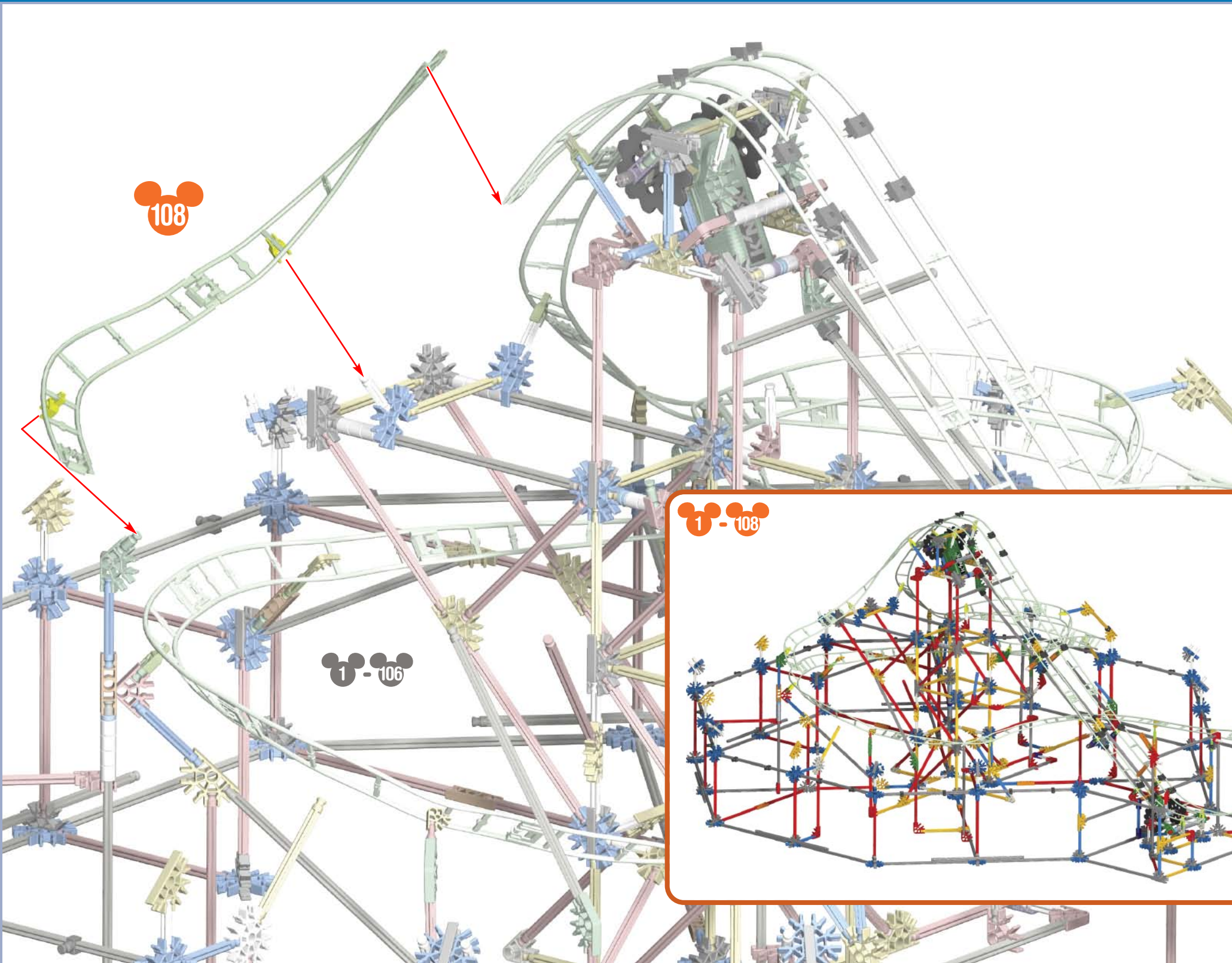
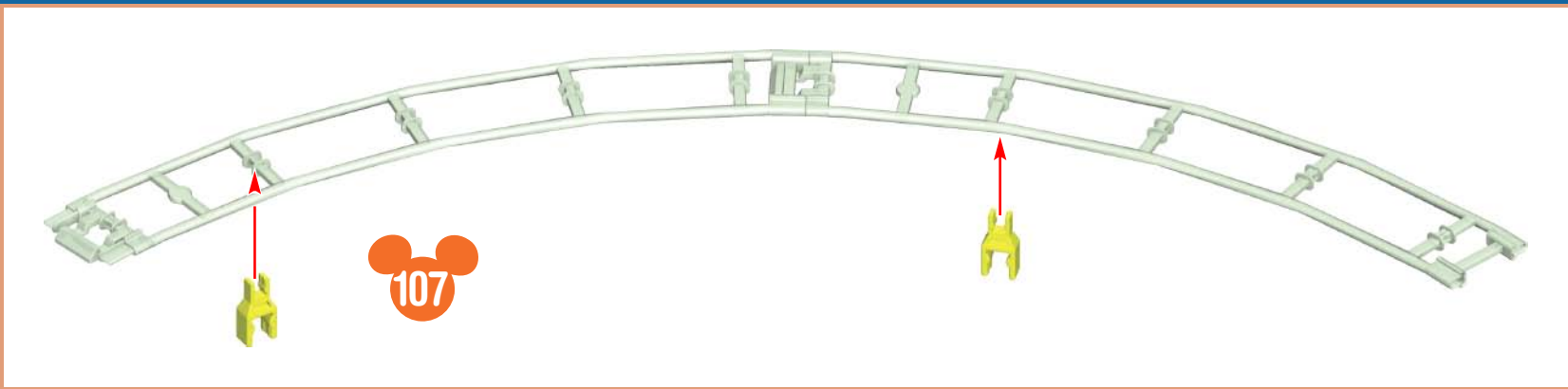

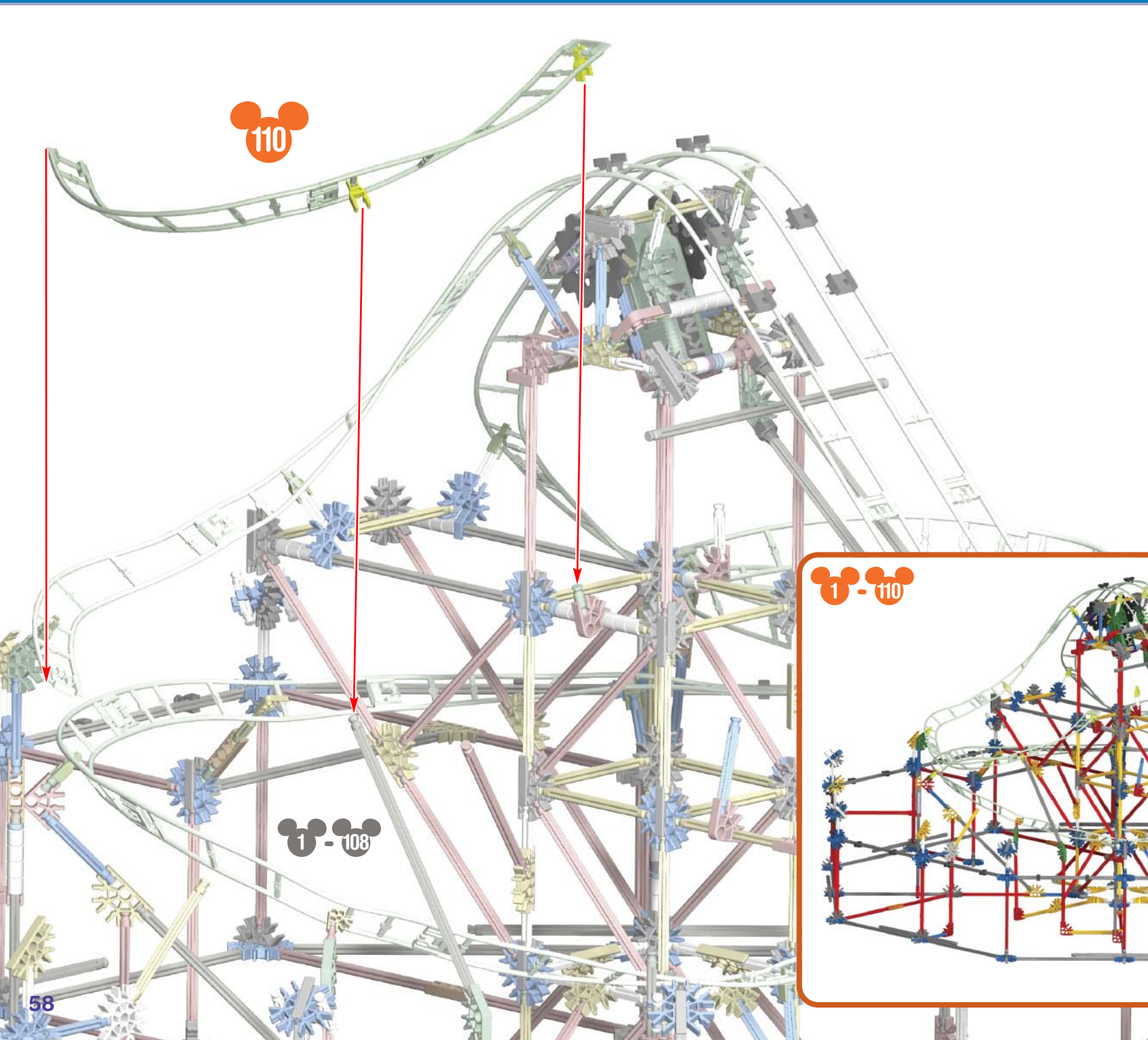
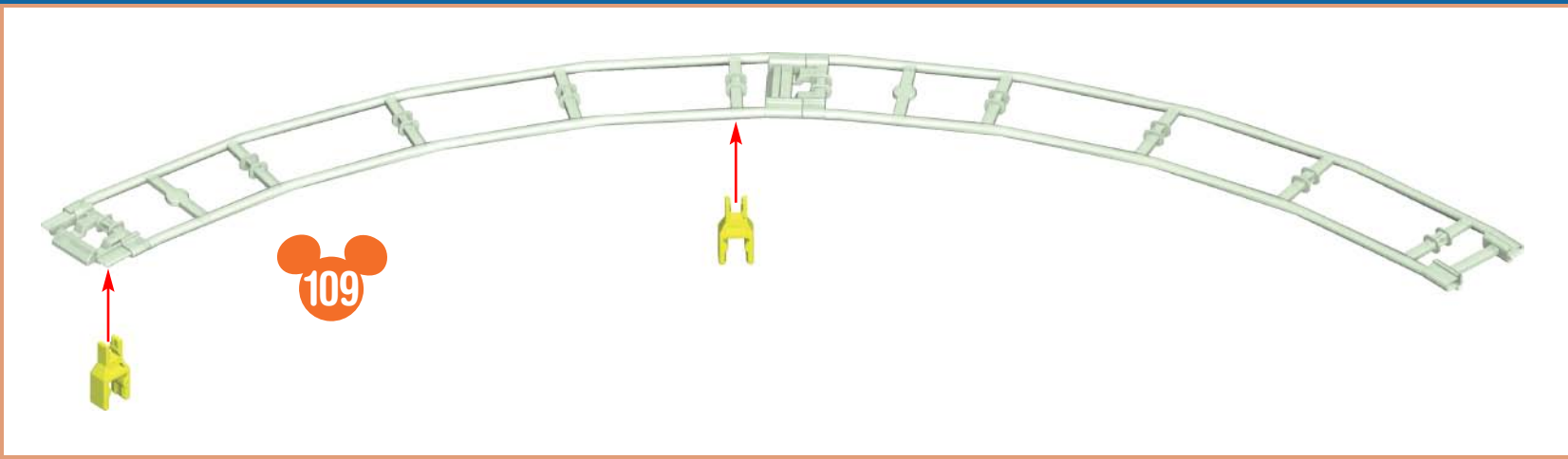

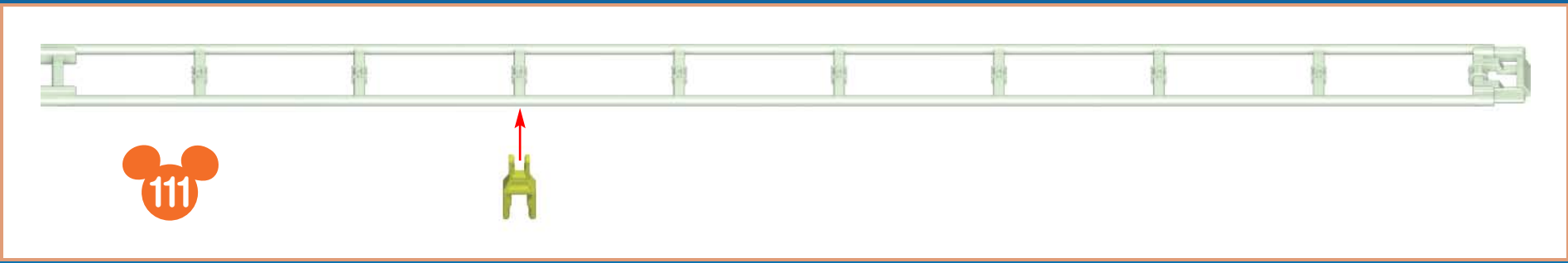

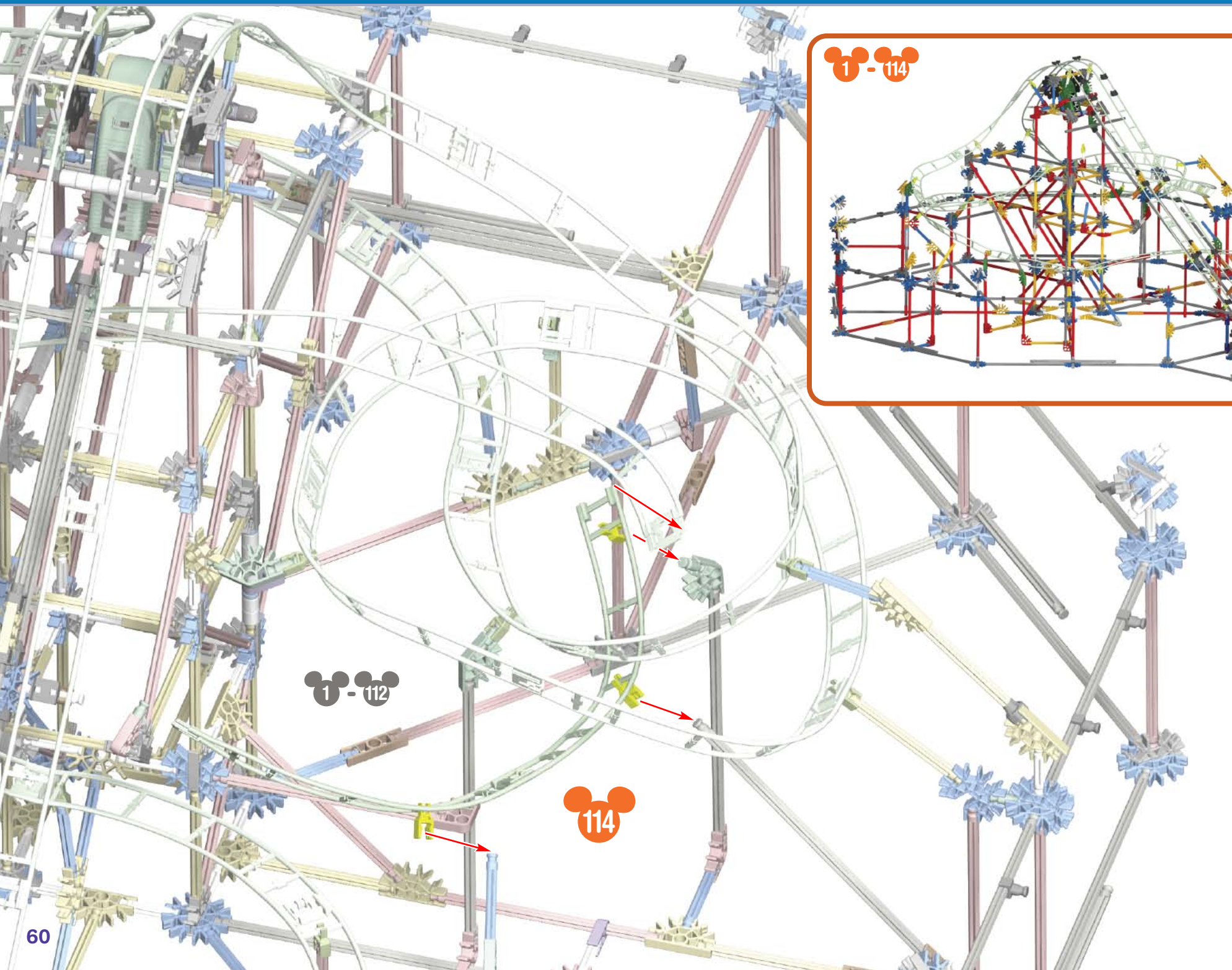
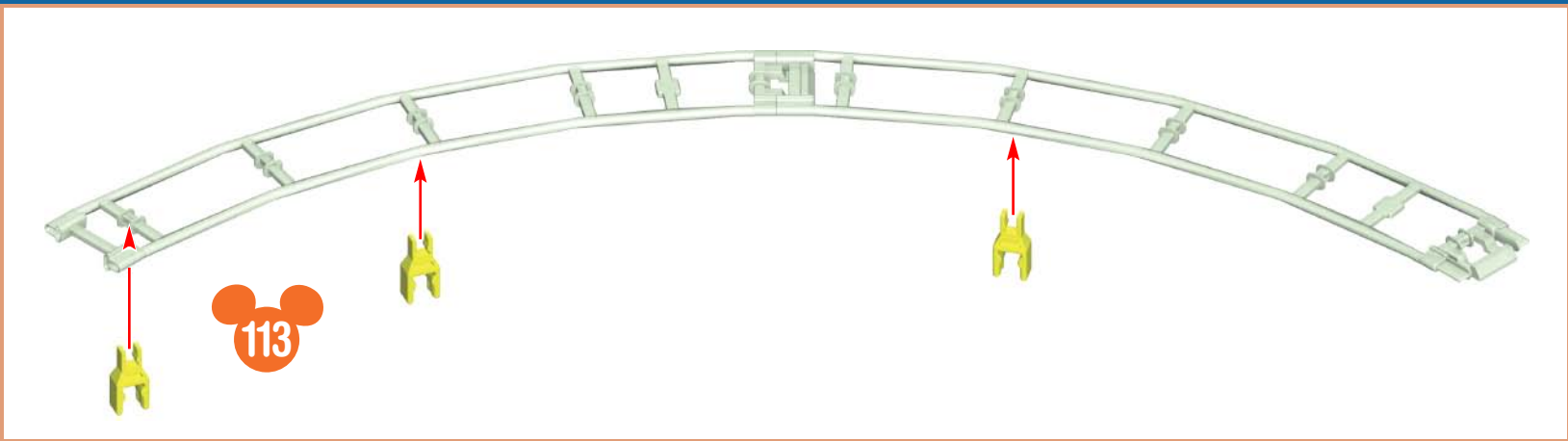

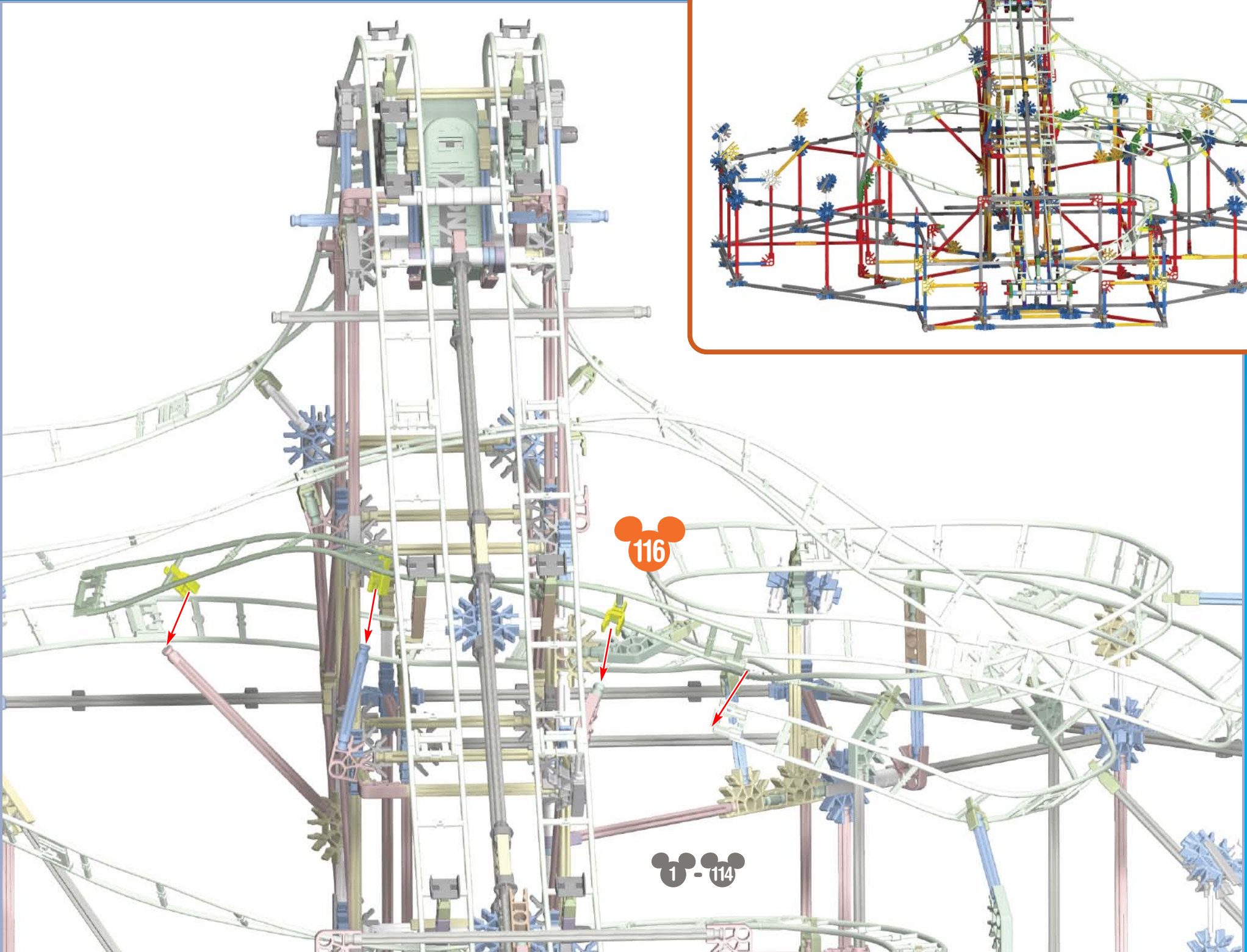
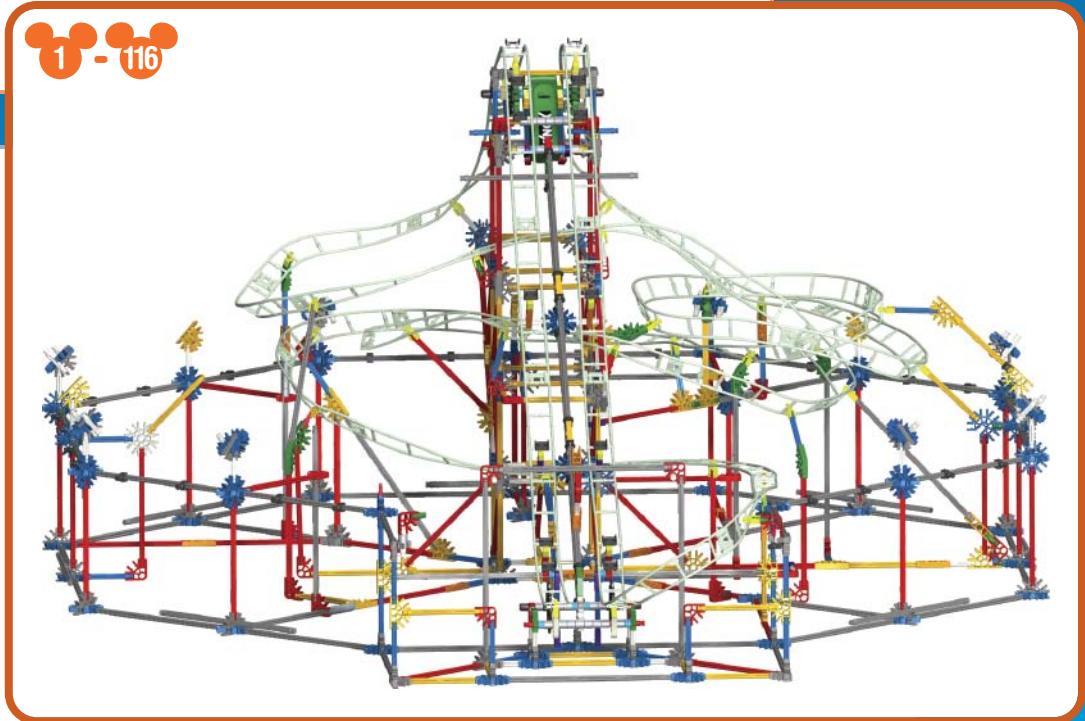
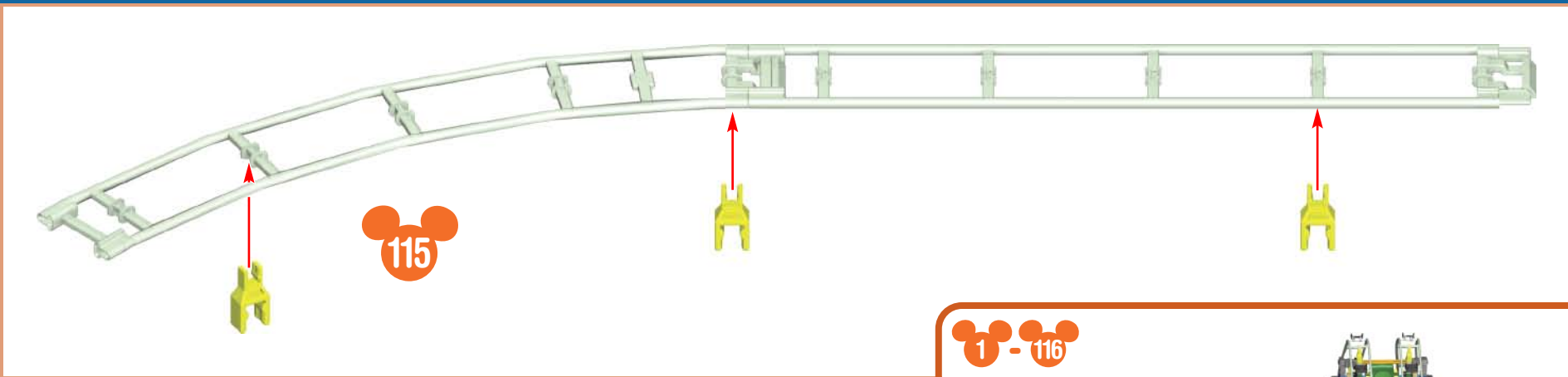

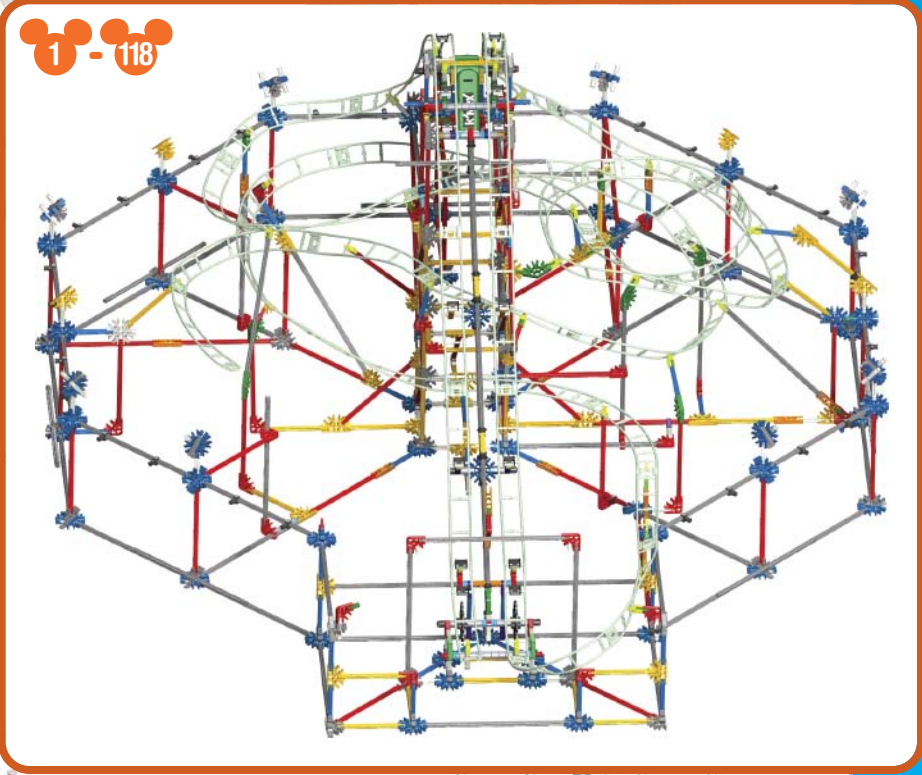
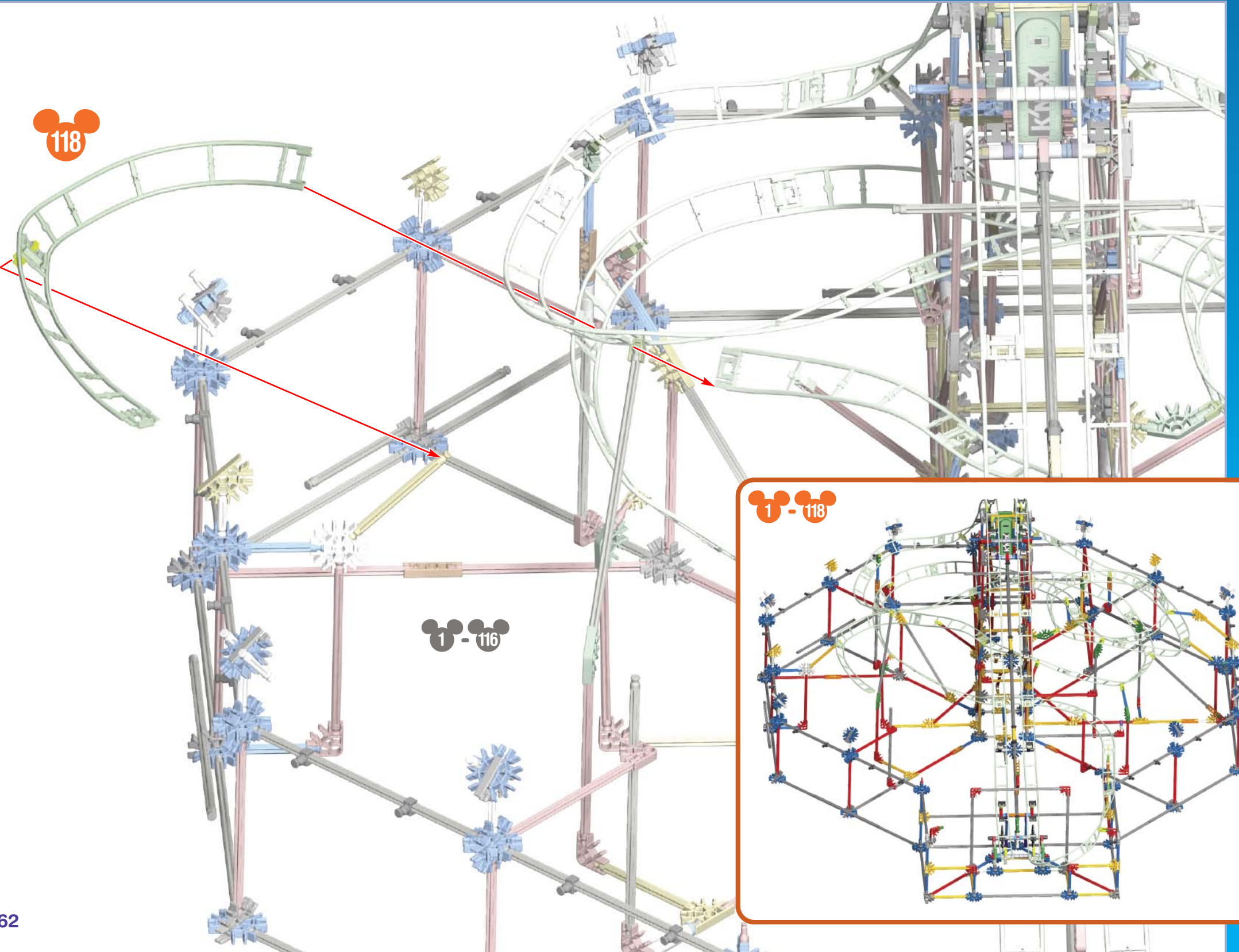
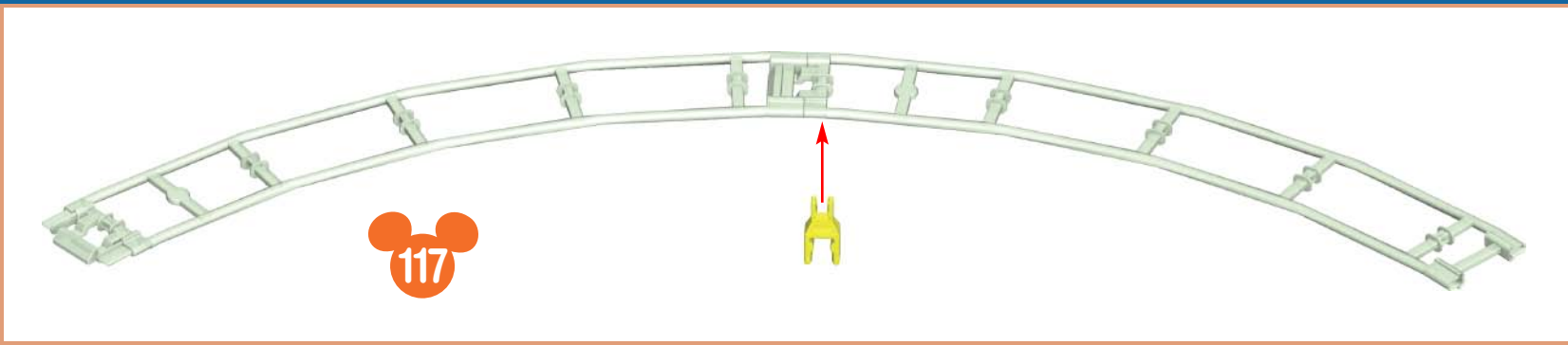

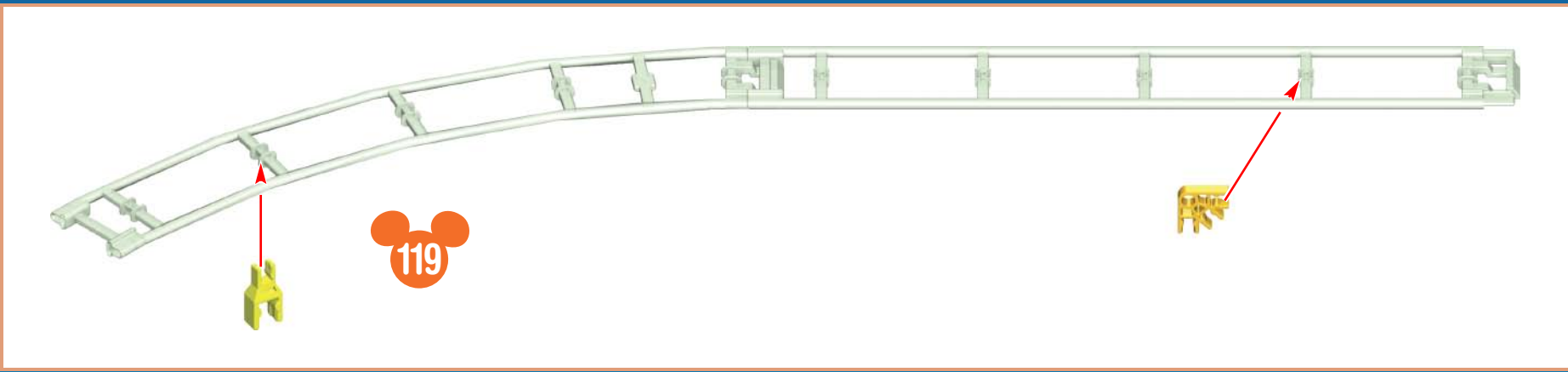

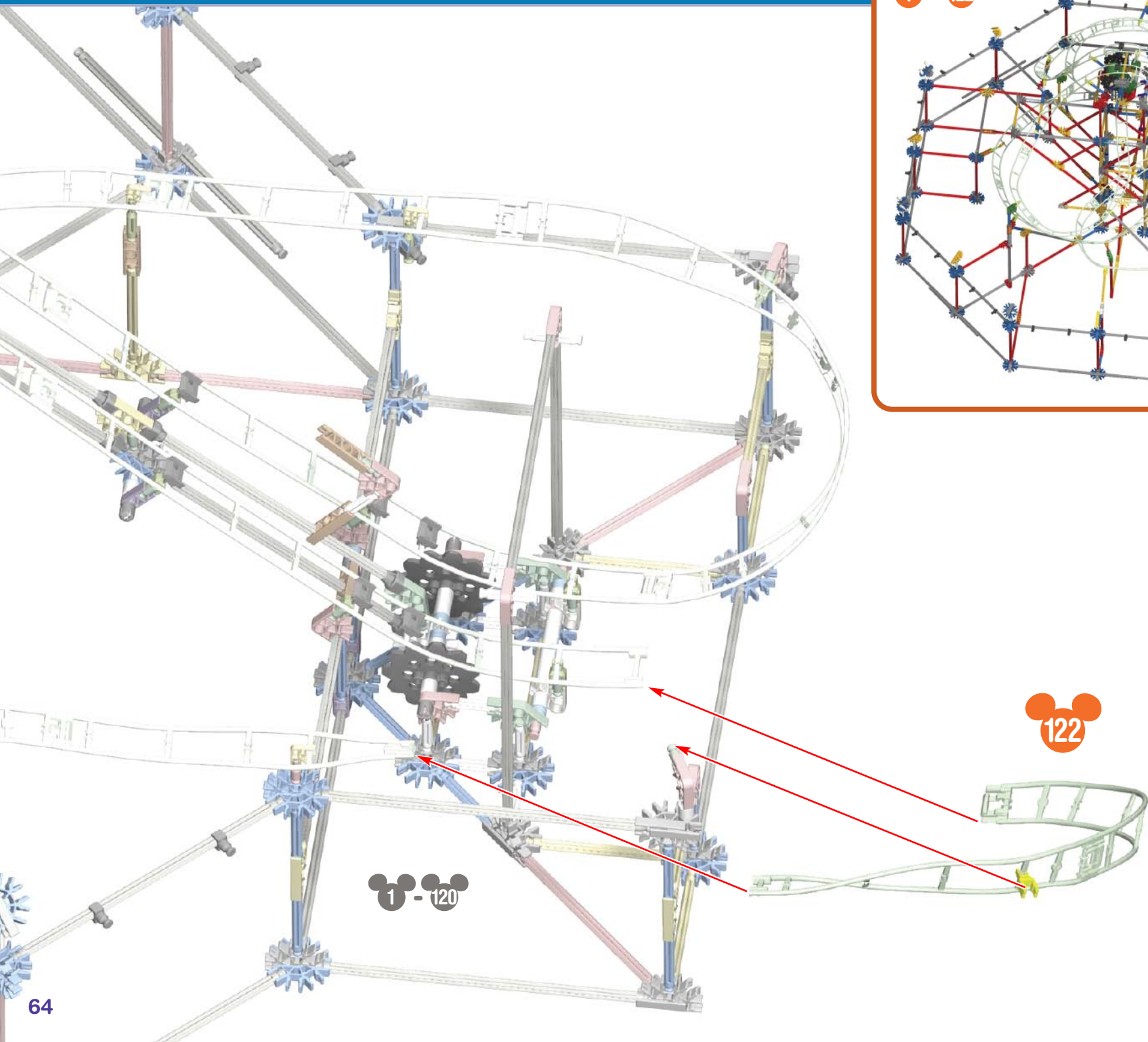
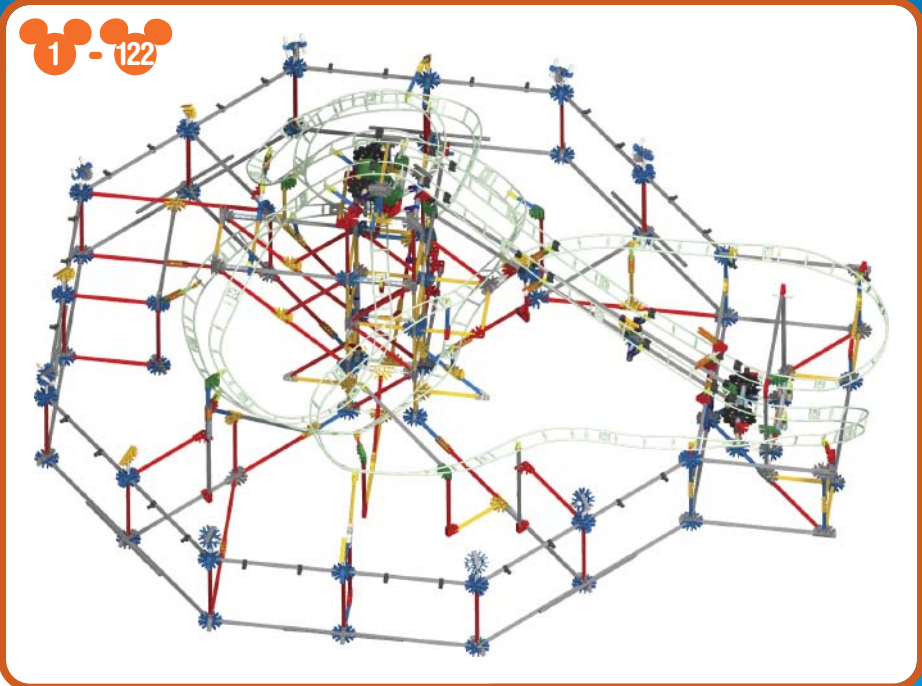
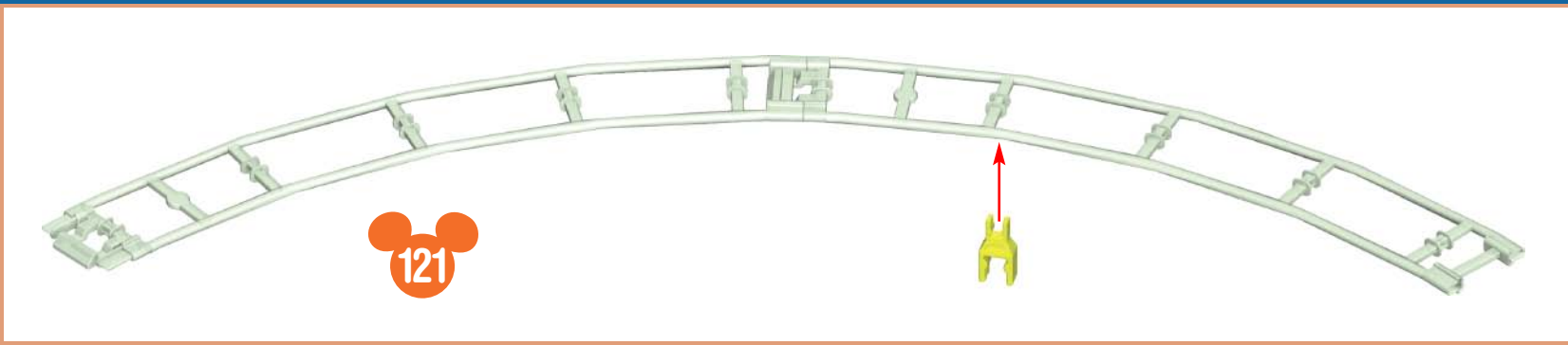



**IMPORTANT:** Attach all the chain links in the same direction.



123



124

x2

x24

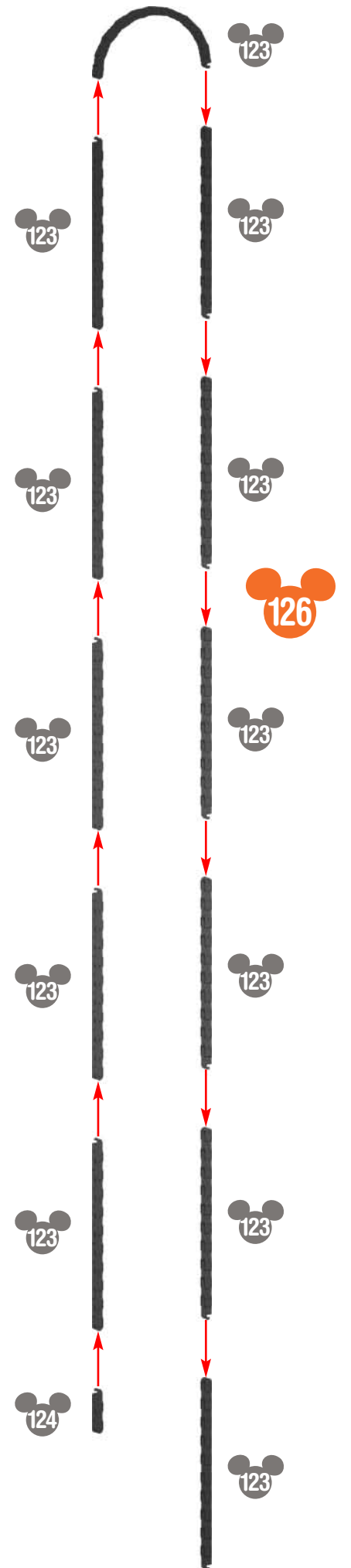
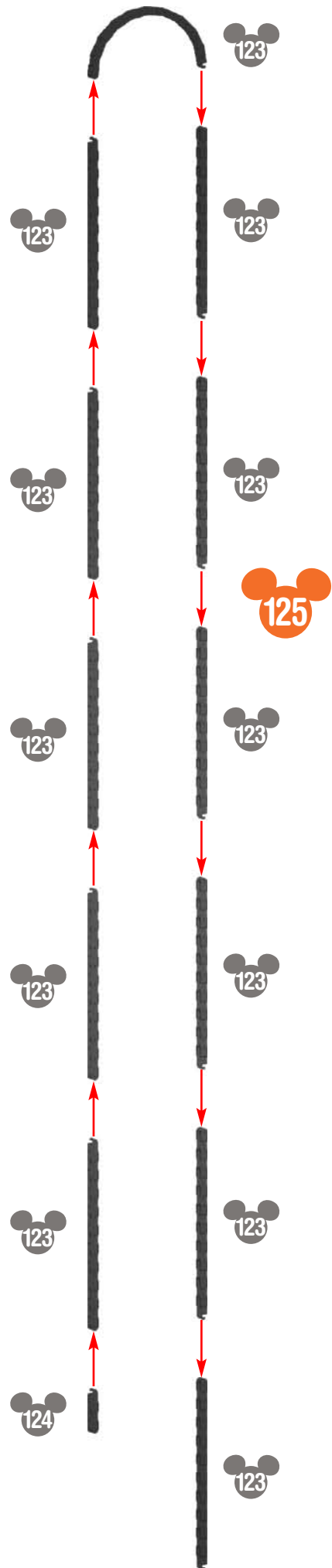

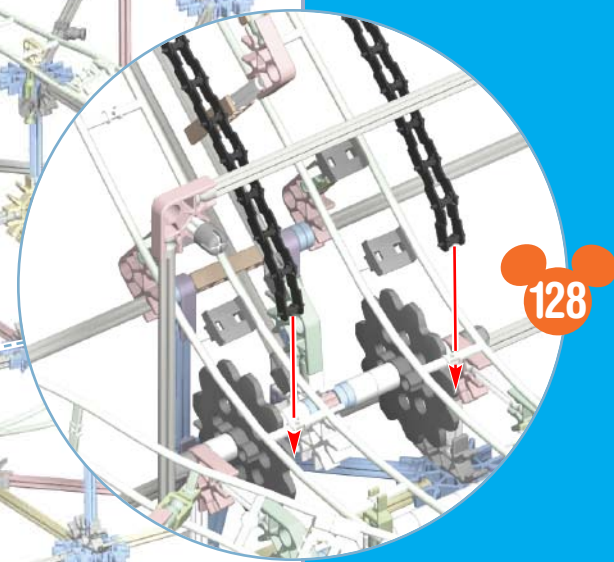
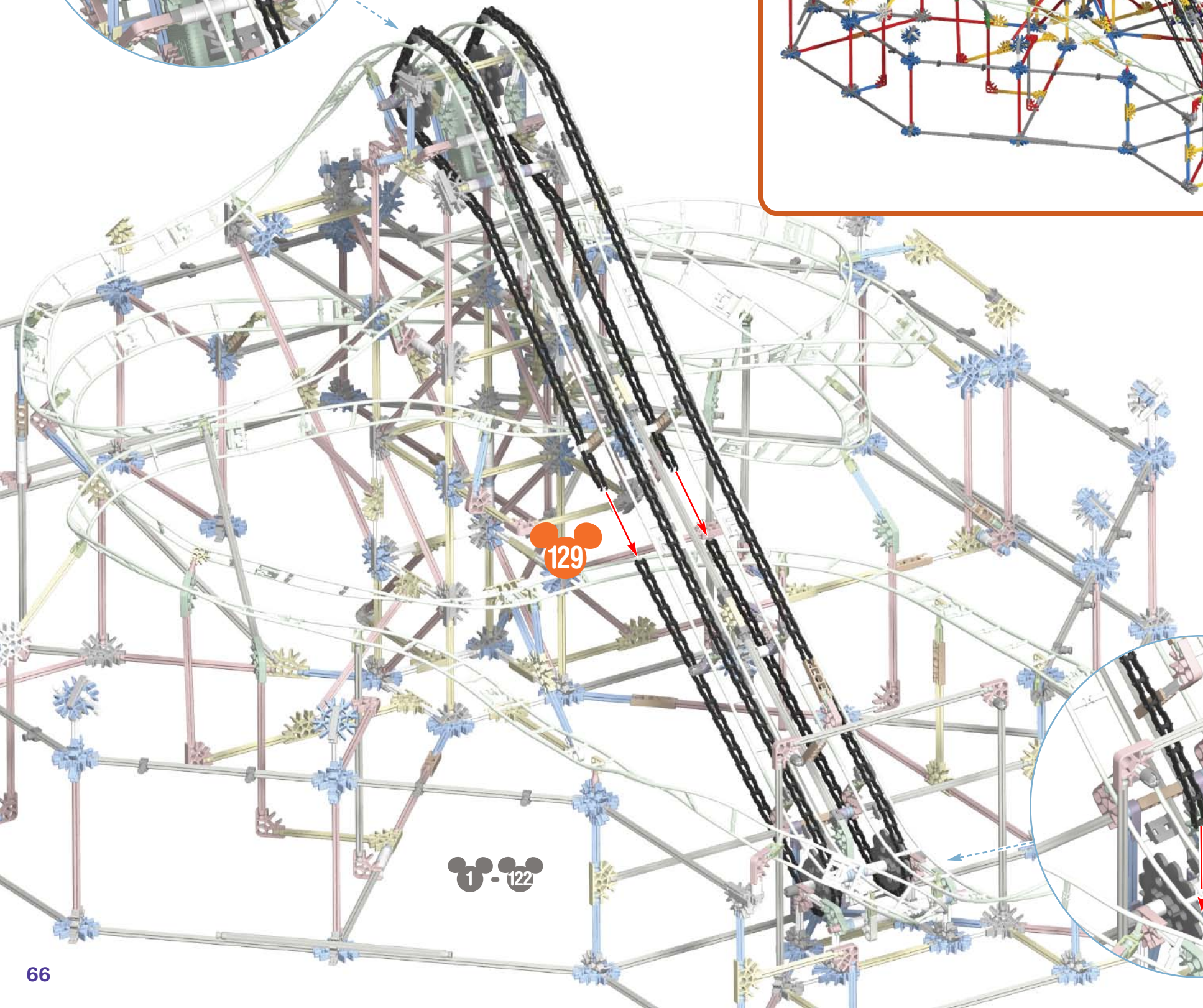
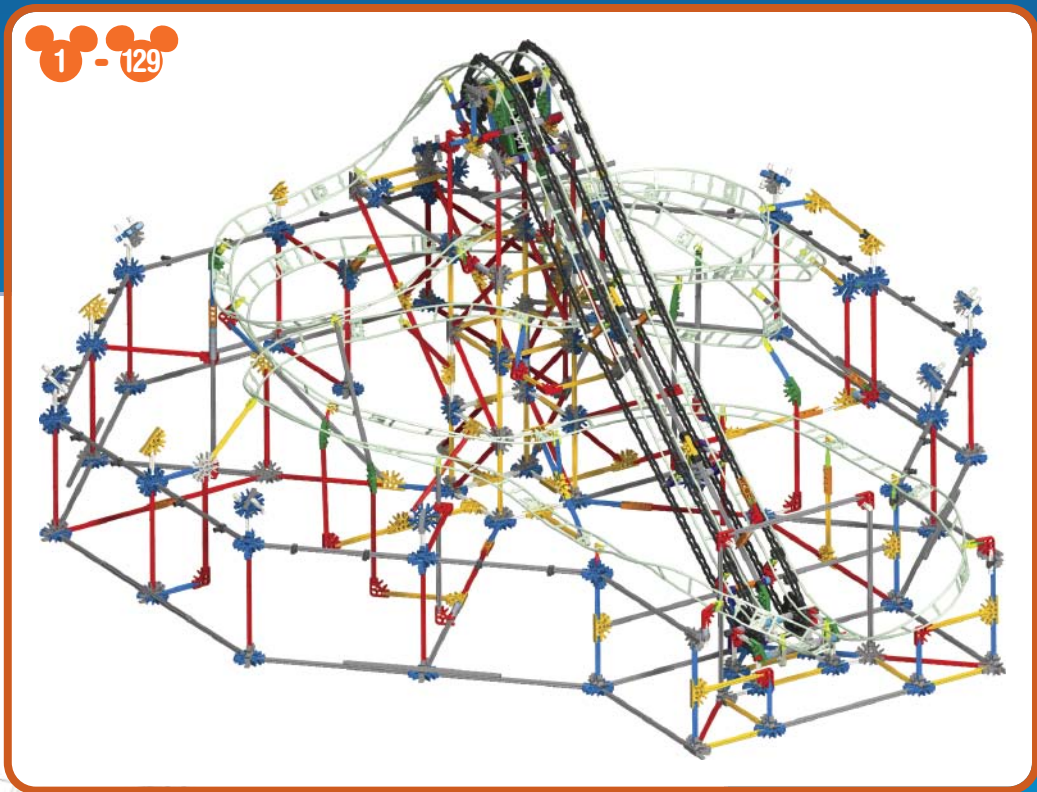
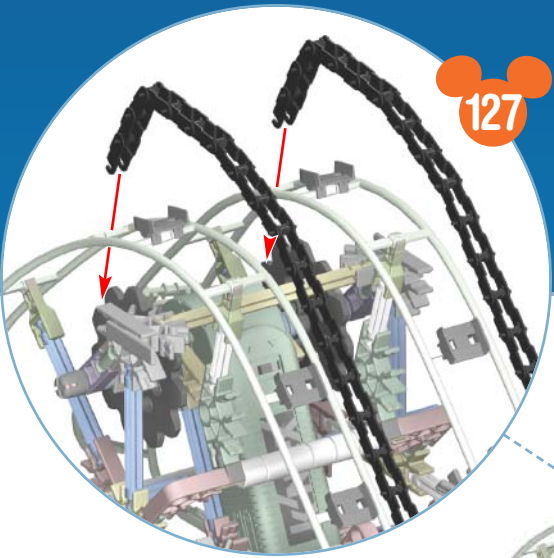

1-122

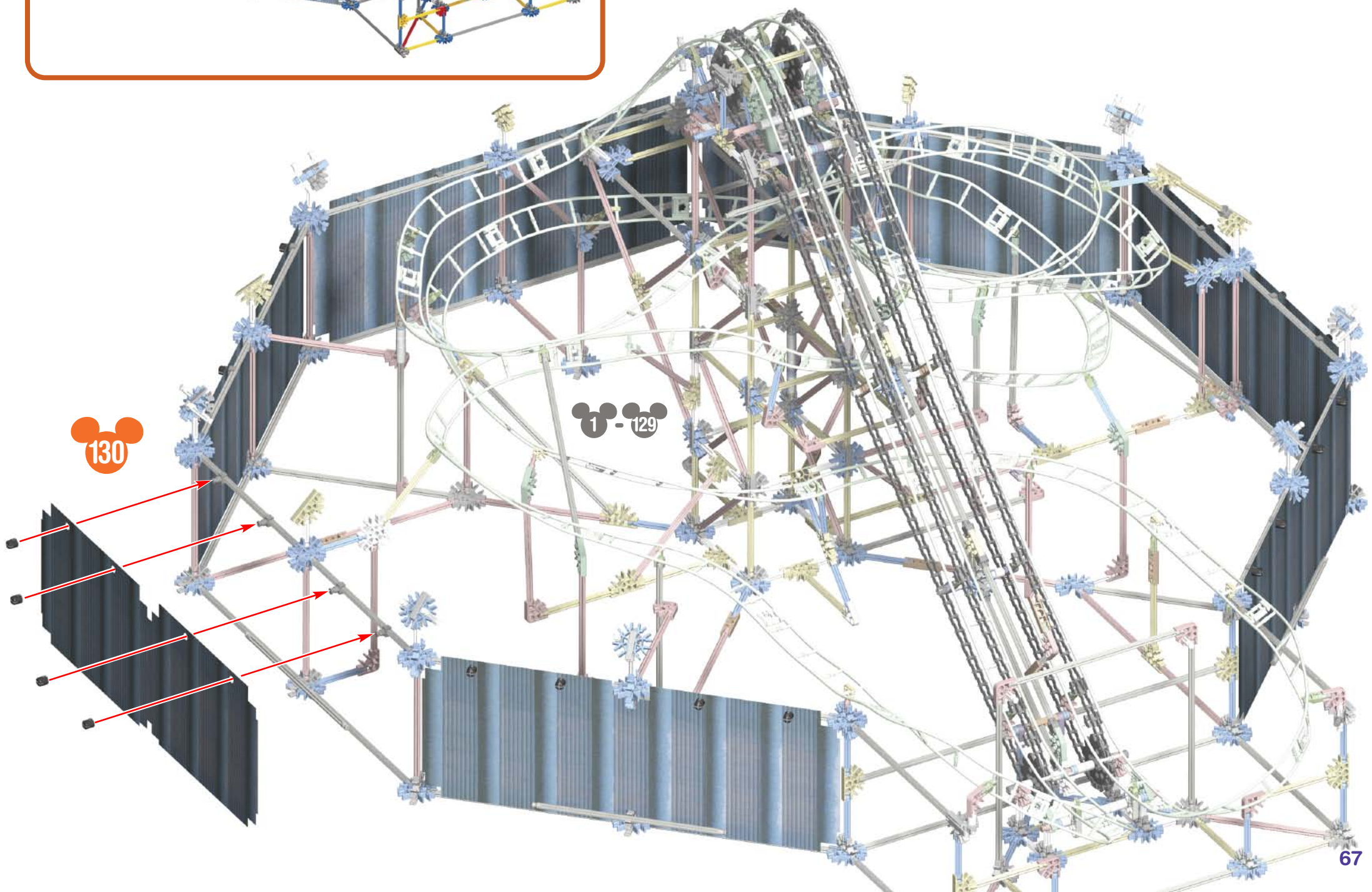
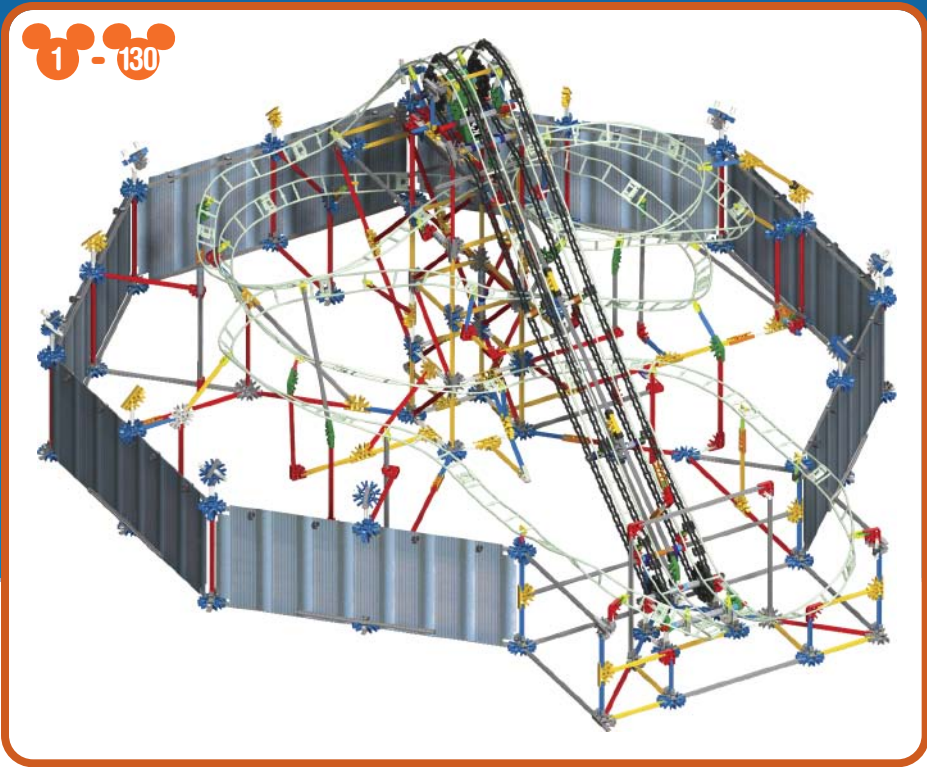

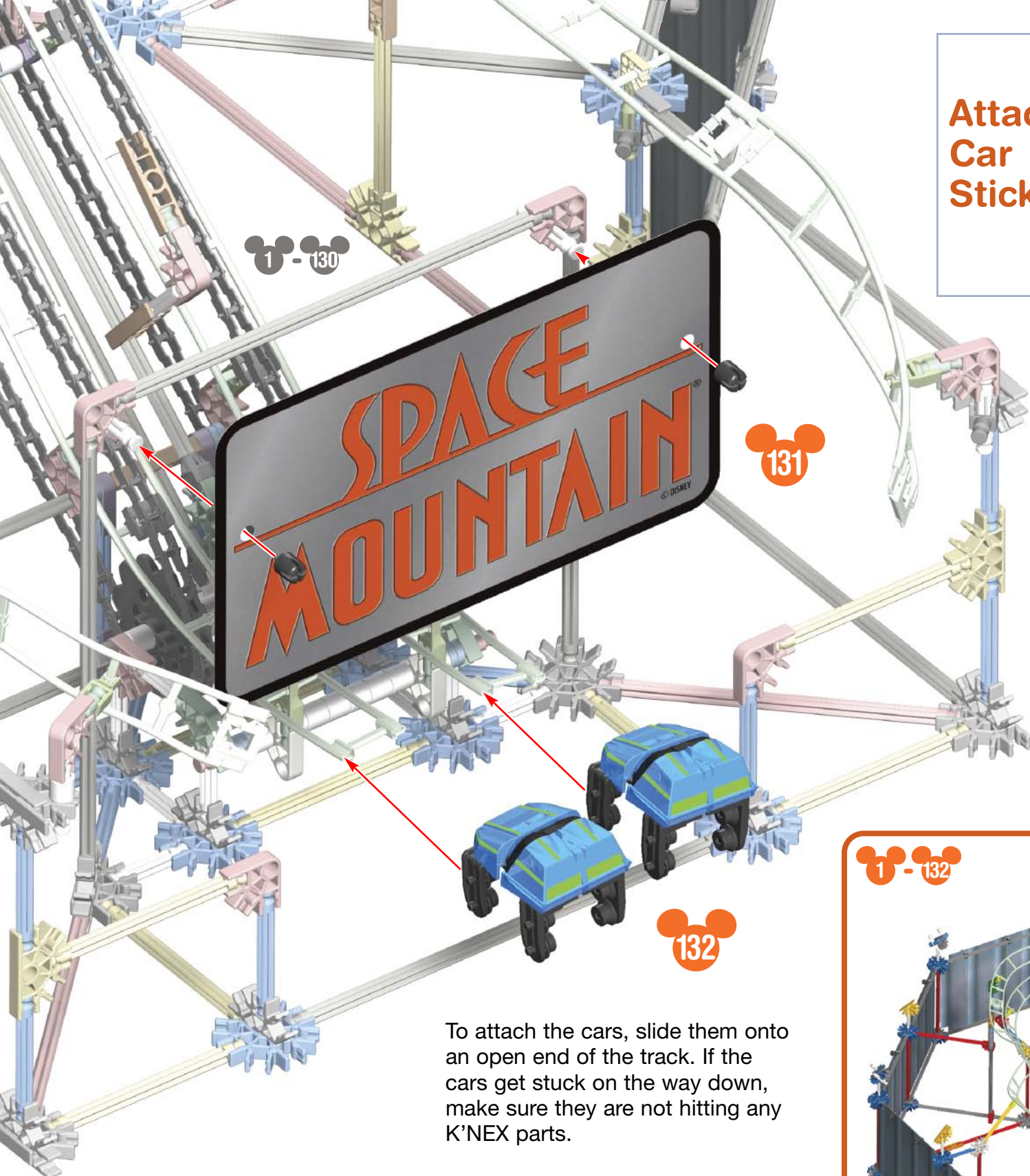

**Attach  
Car  
Stickers**

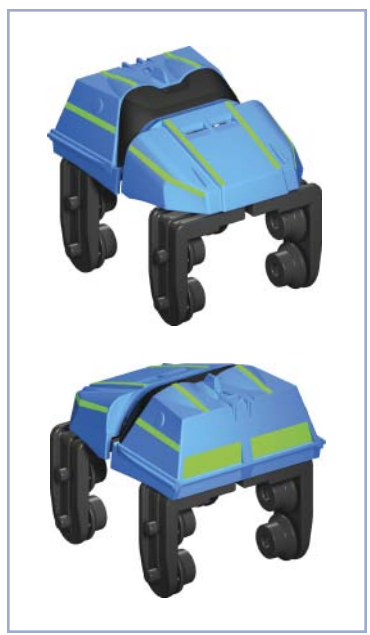
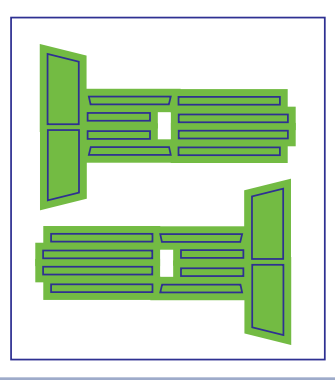

To attach the cars, slide them onto an open end of the track. If the cars get stuck on the way down, make sure they are not hitting any K'NEX parts.

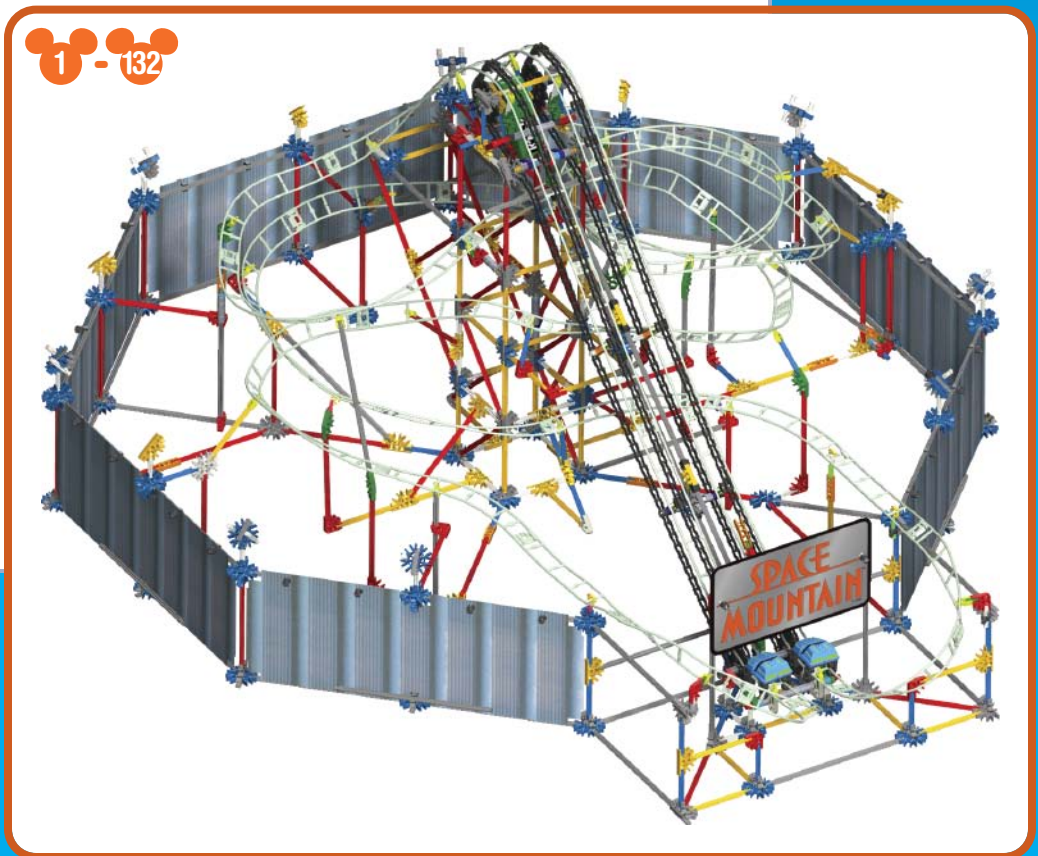

x6



133

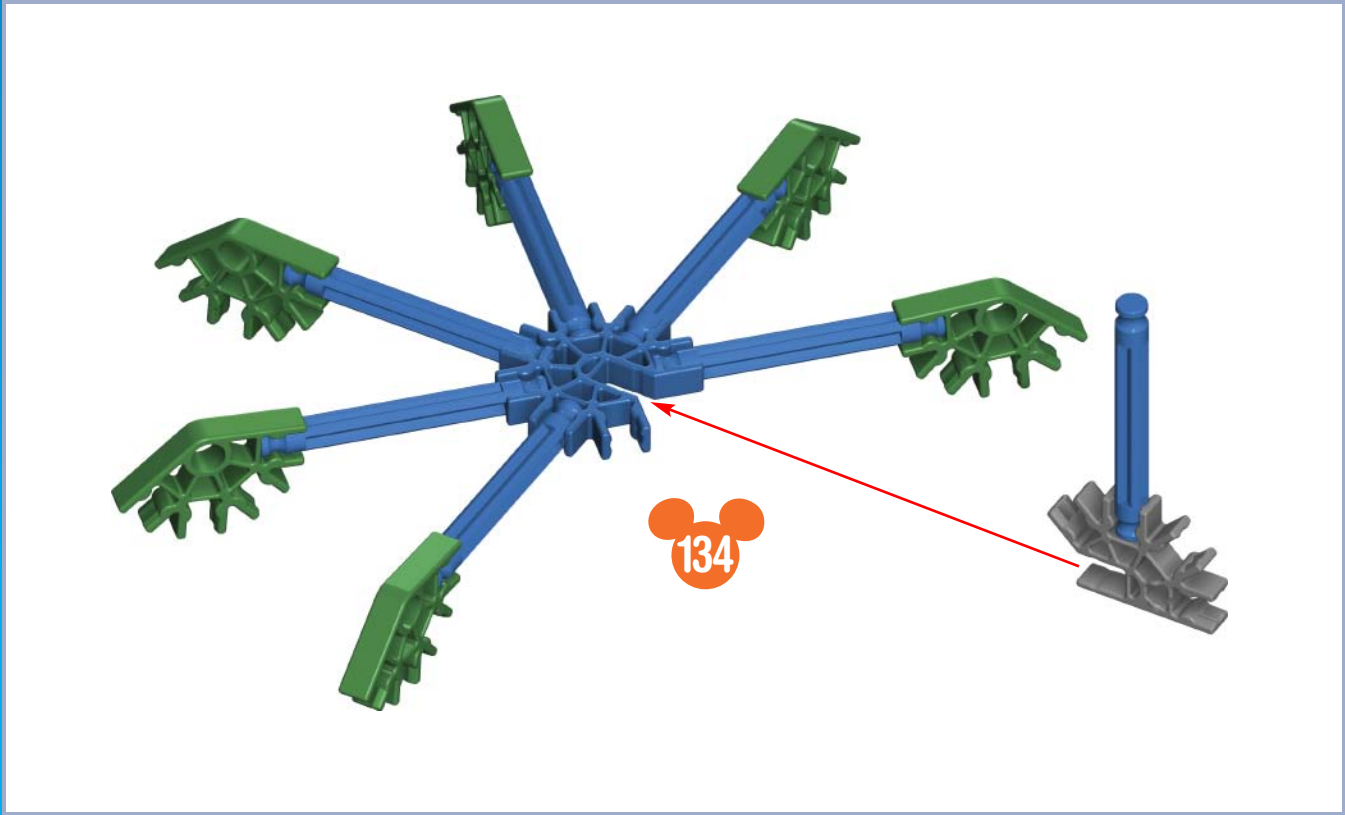

134

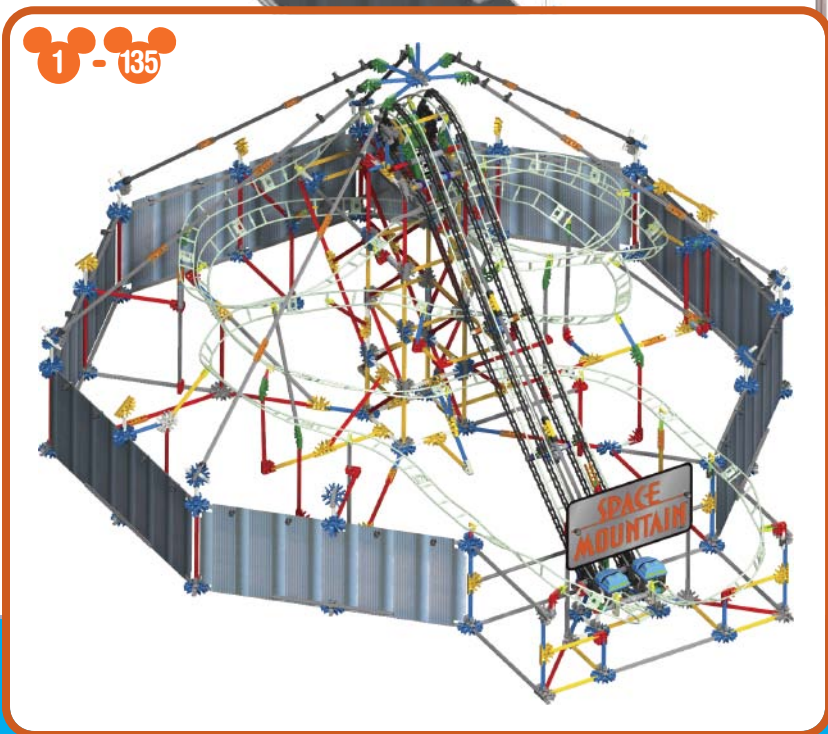
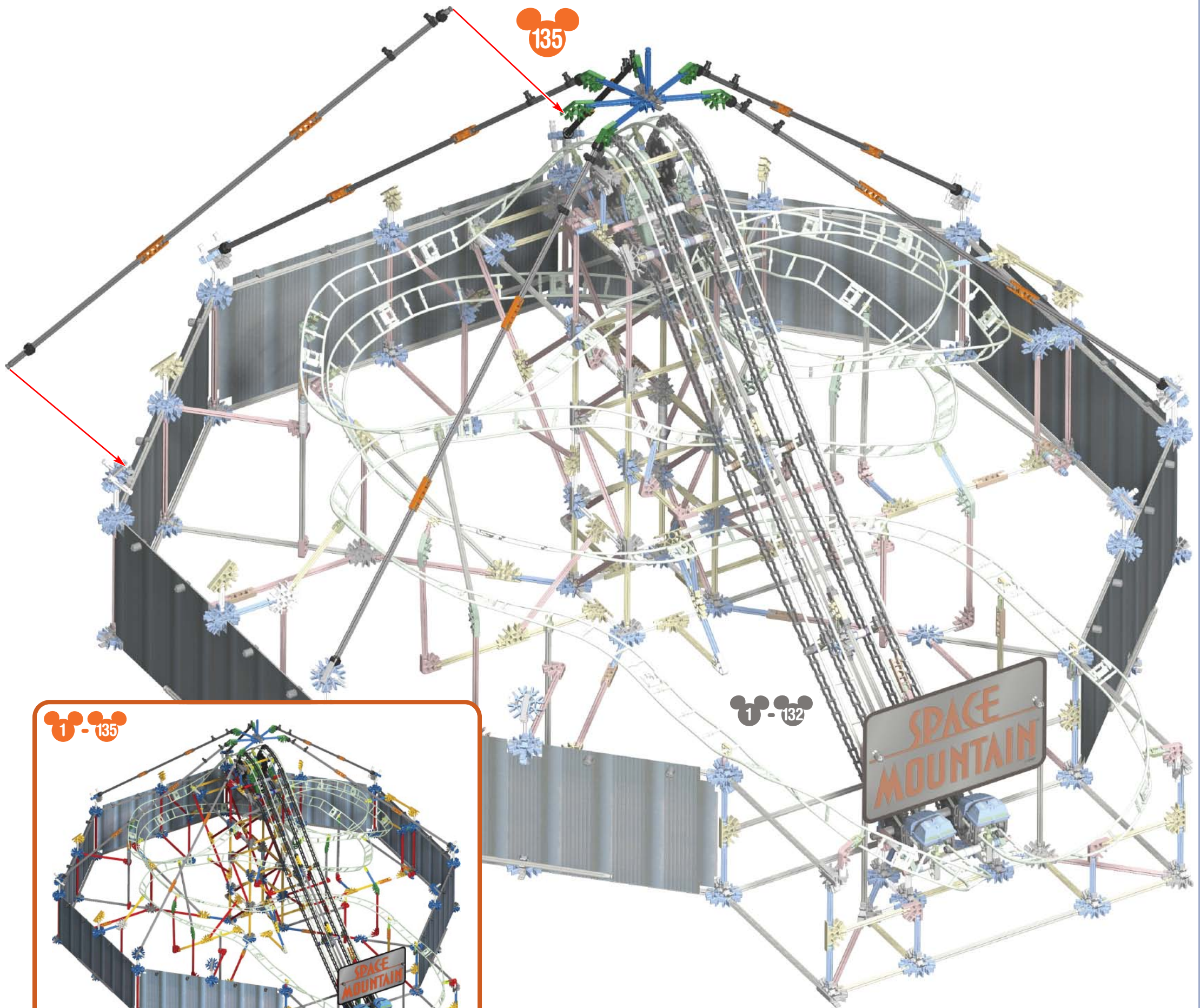

x5



136

x2



137

x1



138

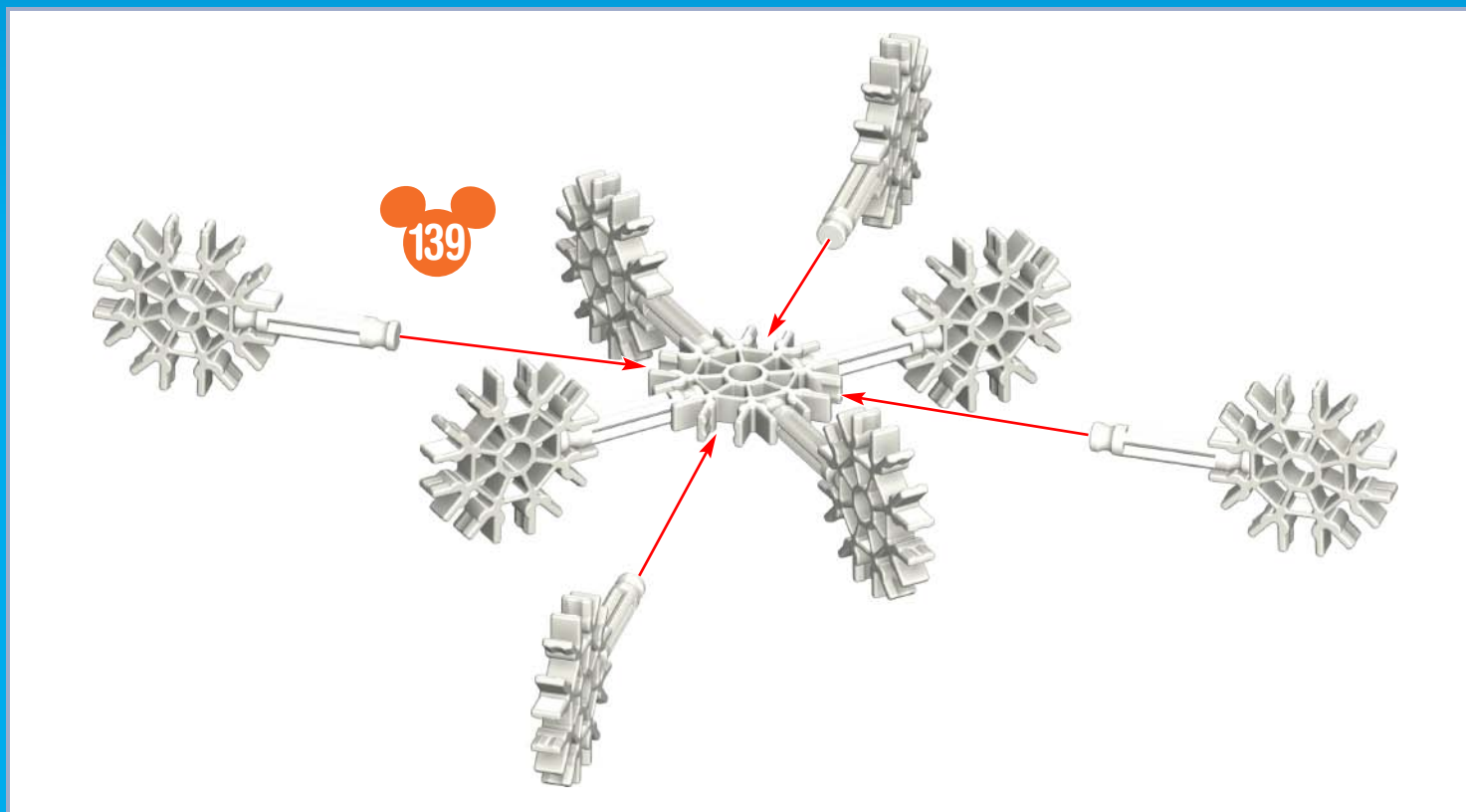

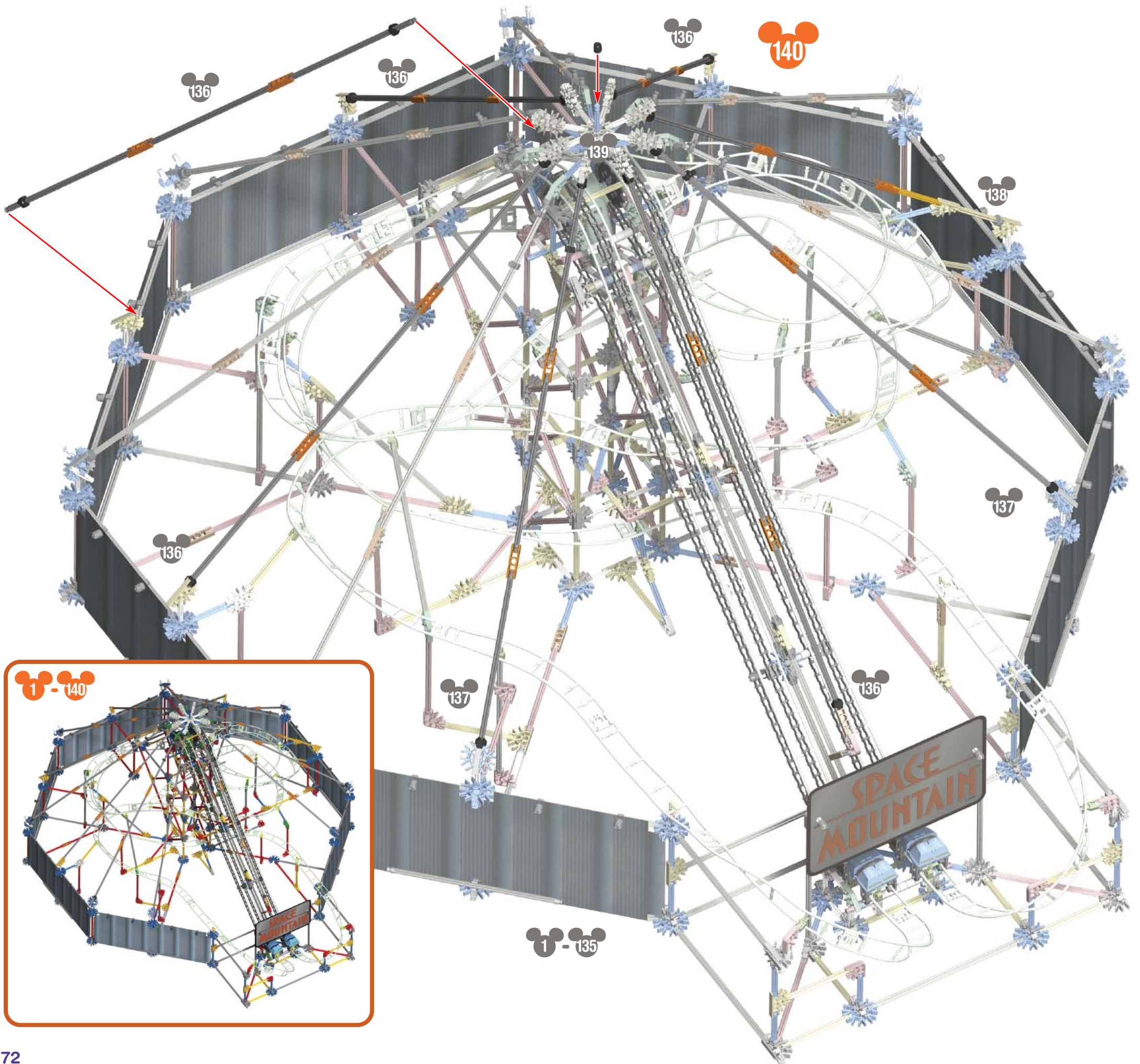

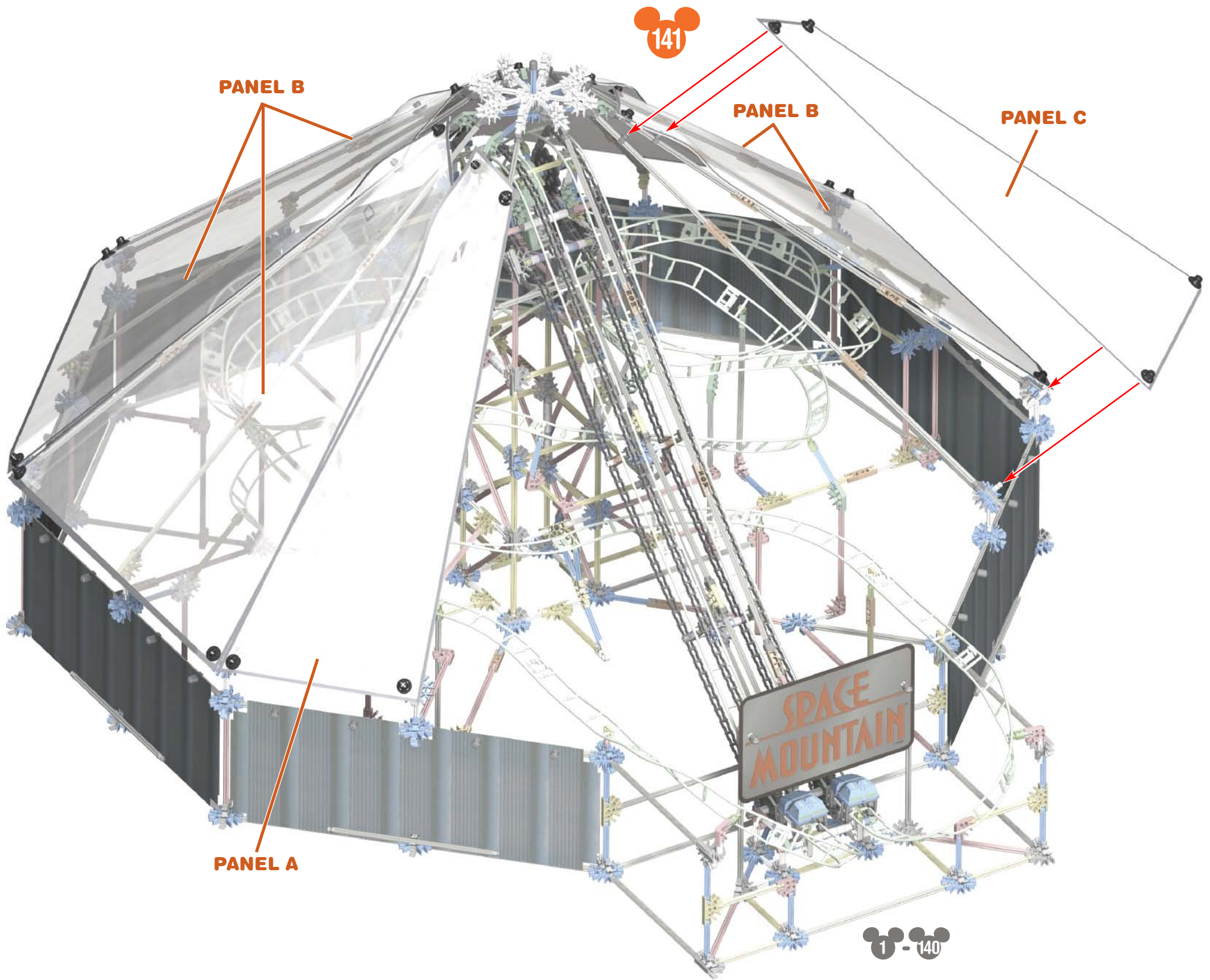

## Attach Panel Stickers



142

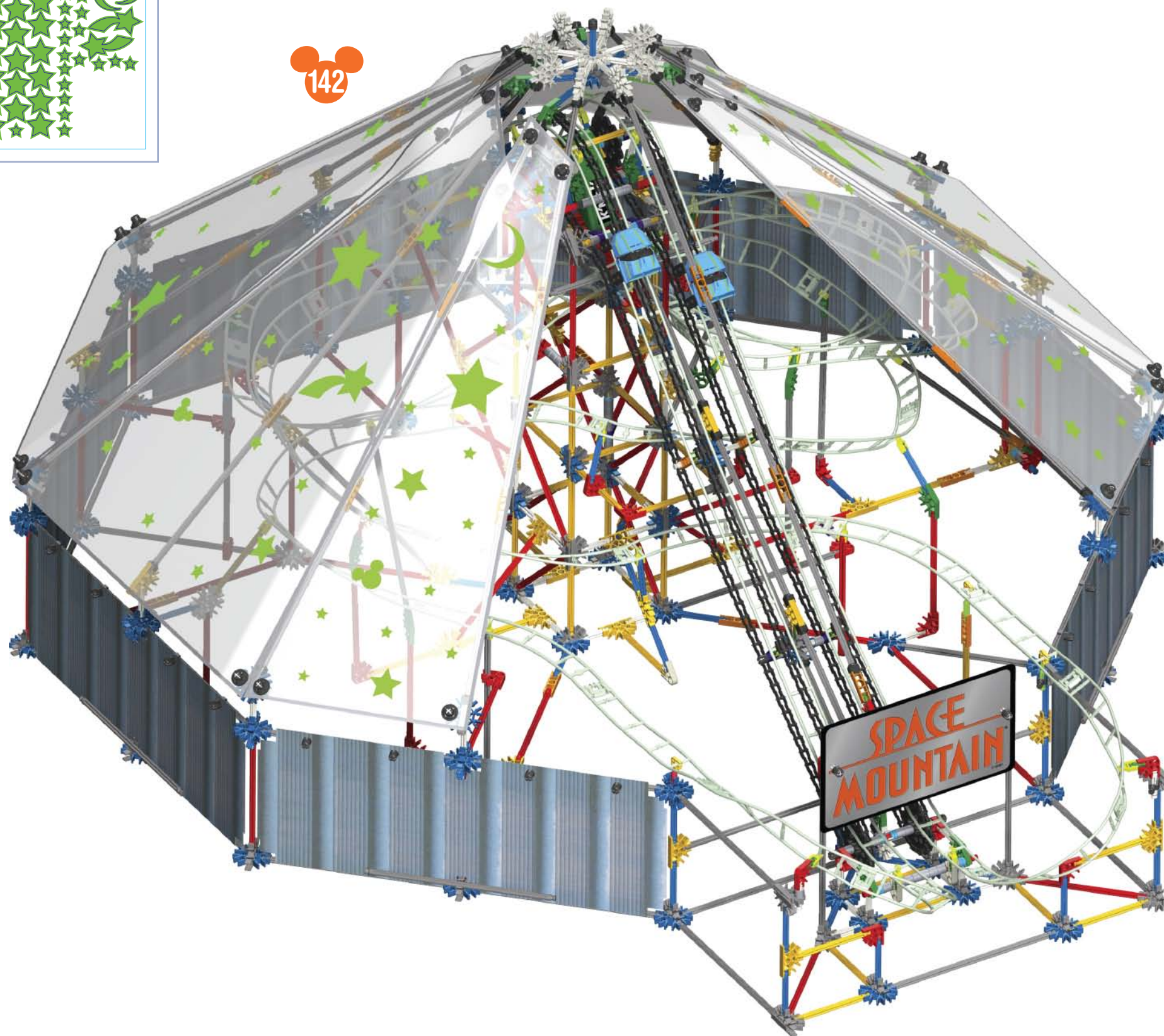

## TIPS & TROUBLESHOOTING

### If the motor is not working properly:

- Check to see if you have fresh batteries and that they are installed correctly.
- If it is still not working, call our Consumer Hotline at 1-800-KID-KNEX (USA and Canada only). See the back cover for other ways to contact K'NEX.

### If a car gets stuck on the track:

- Is the model built correctly?
- Make sure the car is not hitting any K'NEX parts.
- Are the track pieces connected properly?
- Is the car attached to the track correctly?
- Adjust the track to eliminate any flat or little bumpy spots on the track.

### Need additional building help?

- Go to the K'NEX Web site: [www.knex.com/tips](http://www.knex.com/tips)

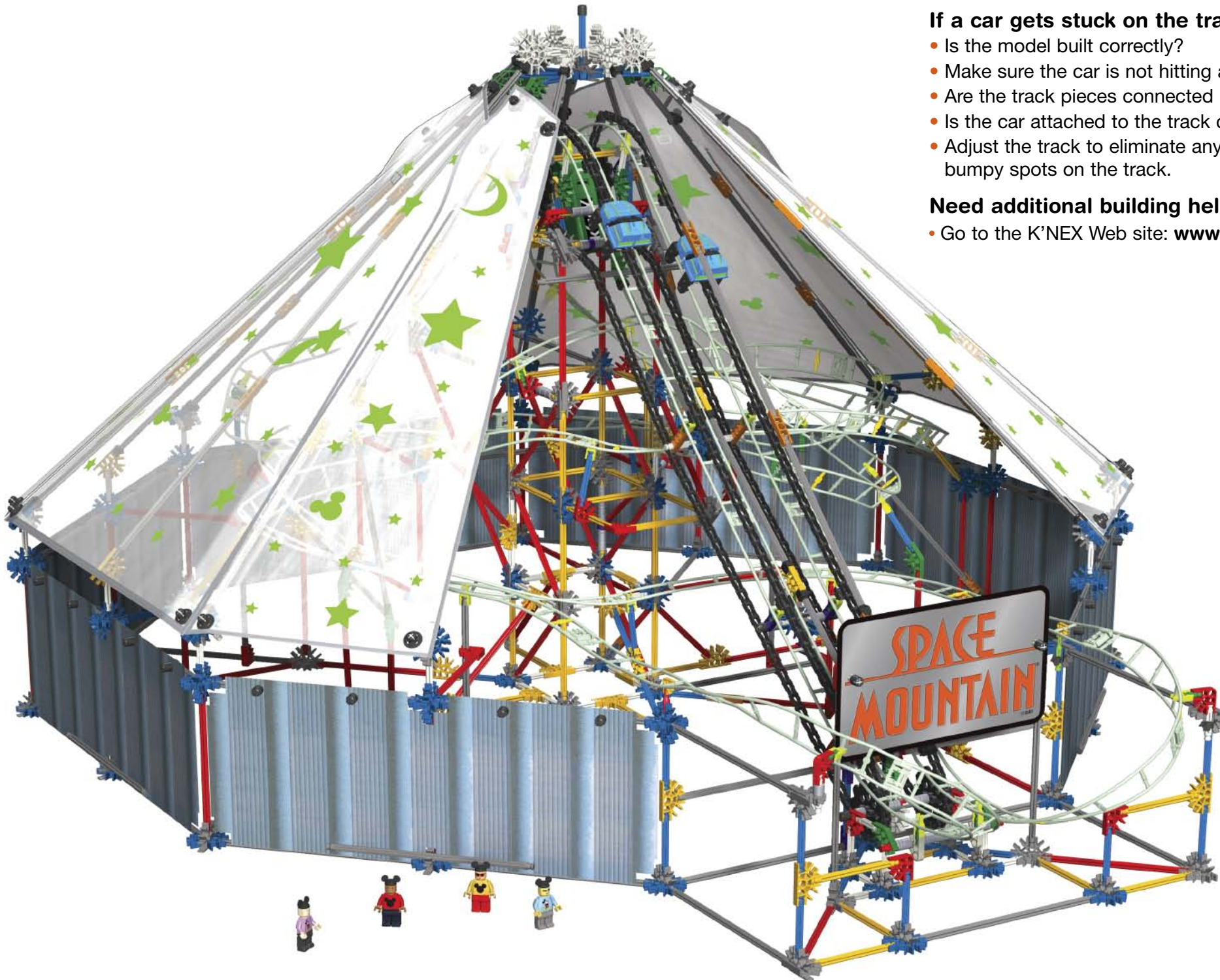

Disney  
BUILD-IT!

# Disney Parks



## Dumbo Building Set



Also Available  
from Disney Parks & K'NEX.  
Set Sold Separately.



2+ Feet!

### Authentic Details!



### 4 Figures!



### Motorized Performance!



Disney.com  
Disney Theme Park Merchandise  
Lake Buena Vista, FL 32830  
©DISNEY

Product & colors may vary. Most models can be built one at a time.  
K'NEX is a registered trademark of K'NEX Limited Partnership Group.  
Manufactured under U.S. Patents 5,061,219; 5,199,919; 5,350,331; 5,137,486;  
D393,417; 5,346,420; 5,427,559. Other U.S. and foreign patents pending.

K'NEX Customer Service  
Call: 1-800-KID-KNEX (USA/CAN only)  
Email: email@knex.com  
Online: www.knex.com

©2010 K'NEX Limited  
Partnership Group  
P.O. Box 700  
Hatfield, PA 19440-0700



410458.11-V1-12/09