

CREATION ZONE

Building Set

Baby Chick
page 1



Crane
page 9



Hot Rod
page 20



Rocketship
page 32

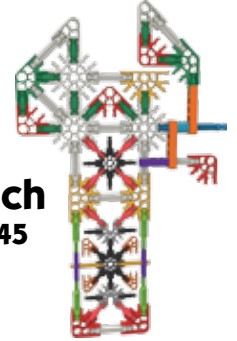

Wrench
page 45

Bee
page 3

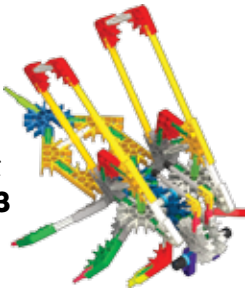

Dragonfly
page 14

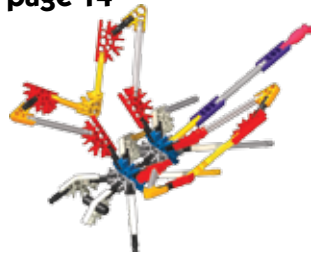

Long Truck
page 24



Spin Ride
page 35



Airplane
page 47



BUTTERFLY BASKET
page 6



Forklift
page 17

Parrot
page 28



V.T.O.L.
page 40



BABY CHICK



- | | | | |
|---|--|---|--|
| 4 | | 2 | |
| 2 | | 4 | |
| 4 | | 2 | |

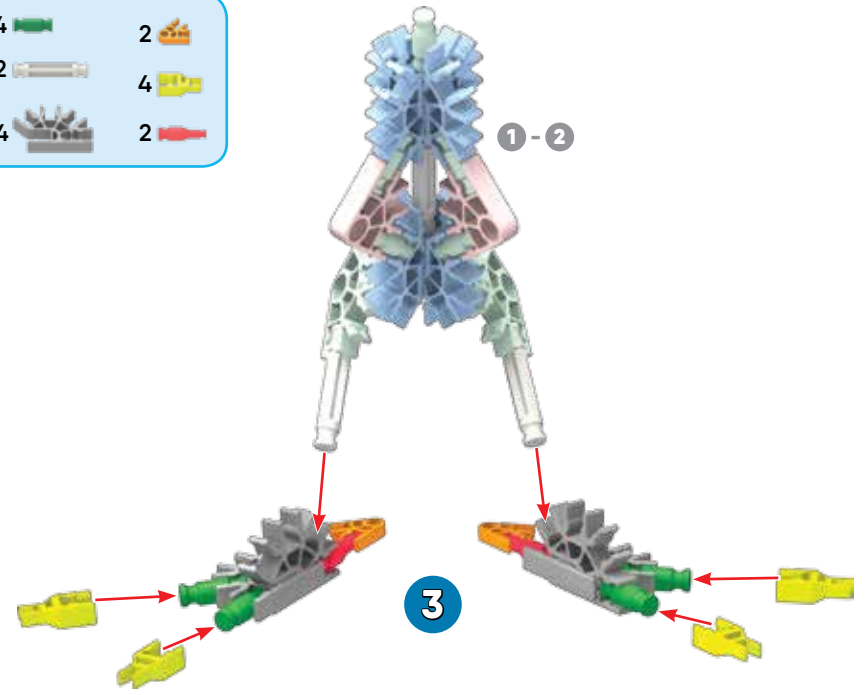

- | | | | |
|---|--|---|--|
| 7 | | 2 | |
| 1 | | 4 | |
| 2 | | | |

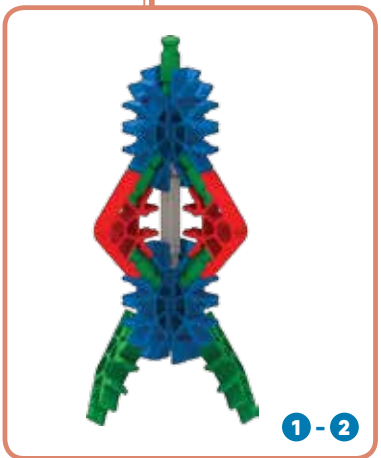
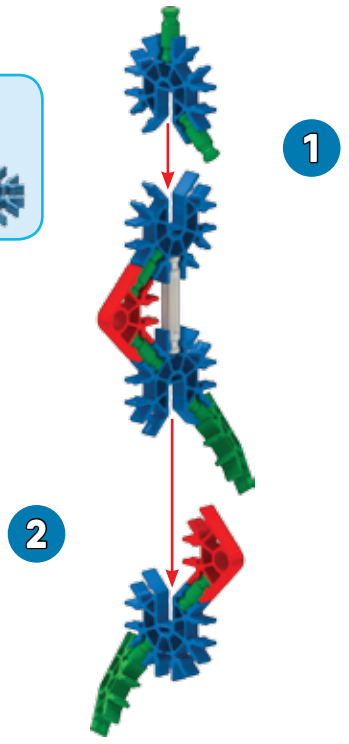

- | | | | |
|---|--|---|--|
| 4 | | 1 | |
| 1 | | 2 | |
| 1 | | 1 | |

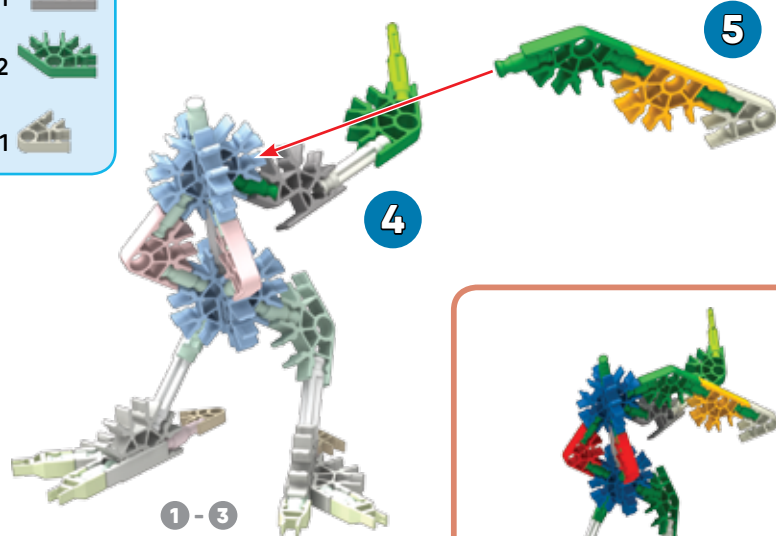

5



1-5

- | | | | | | | | |
|---|--|---|--|---|--|---|--|
| 2 | | 2 | | 2 | | 1 | |
| 2 | | 3 | | 1 | | 1 | |
| 1 | | 1 | | 1 | | | |

8

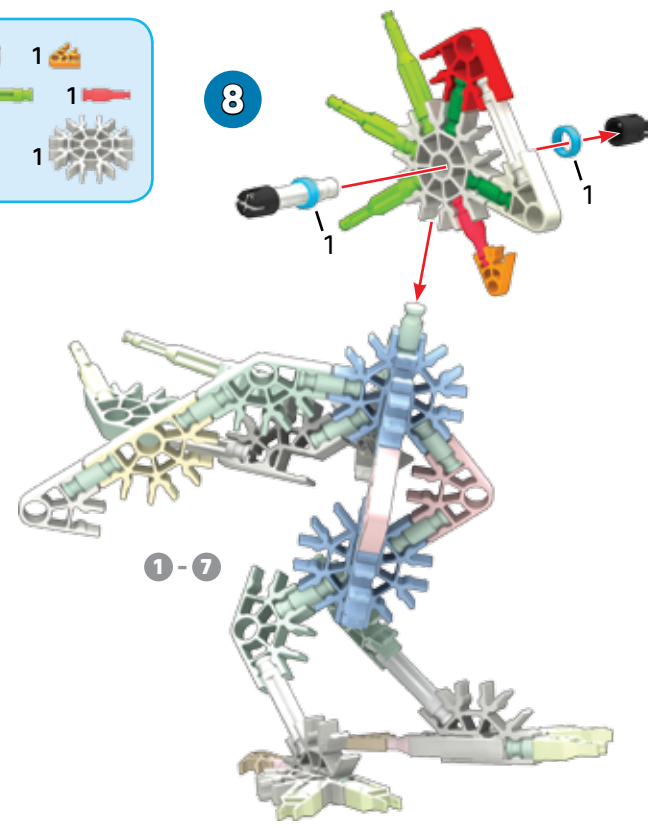

1-7

rotate model

7

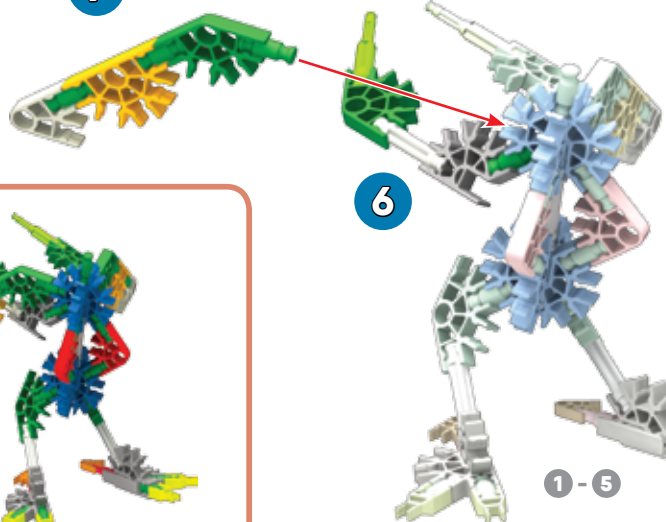

6

- | | | | |
|---|--|---|--|
| 4 | | 1 | |
| 1 | | 2 | |
| 1 | | 1 | |



1-7

1-5

BABY CHICK



1-8

BEE



- | | | |
|---|---|---|
| 2 | 2 | 2 |
| 1 | | 2 |
| 1 | | 1 |
| 2 | 3 | |

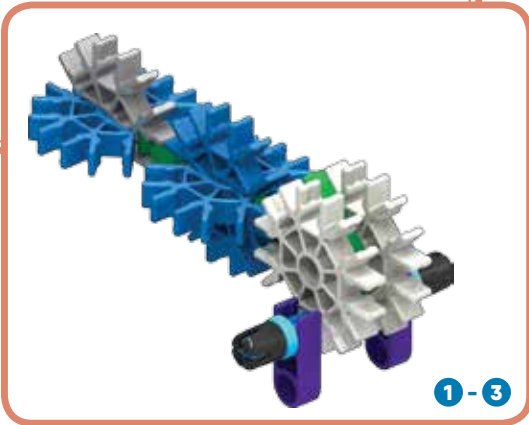
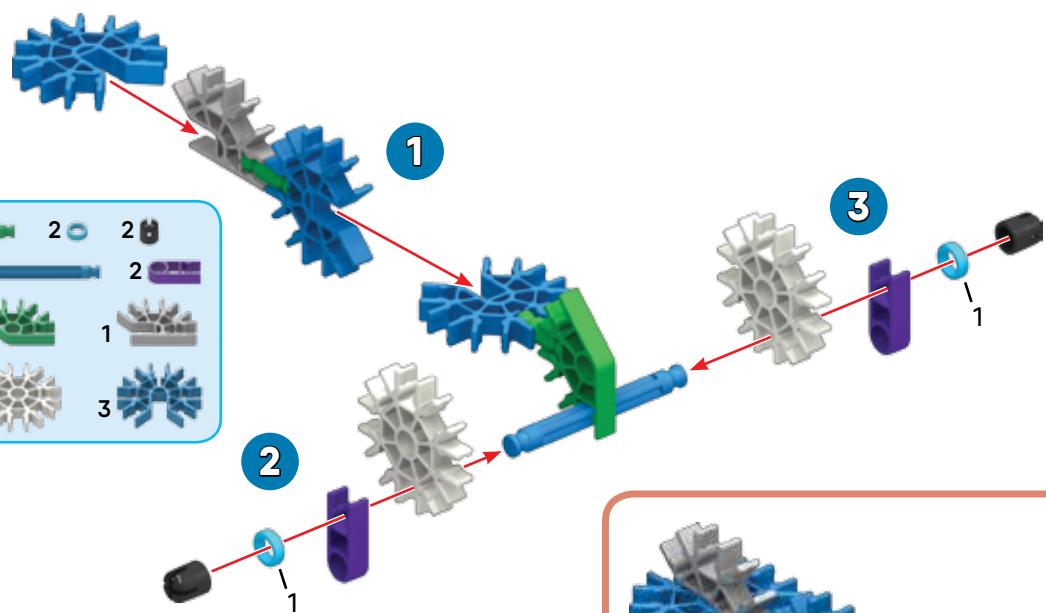

- | | |
|---|---|
| 8 | 4 |
| 2 | 4 |
| 2 | 4 |
| 4 | |

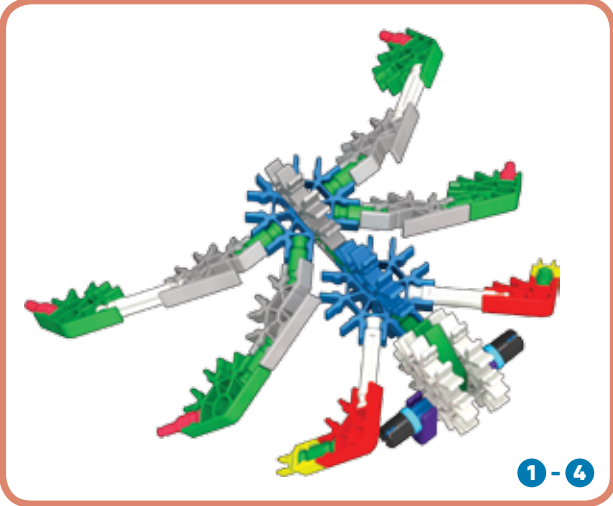
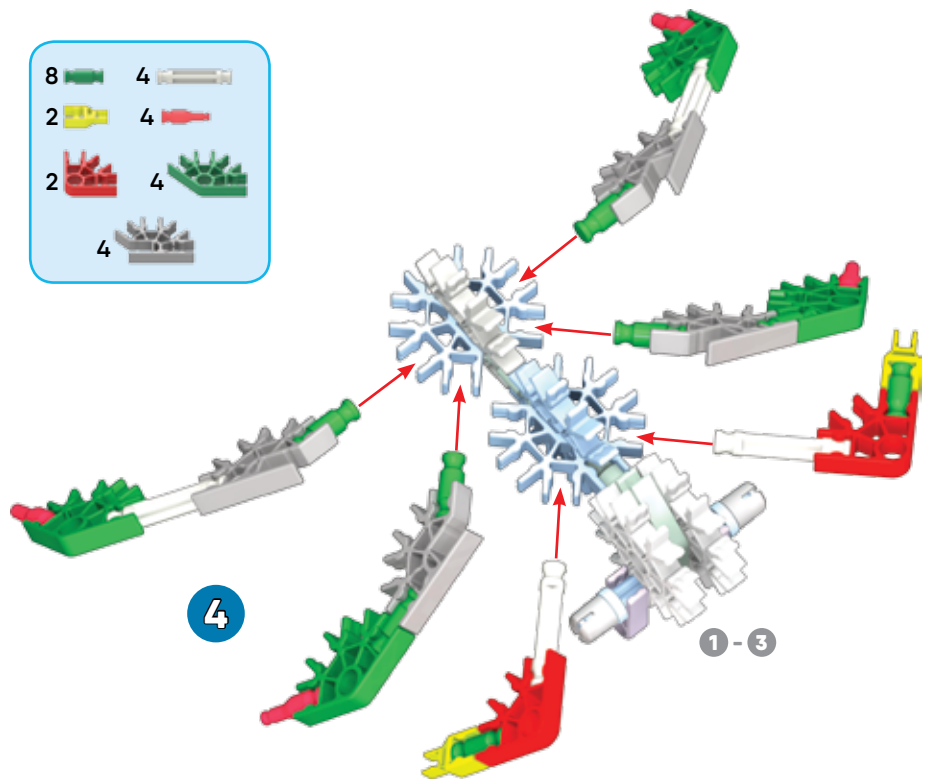

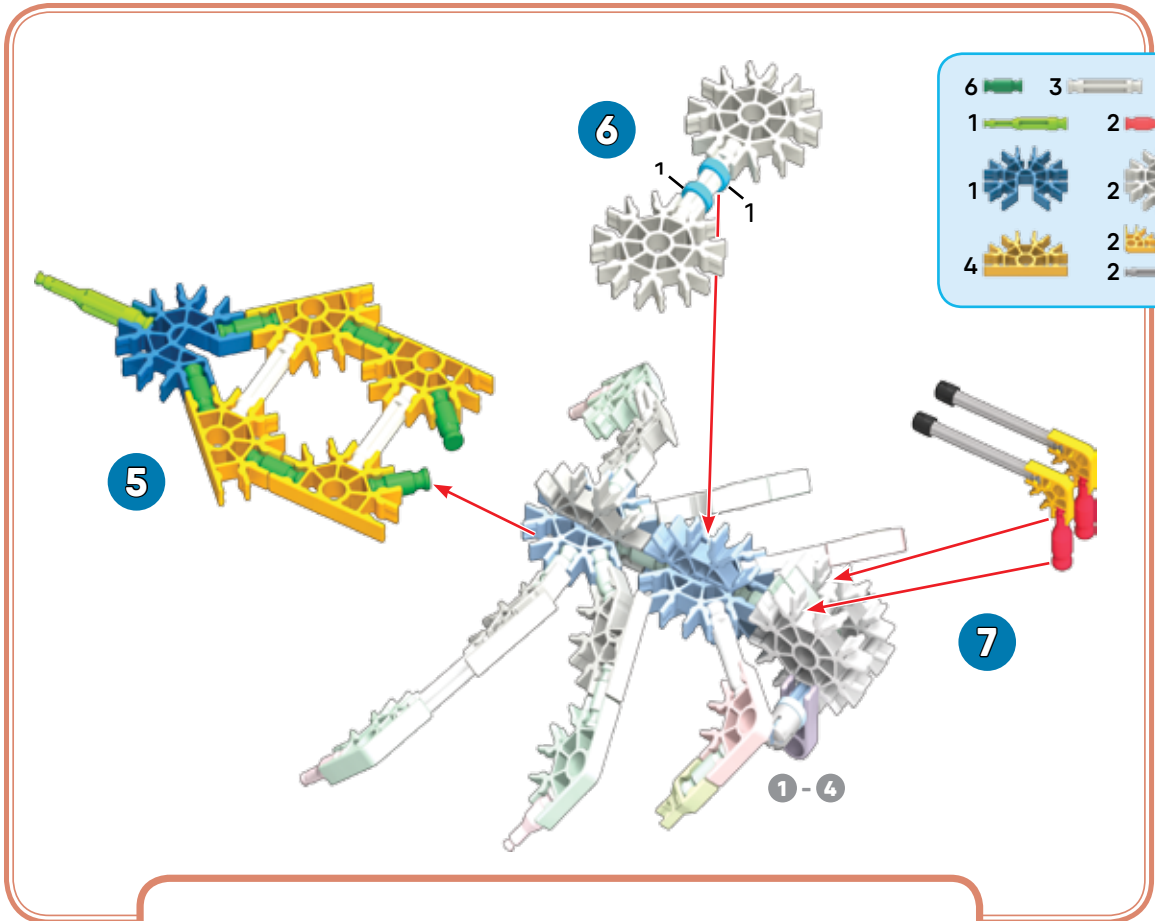

- | | | | | | |
|---|--|---|--|---|--|
| 6 | | 3 | | 2 | |
| 1 | | 2 | | | |
| 1 | | 2 | | | |
| 4 | | 2 | | 2 | |

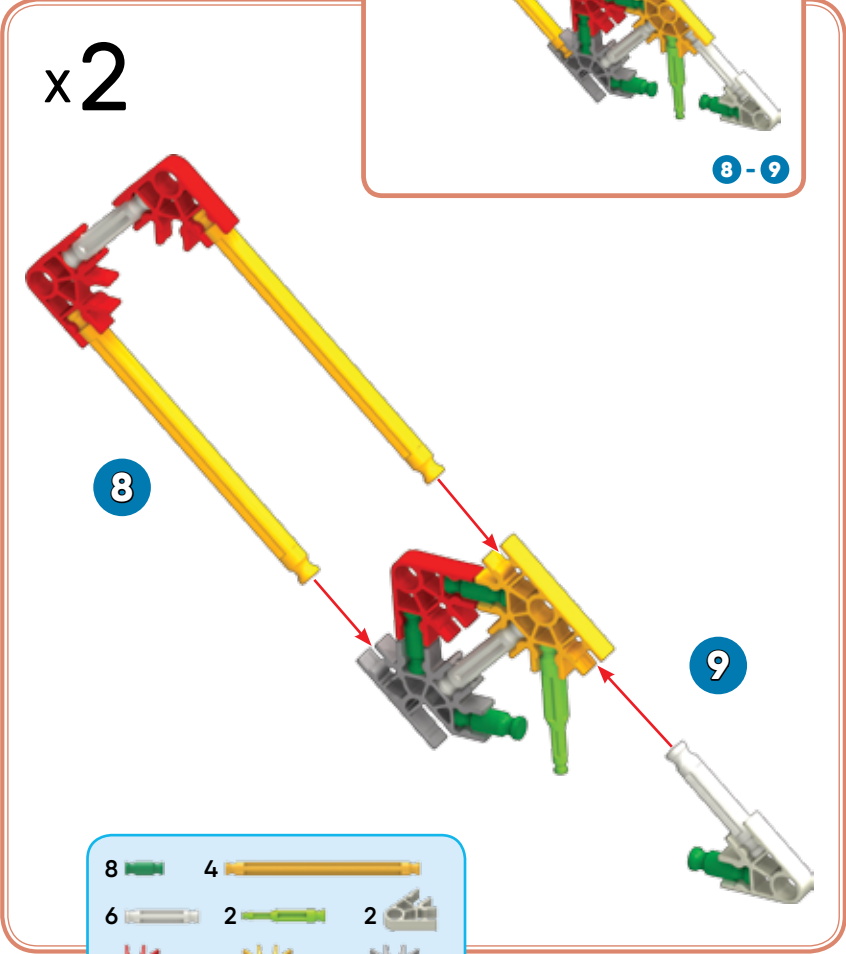

- | | | | | | |
|---|--|---|--|---|--|
| 8 | | 4 | | | |
| 6 | | 2 | | 2 | |
| 6 | | 2 | | 2 | |

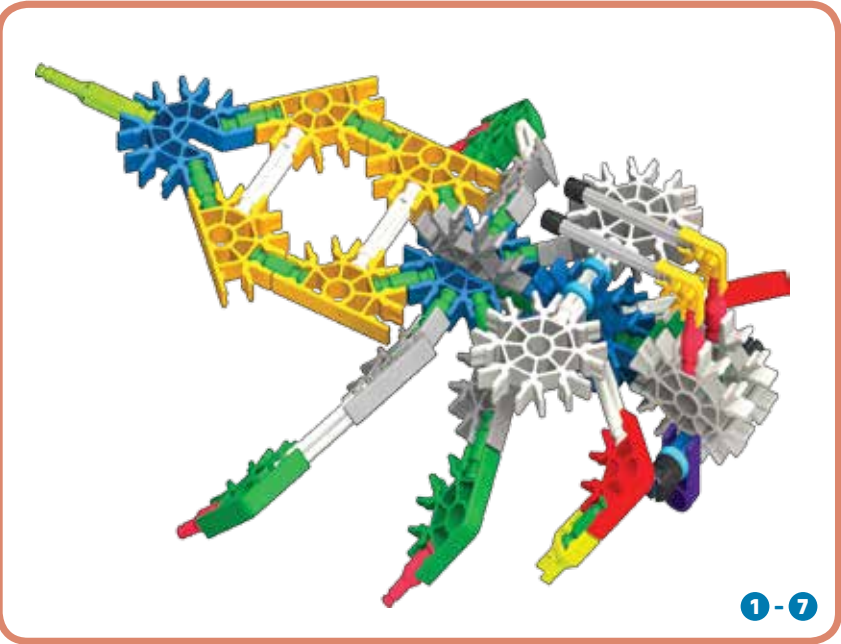

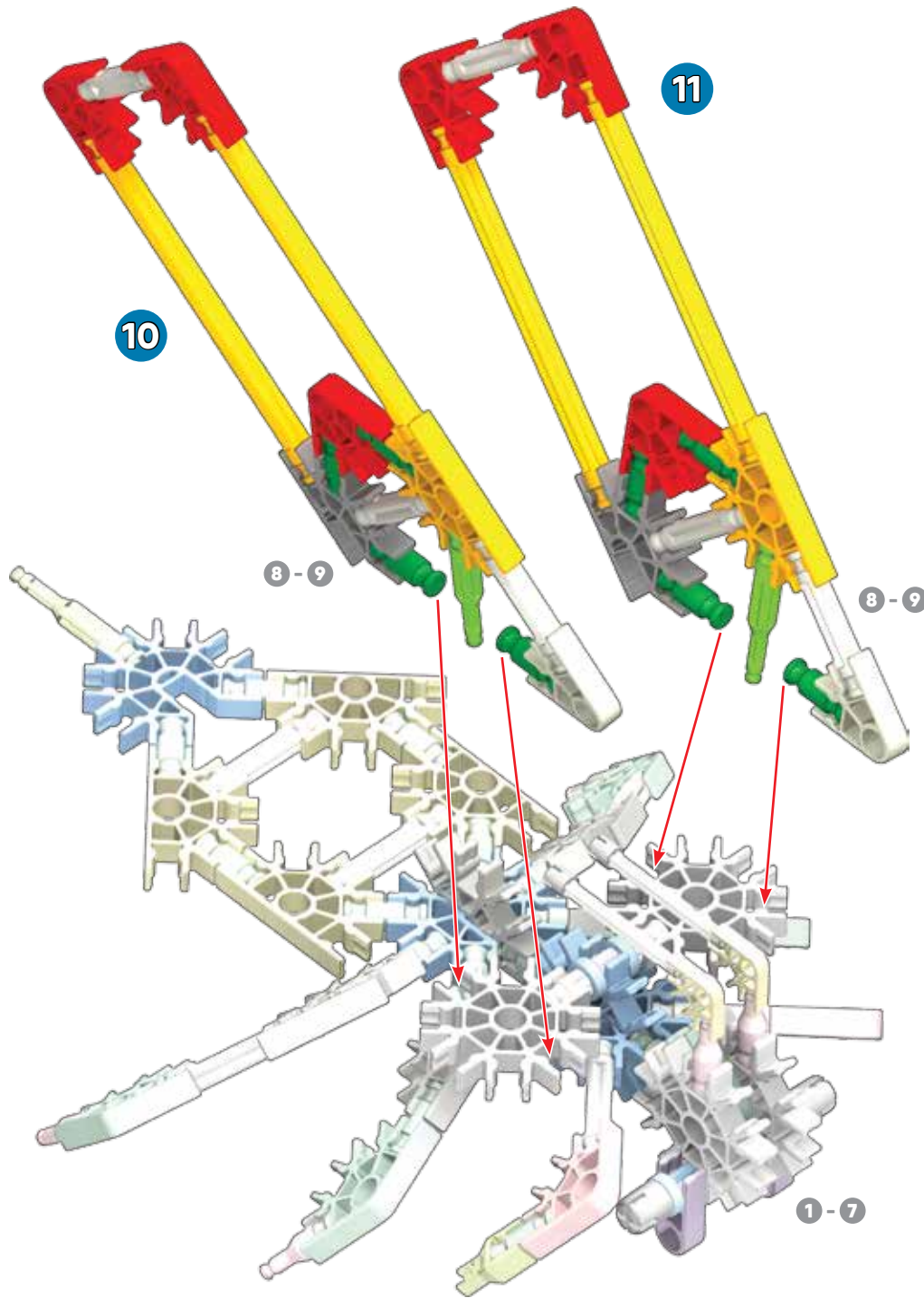

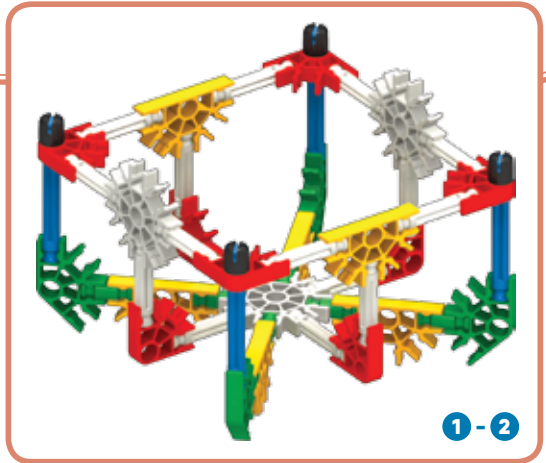
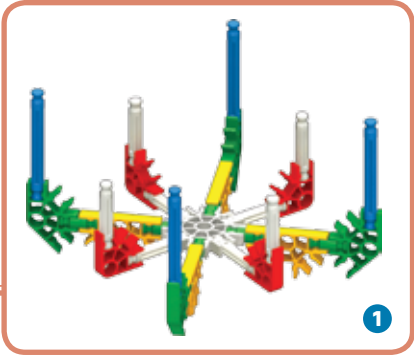
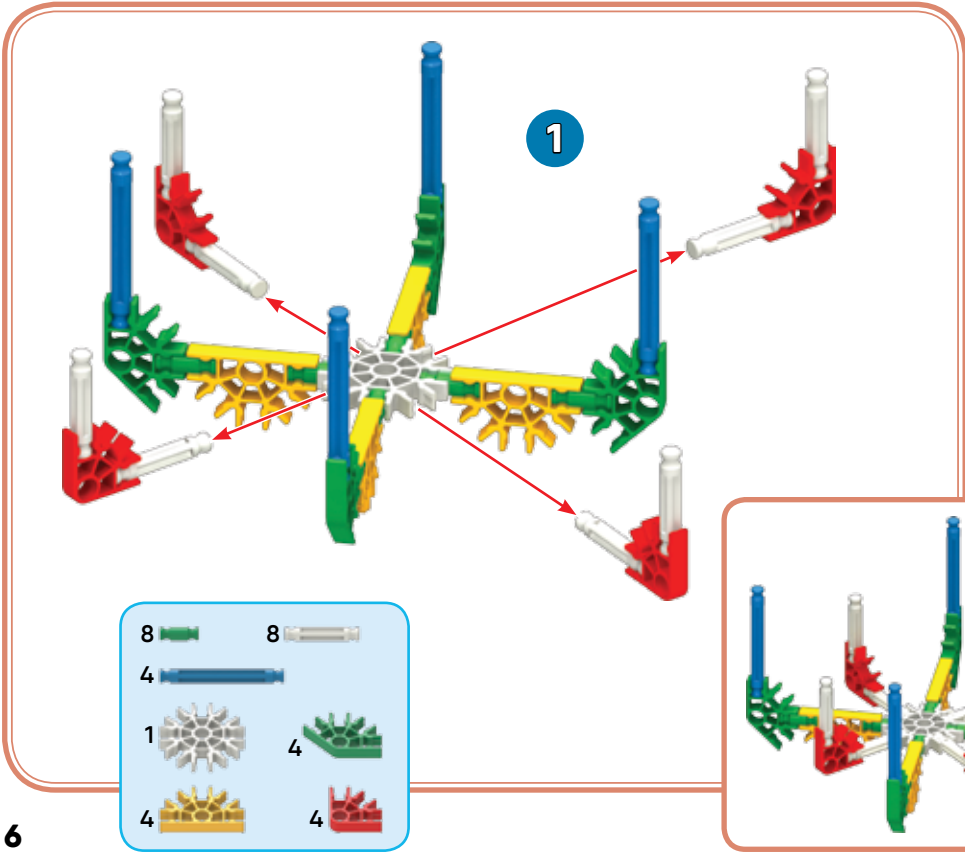
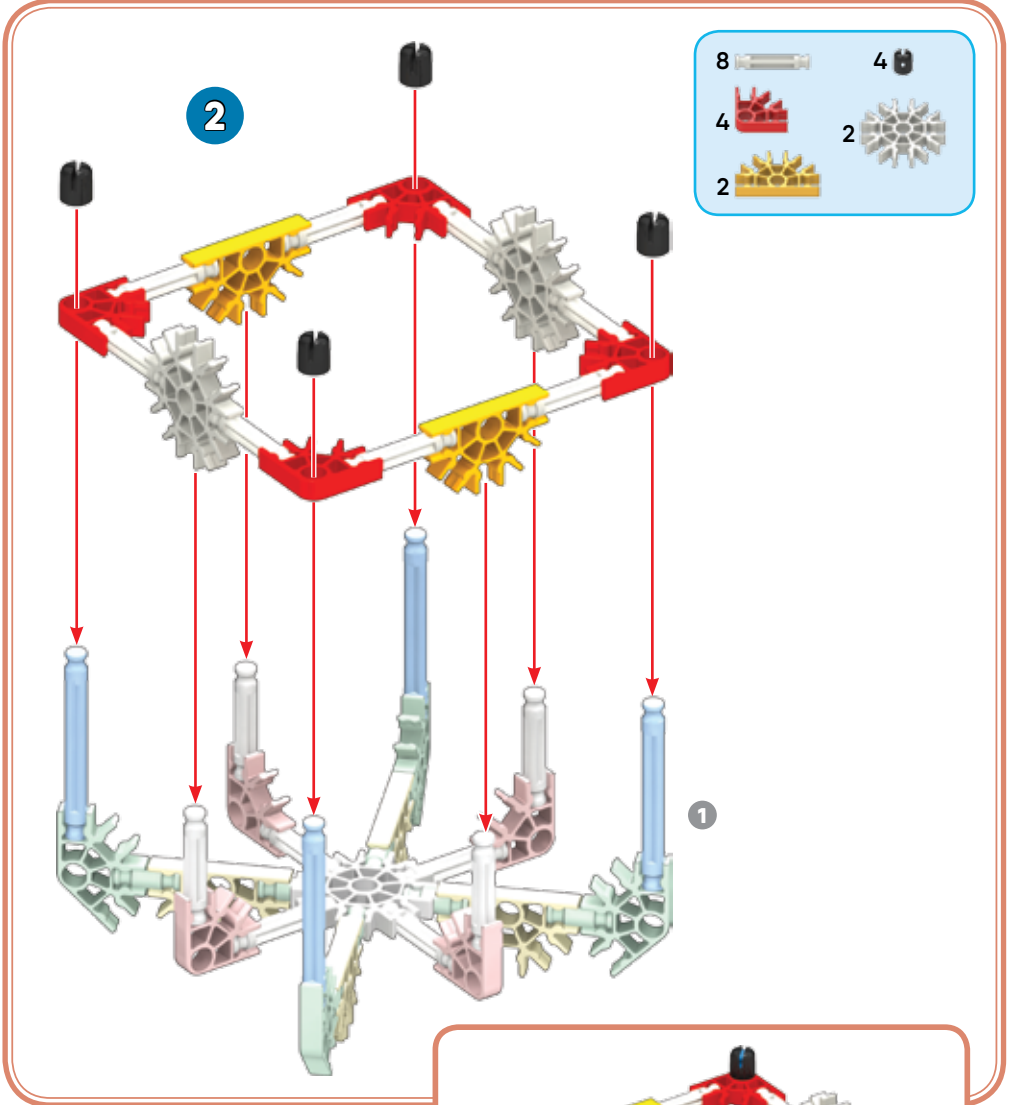

x8

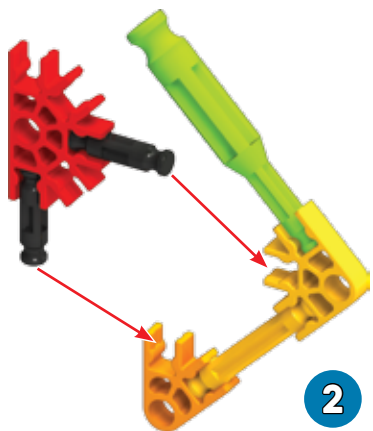

2

x8



2

16	8	8	8
8	8	8	8
8	8	8	8

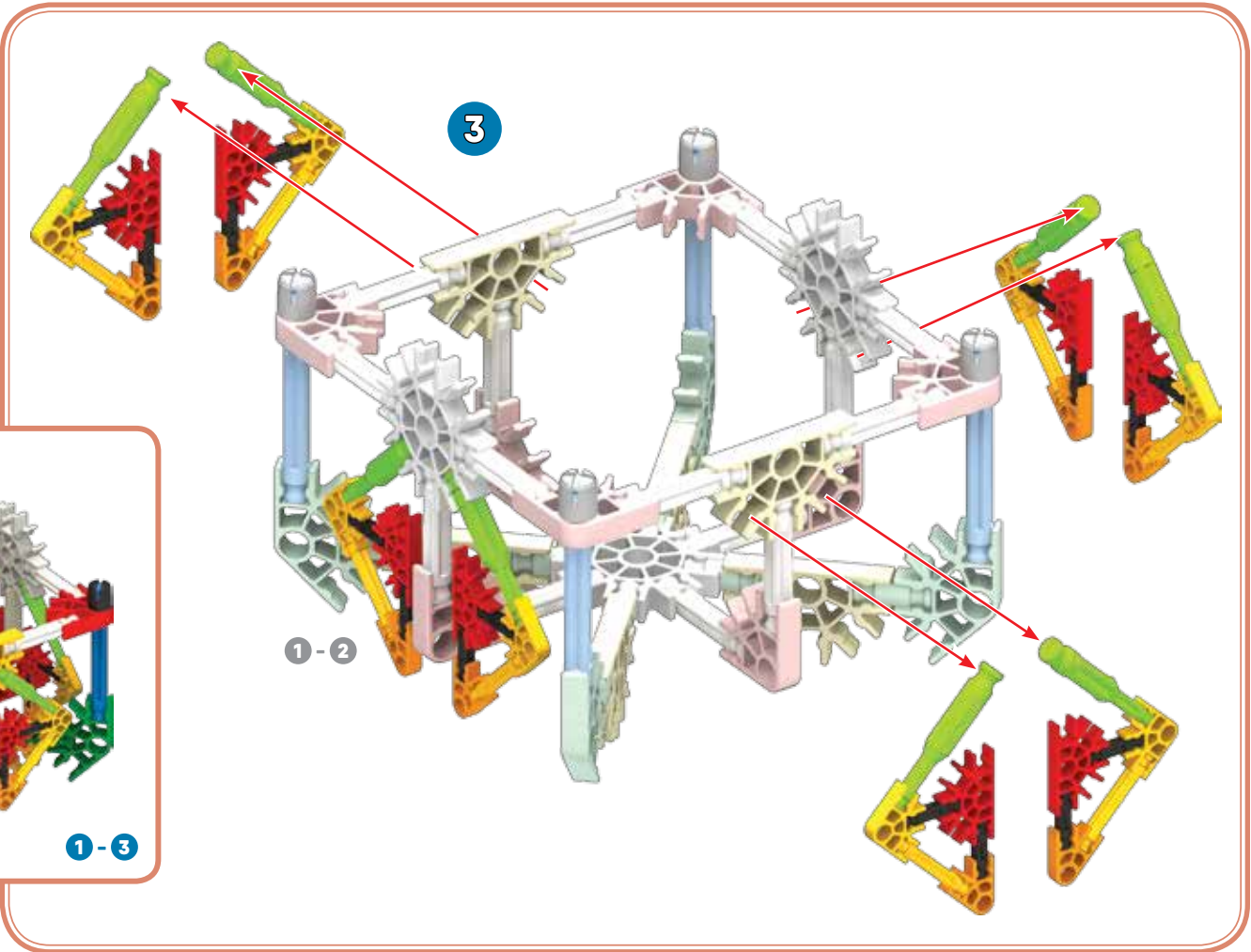

3

1-2

1-3

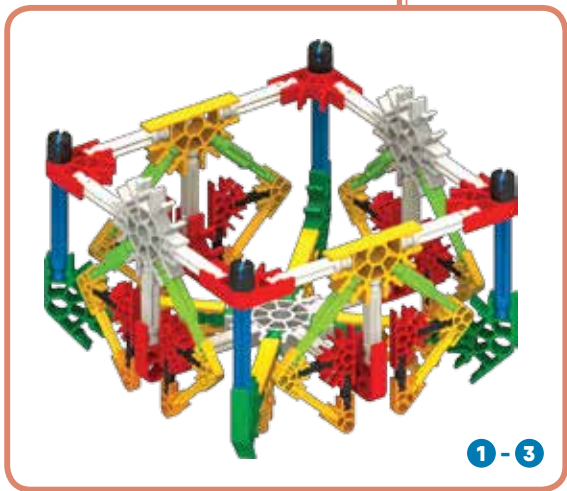

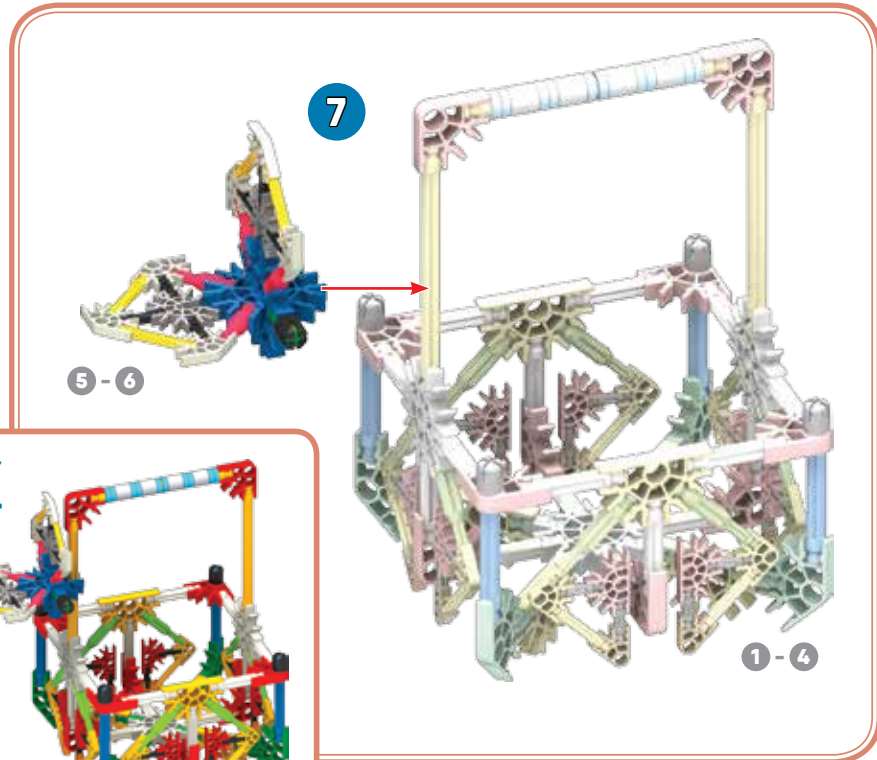
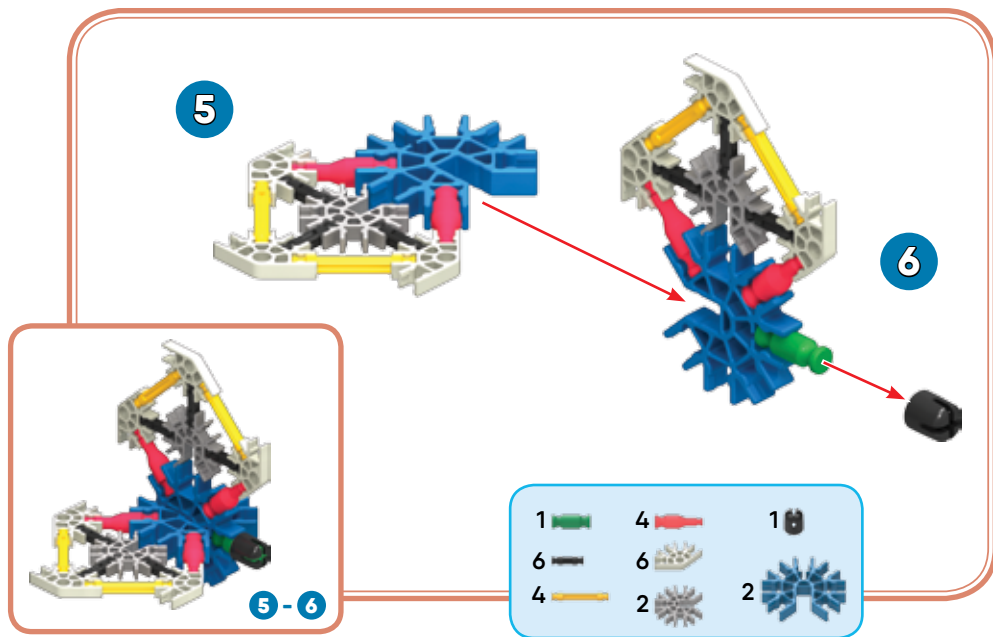
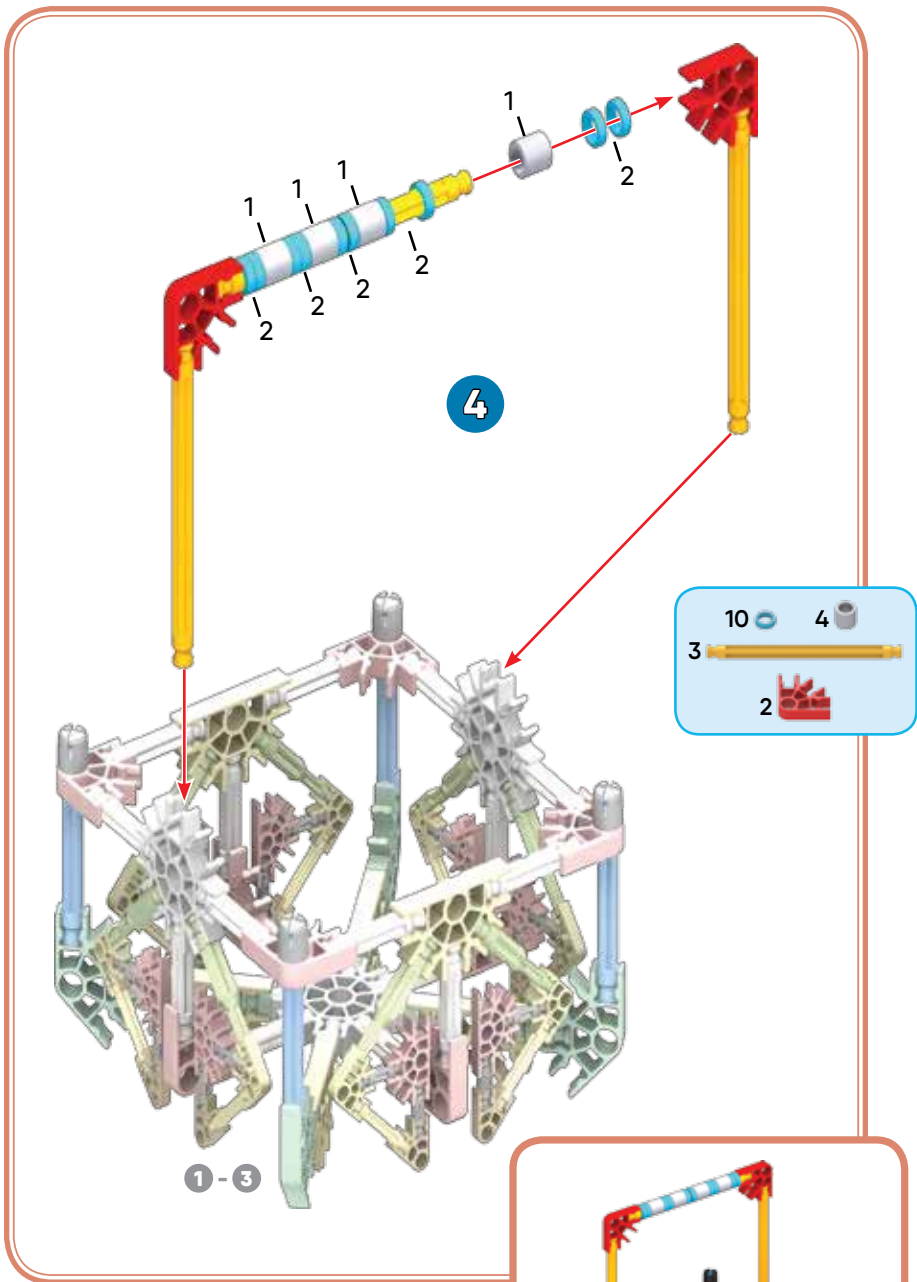

CRANE



x2

1

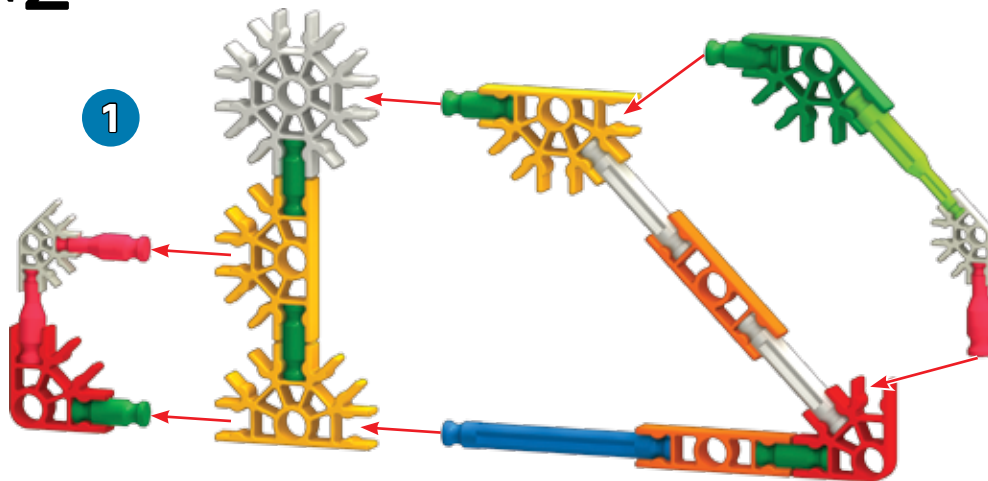

12		4	
2		4	
4		4	
4		2	
2		6	
6		2	

x2

1

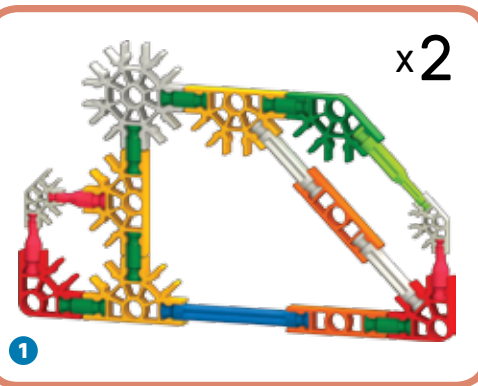



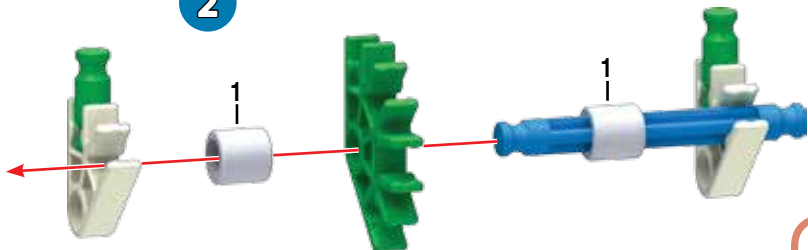

2



2		2	
1		1	
2		1	

2



4		4	
4			
4		2	

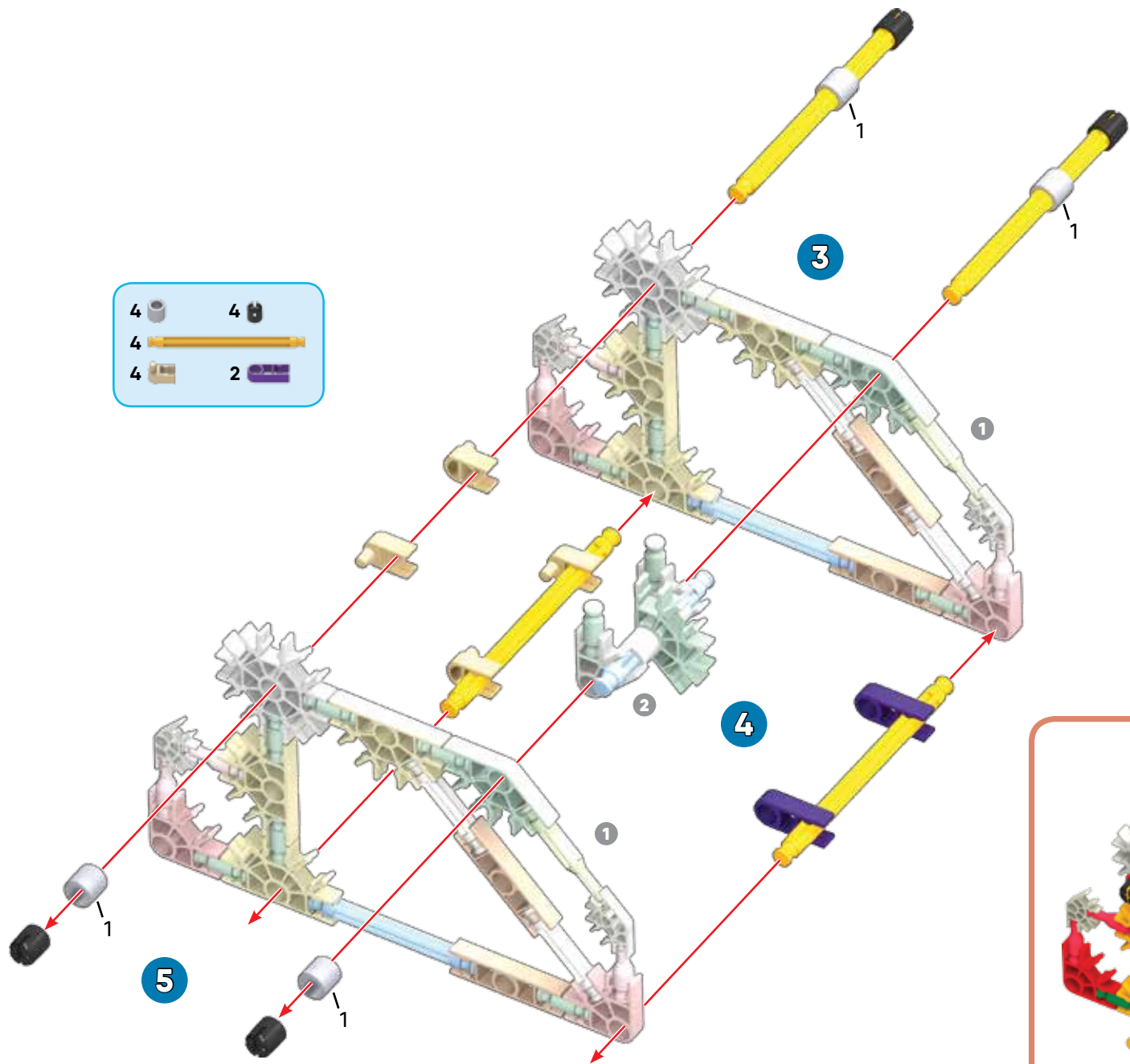

1-5

- | | | | |
|---|---|---|---|
| 1 | 1 | 1 | 1 |
| 1 | 4 | 1 | 1 |
| 1 | 1 | 1 | 2 |

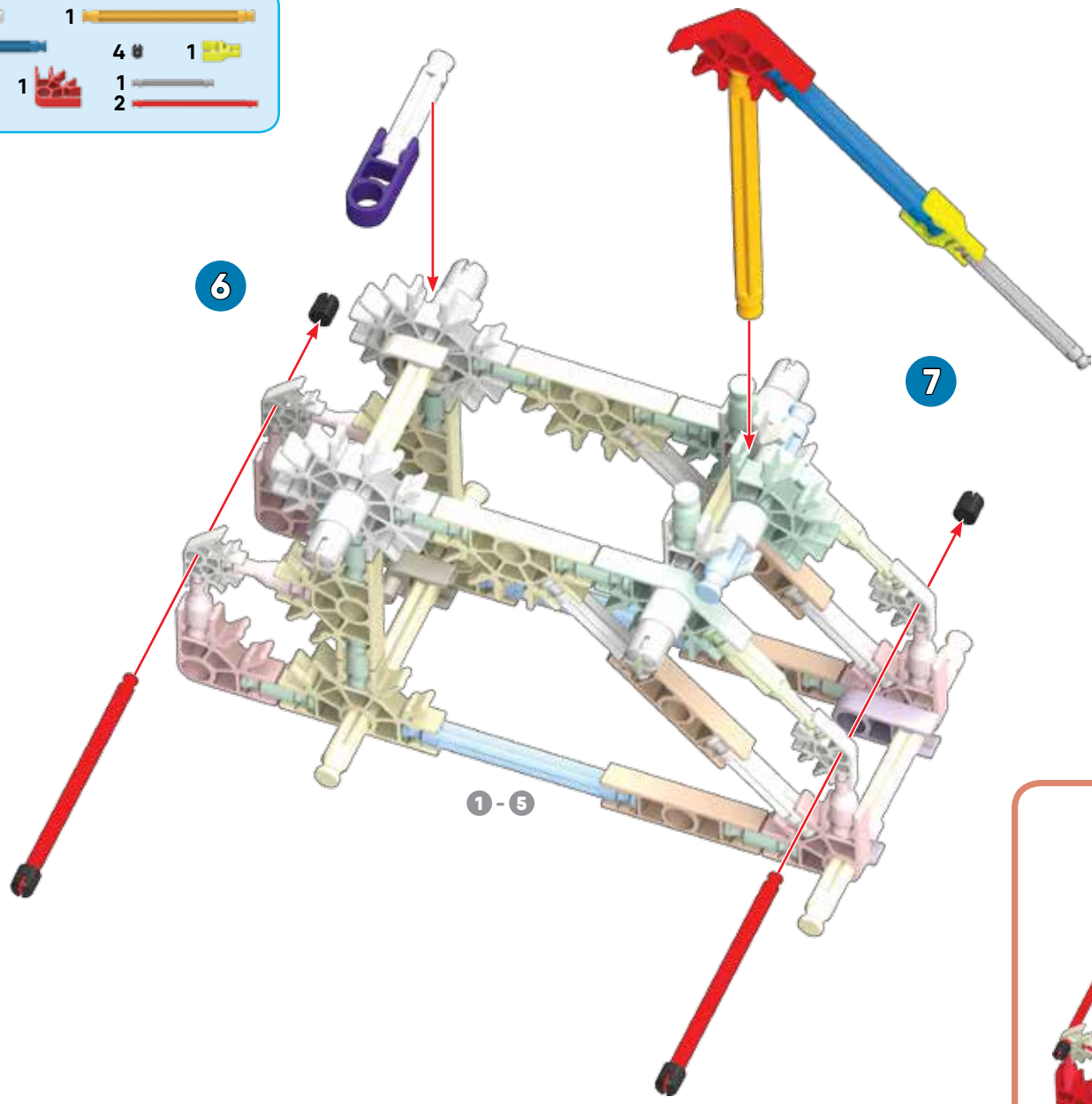

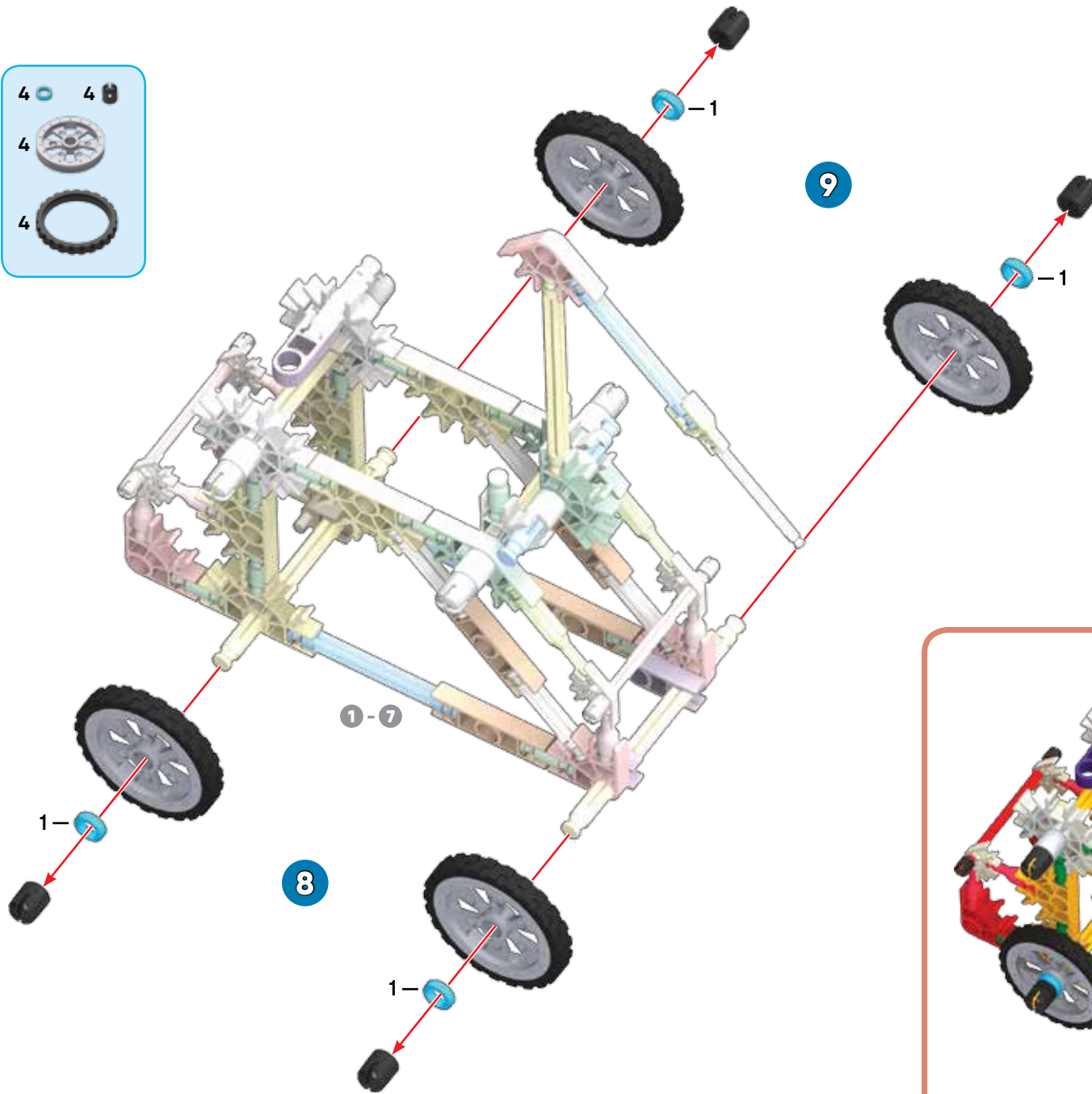

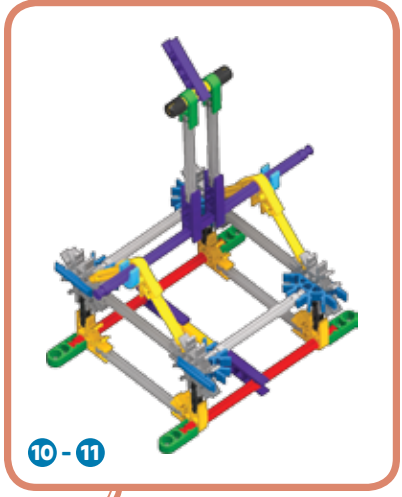
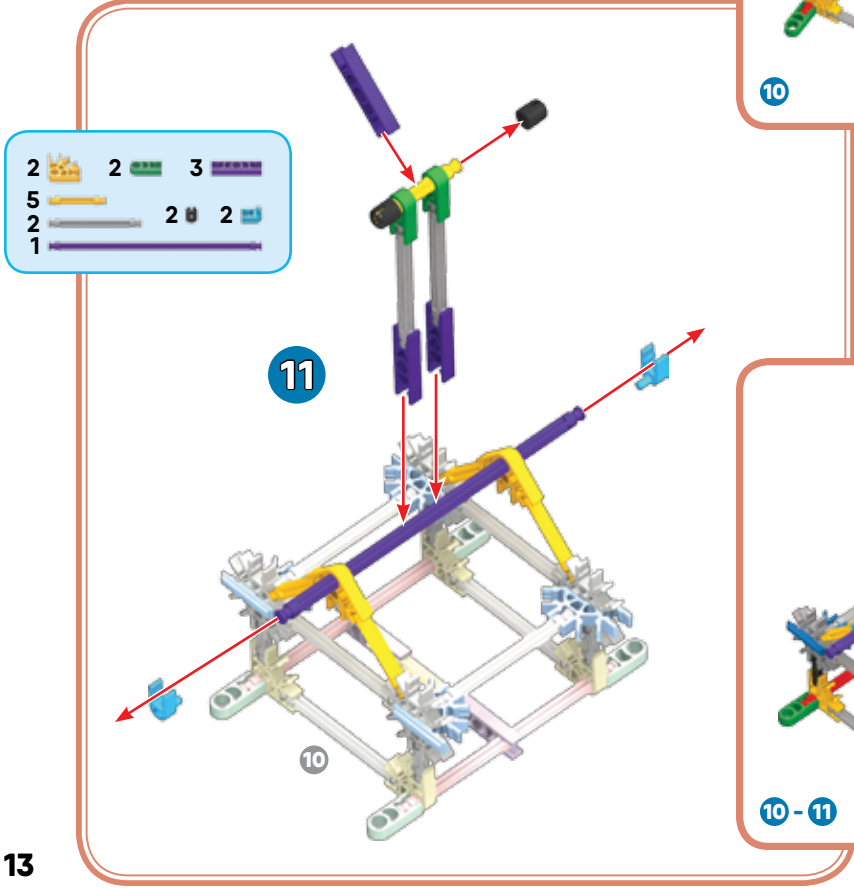
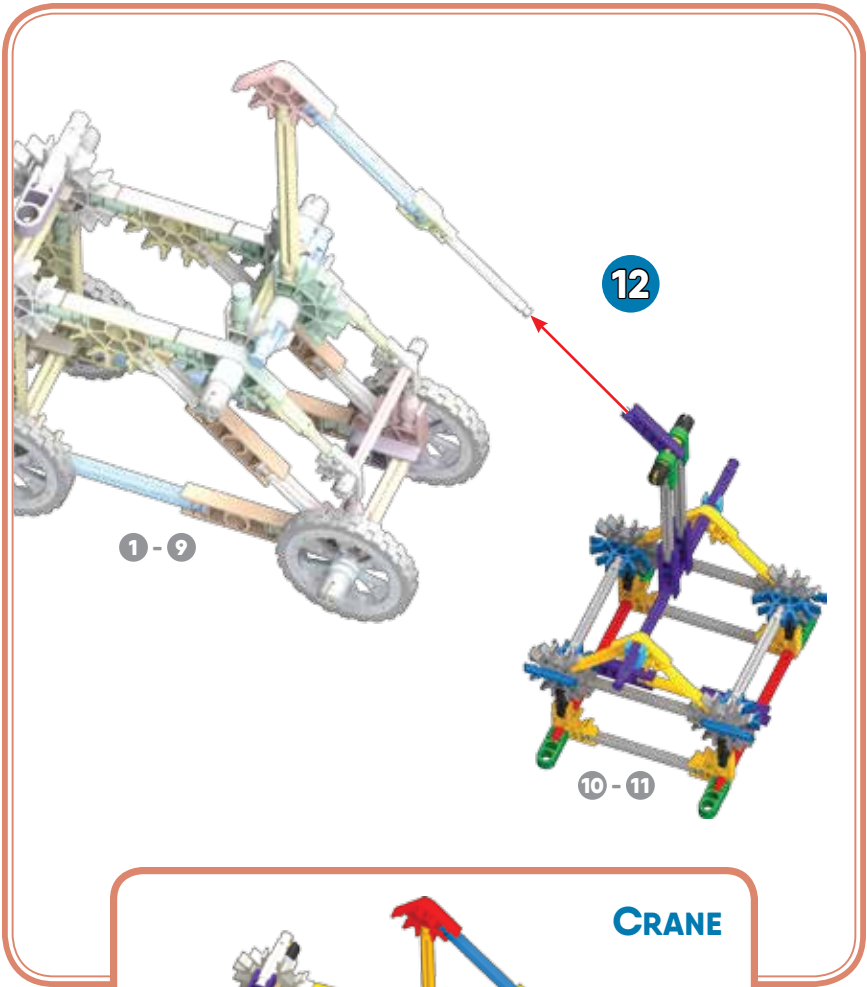
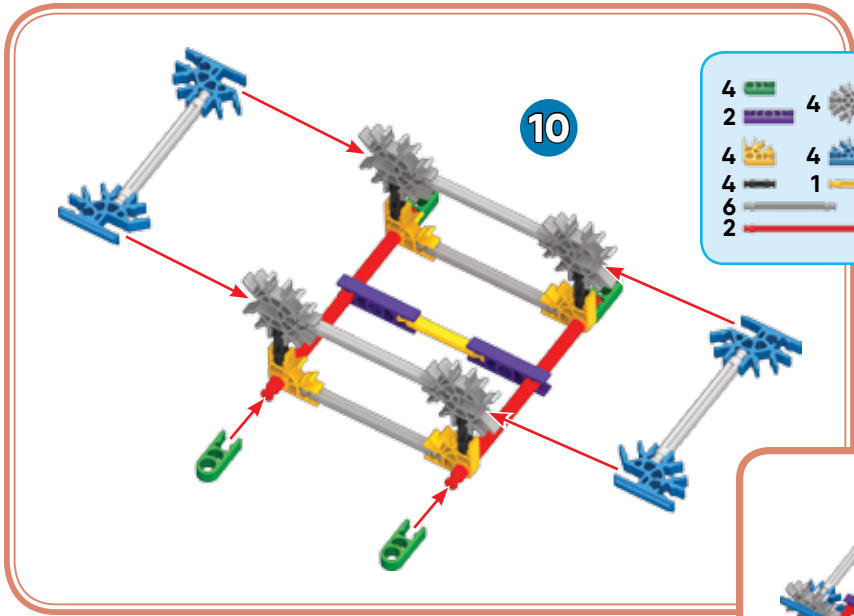



DRAGONFLY

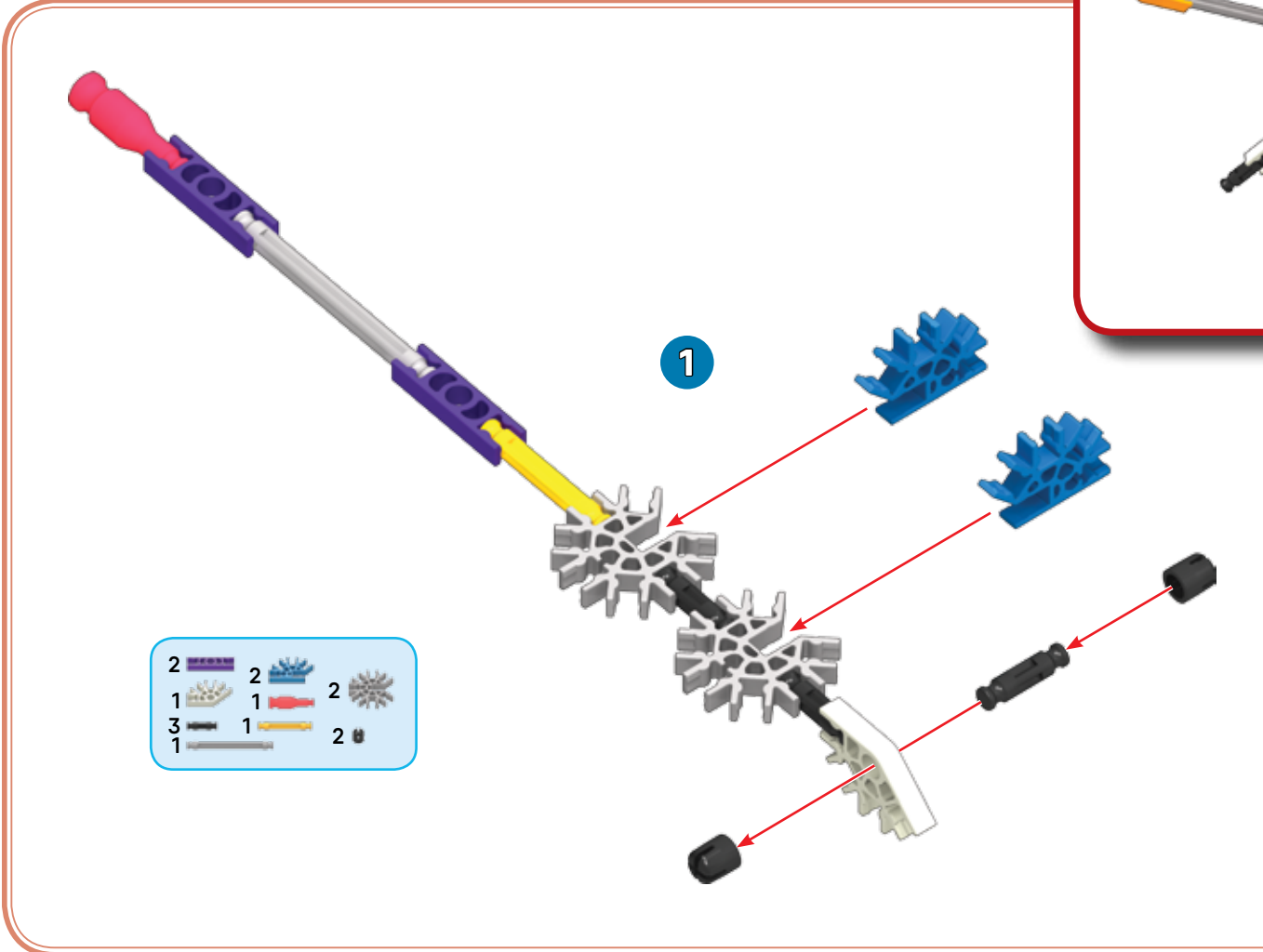

- | | | | | | |
|---|--|---|--|---|--|
| 2 | | 2 | | 2 | |
| 1 | | 1 | | 2 | |
| 3 | | 1 | | 2 | |
| 1 | | | | | |



1

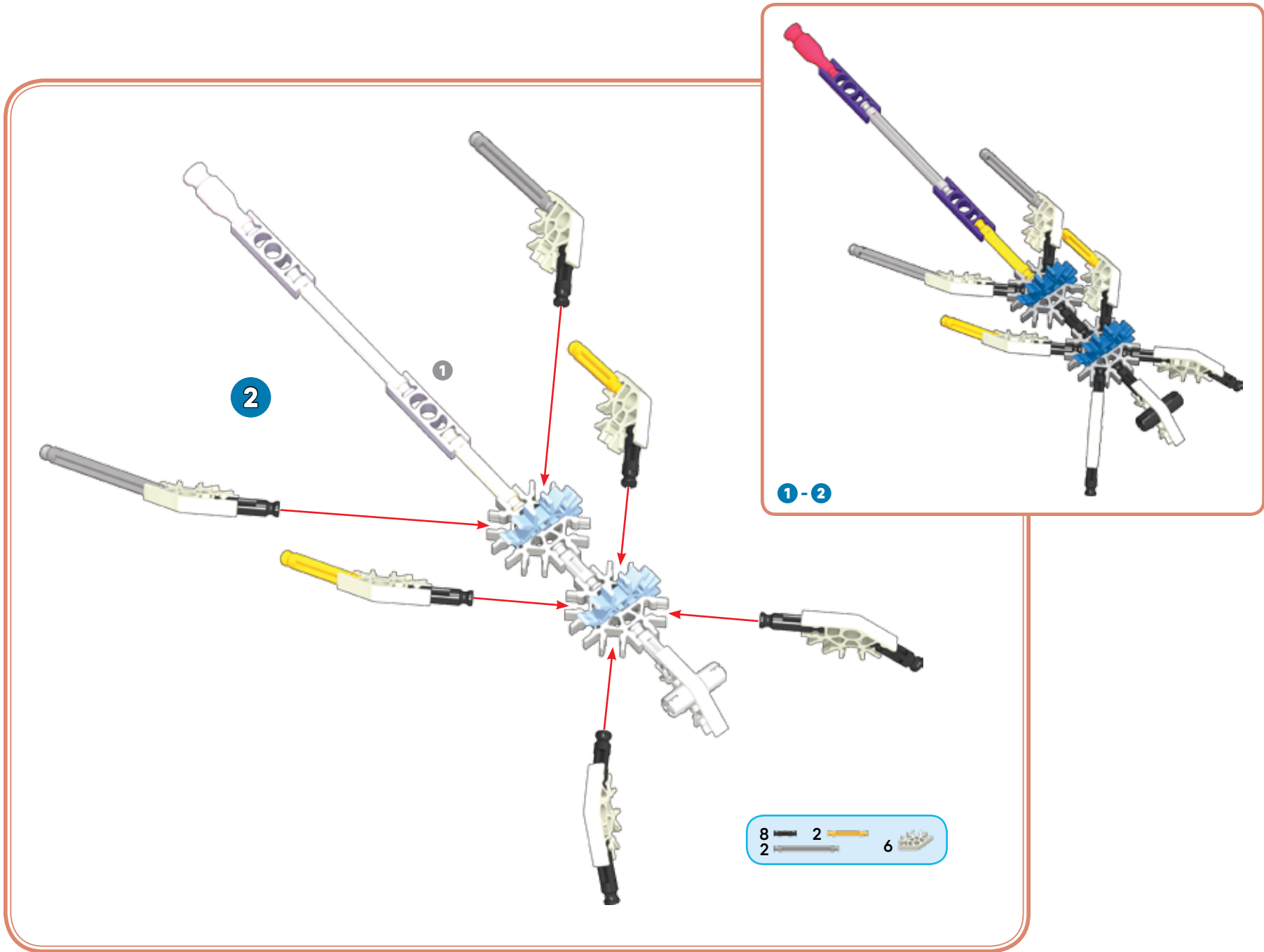

- 2
- 1
- 4
- 4
- 2
- 2

3

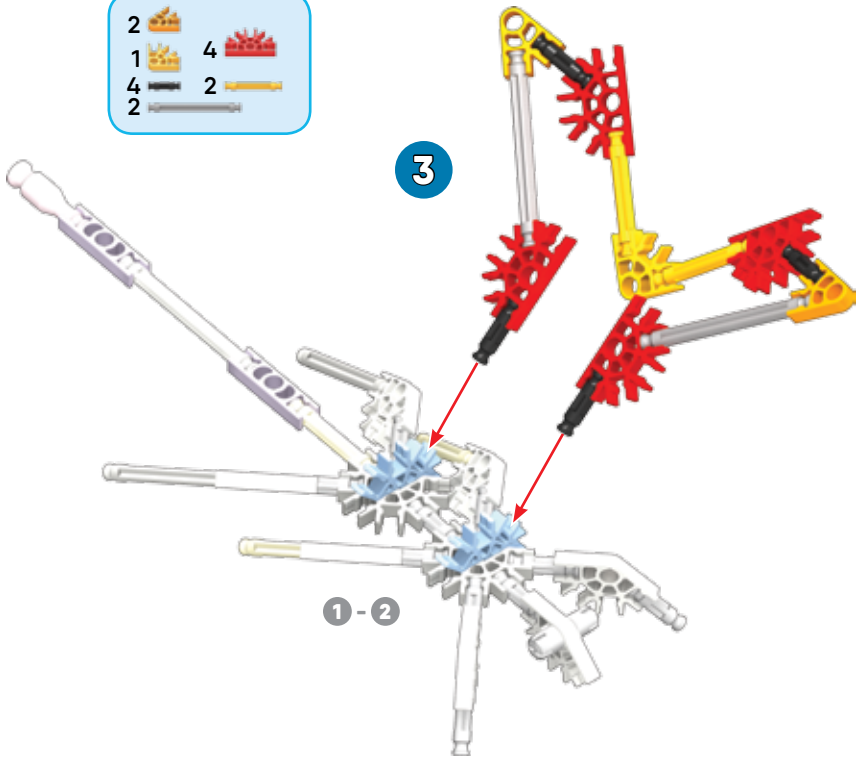

1-2

- 2
- 1
- 4
- 4
- 2
- 2

4

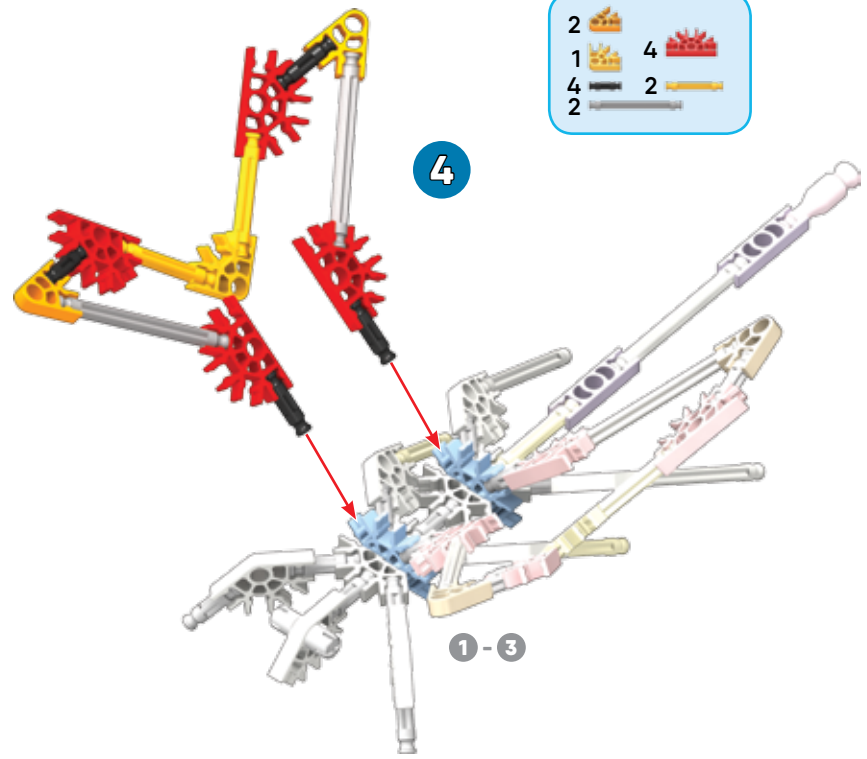

1-3



1-3



1-4

DRAGONFLY

FORKLIFT



- | | | | | |
|---|---|---|---|---|
| 4 | 4 | 4 | 4 | 2 |
| 2 | | | 4 | |
| 2 | 2 | | | |
| 4 | 2 | 4 | | |

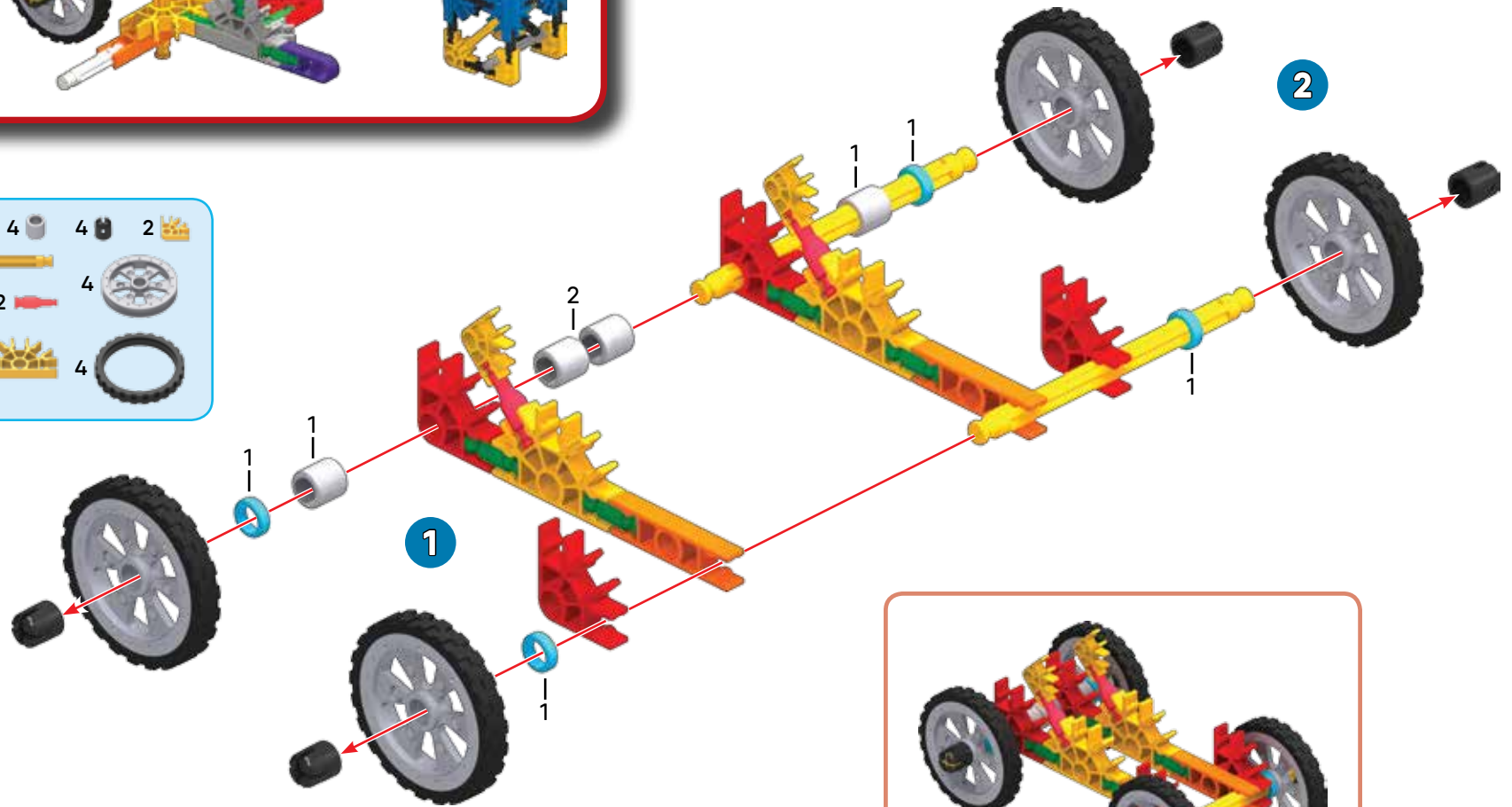

1-2

- | | | | |
|---|---|---|---|
| 2 | 2 | 2 | 2 |
| 5 | 2 | 2 | 2 |
| 2 | 2 | 2 | 2 |
| 2 | 2 | 2 | 2 |

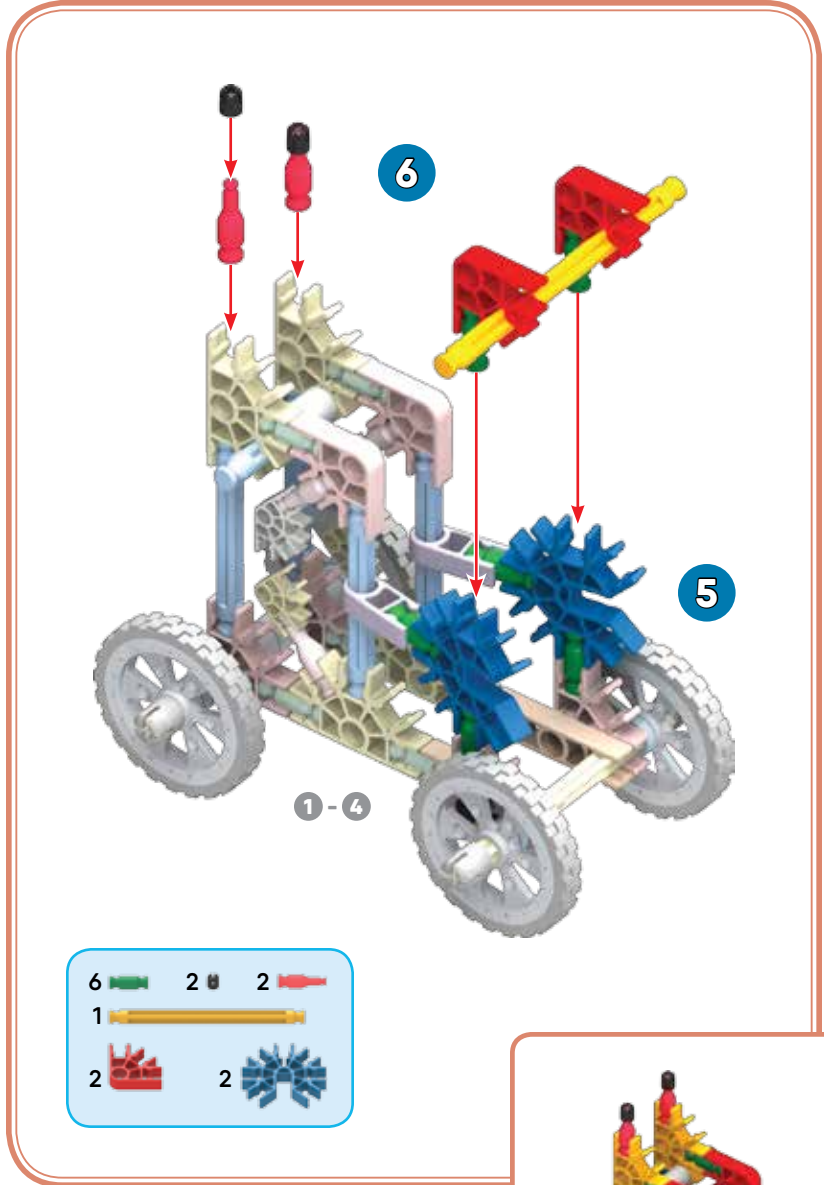
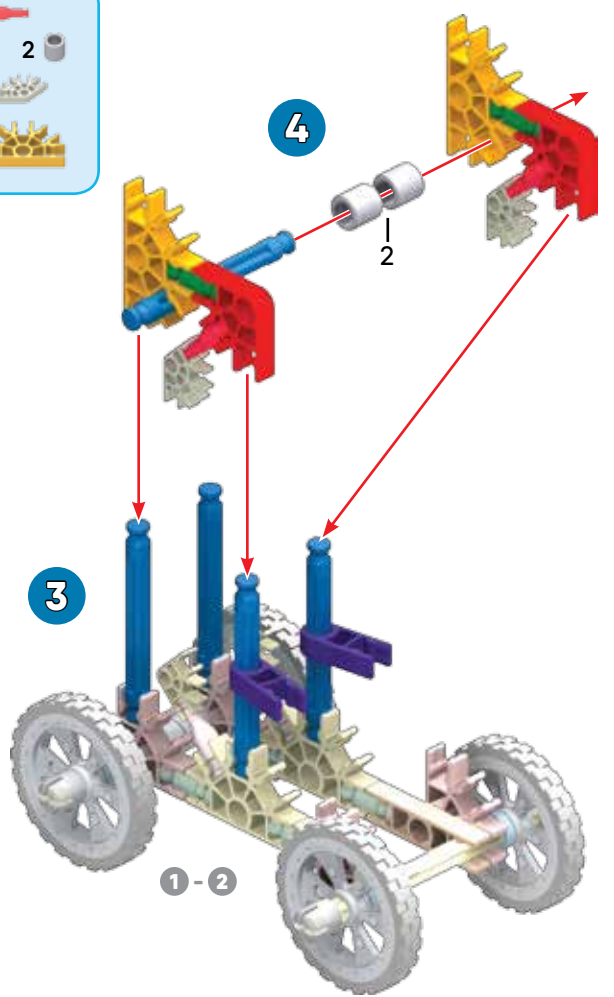

- | | | | |
|---|---|---|---|
| 6 | 2 | 2 | 2 |
| 1 | 2 | 2 | 2 |
| 2 | 2 | 2 | 2 |
| 2 | 2 | 2 | 2 |



7

9	3
2	1
2	6
2	2
1	

7

9

4	8
12	2
1	

1 - 8

9

8

1 - 6

7

1 - 9

FORKLIFT

HOT ROD



- 4
- 2
- 2
- 2 2

- 8
- 1
- 6
- 2
- 3
- 2
- 1

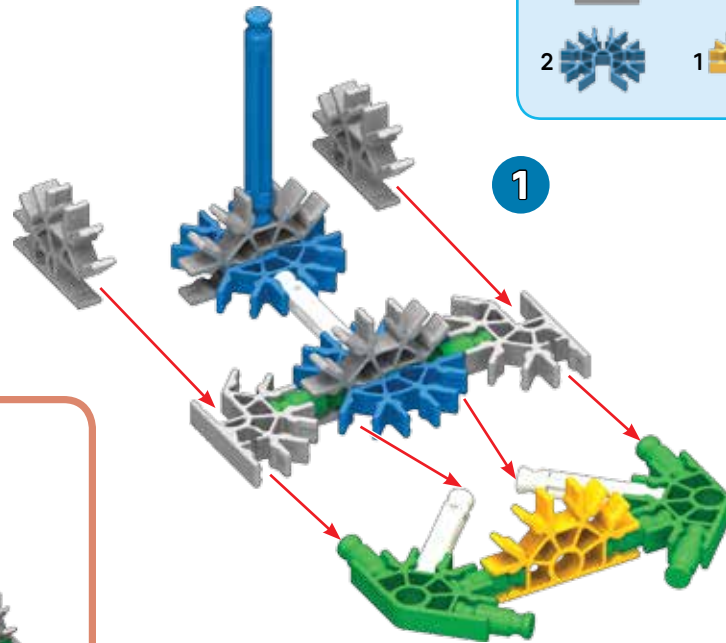

1



1

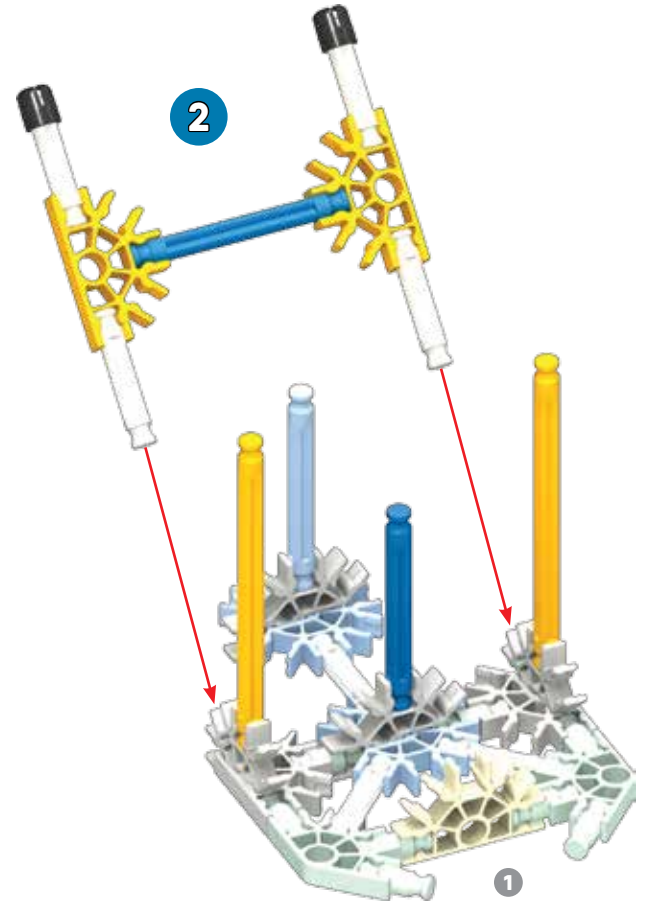

2

1



1-2

3

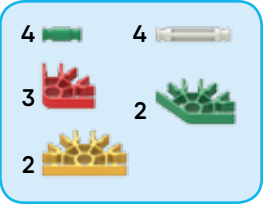
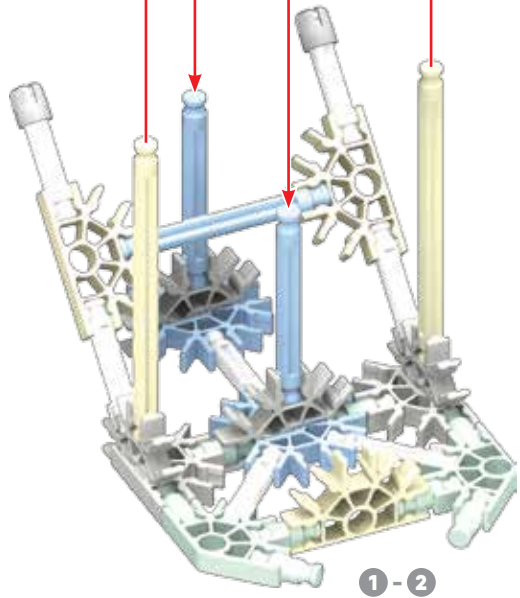
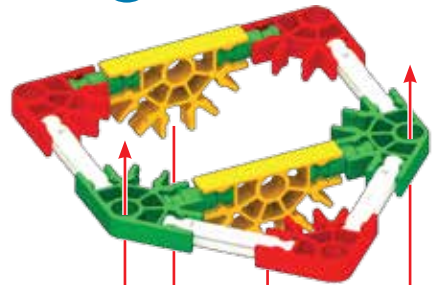

5

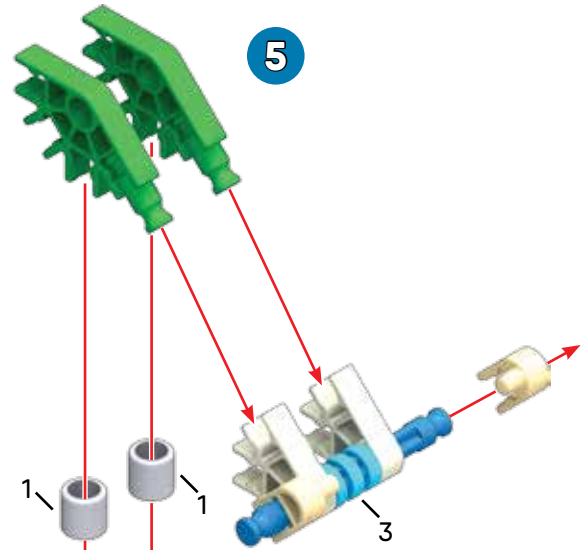

4

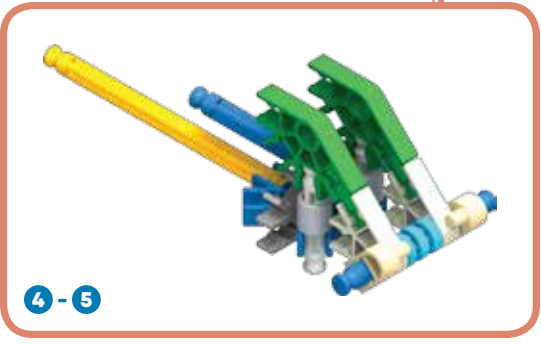

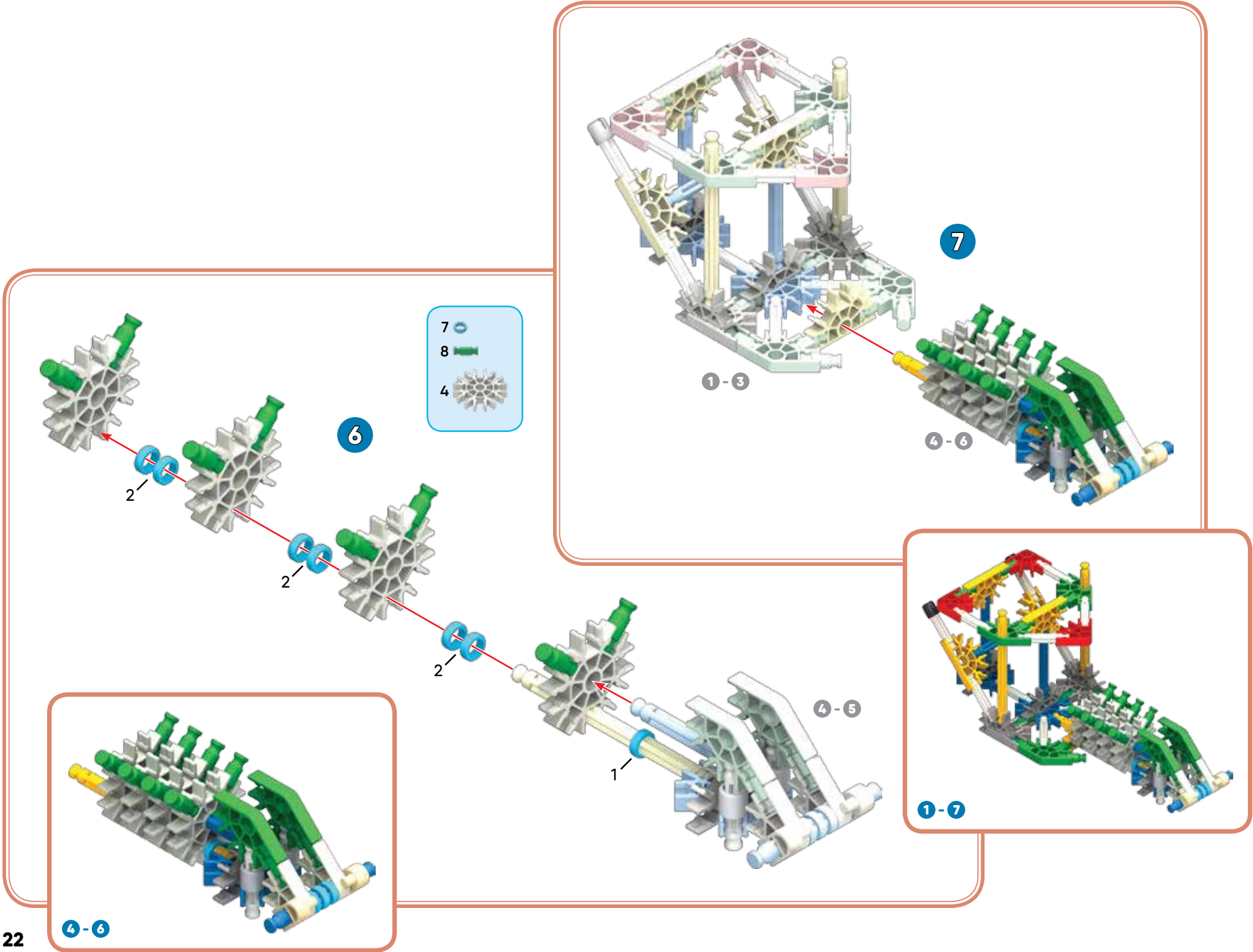

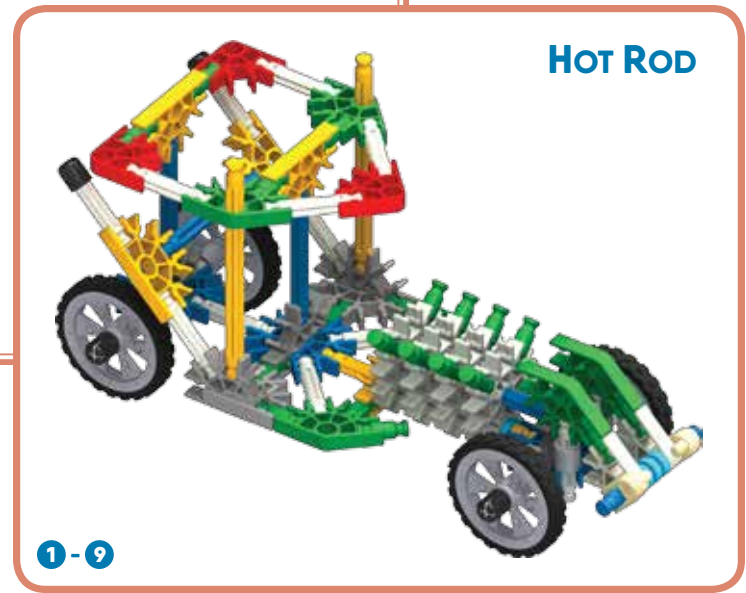
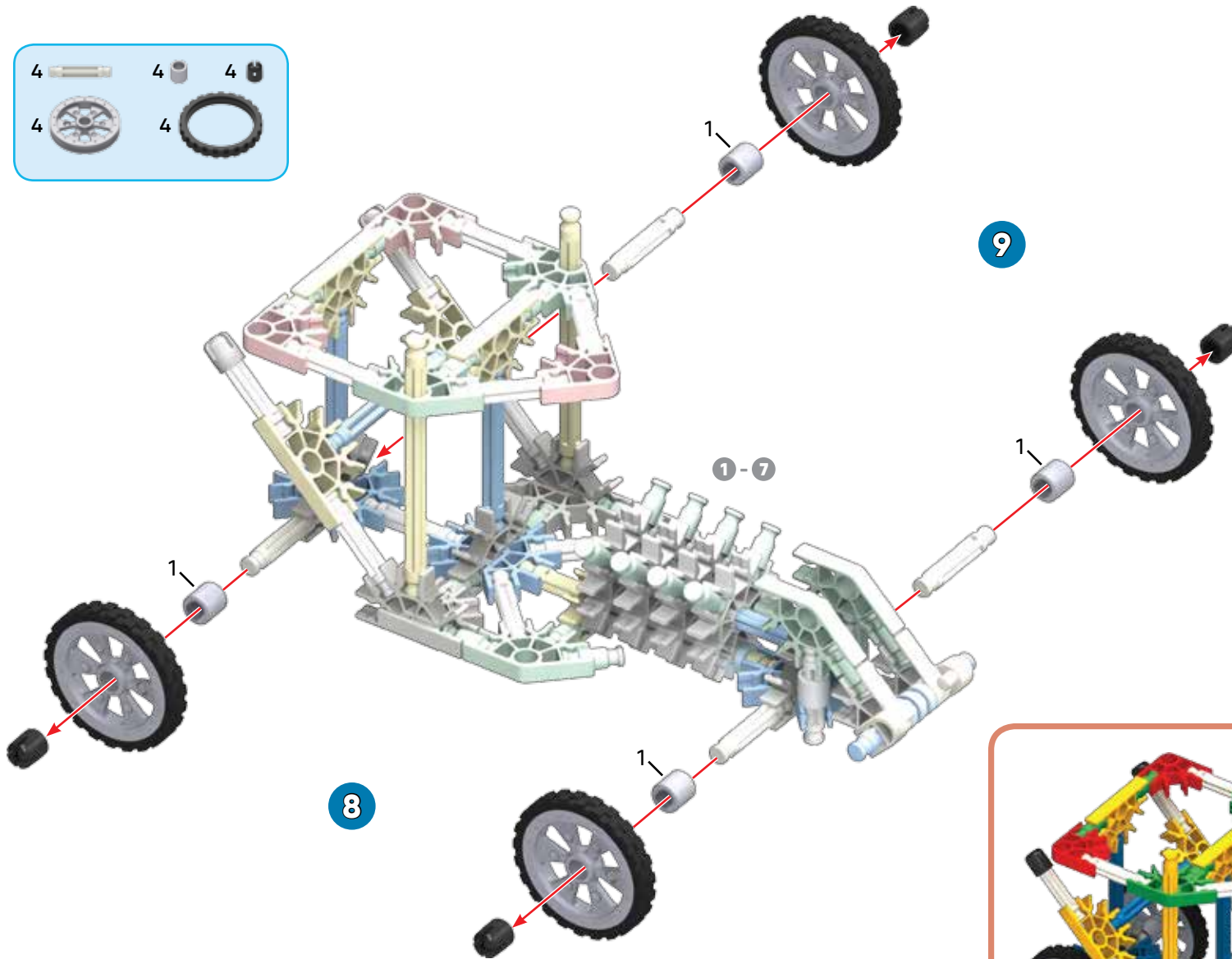
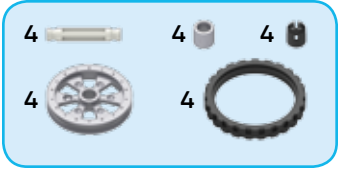

LONG TRUCK



- | | | | |
|---|--|---|--|
| 6 | | 1 | |
| 1 | | 1 | |
| 2 | | 1 | |
| 2 | | 2 | |

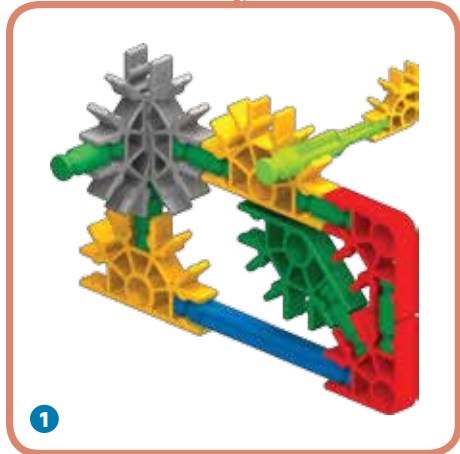
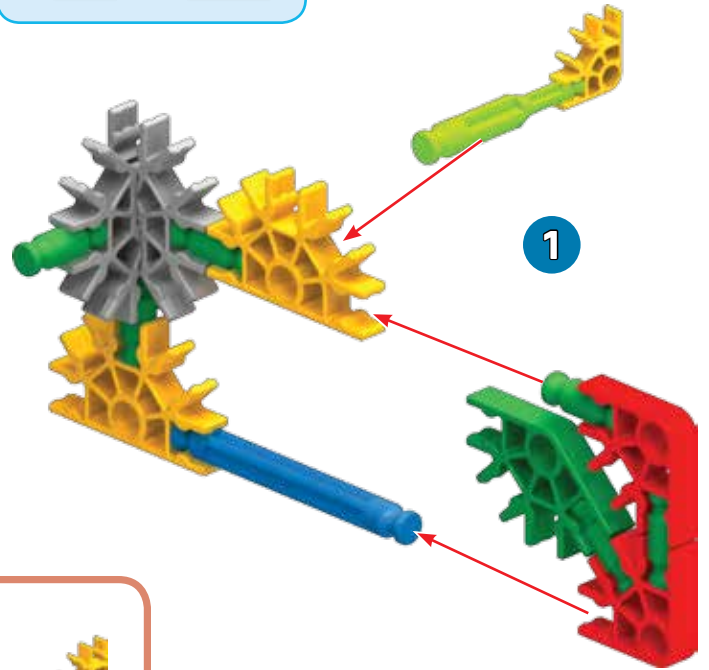

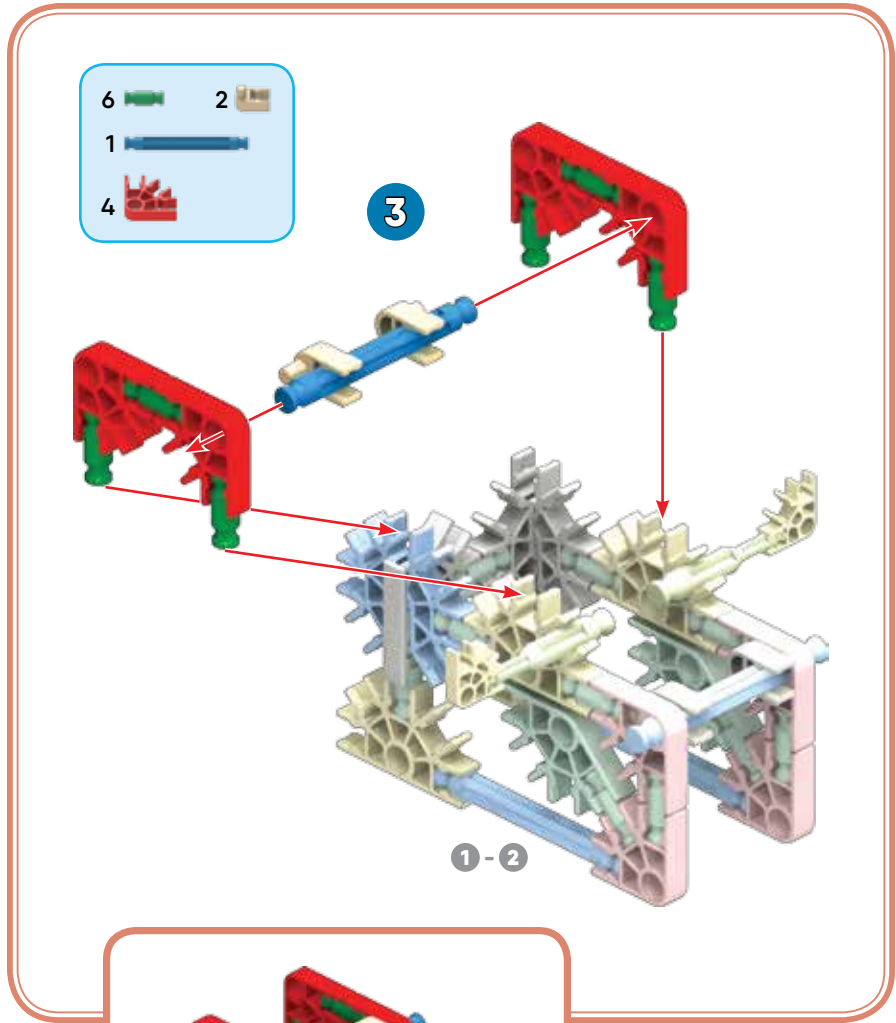
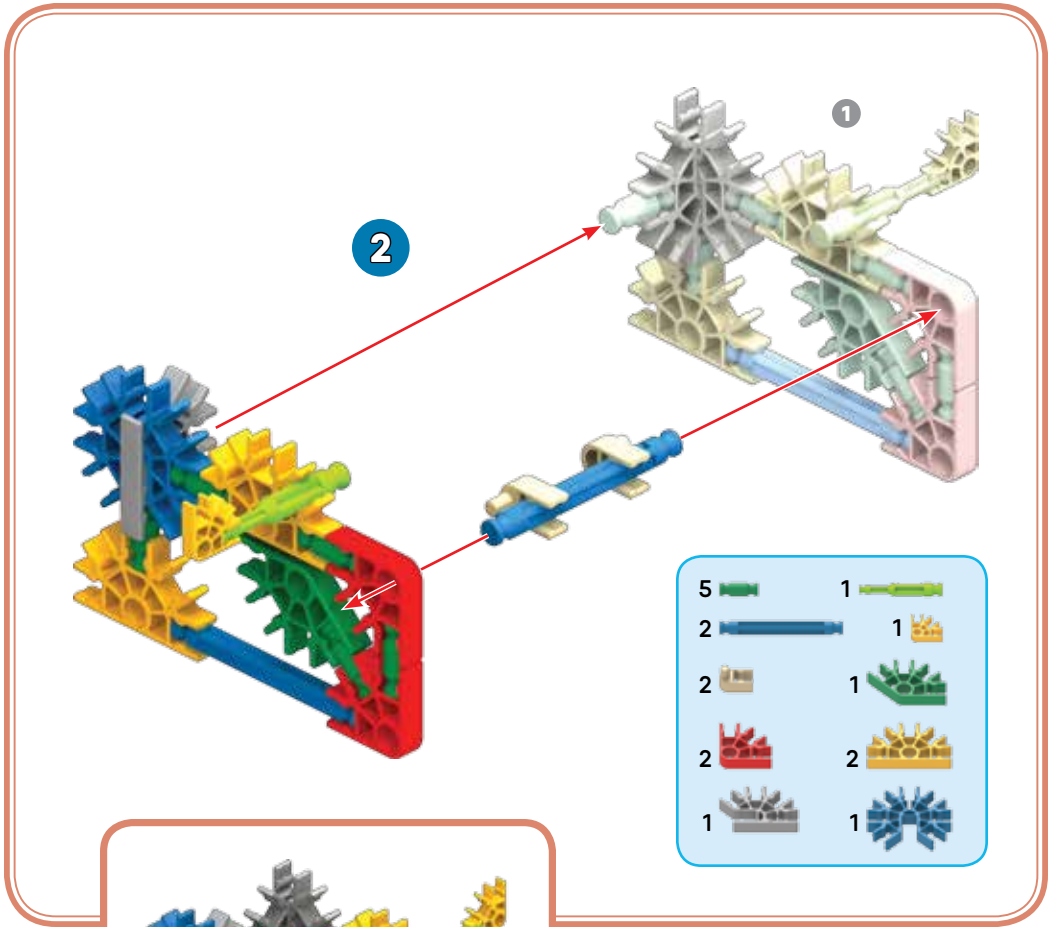

4

5	2	4	4
3			2
2	1	2	

1-3

1

3

1

1

1-5

6

1-5

9	3	2
1	2	1

1-6

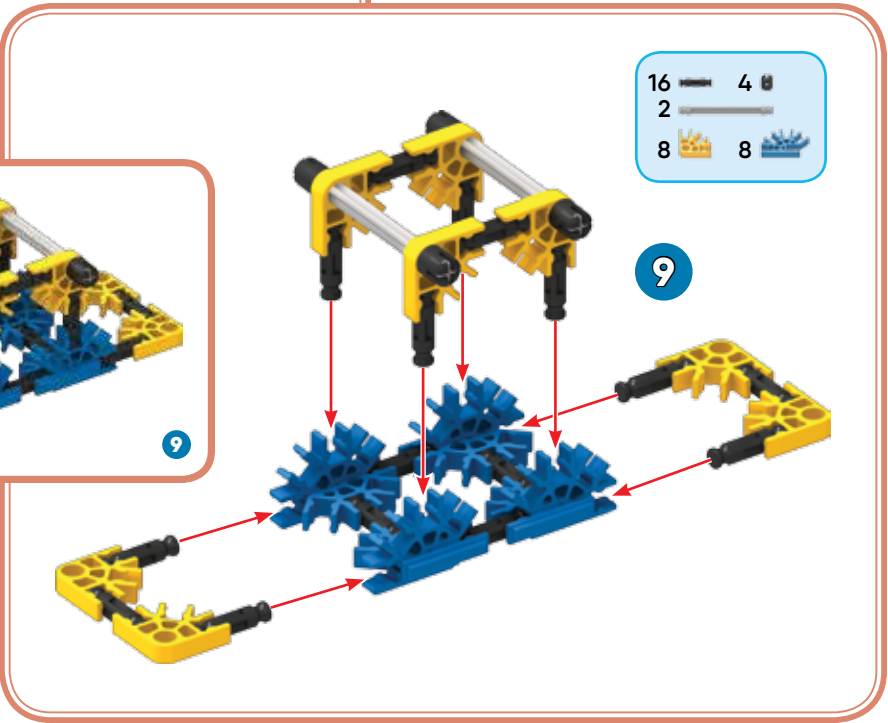
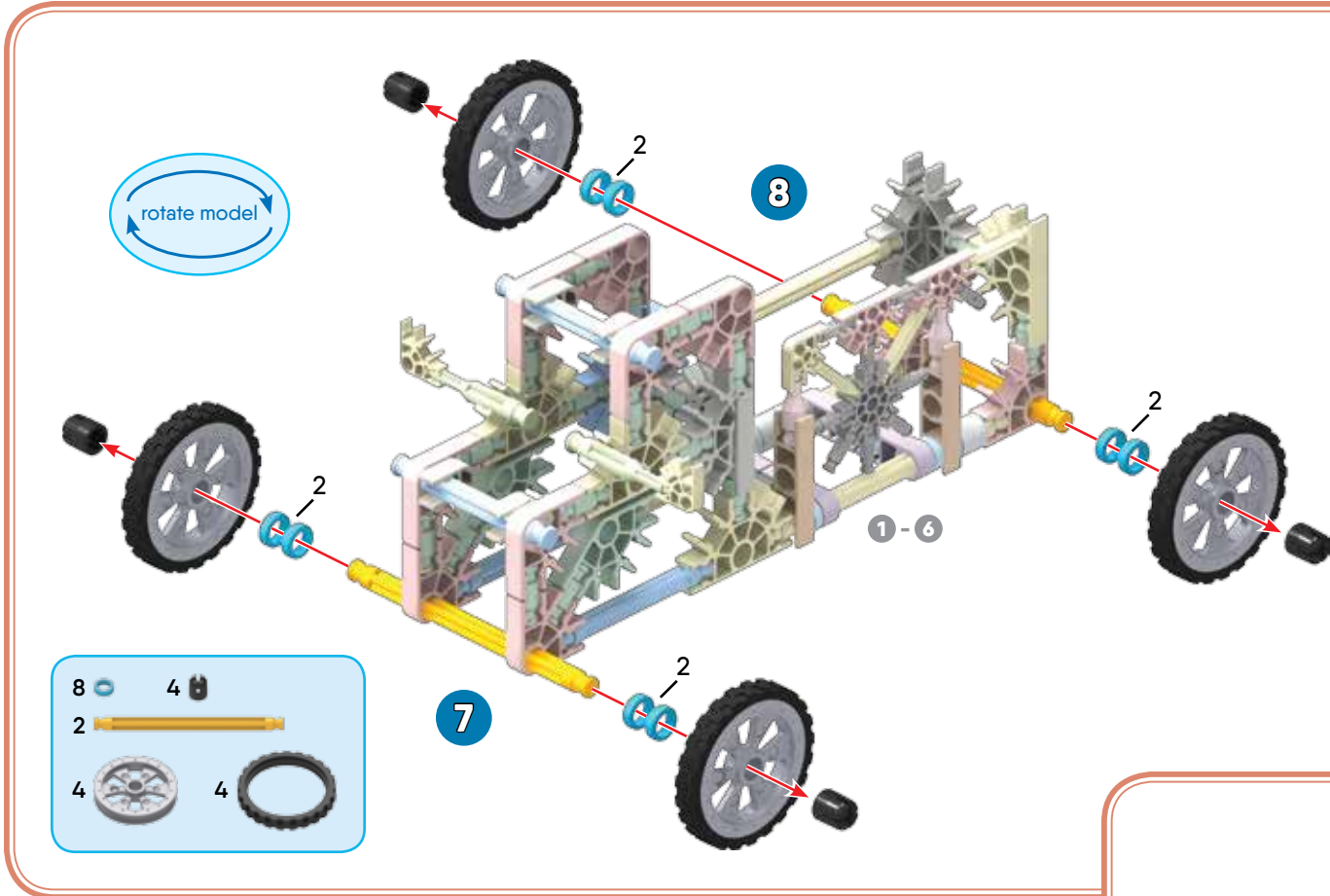

PARROT

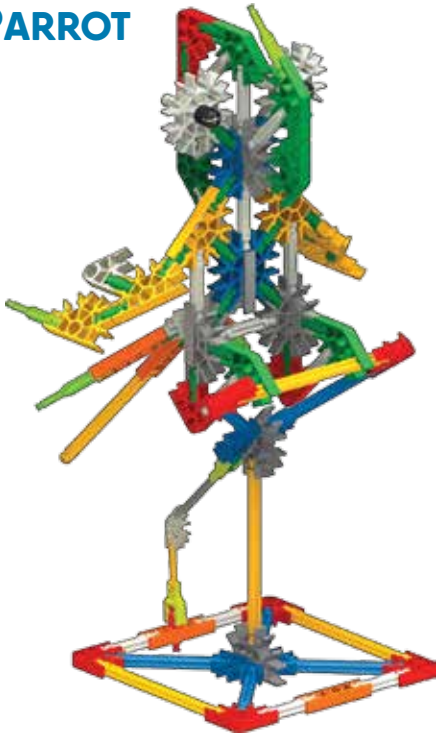

1-2

- | | | | |
|---|--|---|--|
| 4 | | 2 | |
| 4 | | 2 | |
| 4 | | 1 | |
| | | 1 | |

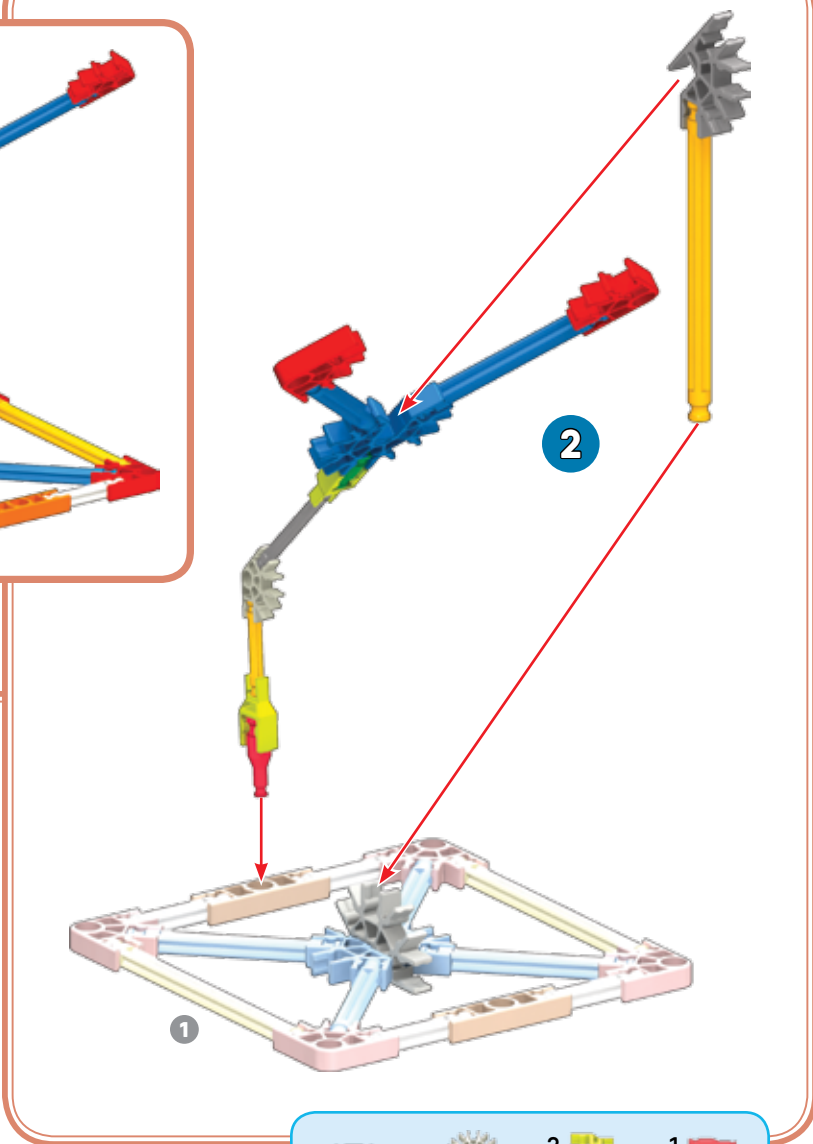

2

- | | | | | | | | |
|---|--|---|--|---|--|---|--|
| 1 | | 1 | | 2 | | 1 | |
| 2 | | 1 | | | | | |
| 2 | | 1 | | 1 | | | |
| 1 | | 1 | | | | | |

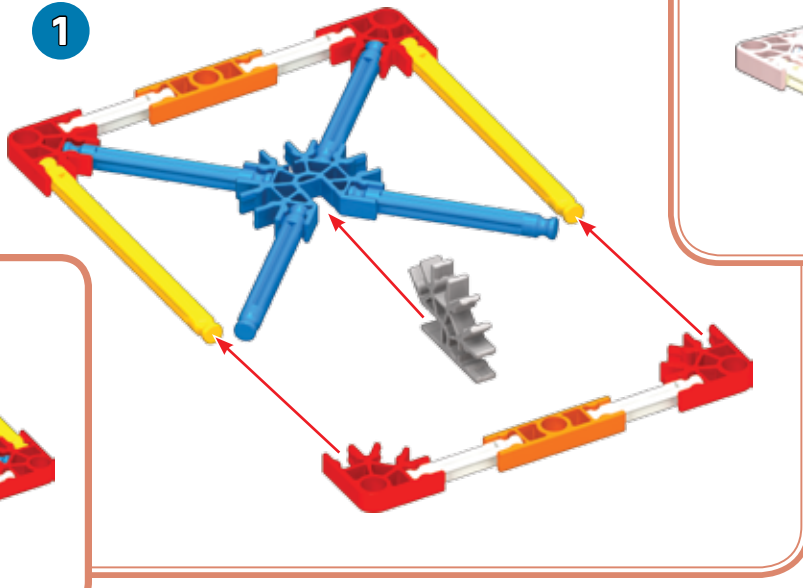

1

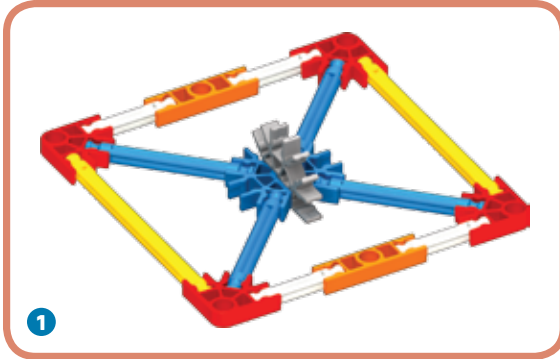

1

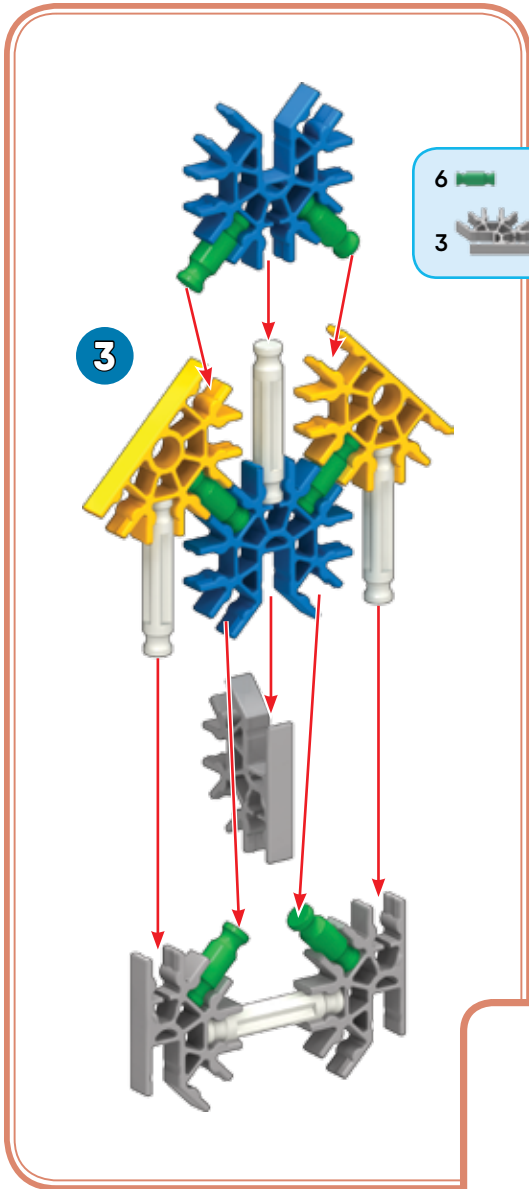

- | | |
|---|---|
| 6 | 4 |
| 3 | 2 |

3

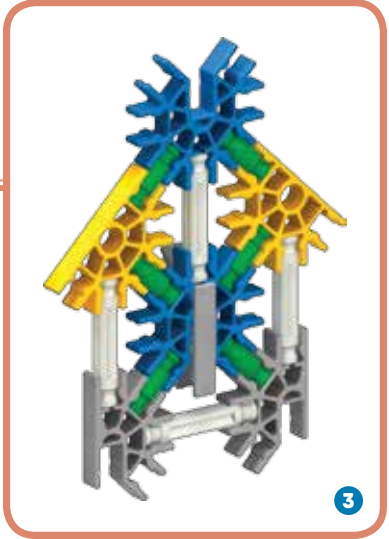

3

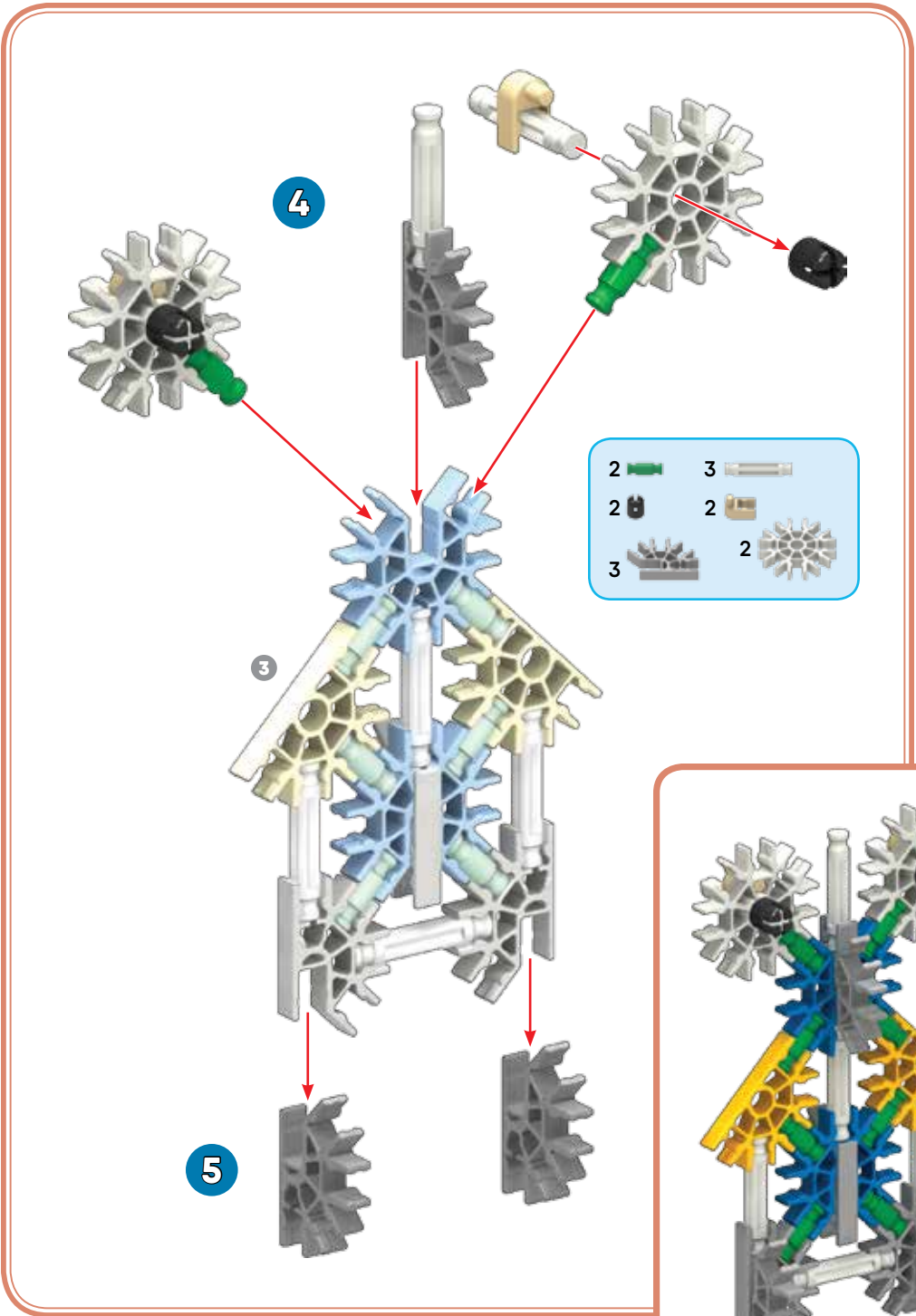

- | | |
|---|---|
| 2 | 3 |
| 2 | 2 |
| 3 | 2 |

4

5

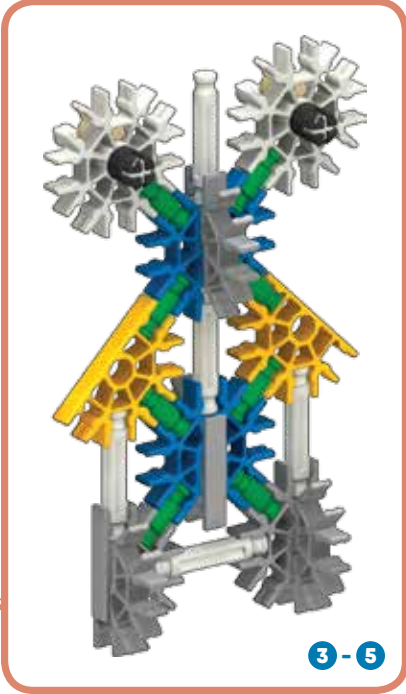

3 - 5

6

3-5

rotate model

6	3
1	1
3	2
2	1
2	

7

3-7

8

3-8

rotate model

7	2	1
1		1
2	2	2

8

3-7

- | | | | |
|---|--|---|--|
| 4 | | 1 | |
| 2 | | 2 | |
| 1 | | 2 | |

rotate model

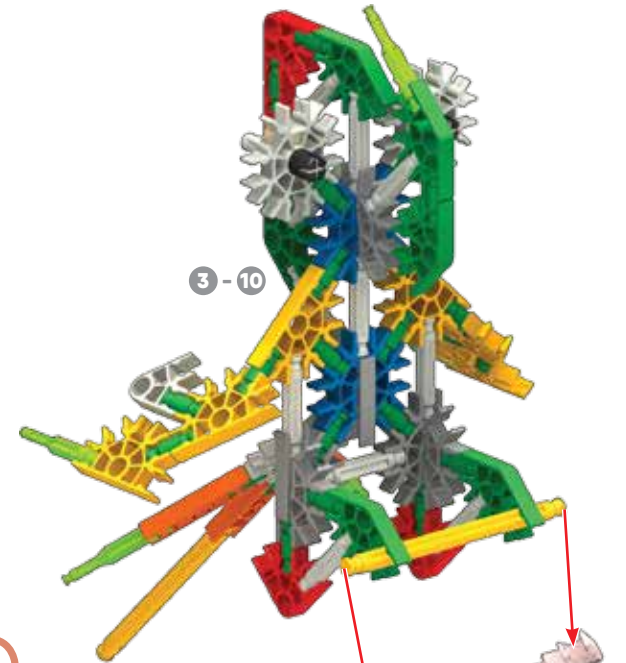
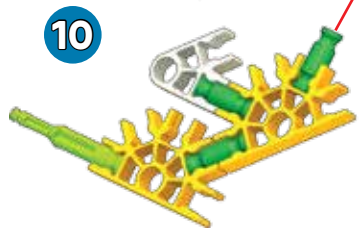
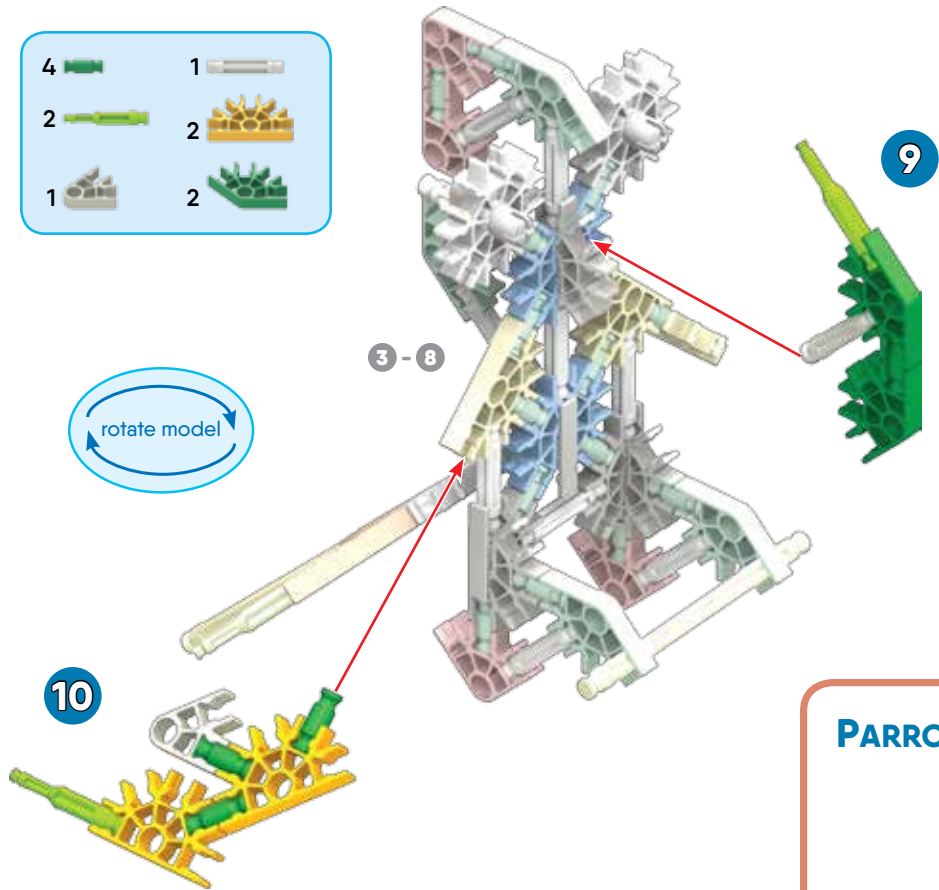

PARROT

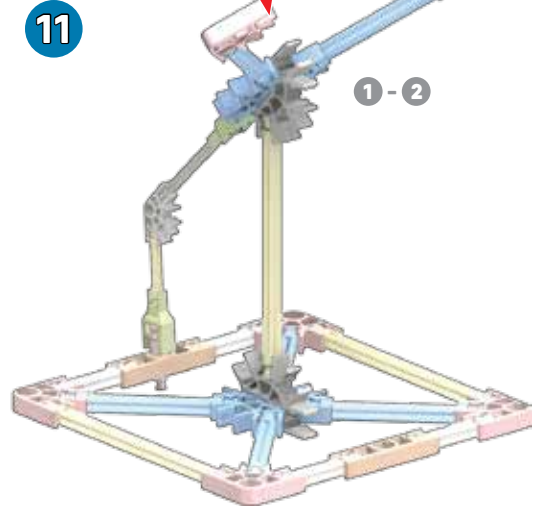

ROCKETSHIP

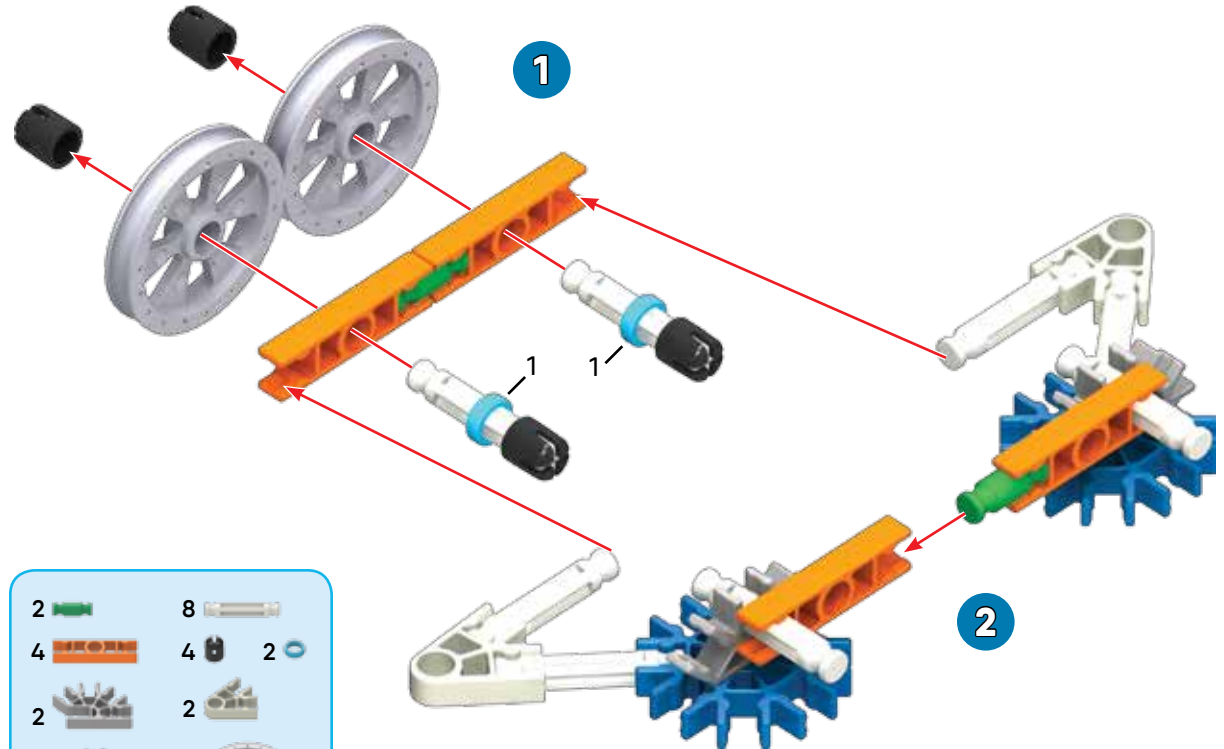

- | | | | |
|---|--|---|--|
| 2 | | 8 | |
| 4 | | 4 | |
| 2 | | 2 | |
| 2 | | 2 | |
| | | 2 | |

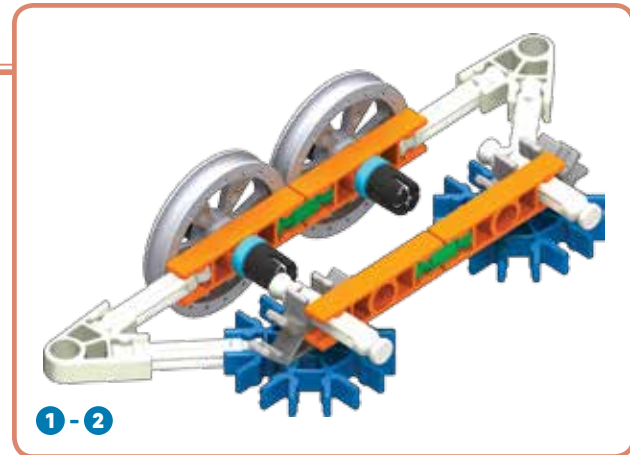

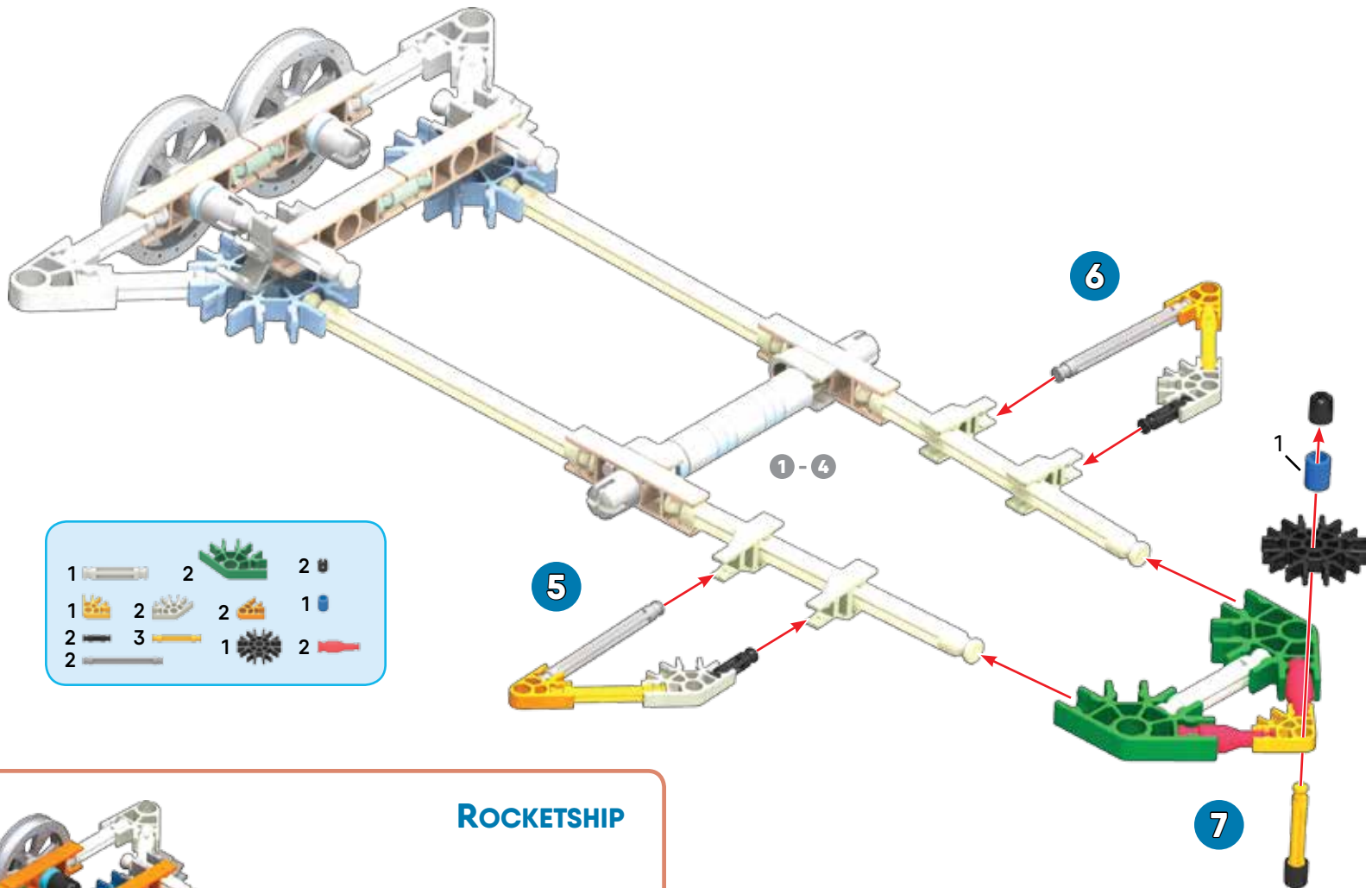

- | | | | |
|---|---|---|---|
| 1 | 2 | 2 | 2 |
| 1 | 2 | 2 | 1 |
| 2 | 3 | 1 | 2 |
| 2 | | | |

ROCKETSHIP

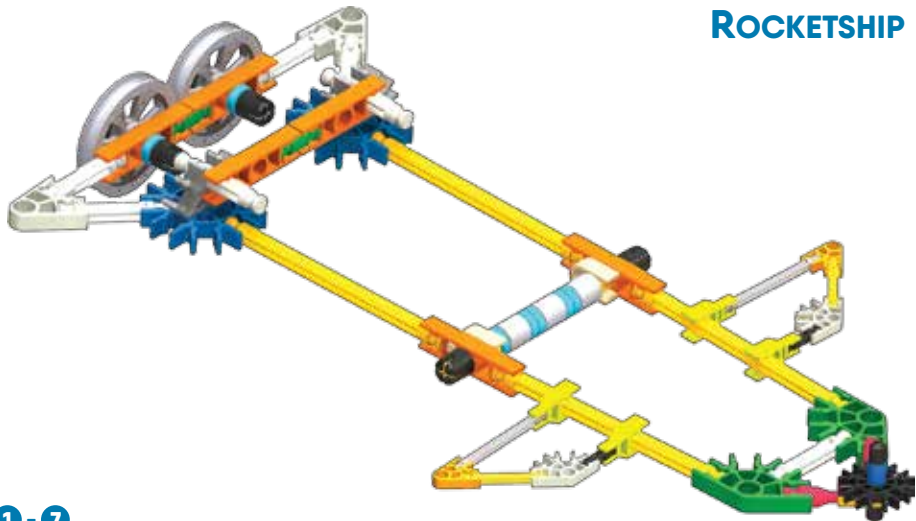

1-7

SPIN RIDE

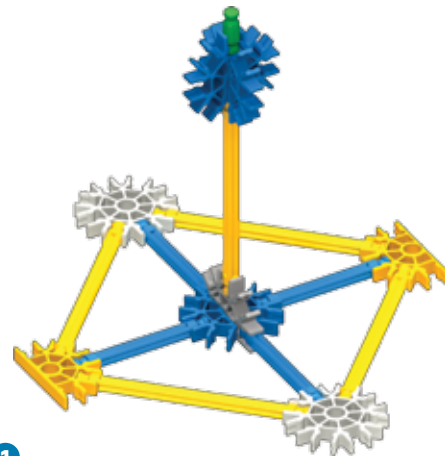
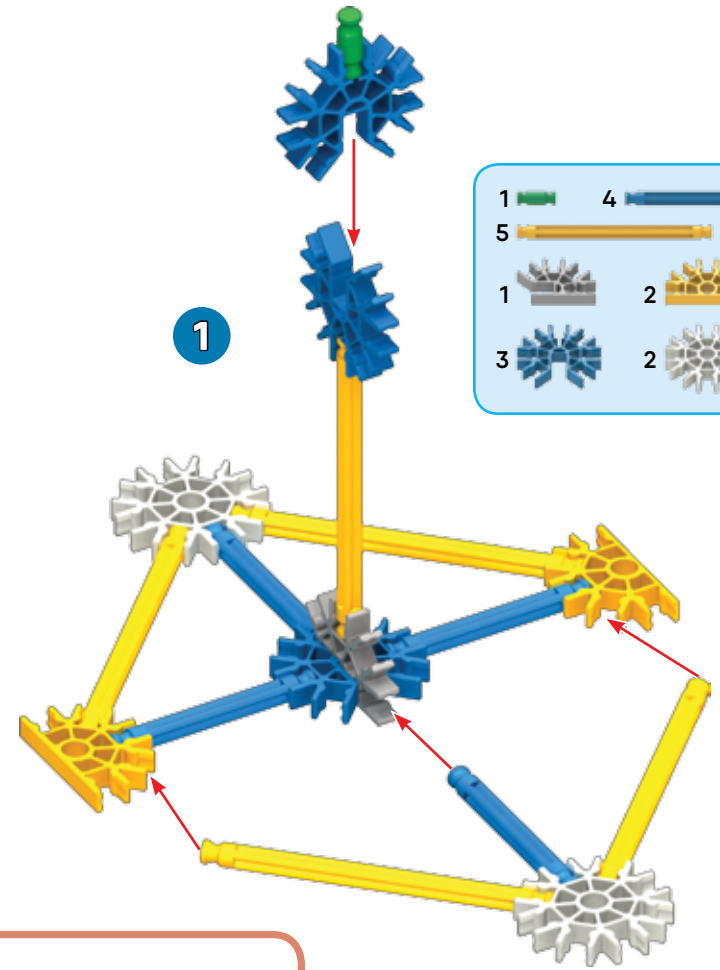
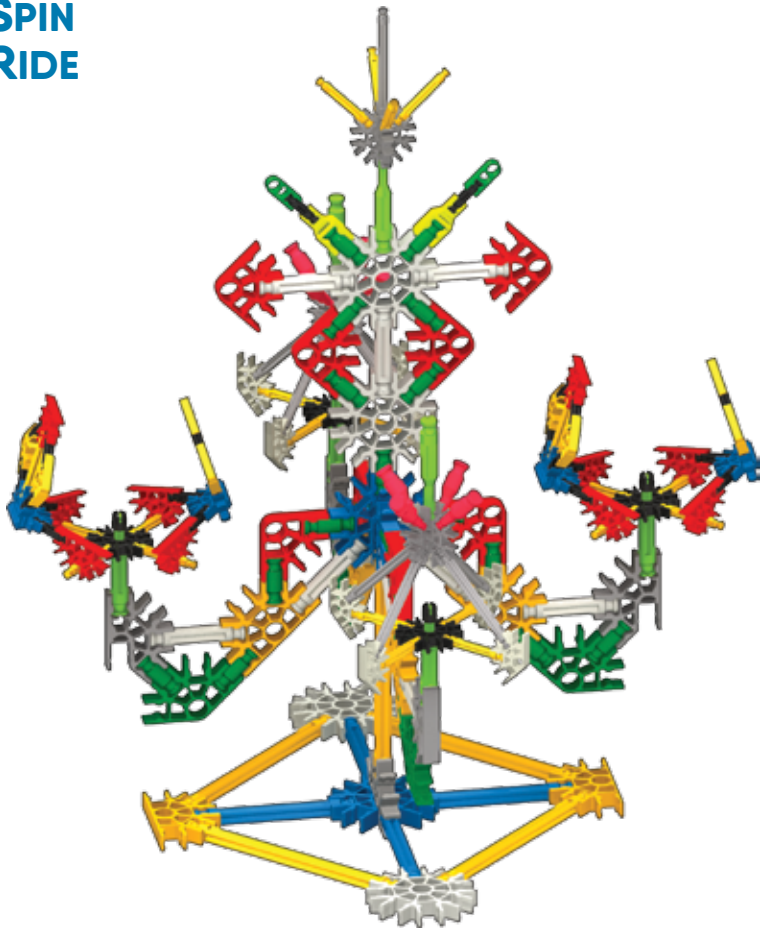

x4

4		8	
16		4	
4		4	
4		4	

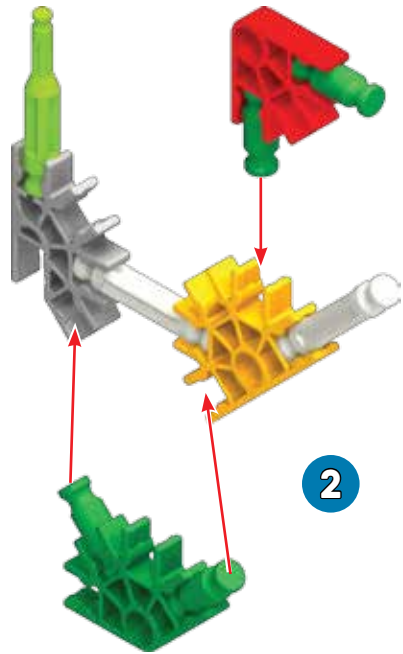

2

x4

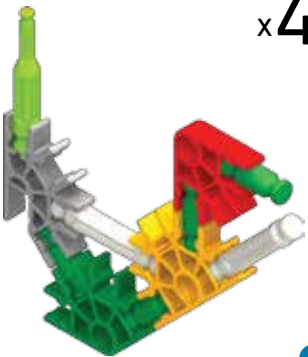

2

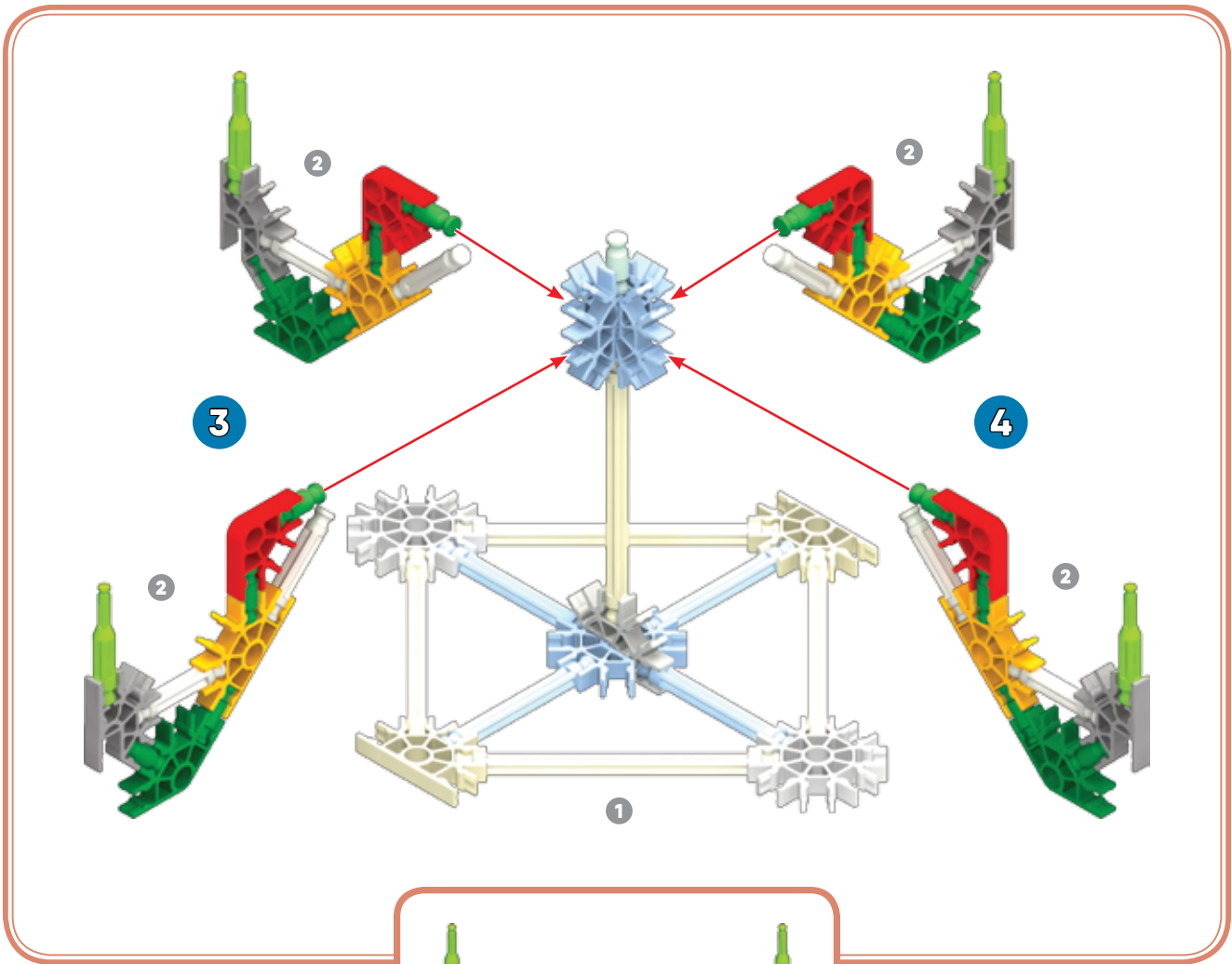

3

4

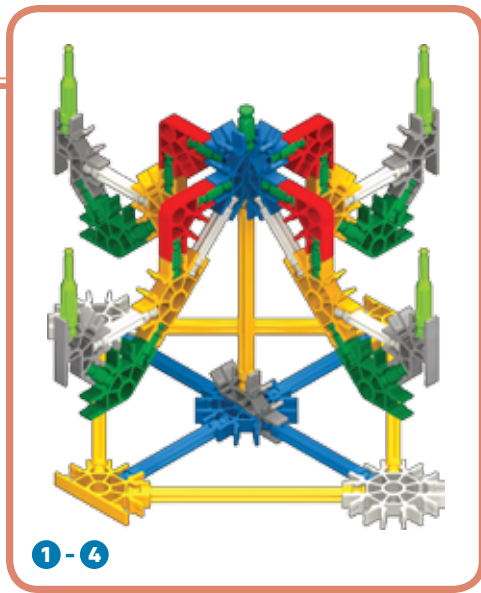

1-4

5

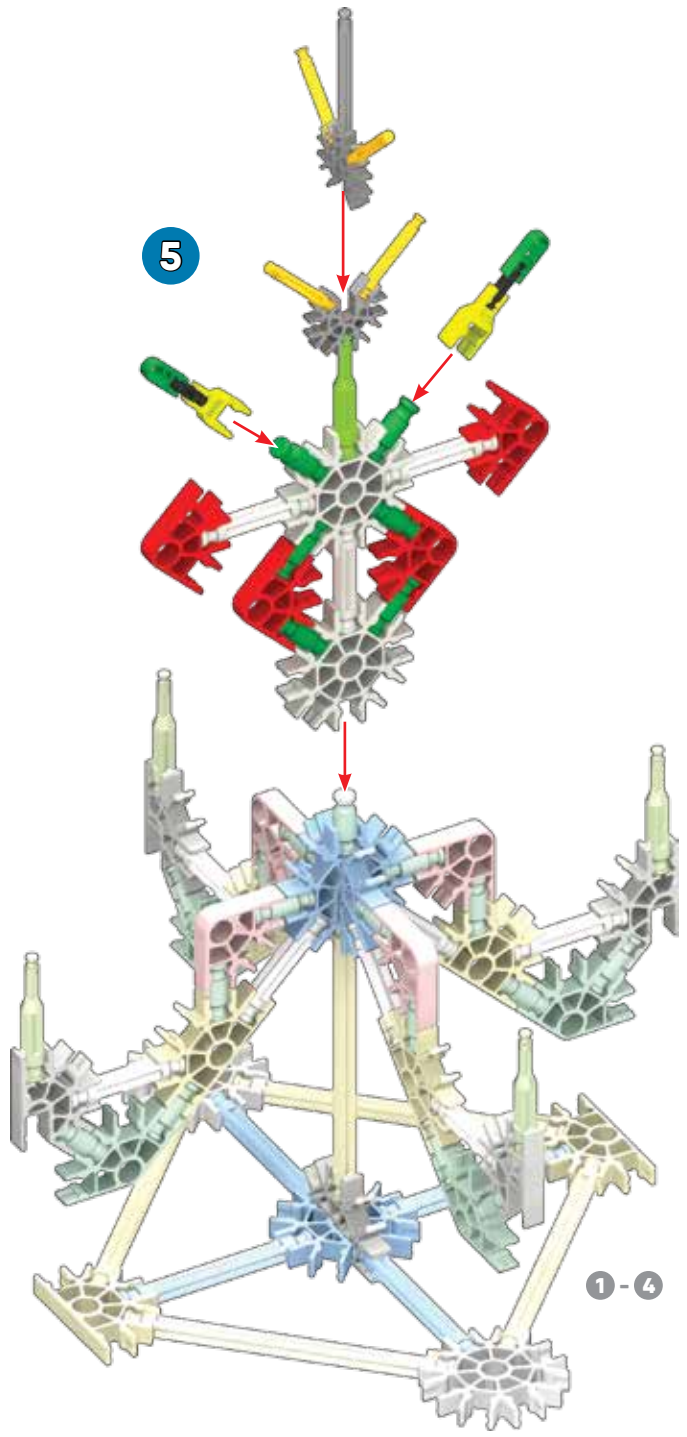

- | | | |
|---|---|---|
| 6 | 3 | 2 |
| 4 | 2 | 2 |
| 2 | 1 | |
| 2 | 4 | 1 |

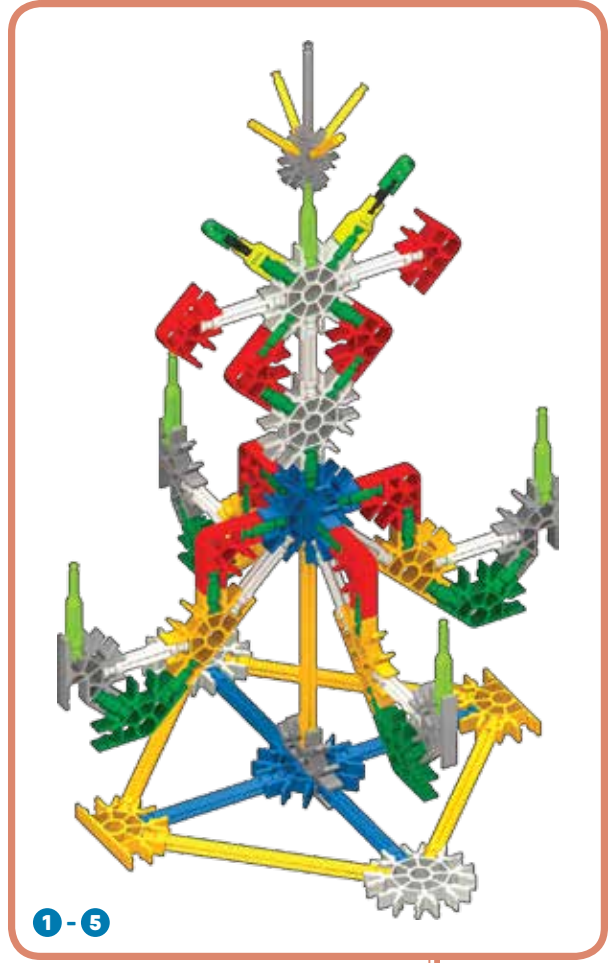

x2

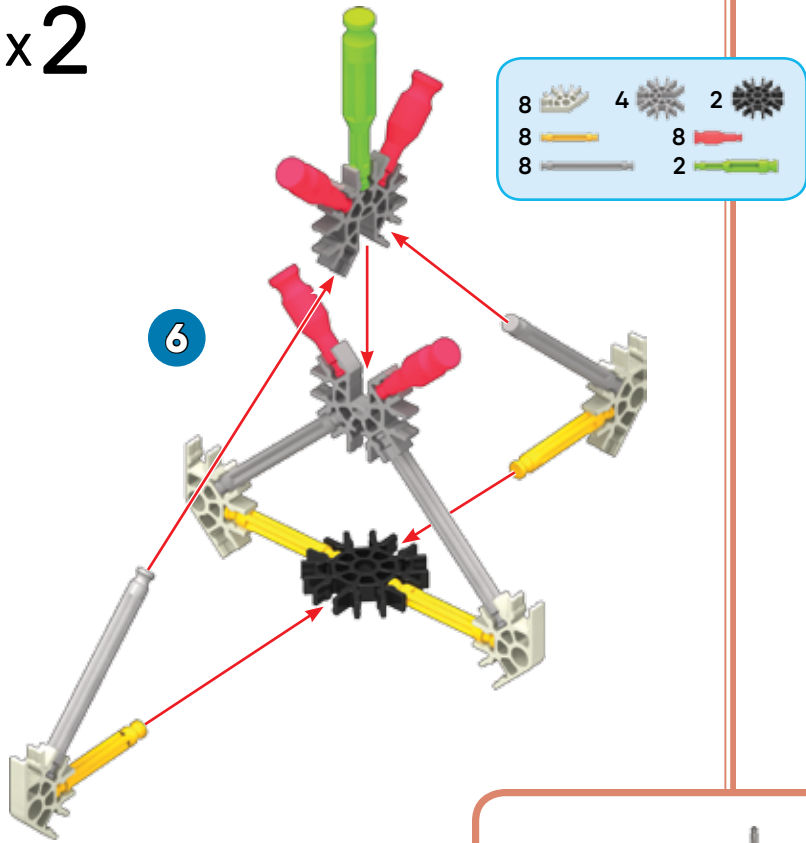

x2

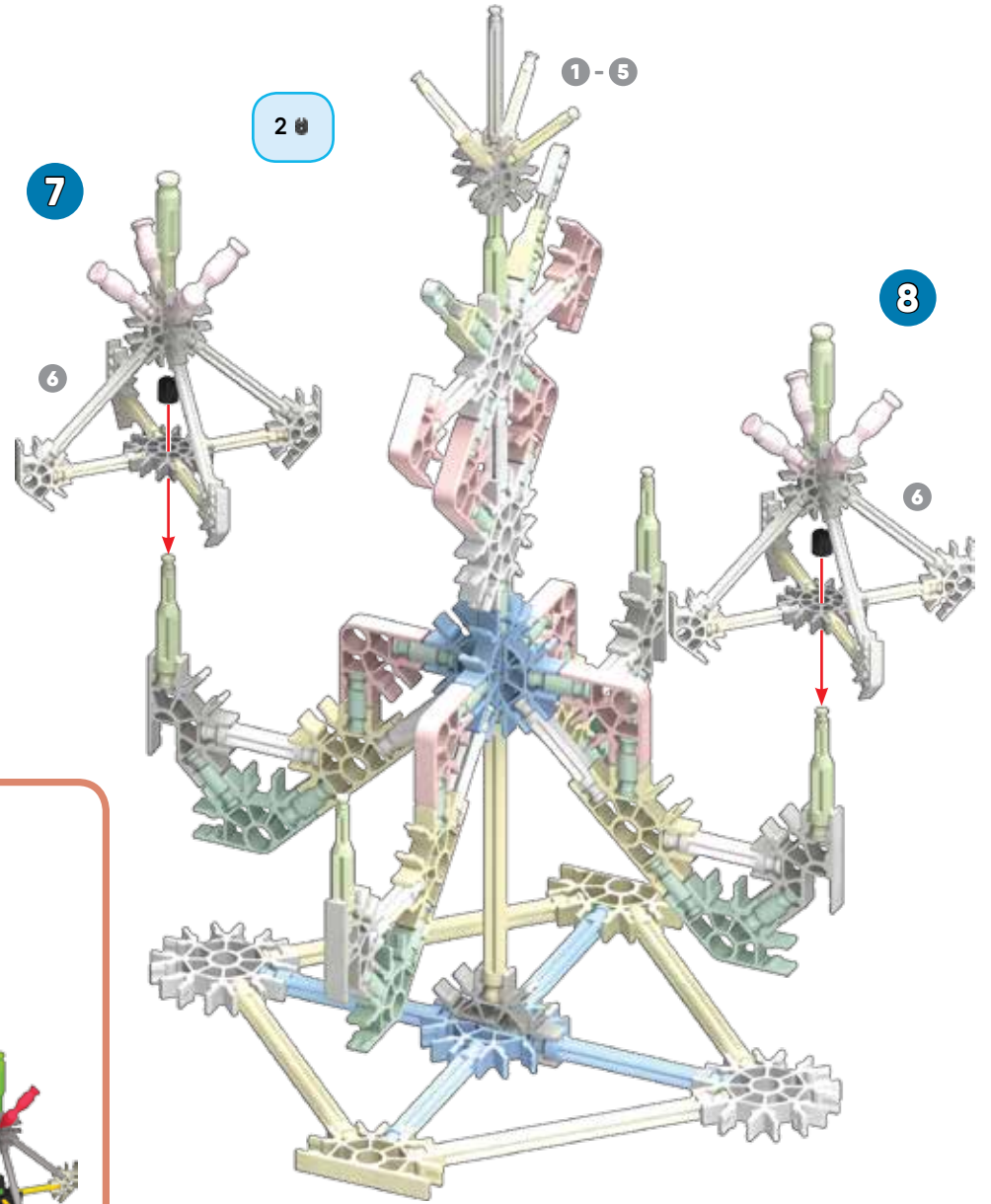
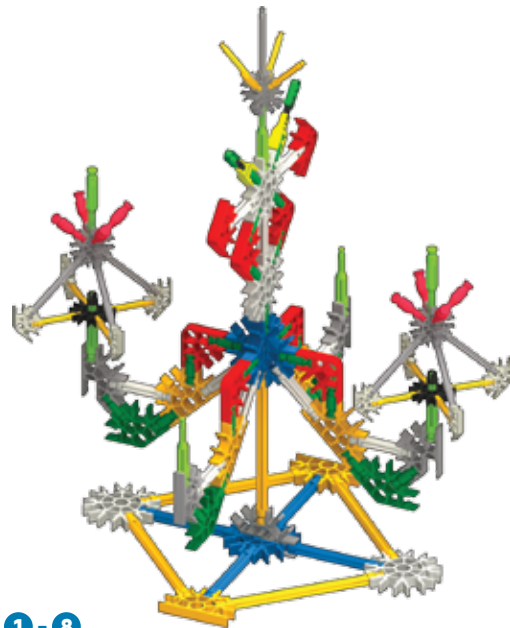
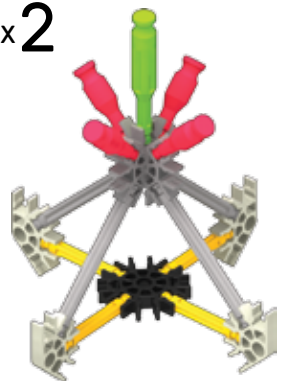

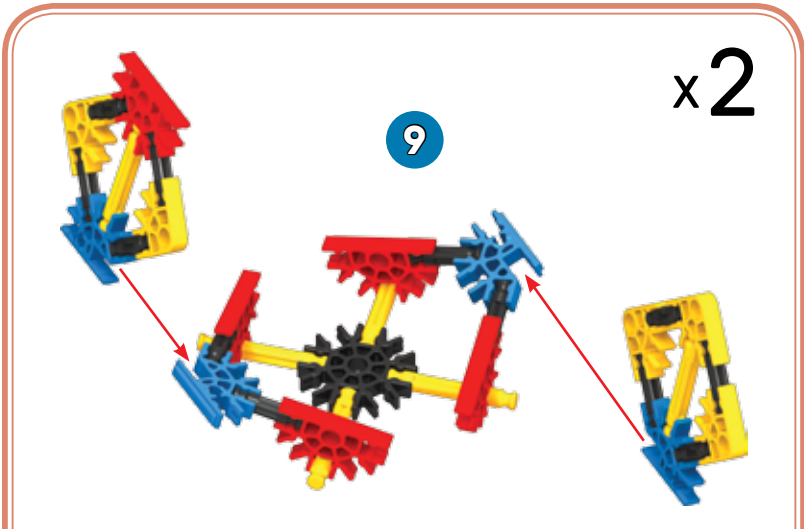

24		12	
10		10	
8		2	

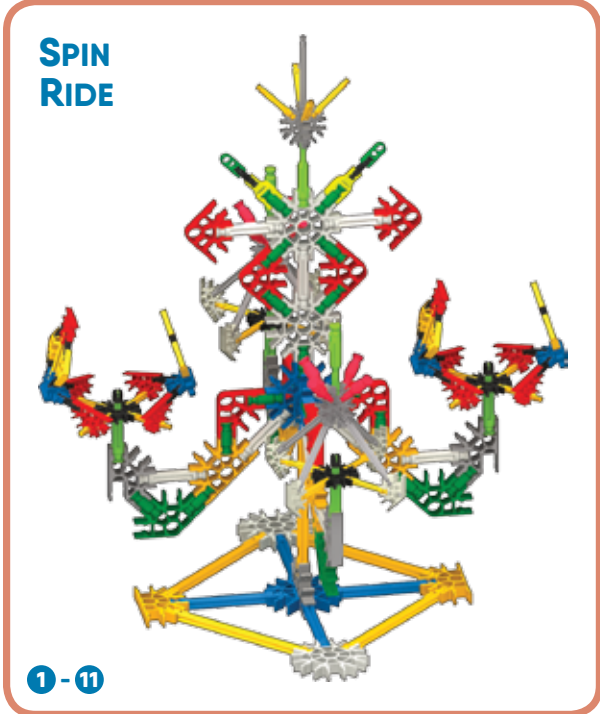
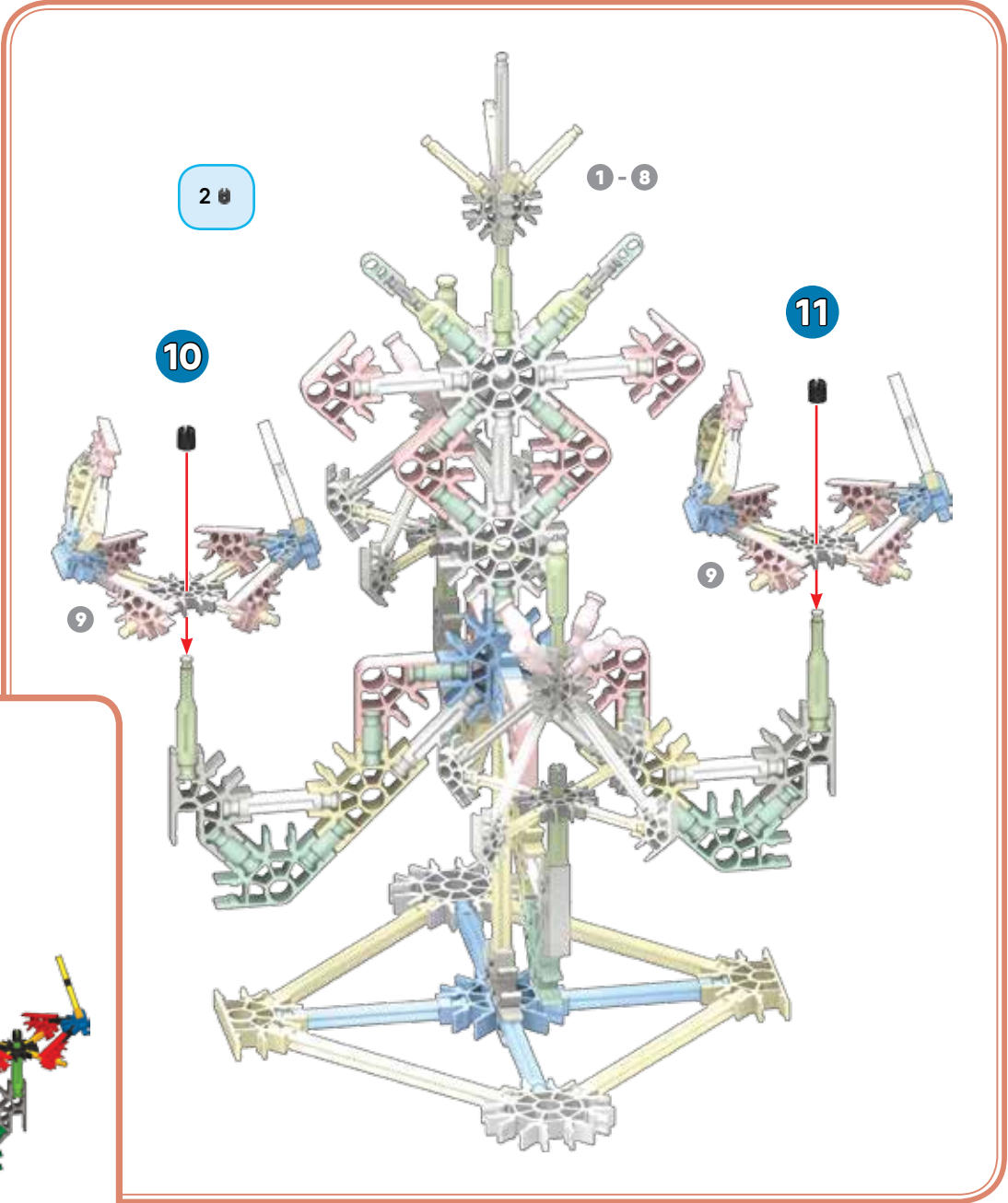

V. T. O. L.

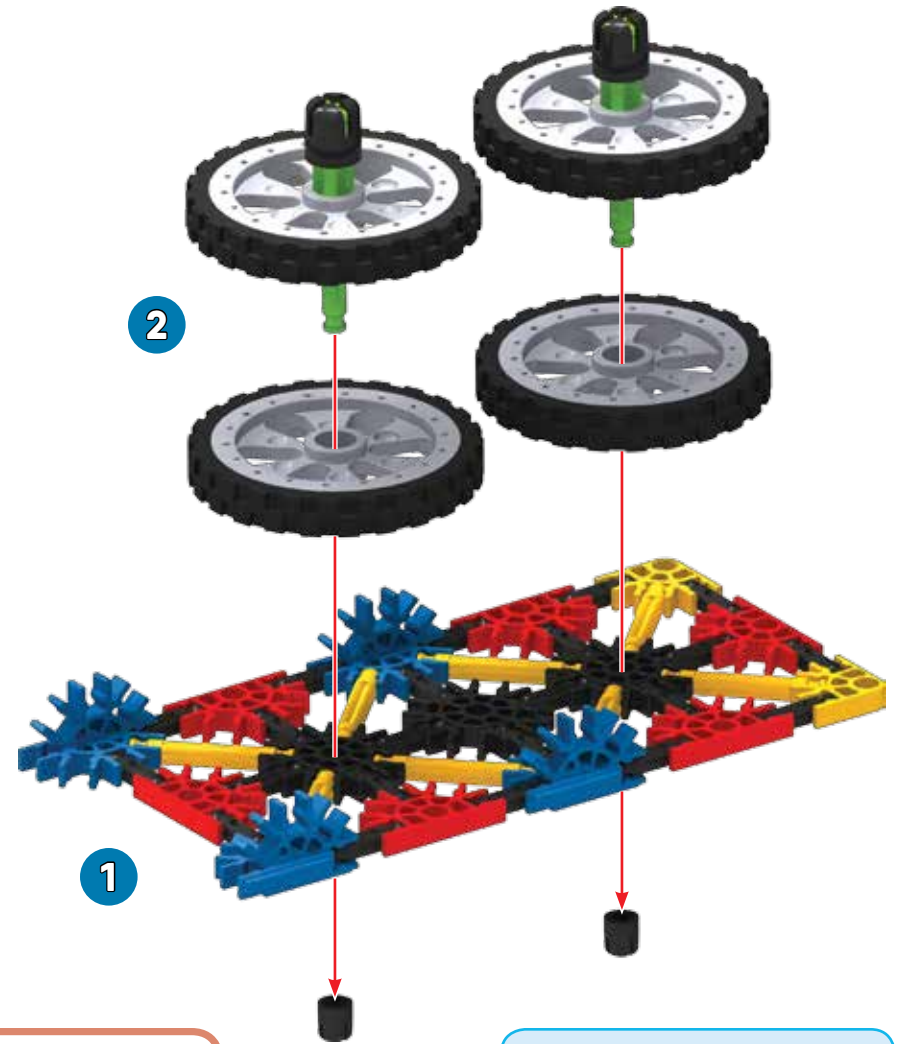

- | | | | | | |
|----|--|---|--|---|--|
| 4 | | 4 | | 2 | |
| 2 | | 6 | | 2 | |
| 22 | | 8 | | 2 | |
| | | 8 | | 3 | |

1 - 2

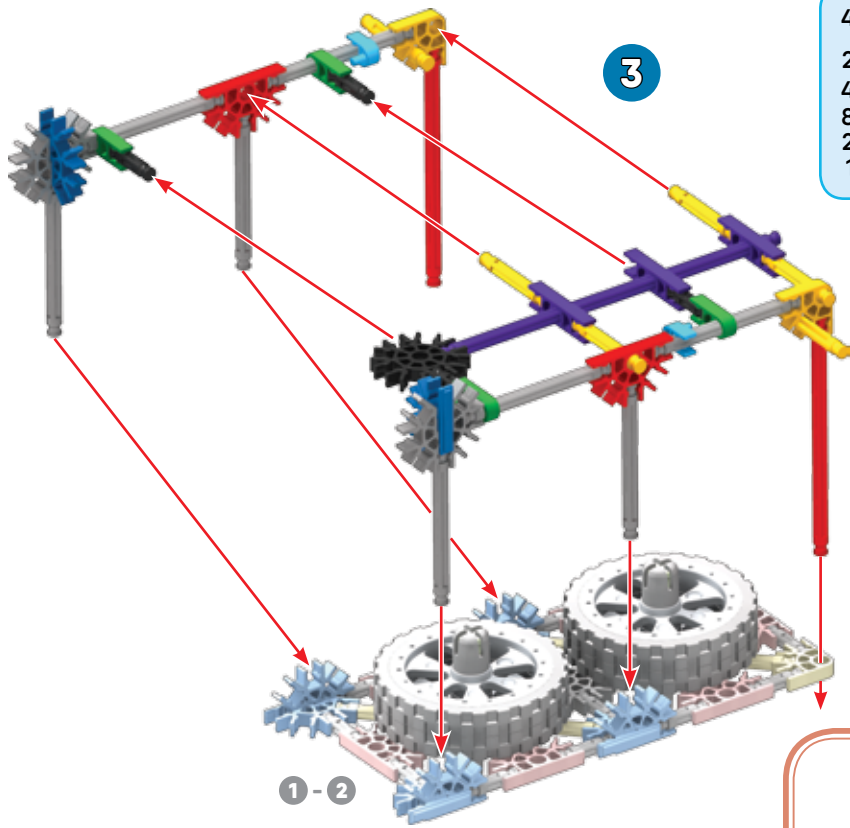

- | | | |
|---|---|---|
| 4 | 3 | 2 |
| 2 | 2 | 2 |
| 4 | 6 | 1 |
| 8 | 2 | |
| 2 | | |
| 1 | | |

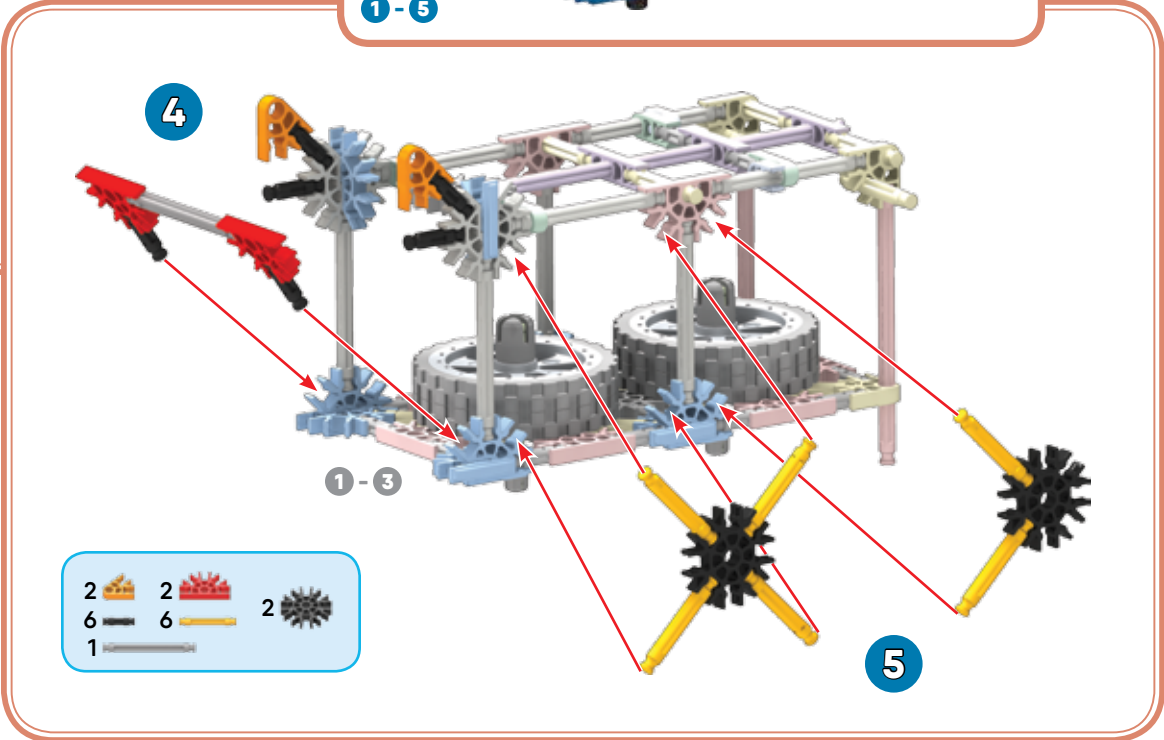

- | | | |
|---|---|---|
| 2 | 2 | 2 |
| 6 | 6 | 2 |
| 1 | | |

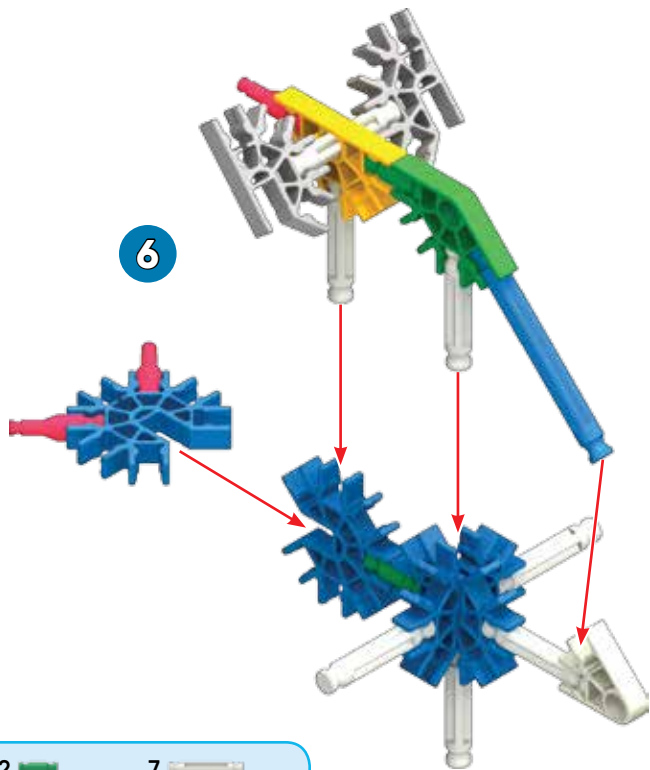

6

- | | | | |
|---|------------------------------|---|-------------------------------|
| 2 | Green Technic Pin | 7 | White Technic Pin |
| 1 | Blue Technic Beam (11 holes) | 1 | Green Technic Beam (3 holes) |
| 3 | Red Technic Pin | 1 | Yellow Technic Beam (3 holes) |
| 1 | Grey Technic Axle (1 hole) | 1 | Yellow Technic Beam (5 holes) |
| 2 | Grey Technic Axle (2 holes) | 4 | Blue Technic Gear (24 teeth) |

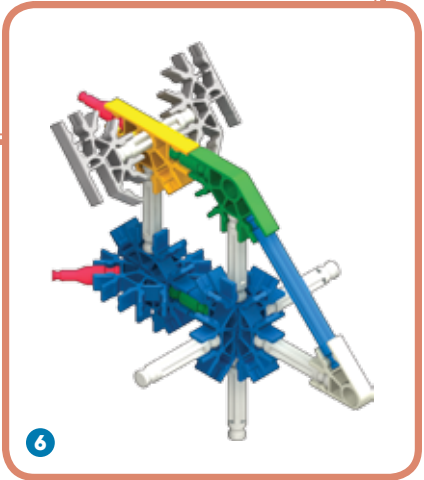

6

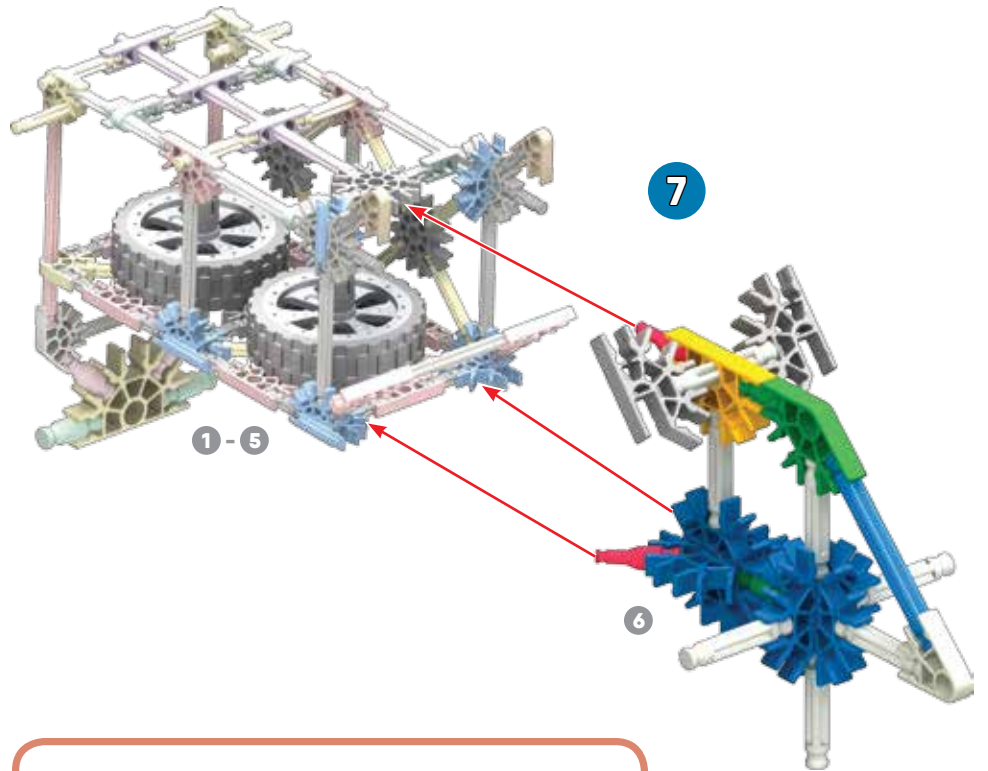

7

1-5

6



1-7

x2

- | | |
|---|---|
| 8 | 4 |
| 4 | 4 |
| 2 | |

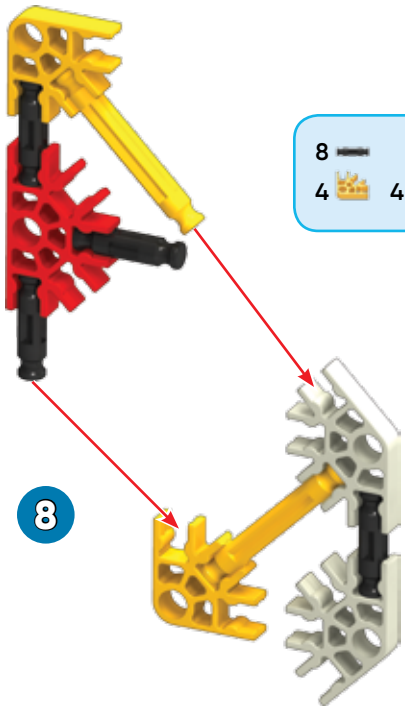

9

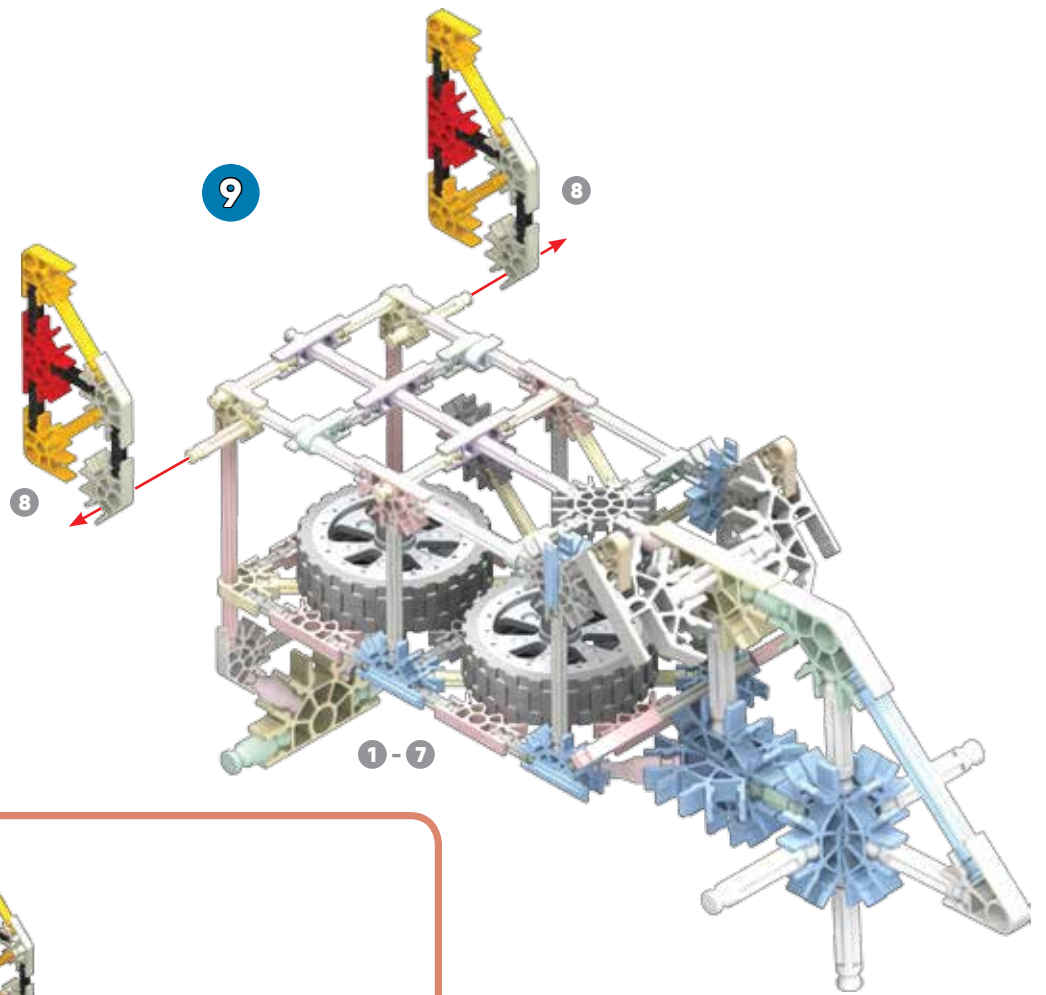

x2

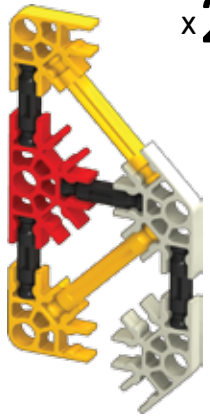

x2

16	6	6	4
2	2	4	2
4	8	2	2
8	8	2	2
2	2	2	2

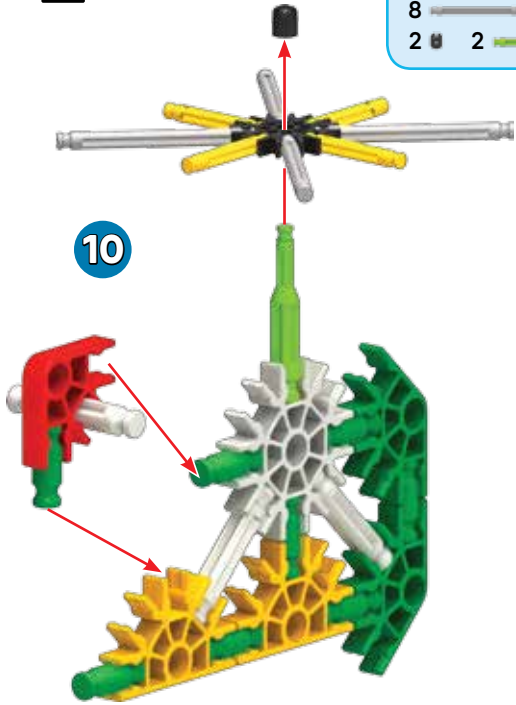

x2

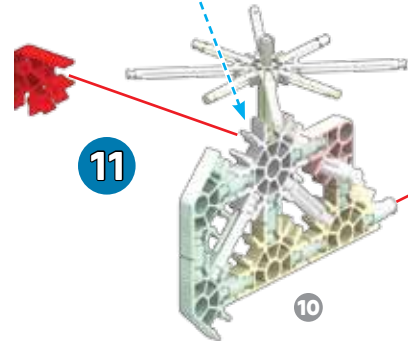
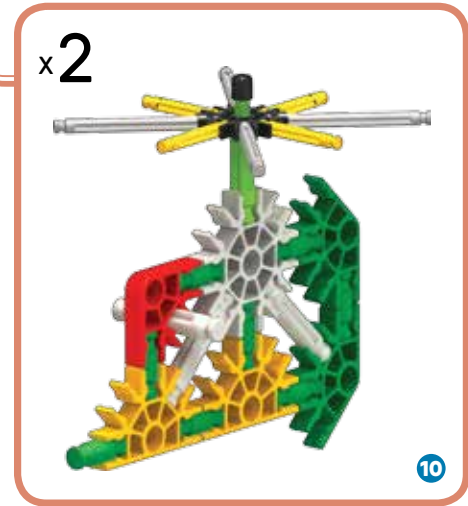

V. T. O. L.



12

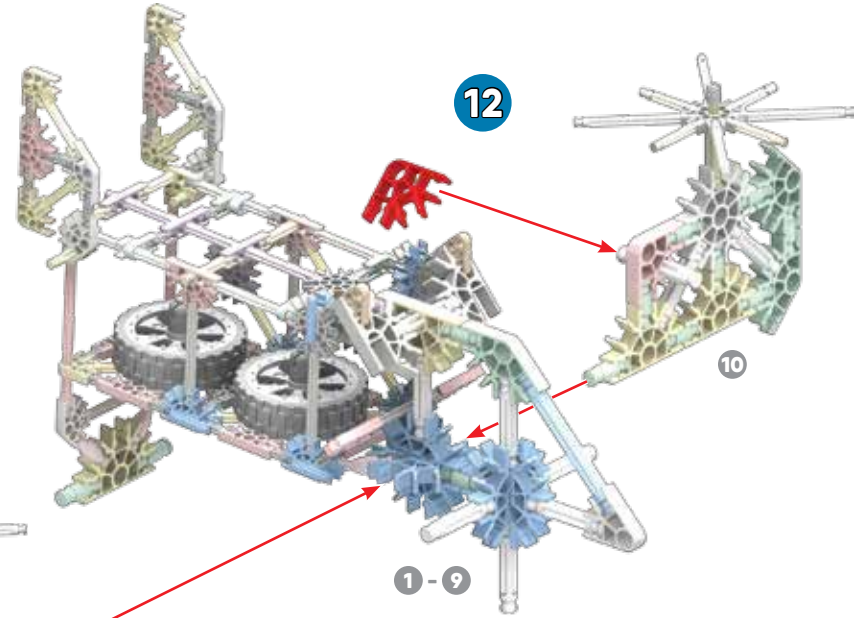

1-9

WRENCH

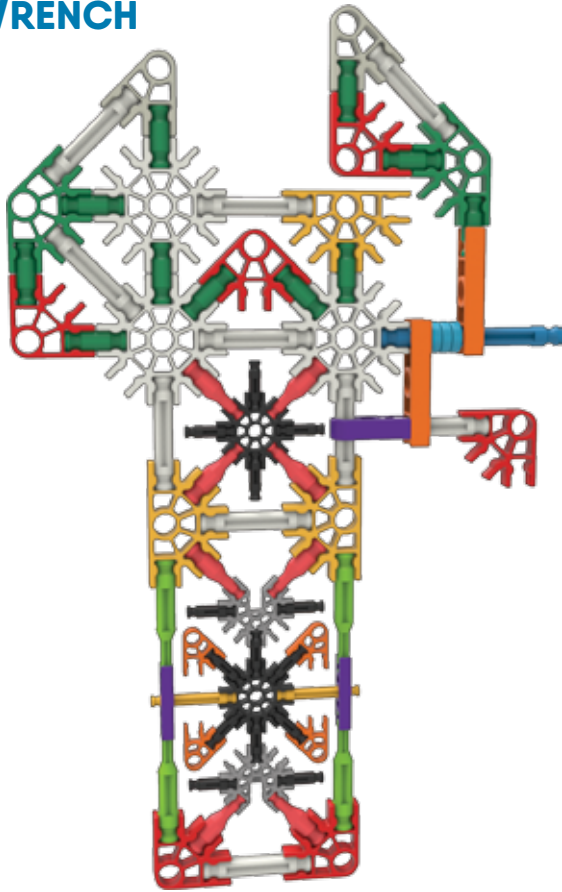

8		7	
1		1	
2		1	
3		3	
4		4	
		1	

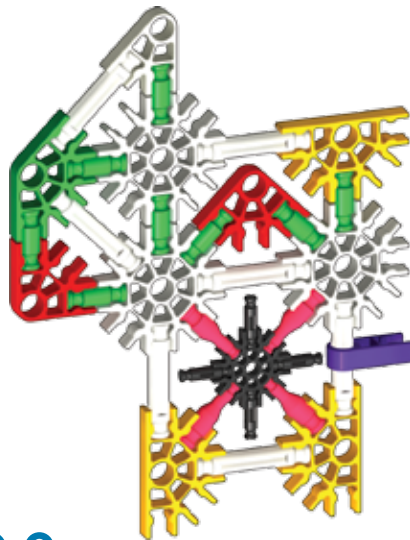
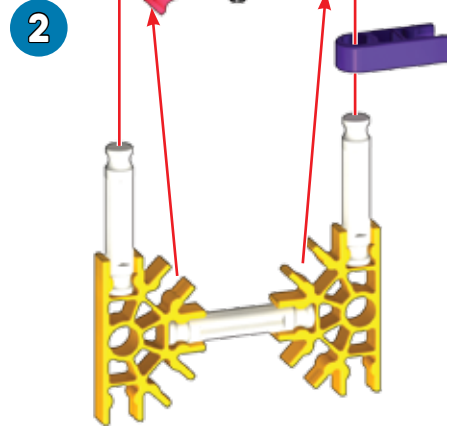
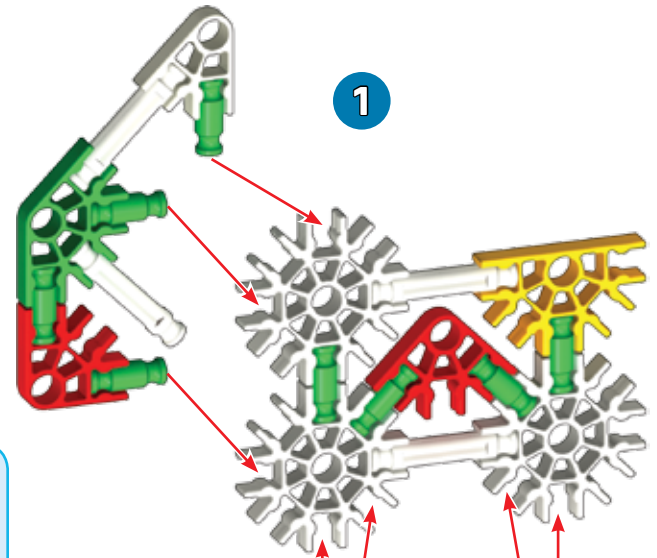

1-2

- | | | |
|---|---|---|
| 3 | 2 | 3 |
| 1 | | |
| 2 | 1 | |
| 2 | 1 | |

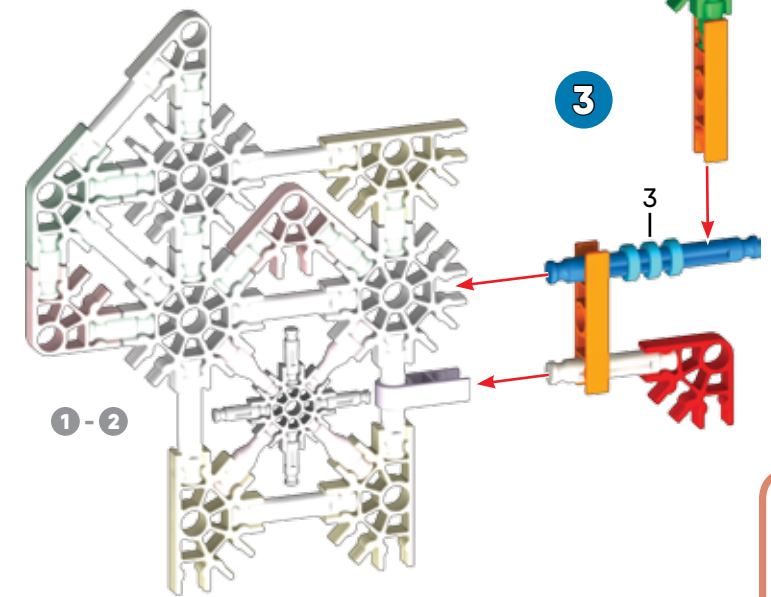

- | | | |
|----|---|---|
| 4 | 2 | 2 |
| 4 | 2 | 1 |
| 10 | 2 | 1 |
| 4 | 2 | |
| 1 | 2 | |

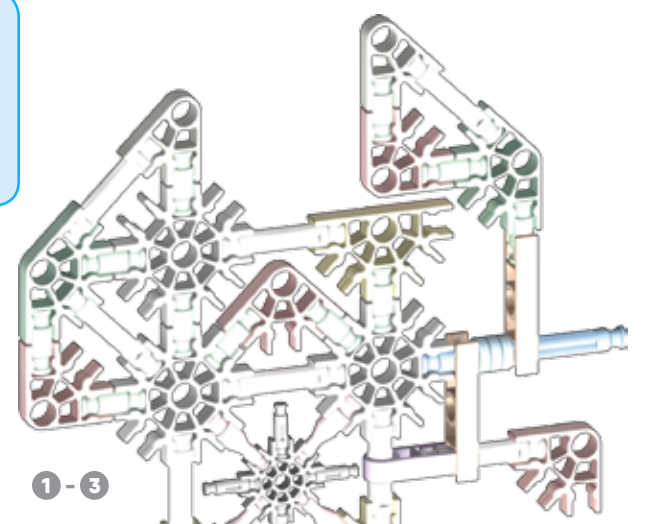

WRENCH

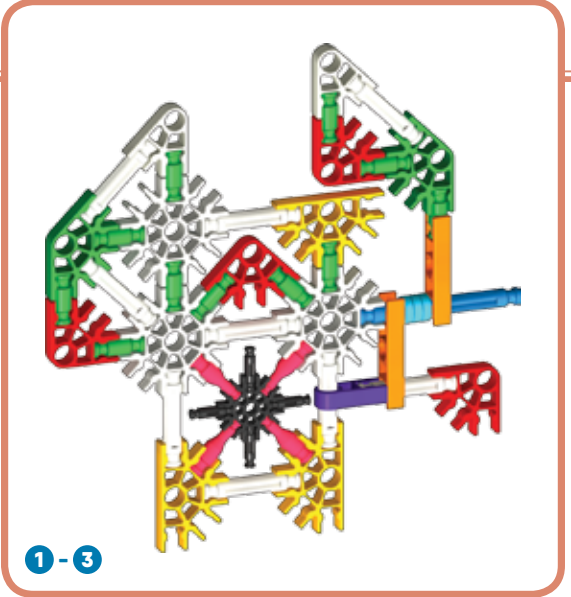
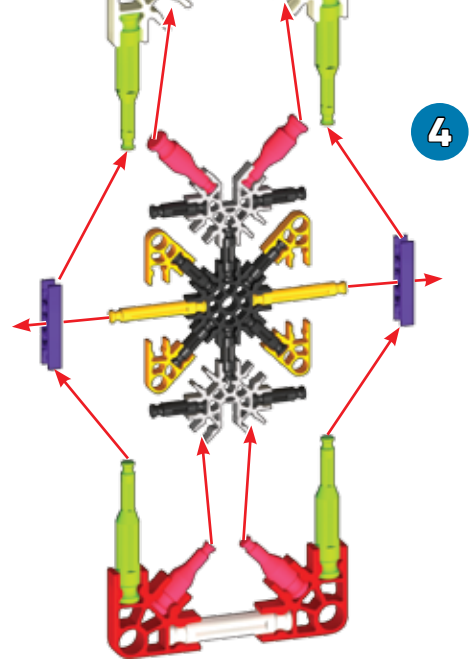
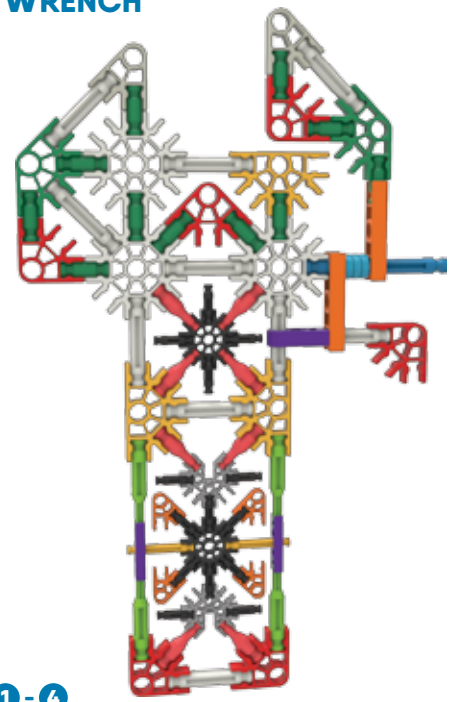

Airplane

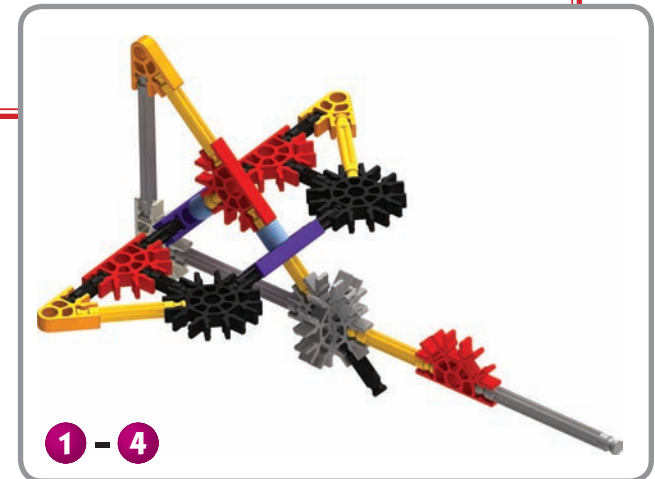
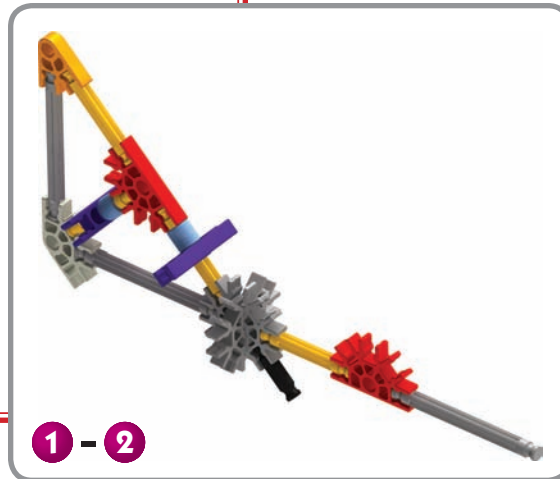
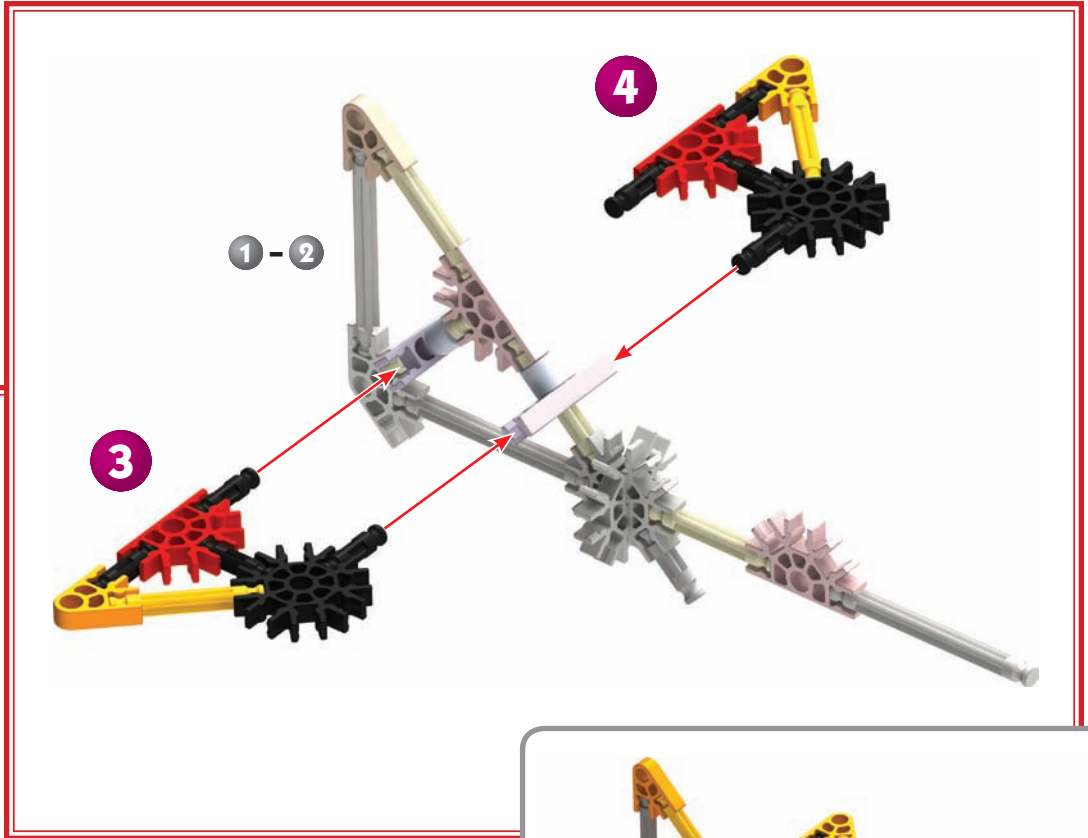
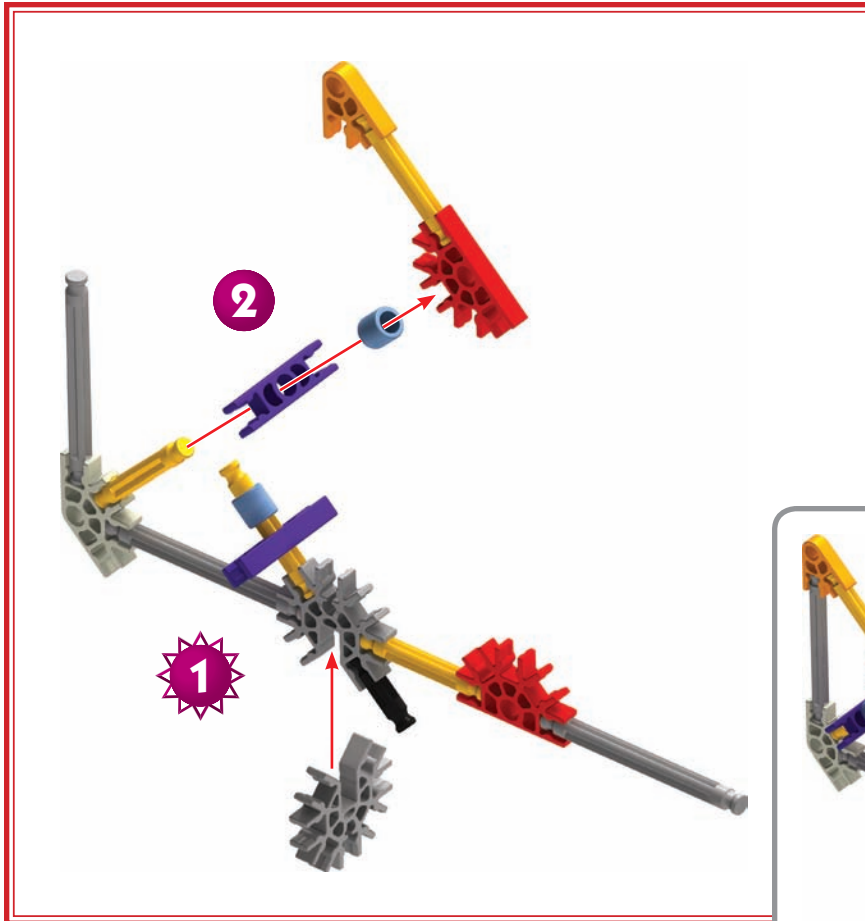

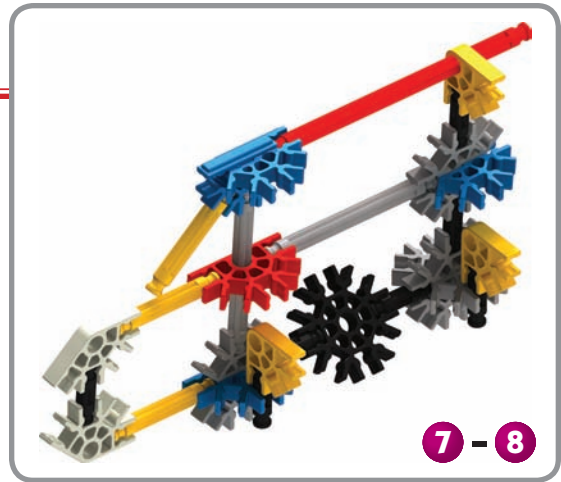
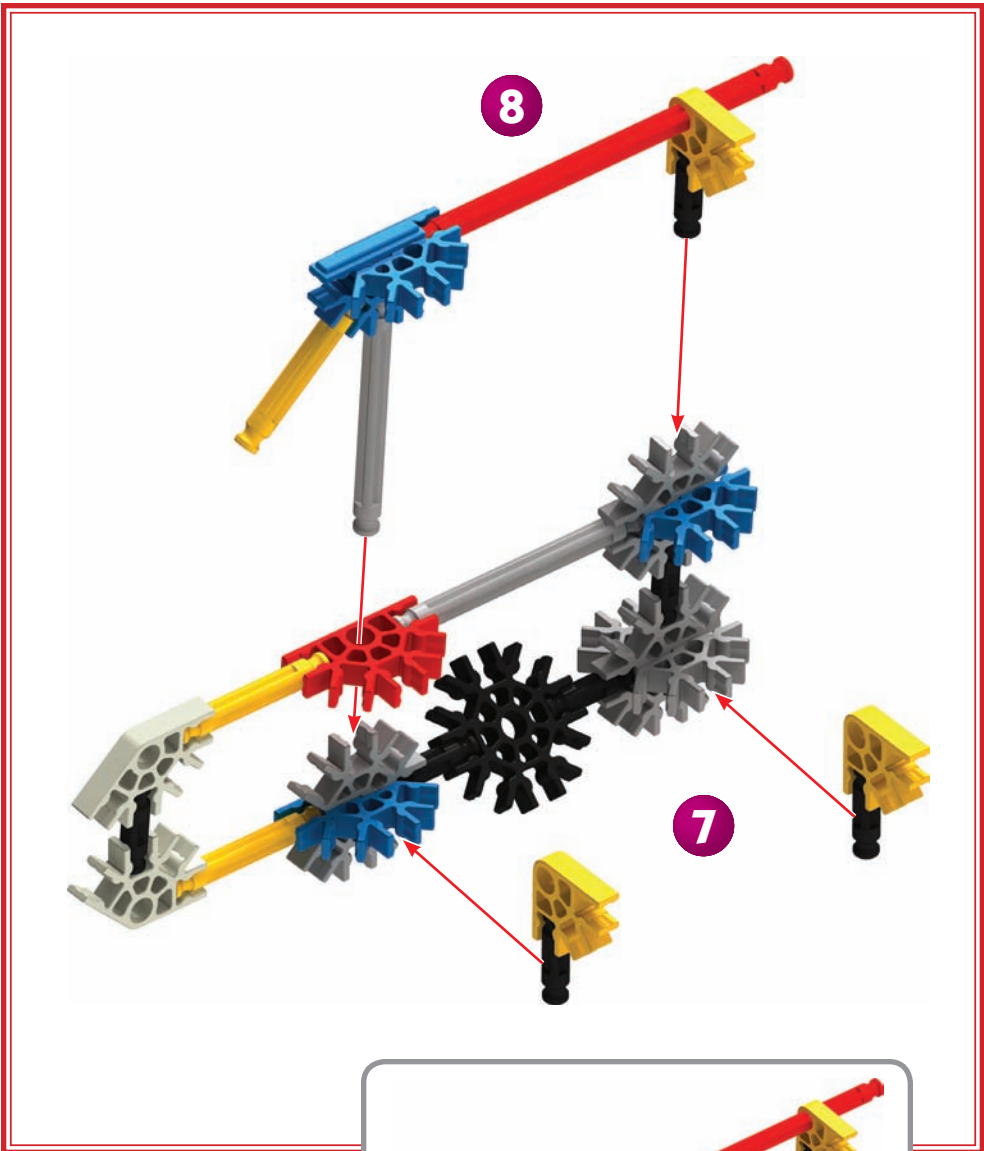
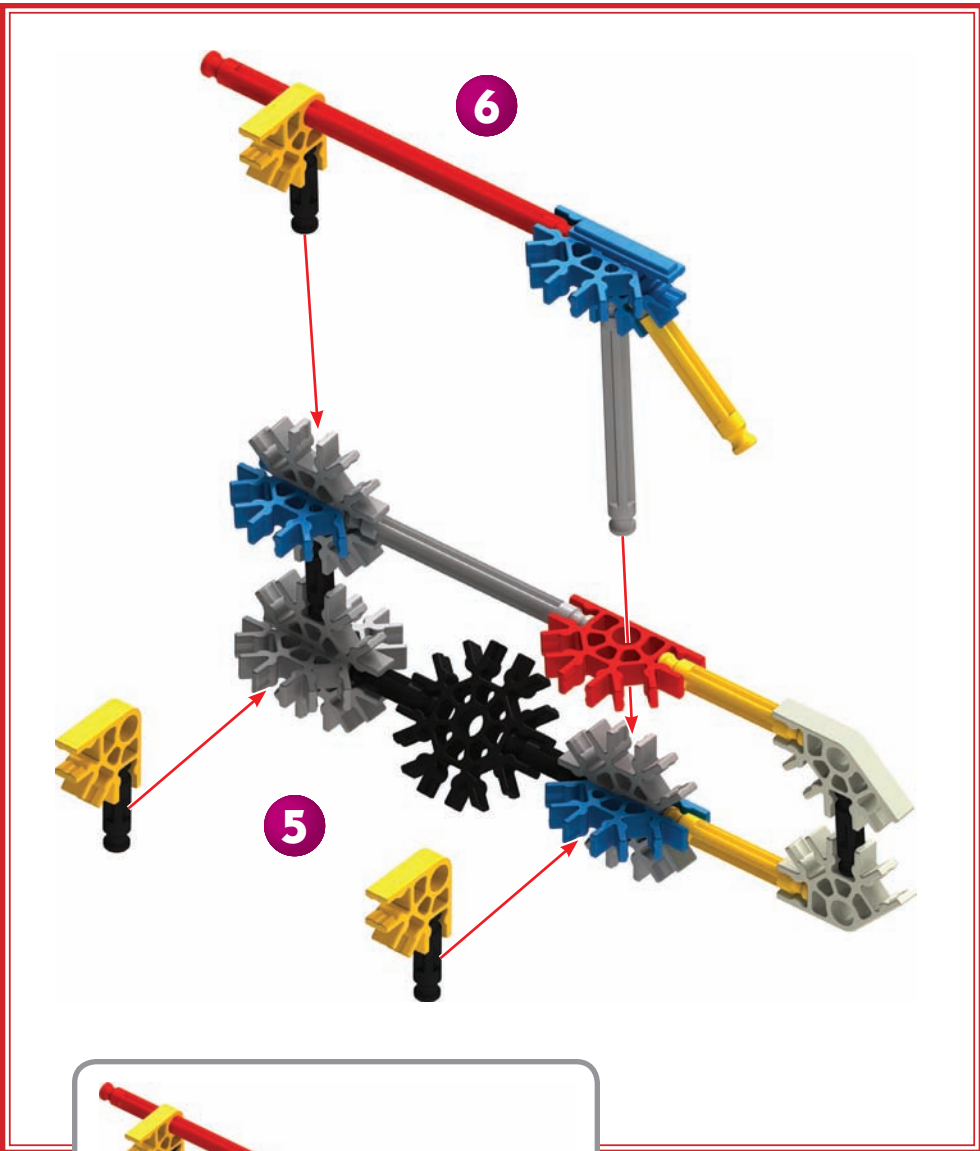

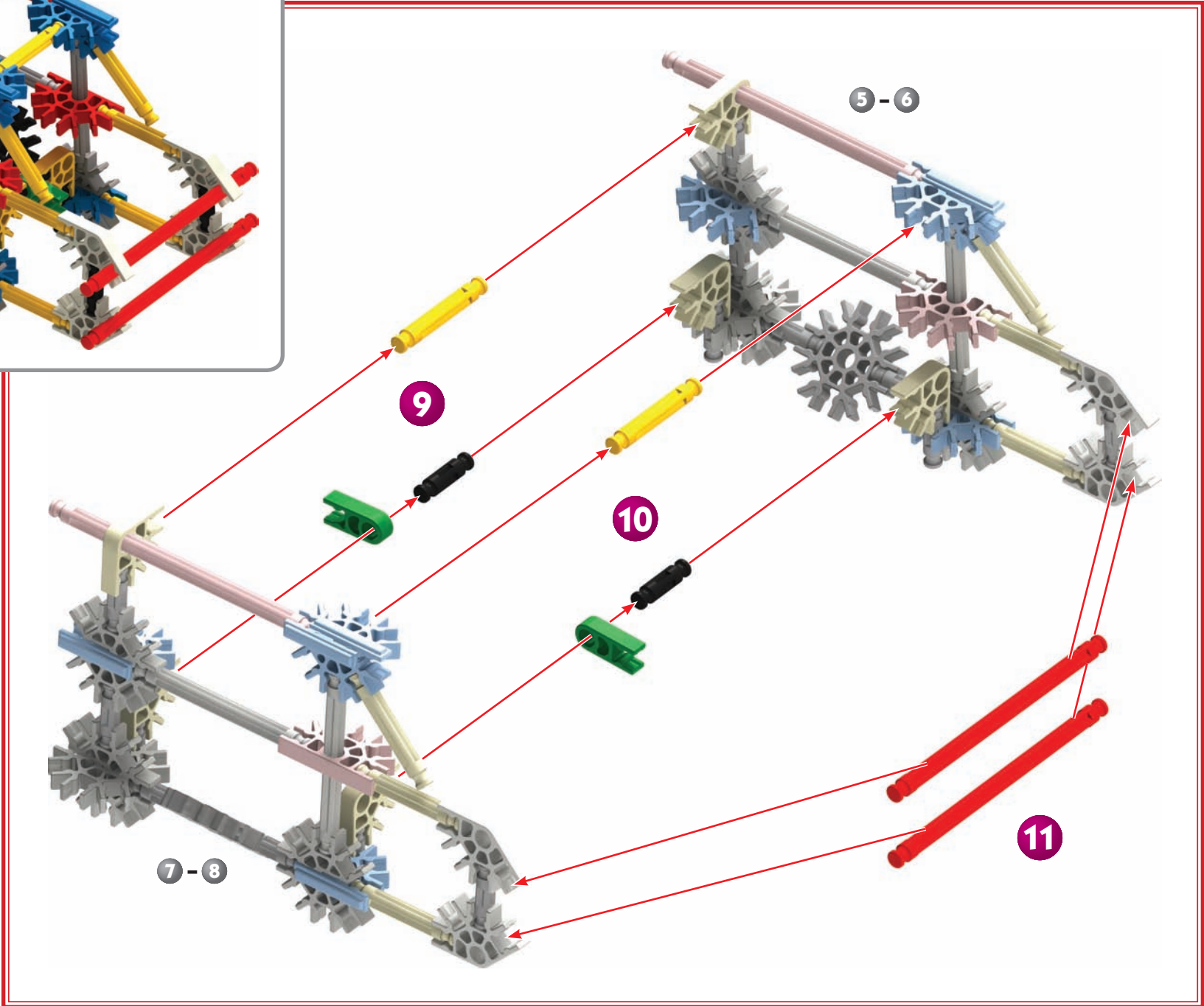
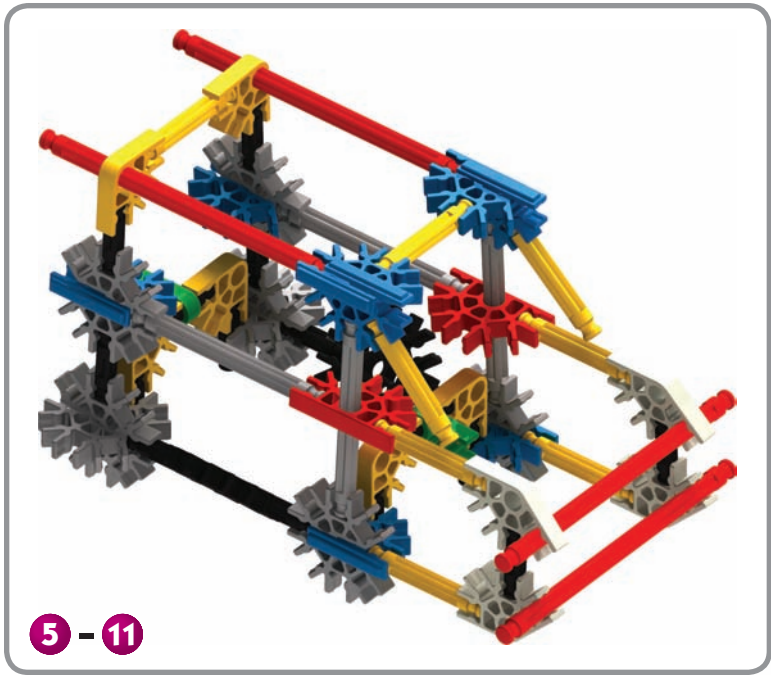

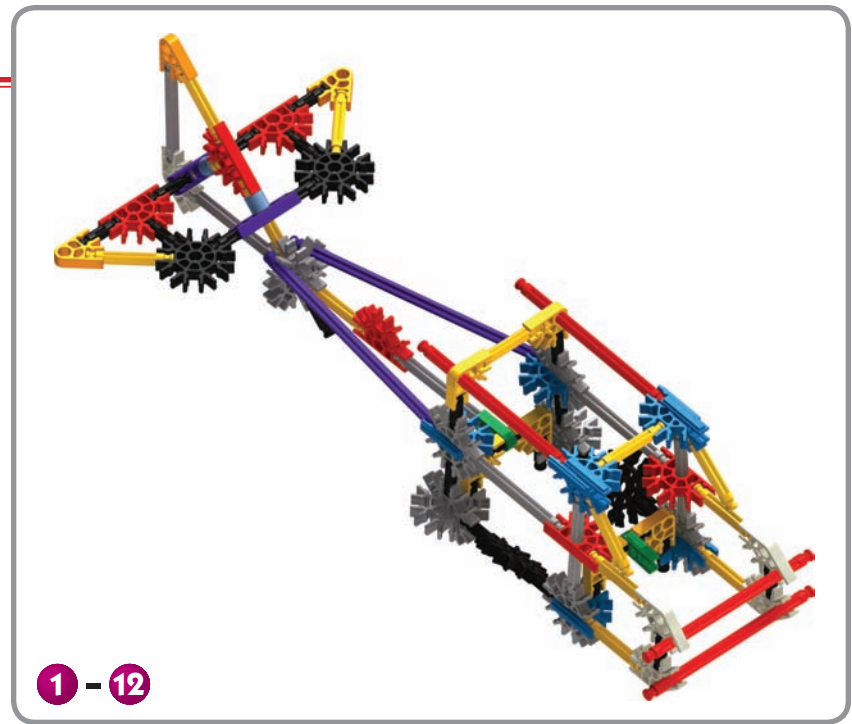
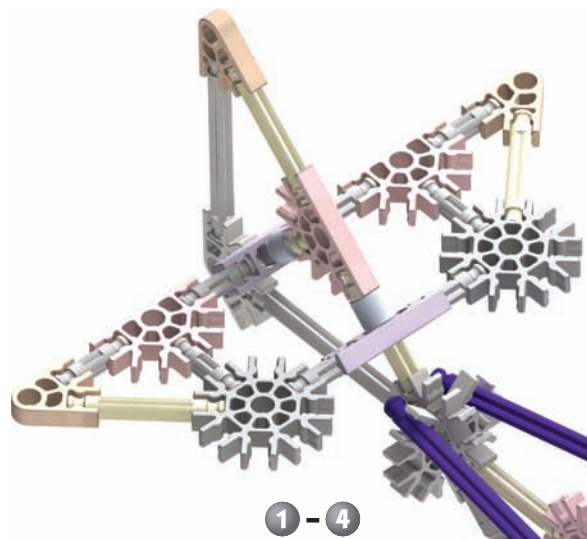

12

5 - 11

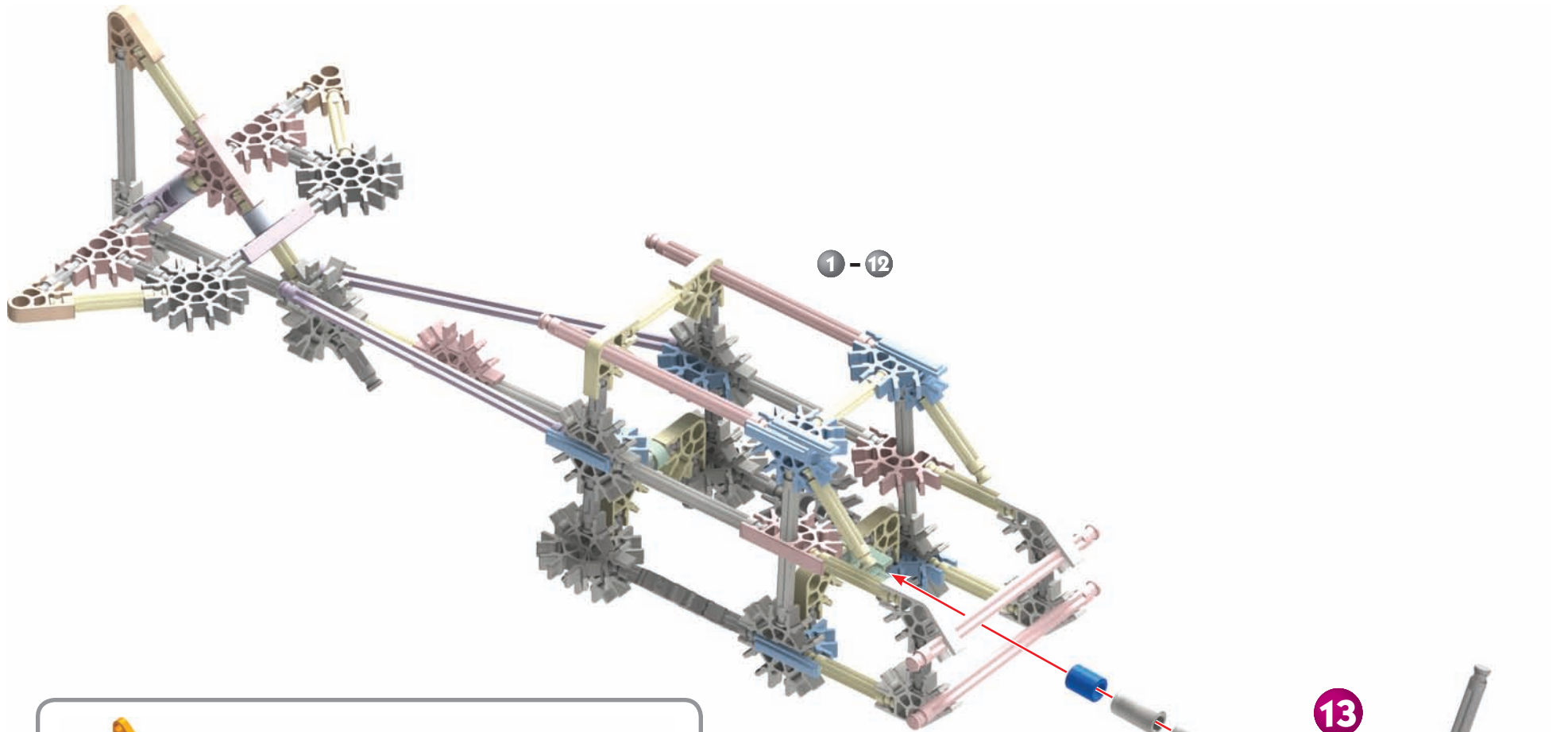

1 - 12

13

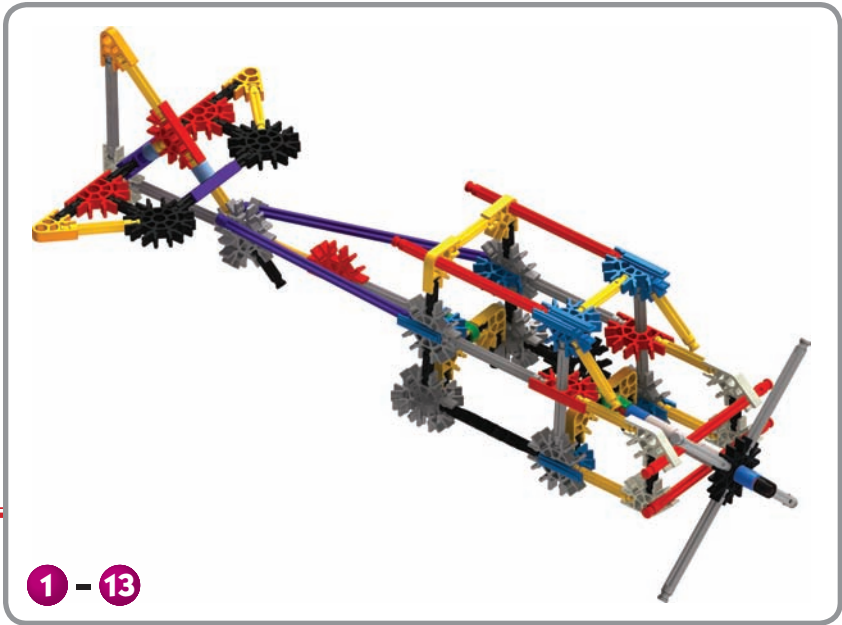

1 - 13

