

Backhoe

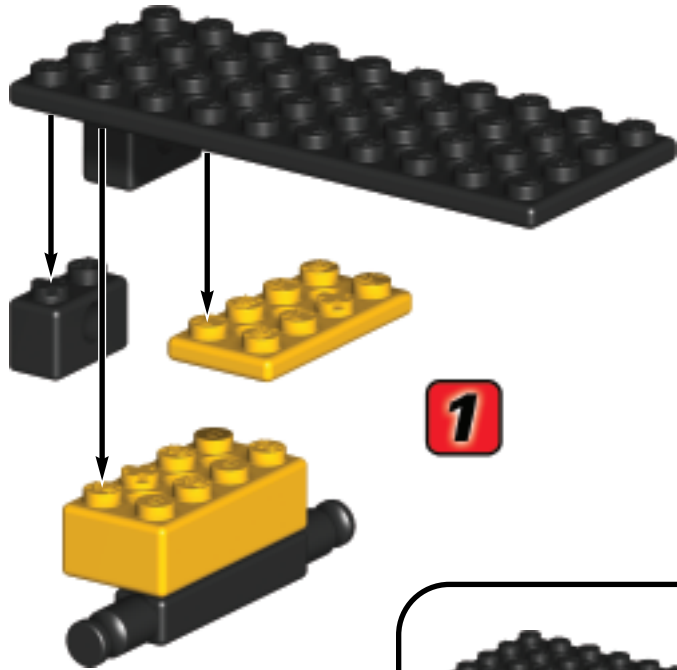

1

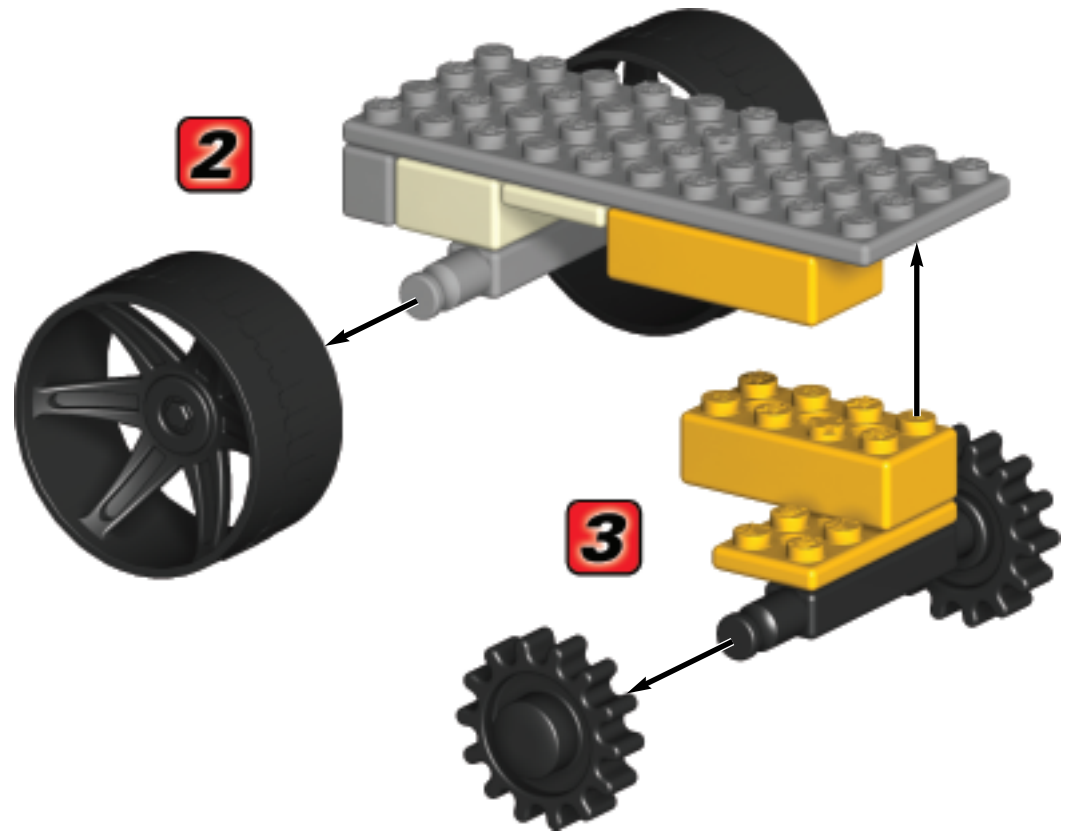
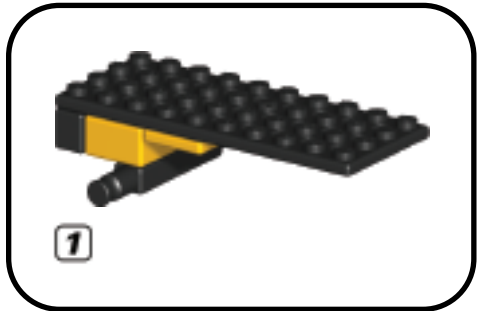

2

3



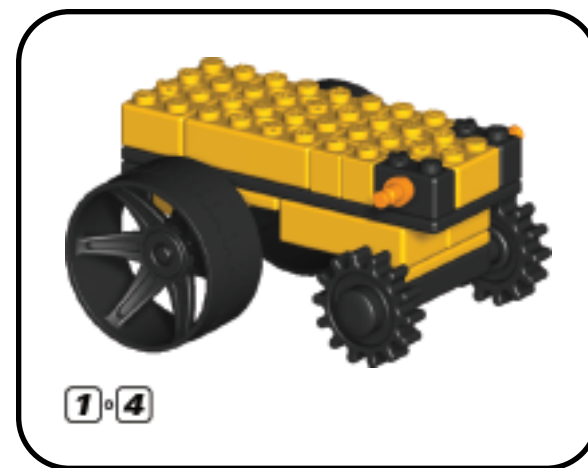
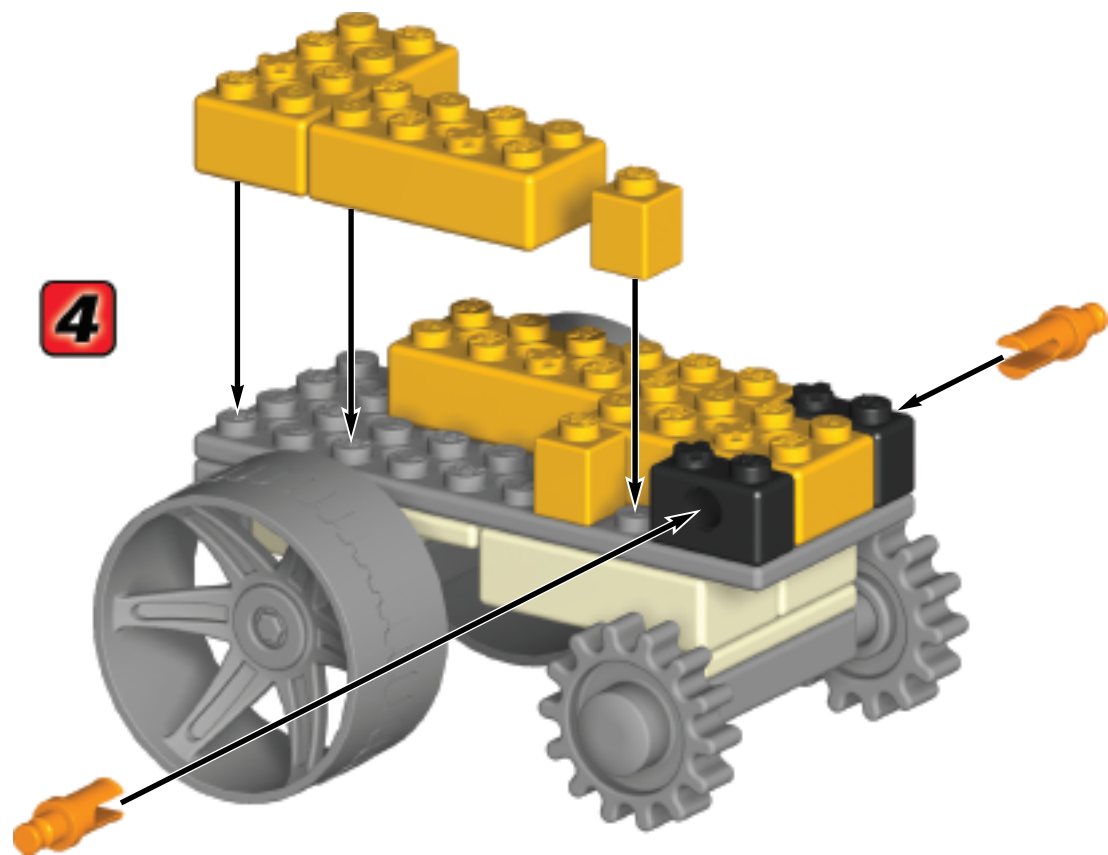

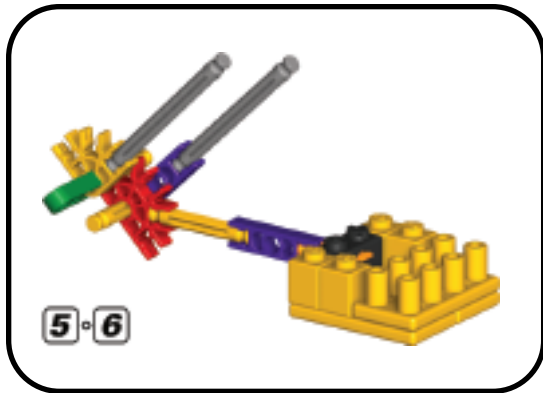
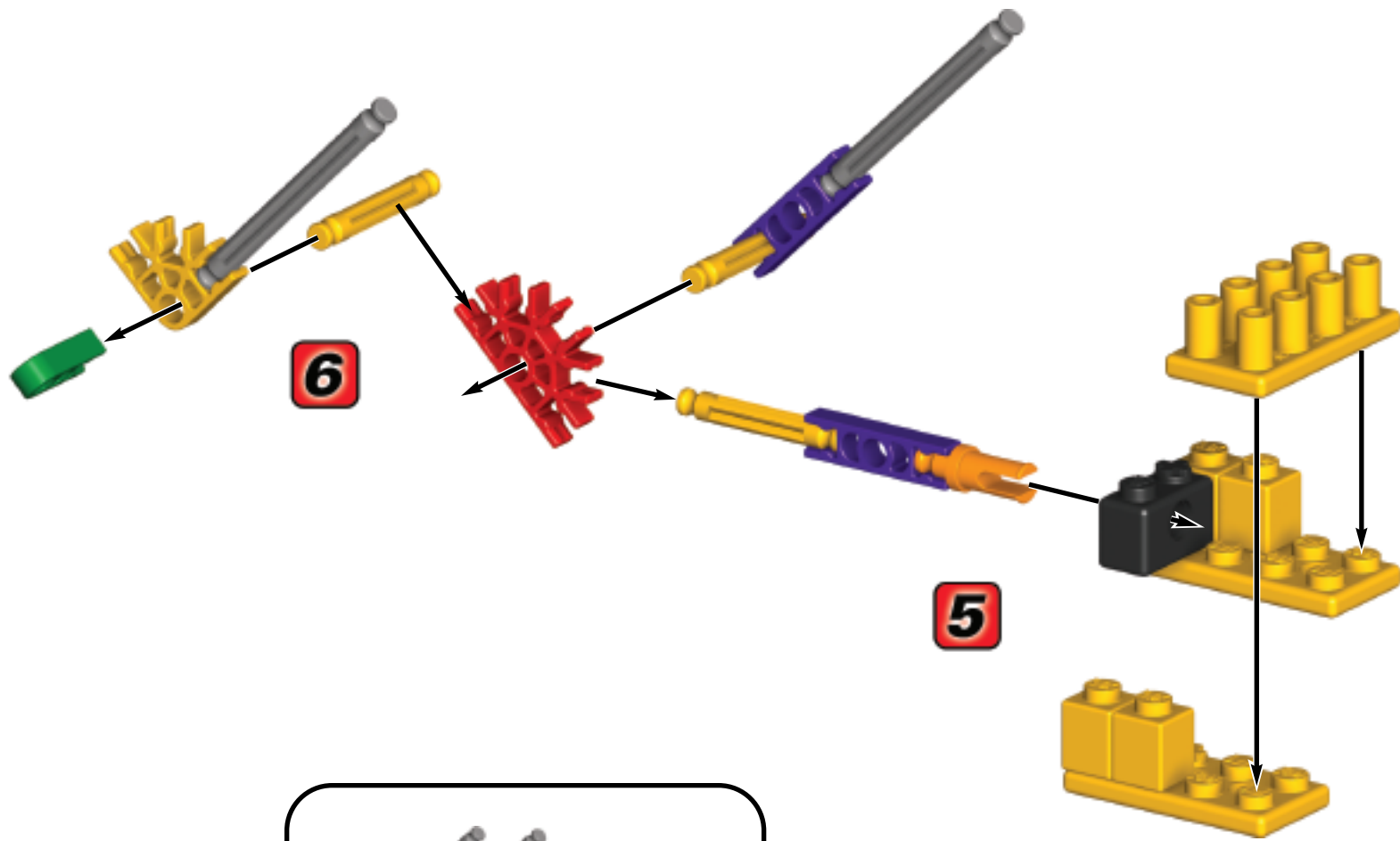

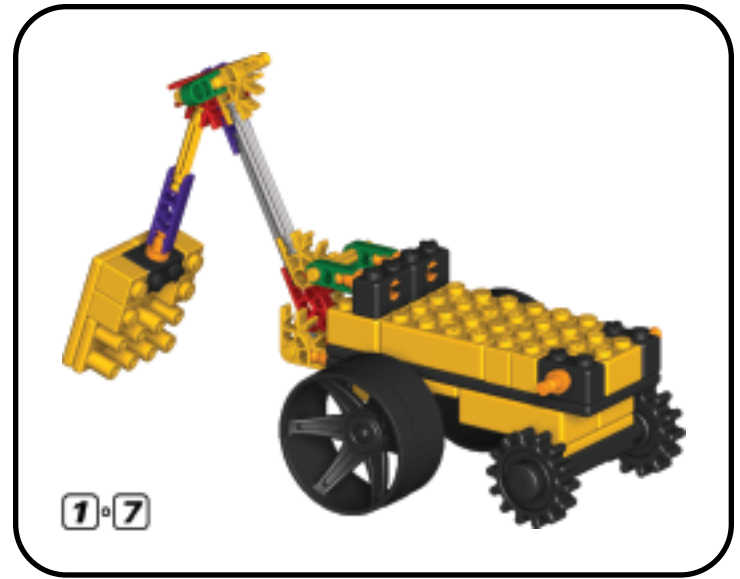
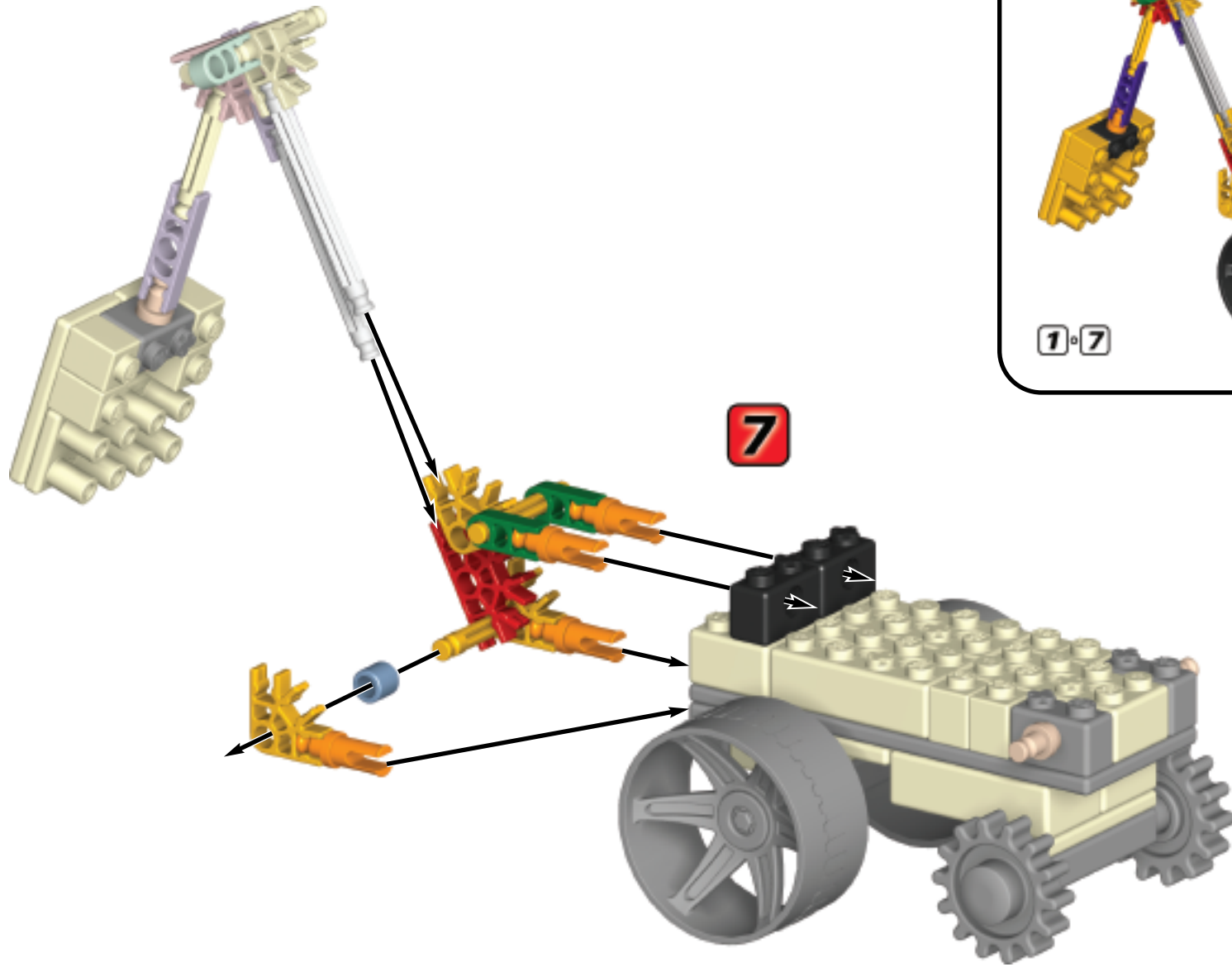

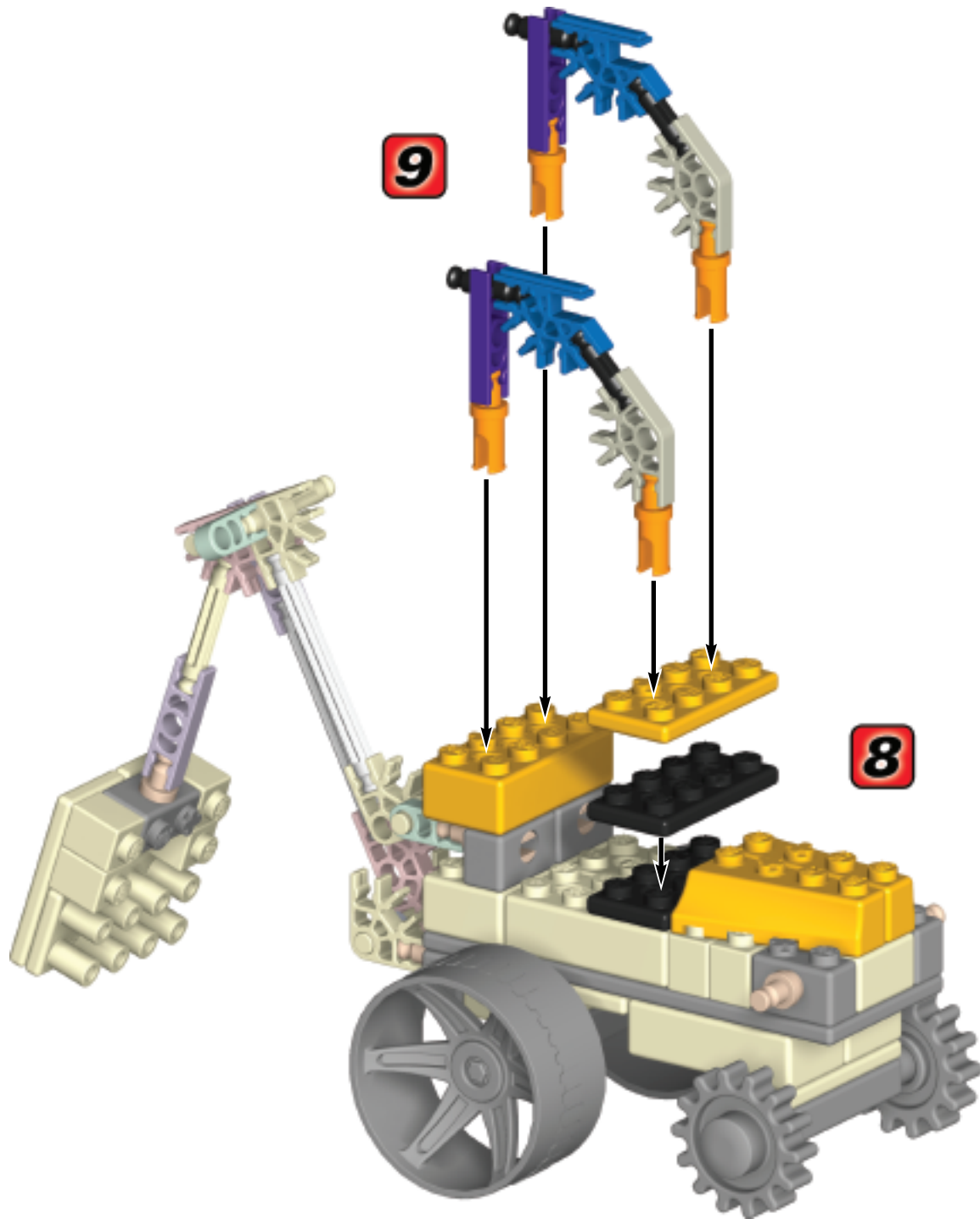

9



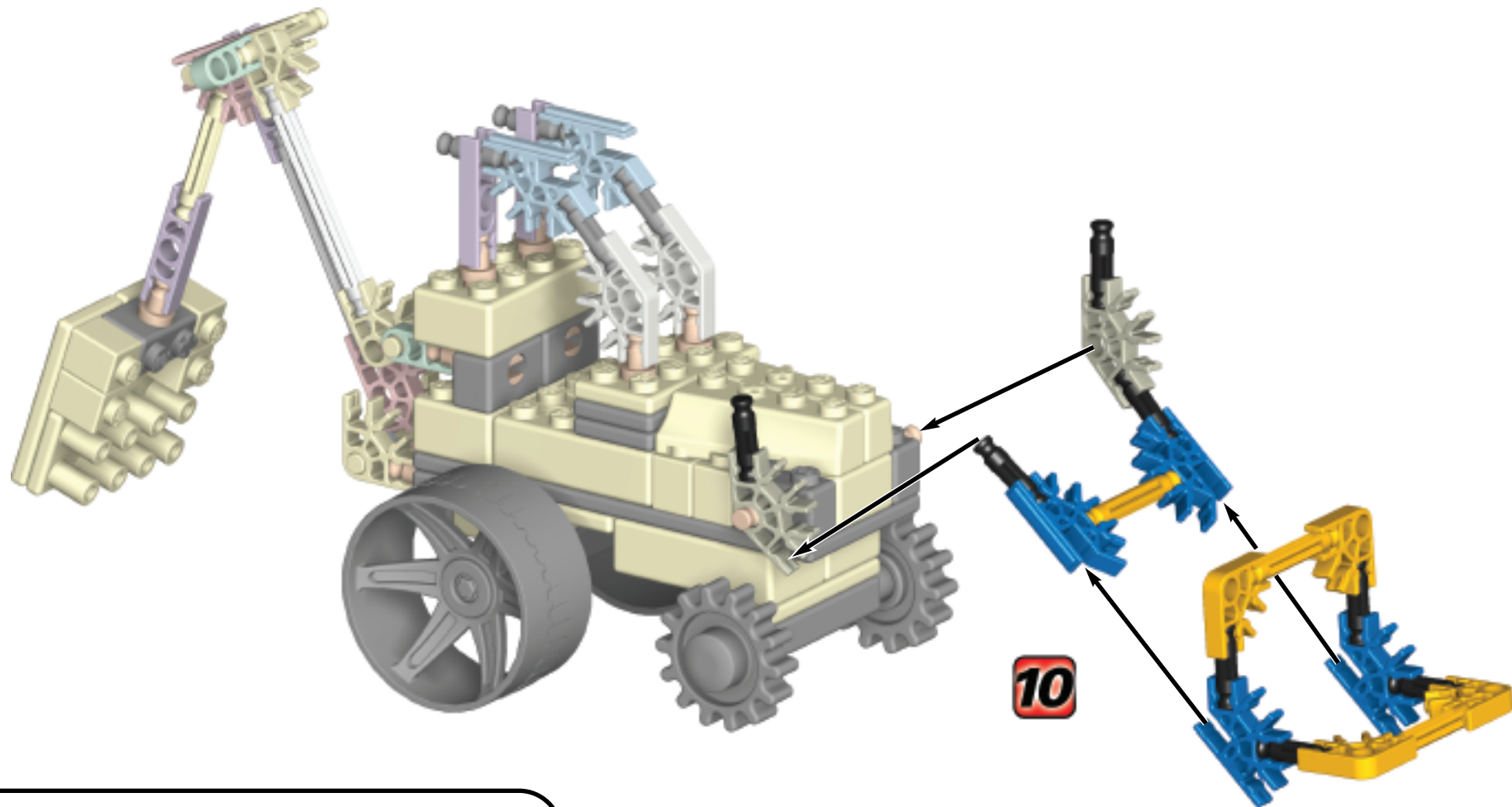

Backhoe



1-10

Crane

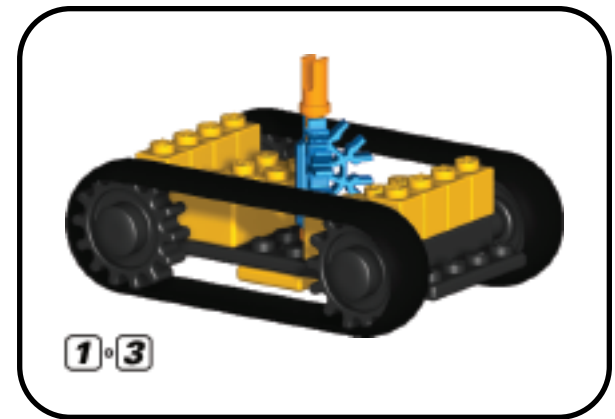
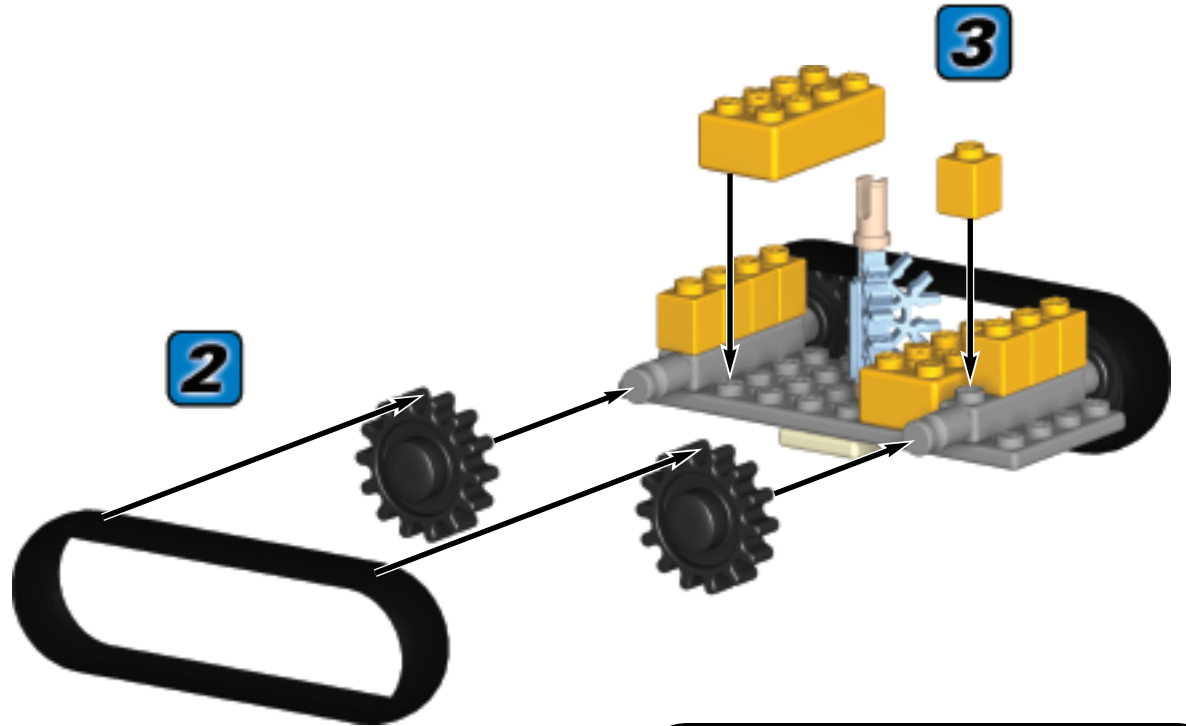
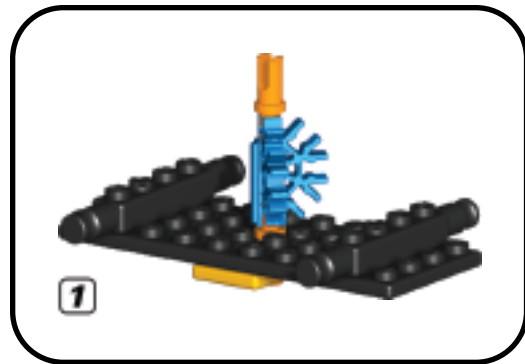
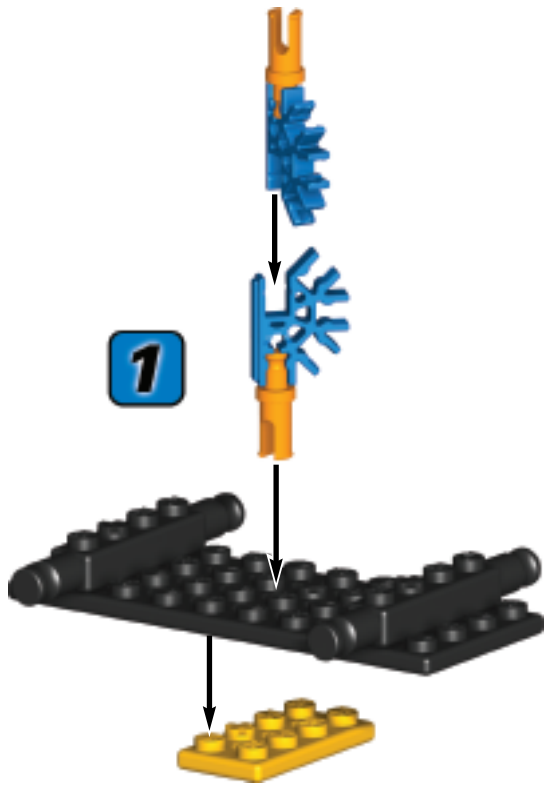

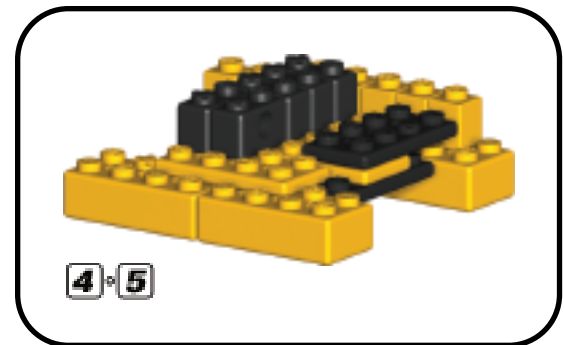
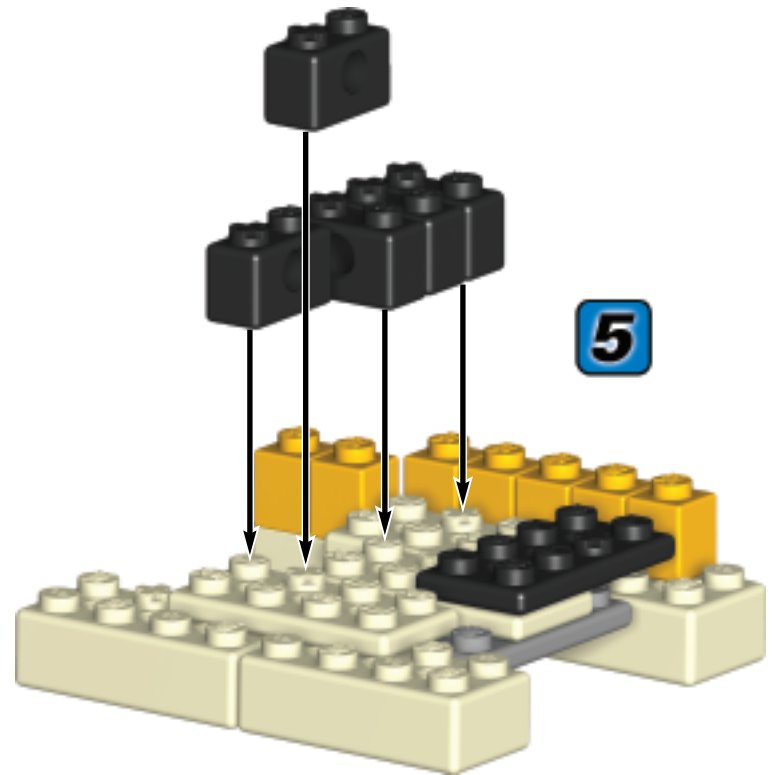
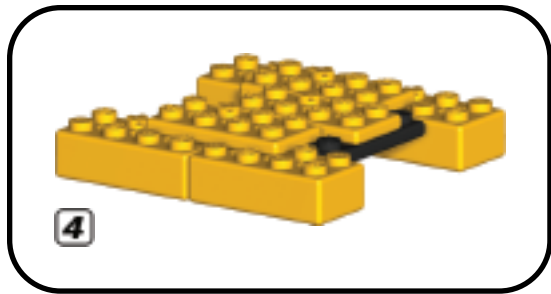
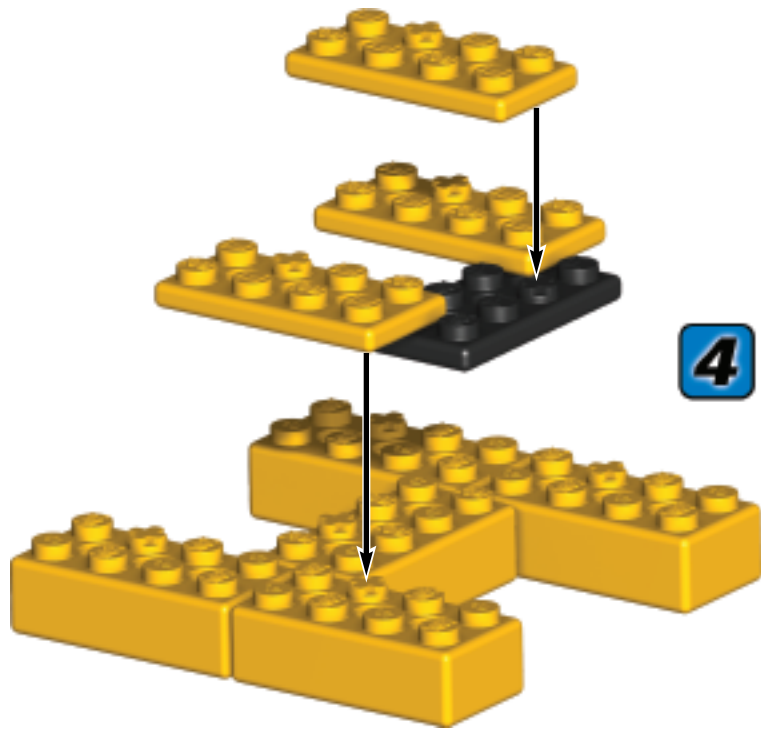

4 5

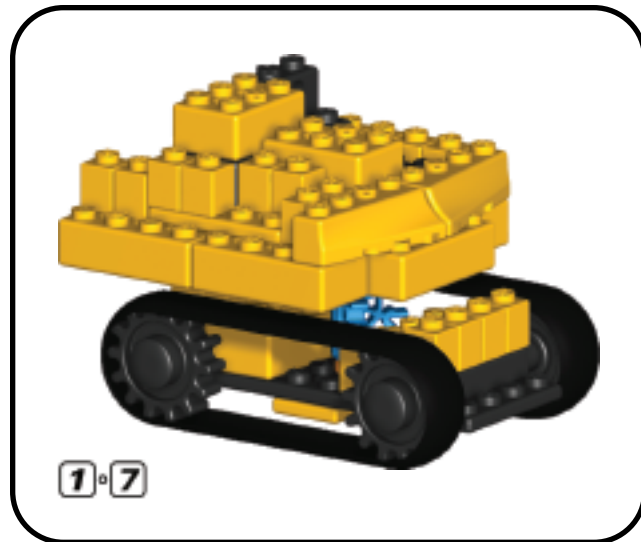
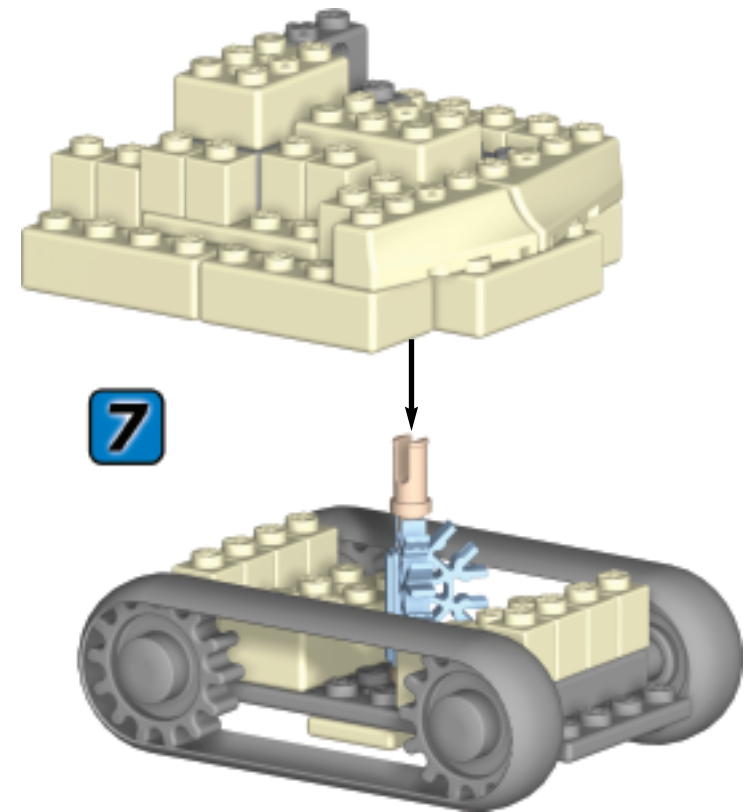
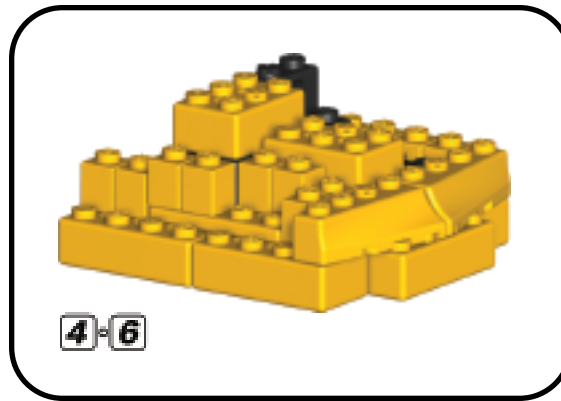
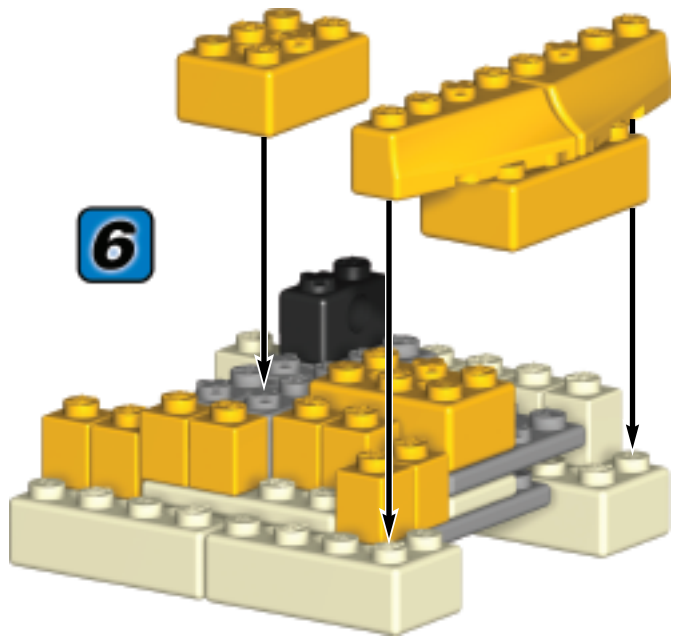

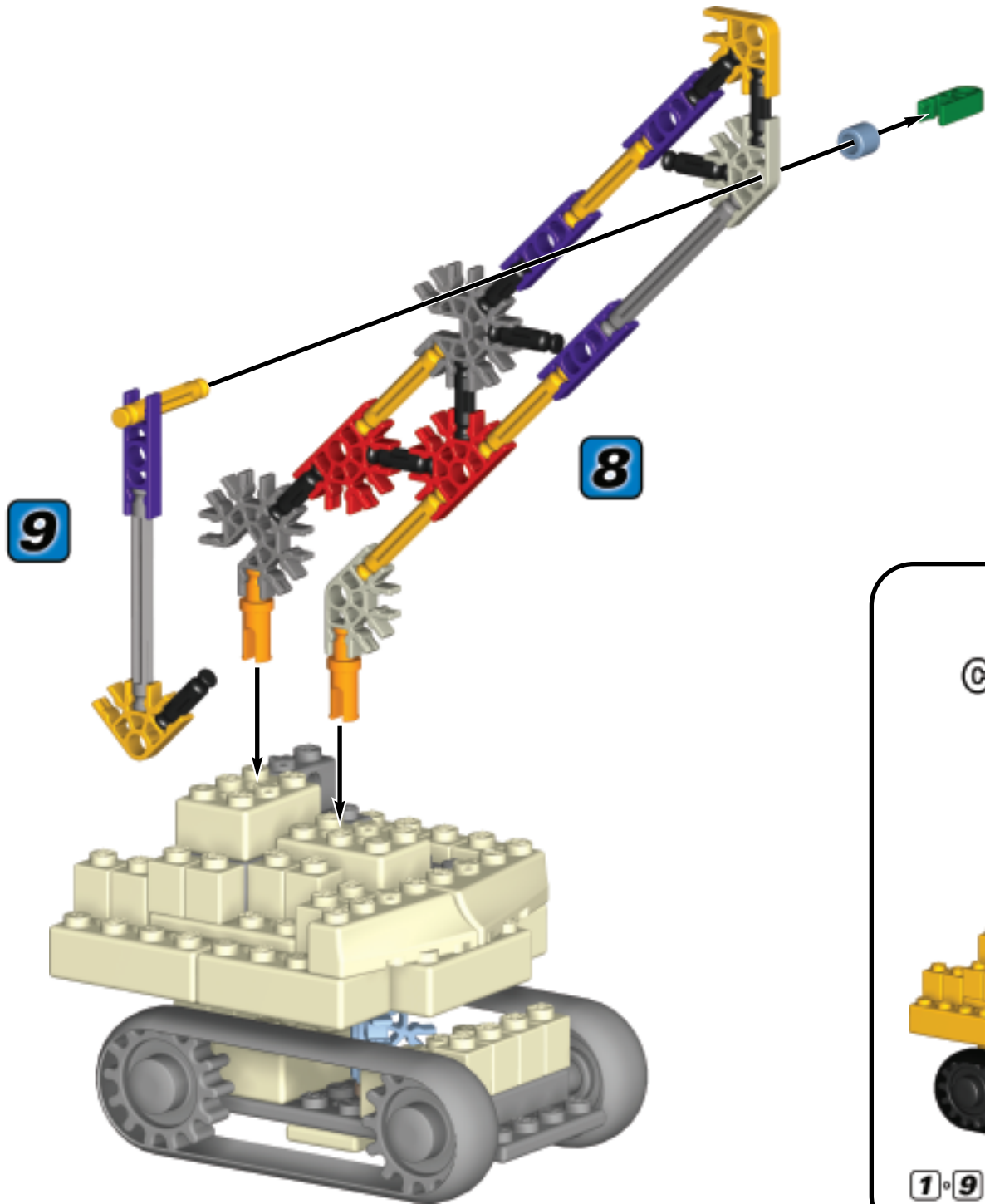

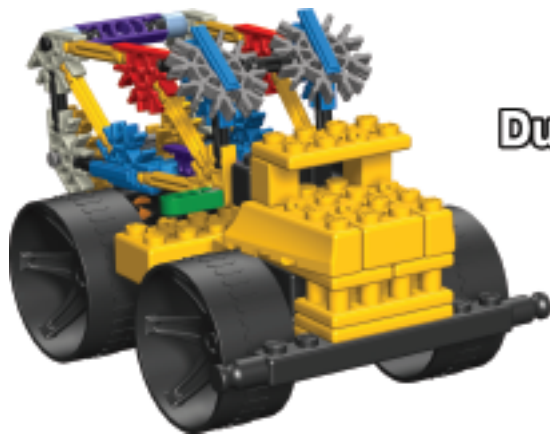

Dump Truck

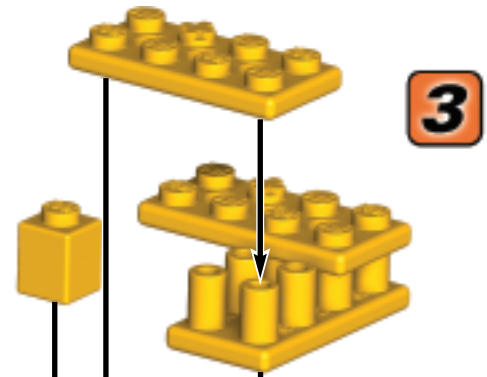
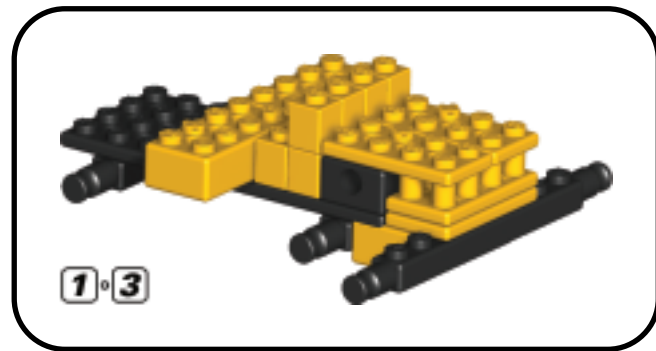
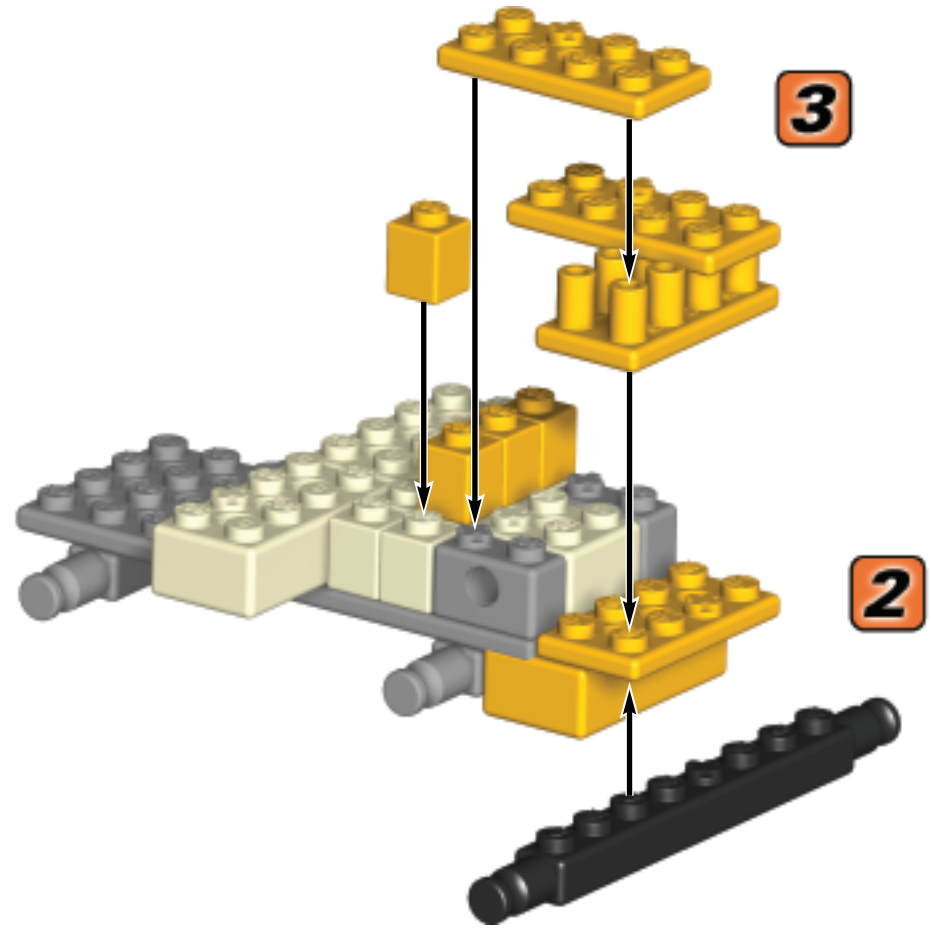
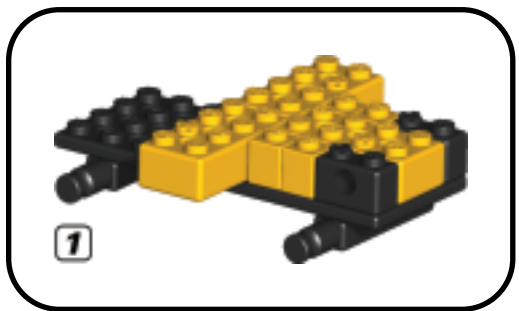
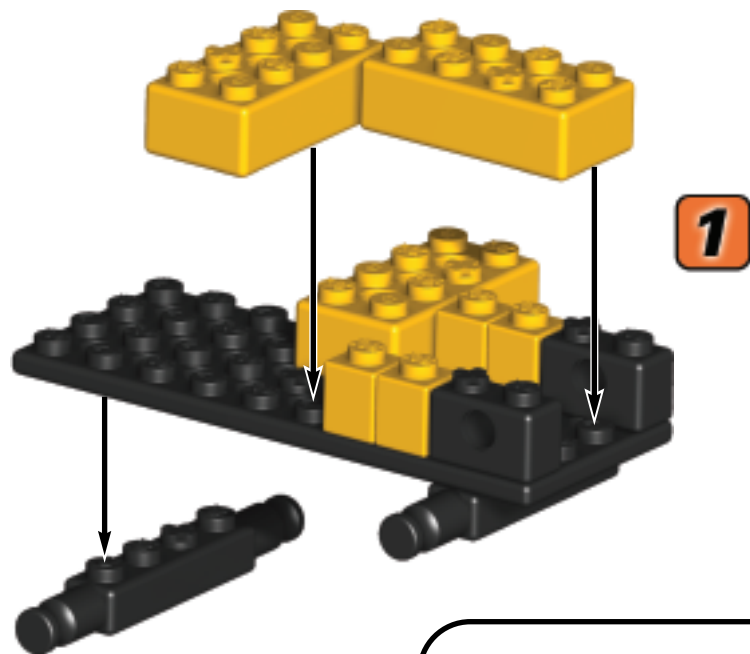

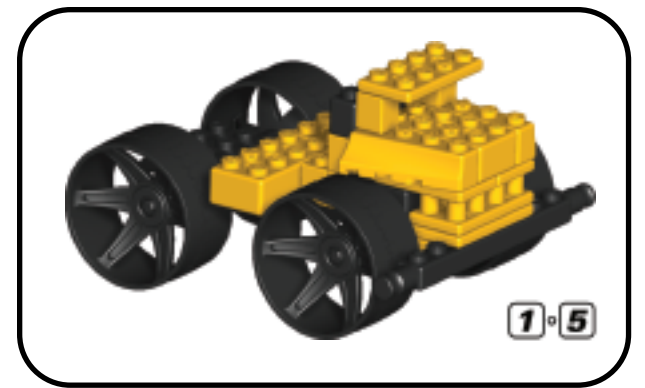
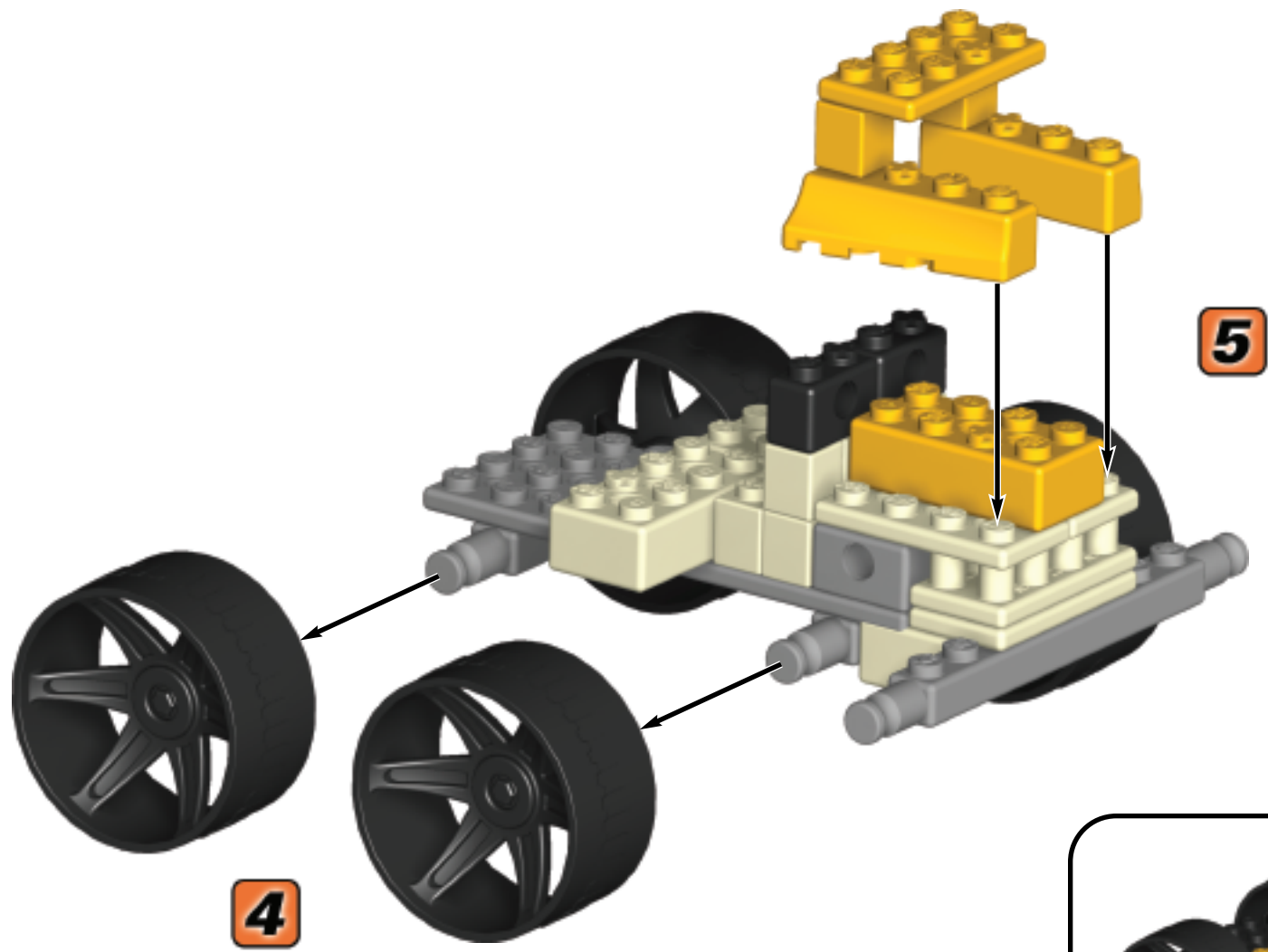

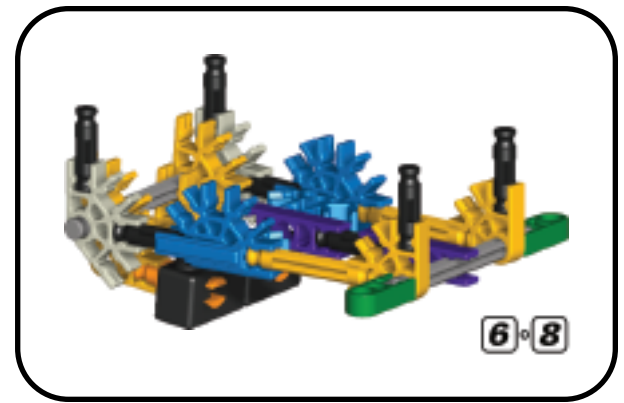
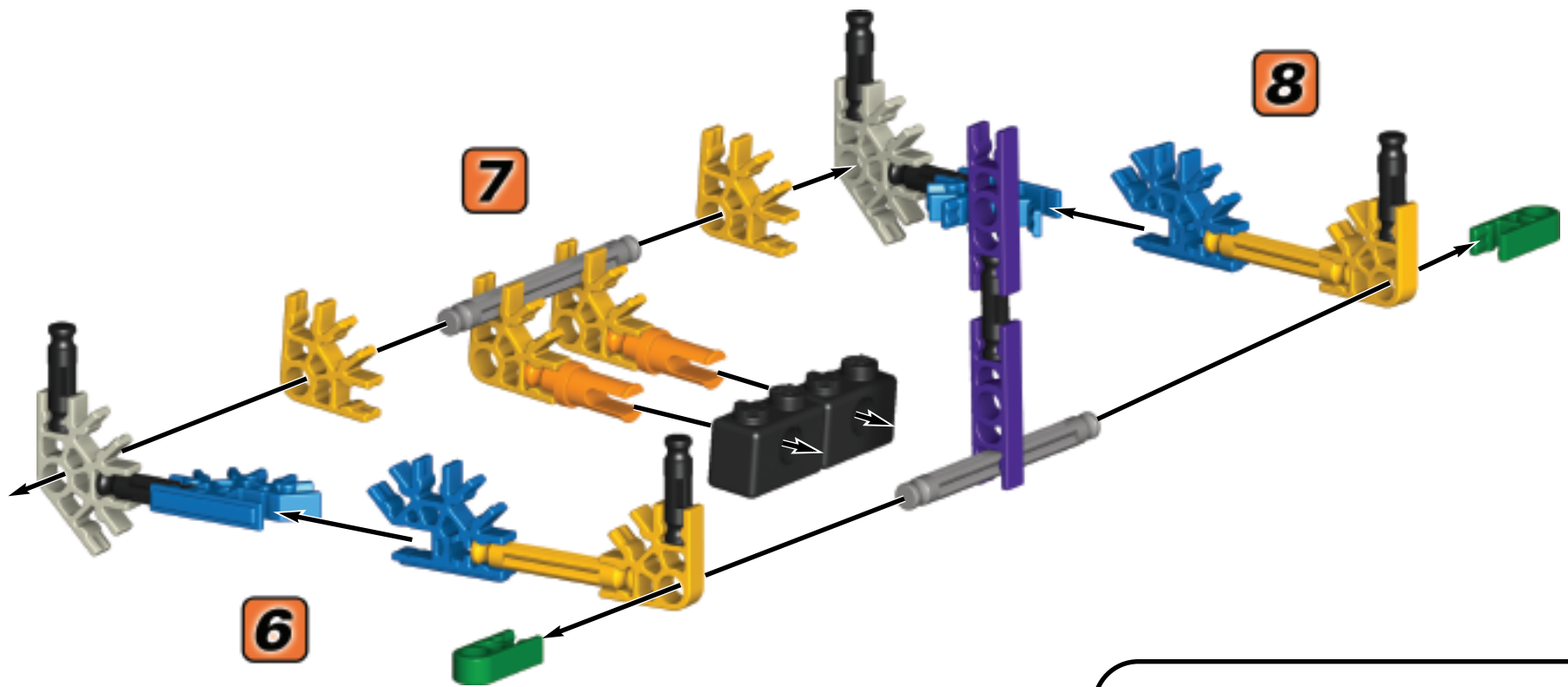

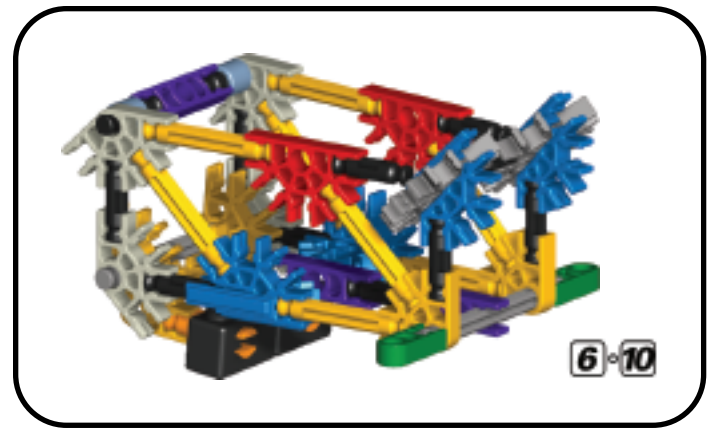
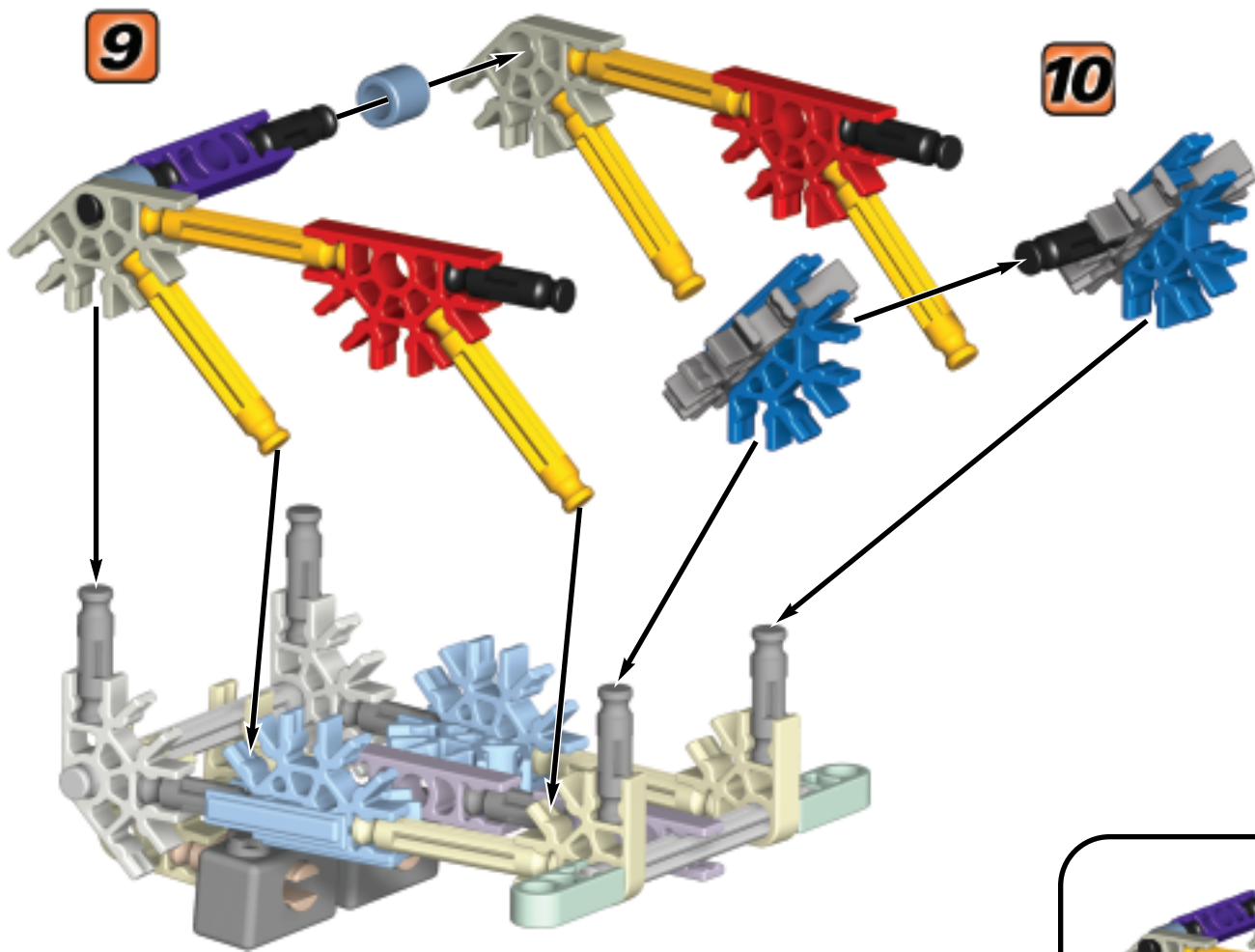

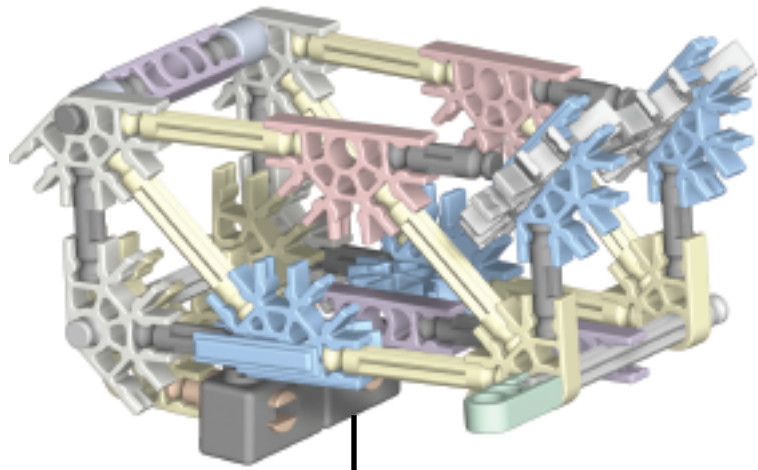

11

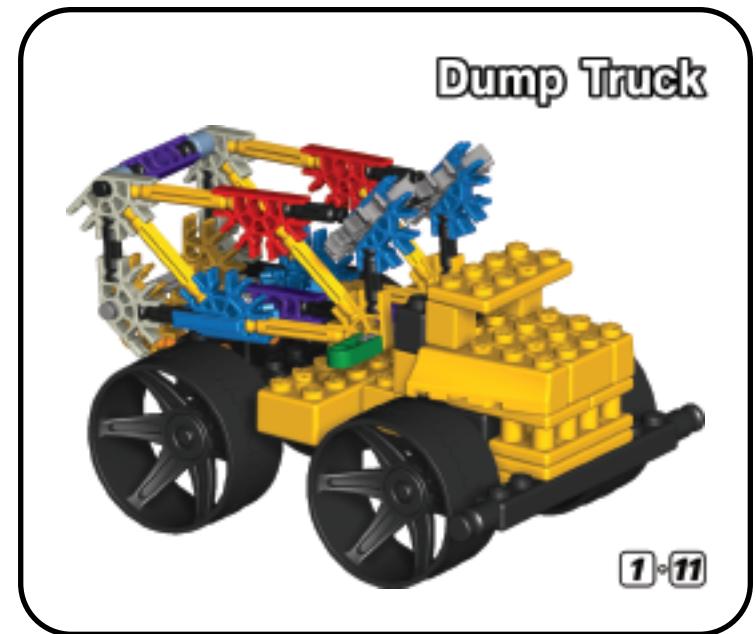
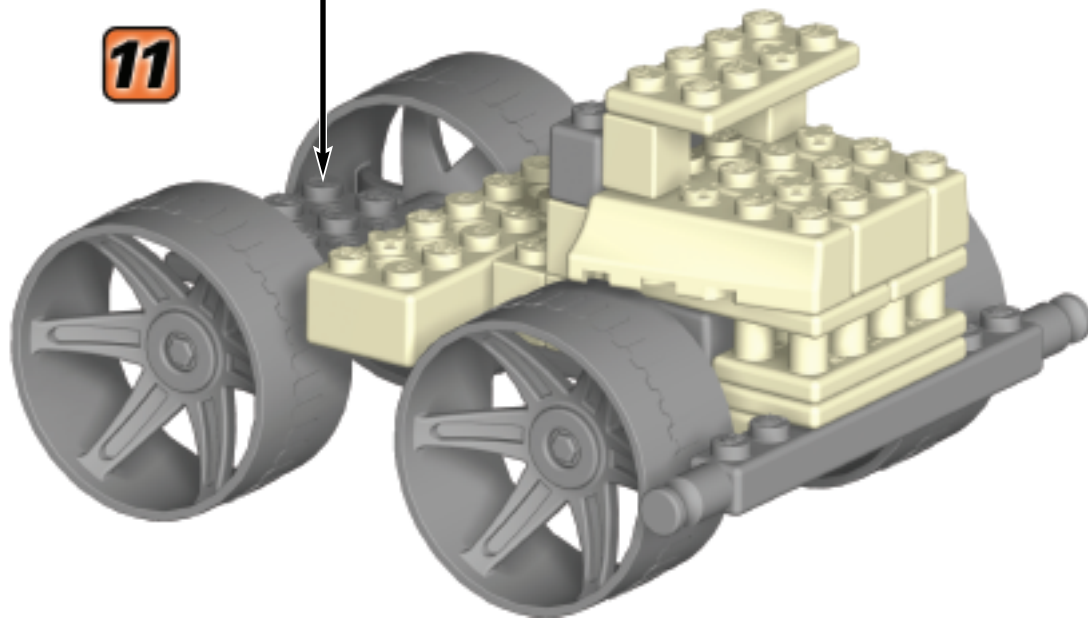



Forklift

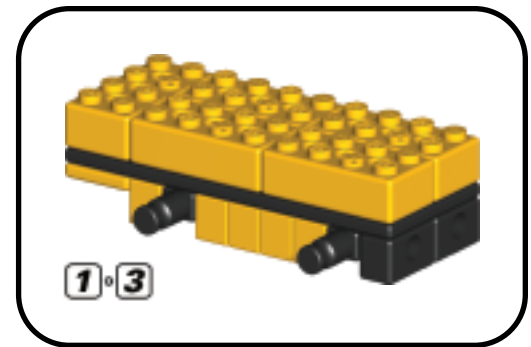
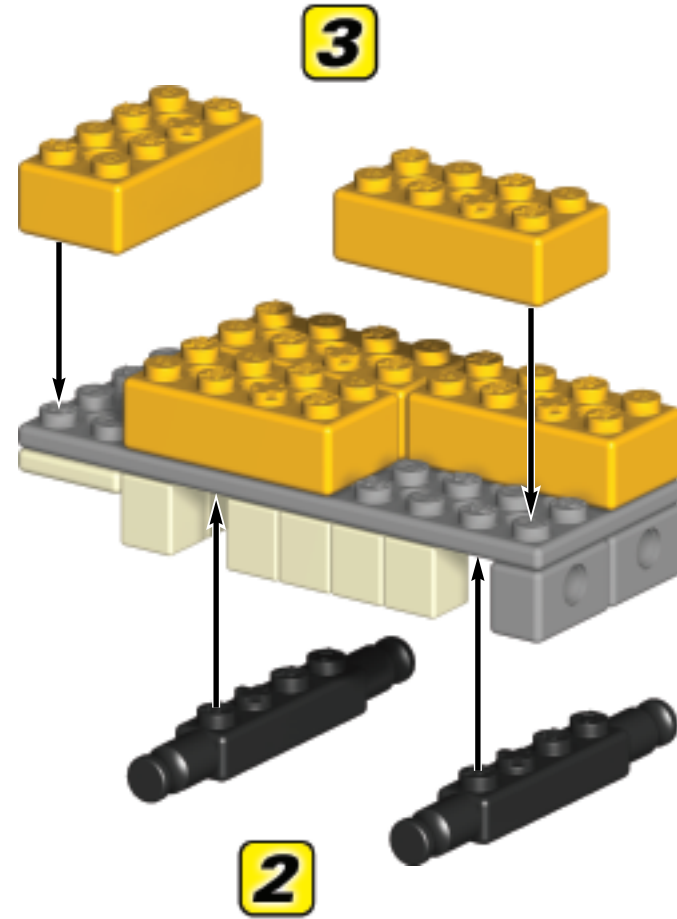
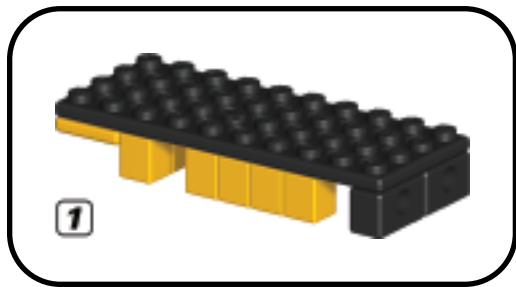
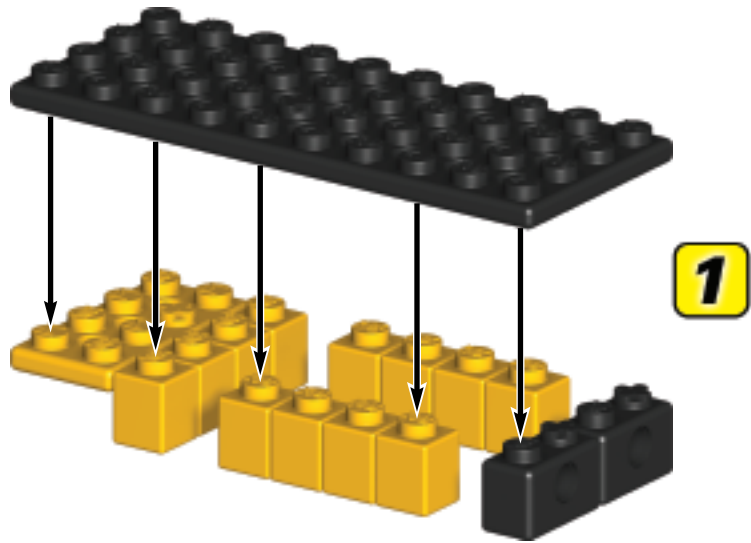

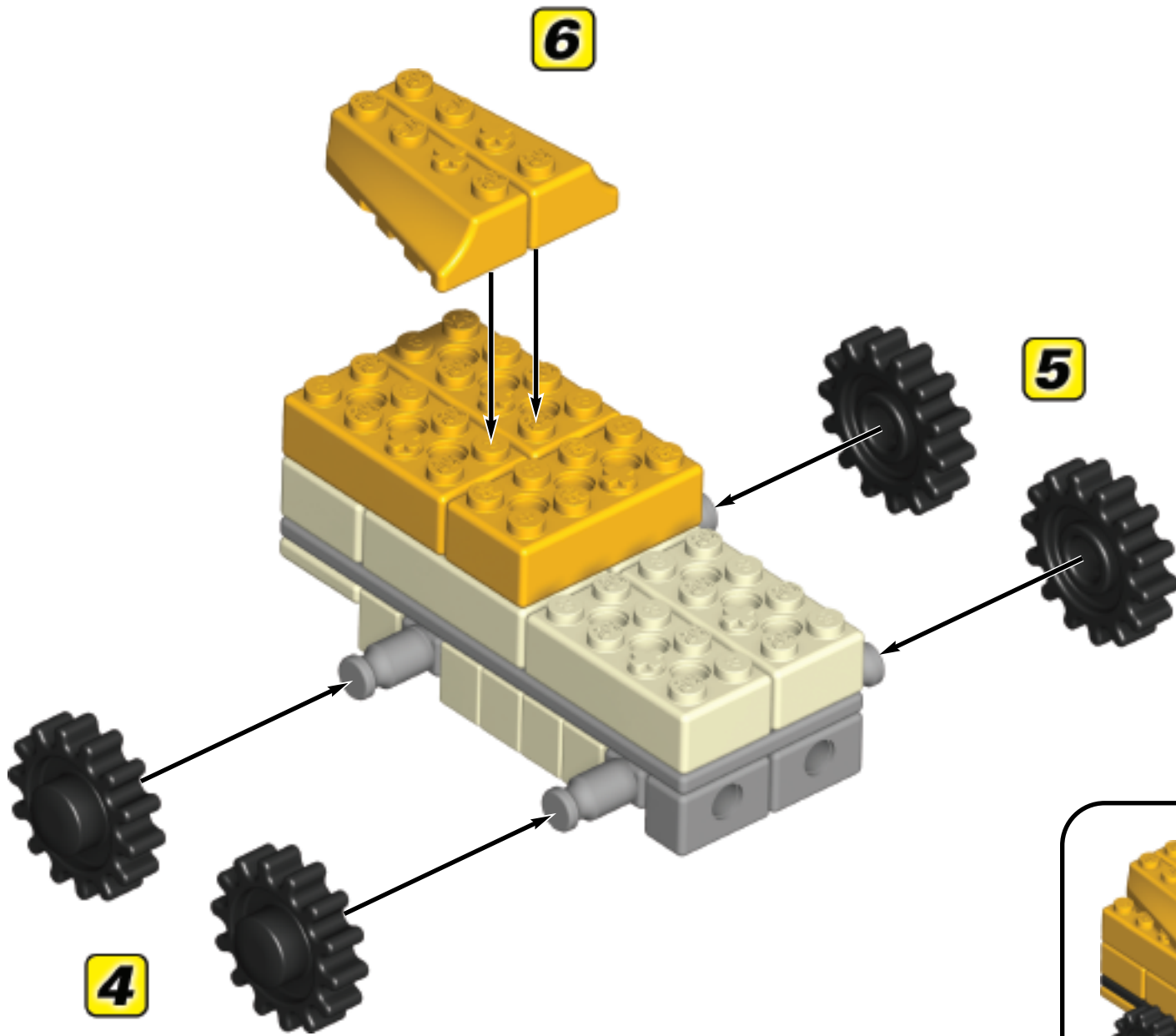

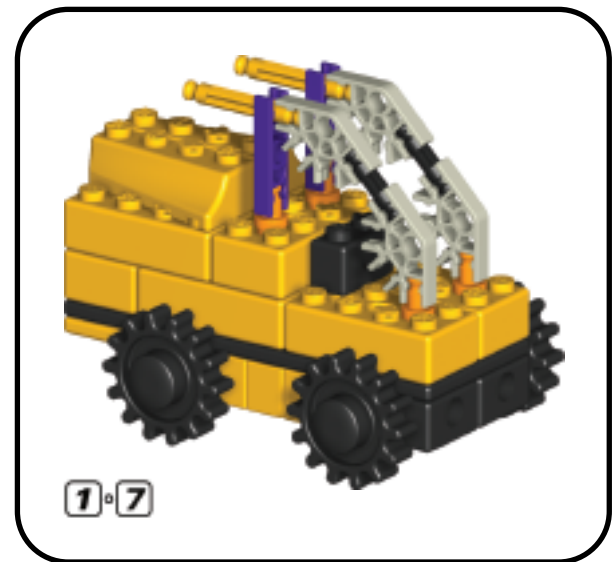
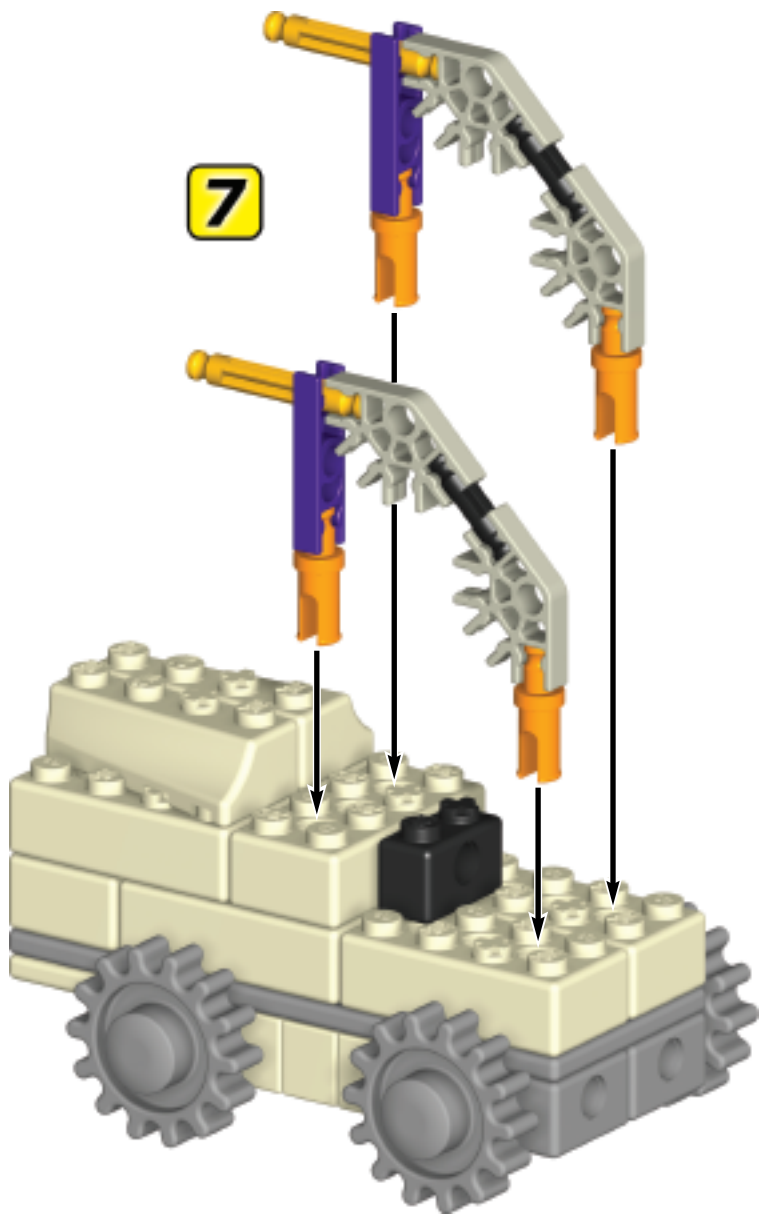

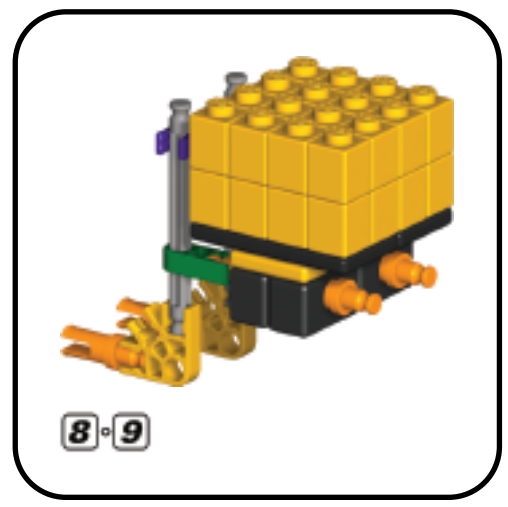
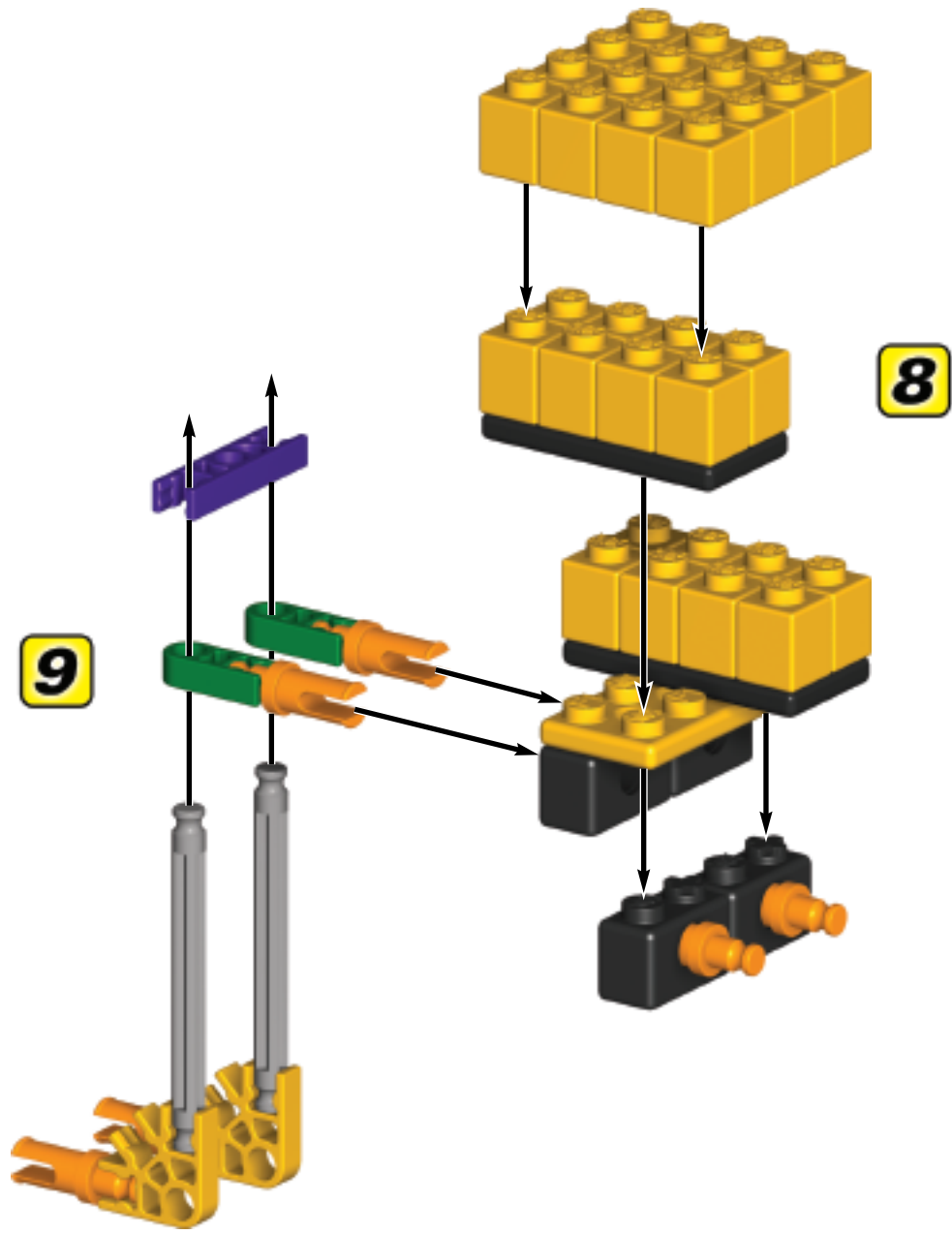

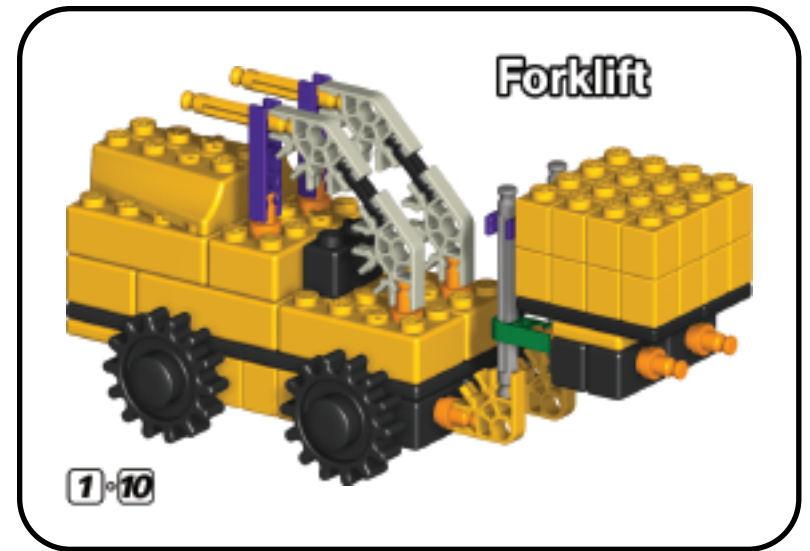
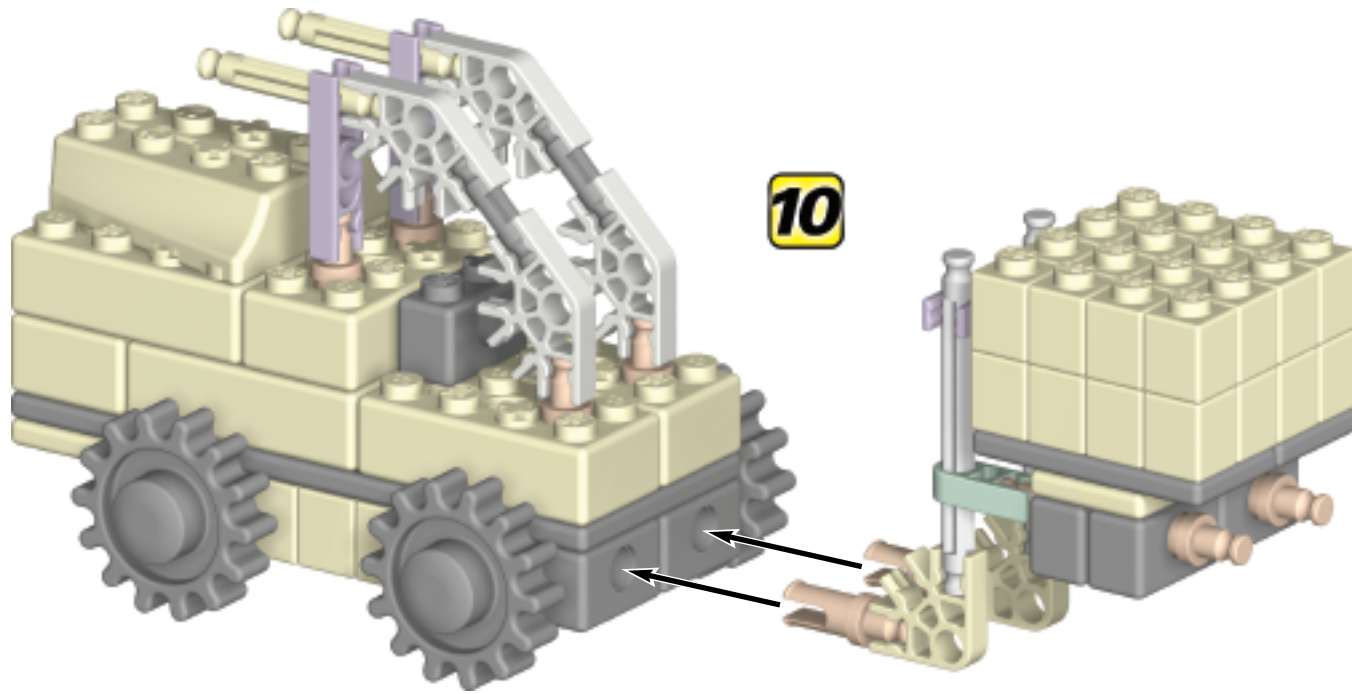

Road Grader



1

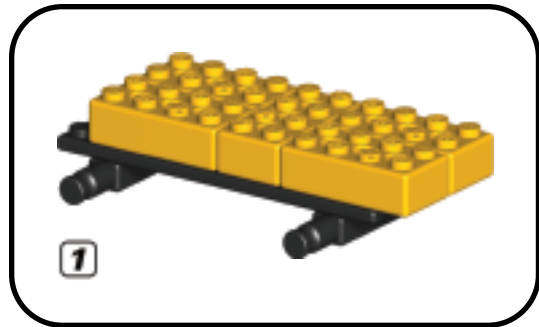
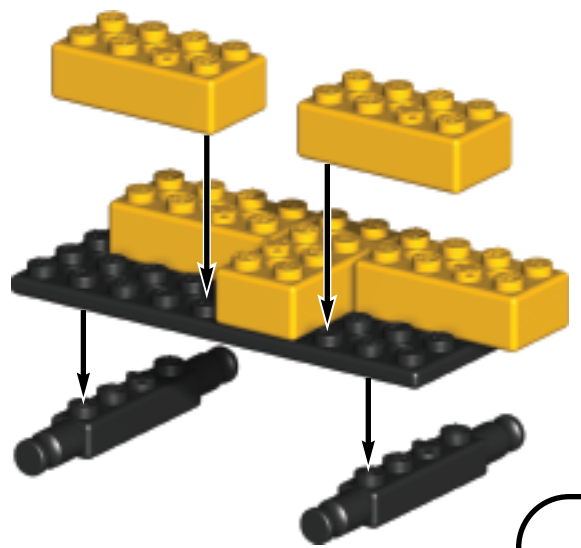

2

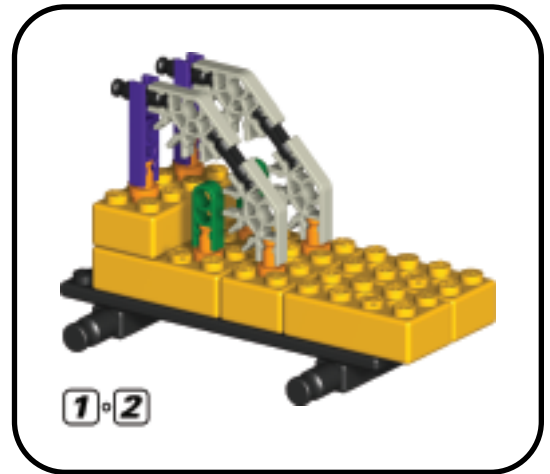
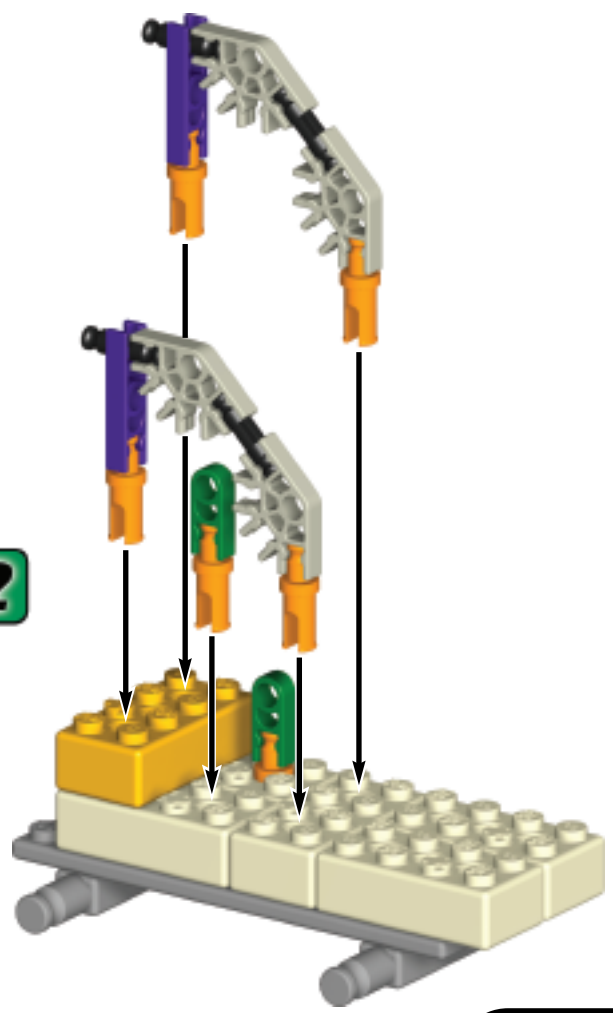

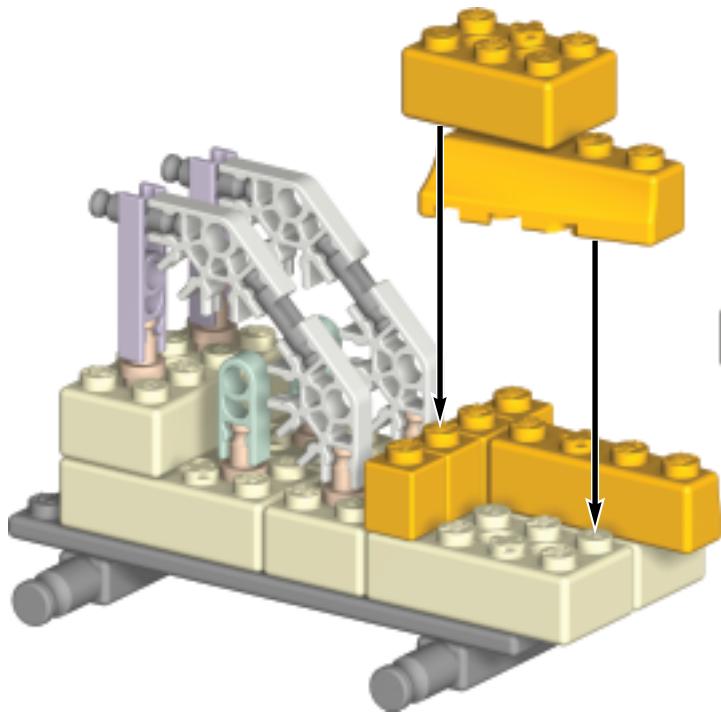

3

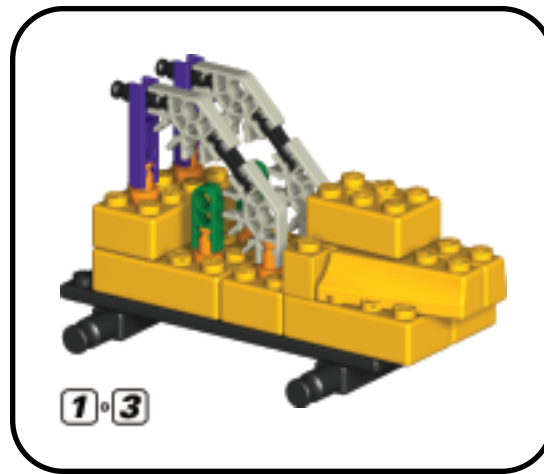

1-3

4

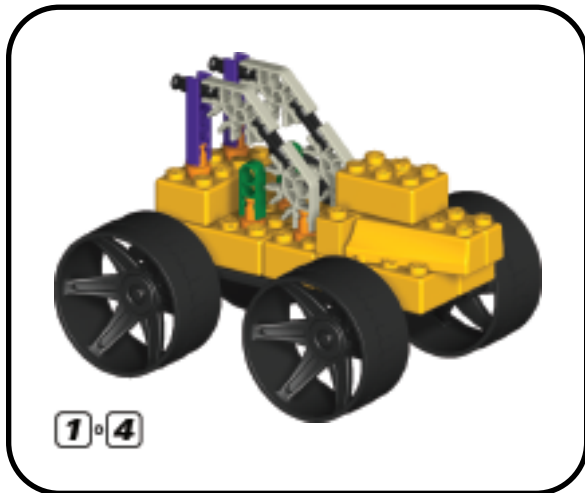
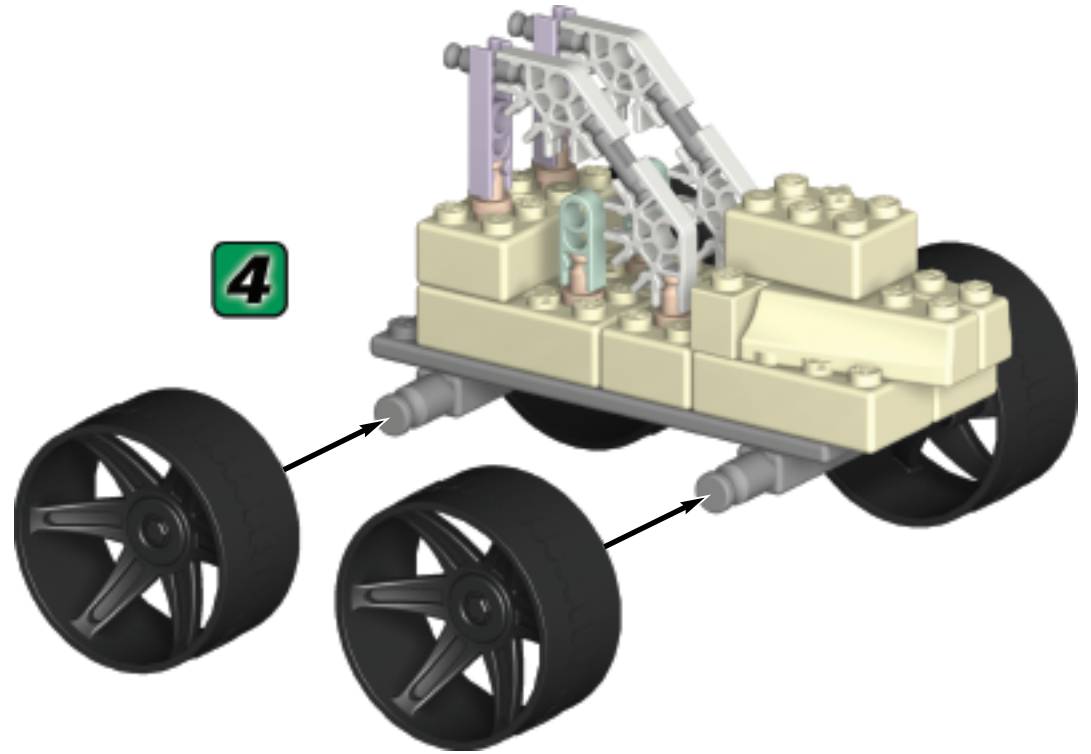

1-4

