

K'NEX

COLLECT & BUILD™

5+

COLLECT ALL 4
COLLECTIONNEZ LES 4



1 EXCAVATOR™



3 STEAM ROLLER™



4 BACKHOE™

*Sold separately
Vendus séparément



CONSTRUCTION
CREW™

2 FRONT LOADER™

⚠ **WARNING:**

CHOKING HAZARD - Small parts.
Not for children under 3 years.

⚠ **AVERTISSEMENT:**

DANGER D'ÉTOUFFEMENT - Pièces de petite taille.
Ne pas donner aux enfants de moins de 3 ans.

11562/71181

K'NEX[®]

COLLECT & BUILD™

5+

CONSTRUCTION CREW™

2 FRONT LOADER™

CONTENTS

FRONT LOADER™ 4
Accessories 14
Languages 14-15

CONTENUS

FRONT LOADER™ 4
Accessoires 14
Langues 14-15



#1 EXCAVATOR™

#3 STEAM
ROLLER™



#4 BACKHOE™

COLLECT ALL 4 COLLECTIONNEZ LES 4



*Sold separately
Vendus séparément
Se venden por separado
Separat erhältlich
Venduti separatamente
Vendidos separadamente
Afzonderlijk verkocht

K'NEX

BUILDING BASICS

Start Building

To begin your model, find step number **1** and follow the numbers. Each piece has its own shape and color. Look at the pictures, find the pieces that match what you see, and connect them together. It helps to face your model in the same direction as the instructions while you build. The arrows show you where the parts connect, but not all connection points have arrows. The faded color parts are the ones you have already put together.

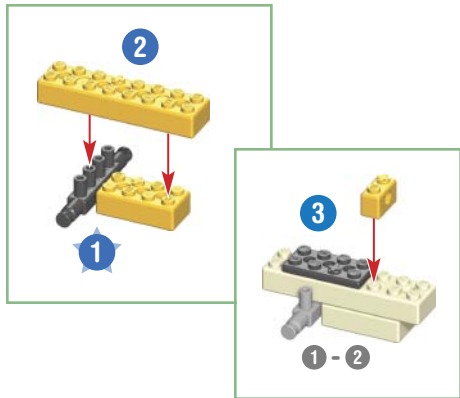

Parts List

Before you start building, be sure to compare the parts in your set with the parts listed here. If anything is missing, call or write to us using the information on the back cover. We're here to help!

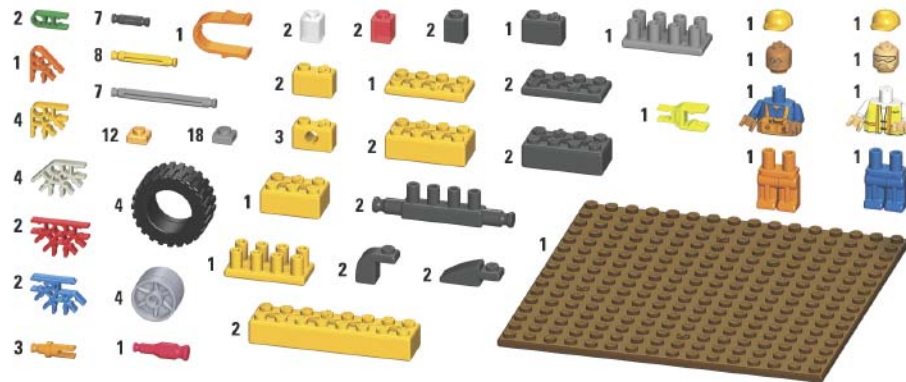

Connectors

You can slide these special connectors together. Push tightly until you hear a "click". Pay close attention to the instructions and position them horizontally or vertically exactly as they are shown.



K'NEX Brick Separator Tool

Use this tool to pull K'NEX bricks apart.



Go to KNEX.COM
for instruction updates

Va à KNEX.COM
pour des mises à jour
des instructions

CONSTRUCTION CREW™

2 FRONT LOADER™

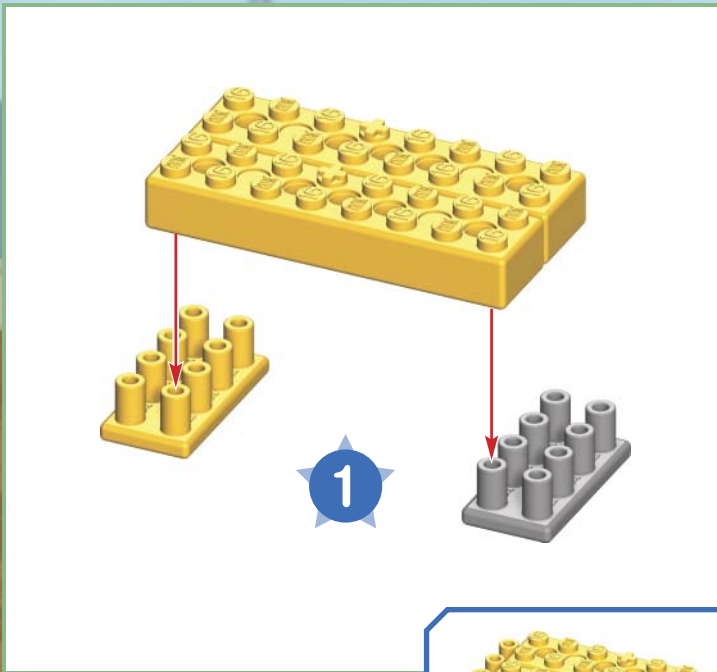

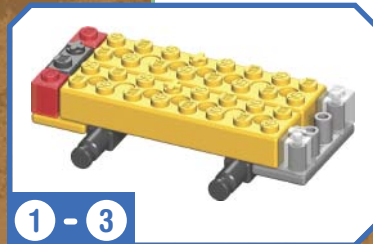
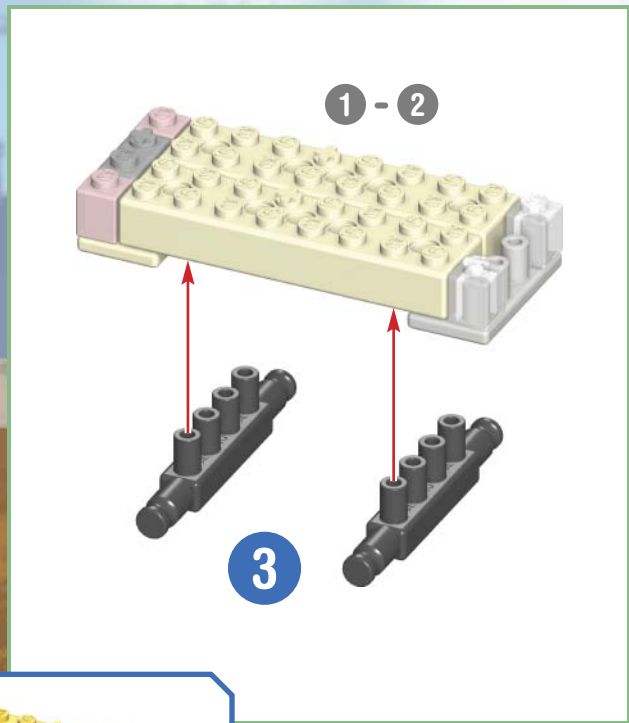
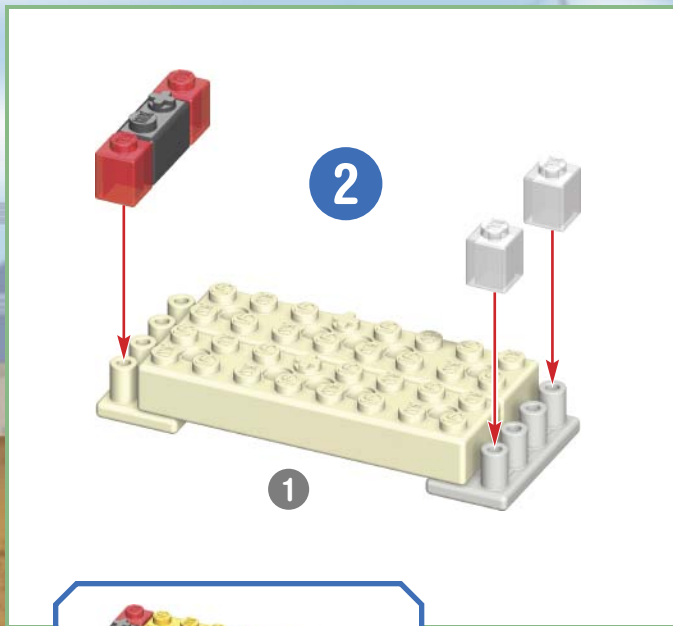

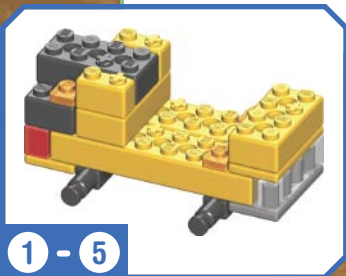
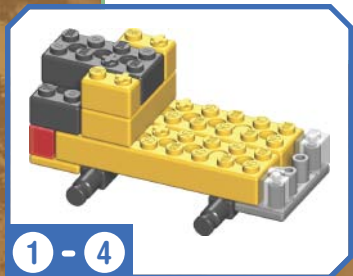
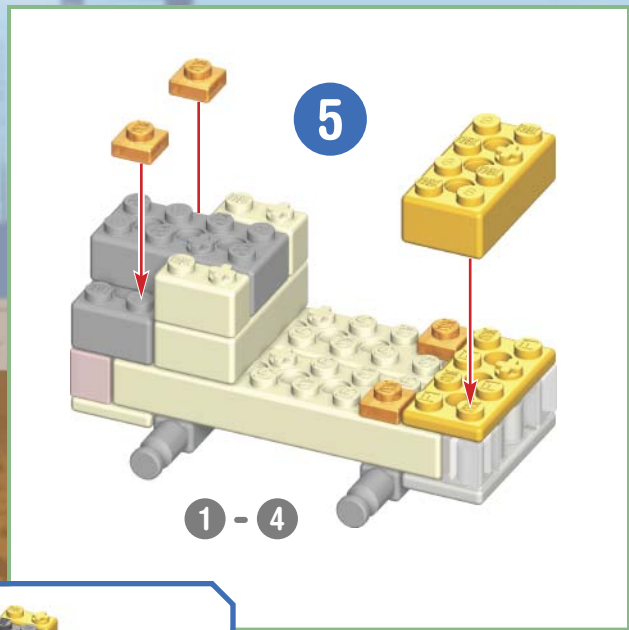
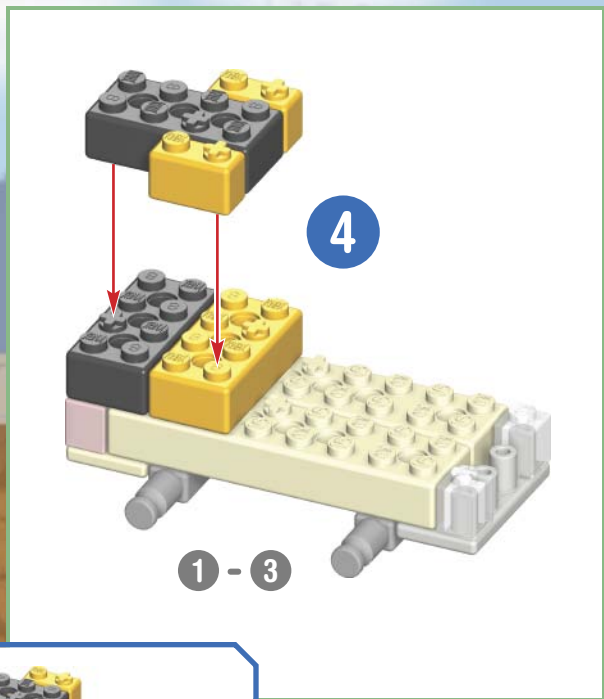

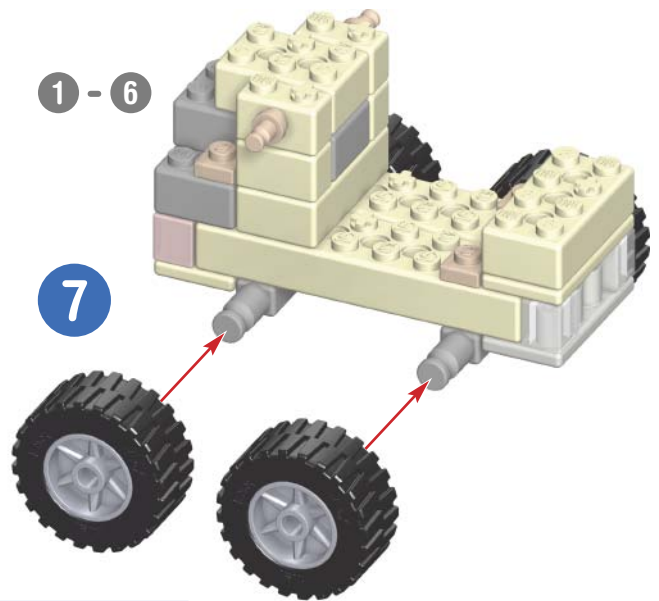
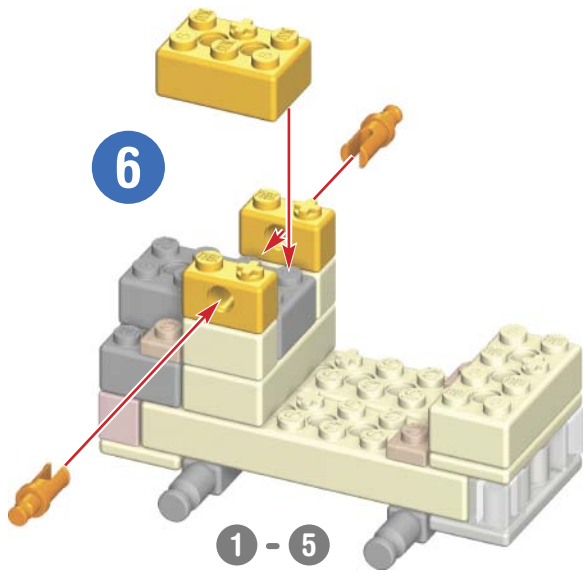

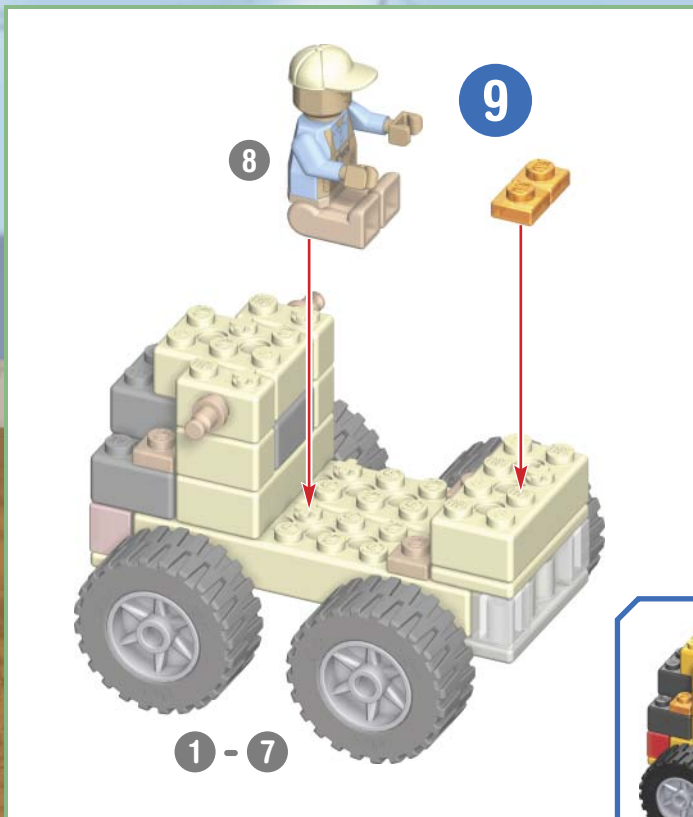
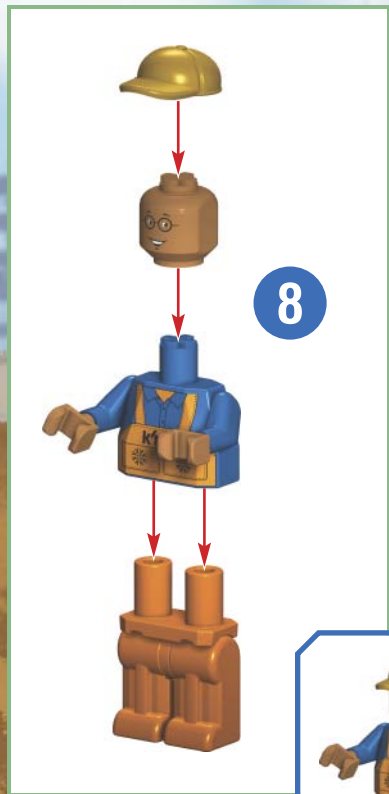

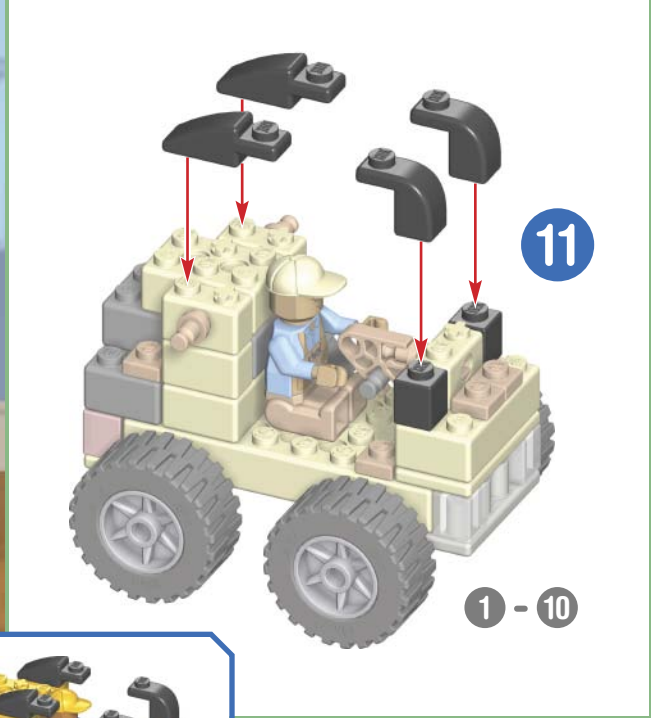
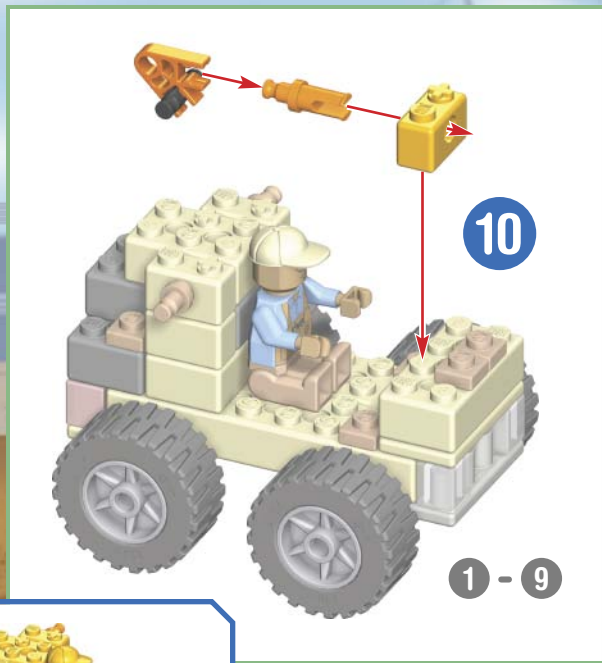

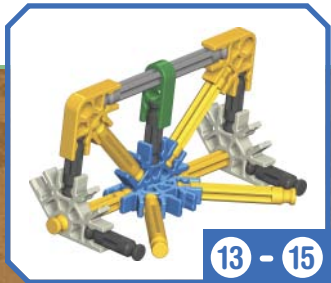
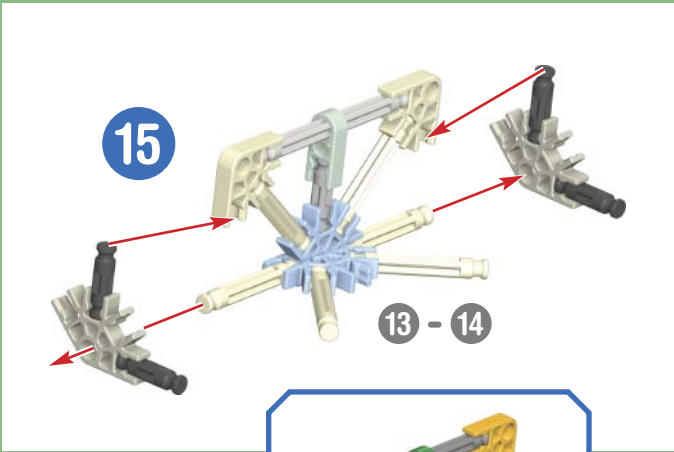
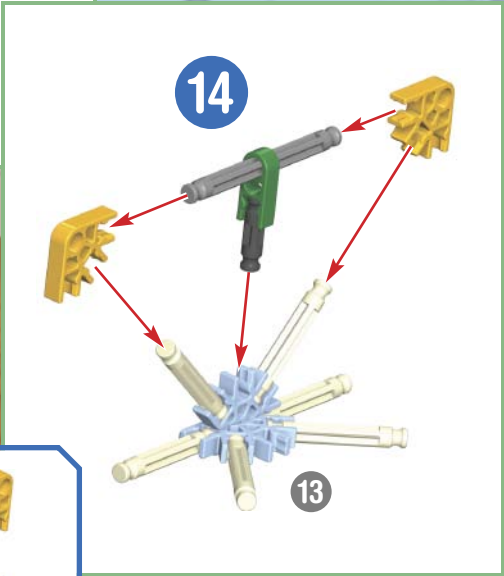
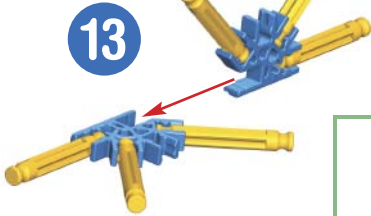

13 - 15

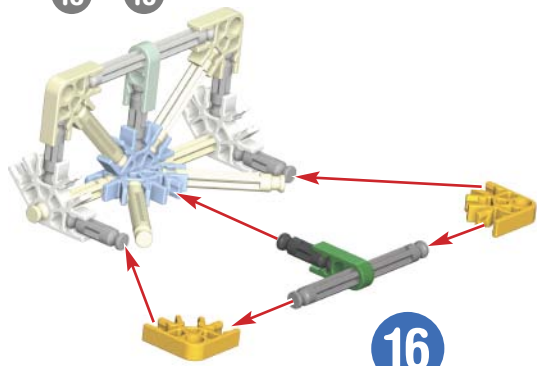

16



13 - 16



13 - 17

17

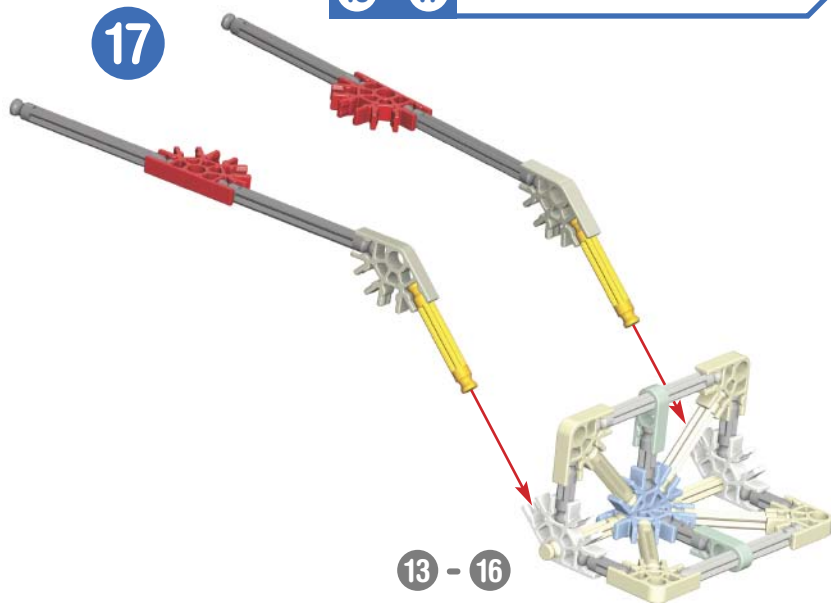

13 - 16

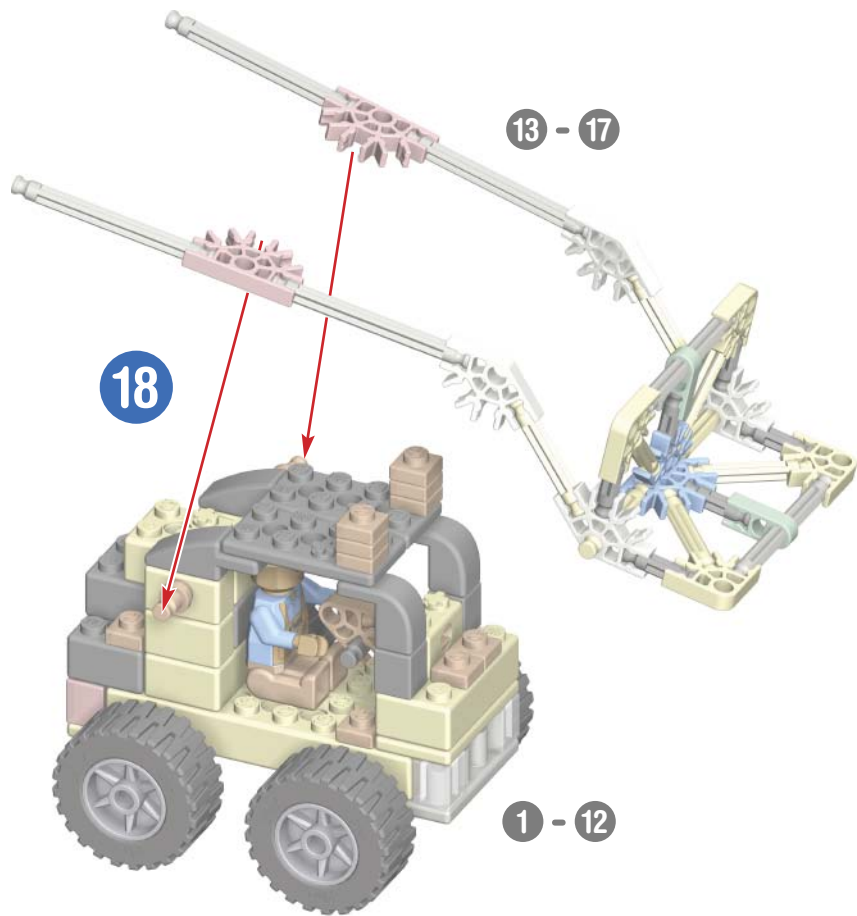

Accessories Accessoires

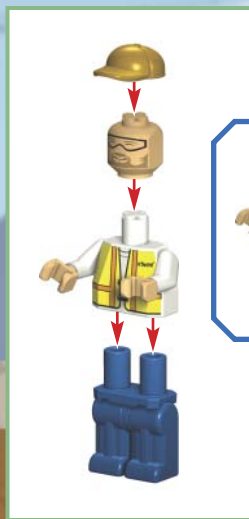
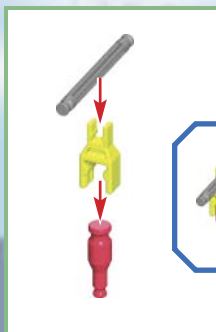

(FR) Français

NOTIONS DE BASE K'NEX POUR LE MONTAGE

Commence la construction

Pour commencer ton modèle, trouve l'étape numérotée **1** et suis les numéros. Chaque pièce a sa propre forme et sa propre couleur. Regarde les illustrations, trouve les pièces qui correspondent à ce que tu vois et assemble-les. Pour t'aider pendant que tu construis, oriente ton modèle dans le même sens que les instructions. Les flèches t'indiquent où les pièces s'assemblent, mais les points de raccordement n'ont pas tous des flèches. Les pièces de couleur délavée sont celles que tu as déjà assemblées.

Liste des pièces

Avant de commencer à construire, assure-toi de comparer les pièces dans ta boîte à la liste de pièces fournie ici. S'il manque quelque chose, téléphone-nous ou écris-nous en te servant des informations figurant au verso de la notice. Nous sommes là pour t'aider !

Connecteurs

Tu peux assembler ces connecteurs tout à fait uniques en les faisant glisser l'un avec l'autre. Pousse fort jusqu'à ce que tu entendes un « clic ». Lis les instructions attentivement et positionne-les horizontalement ou verticalement, en suivant exactement les illustrations.

Outil pour séparer les briques

Sers-toi de cet outil pour détacher les briques K'NEX.



ES Español

Consejos básicos de construcción de K'NEX

A construir

Para empezar tu modelo, es necesario buscar el paso número 1 y seguir los números. Cada pedazo tiene su propia forma y su propio color. Mira las imágenes, busca los pedazos que corresponden con lo que se ve y conéctalos. Durante la construcción, te ayudará si tienes el modelo en la misma dirección que las instrucciones. Las flechas muestran donde las partes se conectan; sin embargo, no todos los puntos de conexión tienen flechas. Las partes descoloradas son las que ya se han conectado.

Lista de piezas

Antes de empezar con la construcción, asegúrate de comparar las piezas en tu conjunto con la lista de las piezas aquí. Si faltan algunas, llámanos o escríbenos siguiendo las instrucciones en la página trasera. Estamos aquí para ayudarte.

Conectores

Se puede juntar estos conectores especiales deslizándolos. Empujar ligeramente hasta oír un "clic". Hace falta prestar mucha atención a las instrucciones y posicionar los conectores horizontal o verticalmente exactamente tal como se muestran.

Separador de ladrillos

Esta herramienta se utiliza para separar los ladrillos K'NEX.

DE Deutsch

Grundlegende Bauanleitungen für K'NEX

Los geht's mit dem Bauen

Beginne mit dem Bauen des Modells beim 1. Schritt und folge den Zahlen. Jedes Teil hat seine eigene Form und Farbe. Schau die Bilder an, suche nach den passenden Teilen zu den Bildern und füge sie richtig zusammen. Halte dein Modell während des Zusammenbaus möglichst genau so wie in der Anleitung. Die Pfeile deuten an, wo die Teile zusammengefügt werden. Allerdings haben nicht alle Verbindungspunkte Pfeile. Die bereits zusammengefügte Teile sind in blassen Farben abgebildet.

Teileliste

Bevor du mit dem Bauen anfängst, solltest du prüfen ob die Teile in deinem Bausatz mit denen auf dieser Teileliste übereinstimmen. Falls etwas fehlt, rufe uns an oder schreibe uns (siehe Rückseite). Wir sind für dich da!

Verbindungsstücke

Diese besonderen Verbindungsstücke kannst du zusammenschieben. Drücke sie fest, bis du ein Klicken hörst. Achte genau auf die Anleitung und positioniere die Verbindungsstücke genau wie in der Abbildung.

Stein-Separator

Mit diesem Werkzeug werden K'NEX-Steine auseinander gezogen.

IT Italiano

Il fondamentale di costruzione di K'NEX

Cominciare la costruzione

Per cominciare il tuo modello, trova il passo numero 1 e segui i numeri. Ogni pezzo ha la sua forma e il suo colore. Guarda le figure, trova i pezzi che corrispondono a ciò che vedi e congiungili insieme. È un aiuto se tieni il tuo modello di fronte a te nella stessa direzione delle istruzioni mentre costruisci. Le frecce ti indicano dove sono congiunte le parti ma non tutti i punti di congiunzione hanno le frecce. Le parti con i colori sbiaditi sono quelle che hai già messo insieme.

Elenco delle parti

Prima di cominciare a costruire, accertati di confrontare le parti che sono nel tuo set con l'elenco delle parti qui. Se ne manca una chiamaci o scrivici usando le informazioni che sono nella retrocopertina. Noi siamo qui per aiutarvi!

Connettori

Puoi infilare insieme questi connettori speciali. Spingi bene finché non senti un "clic". Fa' ben attenzione alle istruzioni e mettili orizzontalmente o verticalmente esattamente come viene mostrato.

Arnese per separare i mattoncini

Usa questo arnese per smontare i mattoncini K'NEX.

PT Português

Fundamentos de Construção K'NEX

Inicia a construção

Para iniciares a construção do teu modelo, procura a etapa 1 e segue os números. Cada peça tem a sua própria configuração e cor. Observa as ilustrações, procura as peças que correspondem ao que estás a ver e liga umas às outras. É mais fácil se estiveres virado para o modelo na mesma direcção mostrada nas ilustrações durante o processo de construção. As setas mostram os pontos onde as peças são conectadas, mas nem todos os pontos de conexão possuem setas. As peças com cores desbotadas pertencem às secções que já foram coordenadas.

Lista de peças

Antes de iniciares a construção, certifica-te de que comparas as peças do teu conjunto com a lista das peças aqui. Se faltar alguma peça telefona ou escreve-nos usando as informações indicadas na contracapa. Estamos aqui para te ajudar!

Conectores

Podes fazer deslizar estes conectores especiais em conjunto. Empurra com força até escutares um "estalido". Presta muita atenção às instruções e posiciona-as na horizontal ou na vertical, exactamente como são mostradas.

Ferramenta separadora dos cubos

Usa esta ferramenta para separares os cubos K'NEX.

NL Nederlands

Basisstappen voor K'NEX bouwen

Begin te bouwen

Om je model te beginnen, moet je eerst stap nummer 1 vinden en dan de nummers volgen. Elk stuk heeft zijn eigen vorm en kleur. Kijk naar de prentjes, vind de stukken die overstemmen met wat je ziet, en maak zeean mekaar vast. Het helpt wanneer je model dezelfde richting volgt als de aanwijzingen terwijl je bouwt. De pijlen duiden je aan waar de onderdelen zich vasthechten, maar niet alle hechtingspunten hebben pijlen. De onderdelen met afnemende kleur werden reeds eerder aan mekaar vastgemaakt.

Onderdelenlijst

Voor je begint te bouwen, vergewis je ervan de onderdelen in je geheel na te gaan met de onderdelenlijst hier. Wanneer iets ontbreekt, bel ons op of schrijf ons door gebruik te maken van de informatie op het achterblad. We staan er om je te helpen!

Verbindingstukken

Deze speciale verbindingsstukken kunnen in mekaar geschoven worden. Druk ze goed tezamen tot wanneer je een "klik" hoort. Geef goed aandacht aan de aanwijzingen en richt ze horizontaal of vertikaal af, precies zoals afgebeeld.

Scheidingsinstrument voor de stenen

Gebruik dit instrument om de K'NEX stenen uit mekaar te halen.

KNEX.COM

K'NEX Customer Service. Call 1-800-KID-KNEX (USA/CAN only); Write to email@knex.com; Visit www.knexus.com
For Customer Service outside USA/CAN contact your local distributor at: <http://www.knexus.com/distributors>
(FR) Le Service clients hors d'USA/CAN, s'il vous plaît contacter le distributeur local.
L'information de distributeur peut être trouvée à <http://www.knexus.com/distributors>
(AZ) (NZ) (UK) (DE) (NL) (BE) (CH) (CL) (PE) <http://www.knexus.com/distributors>
(UK) TOMY Careline, PO Box 20, Totton, Hants, SO40 3YF; Tel 023 8066 2600
(FR) ALLO TOMY SAV, Parc d'affaires international, 74166 ARCHAMPS; Tél 0 820 013 013
(UK) (FR) (DE) (NL) <http://www.tomy.eu>



Look At Our Collect And Build Toys! Regardez Notre Recueillent Et Construisent des jouets !



* Sold separately
Vendus séparément
Se venden por separado
Separat erhältlich
Venduti separatamente
Vendidos separadamente
Afzonderlijk verkocht



- Identifies Genuine K'NEX Bricks.
- Identifie que ce sont d'authentiques briques K'NEX.
- Identifica los ladrillos genuinos de K'NEX.
- Identifiziert echte K'NEX-Bausteine.
- Identifica i veri blocchi K'NEX.
- Identifica que são cubos genuinos da K'NEX.

Product & colors may vary. Most models can be built one at a time. Standard K'NEX parts made in the USA.
Produits et couleurs peuvent varier. La plupart des modèles ne peuvent être construits que un à un. Pièces K'NEX courantes fabriqués aux États-Unis. El producto y los colores pueden variar. La mayoría de los modelos se pueden construir uno a la vez. Manufactured under U.S. Patents/Fabriqués sous brevets américains/Fabricado bajo patentes de EE.UU. 5,061,219; 5,199,919; 5,350,331; 5,137,486; 7,267,598; D553,204. Other U.S. and foreign patents pending. Autres brevets américains et étrangers en instance. Otras patentes de EE.UU. y países extranjeros pendientes. Community design/Le dessin ou modèle communautaire/Diseño de comunidad No. 000 645338-001-0002.

© 2009 K'NEX Limited
Partnership Group
P.O. Box 700
Hatfield, PA 19440-0700
410015-V1-07/09