

THE SIDEWINDER™

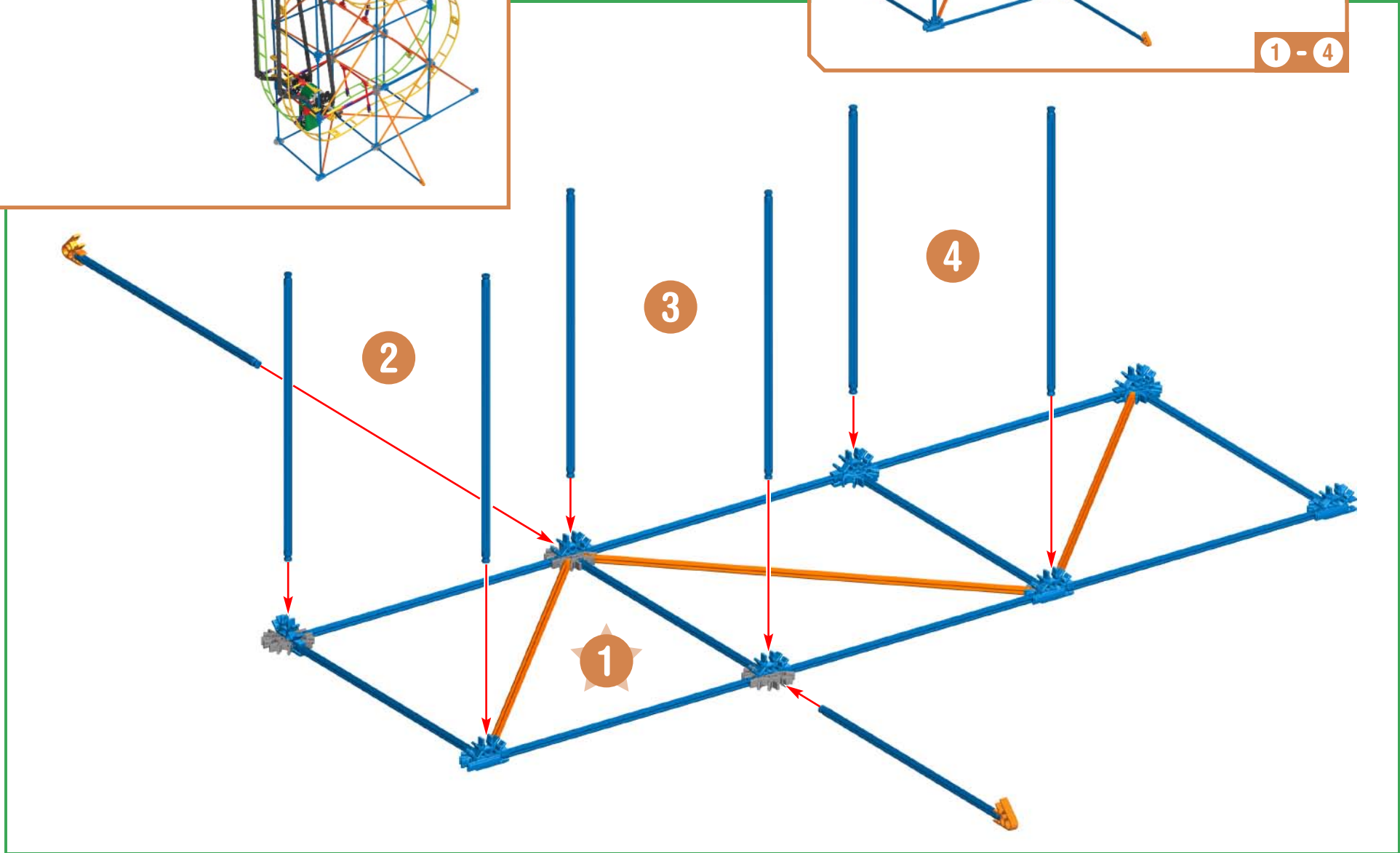

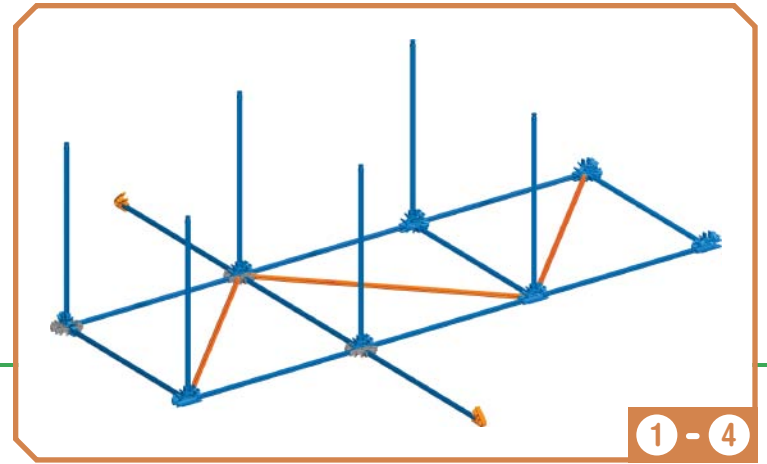

Did you install 2 AA (or LR6) batteries in the motor?

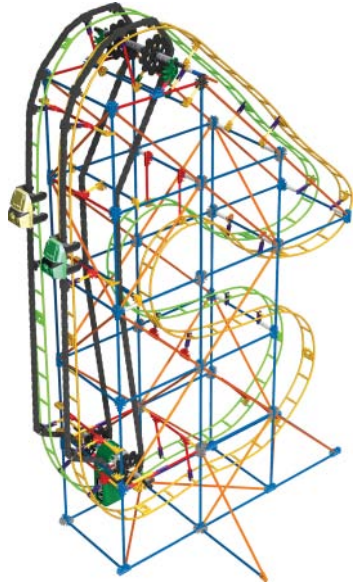
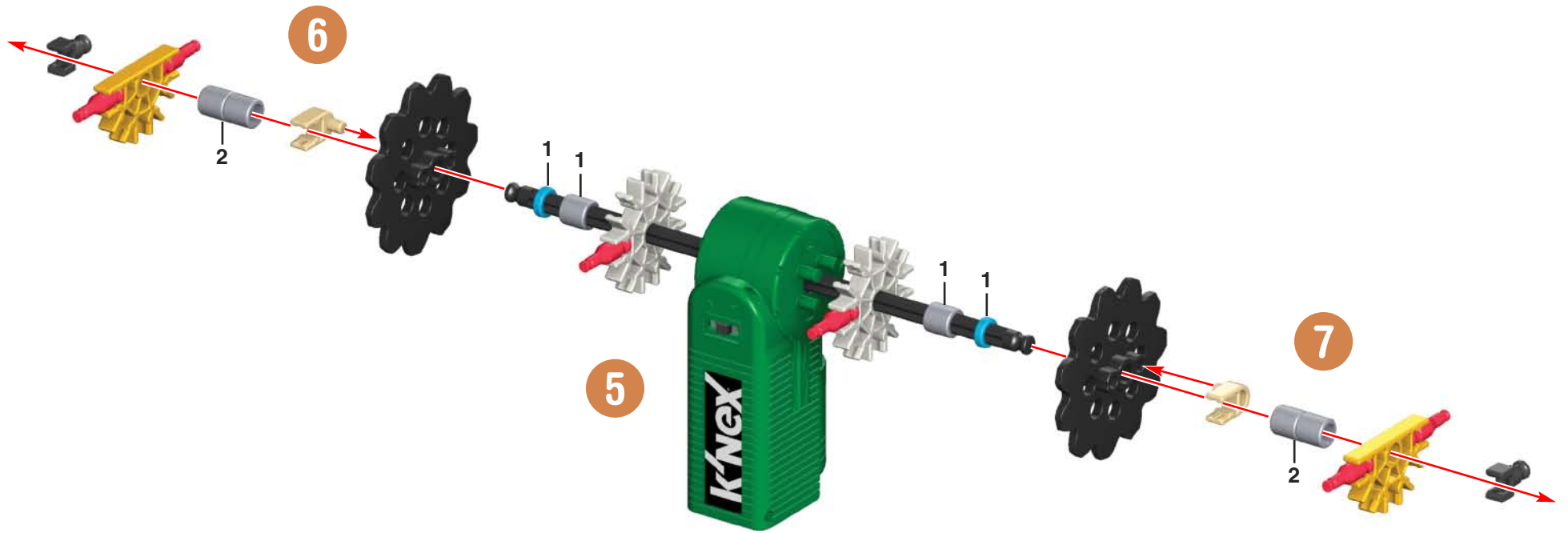

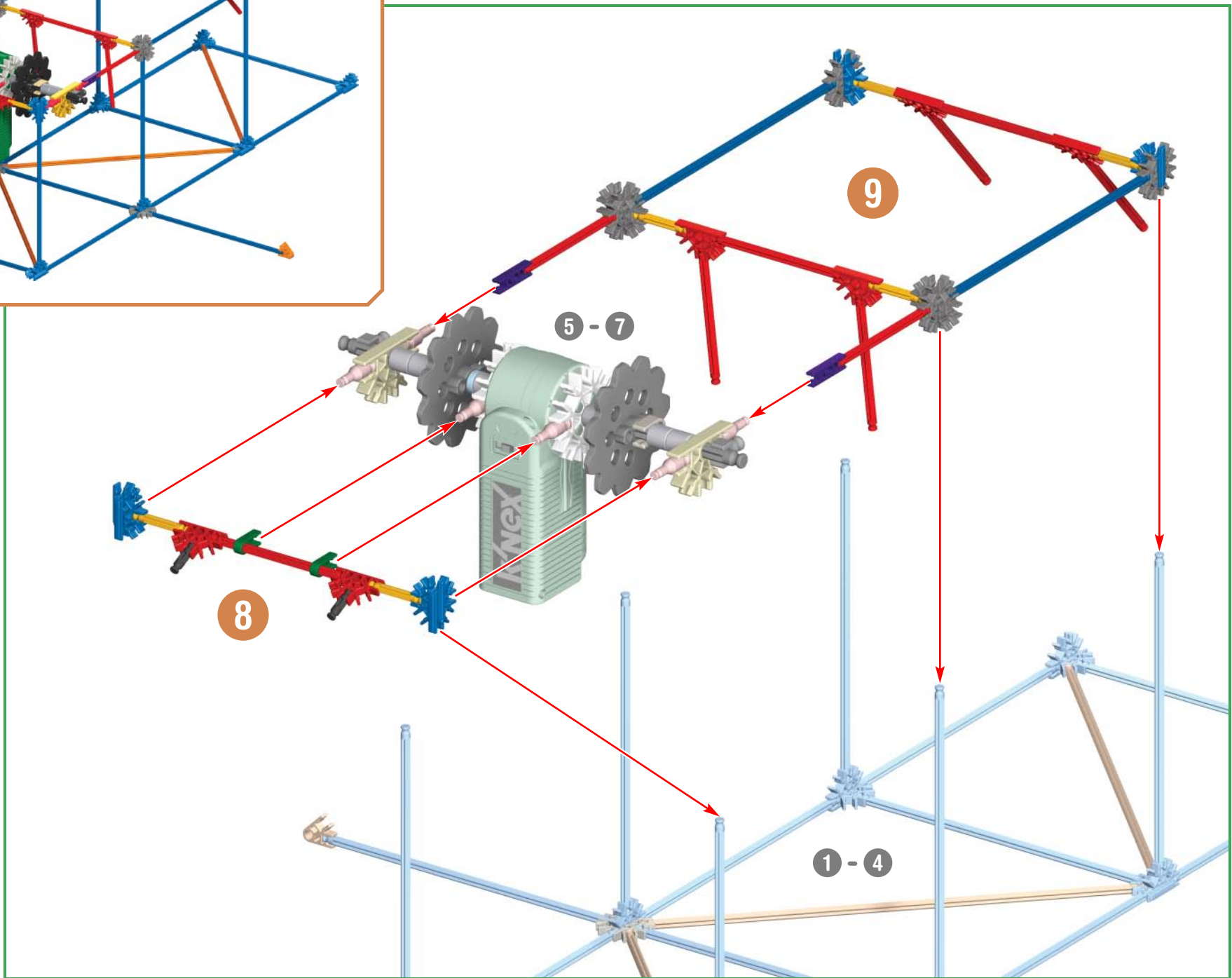
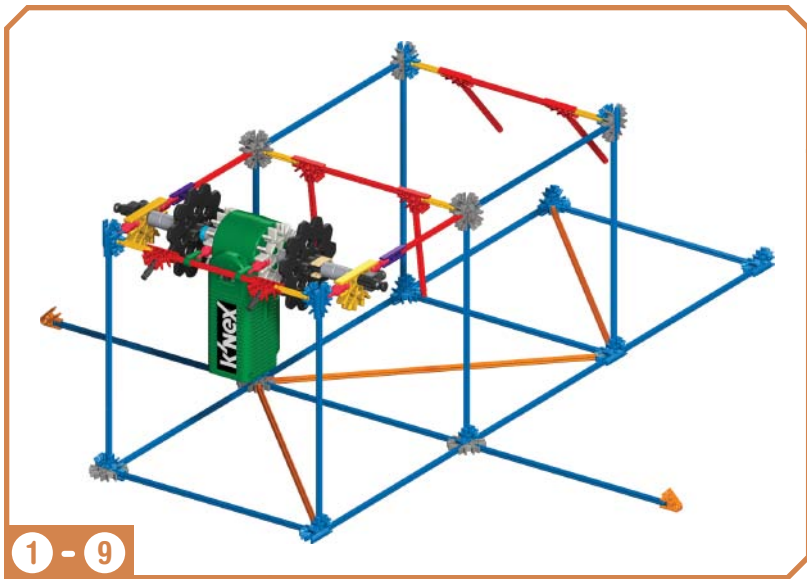

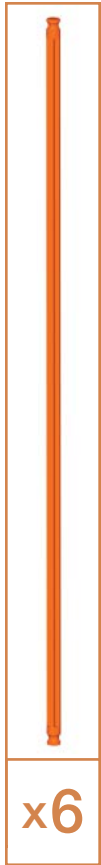

10

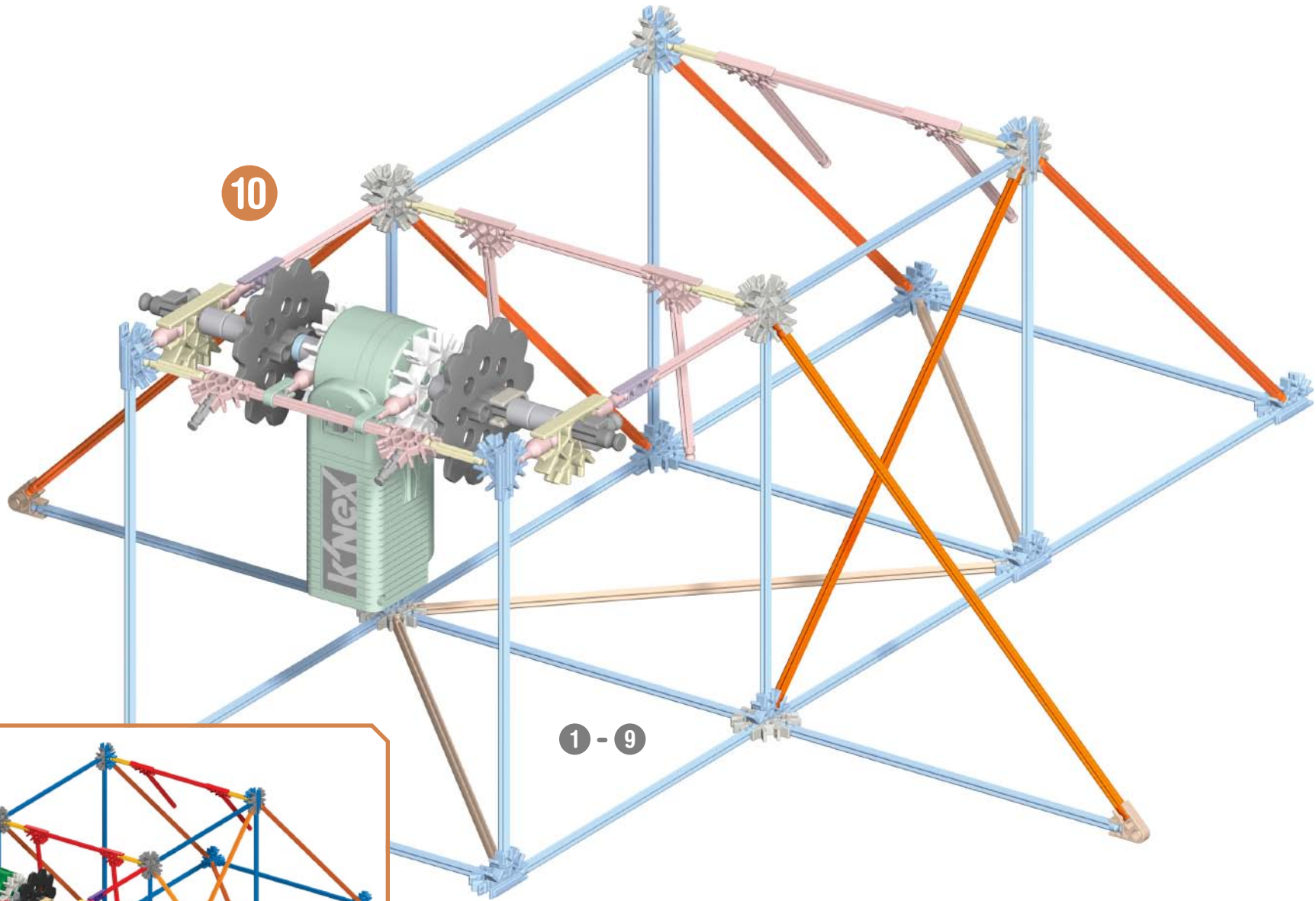

1 - 9

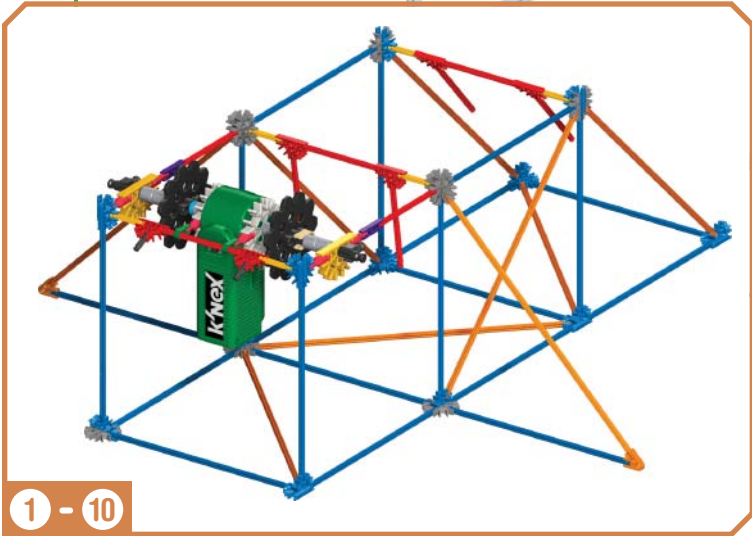

1 - 10

11

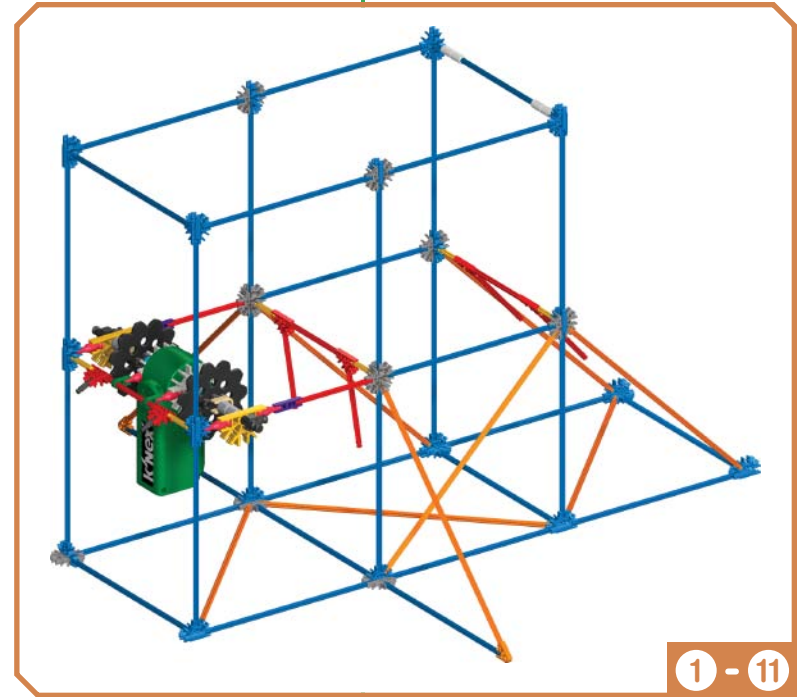
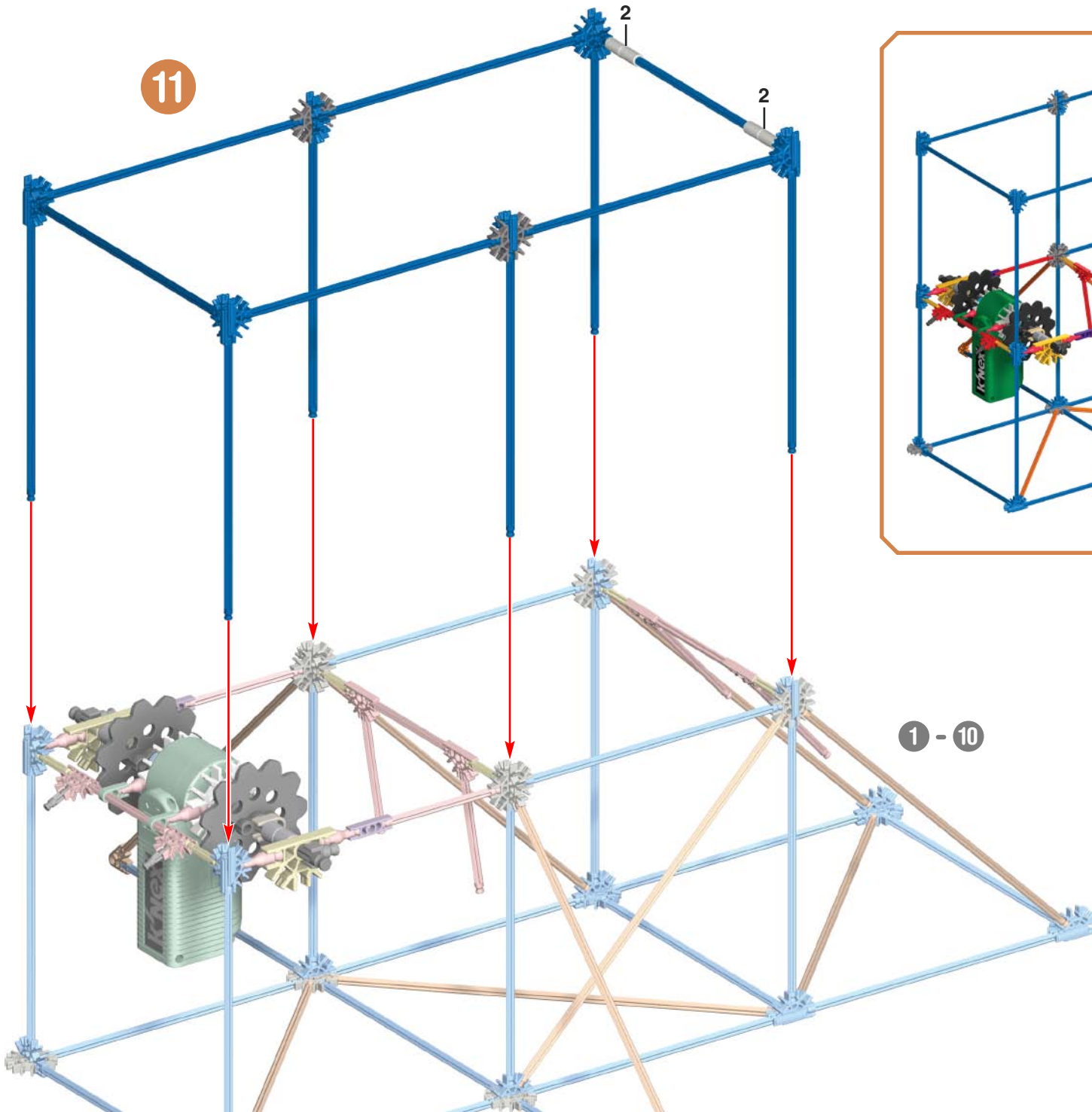

1 - 10

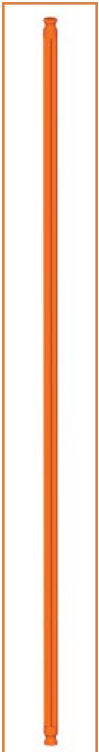

x2

1 - 11

12

1 - 12

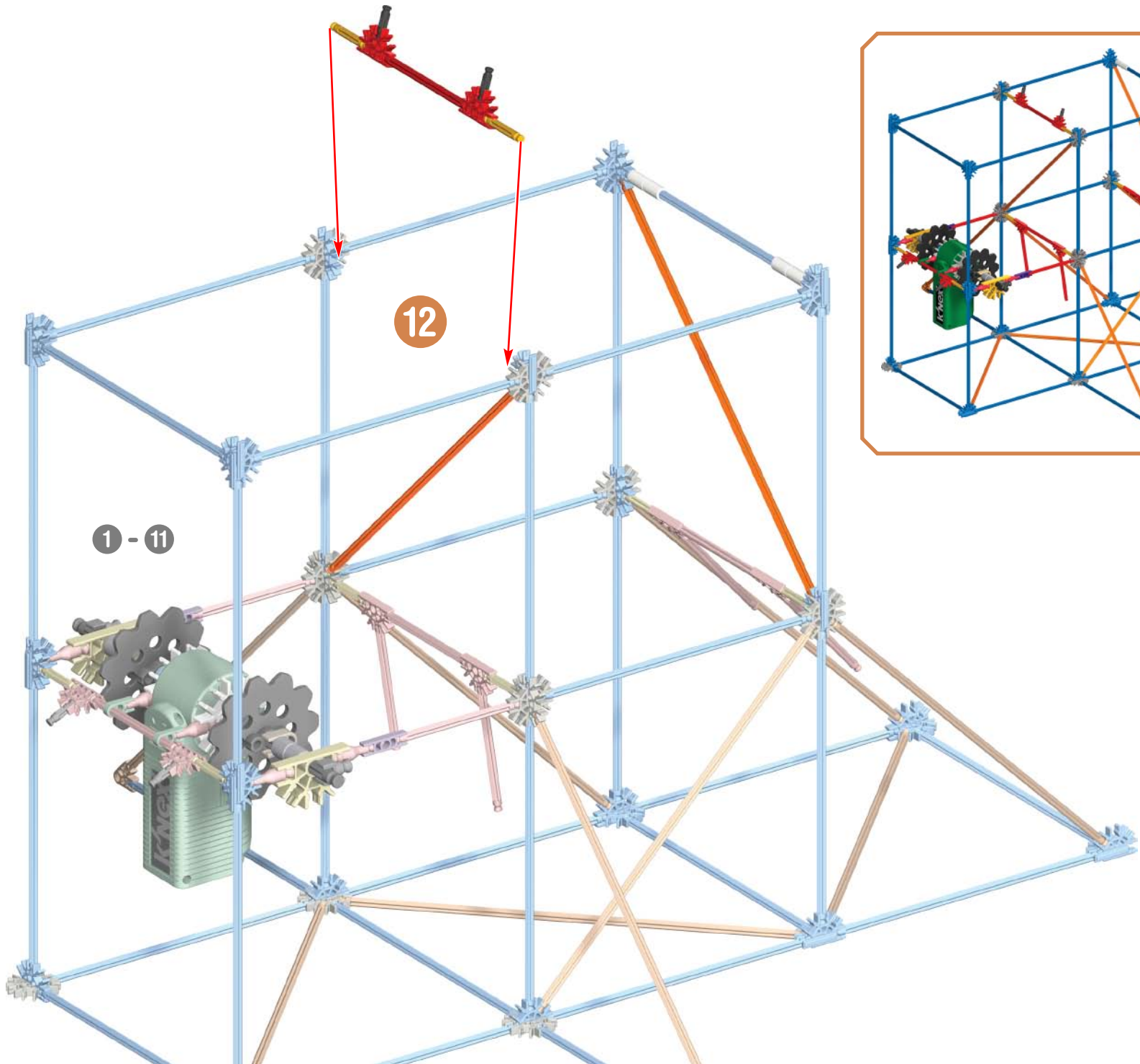
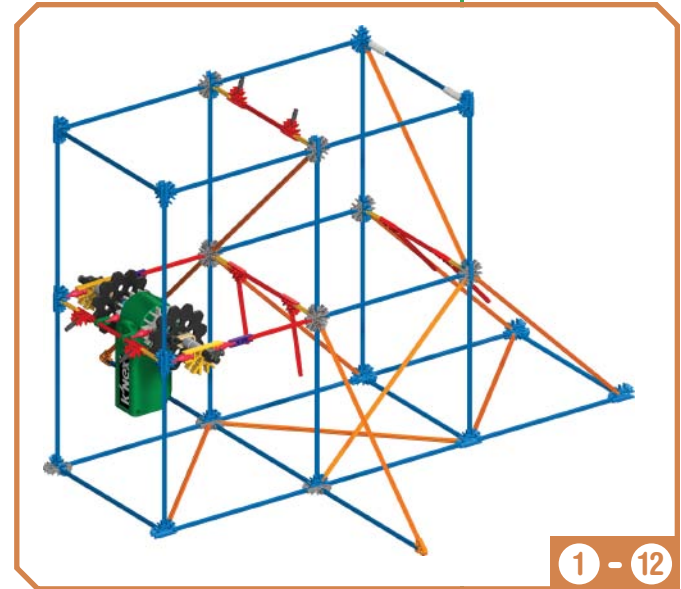

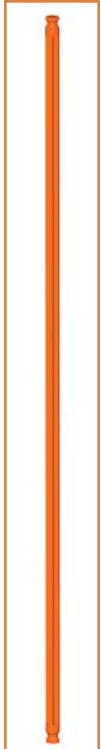

x4

13

1 - 12

1 - 13

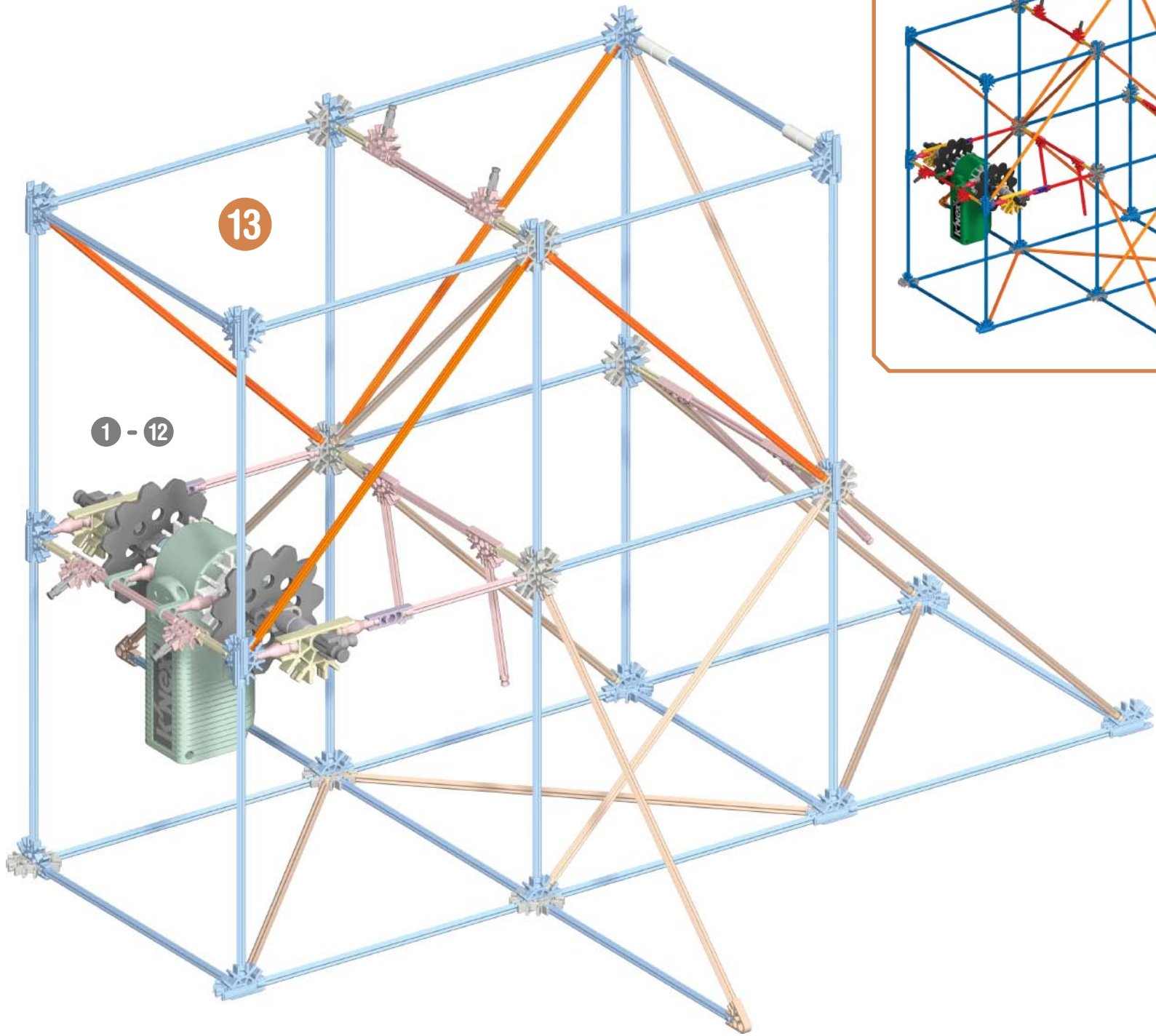
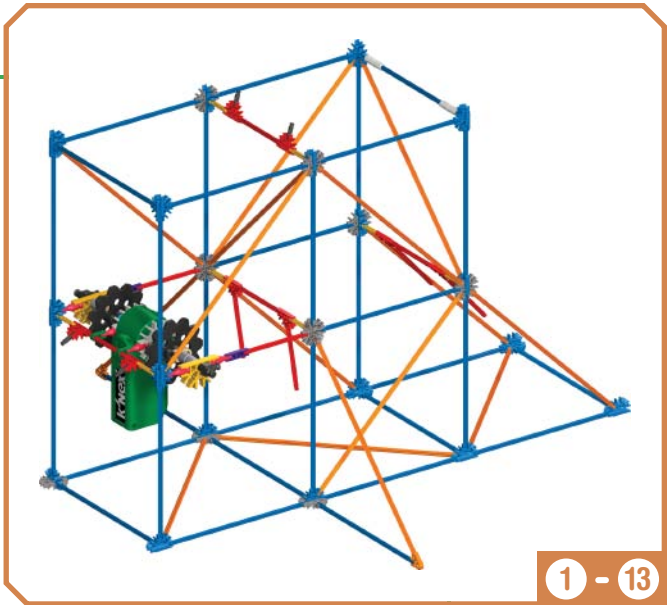

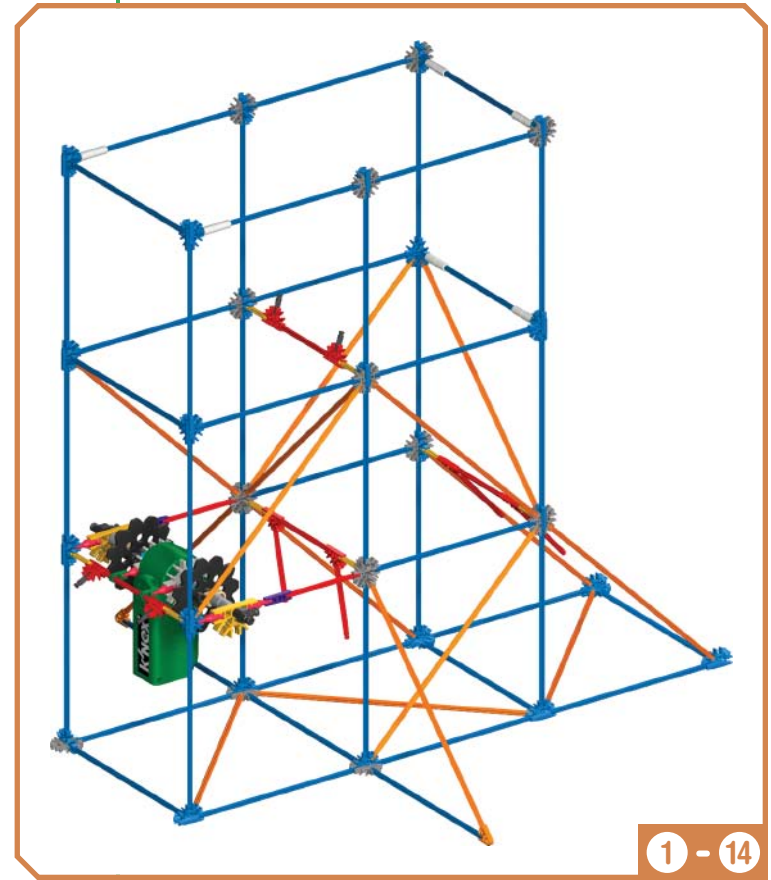
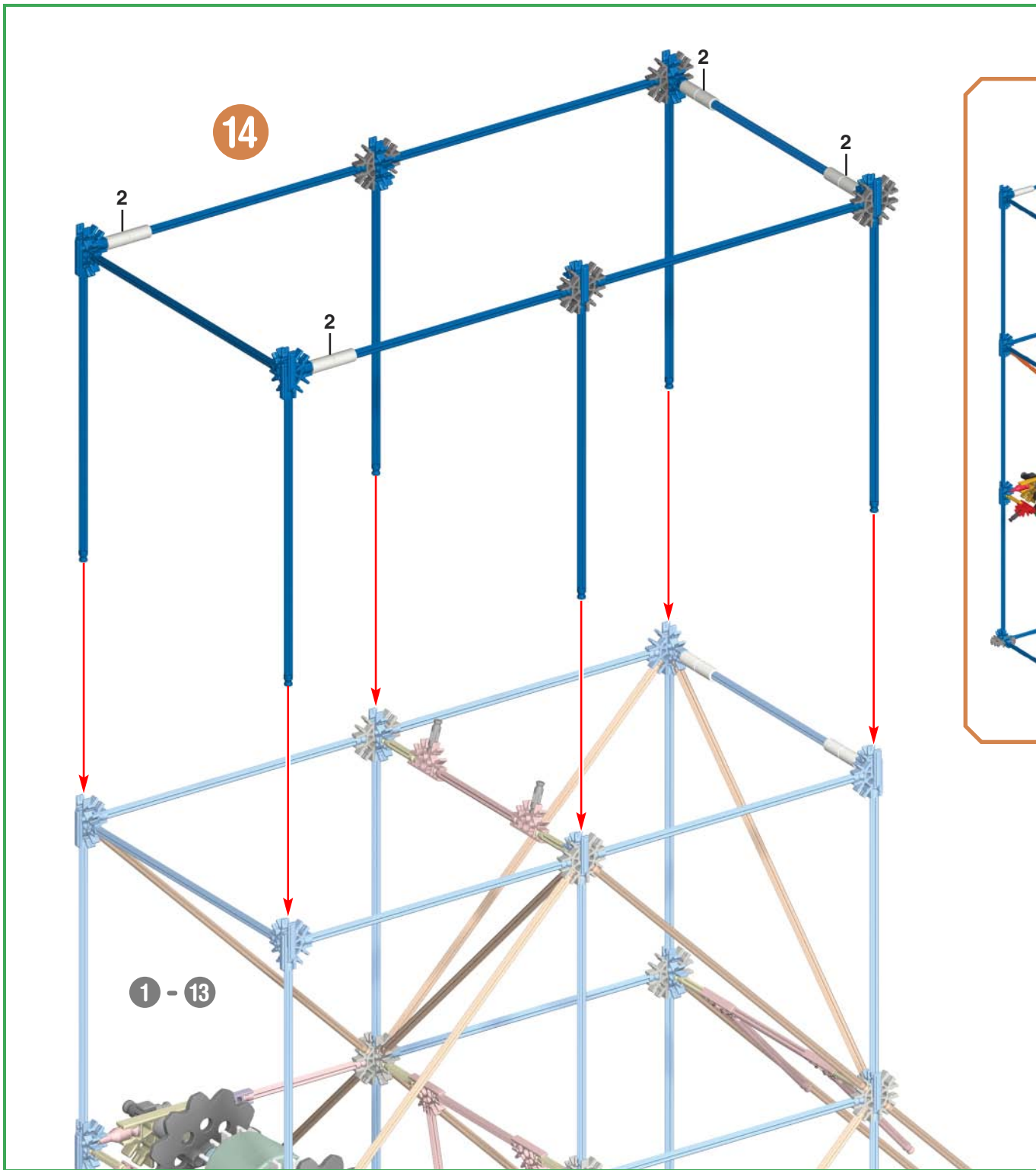

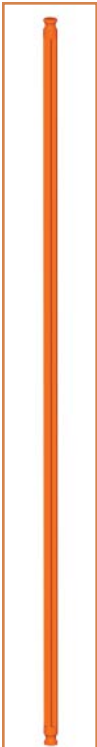

x1

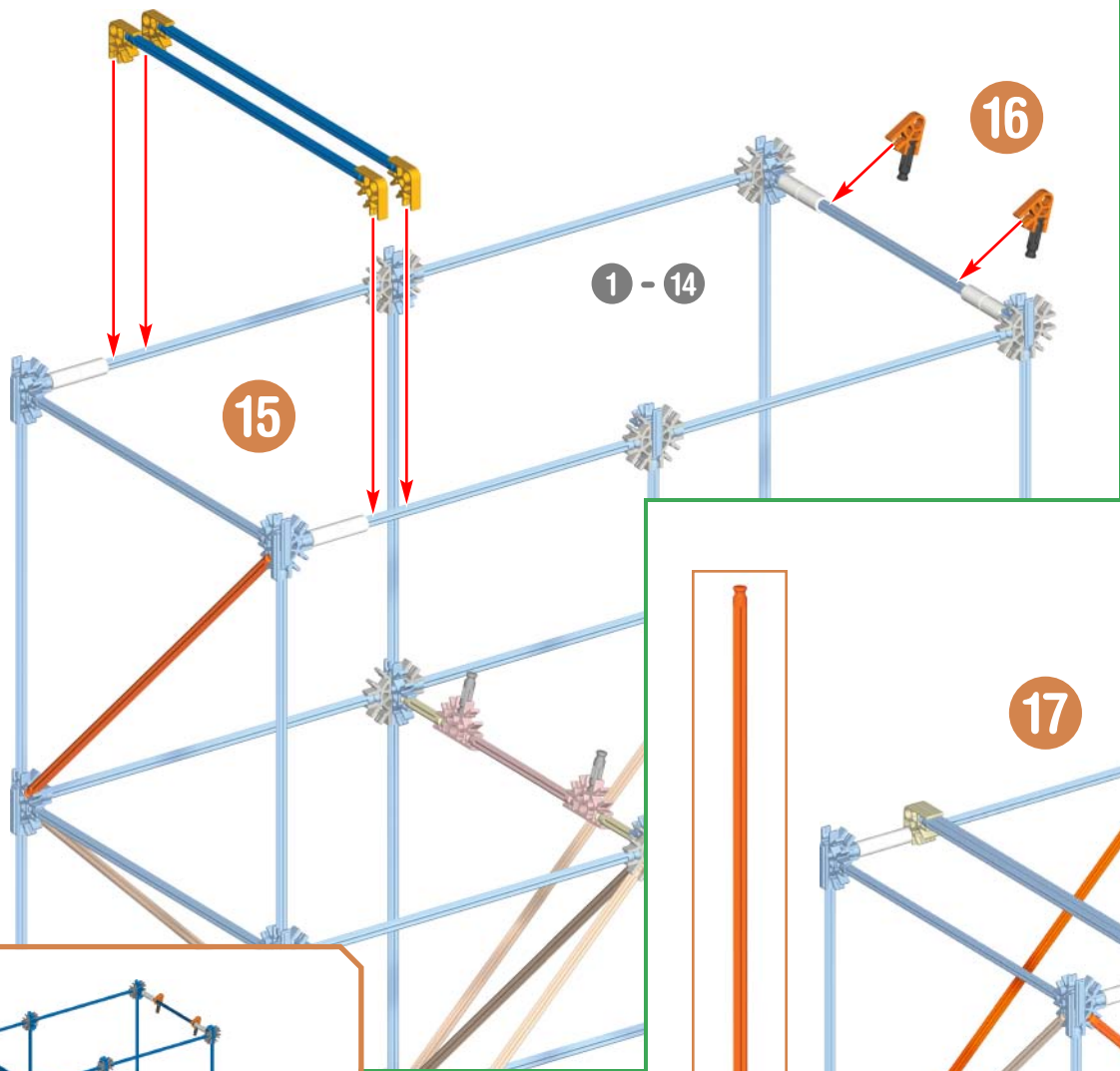

15

1 - 14

16

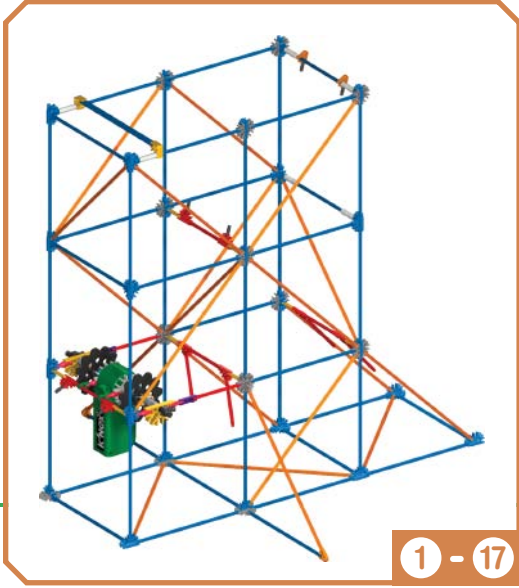

1 - 17

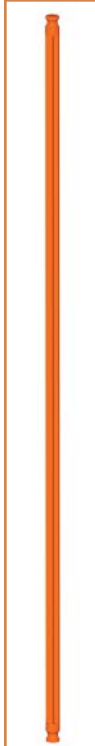

x4

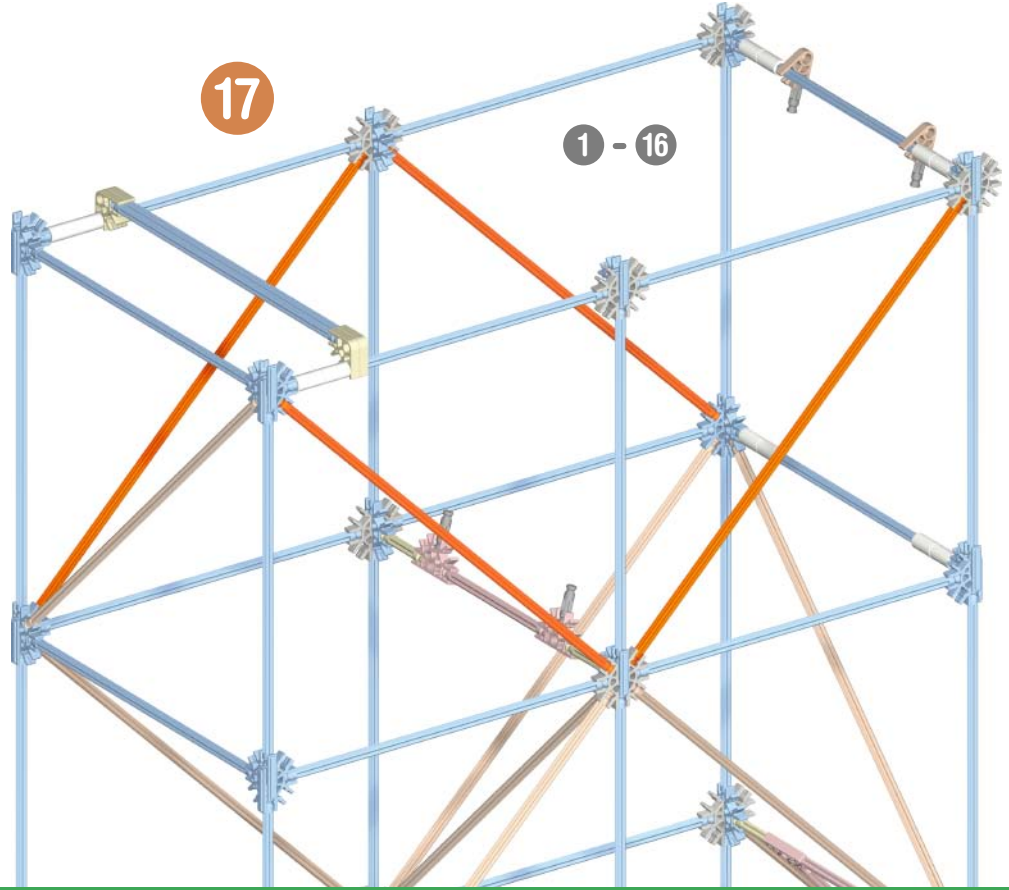

17

1 - 16

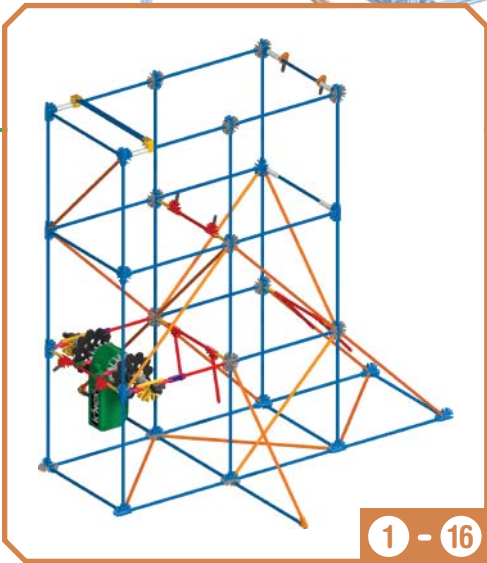

1 - 16

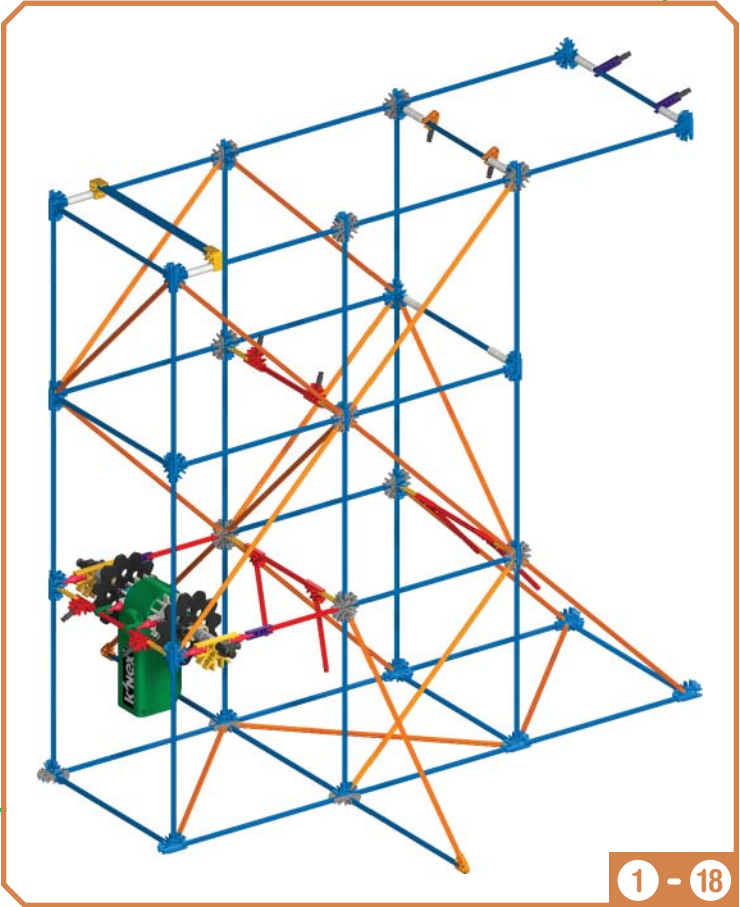
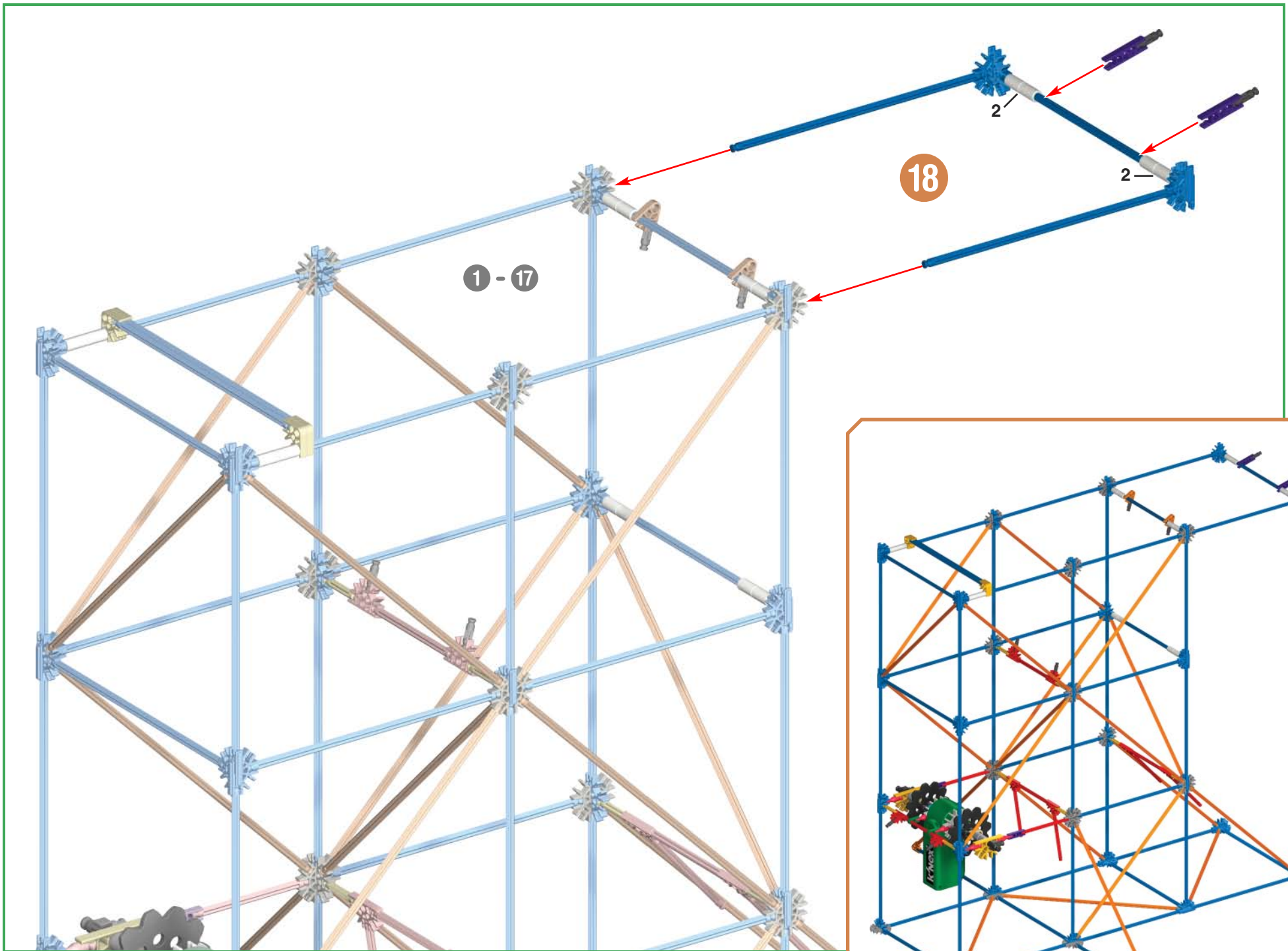

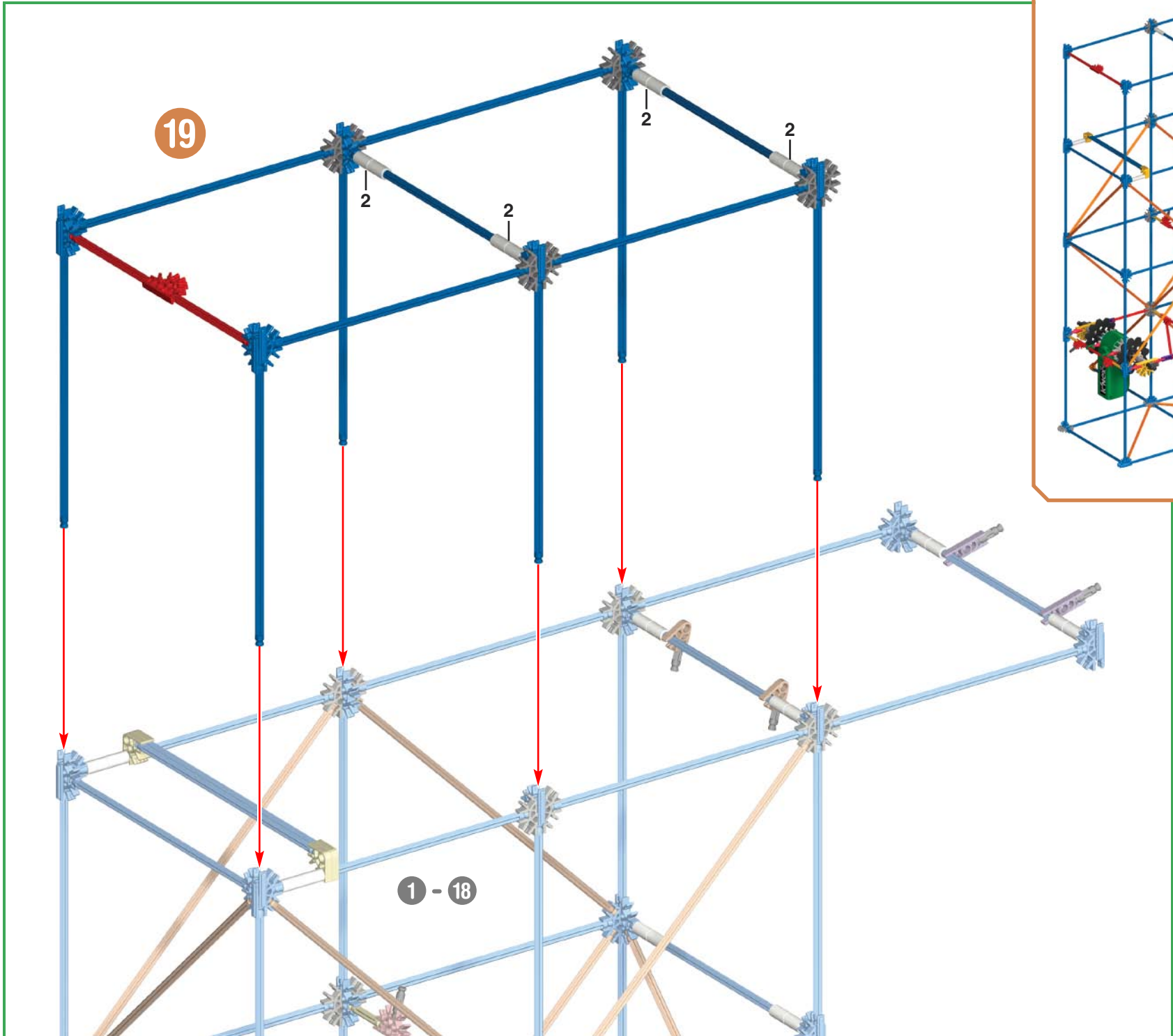

19

2

2

2

2

1 - 18

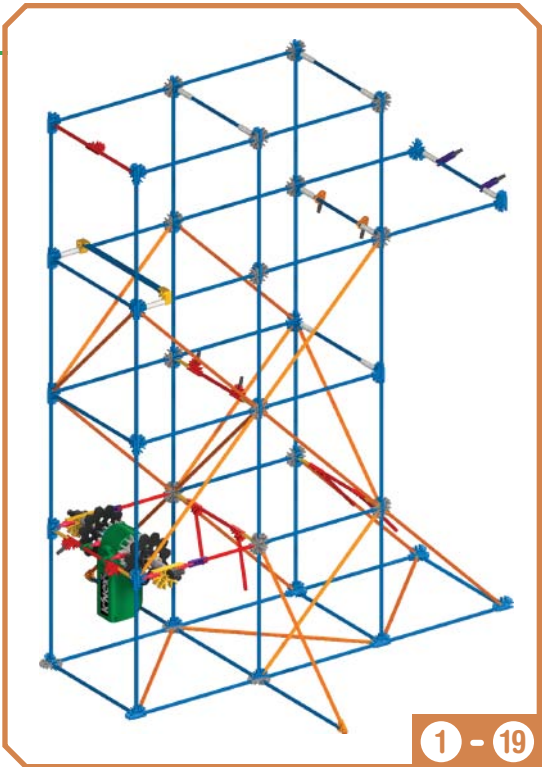

1 - 19

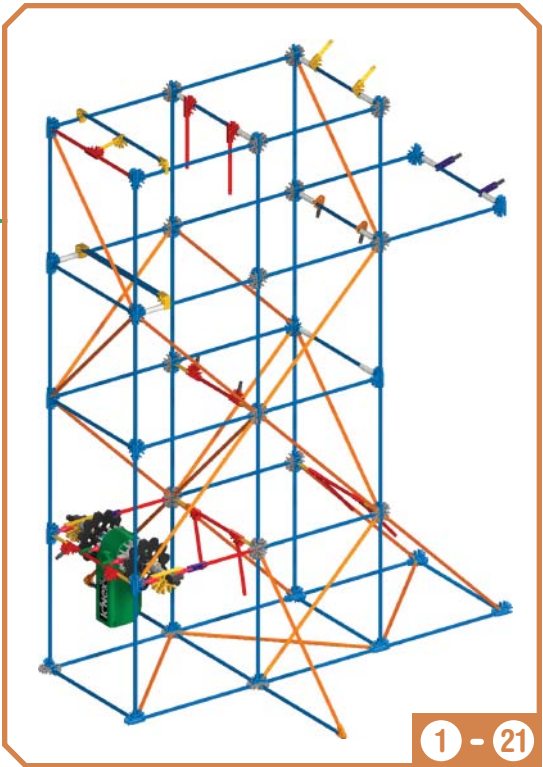
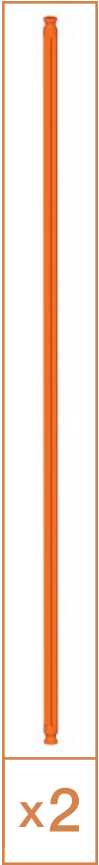
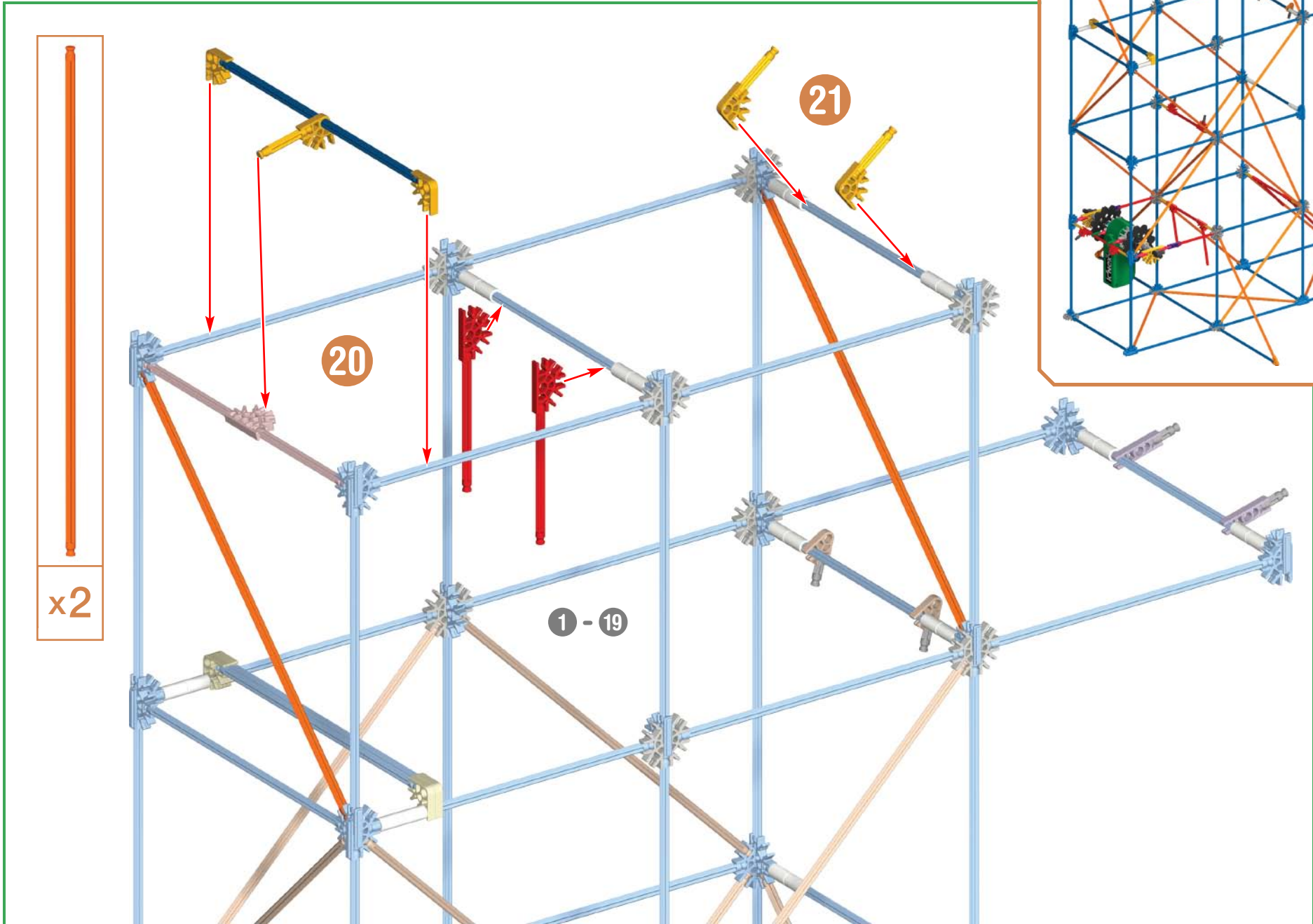

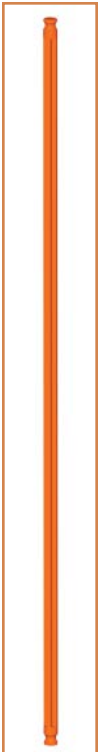

x6

22

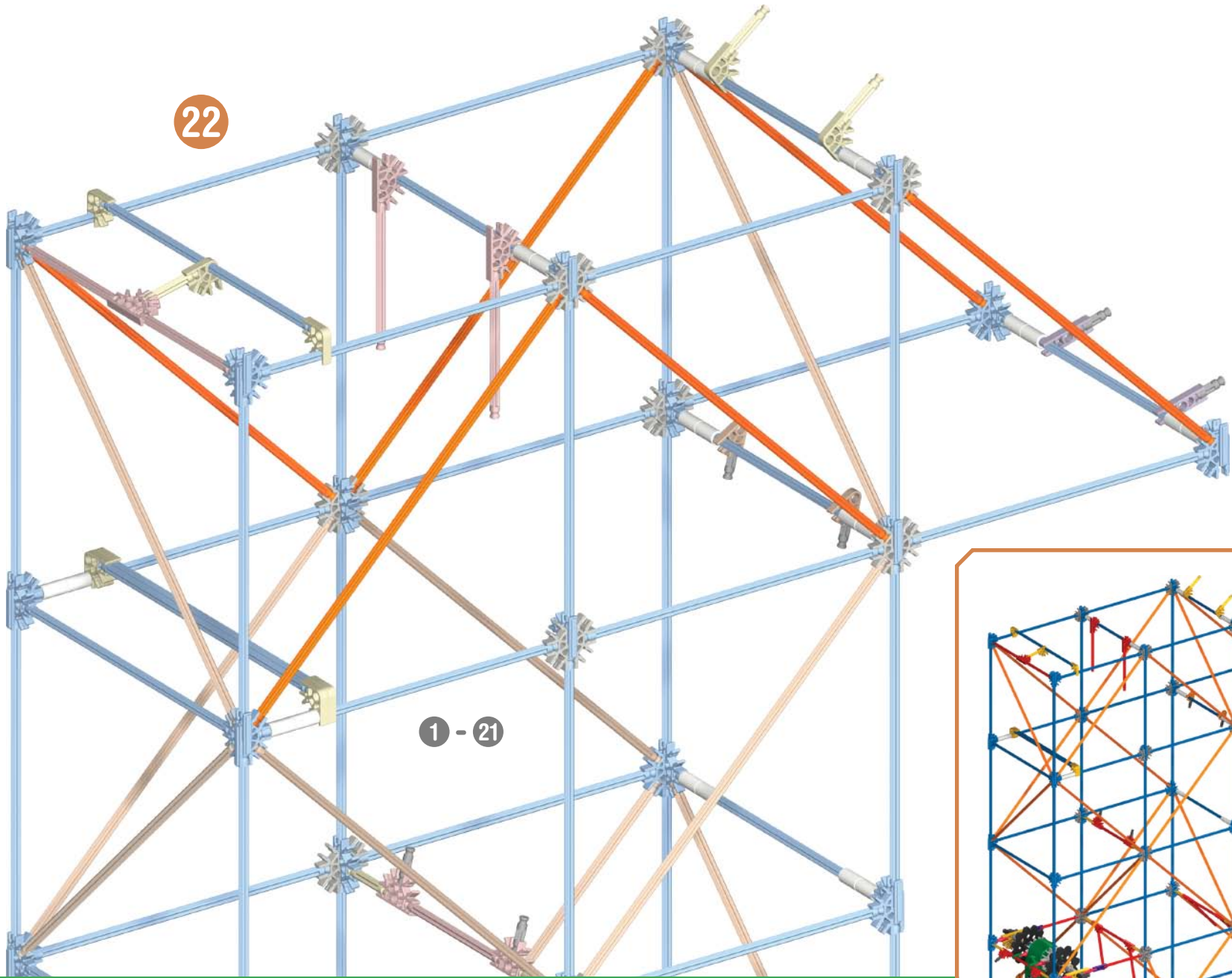

1 - 21

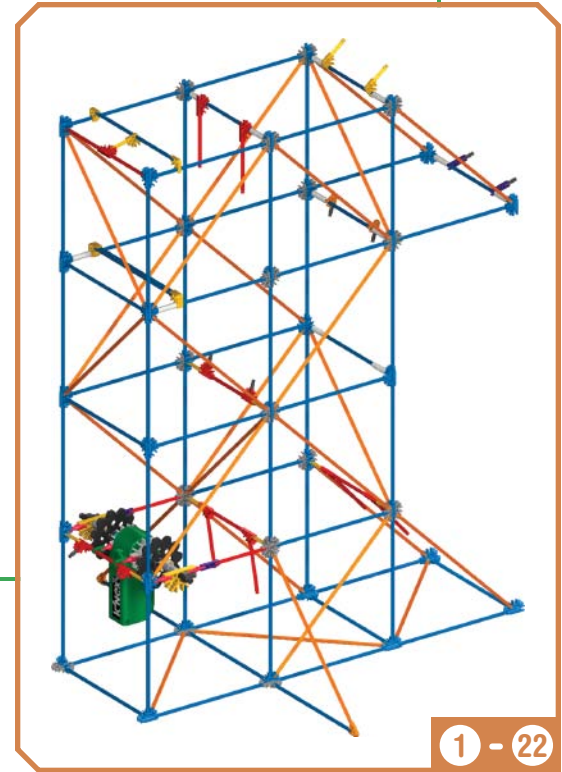

1 - 22

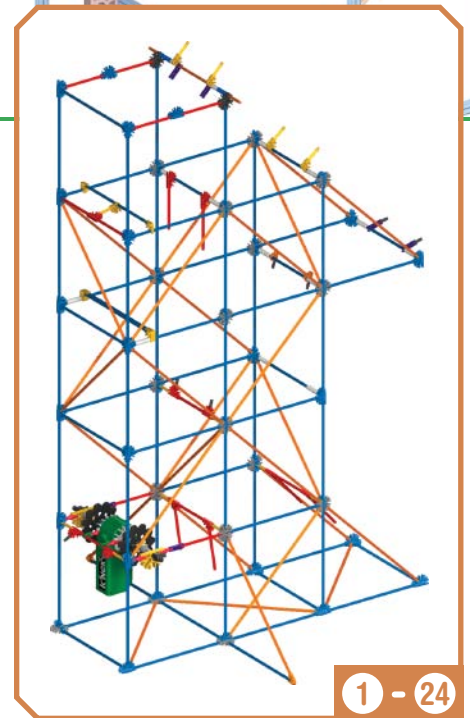
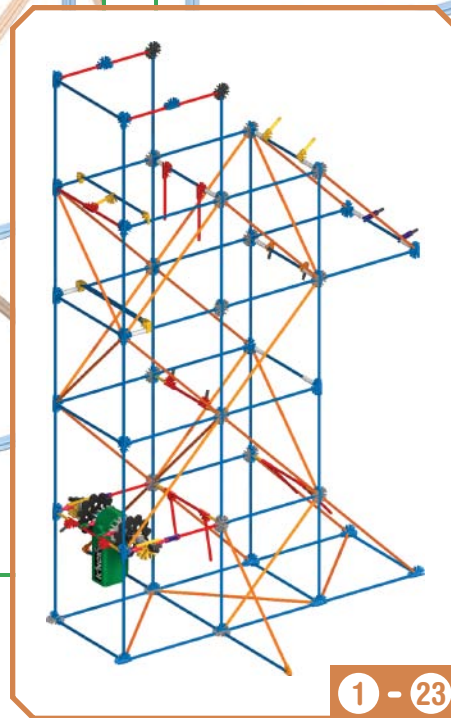
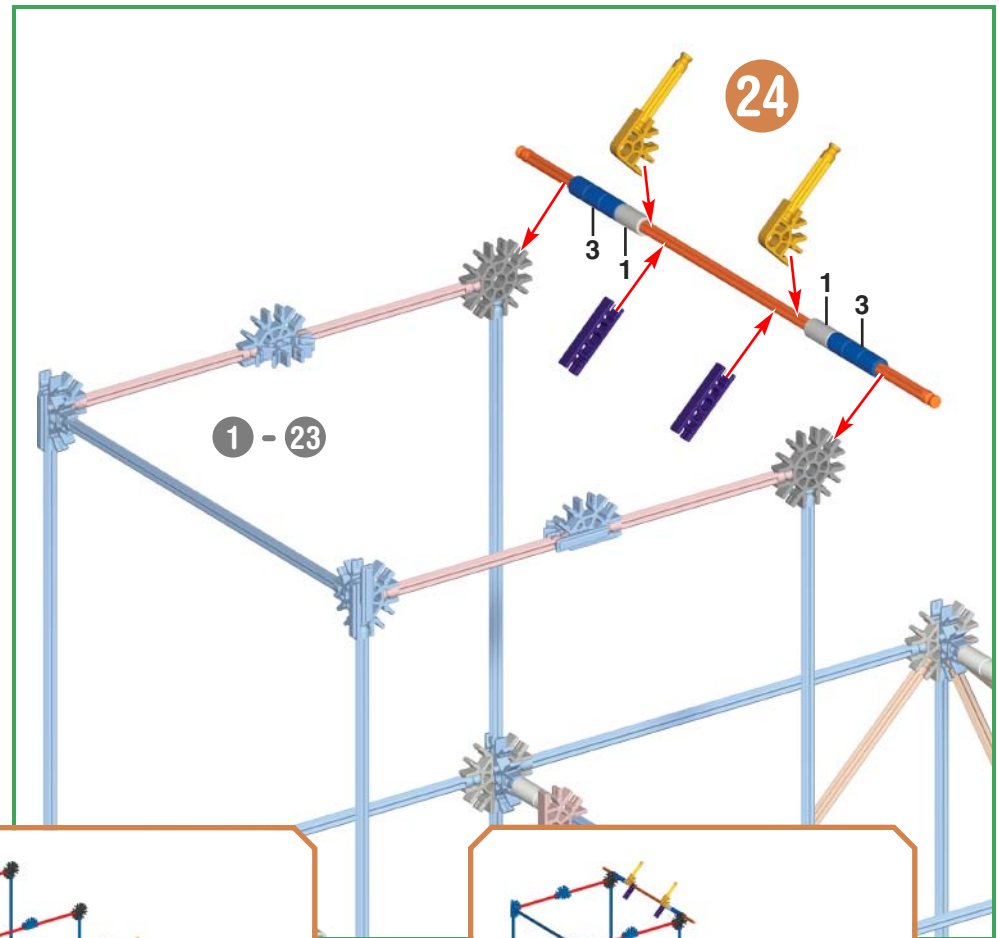
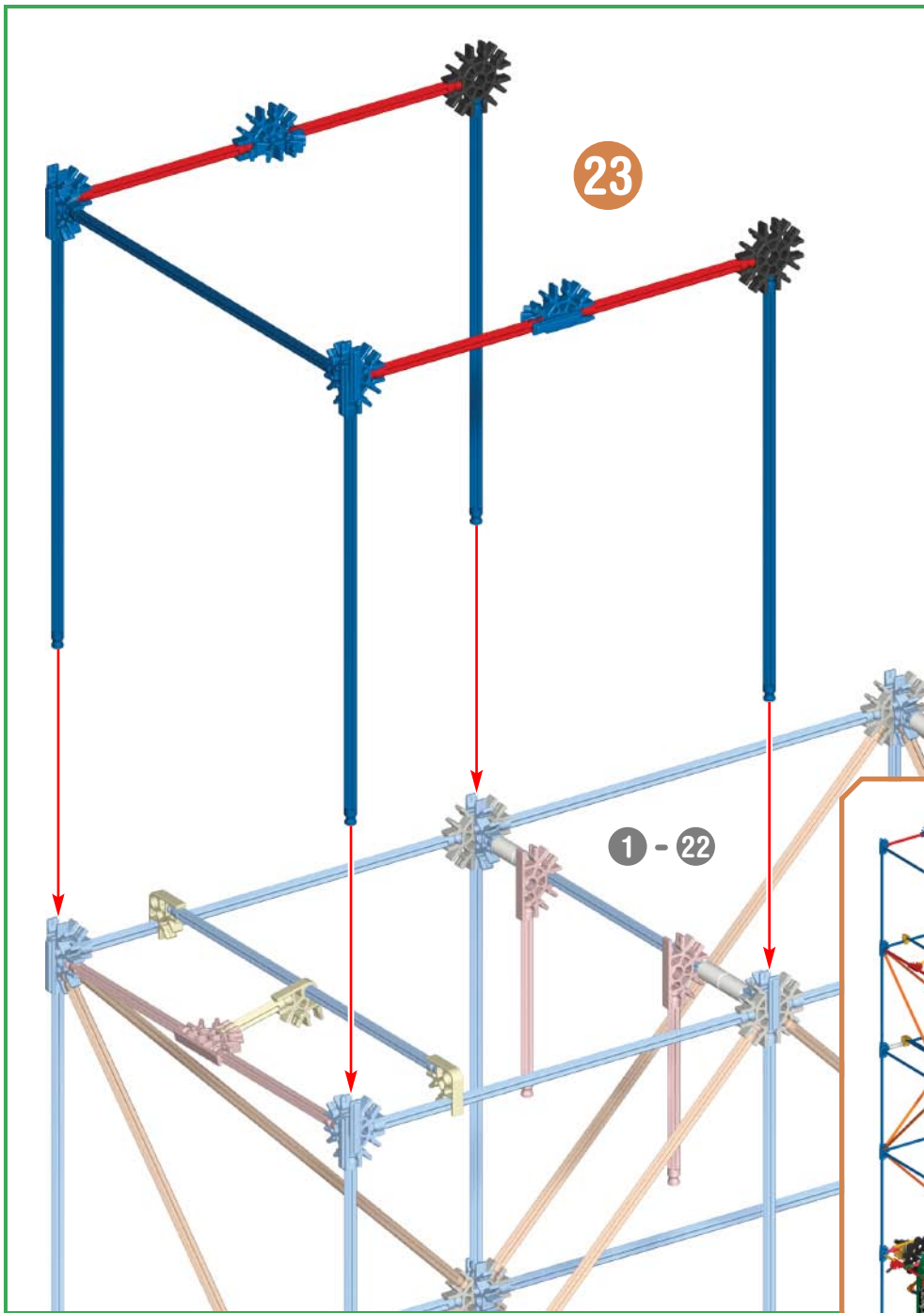

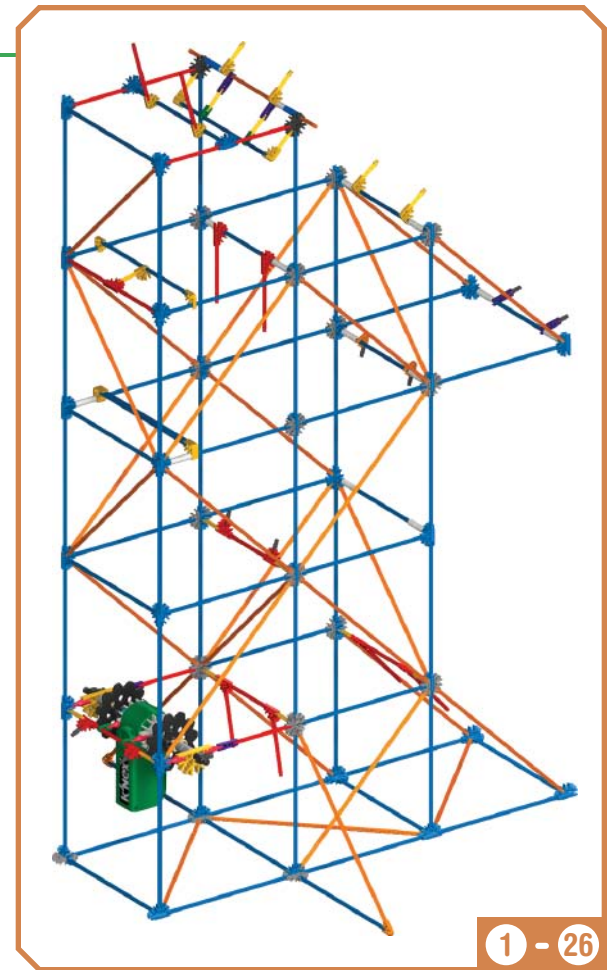
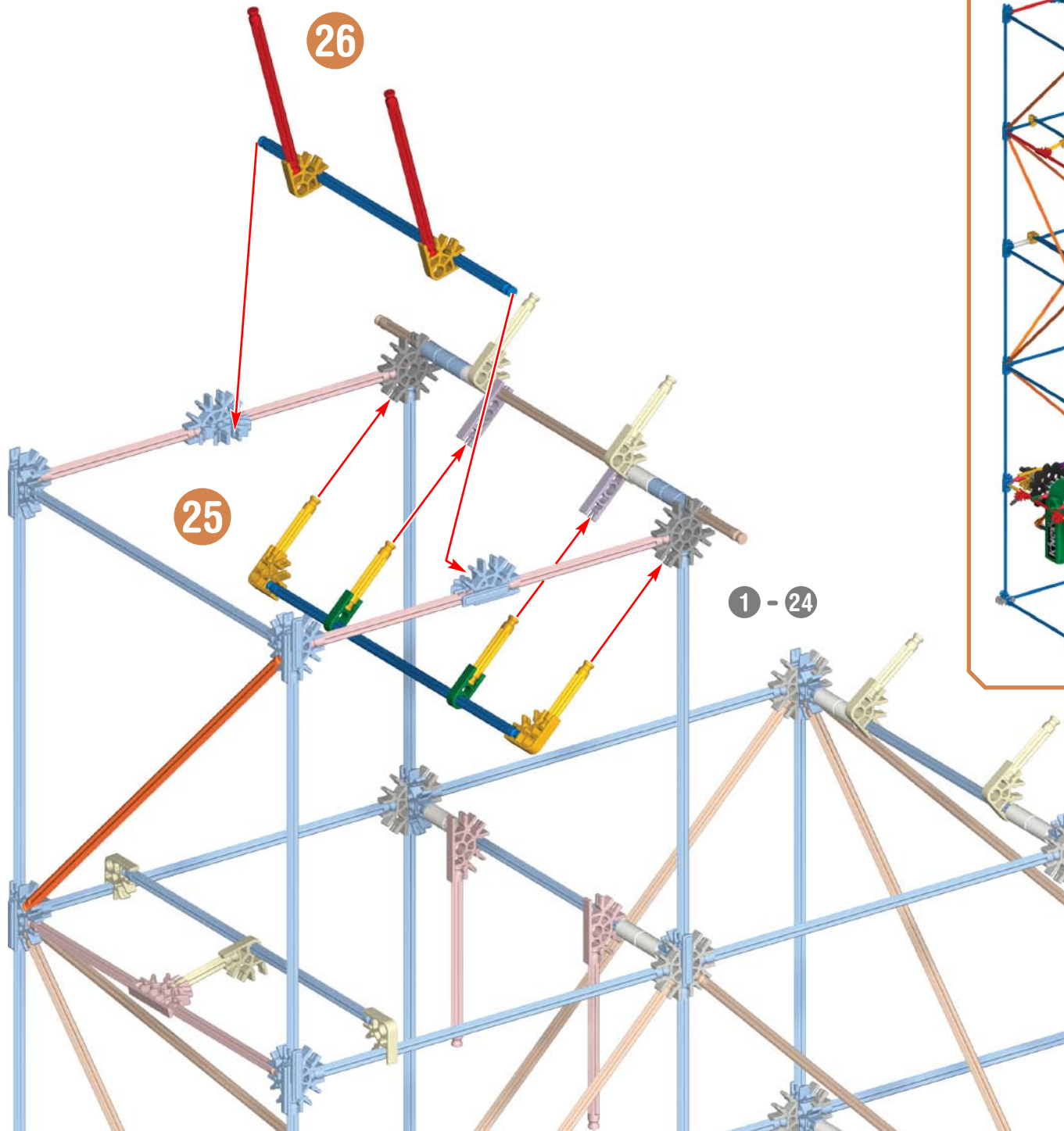
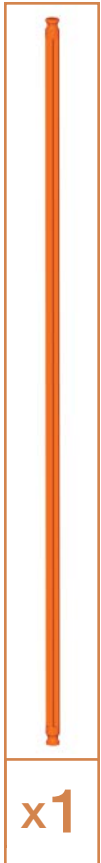

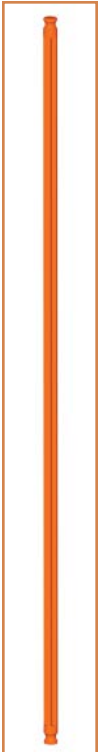

x4

27

1 - 26

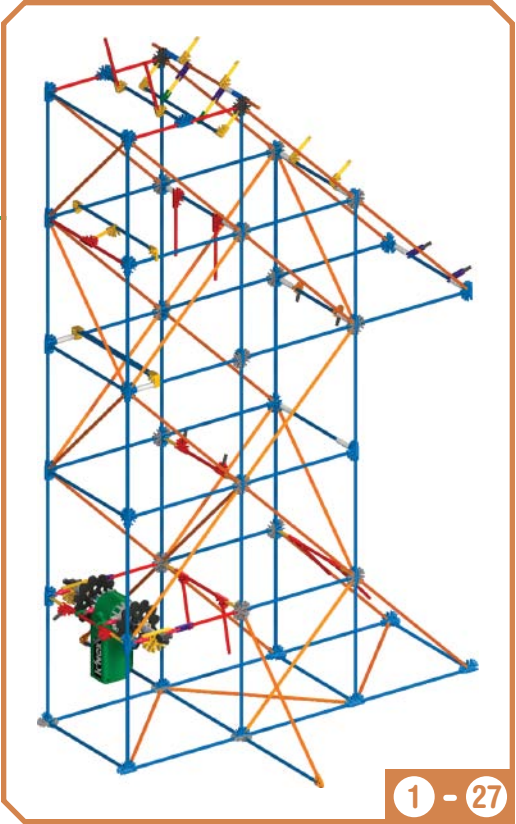
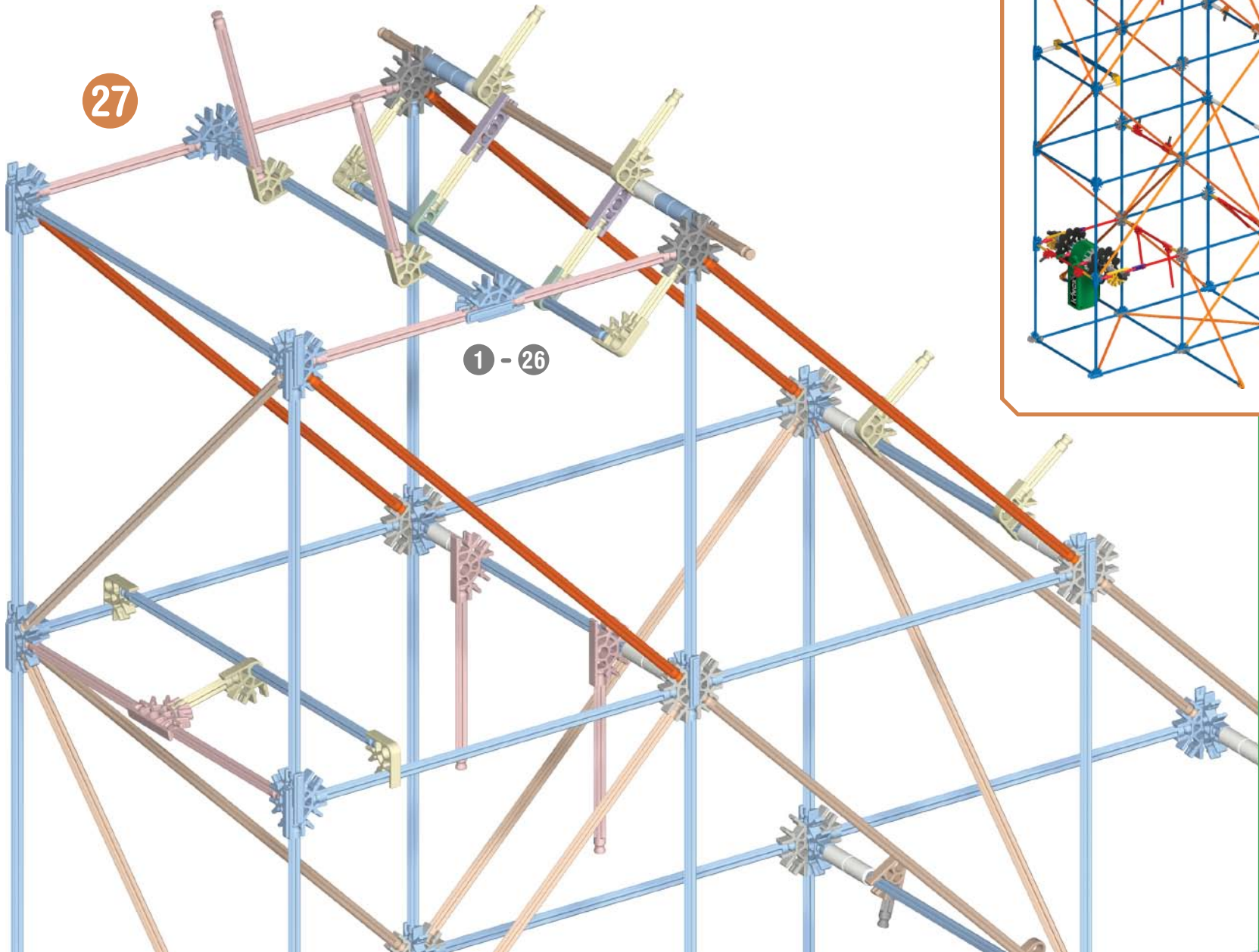

1 - 27

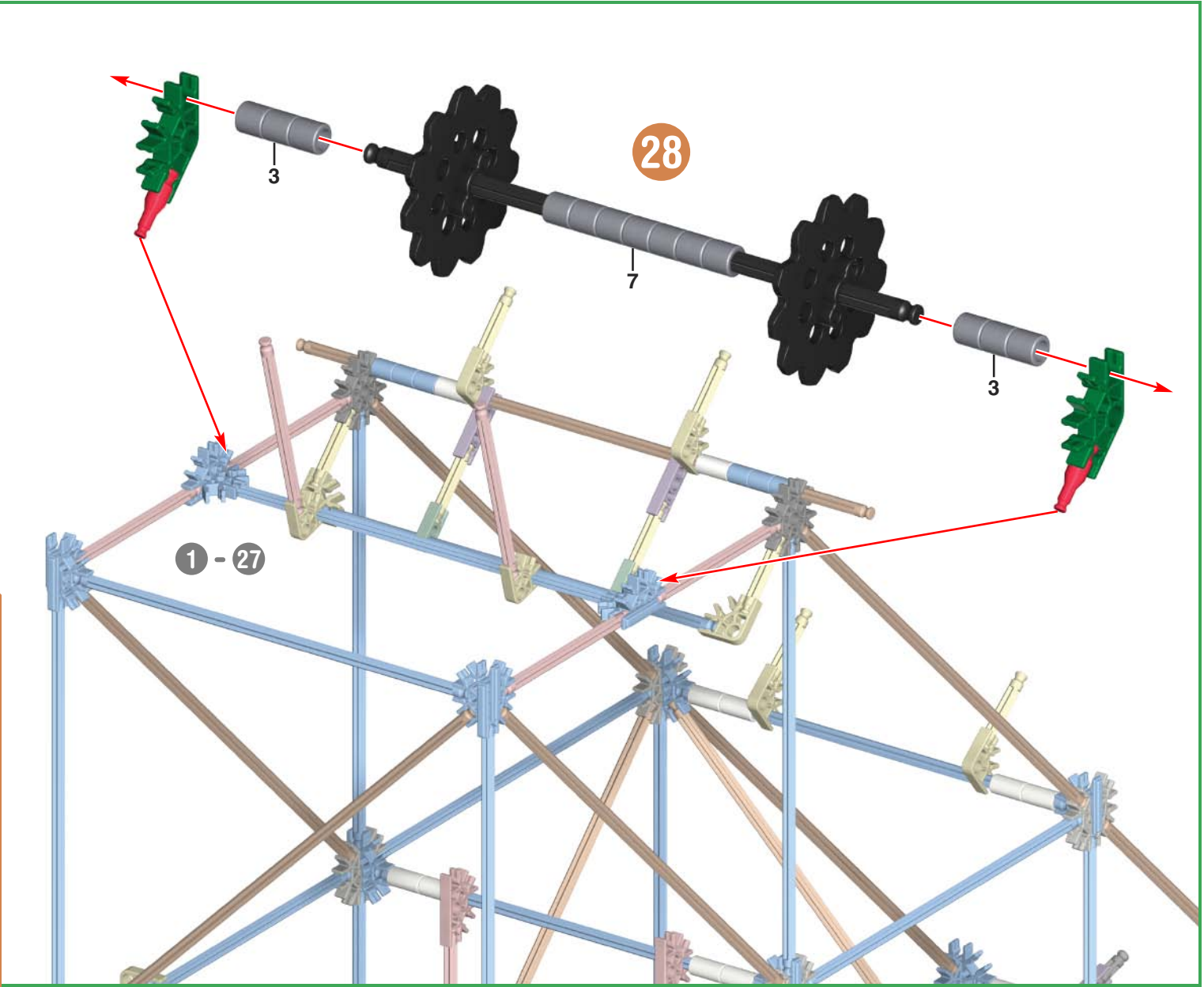
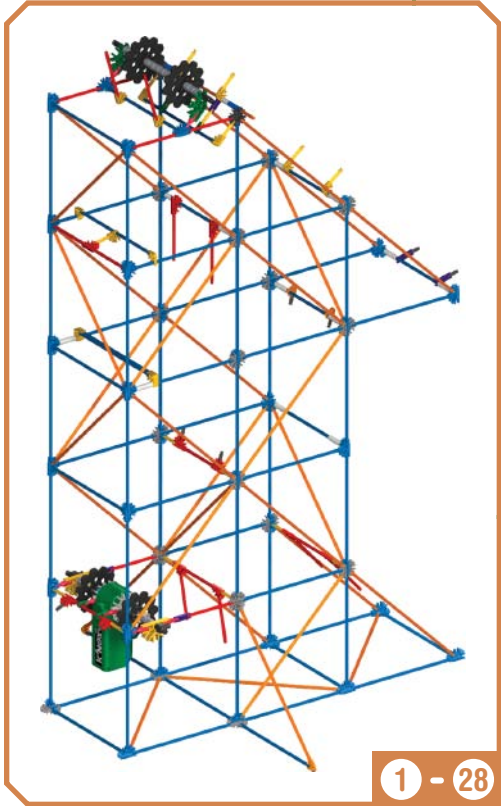

29

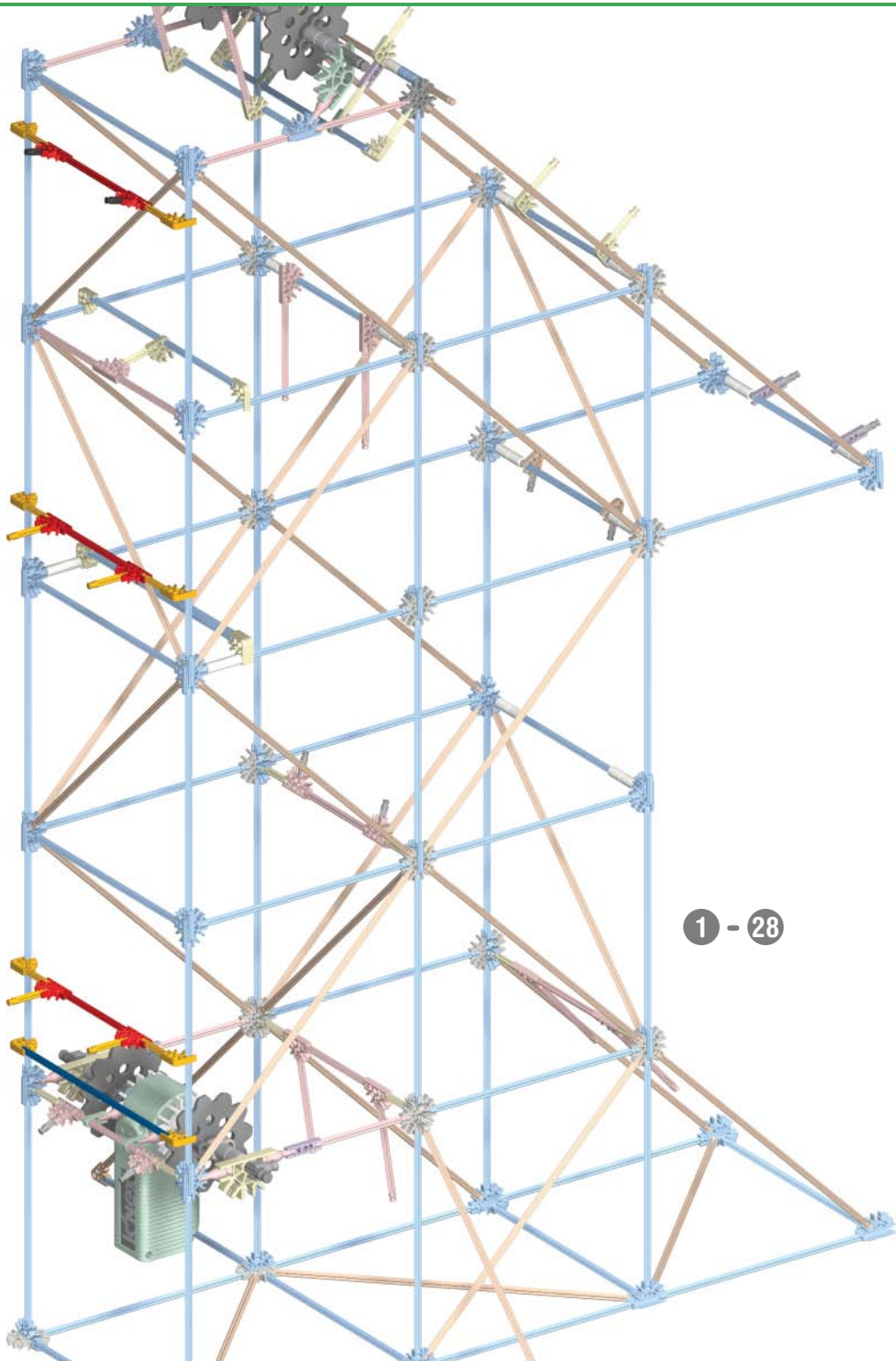

1 - 28

30

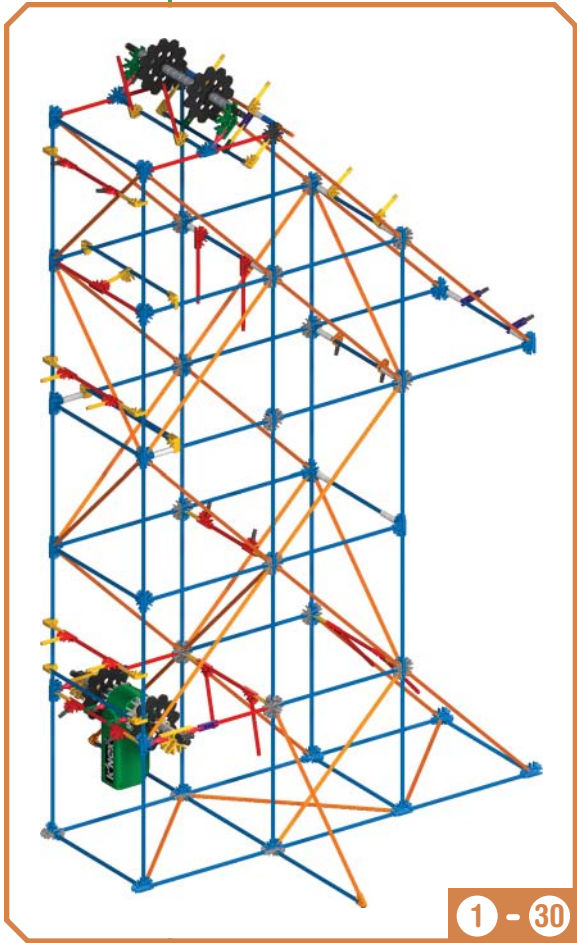

1 - 30

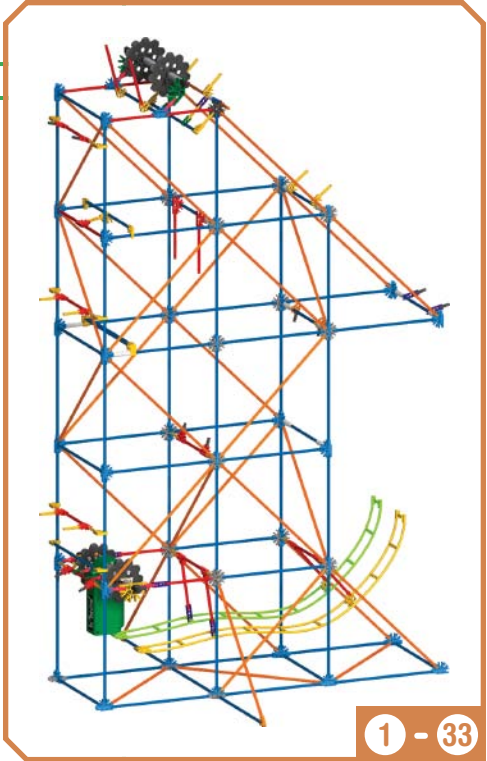
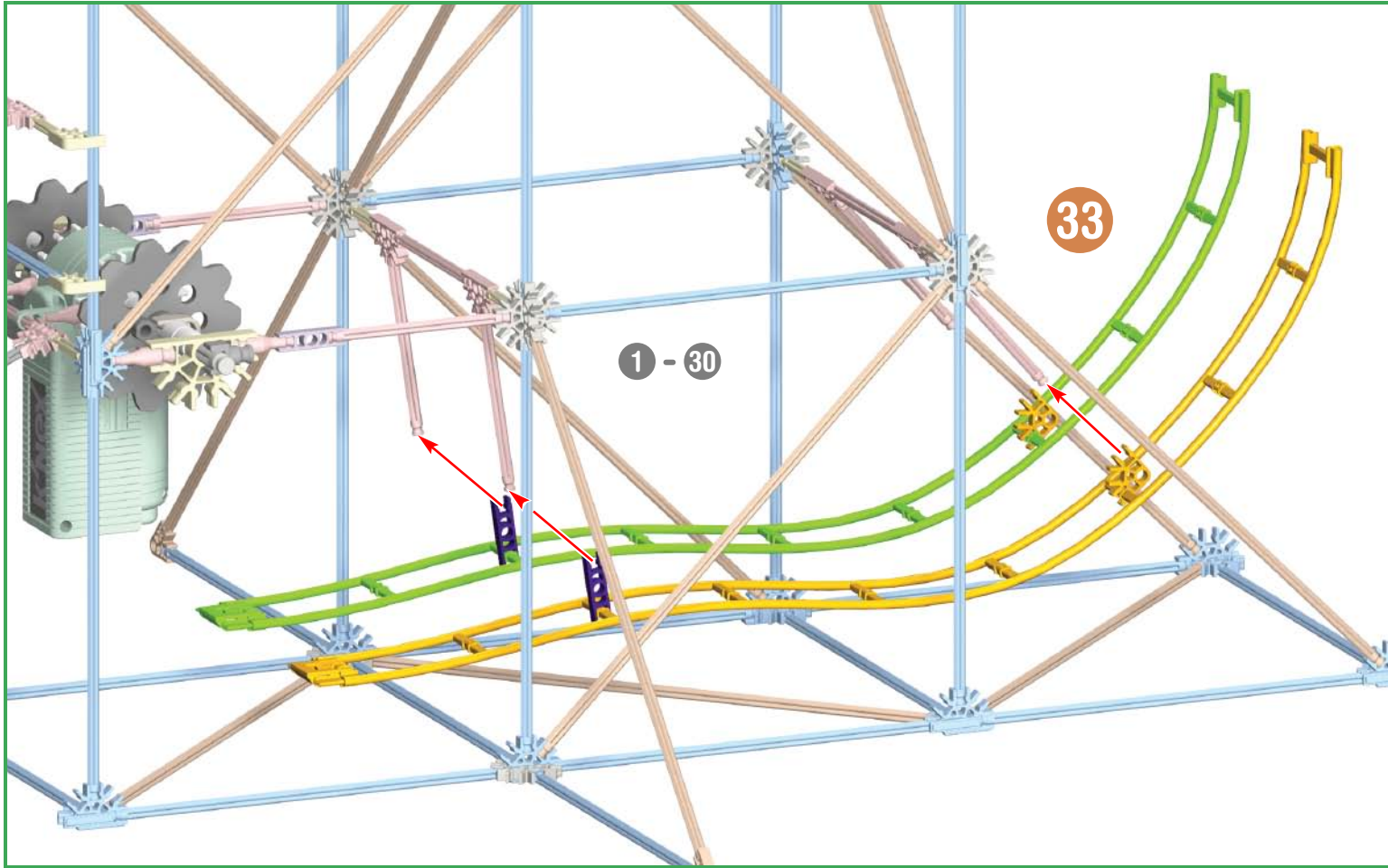
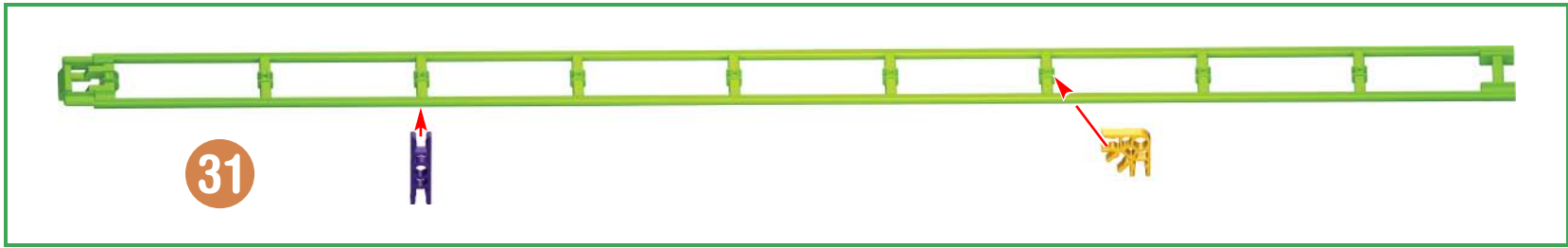

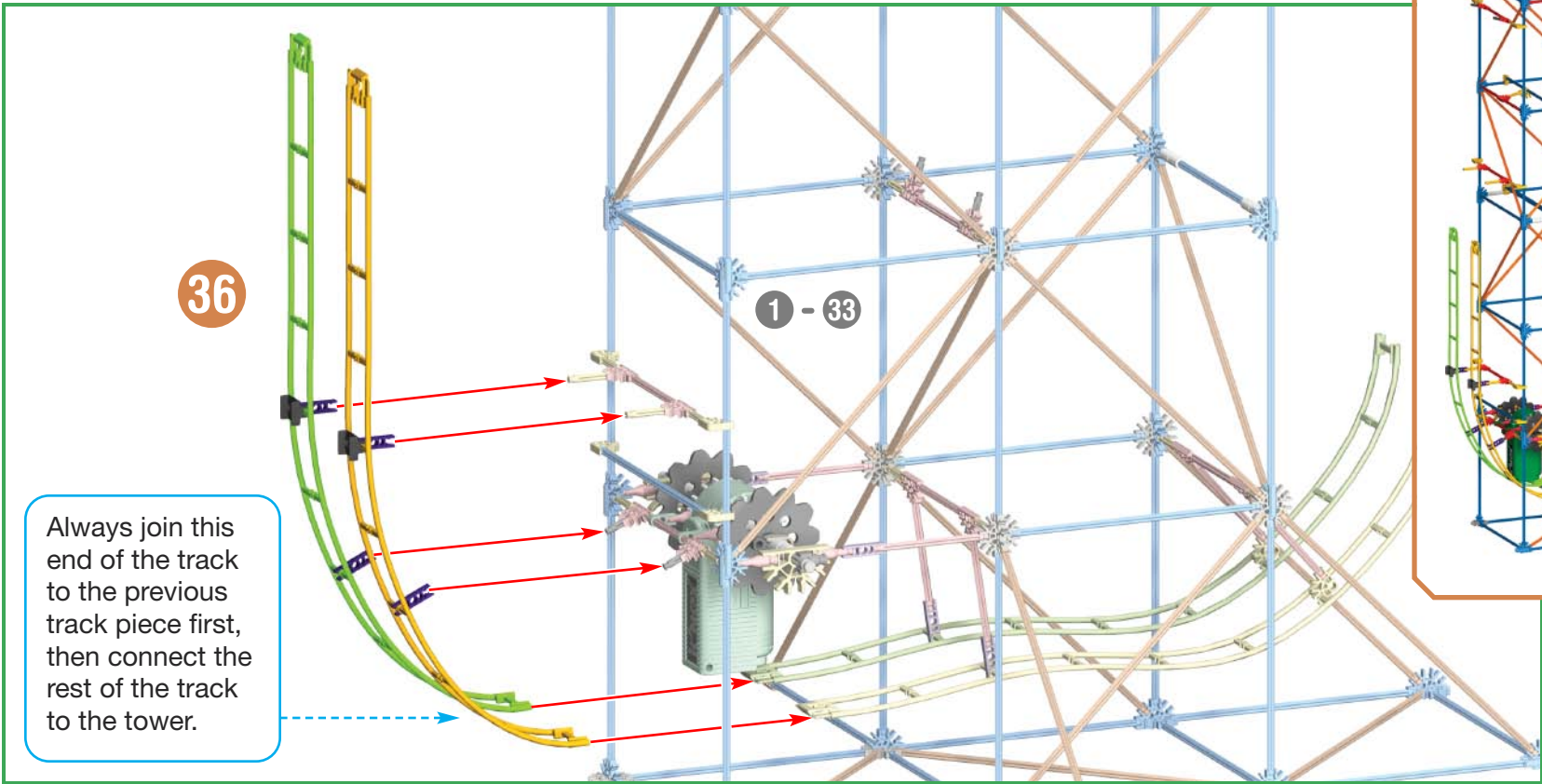
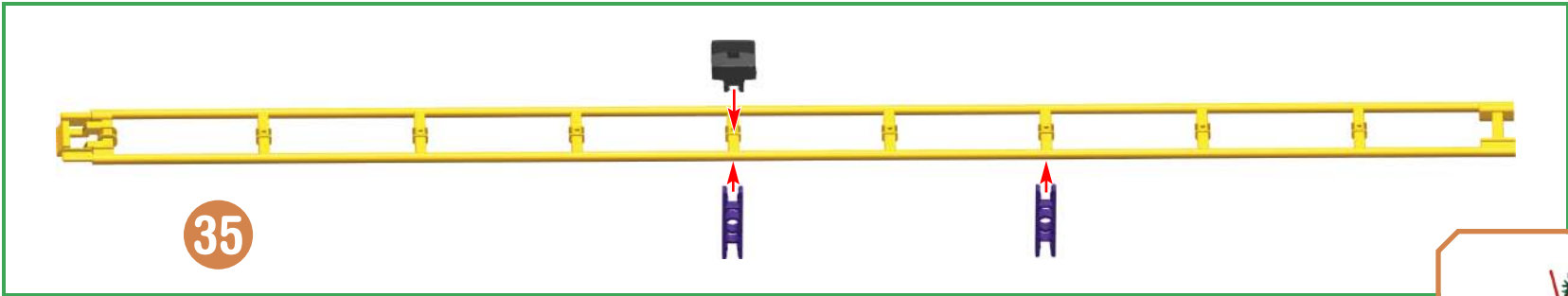
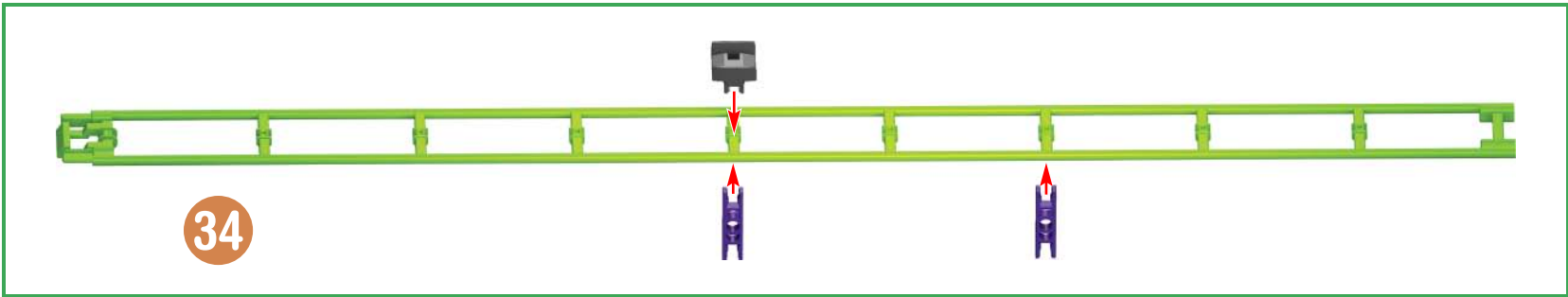

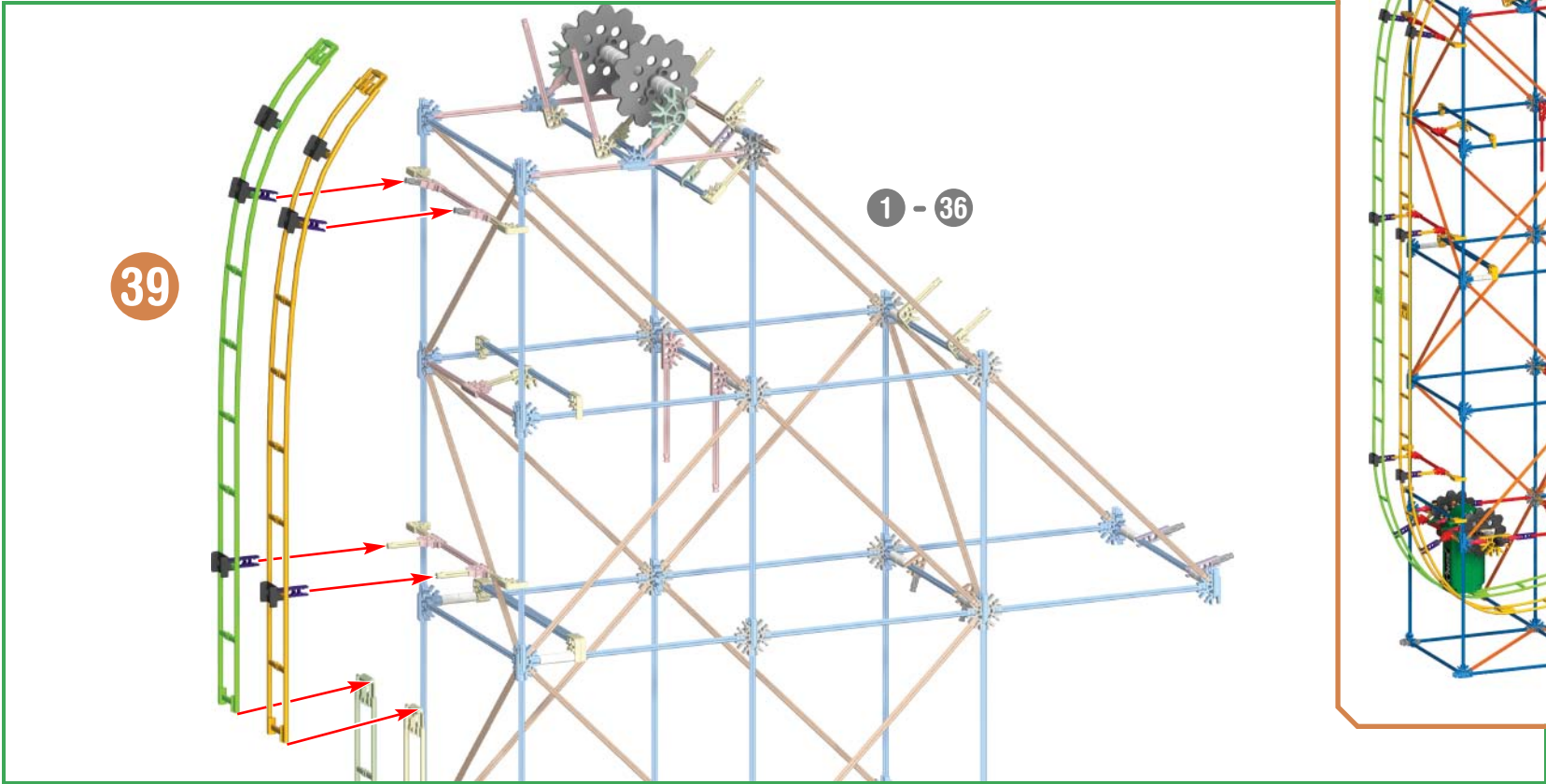
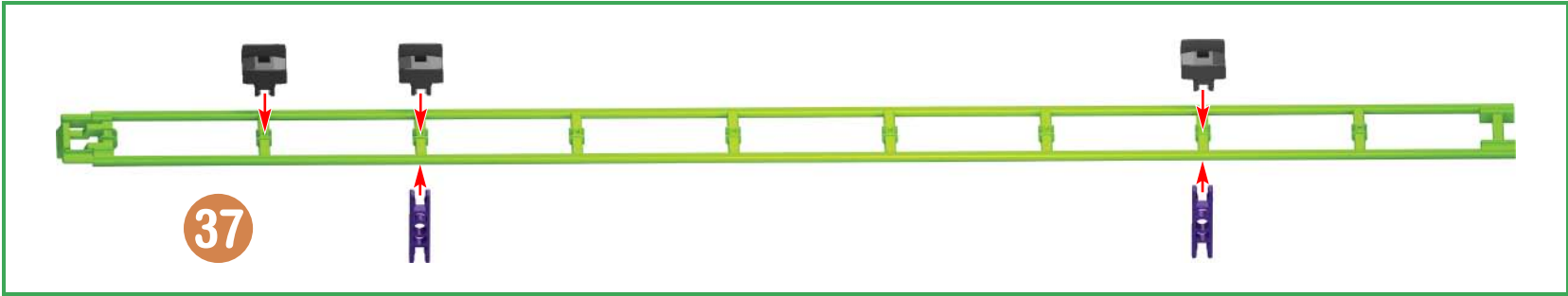

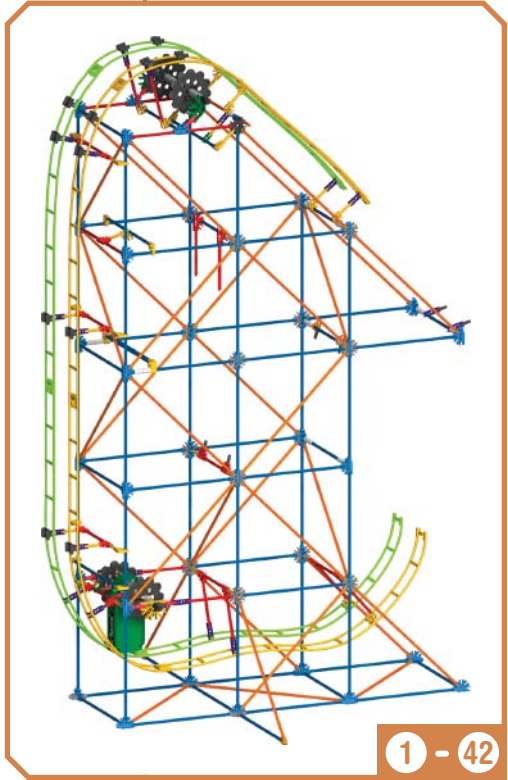
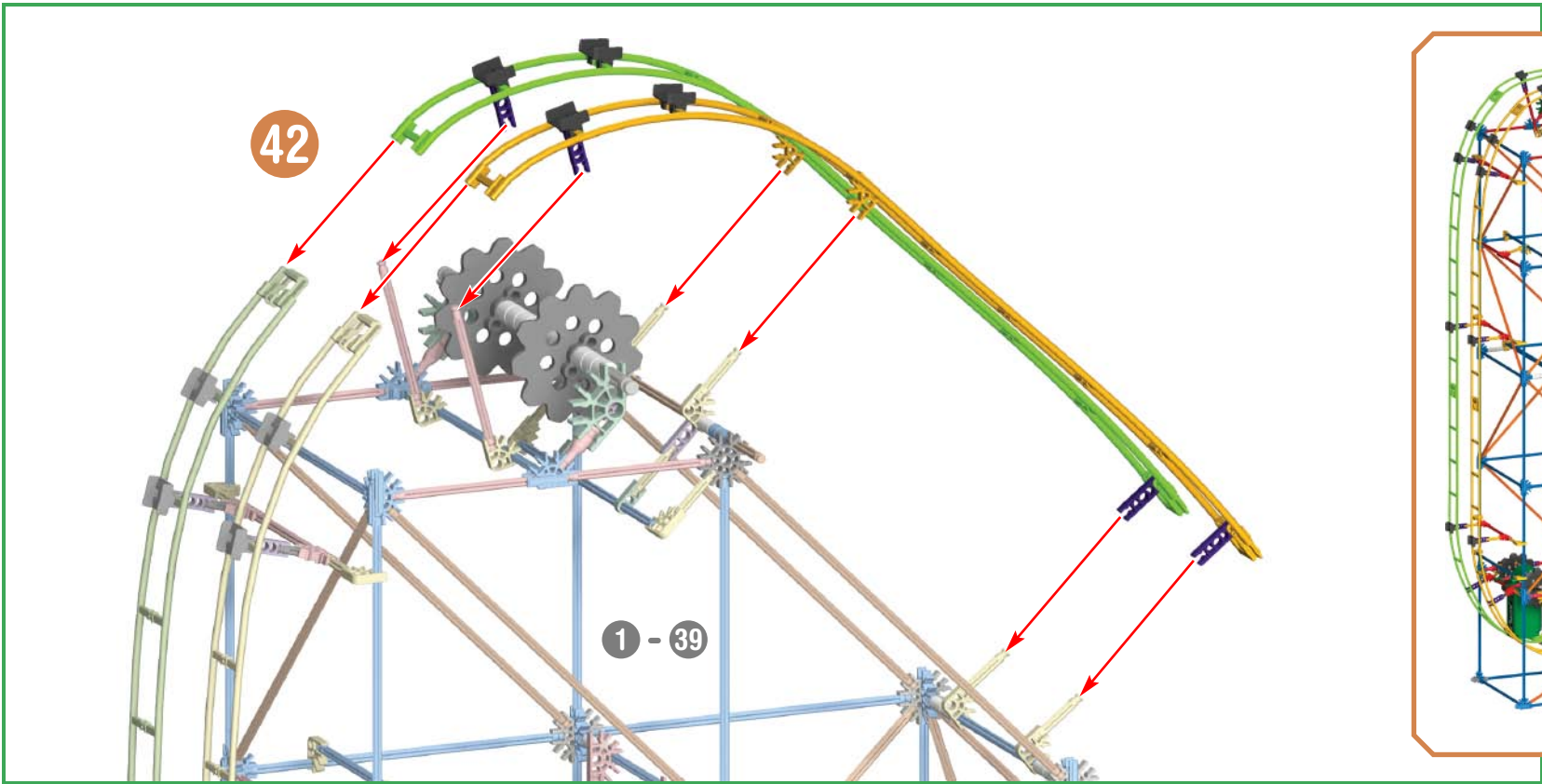
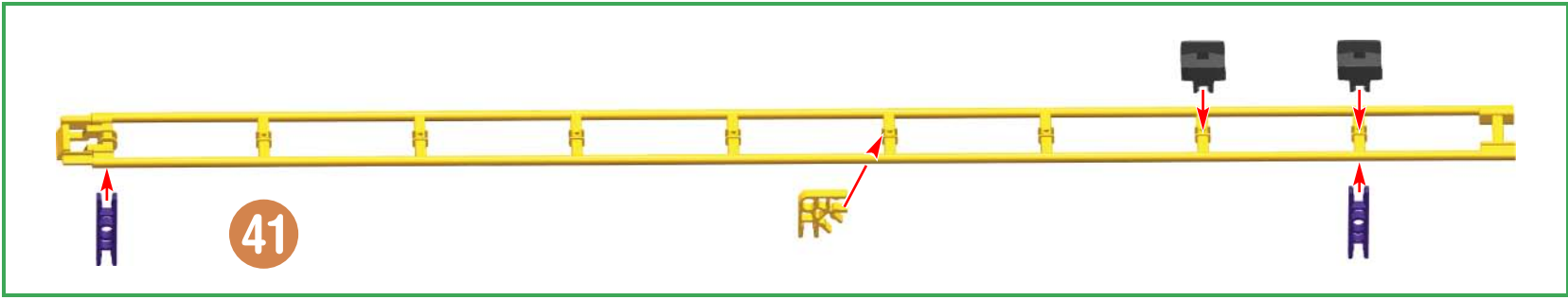
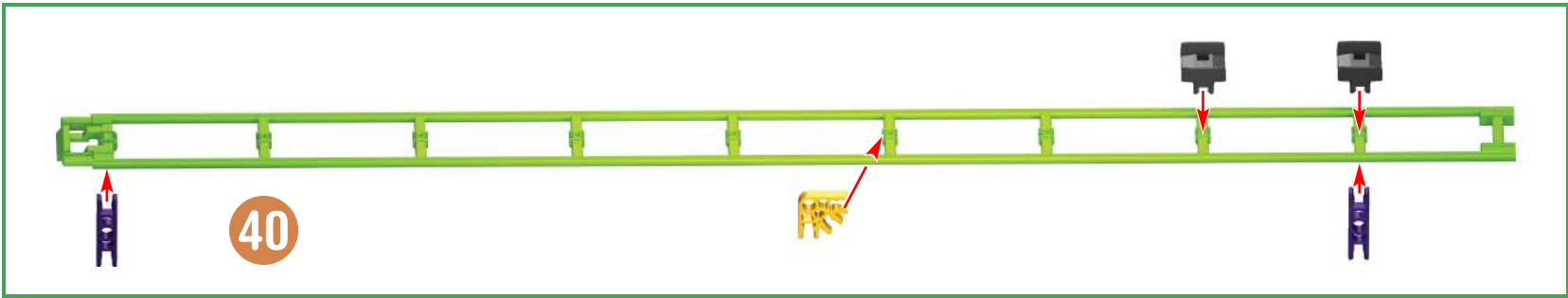

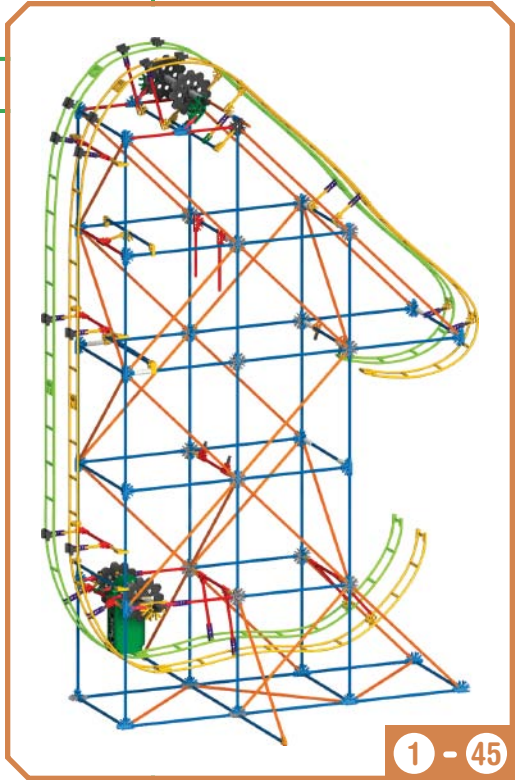
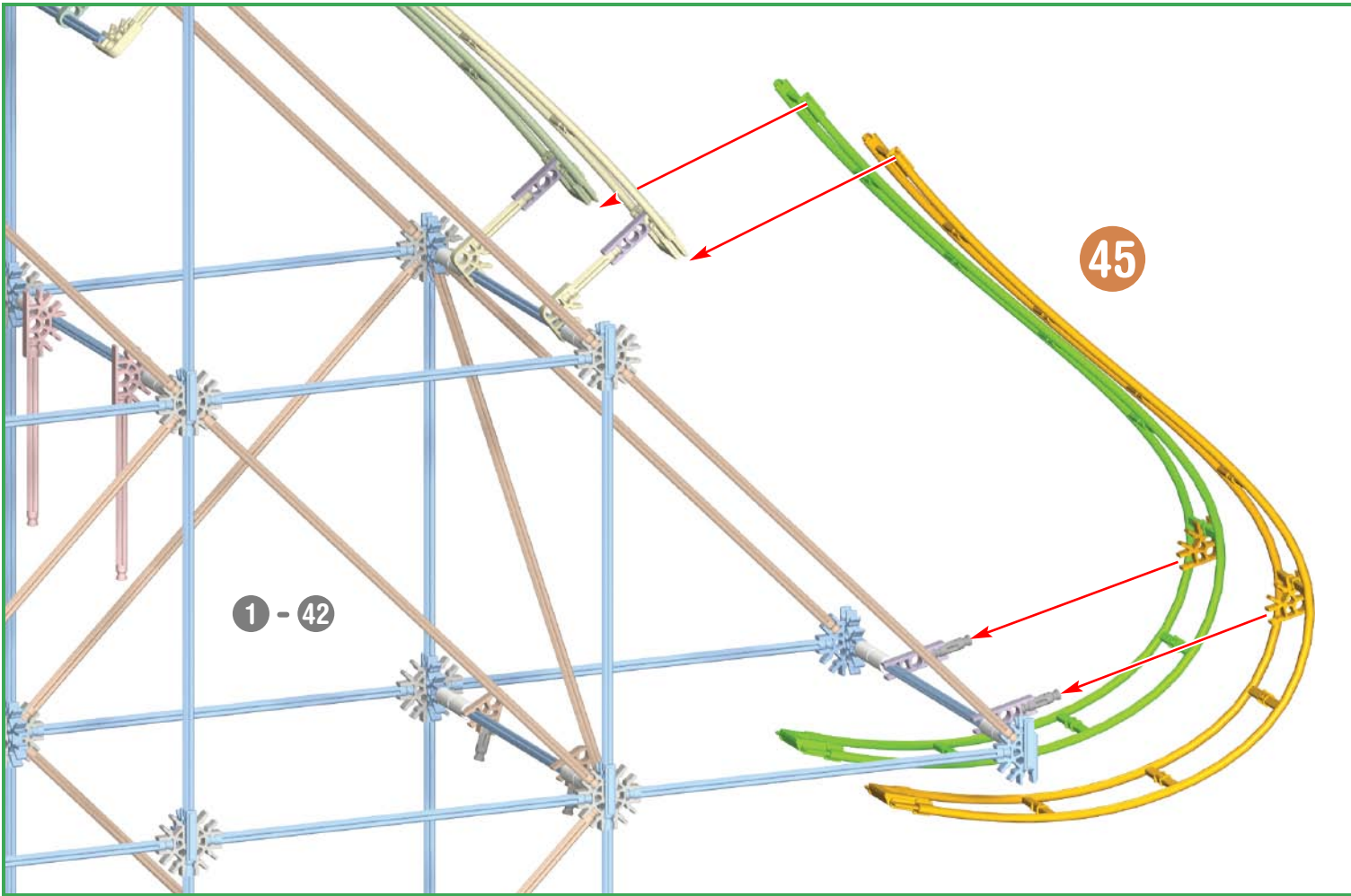
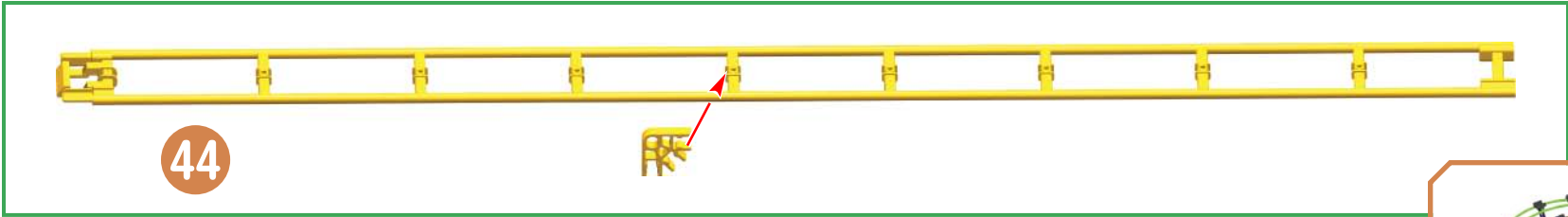
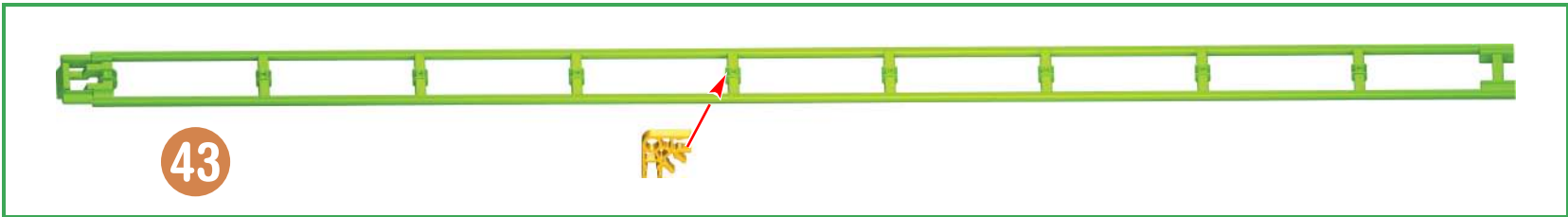

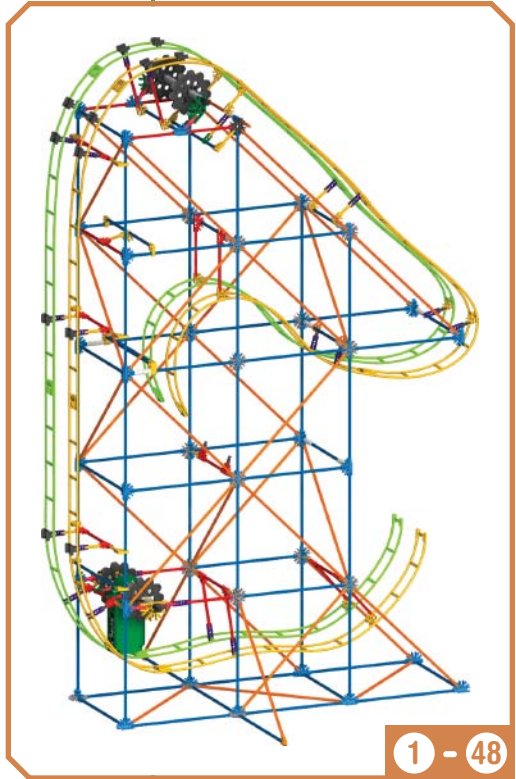
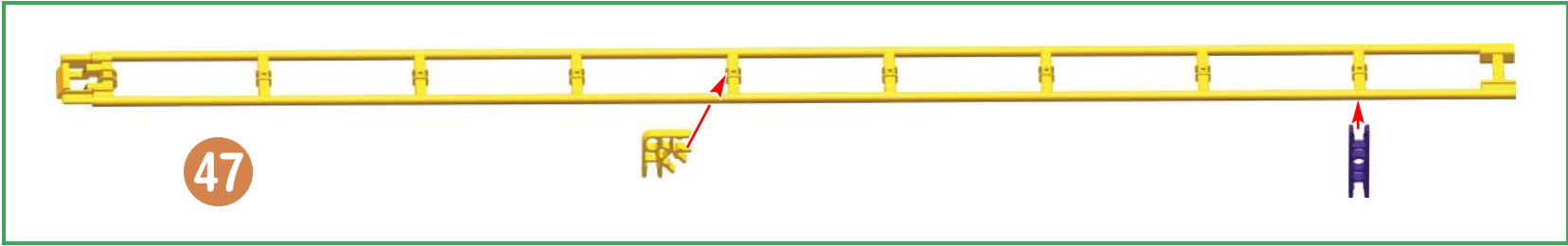
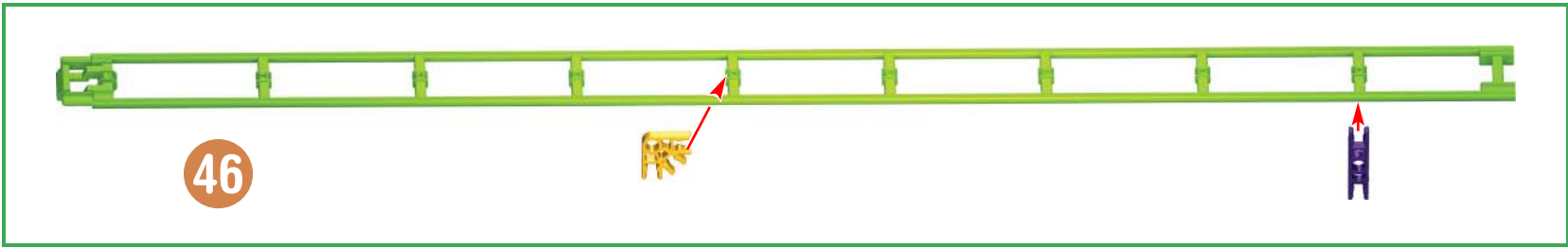

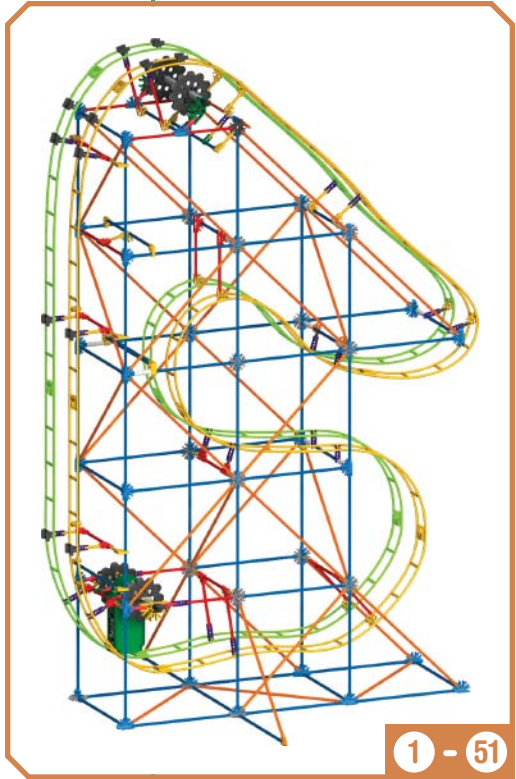
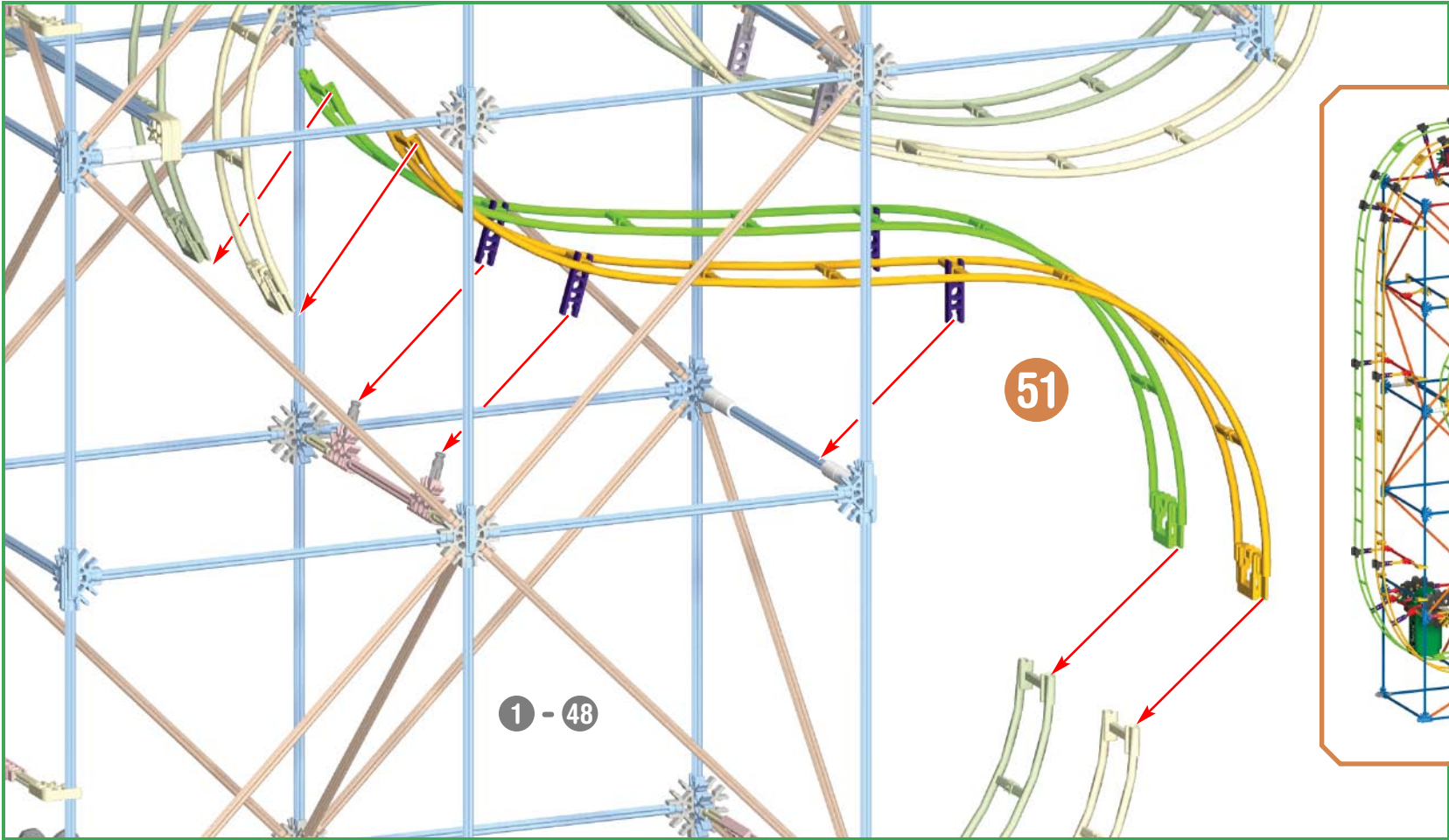
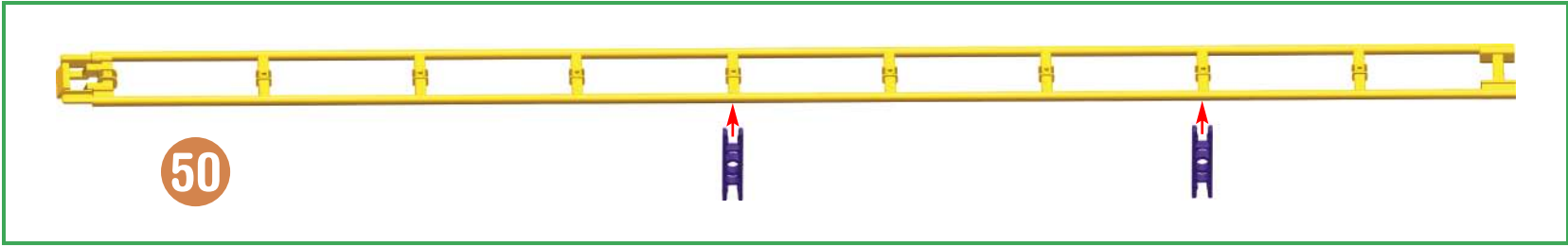
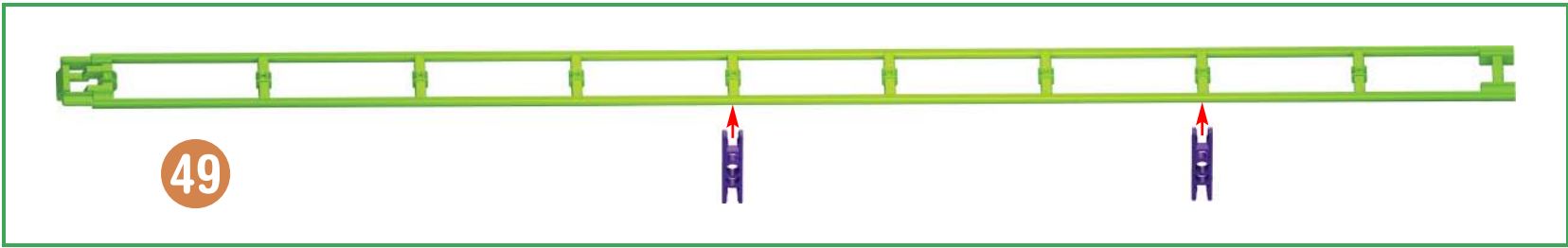

Attaching Chain Links

IMPORTANT:

Attach all the chain links in the same direction.



x10

52

x22

x3

53

x2

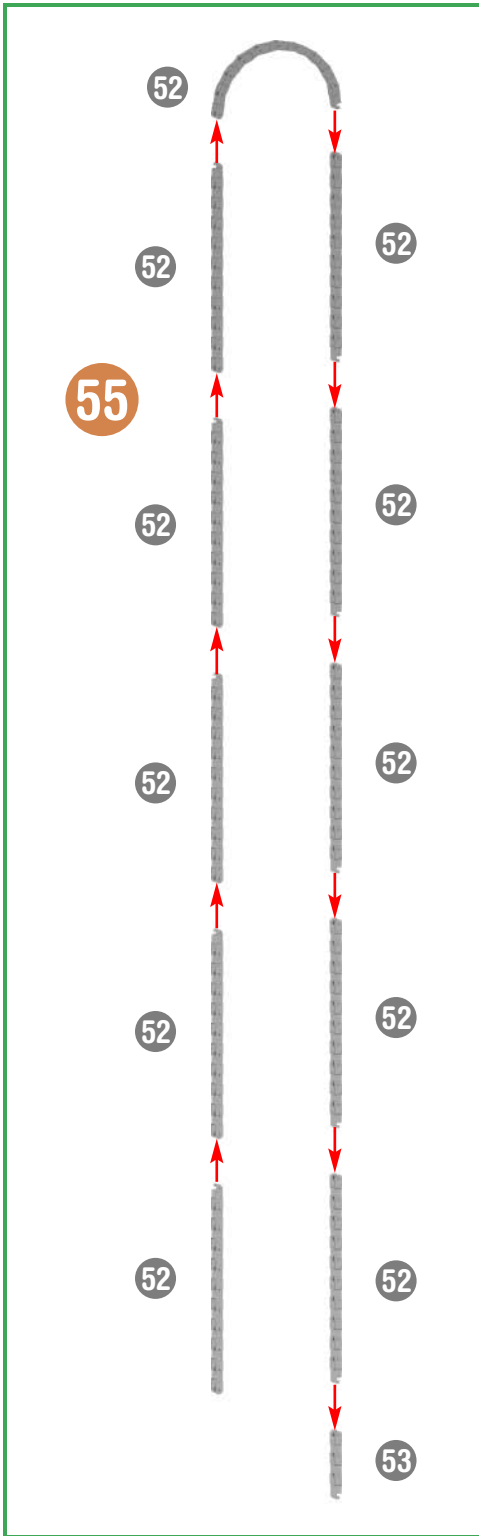
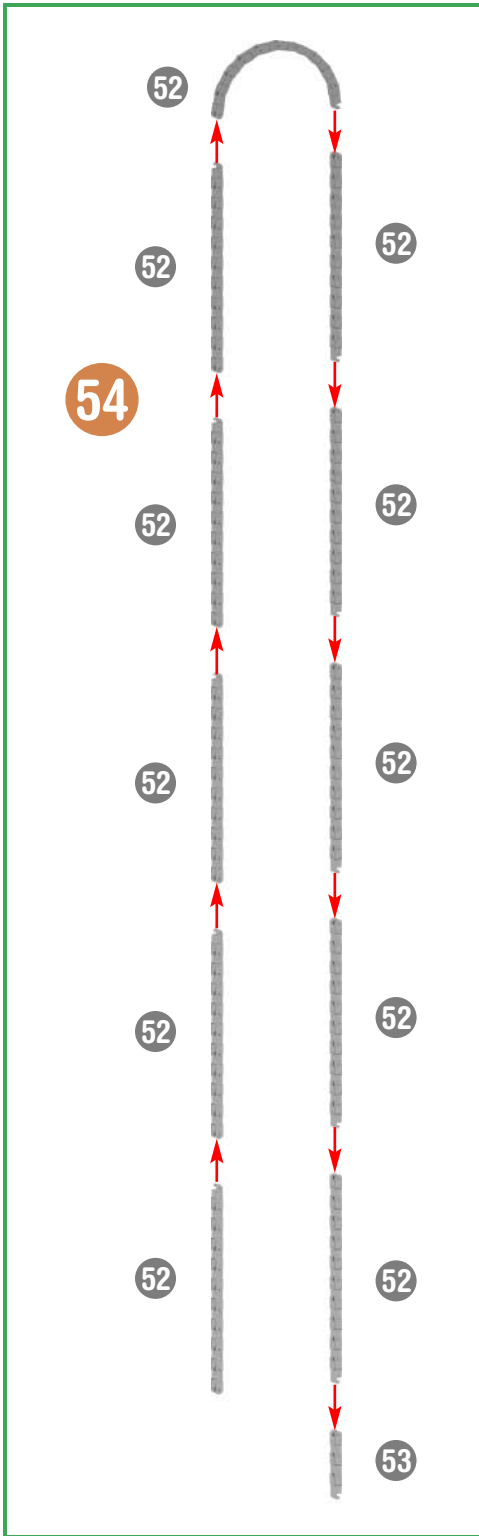

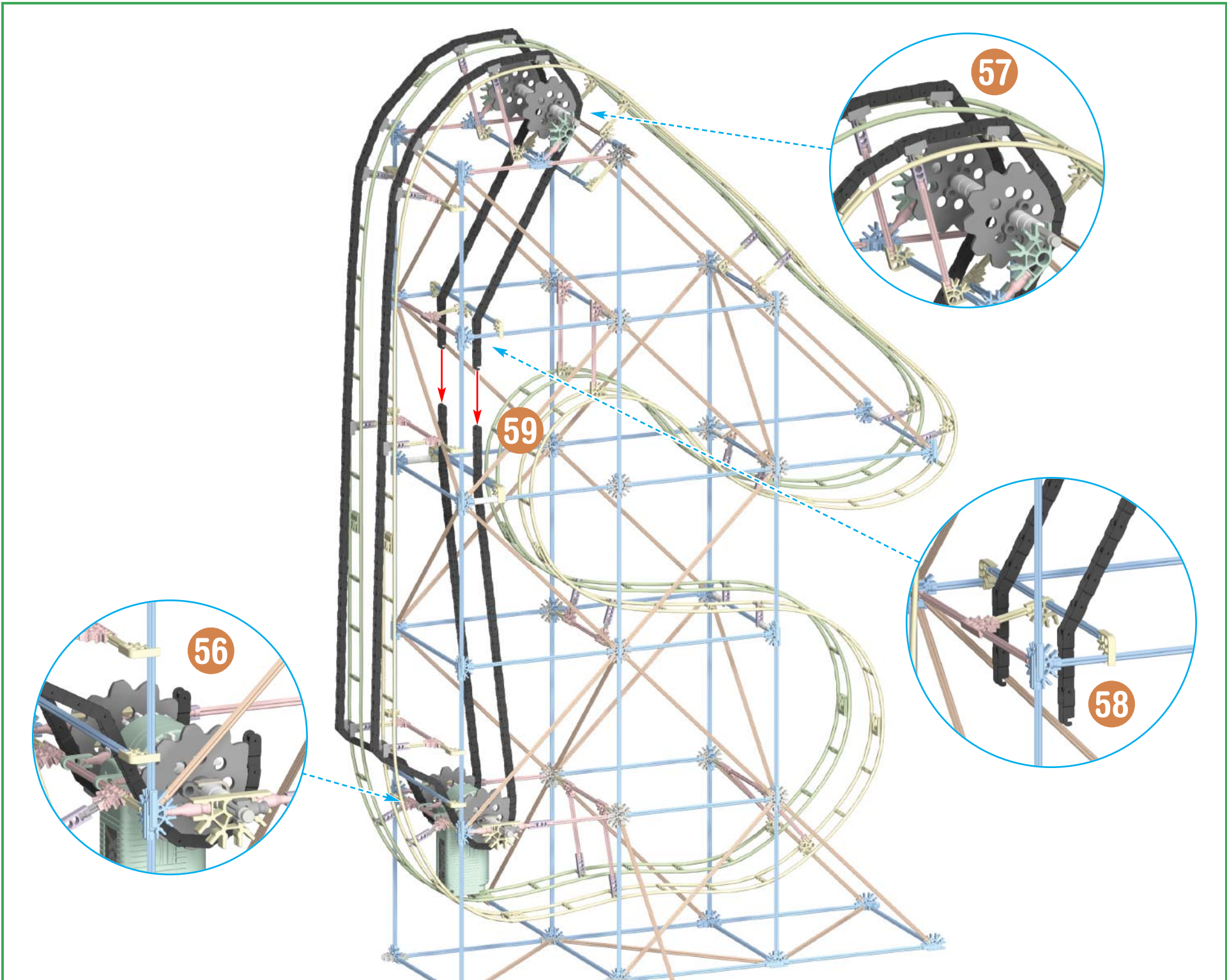



Attaching Coaster Cars

To attach the cars, slide them onto an open end of the track. If the cars get stuck on the way down, make sure they are not hitting any K'NEX parts.

THE SIDEWINDER™

