

K'NEX®

NEW METALLIC COLORS

12524

COBRA STRIKER

BUILDS 3 MODELS



WARNING:
CHOKING HAZARD – Small Parts.
Not for children under 3 years.

AVERTISSEMENT:
DANGER D'ÉTOUFFEMENT – Pièces de petite taille.
Ne pas donner aux enfants de moins de 3 ans.

ATENCIÓN: Peligro de asfixia: Por contener piezas pequeñas, no recomendable para niños menores de tres años.

COLOR CODED BUILDING SYSTEM

Congratulations!

You have discovered K'NEX, the award winning construction system that lets you build and bring to life anything you can imagine.

Stretch your imagination. Make the most of your creativity. And have a ton of fun building, too.

Your set has everything you need to turn K'NEX parts into totally cool models. The instructions get you going, but the fun doesn't stop there. Design your own models! Make your own K'NEX world.

And check out the other great K'NEX Sets, with exciting themes and models for kids of all ages!

Visit the K'NEX website at www.knex.com.
Questions? Call us at 1-800-KID-KNEX.

Félicitations ! Vous venez de découvrir K'NEX, un système de construction unique qui vous permettra de créer tout un monde imaginaire.

Laissez-vous guider par votre imagination, écoutez votre esprit créateur et amusez-vous à construire des modèles pendant des heures.

Vous trouverez dans cette boîte toutes les pièces et accessoires nécessaires pour créer de super modèles. Ces instructions ne sont qu'un exemple. Ne vous y limitez pas. Inventez d'autres modèles et bâtissez votre univers K'NEX !

N'oubliez pas non plus d'essayer les autres kits K'NEX qui vous proposeront encore plus de thèmes et de modèles pour enfants de tous les âges !

Visitez le site K'NEX au www.knex.com ou appelez-nous au 1-800-KID-KNEX.

¡Enhorabuena! Has descubierto K'NEX, el sistema de construcción galardonado, que te permite construir y hacer que cobre vida todo aquello que puedas imaginarte.

¡Da rienda suelta a tu imaginación! ¡Sácale partido a tu creatividad! Y, de paso, ¡diviértete de lo lindo!

Este juego tiene todo lo que necesitas para crear, con las piezas K'NEX, los modelos más divertidos. Las instrucciones te muestran el camino, pero el juego no tiene límites.

¡Diseña tus propios modelos! ¡Crea tu propio mundo K'NEX!

Y no olvides que hay muchos otros sets K'NEX para niños de todas las edades, con temas y modelos que te encantarán.

Visita el sitio de K'NEX en la Web, www.knex.com, o llámanos al 1-800-KID-KNEX.



Each K'NEX piece has its own color and shape; match it to pieces in the picture instructions. Put pieces together exactly as pictures show. Be sure to put Rods in the correct slots of Connectors, so you have proper angles in your finished model.

Chaque pièce K'NEX a une couleur et une forme bien à elle. Faites correspondre et montez les pièces les unes sur les autres en suivant exactement les instructions illustrées. Assurez-vous de bien assembler les tiges dans les fentes des connecteurs afin d'obtenir des angles corrects une fois le modèle fini.

Assurez-vous de bien assembler les tiges dans les fentes des connecteurs afin d'obtenir des angles corrects une fois le modèle fini. Asegurarse de colocar las varillas en las ranuras correctas de los conectores, de modo que al terminar el modelo, los ángulos sean los adecuados.

Faded colors indicate sections previously built; connecting points will be in full color.

Les couleurs plus claires indiquent les sections déjà construites. Les points de jonction sont indiqués en couleurs vives.

Los colores apagados indican secciones que ya han sido montadas anteriormente. Los puntos de conexión se indican con colores vivos.

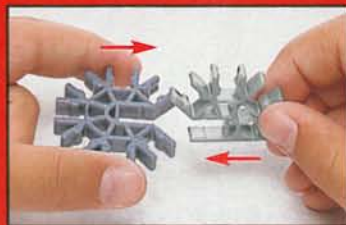
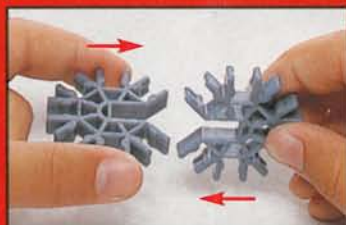
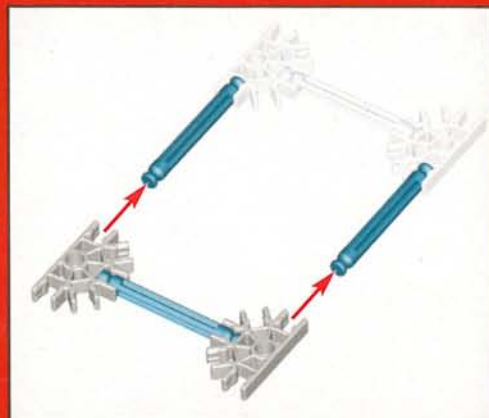

It's very important to position blue and silver Connectors in a specific direction. Pay close attention to the instructions, and position these Connectors horizontally or vertically exactly as they are shown. Push together tightly until you hear a "click".

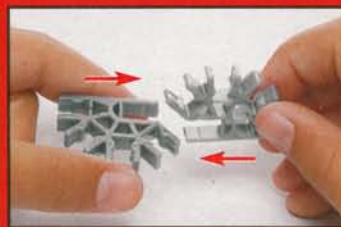

Il est important de bien placer les connecteurs bleus et argentés dans le bon sens. Lisez attentivement les instructions et placez ces connecteurs horizontalement ou verticalement selon l'indication. Appuyez dessus en forçant légèrement jusqu'à ce que vous entendiez un dé clic.

es muy importante colocar los conectores de color azul y plata en una dirección específica. Prestar mucha atención a las instrucciones y colocar estos conectores según se indica, ya sea horizontal o verticalmente. Para conectarlos, presionar hasta oír un "clic".

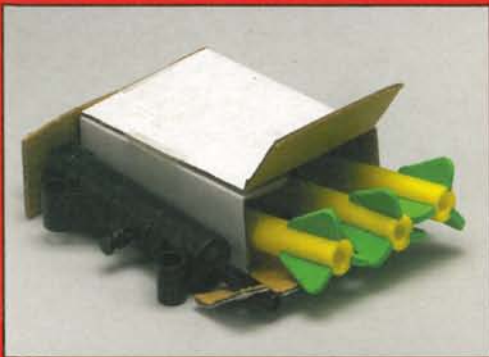

This set contains 1 launcher and 3 foam missiles as shown. Additional Foam Missiles are available for purchase. Call 1-800-KID-KNEX, Monday through Friday 8:30 AM - 5:00 PM (EST).

Des Missiles en Mousse supplémentaires peuvent être achetés séparément en appelant gratuitement le 1-800-KID-KNEX du Lundi au Vendredi de 8 H 30 à 17 H (Heure de la Côte EST).

Si desea comprar más Misiles de Espuma. Llame al 1-800-KID-KNEX, de Lunes a Viernes, de 8:30 AM a 5:00 PM (Horario de la Costa Este).

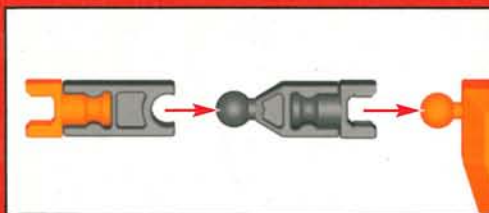

Push to snap together.

Enfoncez les pièces pour les imbriquer.

Empuja las piezas para que encajen a presión.



FIGURE

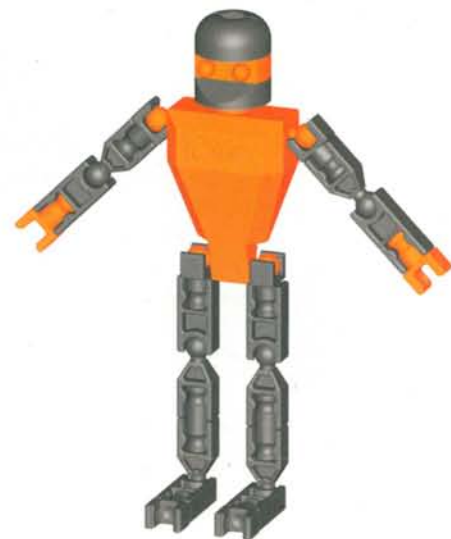

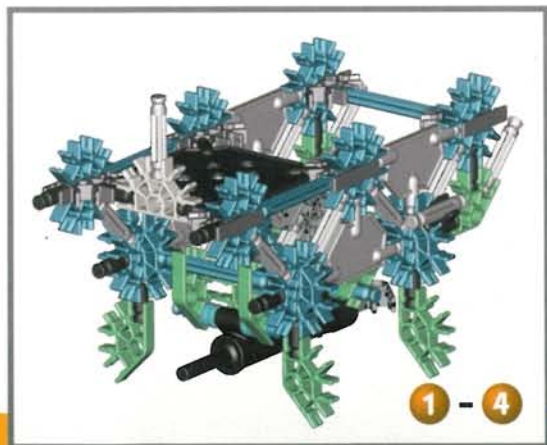
COBRA STRIKER

1 - 4

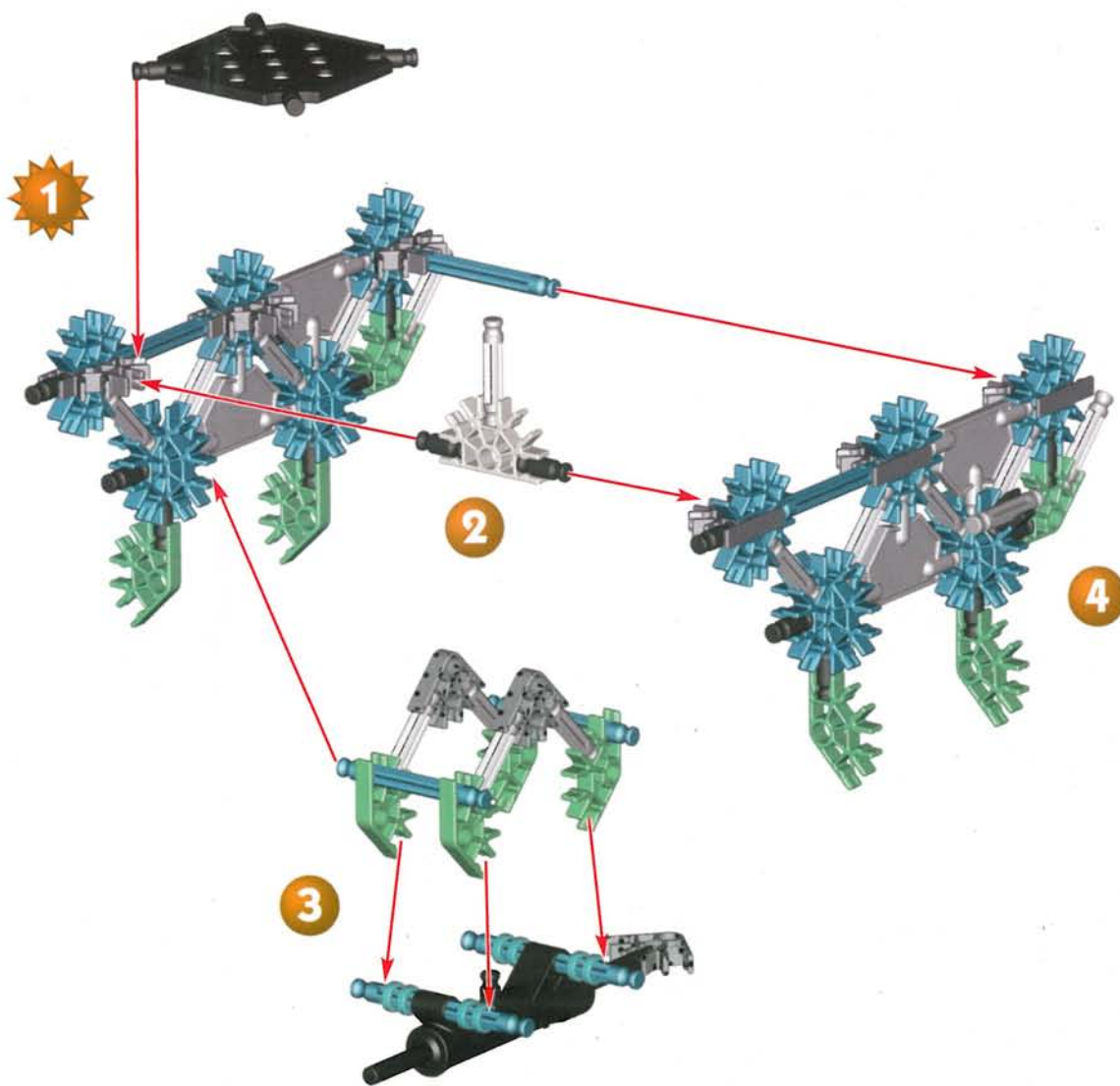

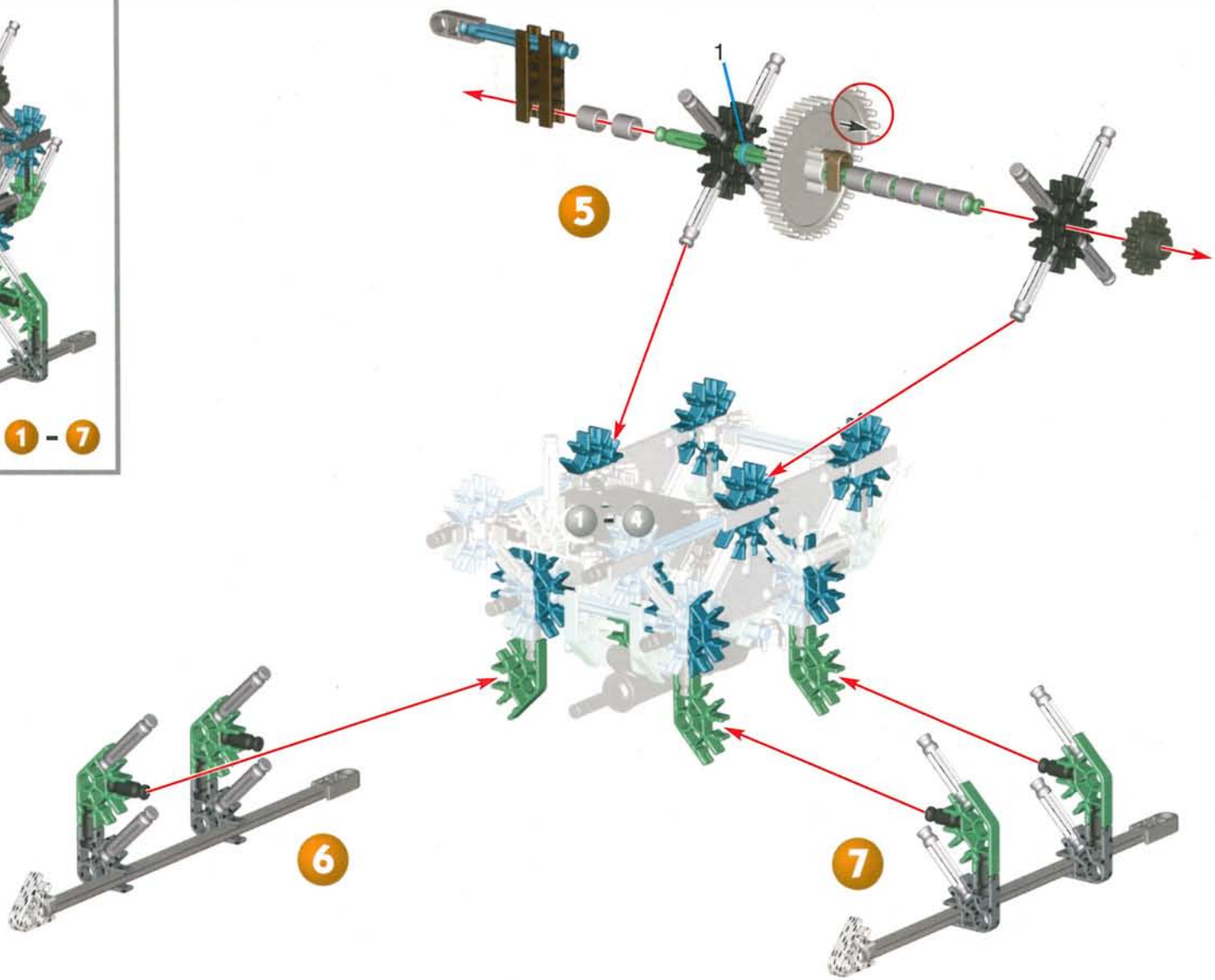
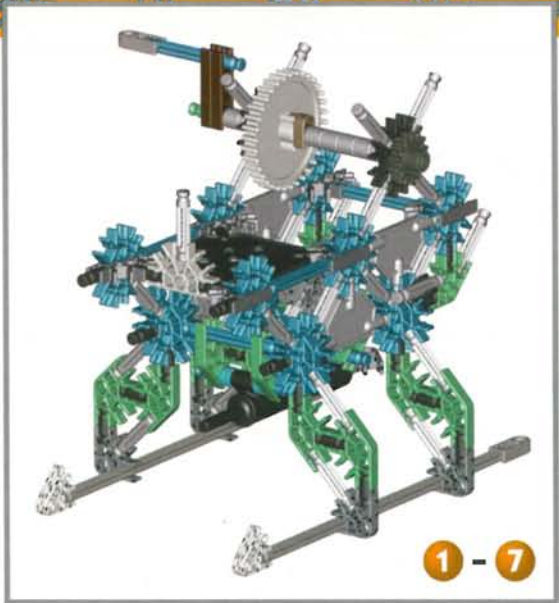

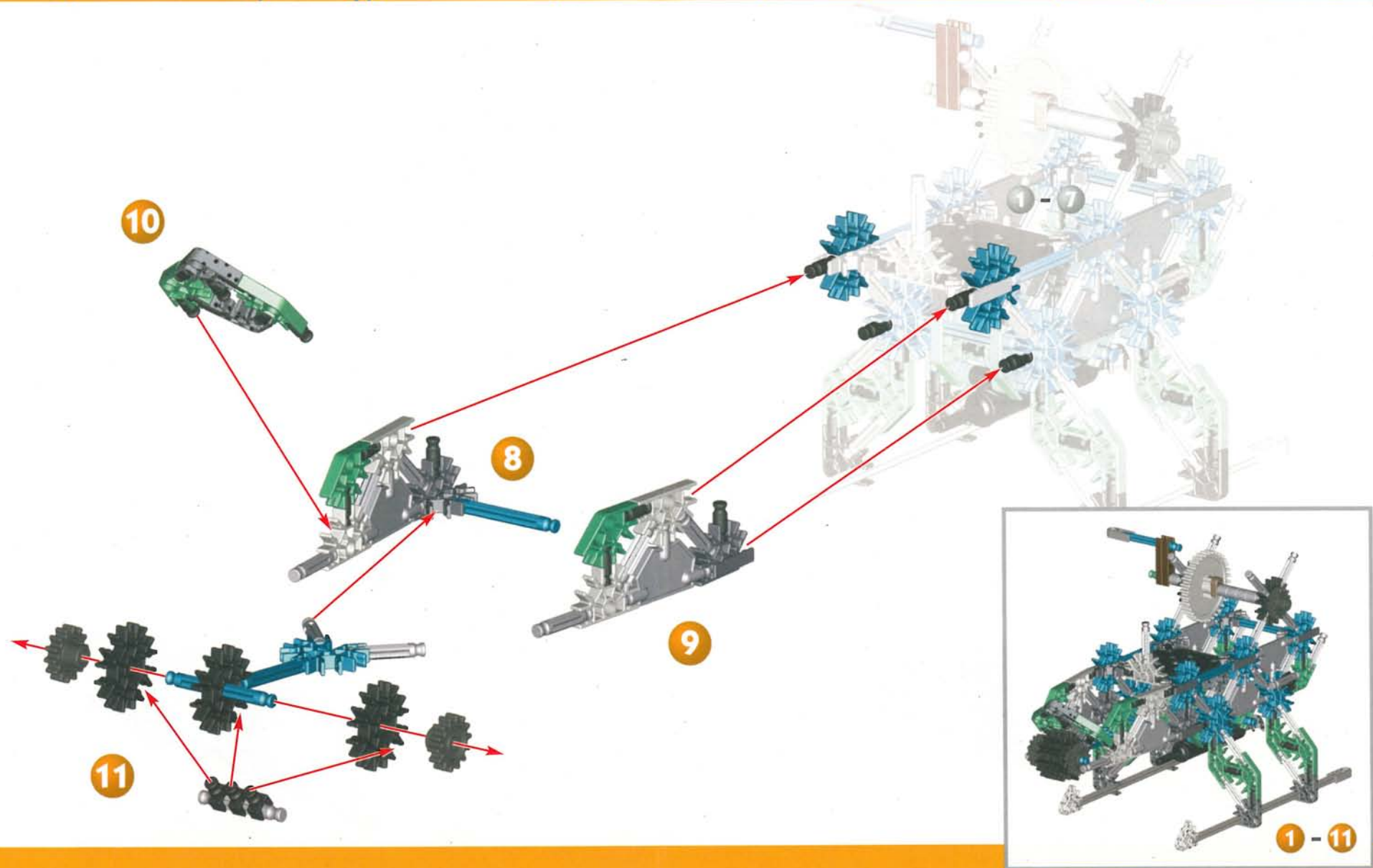

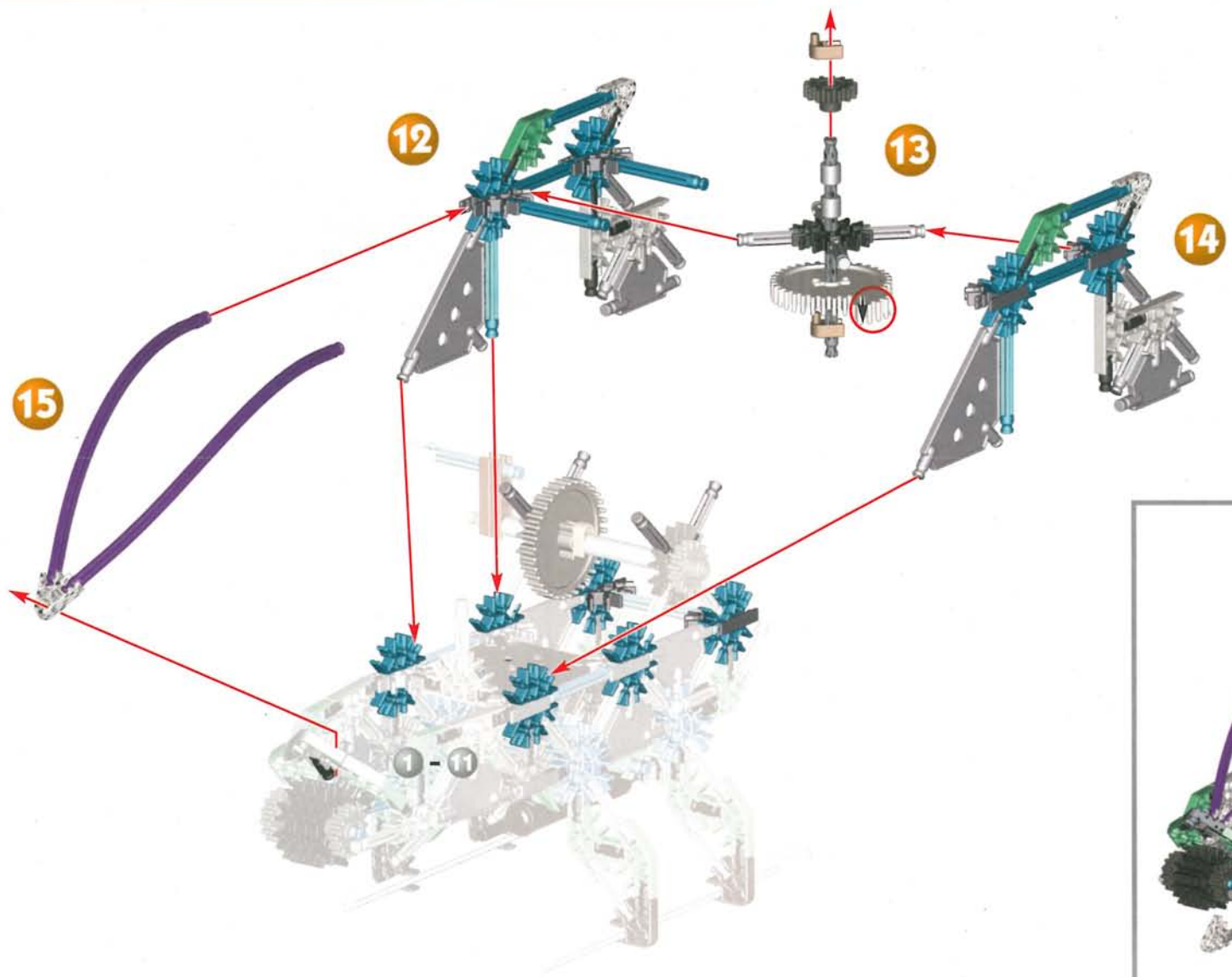

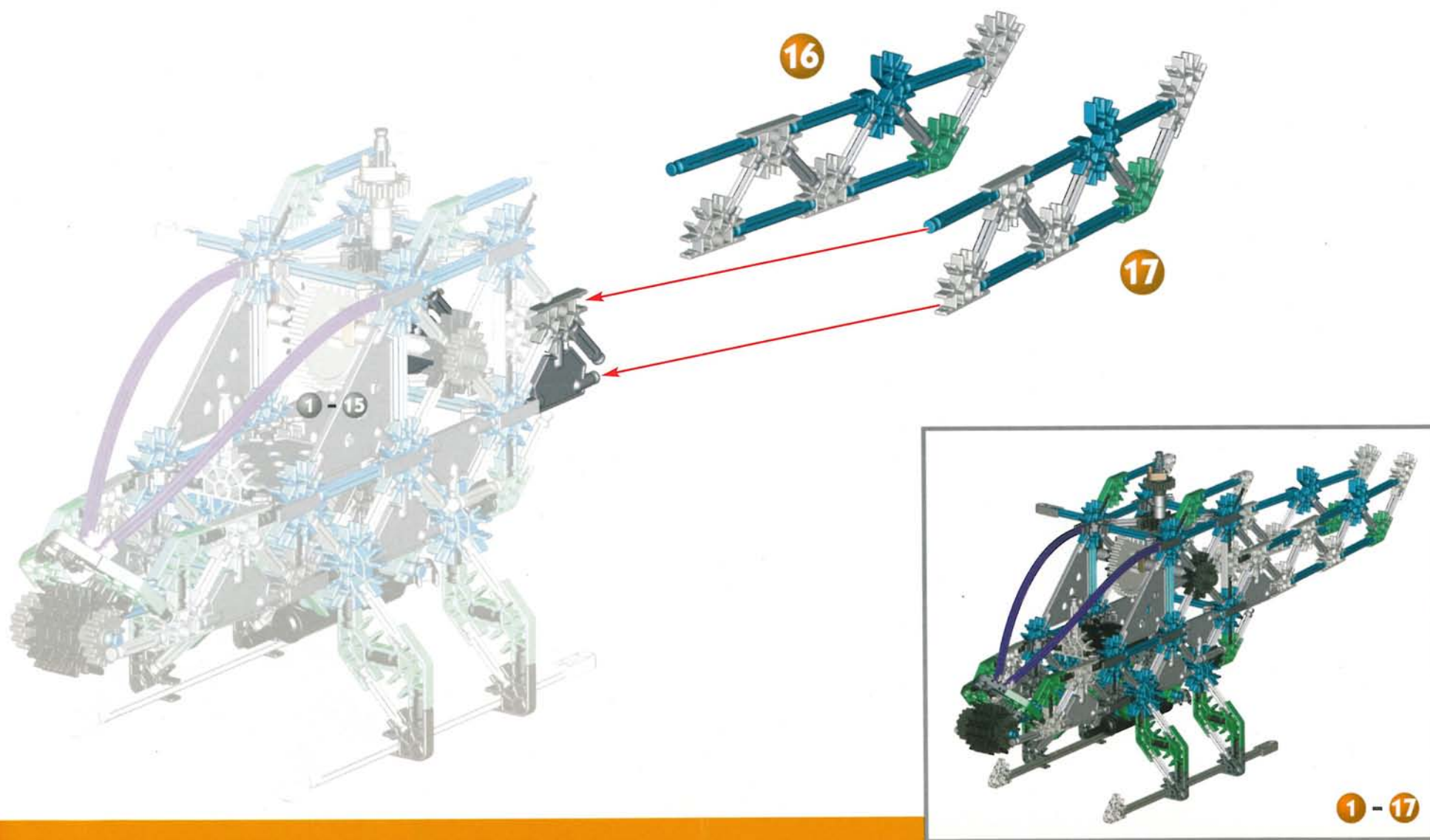

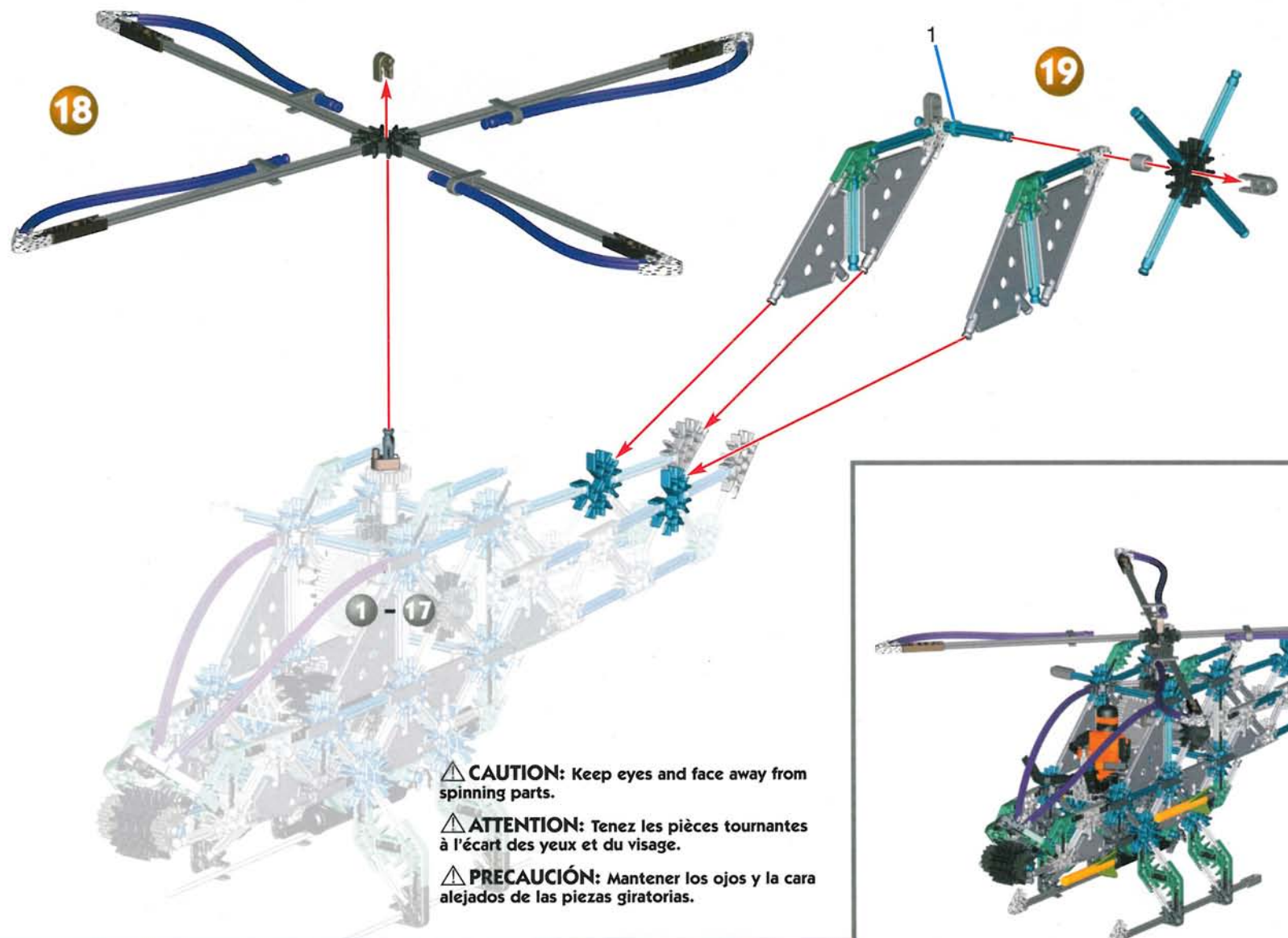

⚠ **CAUTION:** Keep eyes and face away from spinning parts.

⚠ **ATTENTION:** Tenez les pièces tournantes à l'écart des yeux et du visage.

⚠ **PRECAUCIÓN:** Mantener los ojos y la cara alejados de las piezas giratorias.

STRIKER COPTER

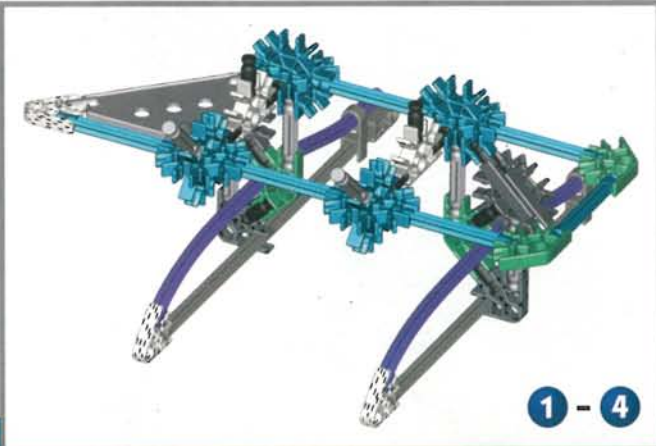
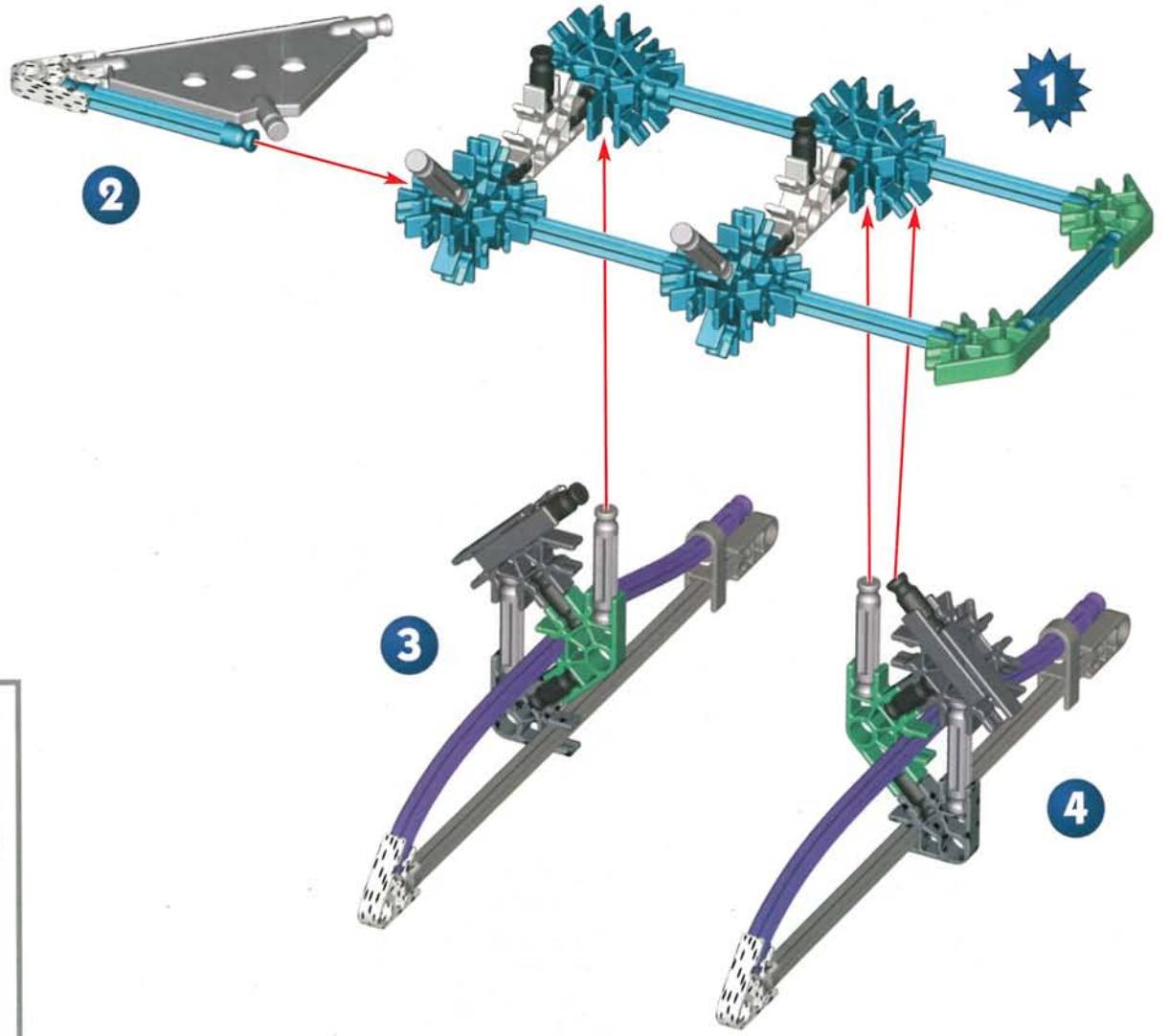
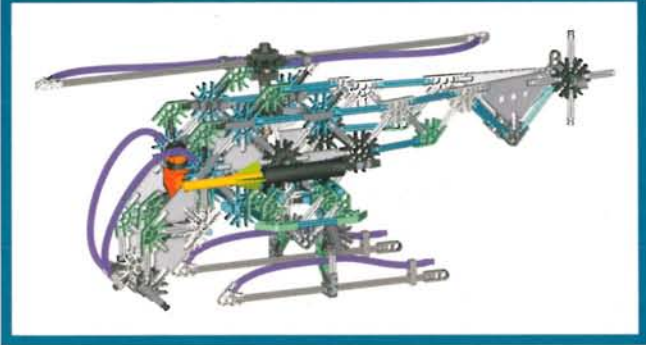

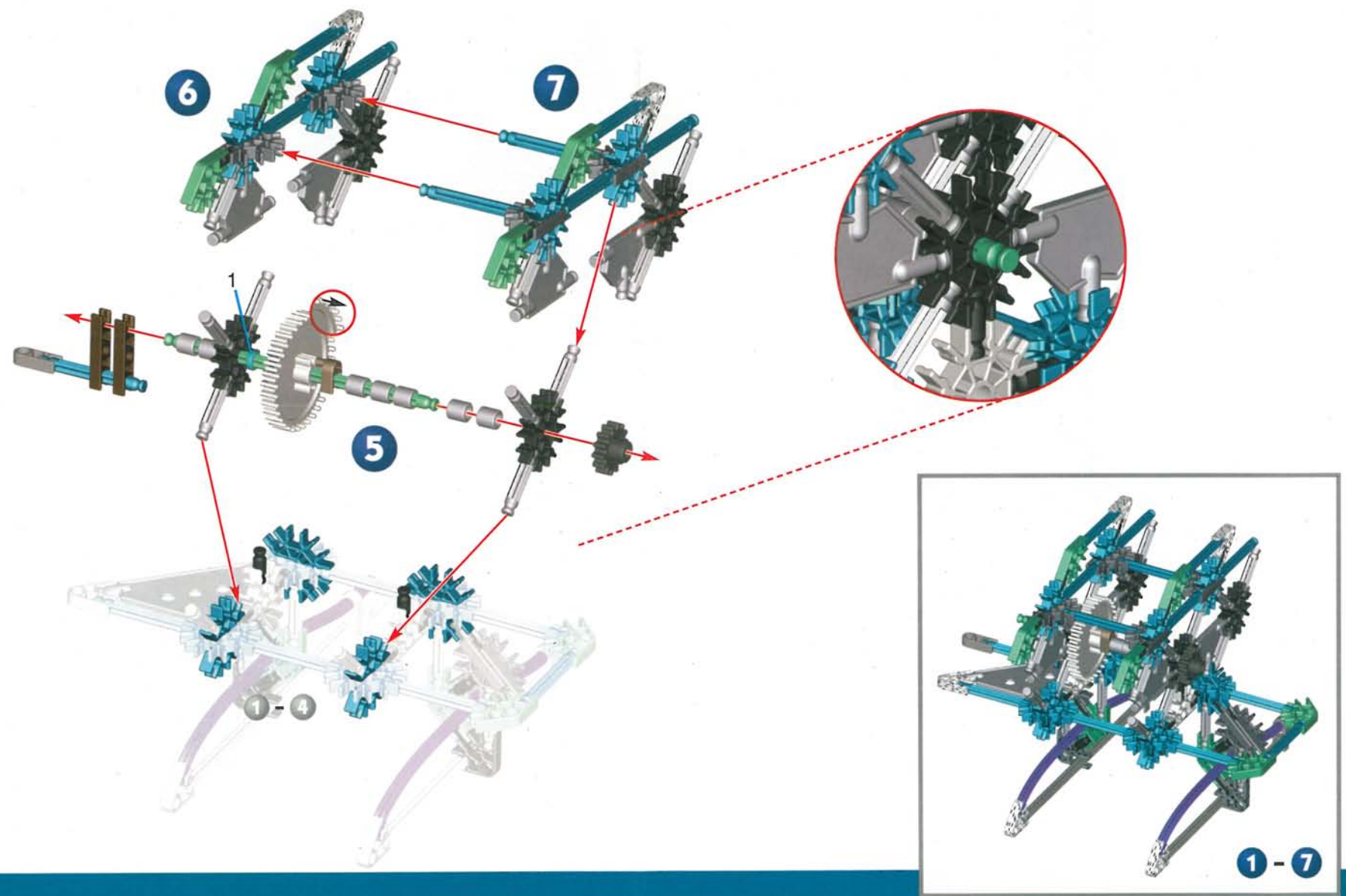

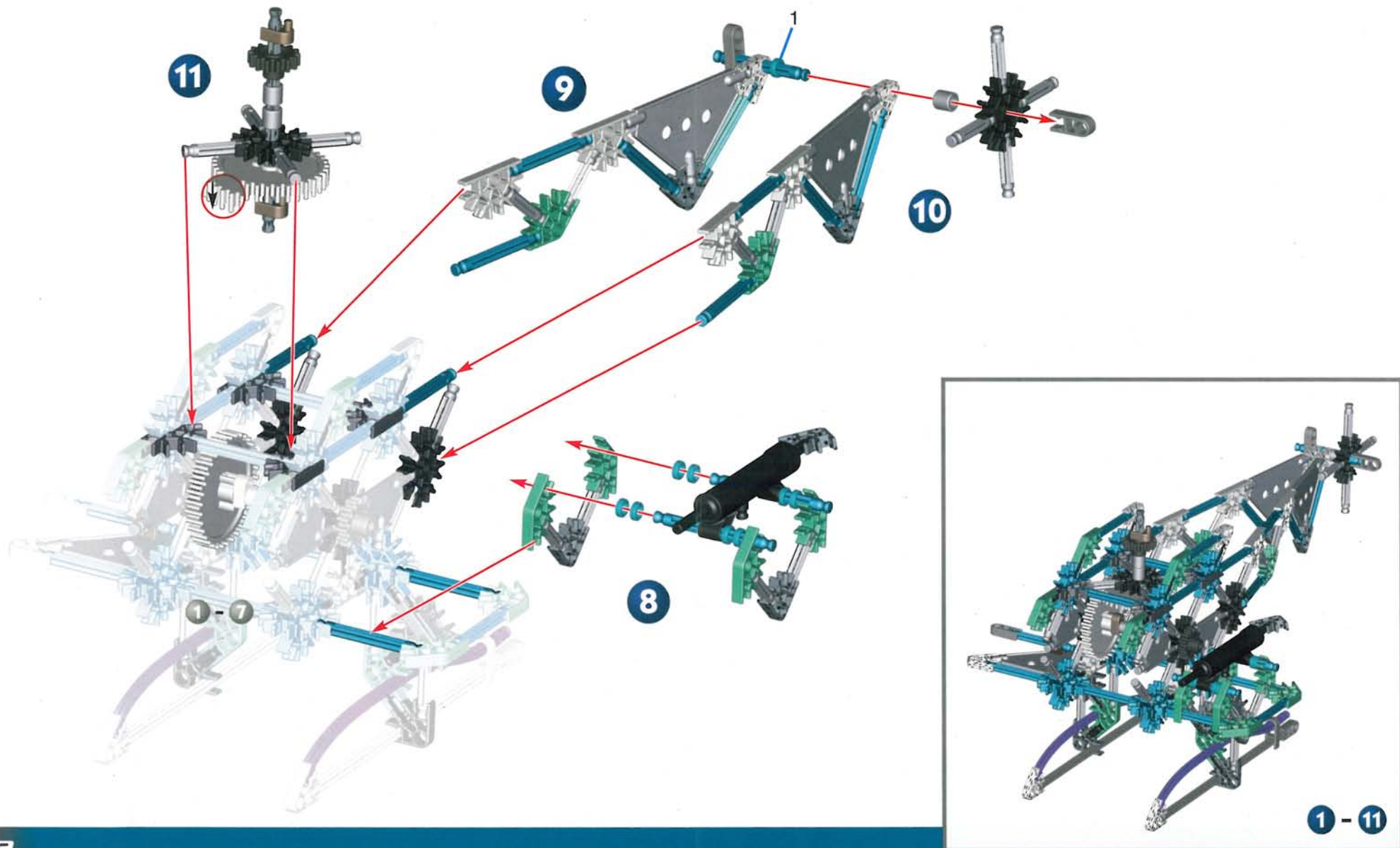

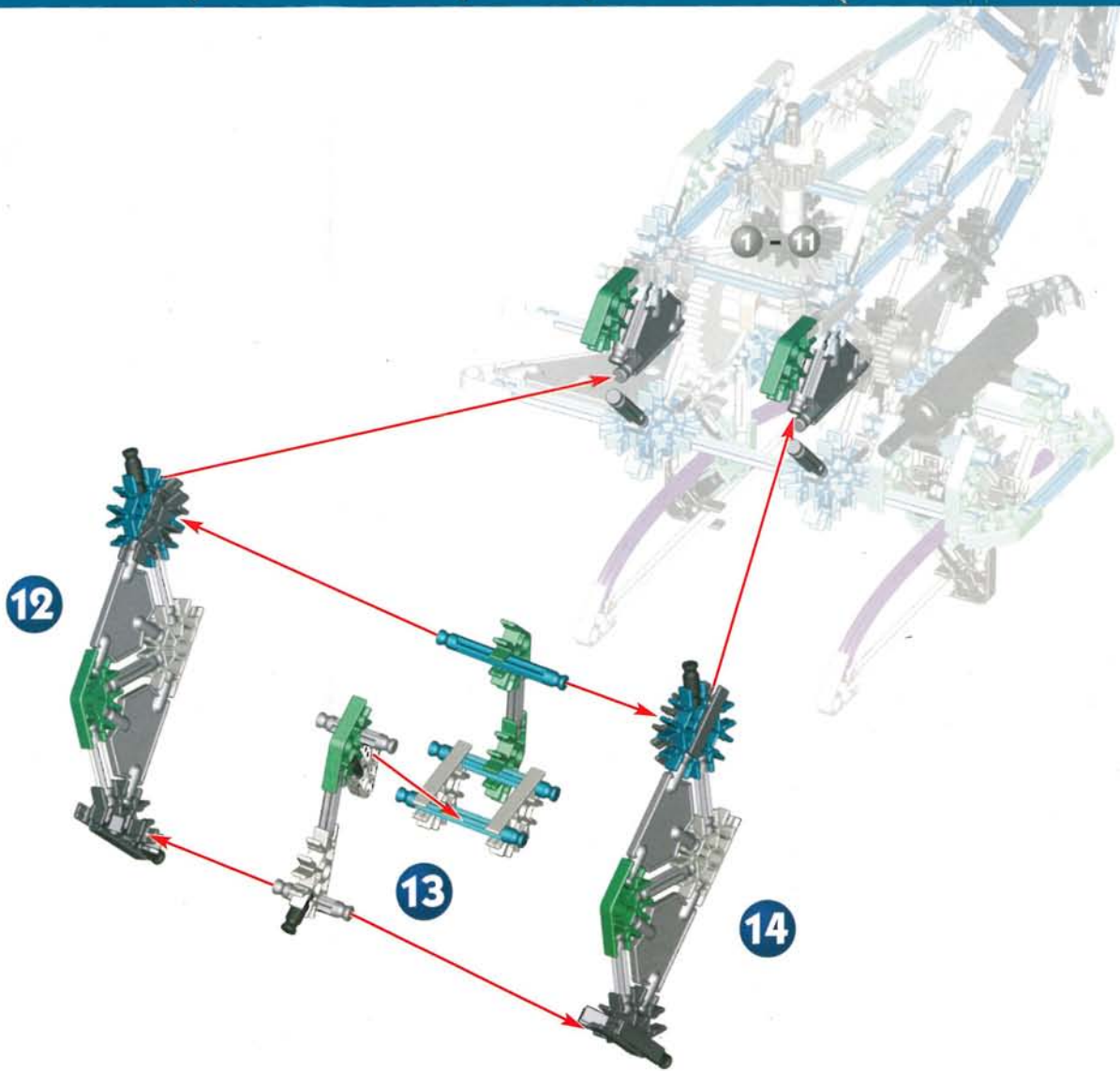
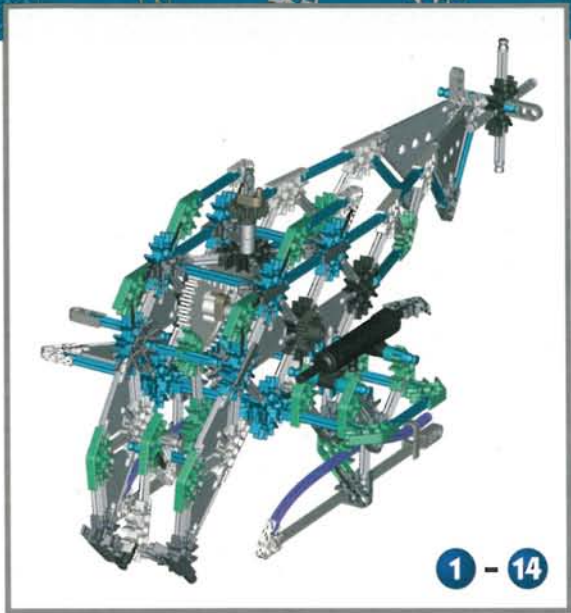



1 - 16

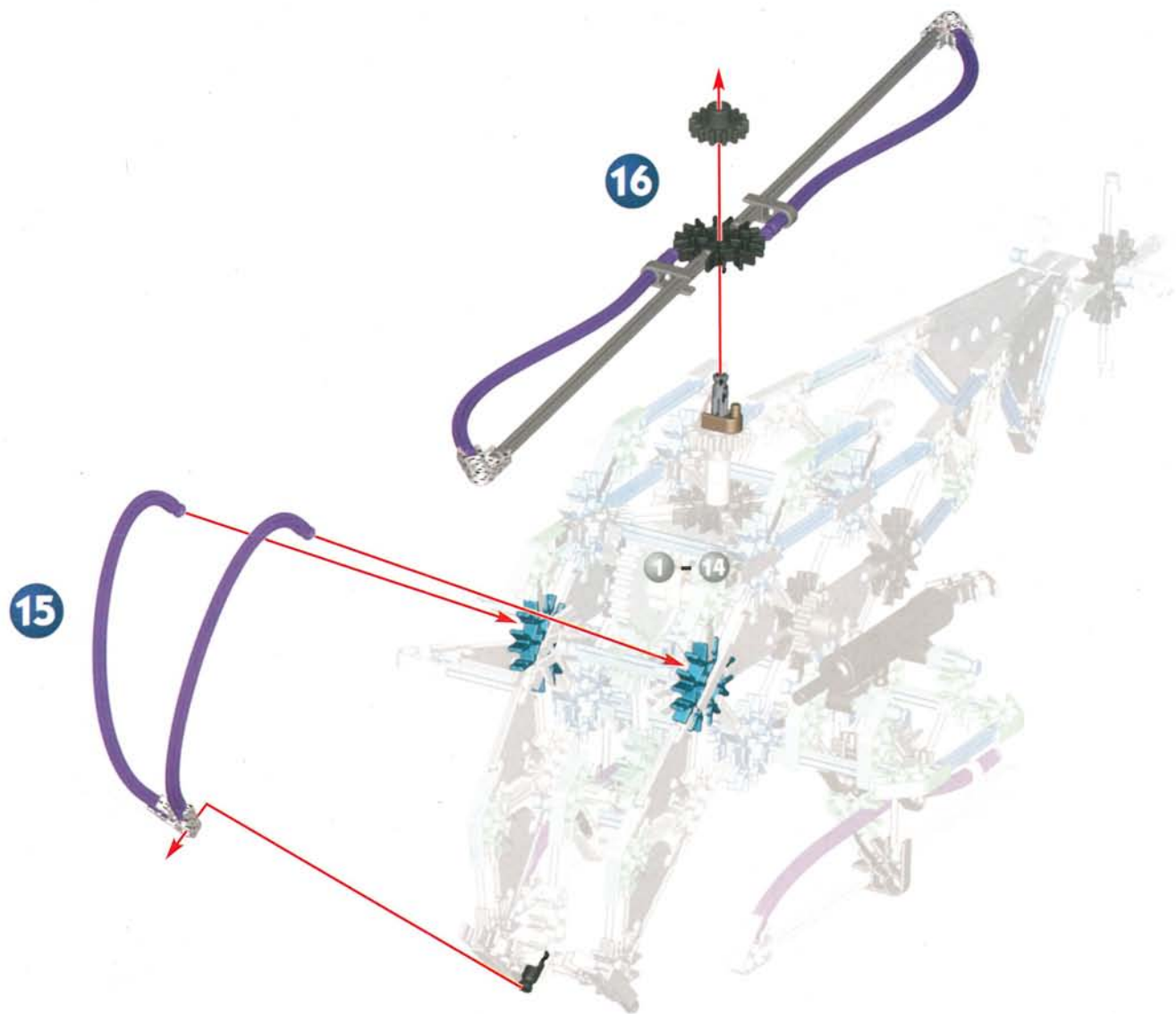

⚠ CAUTION: Keep eyes and face away from spinning parts.

⚠ ATTENTION: Tenez les pièces tournantes à l'écart des yeux et du visage.

⚠ PRECAUCIÓN: Mantener los ojos y la cara alejados de las piezas giratorias.

STRIKER CRAFT

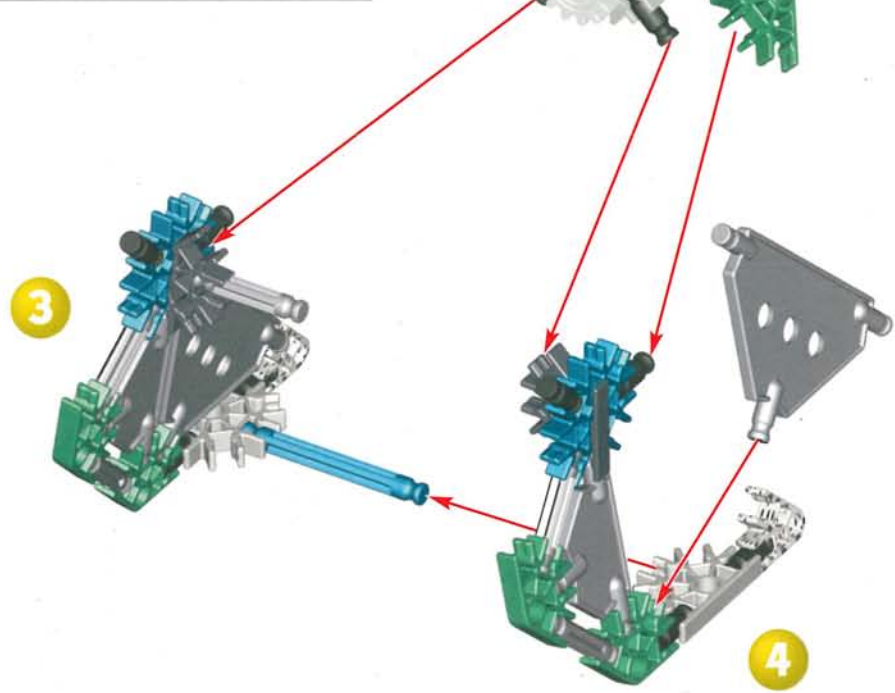
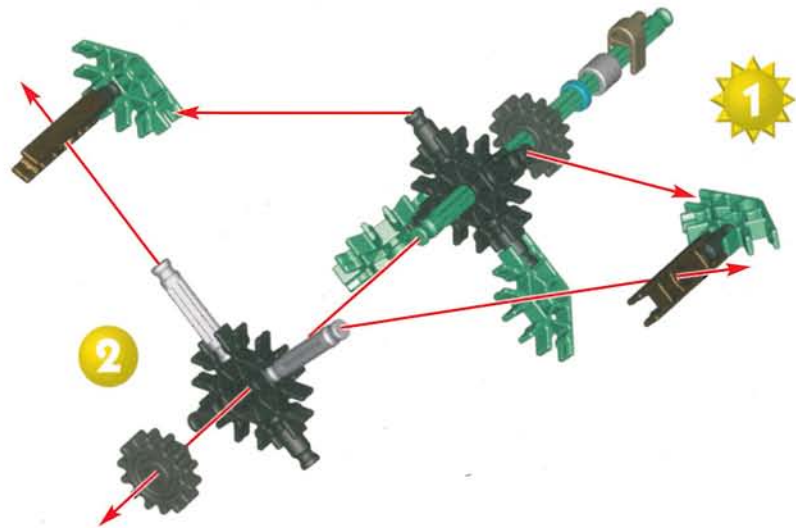
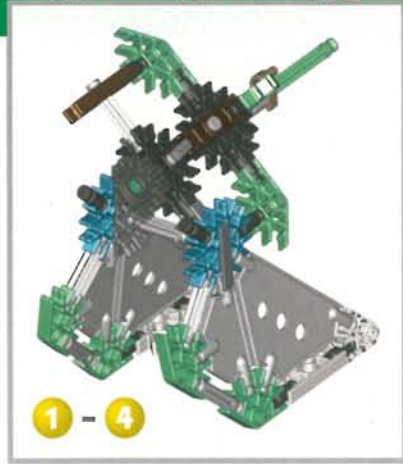
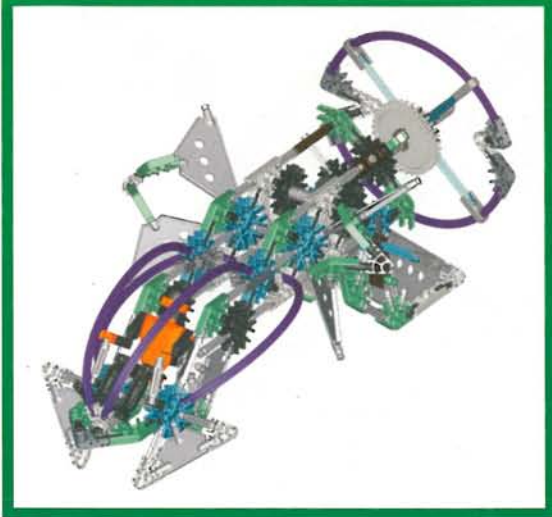



Put a gray connector here to keep Rod from slipping out

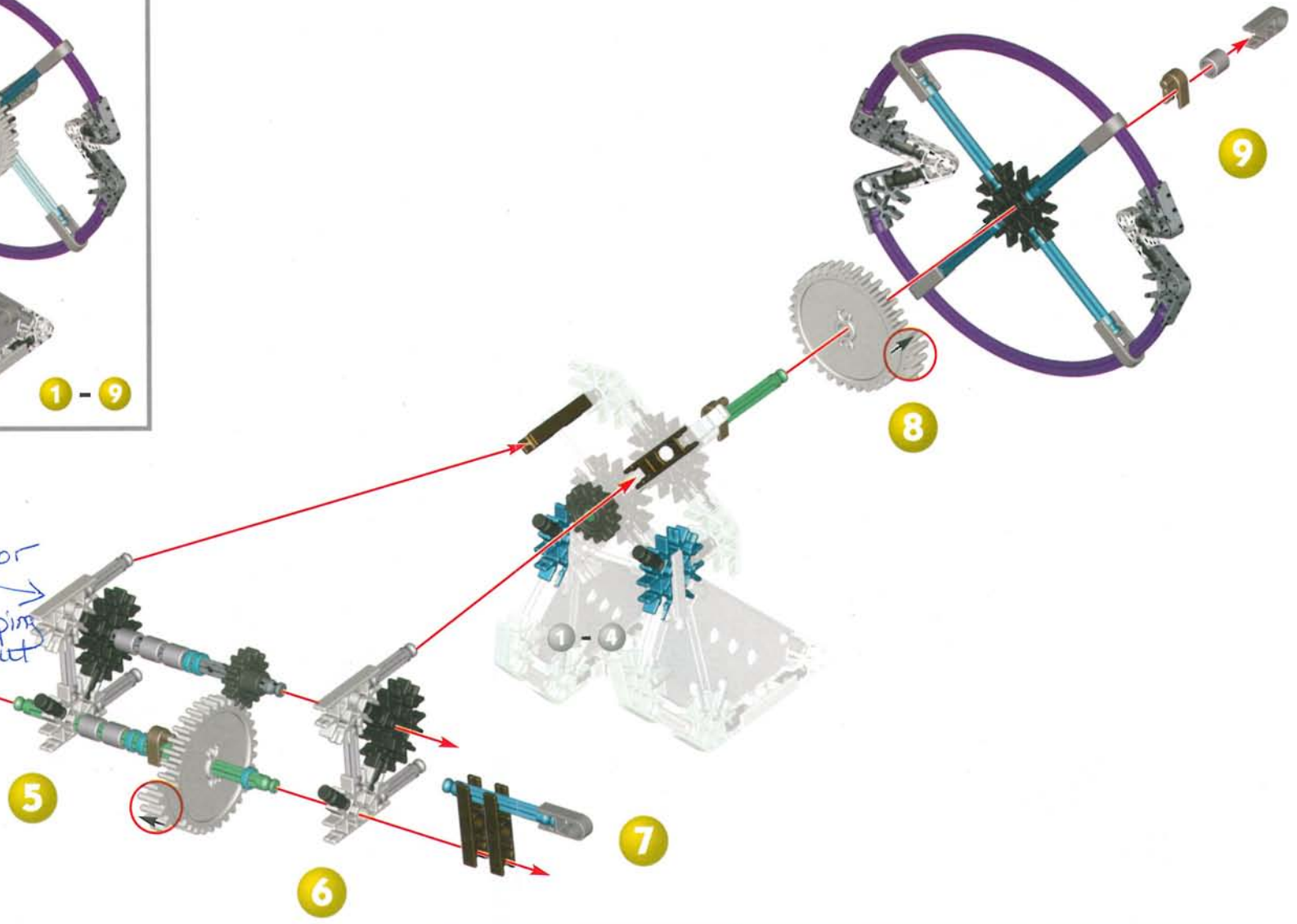

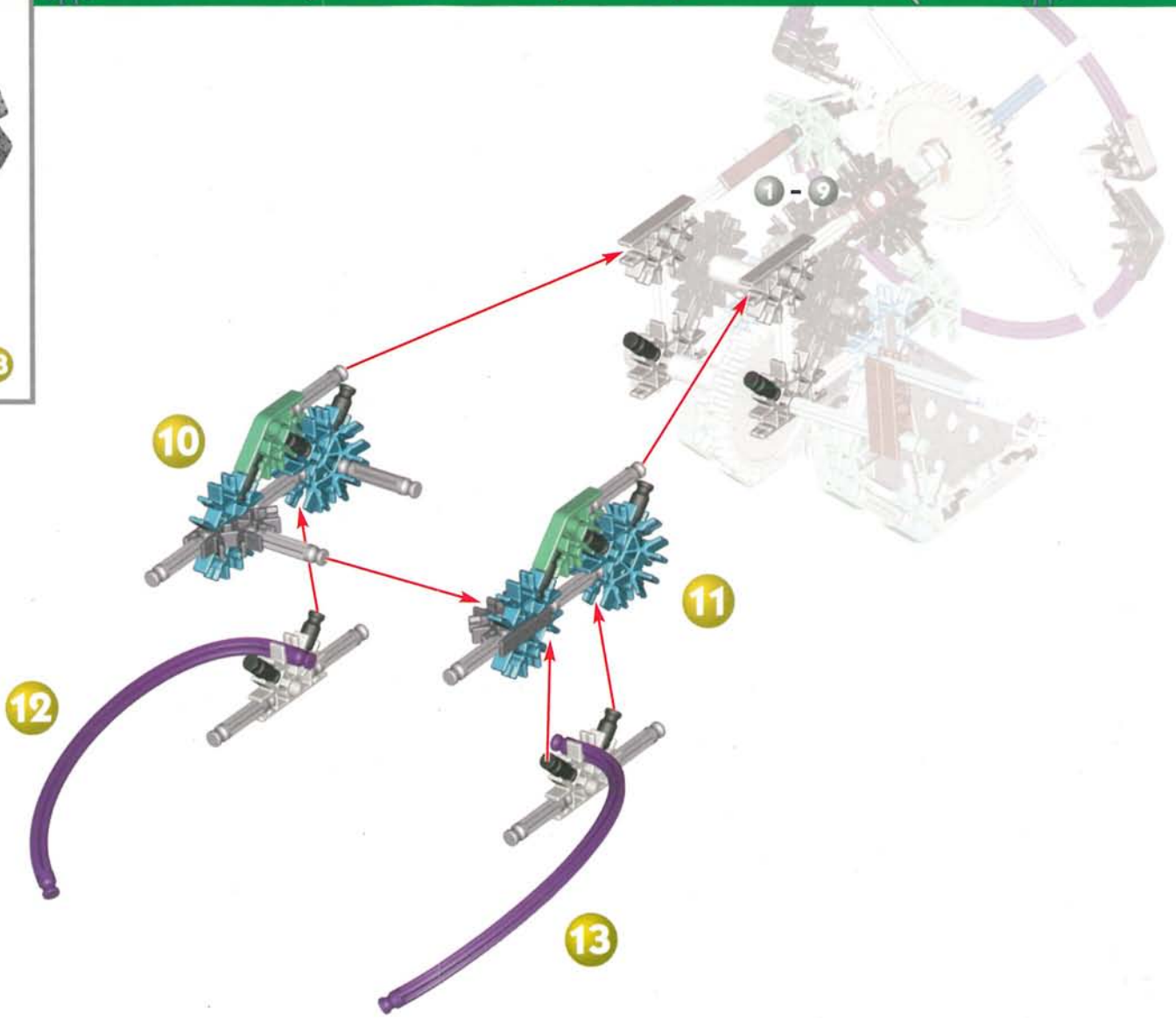

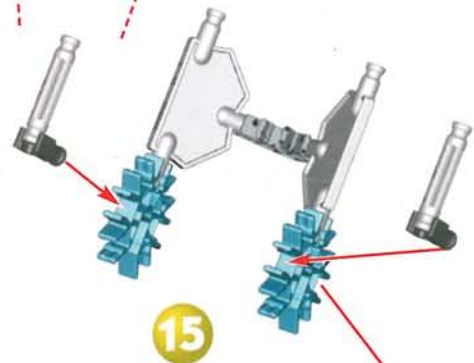

16

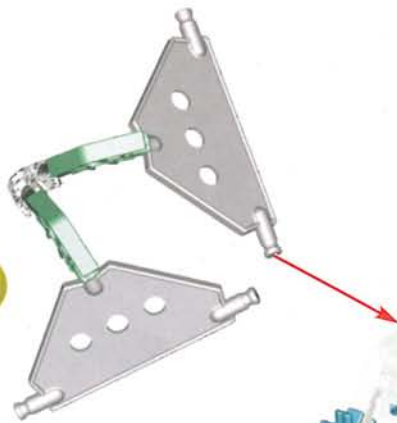

1 - 13



1 - 17

15

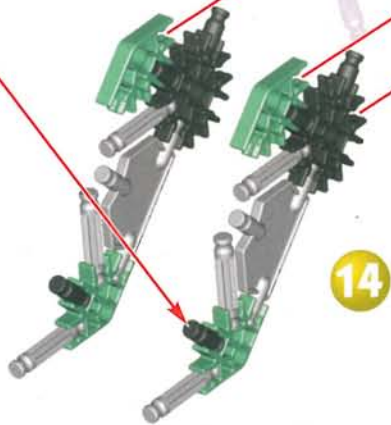

14

17



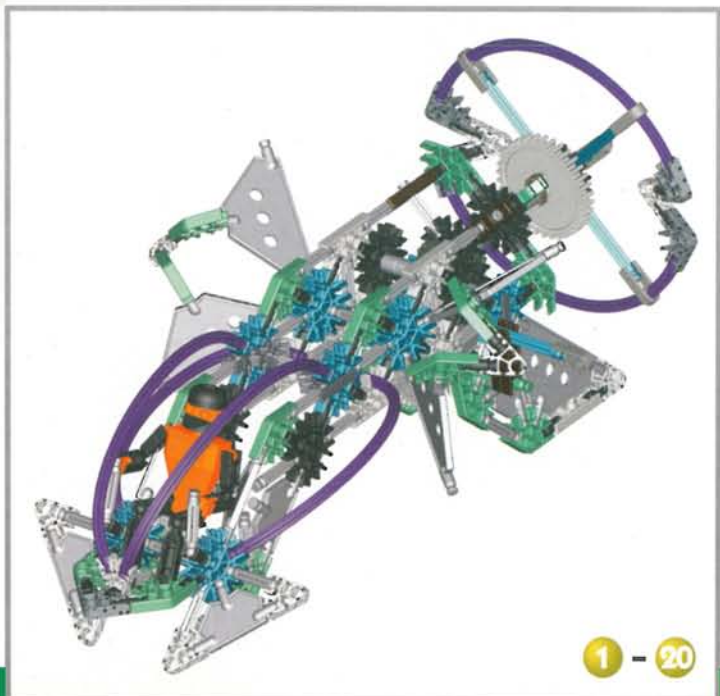
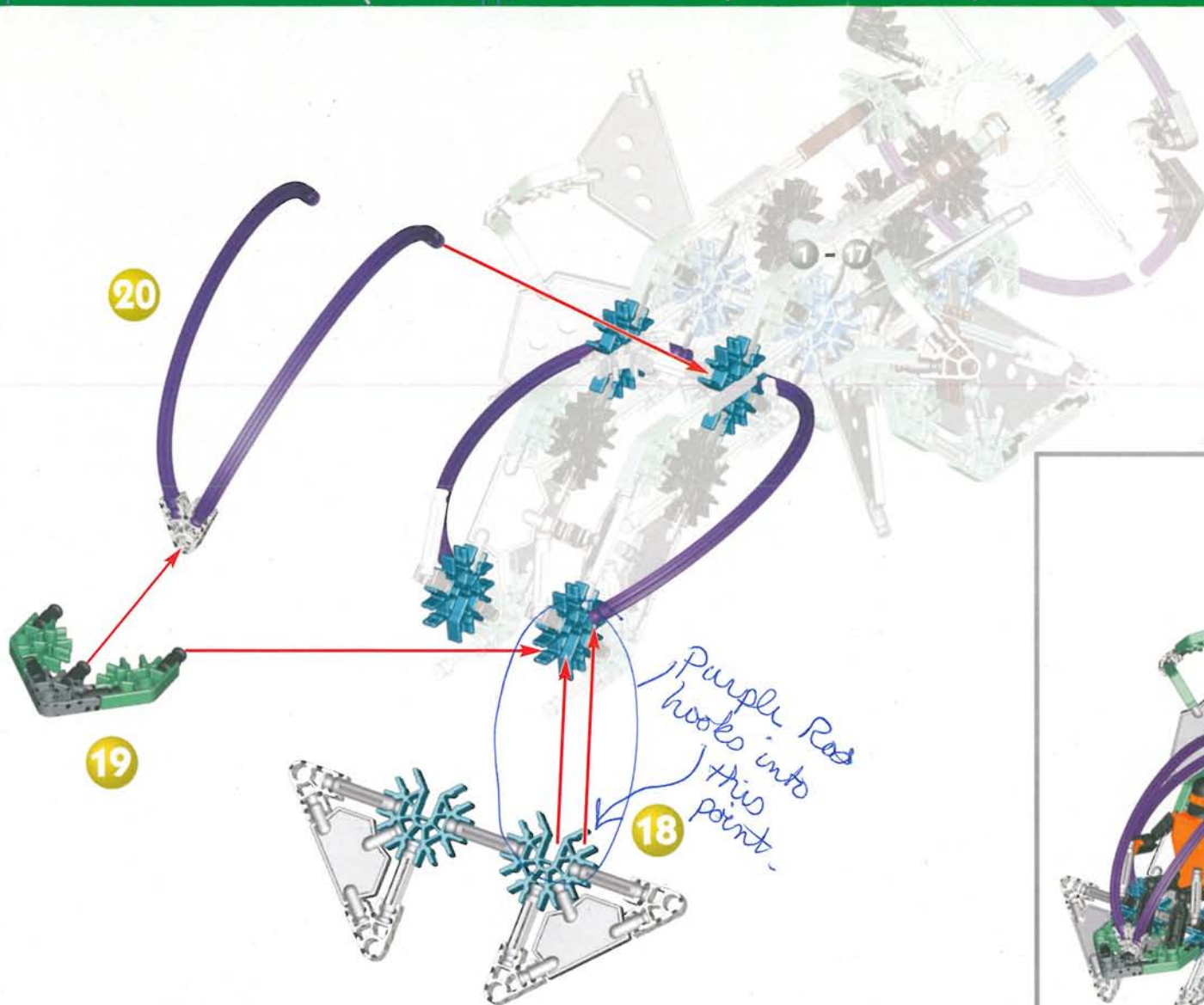

K'NEX[®]

COBRA STRIKER

BUILDS 3 MODELS

Questions? Call us
at 1-800-KID-KNEX
(USA/Canada only)
www.knex.com

©1999 K'NEX Industries, Inc.
P.O. Box 700
Hatfield, PA 19440-0700

K'NEX is a registered trademark of/K'NEX est une marque
déposée de K'NEX Industries, Inc.

Manufactured under U.S. Patents/Fabriqu  sous brevets
am ricains 5,061,219; 5,137,486; 5,199,919; 5,238,438;
5,346,420; 5,350,331; 5,368,514; 5,421,762; 5,423,707;
5,427,559; 5,518,435; D383,509; D388,475; D389,203;
D391,843; D391,921; D392,555. Other U.S. and foreign
patents pending./Autres brevets am ricains et  trangers
en instance.

Conforms to the Requirements of ASTM Standard Consumer
Safety Specification on Toy Safety, F963-96a./Conforme
aux sp cifications de s curit  du consommateur sur la
s curit  des jouets de la norme ASTM F963-96a.



Colors and product may vary.

Le produit et les couleurs peuvent varier.

El producto y los colores pueden variar.

CAUTION: Do not launch in the direction of people, animals, or walls; you could cause injury or damage. Never attempt to launch any projectiles other than K'NEX foam missiles.

ATTENTION: Ne pas lancer en direction de personnes, d'animaux ou de murs au risque de causer des blessures et des dommages. N'essayez de lancer des projectiles autres que des missiles en mousse K'NEX.

PRECAUCI N: No lanzar el veh culo en direcci n a personas, animales o paredes, pues ello podr a provocar lesiones o da os. Nunca intente lanzar otros proyectiles que no sean los misiles de gomaespuma de K'NEX.



94244-V1-3/99