

K'NEX®

33147



CHALLENGE BUILDING SET

35 MODELS



WARNING:
CHOKING HAZARD – Small Parts.
Not for children under 3 years

AVERTISSEMENT:
DANGER D'ÉTOUFFEMENT – Pièces de petite taille.
Ne pas donner aux enfants de moins de 3 ans.

ATENCIÓN: Peligro de asfixia: Por contener piezas pequeñas,
no recomendable para niños menores de tres años.

COLOR CODED BUILDING SYSTEM

Speedy Bird	4
CD Holder	5
Small Picture Frame	6
Large Picture Frame	7
Trolley Car	8
Dragster	10
Trike	12
Chuck Wagon	14
Space Transporter	16
Spider	18
Backhoe	21
Road Grader	24
Ferris Wheel	27
Golf Cart	30
Praying Mantis	32
Helicopter	34
Windmill	38
Spaceship Ride	40
Robot	43
Formula Car	46
Sport Bike	49
Camera	52
Boom Ride	55
Octopus Ride	58
Boat Ride	60
Hippo	64
Elephant	66
Prop Plane	69
Combine Harvester	73
Swing Ride	76
Exploration Vehicle	79
Radar Center	84
Cherry Picker Truck	90
Dragon	94
Space Shuttle	98

K'NEXman

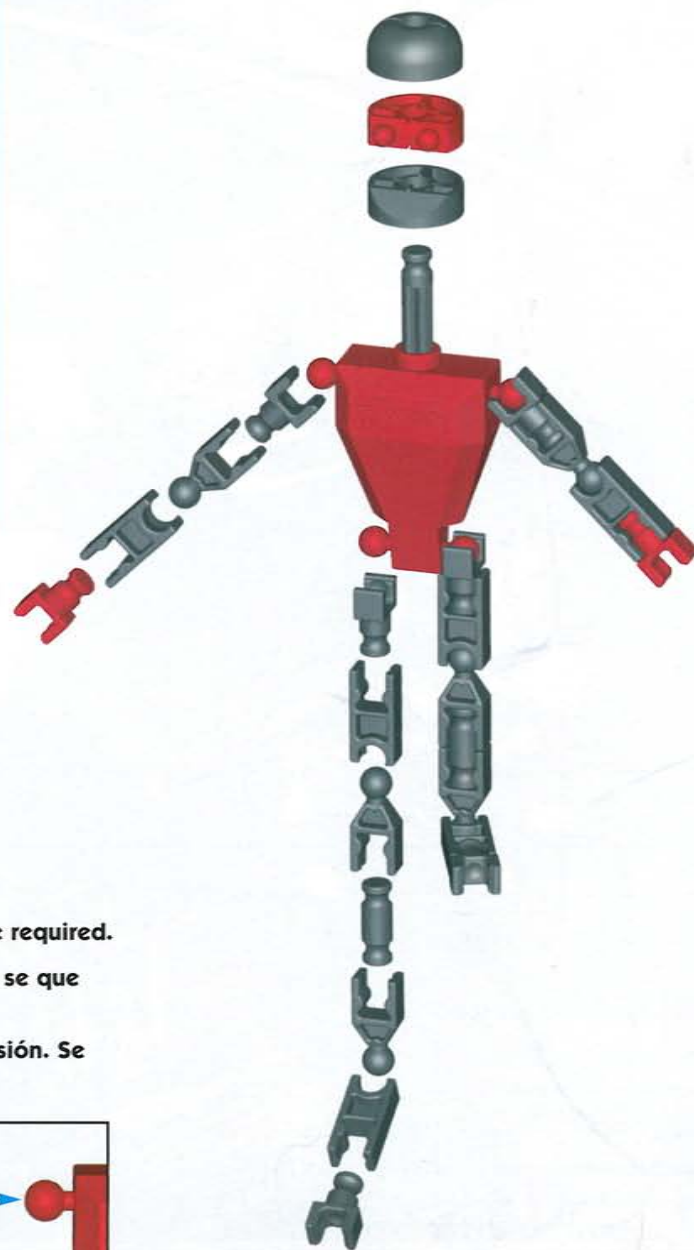
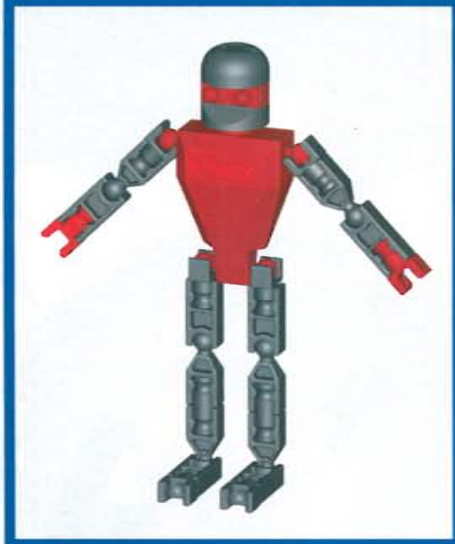

Push to snap together. Adult help may be required.

Enfoncez les pièces pour les imbriquer. Il se que l'aide d'un adulte soit nécessaire.

Empuja las piezas para que encajen a presión. Se podrá requerir la ayuda de un adulto.

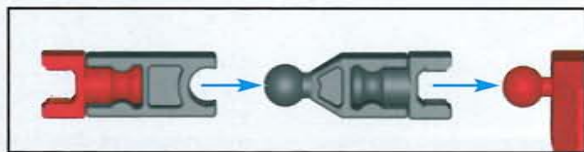

Congratulations!

You have discovered K'NEX, the award winning construction system that lets you build and bring to life anything you can imagine.

Stretch your imagination. Make the most of your creativity. And have a ton of fun building, too.

Your set has everything you need to turn K'NEX parts into totally cool models. The instructions get you going, but the fun doesn't stop there. Design your own models! Make your own K'NEX world.

And check out the other great K'NEX Sets, with exciting themes and models for kids of all ages!

Visit the K'NEX website at www.knex.com. Questions? Call us at 1-800-KID-KNEX.

Félicitations ! Vous venez de découvrir K'NEX, un système de construction unique qui vous permettra de créer tout un monde imaginaire.

Laissez-vous guider par votre imagination, écoutez votre esprit créateur et amusez-vous à construire des modèles pendant des heures.

Vous trouverez dans cette boîte toutes les pièces et accessoires nécessaires pour créer de super modèles. Ces instructions ne sont qu'un exemple. Ne vous y limitez pas. Inventez d'autres modèles et bâtissez votre univers K'NEX !

N'oubliez pas non plus d'essayer les autres kits K'NEX qui vous proposeront encore plus de thèmes et de modèles pour enfants de tous les âges !

Visitez le site K'NEX au www.knex.com ou appelez-nous au 1-800-KID-KNEX.

¡Enhorabuena! Has descubierto K'NEX, el sistema de construcción galardonado, que te permite construir y hacer que cobre vida todo aquello que puedas imaginar.

¡Da rienda suelta a tu imaginación! ¡Sácale partido a tu creatividad! Y, de paso, ¡diviértete de lo lindo!

Este juego tiene todo lo que necesitas para crear, con las piezas K'NEX, los modelos más divertidos. Las instrucciones te muestran el camino, pero el juego no tiene límites. ¡Diseña tus propios modelos! ¡Crea tu propio mundo K'NEX!

Y no olvides que hay muchos otros sets K'NEX para niños de todas las edades, con temas y modelos que te encantarán.

Visita el sitio de K'NEX en la Web, www.knex.com, o llámanos al 1-800-KID-KNEX.

Each K'NEX piece has its own color and shape; match it to pieces in the picture instructions. Put pieces together exactly as pictures show. Be sure to put Rods in the correct slots of Connectors, so you have proper angles in your finished model.

Chaque pièce K'NEX a une couleur et une forme bien à elle. Faites correspondre et montez les pièces les unes sur les autres en suivant exactement les instructions illustrées. Assurez-vous de bien assembler les tiges dans les fentes des connecteurs afin d'obtenir des angles corrects une fois le modèle fini.

Assurez-vous de bien assembler les tiges dans les fentes des connecteurs afin d'obtenir des angles corrects une fois le modèle fini. Asegurarse de colocar las varillas en las ranuras correctas de los conectores, de modo que al terminar el modelo, los ángulos sean los adecuados.

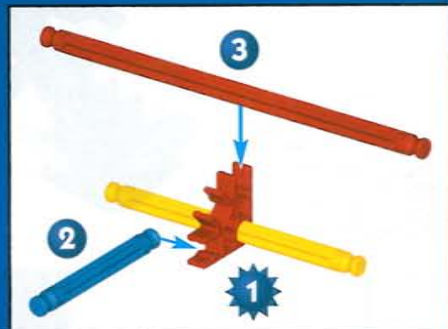

Pay close attention to the number of blue Spacers needed.

Comptez bien le nombre de rondelles bleues nécessaires.

Prestar atención al número de espaciadores azules que se necesitan.

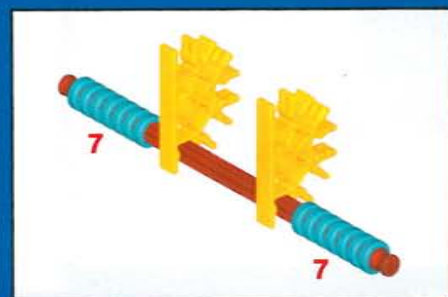

Faded colors indicate sections previously built; connecting points will be in full color.

Les couleurs plus claires indiquent les sections déjà construites. Les points de jonction sont indiqués en couleurs vives.

Los colores apagados indican secciones que ya han sido montadas anteriormente. Los puntos de conexión se indican con colores vivos.

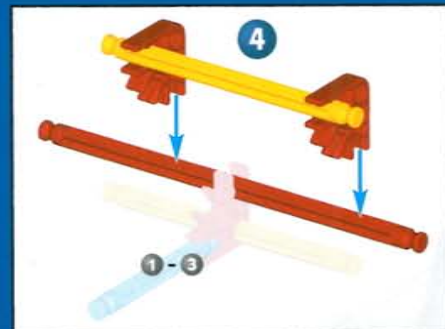

CAUTION: Rubber Bands can cause injury from snap-back, breaking, or loss of control. While assembling models shown in instructions, hold Rubber Band tightly, and do not overstretch. Use Rubber Bands only as shown in these instructions. **DO NOT USE FRAYED OR TORN RUBBER BANDS.** Caution: Keep Rubber Bands away from face and eyes. Keep hair, clothing and fingers away from moving parts.

ATTENTION: les élastiques peuvent causer des blessures en claquant, en se cassant ou quand on les manipule imprudemment. Tenez fermement l'élastique lors de l'assemblage du modèle en veillant à ne pas trop le tendre. N'utilisez les élastiques que selon les instructions. **N'UTILISEZ PAS D'ÉLASTIQUES ÉRAILLÉS OU DÉCHIRÉS.** Attention: Tenez les élastiques en caoutchouc à l'écart du visage et des yeux. Gardez les pièces mobiles à l'écart des doigts, des vêtements et des cheveux.

PRECAUCIÓN: Las gomas pueden causar daños si se sueltan con fuerza, se rompen o se pierde su control. Al construir los modelos que se muestran en las instrucciones, sujetar bien la goma y no estirla demasiado. Las gomas deben usarse únicamente como se indica en las instrucciones. **NO USAR GOMAS QUE ESTÉN DESGASTADAS NI RASGADAS.** Precaución: Mantenga las gomas elásticas alejadas de la cara y los ojos. Mantén el pelo, la ropa y los dedos alejados de las piezas móviles.

It's very important to position blue and purple Connectors in a specific direction. Pay close attention to the instructions, and position these Connectors horizontally or vertically exactly as they are shown. Push together tightly until you hear a "click".

Il est important de bien placer les connecteurs bleus et violets dans le bon sens. Lisez attentivement les instructions et placez ces connecteurs horizontalement ou verticalement selon l'indication. Appuyez dessus en forçant légèrement jusqu'à ce que vous entendiez un dé clic.

Es muy importante colocar los conectores de color azul y morado en una dirección específica. Prestar mucha atención a las instrucciones y colocar estos conectores según se indica, ya sea horizontal o verticalmente. Para conectarlos, presionar hasta oír un "clic".

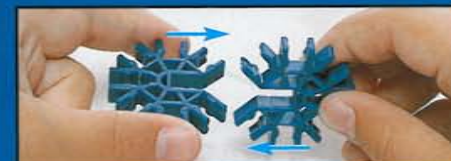

MicroPower motor: Wind until you hear clicking. Then release.

Moteur à MicroPower: Remontez jusqu'à ce que vous entendiez un clic. Puis, relâchez.

Motor de Micropower: Da cuerda hasta escuchar un clic. Luego, suéltalo.



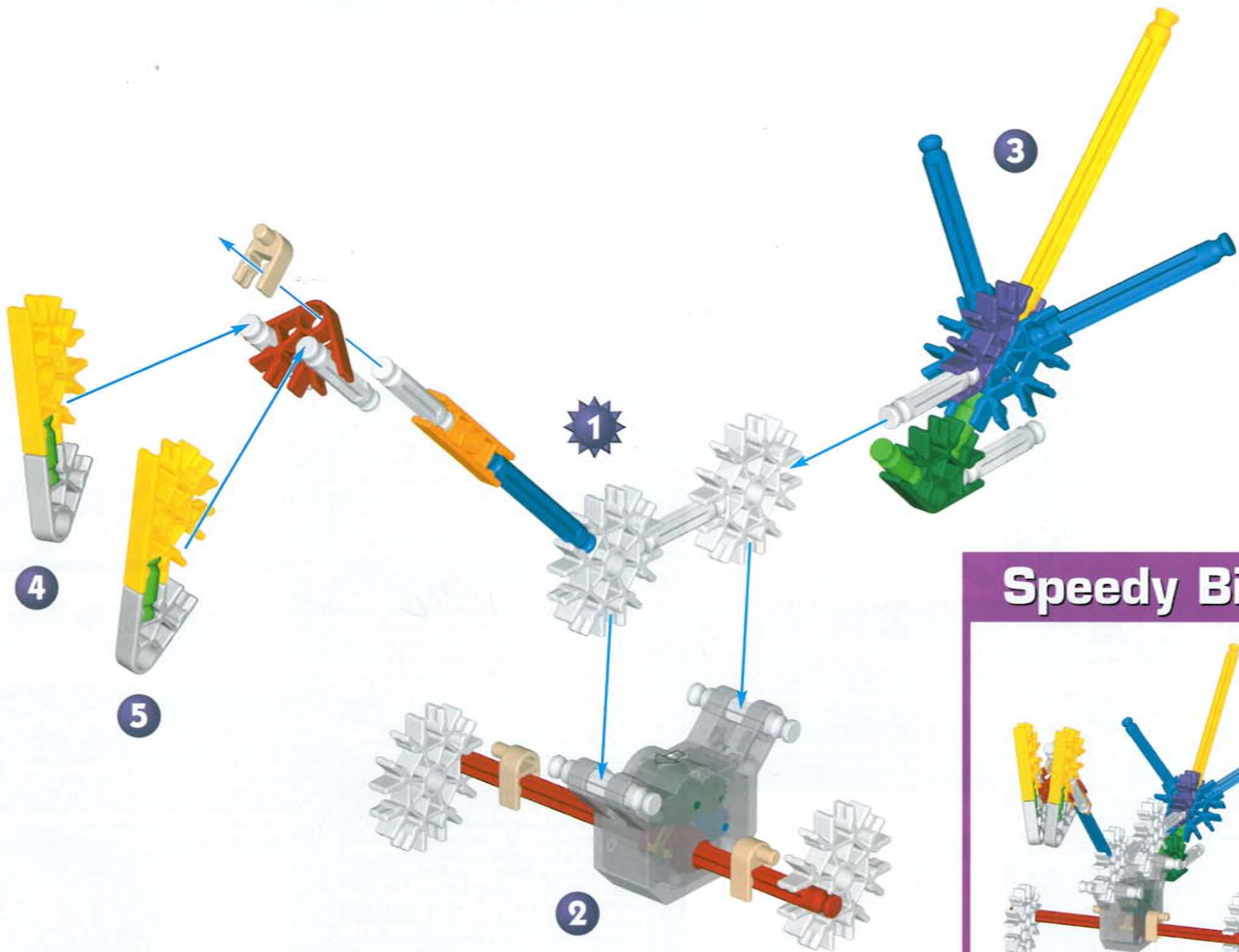

CD Holder

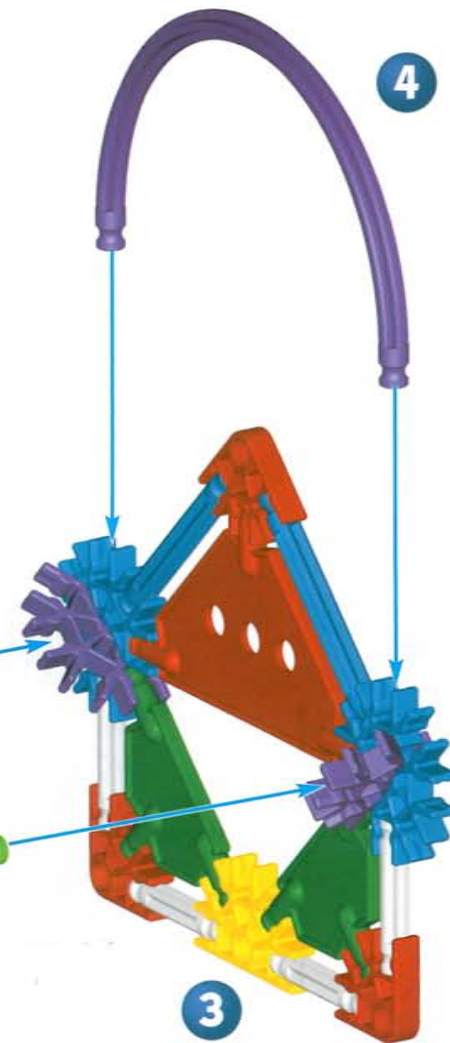
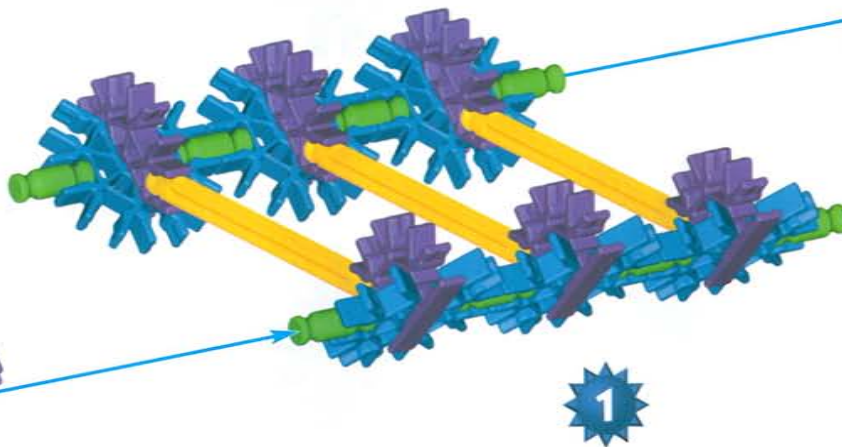
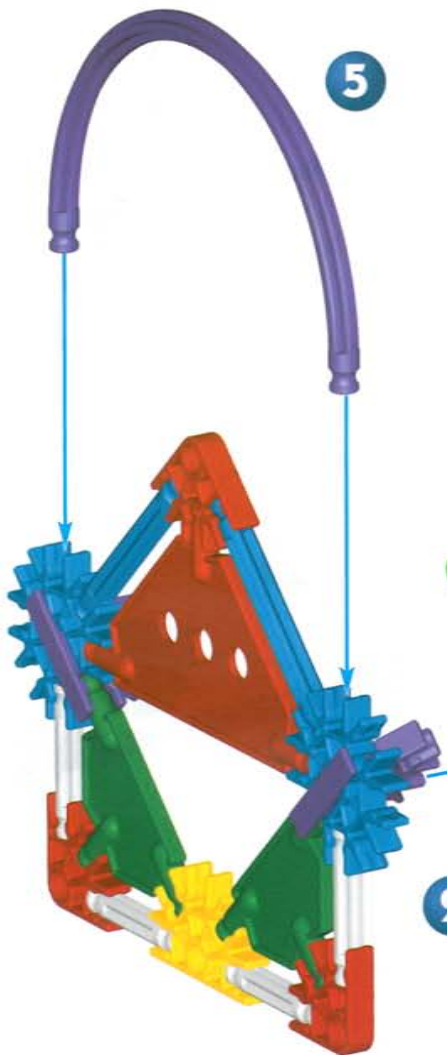
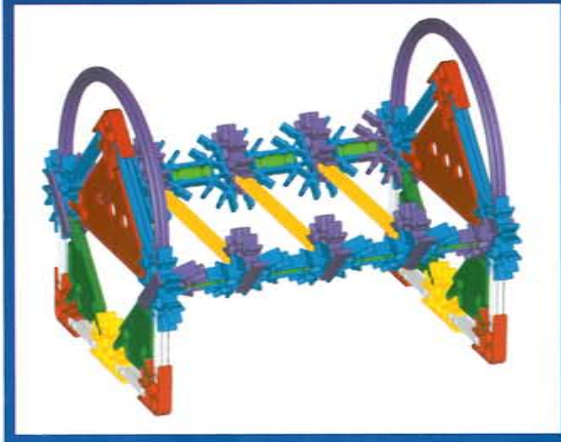

2

1

3

5

4

Small Picture Frame

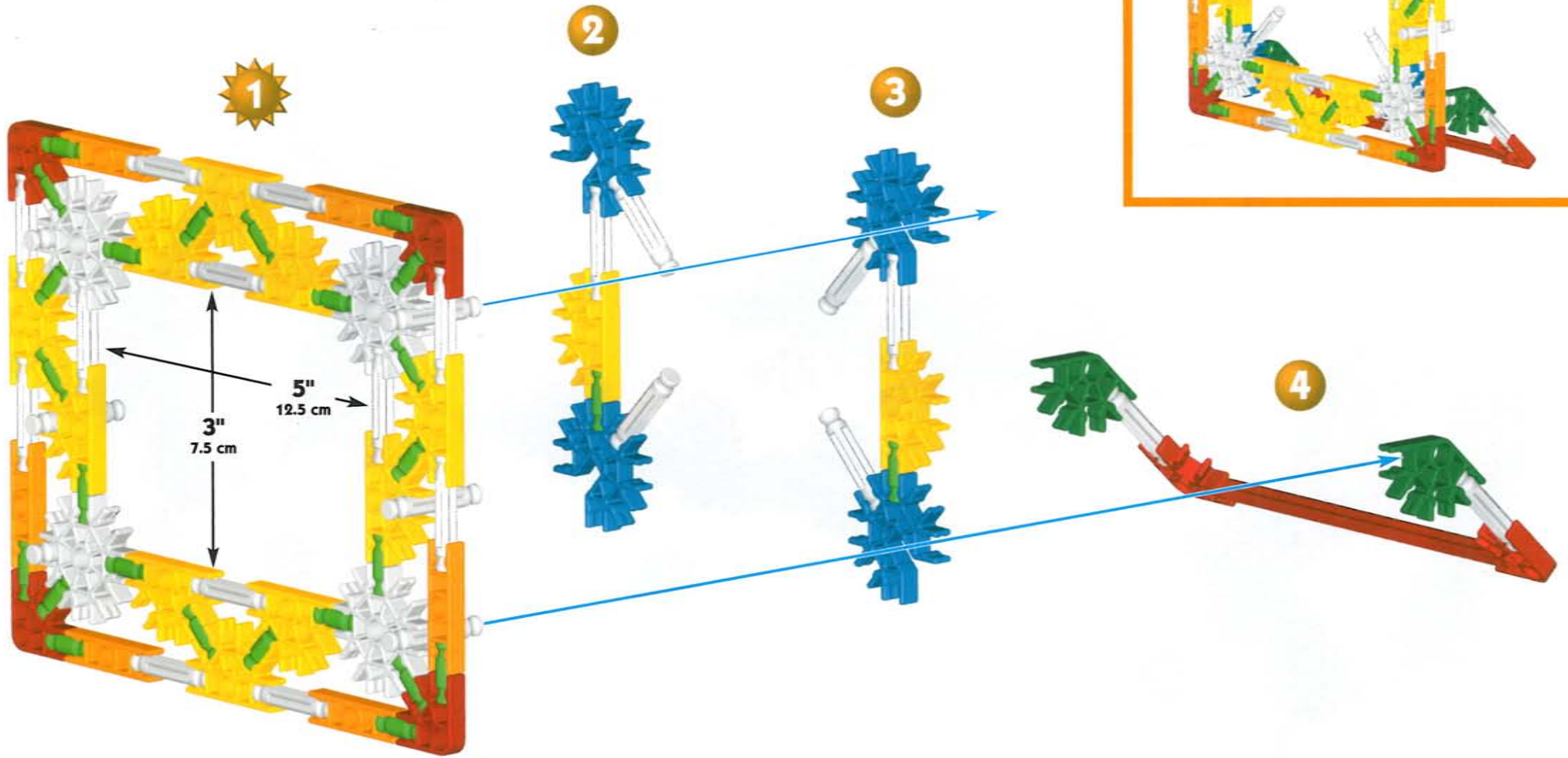

Large Picture Frame

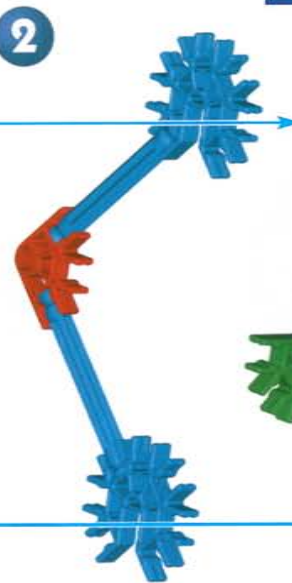
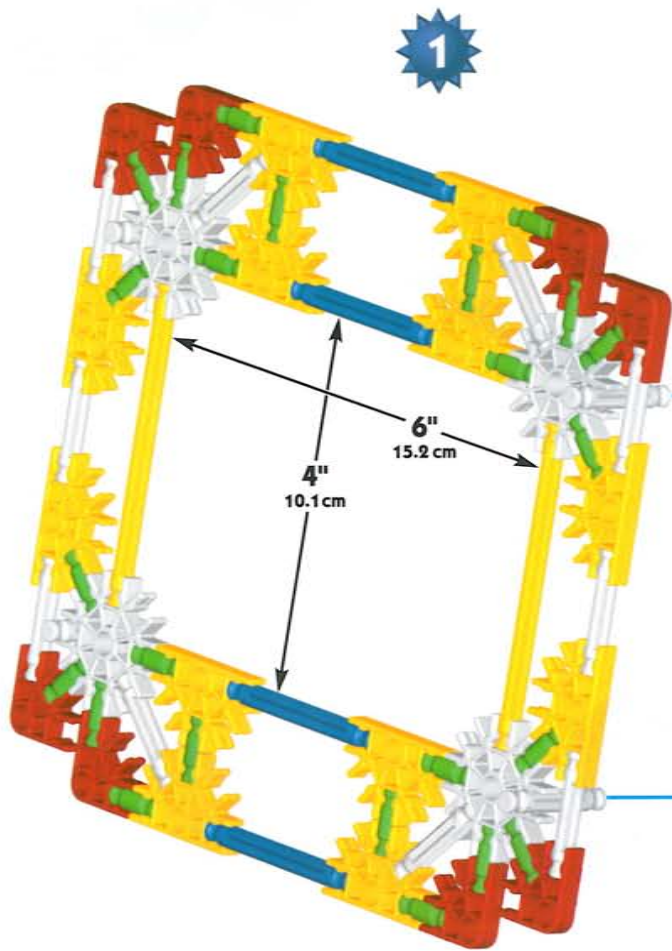
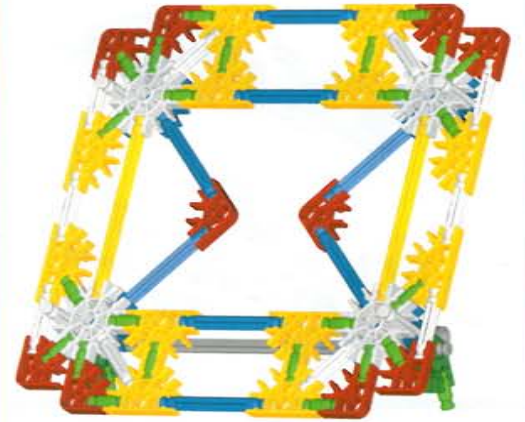

Trolley Car

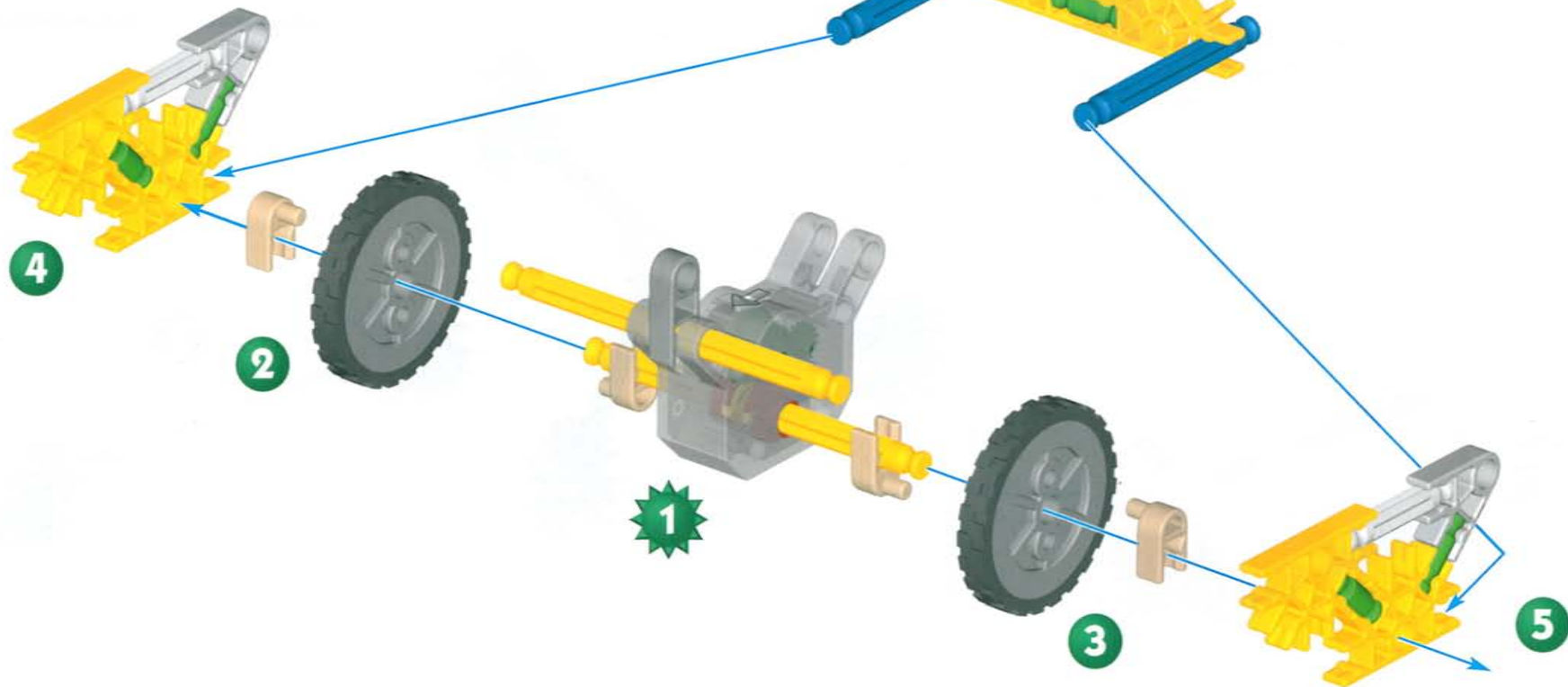

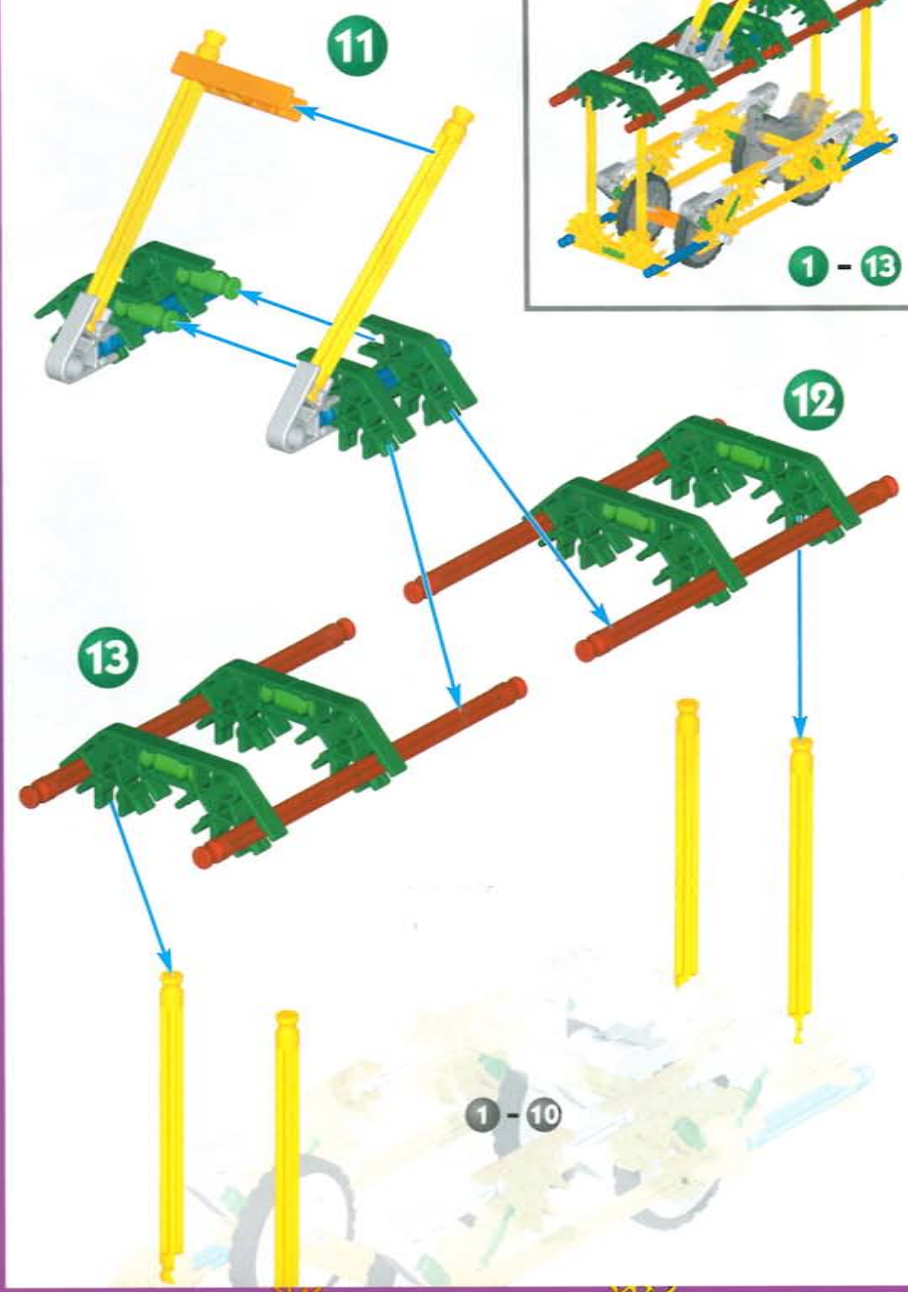
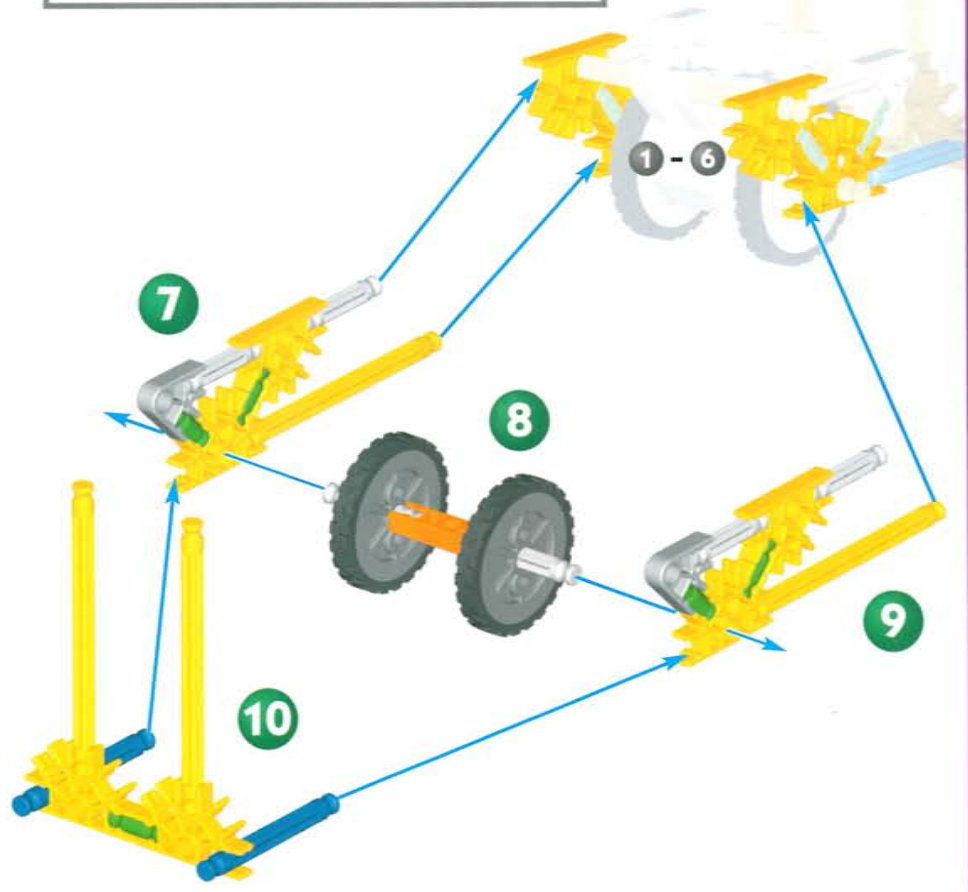
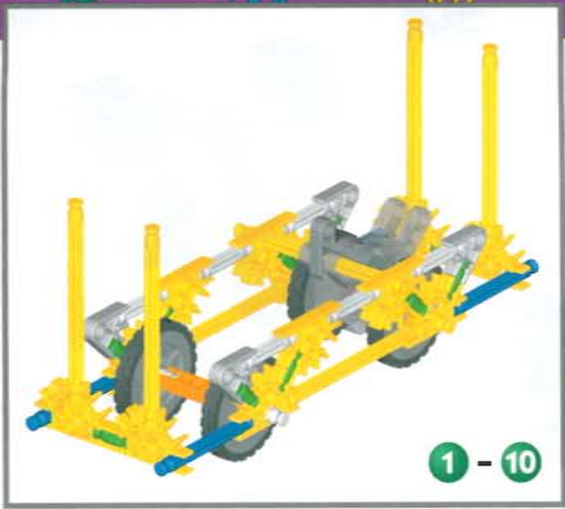

Dragster

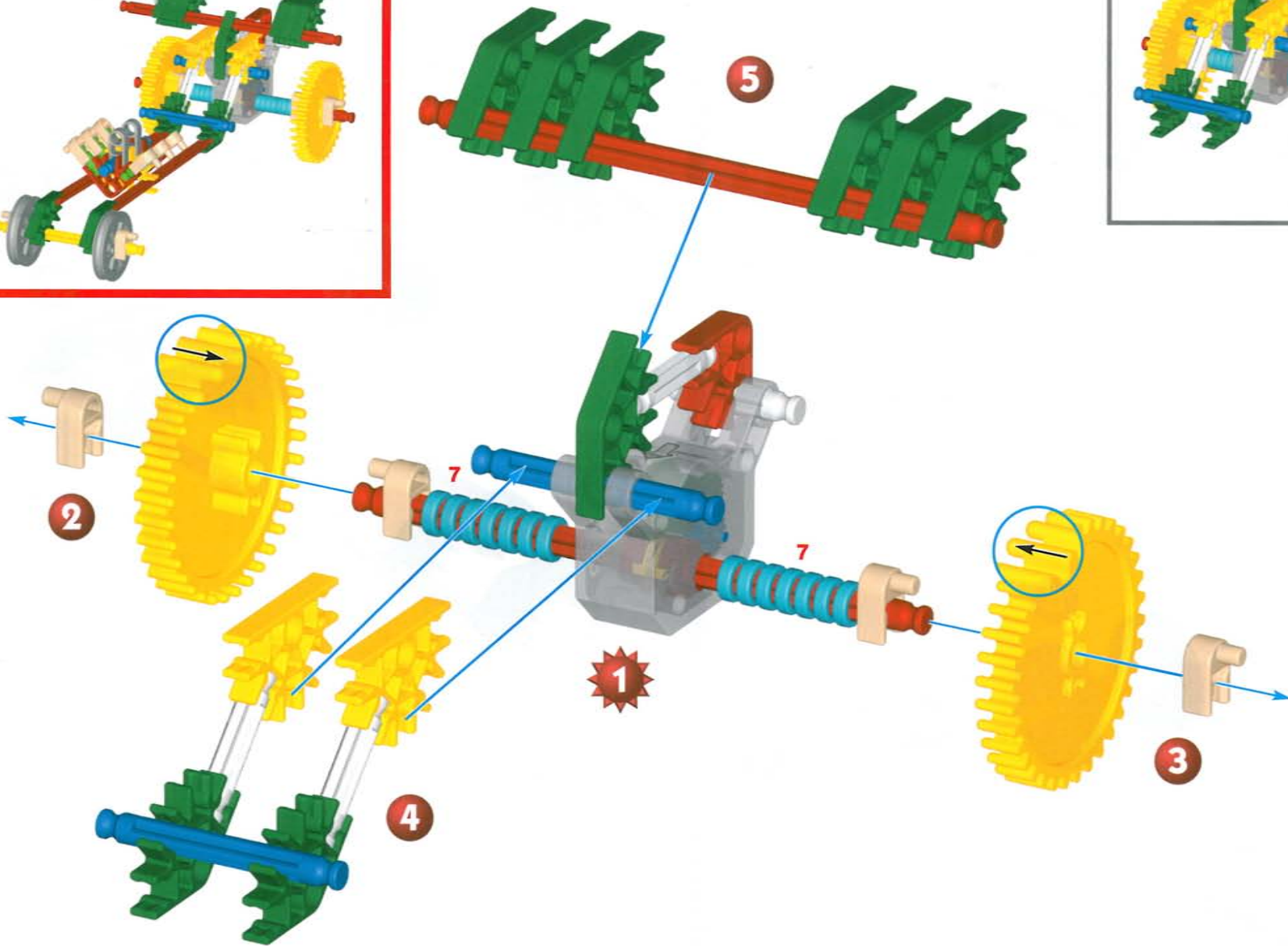
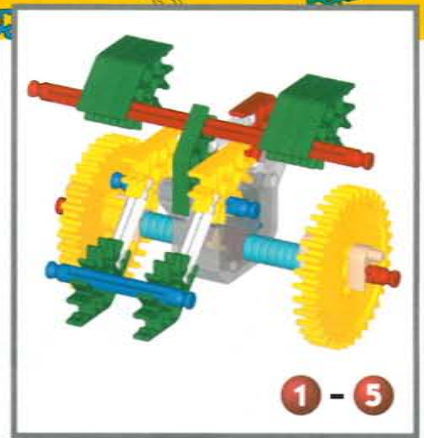
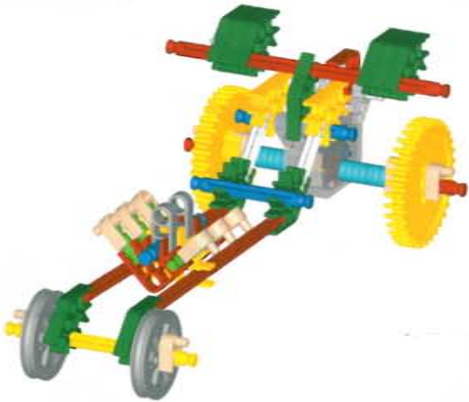

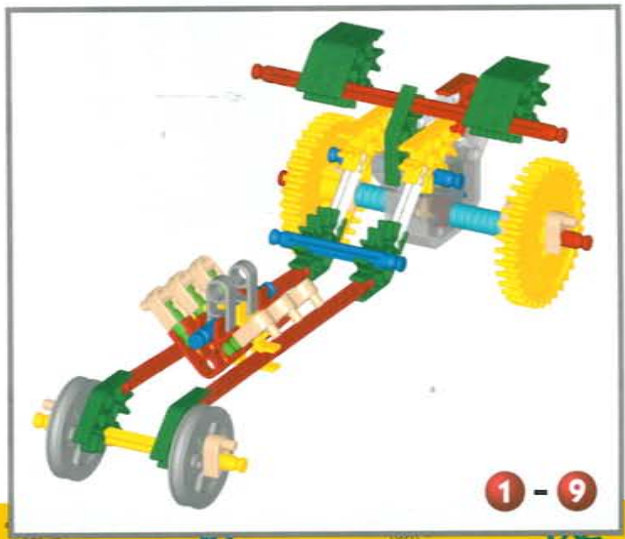
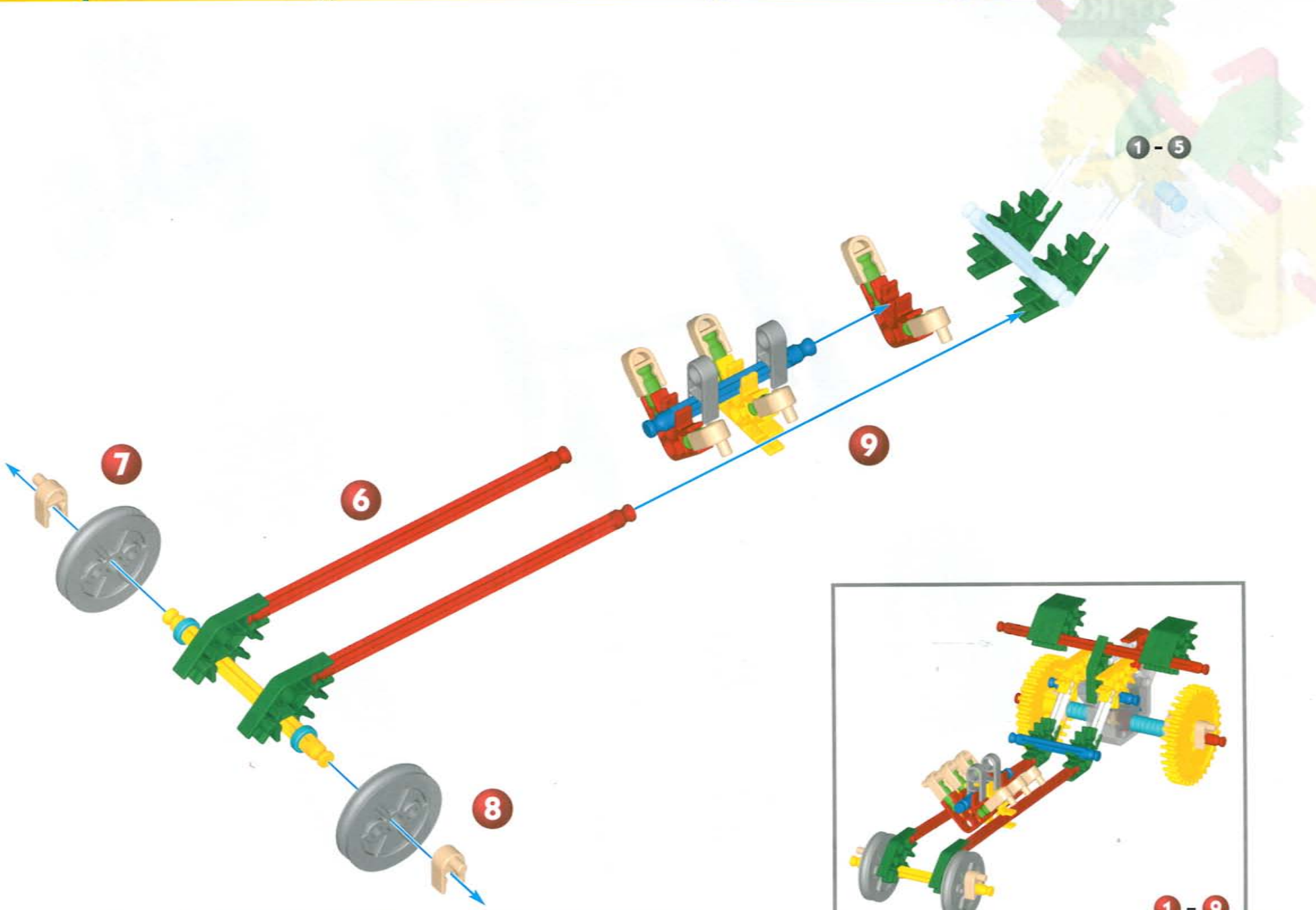

Trike

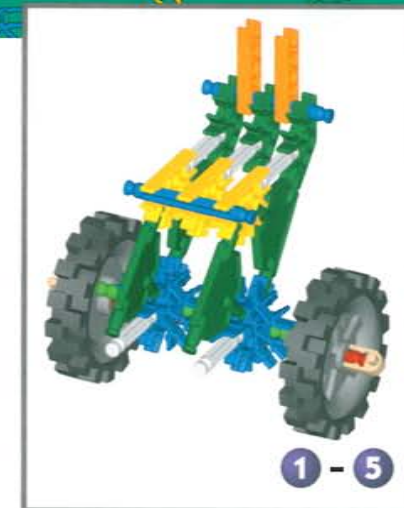
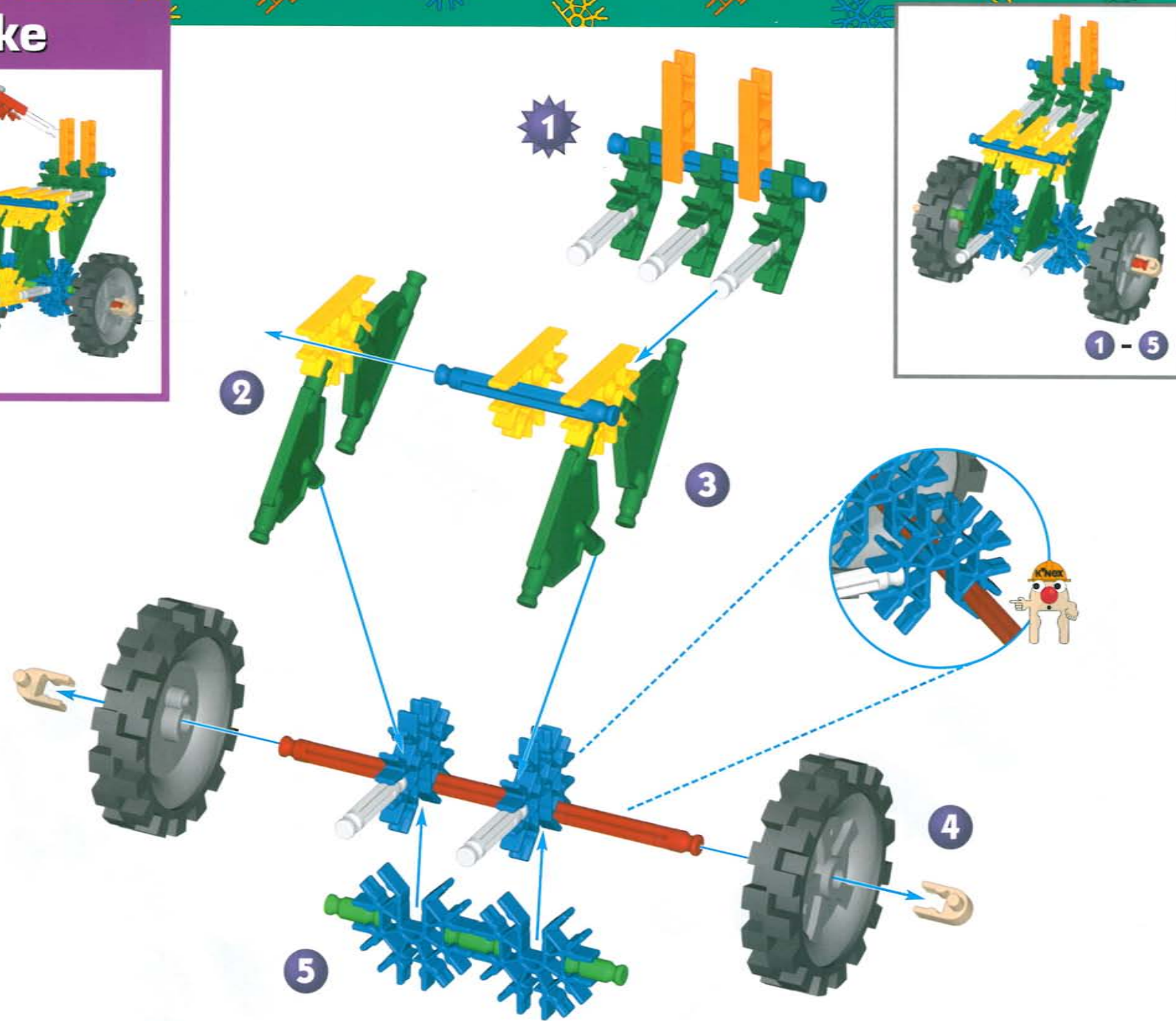

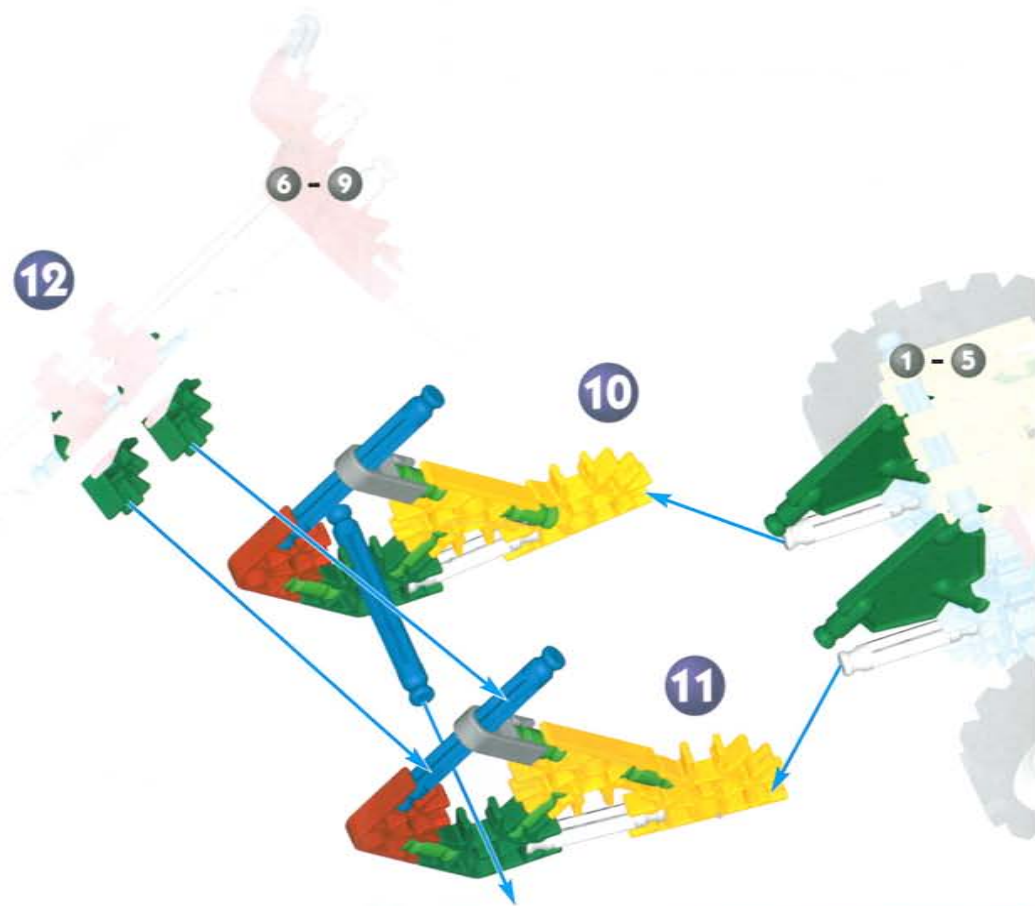
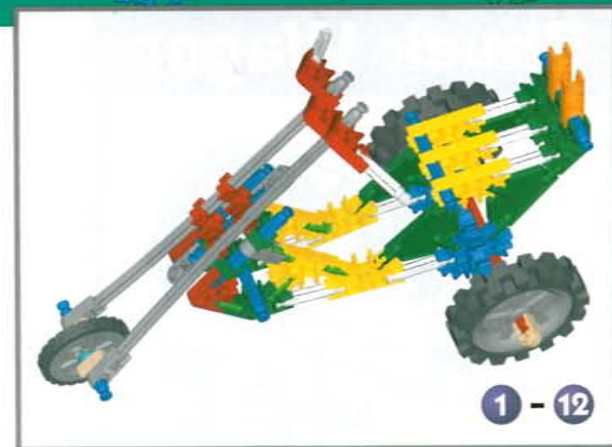
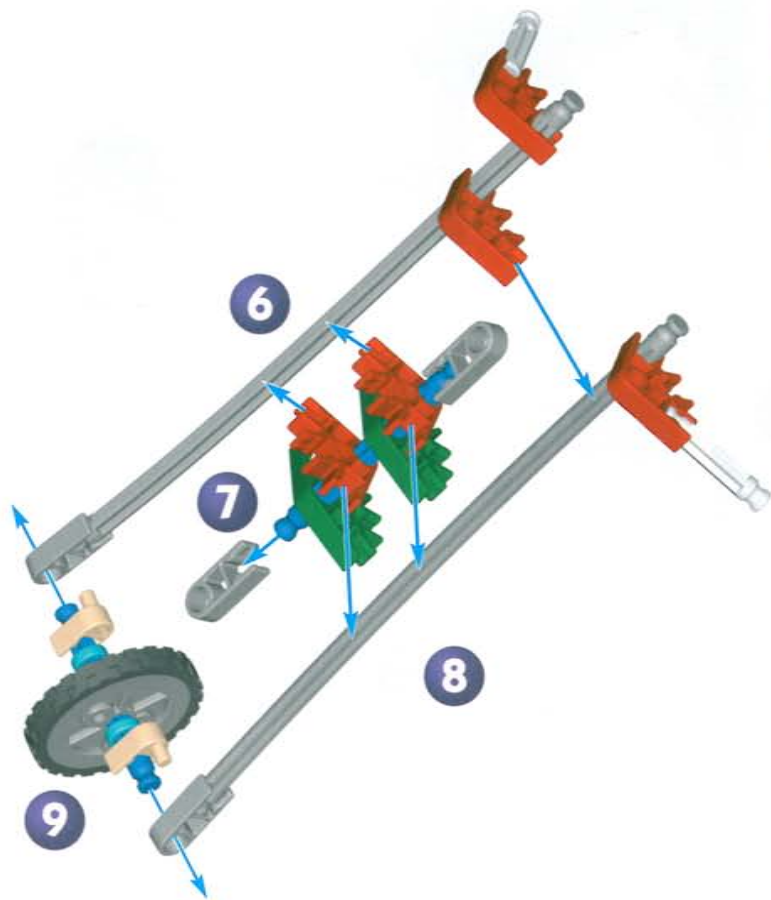

Chuck Wagon

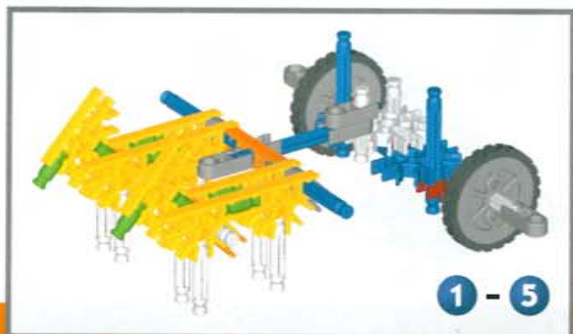
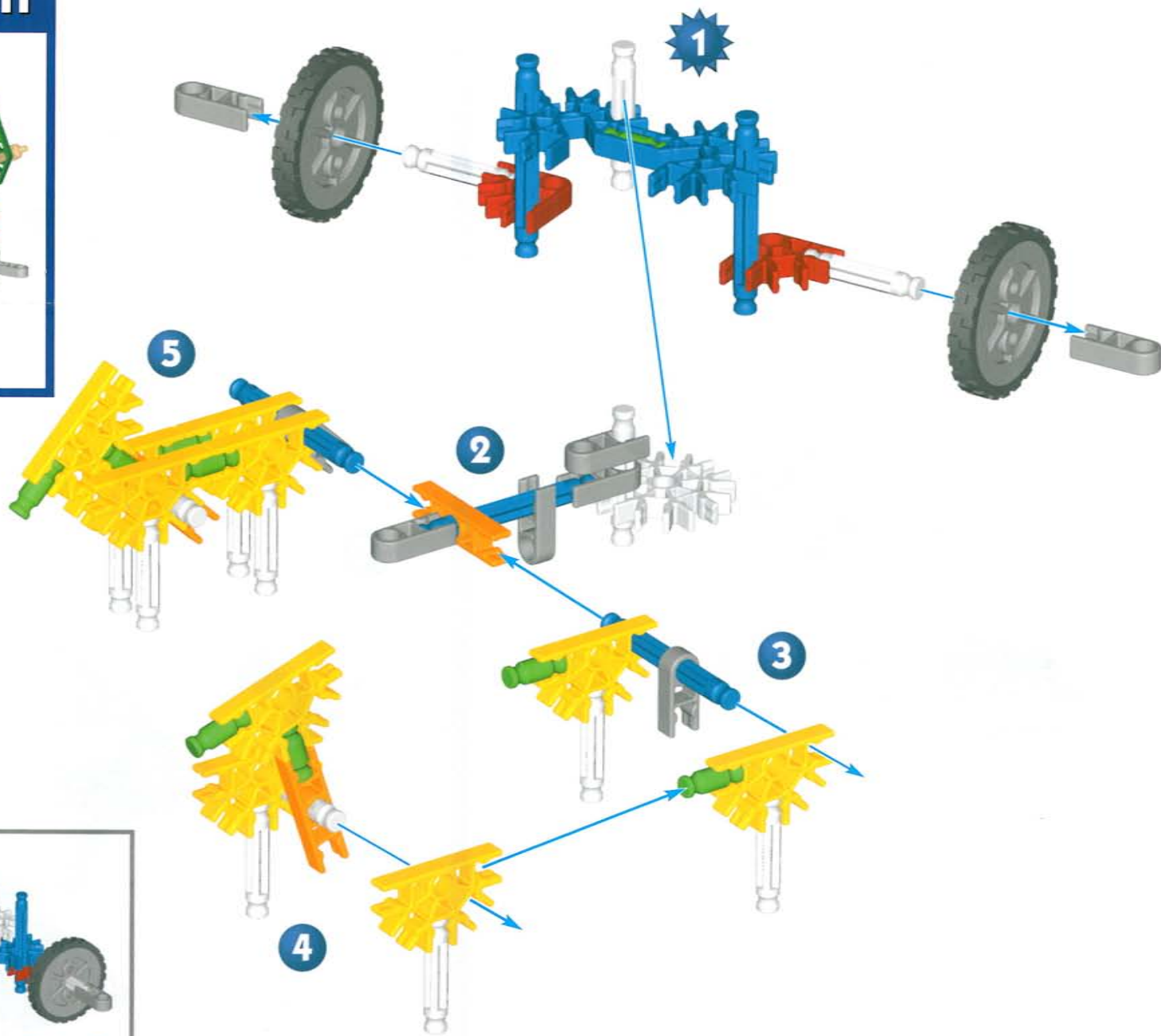

7

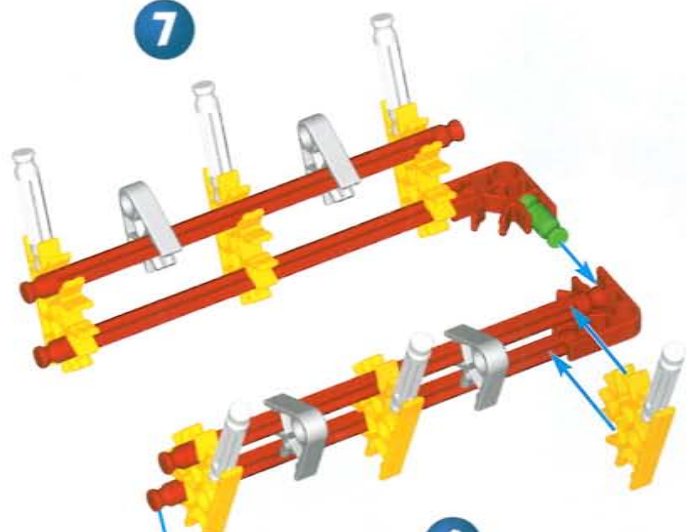

6

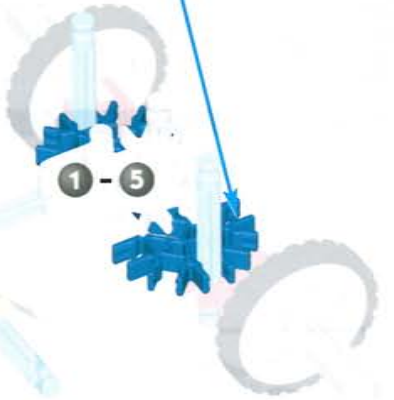

1-5

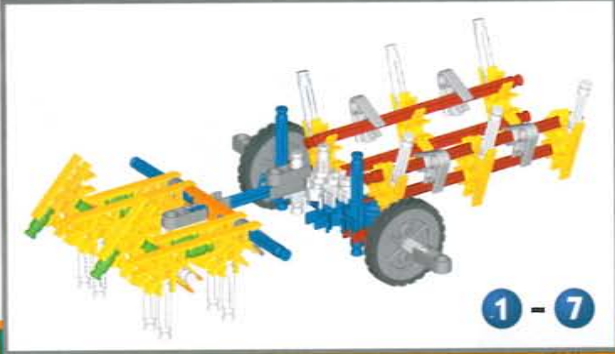

1-7

8

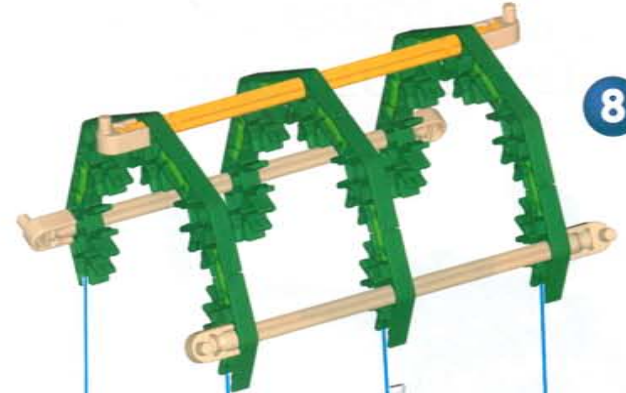

1-7

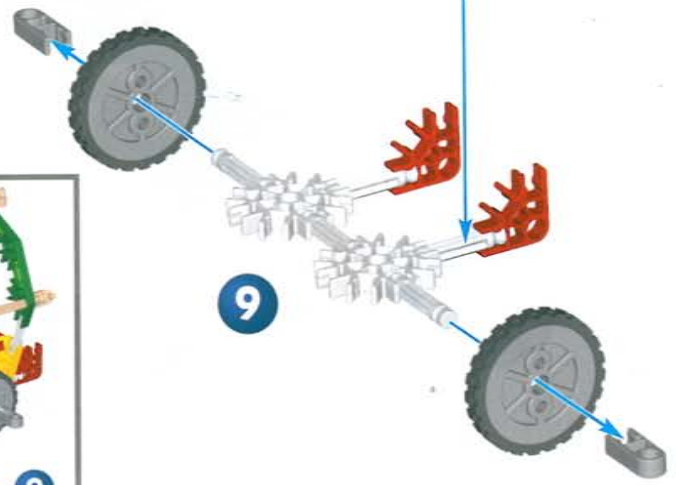

9



1-9

Space Transporter

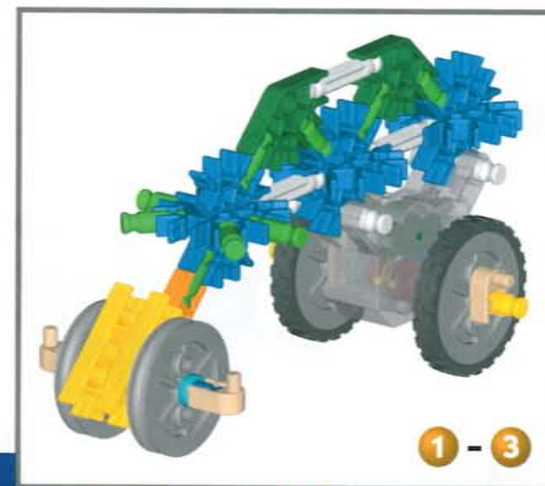
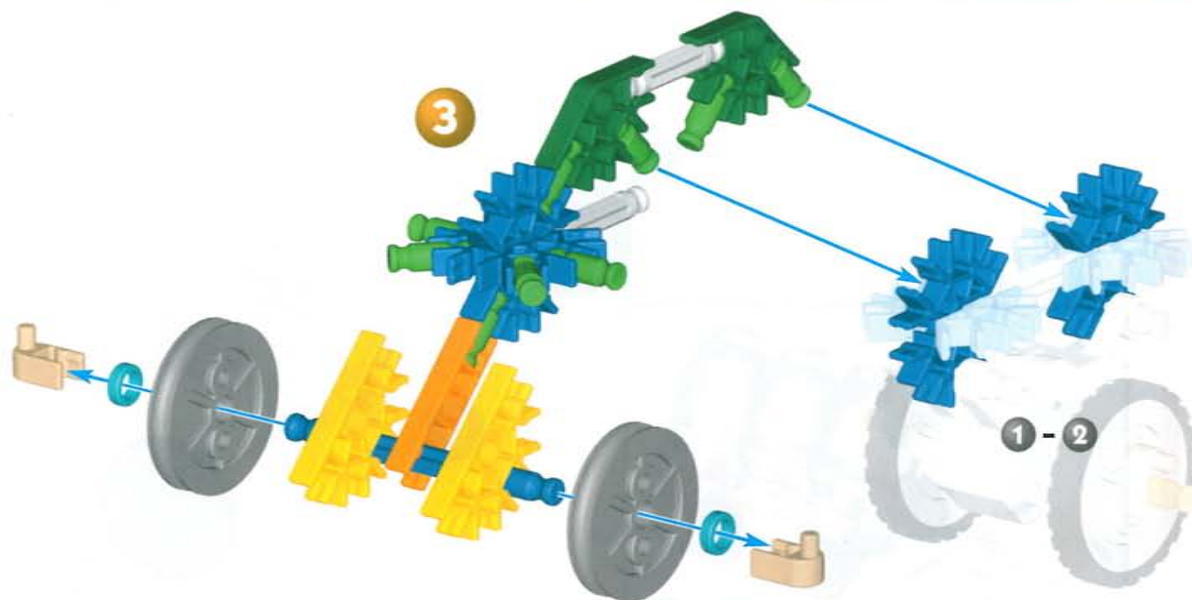
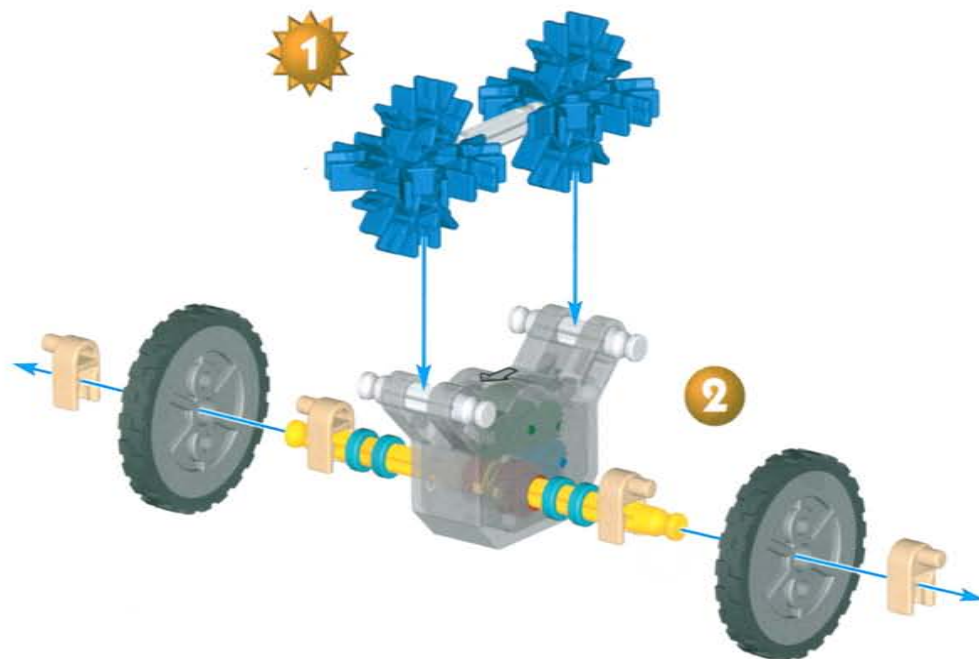

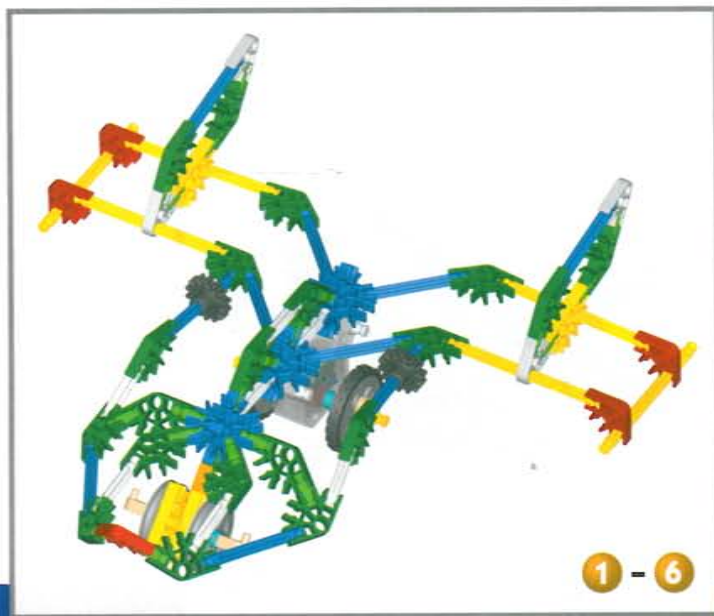

Spider

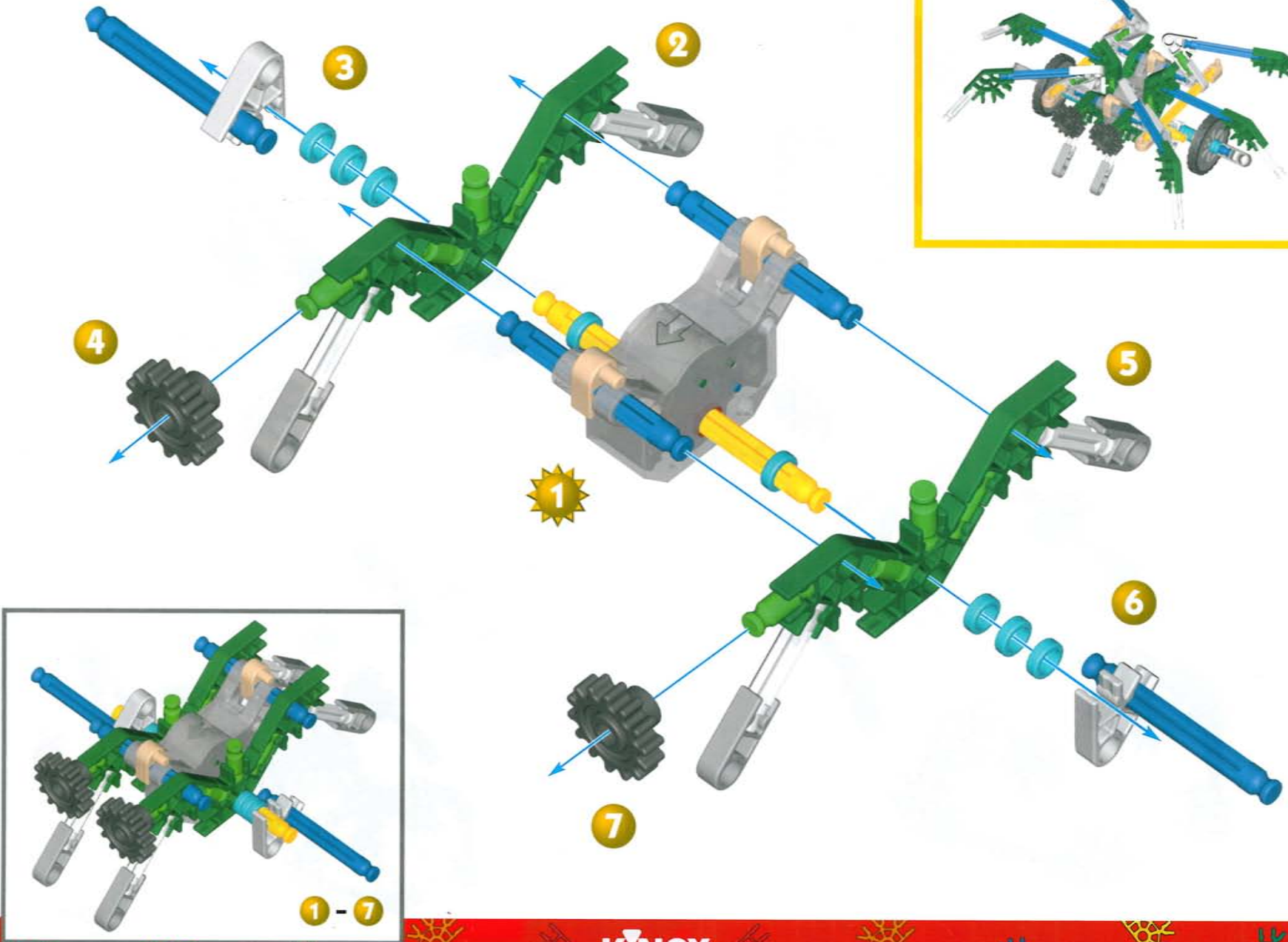

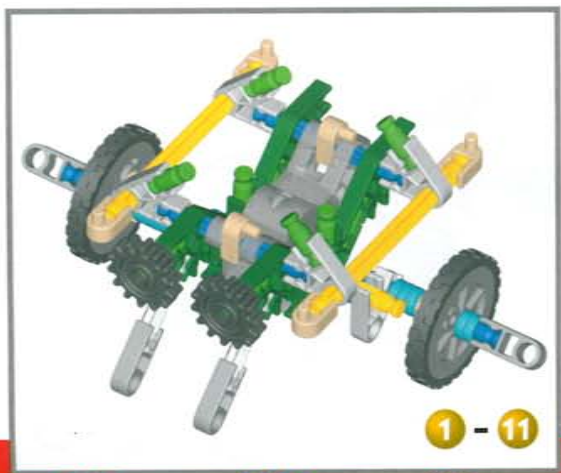
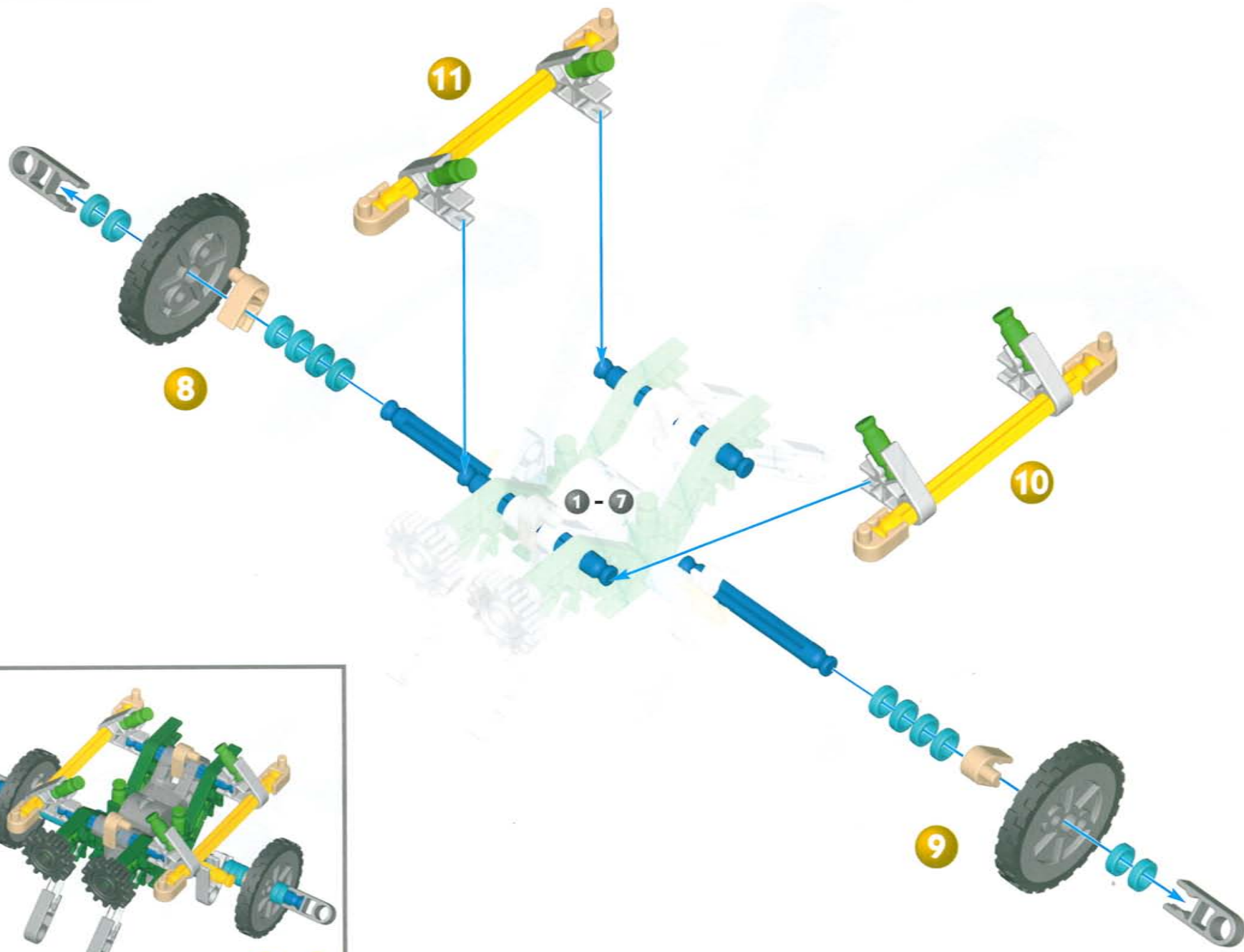

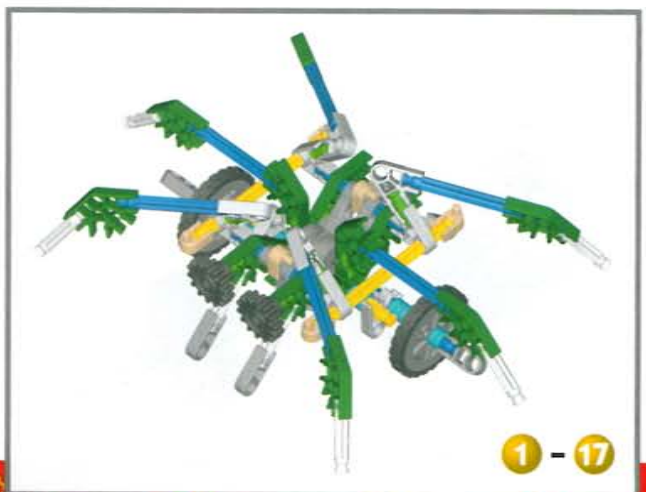
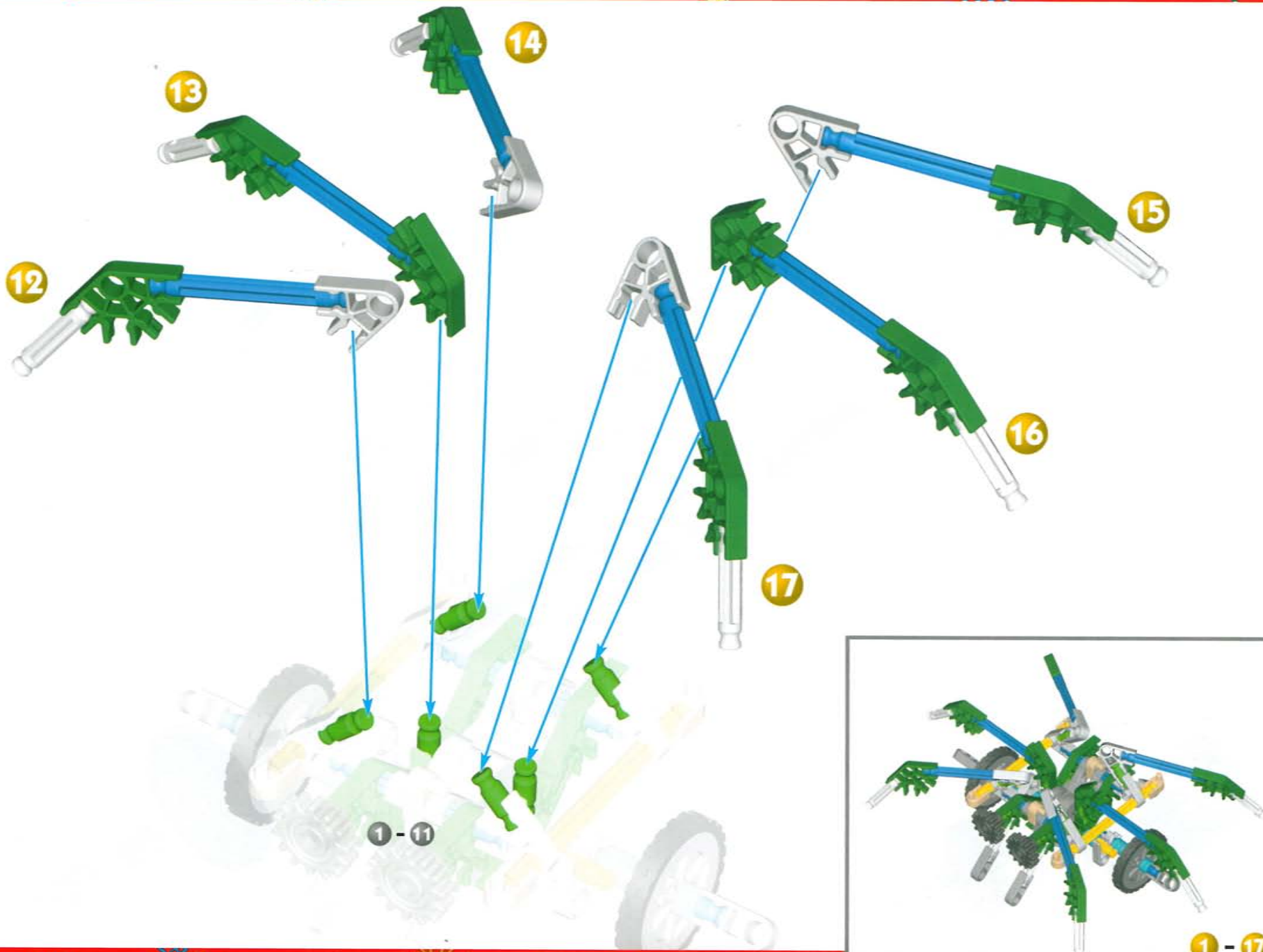

Backhoe

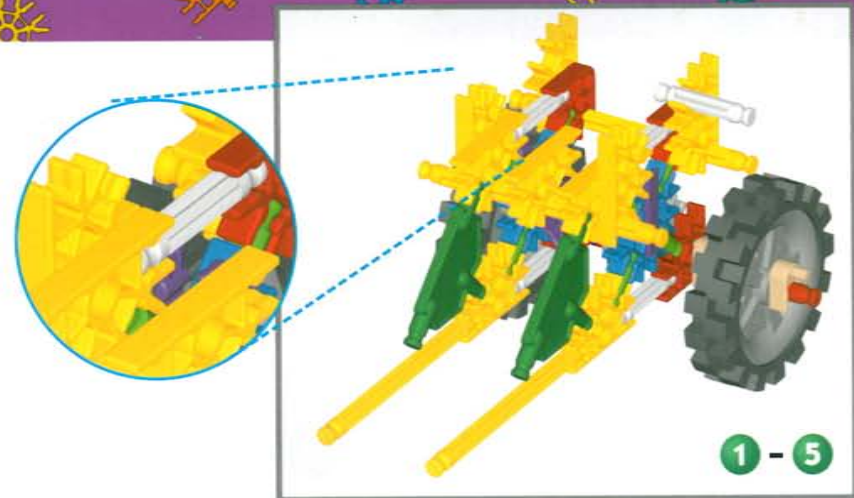
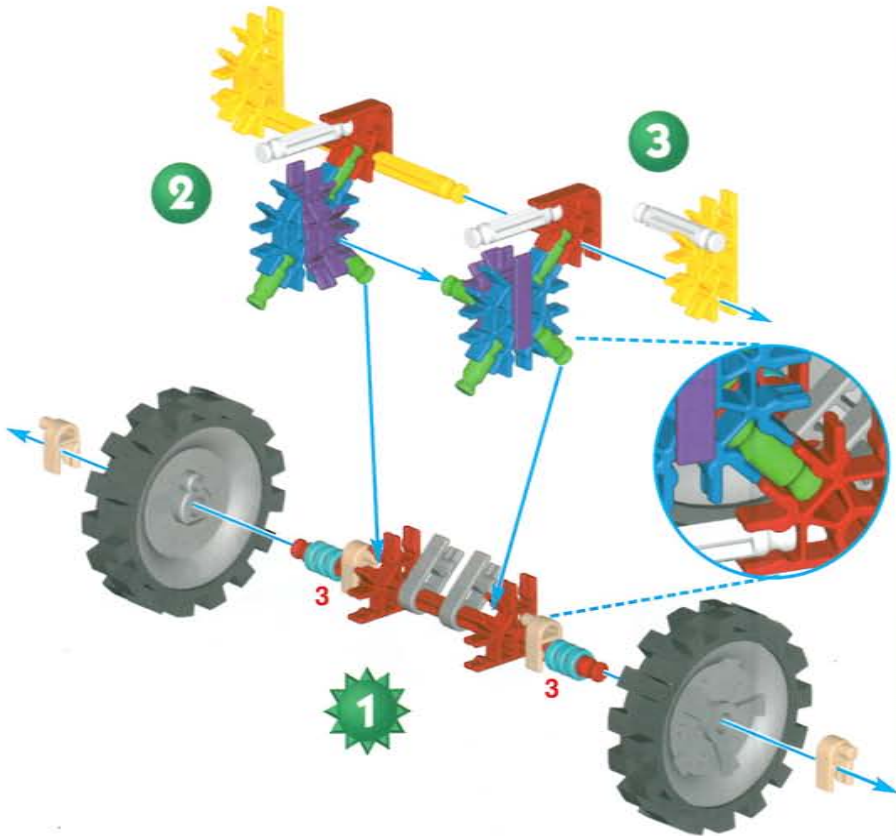

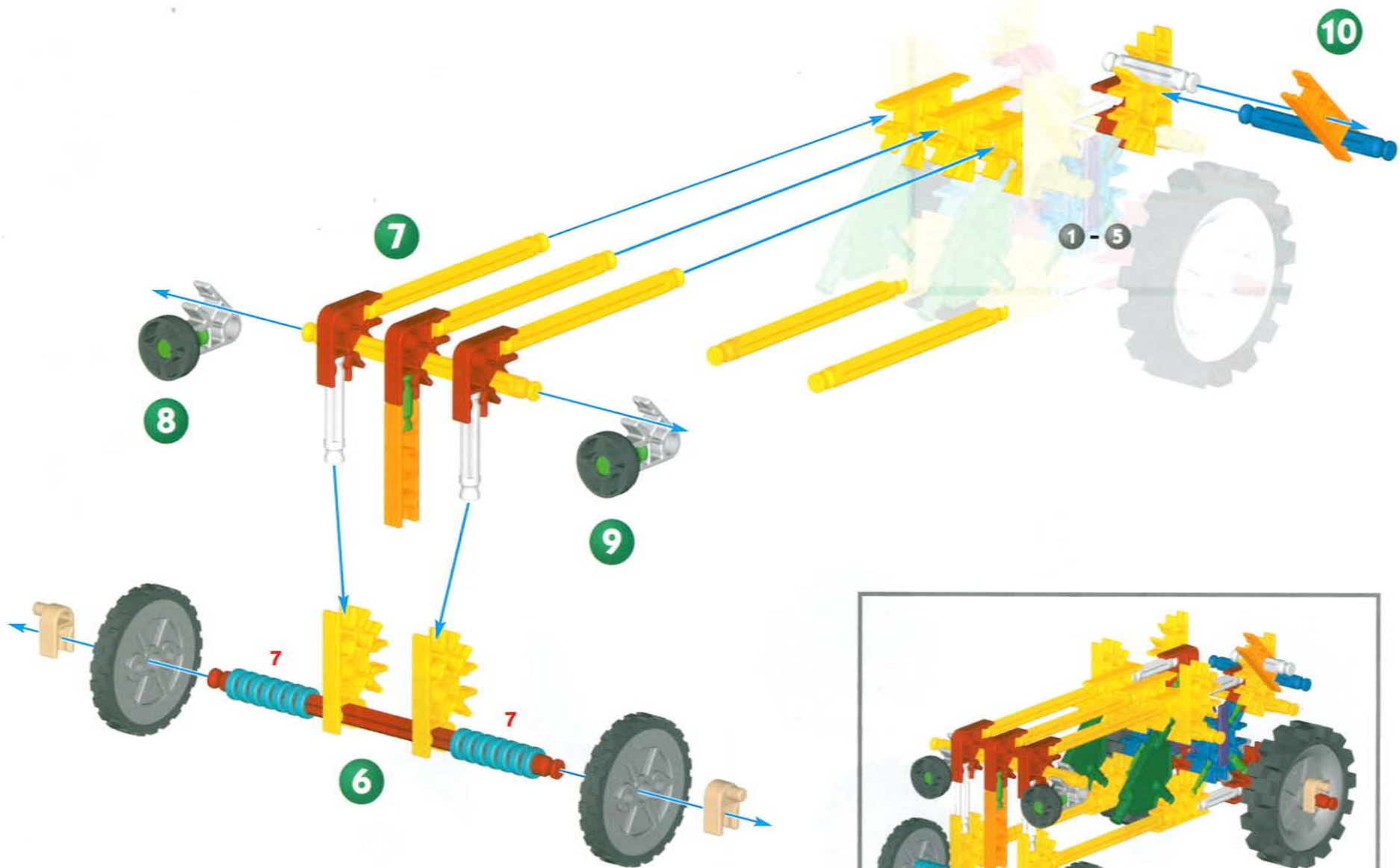

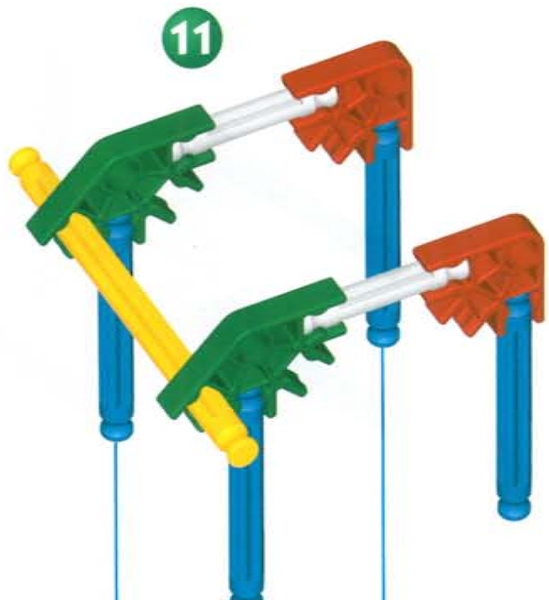

11

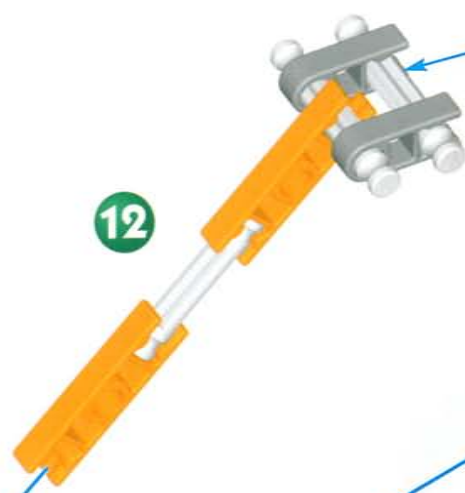

12



13

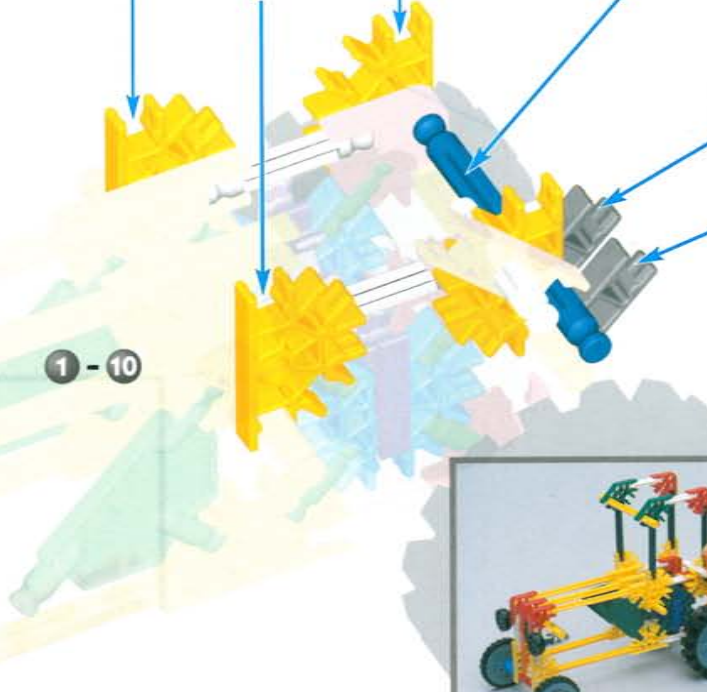

1 - 10

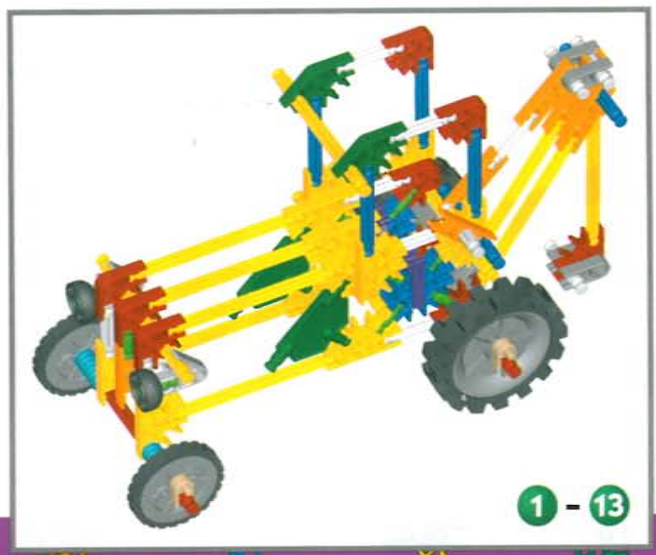

1 - 13

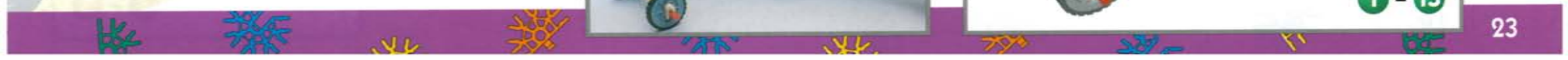

Road Grader

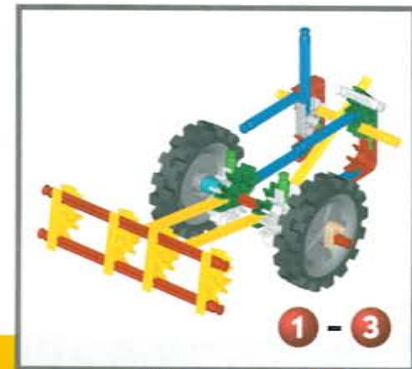
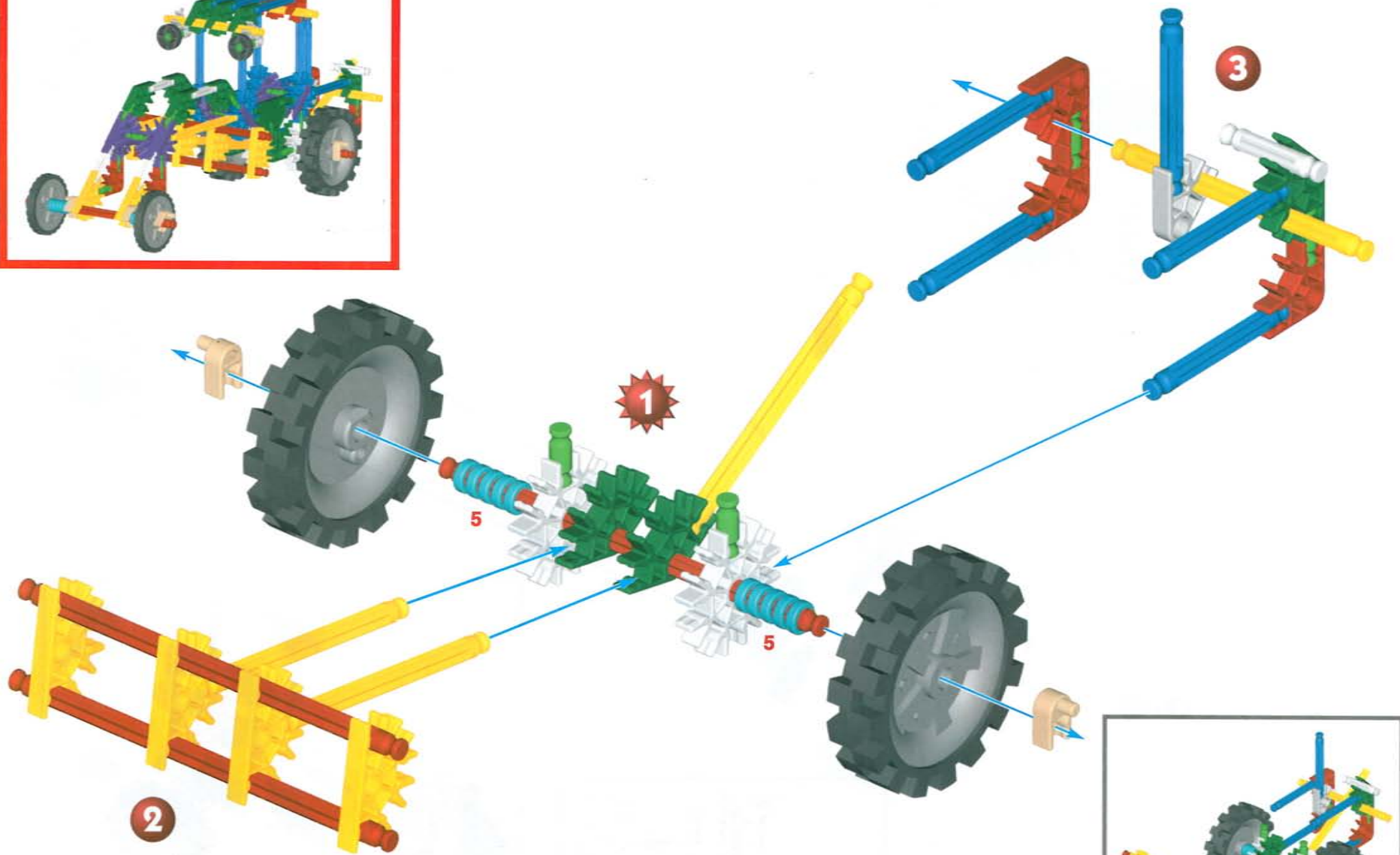

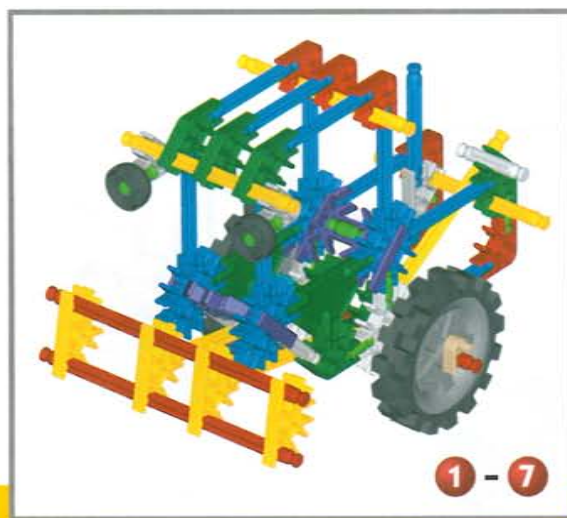
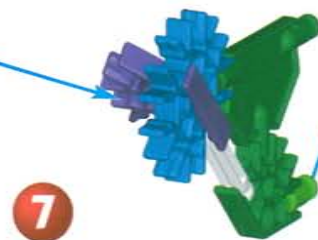
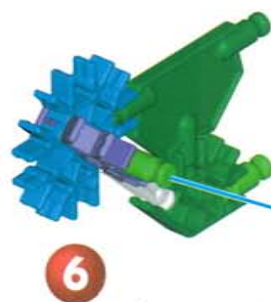
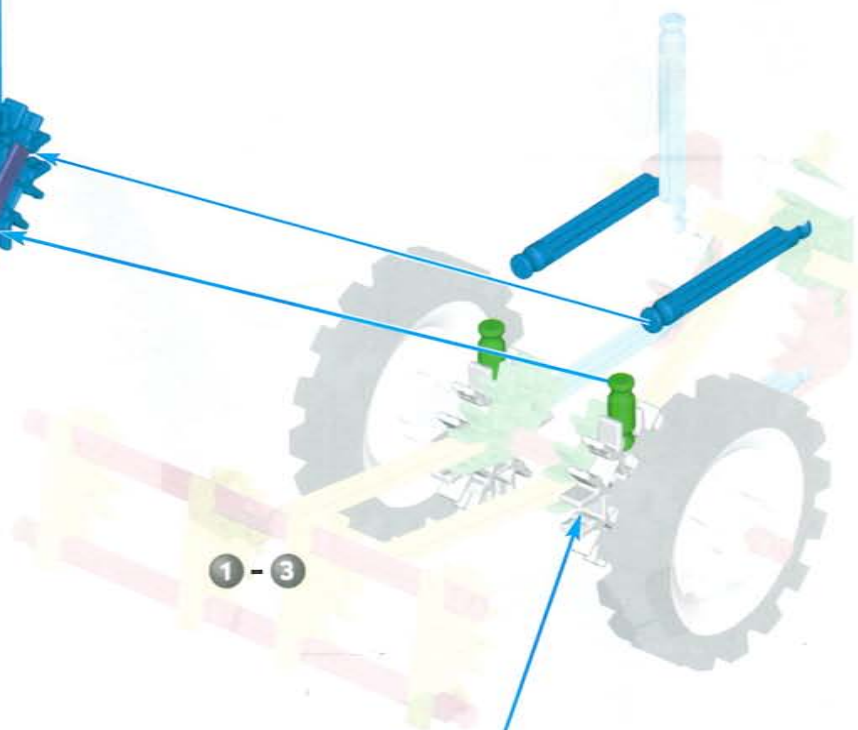
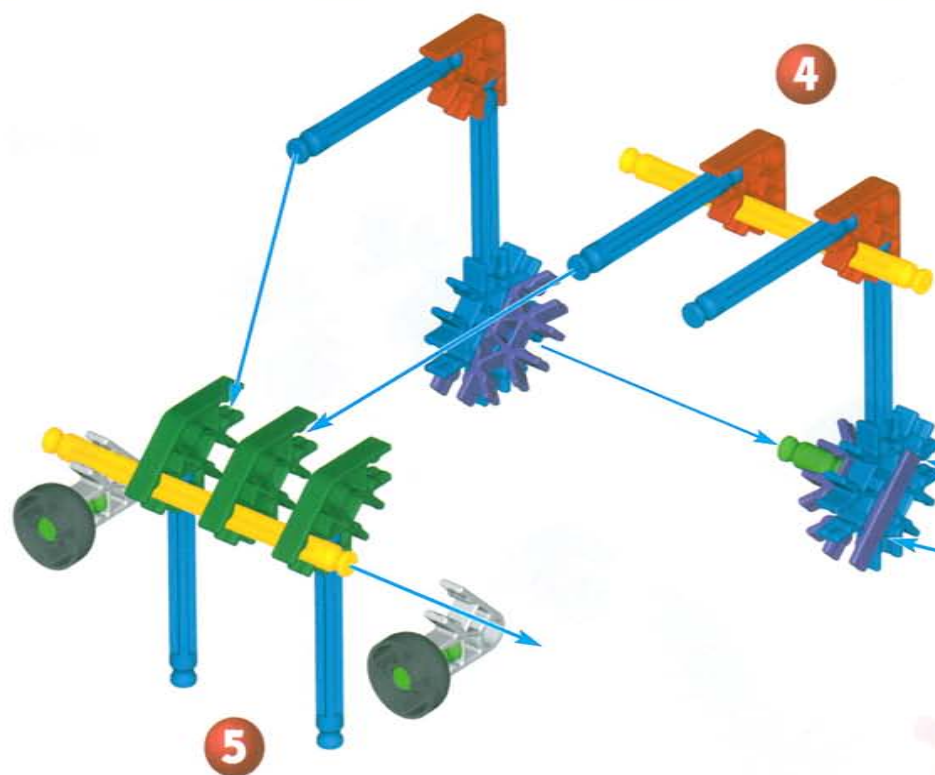

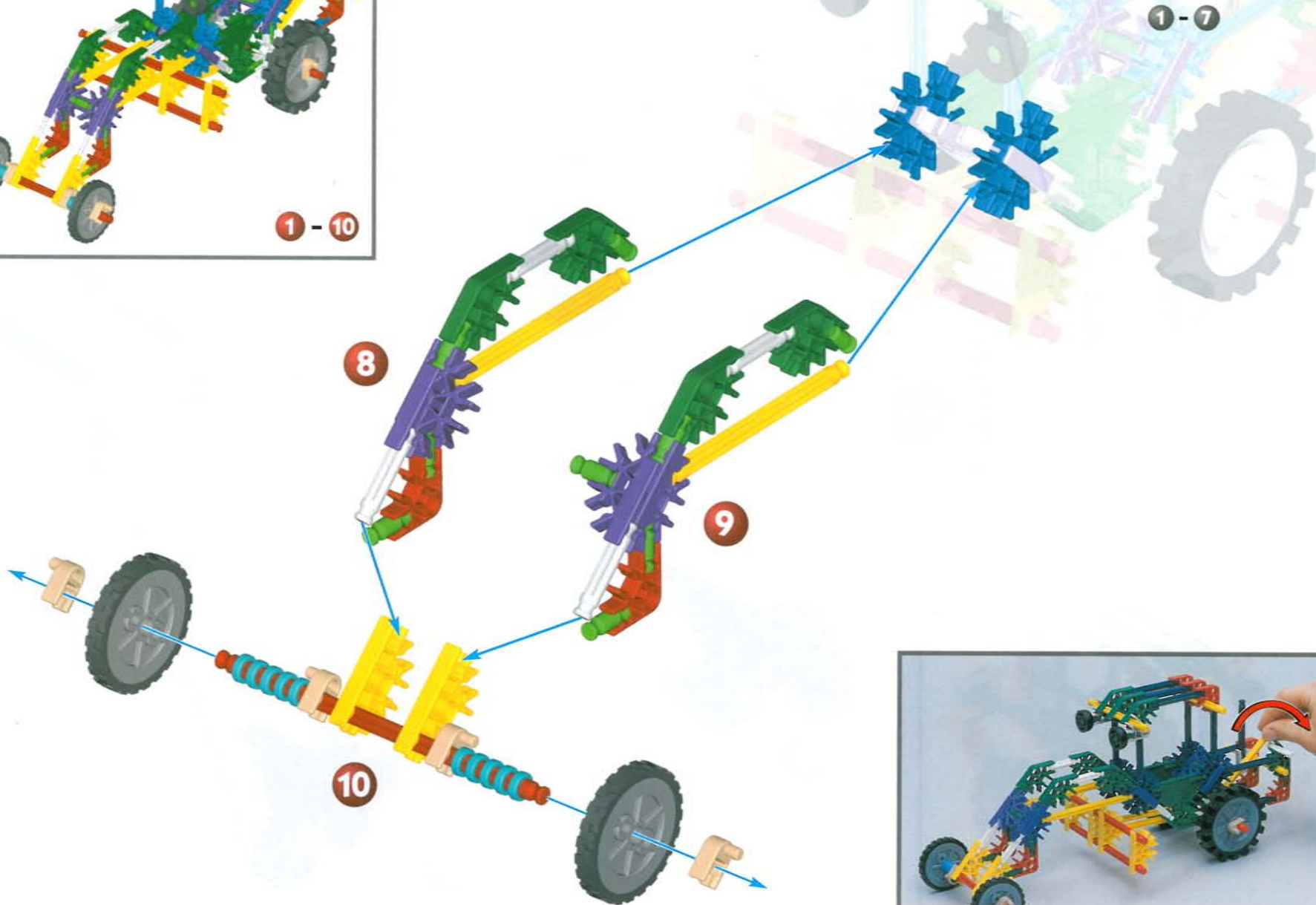
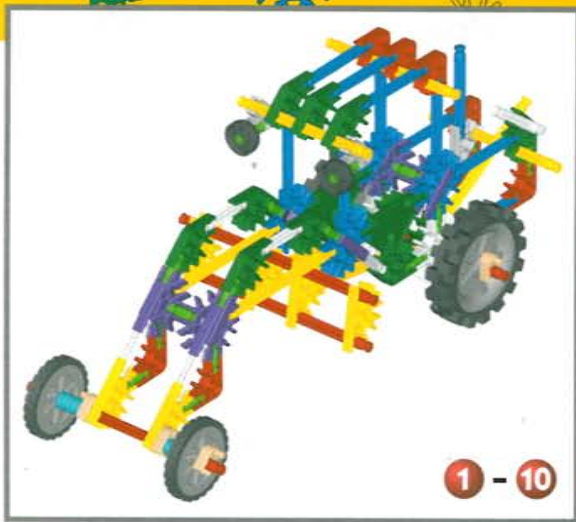

Ferris Wheel

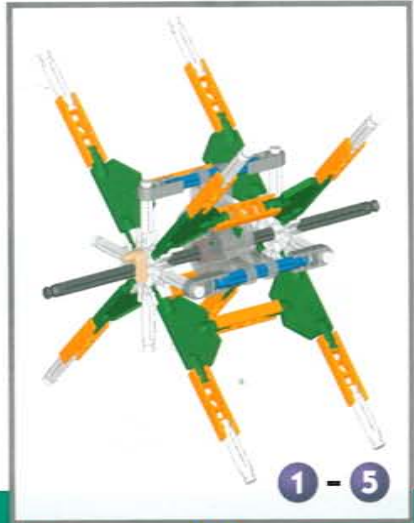
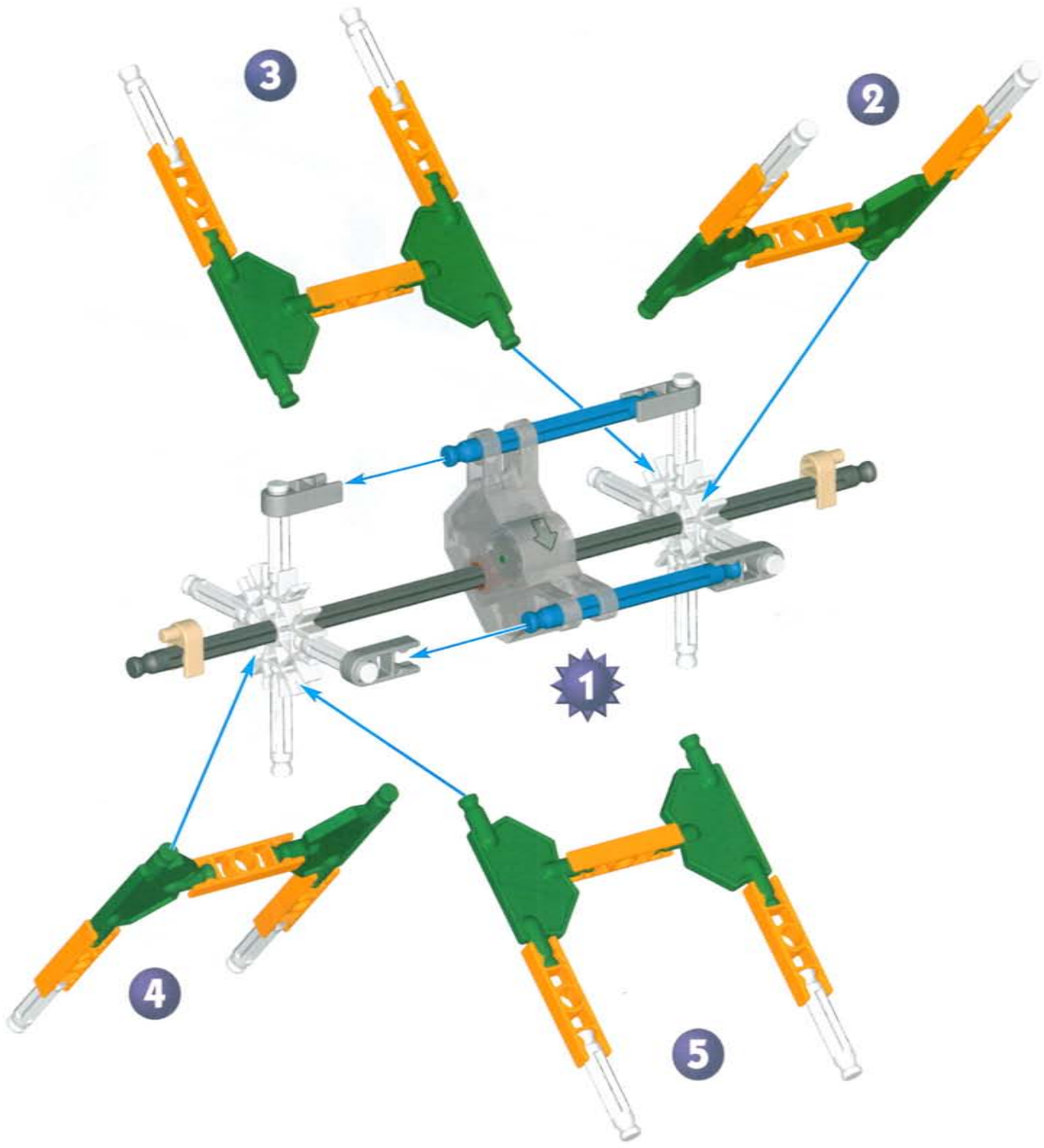

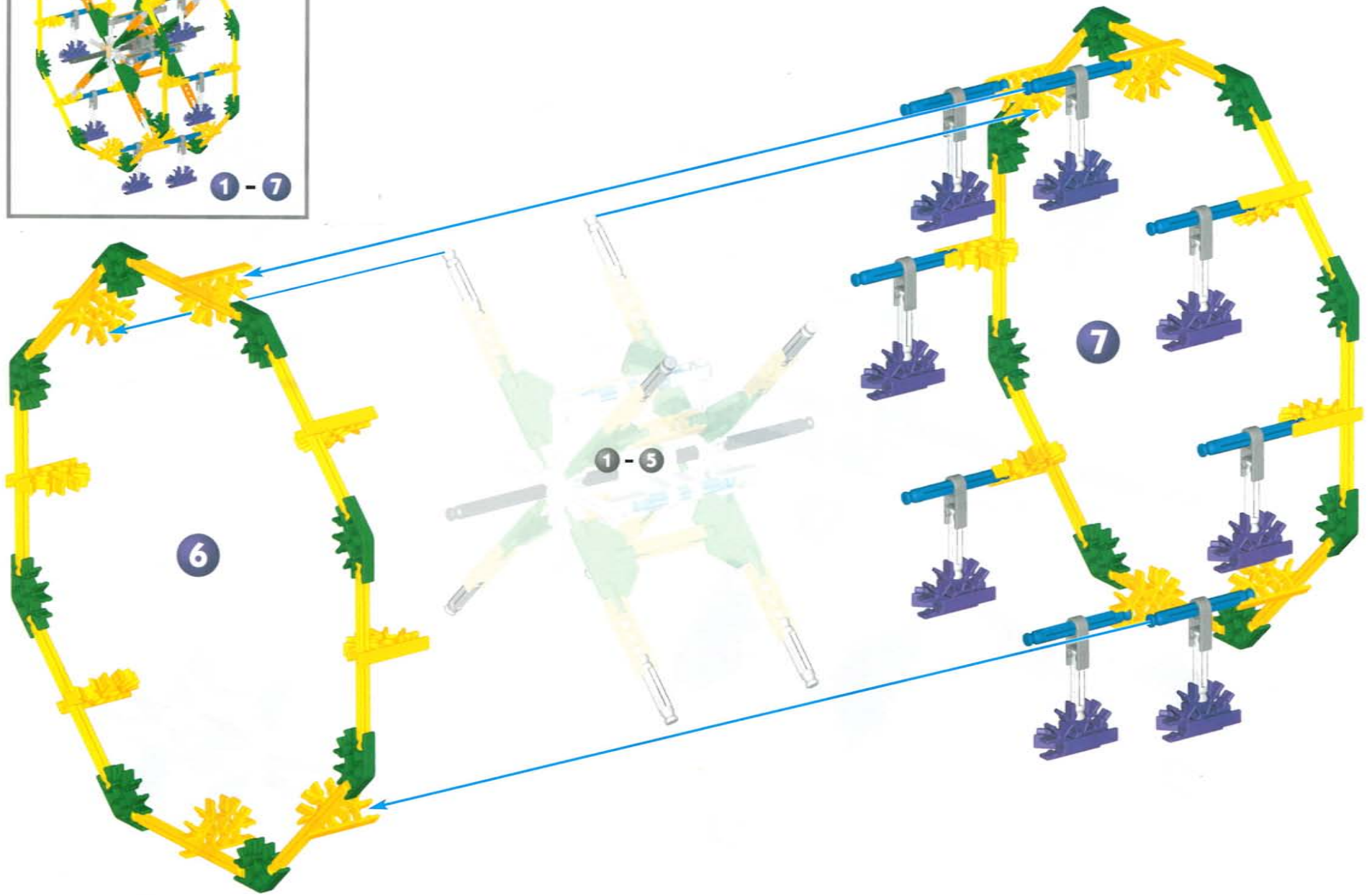
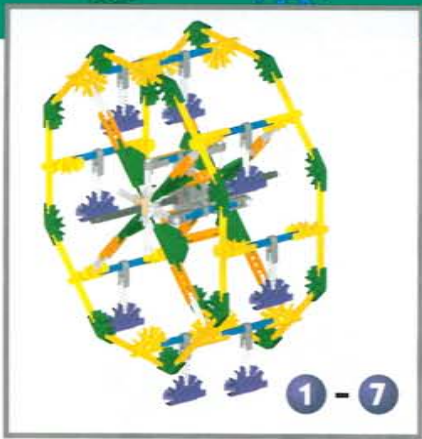

8

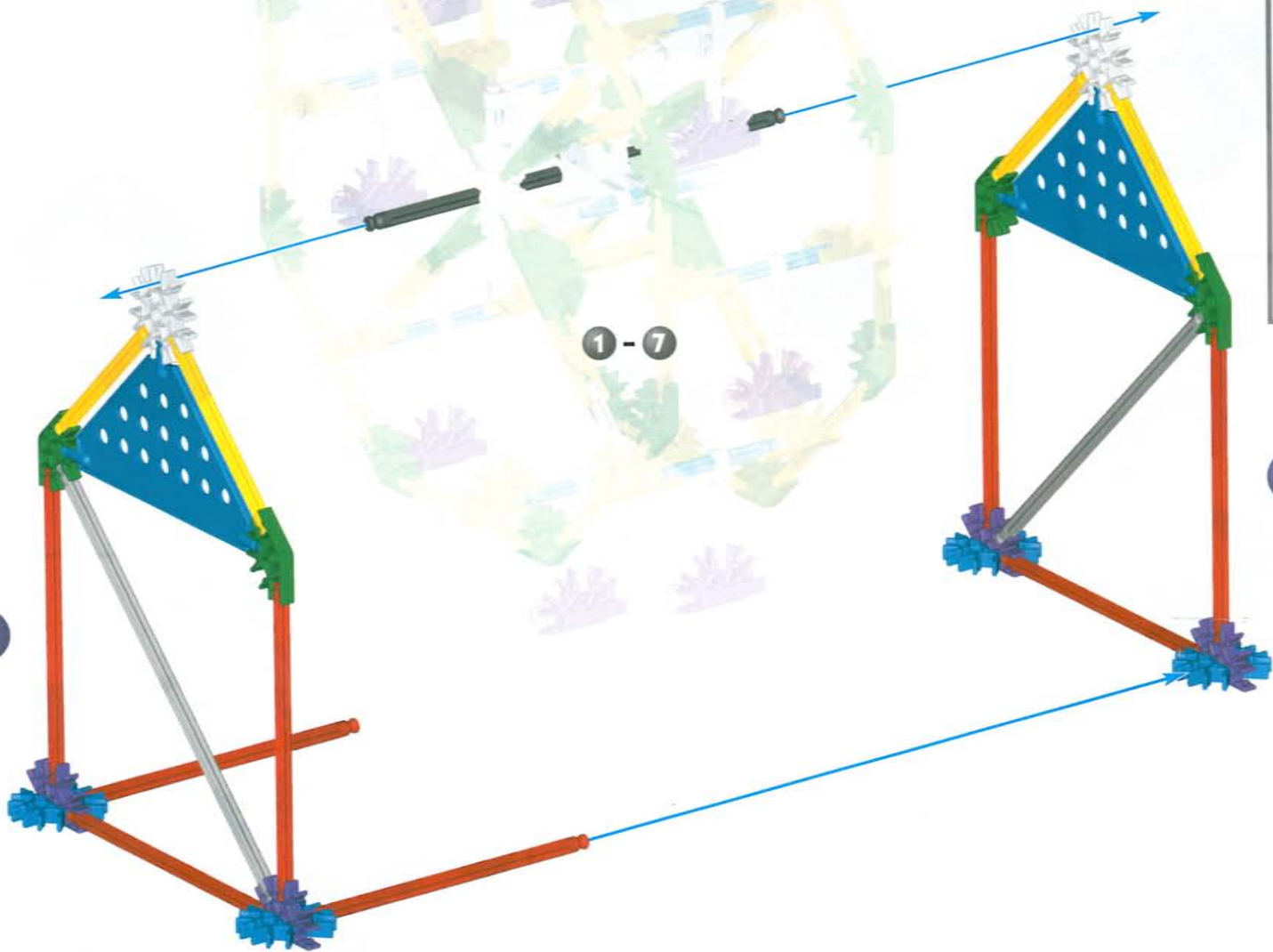

1 - 7

9

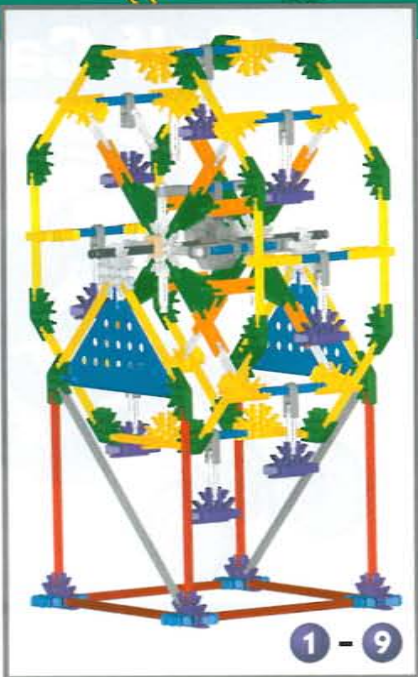

1 - 9

Golf Cart

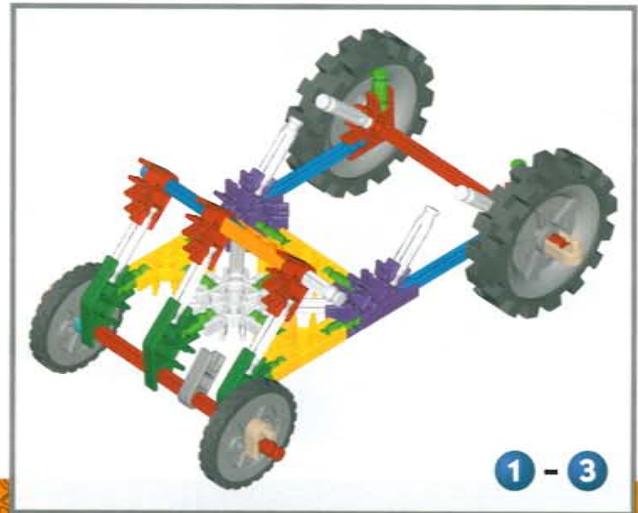
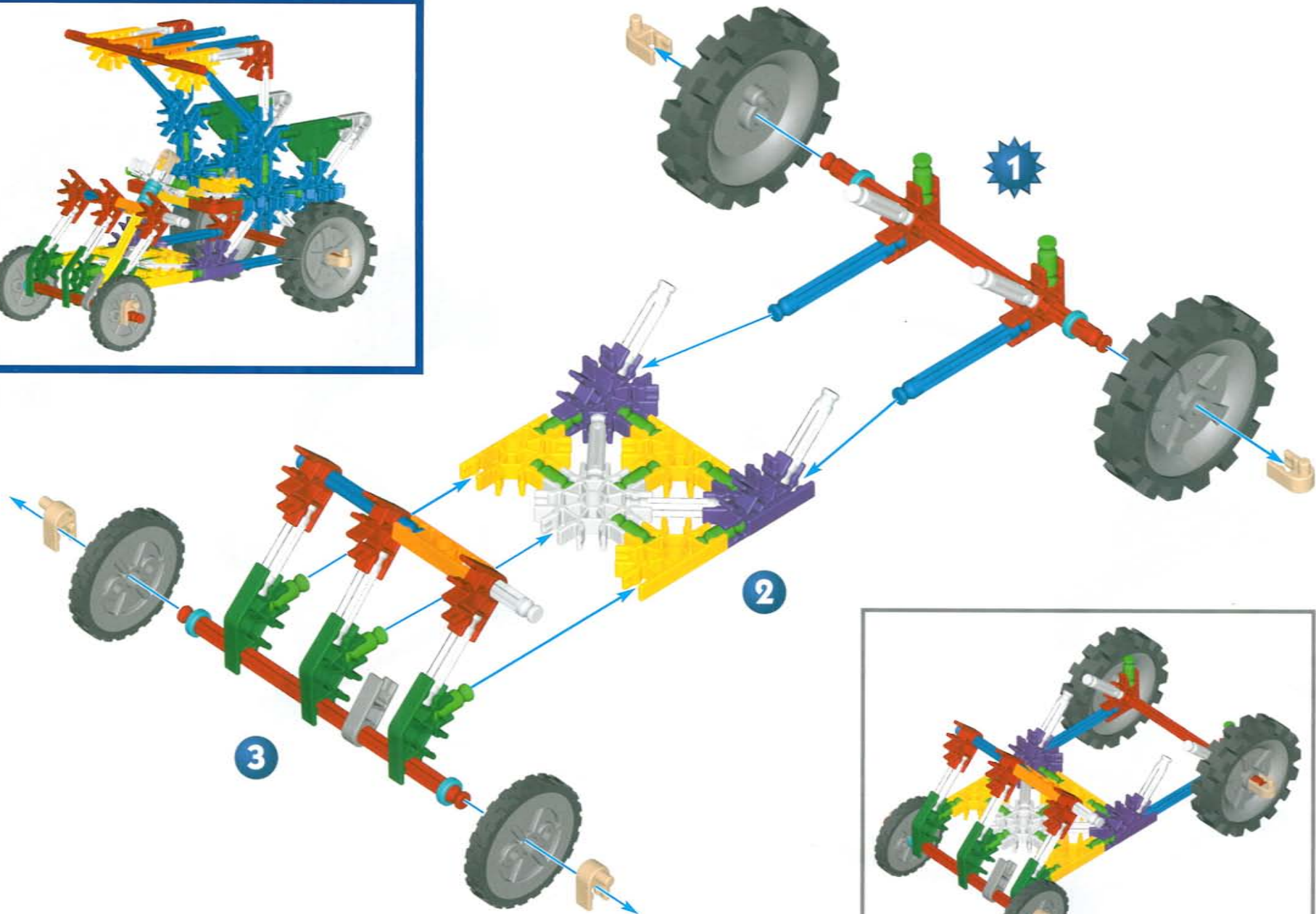

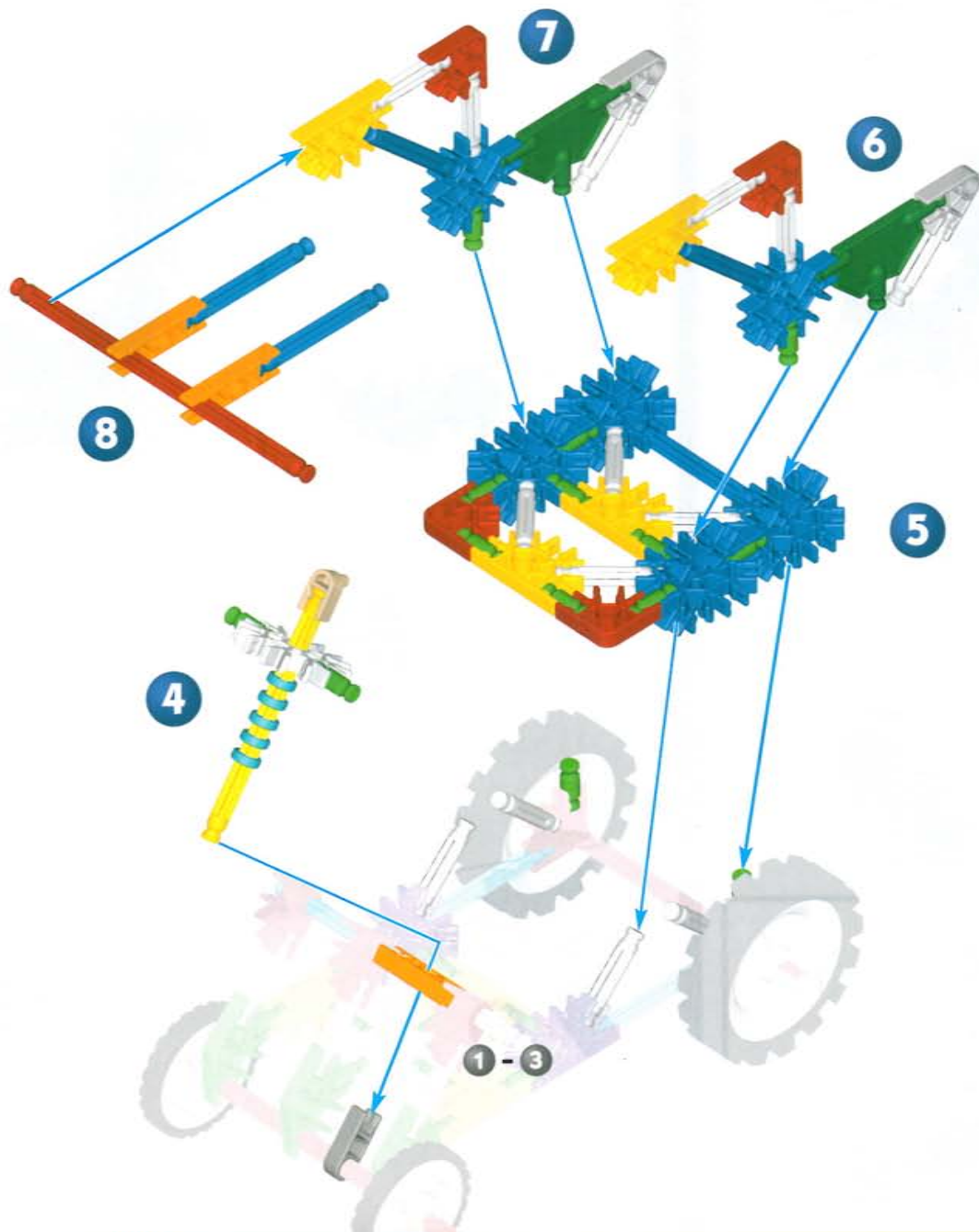

Praying Mantis

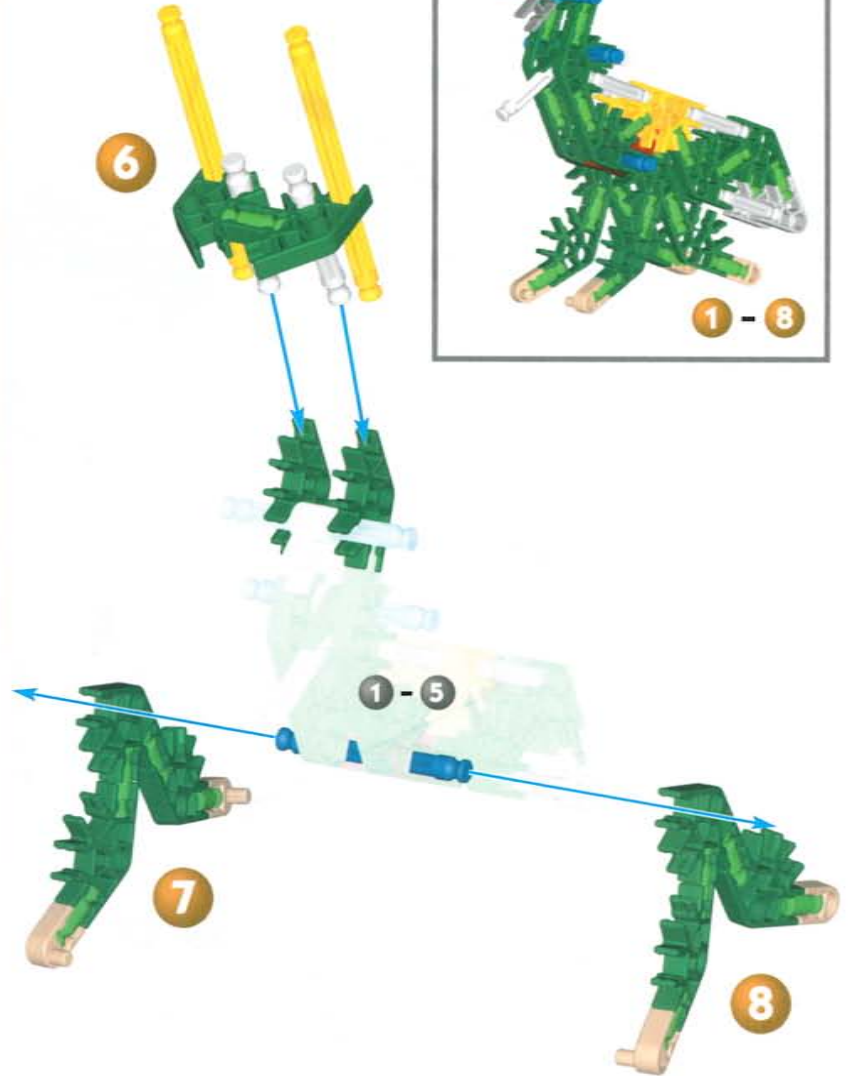
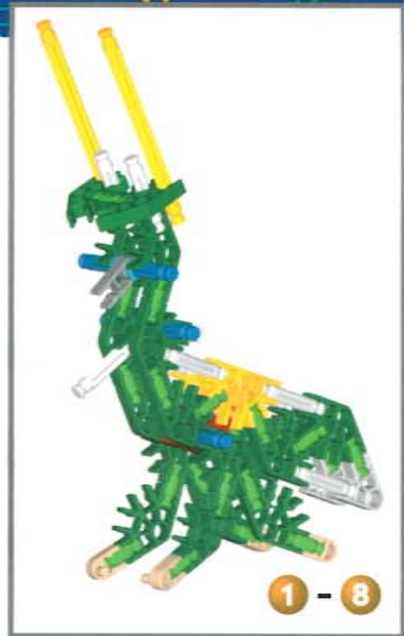
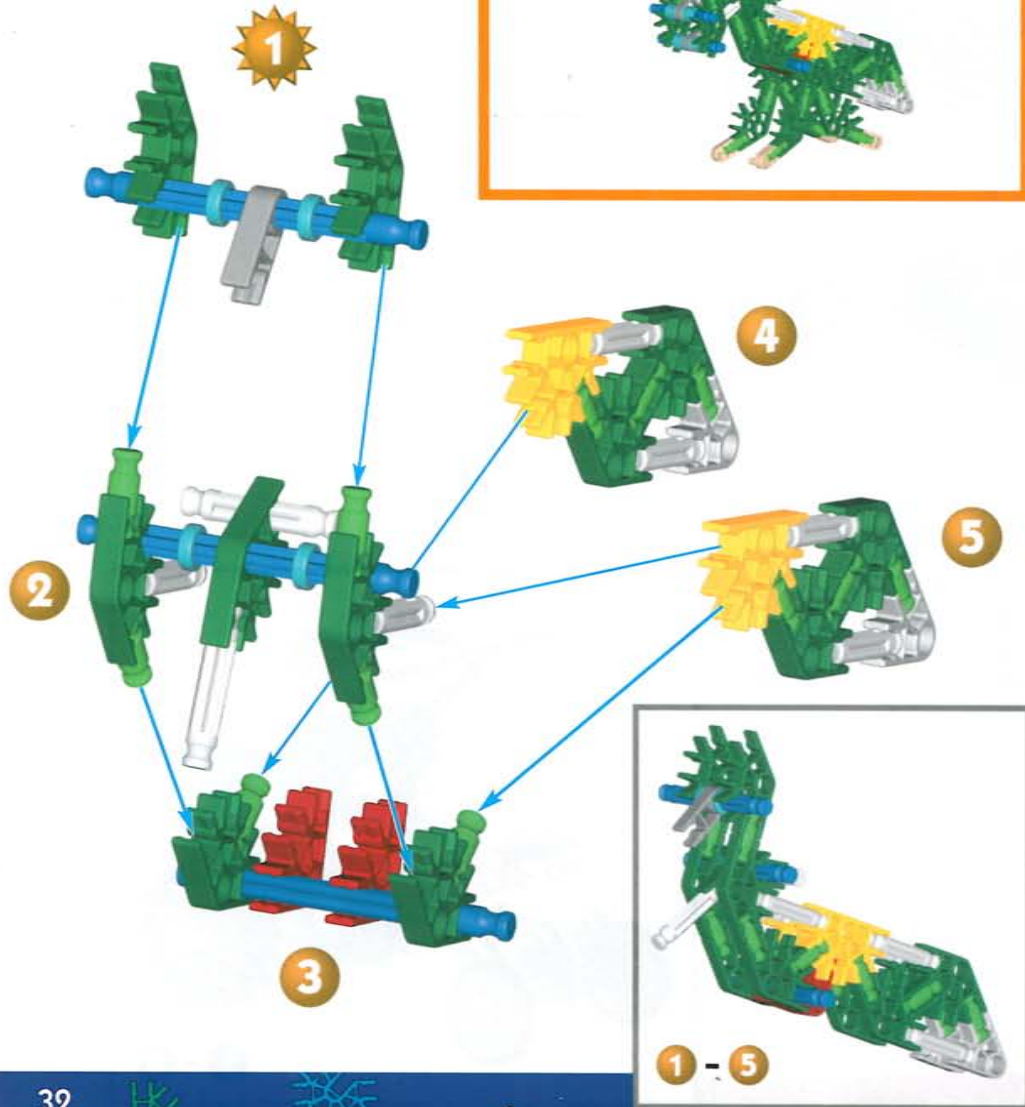

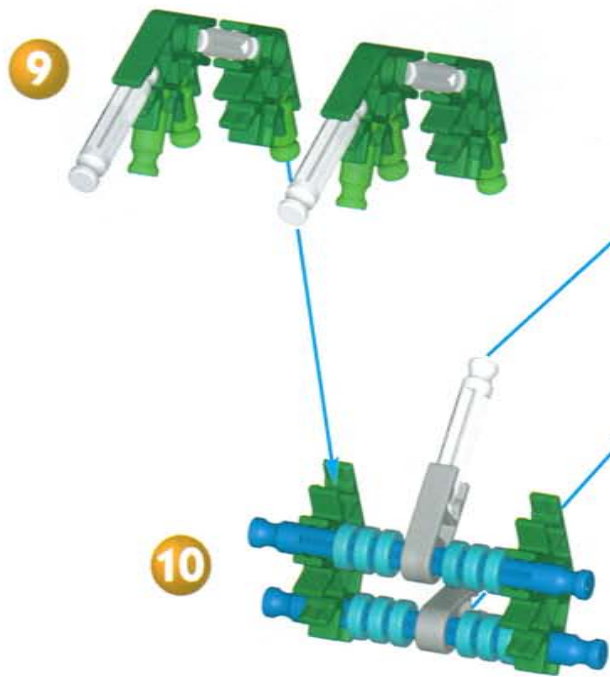

Helicopter

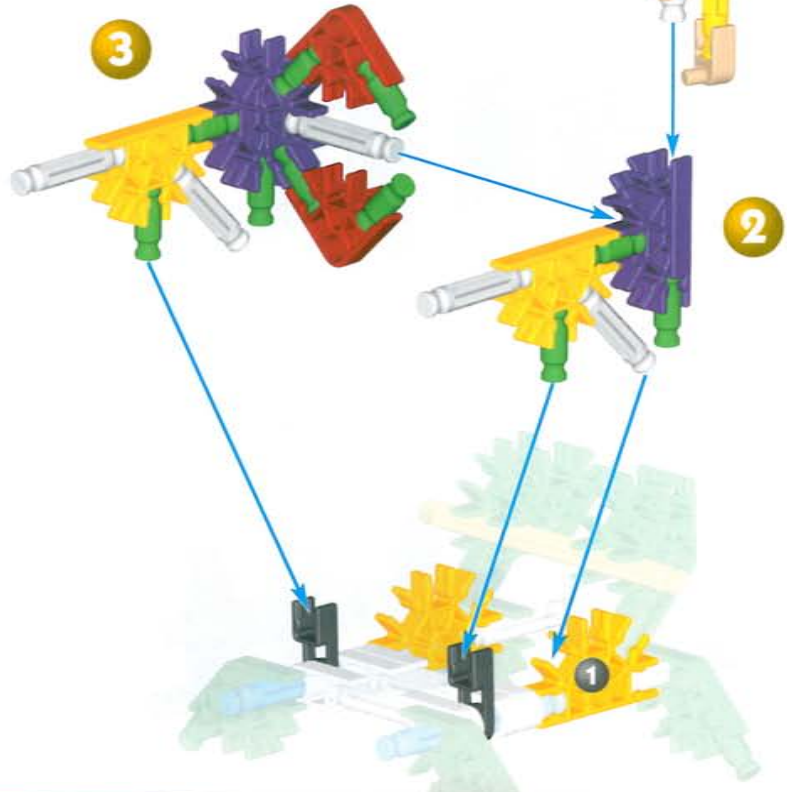
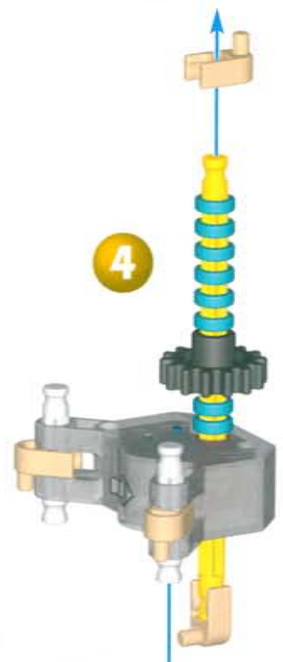
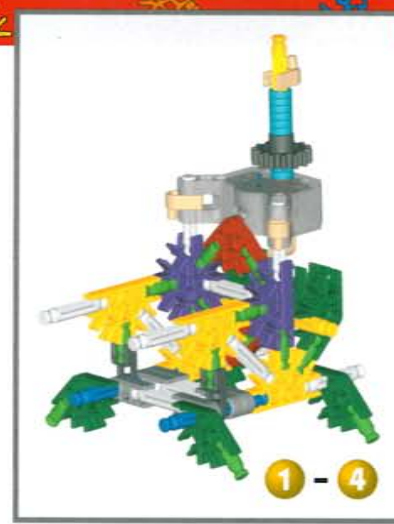
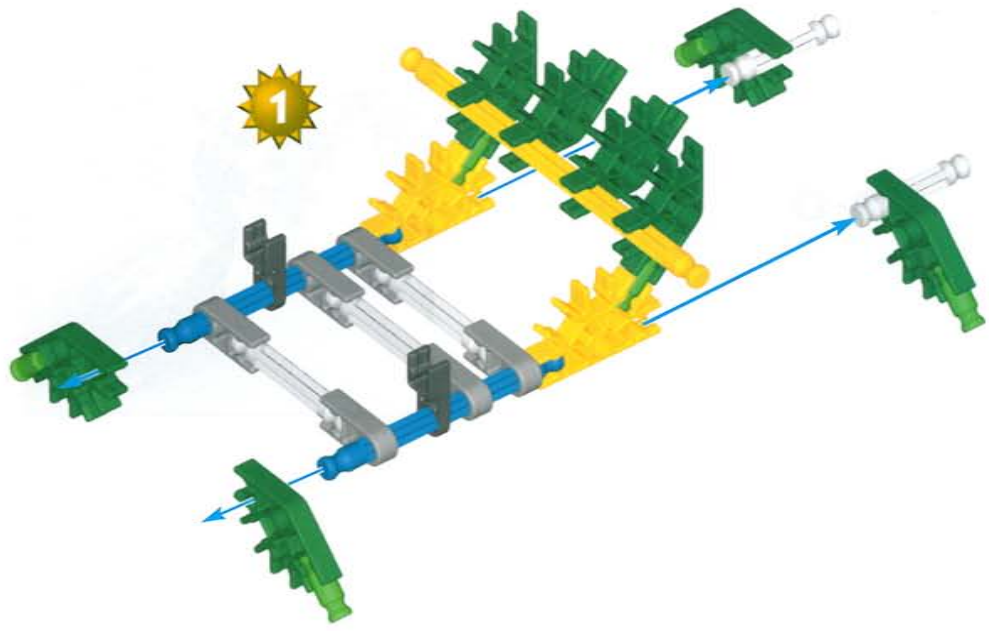
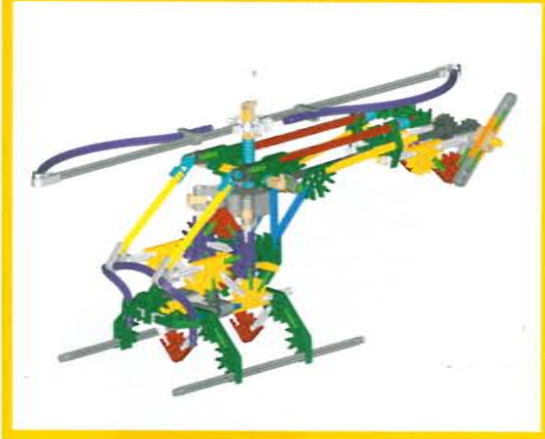

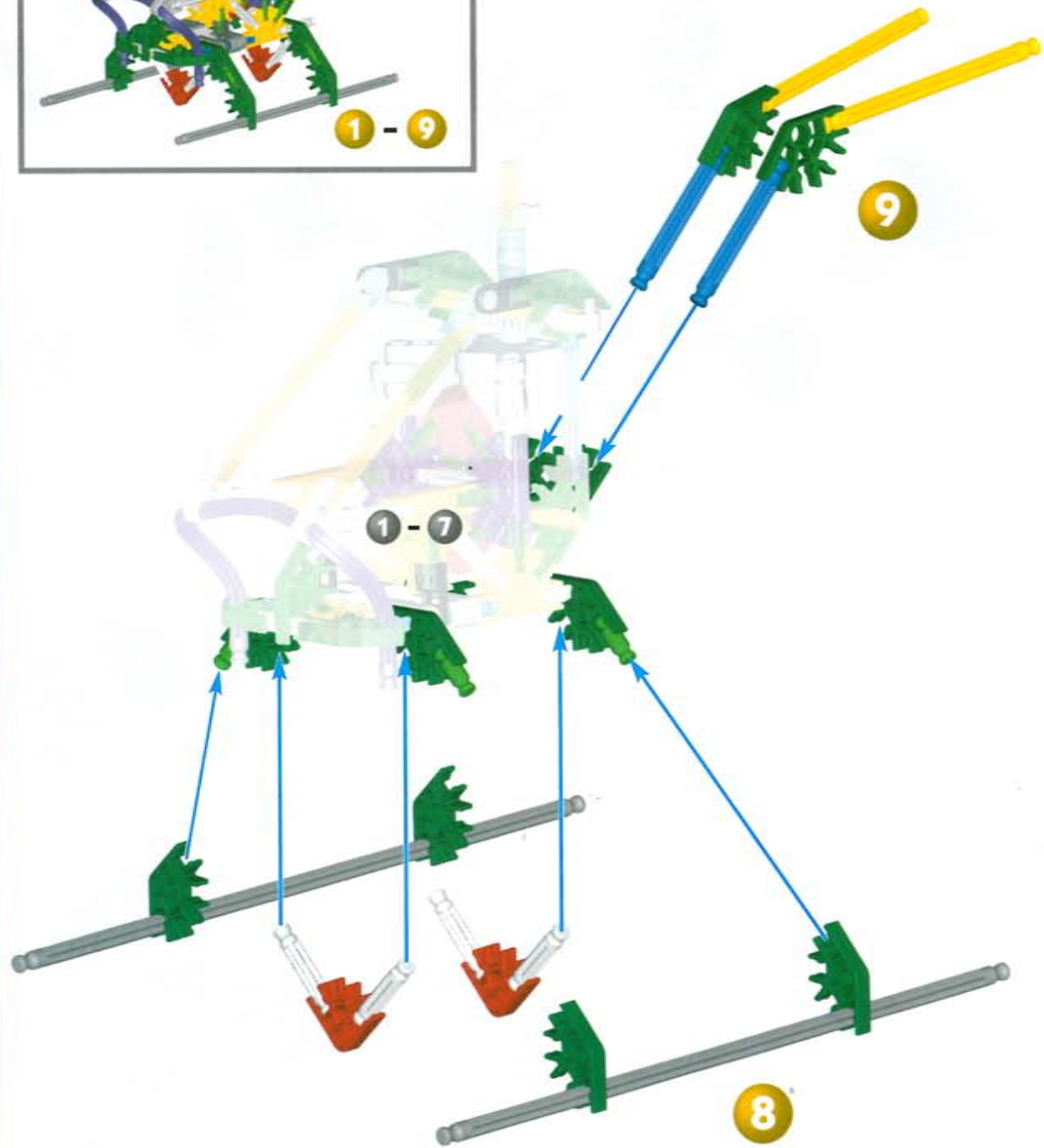
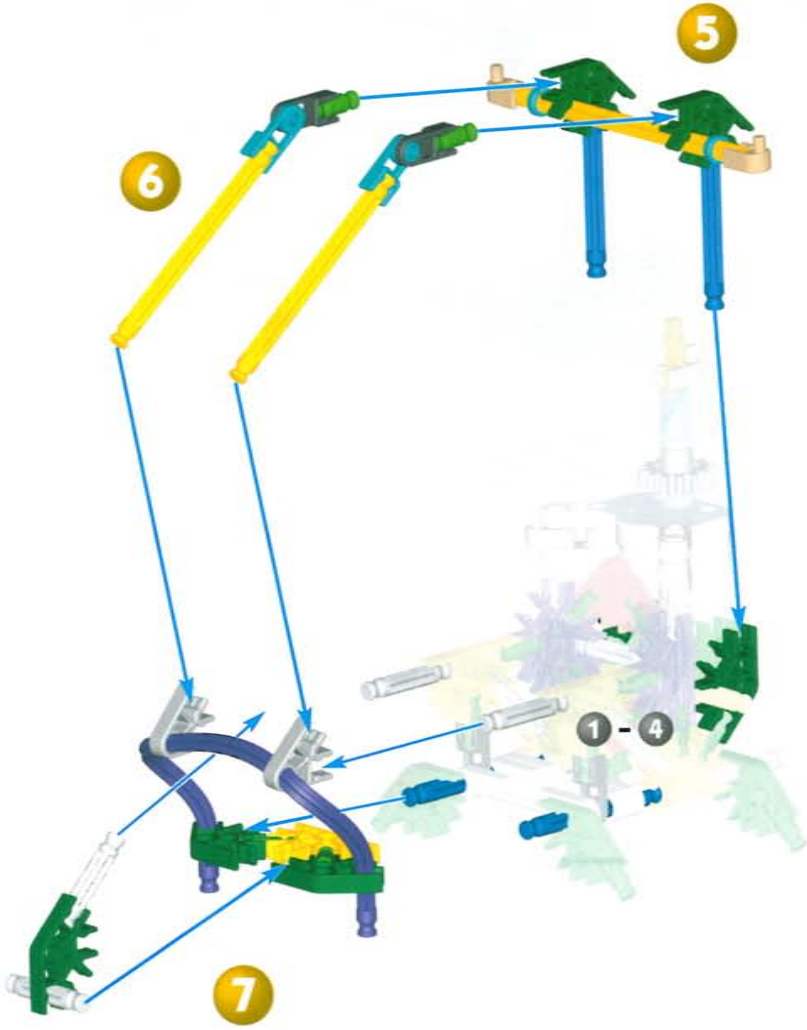

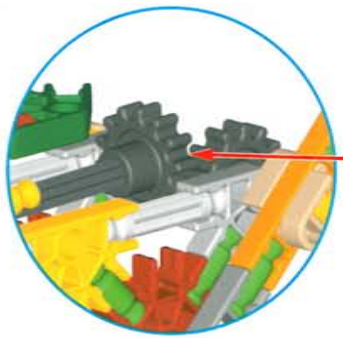
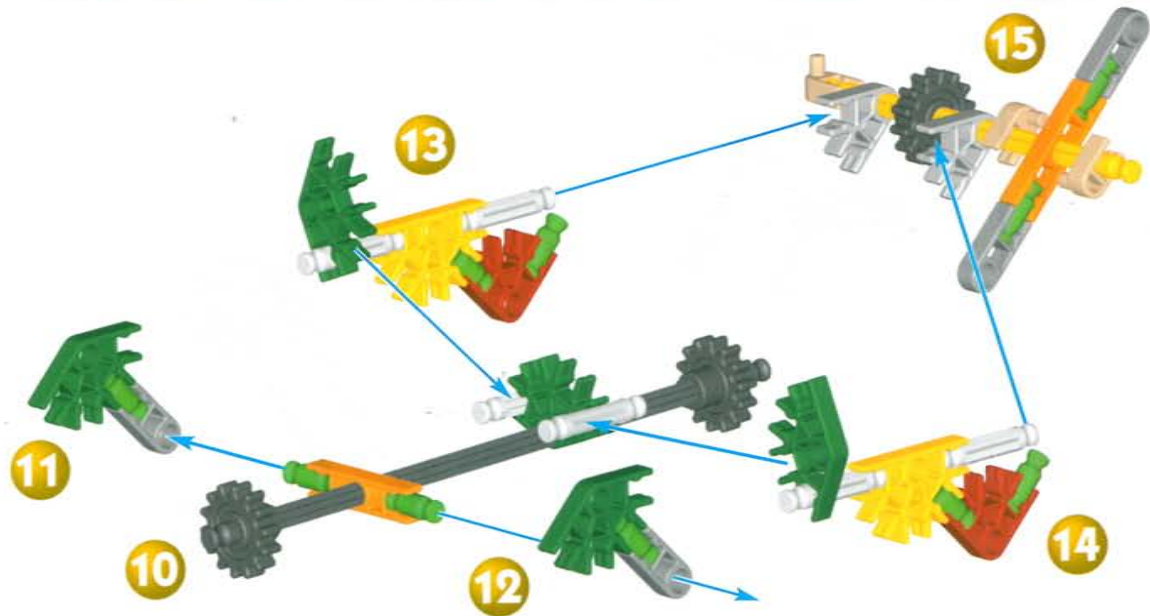

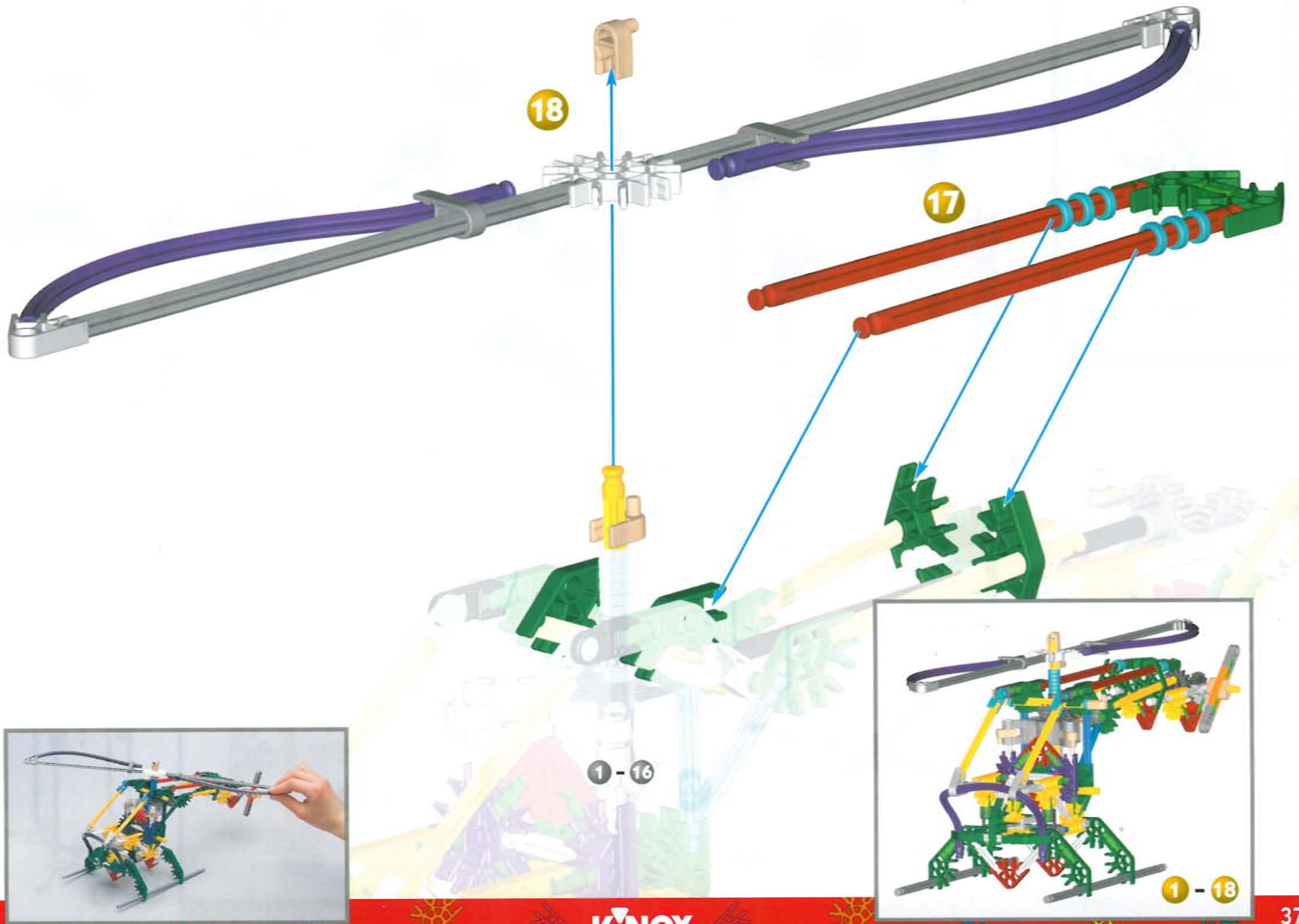

Windmill

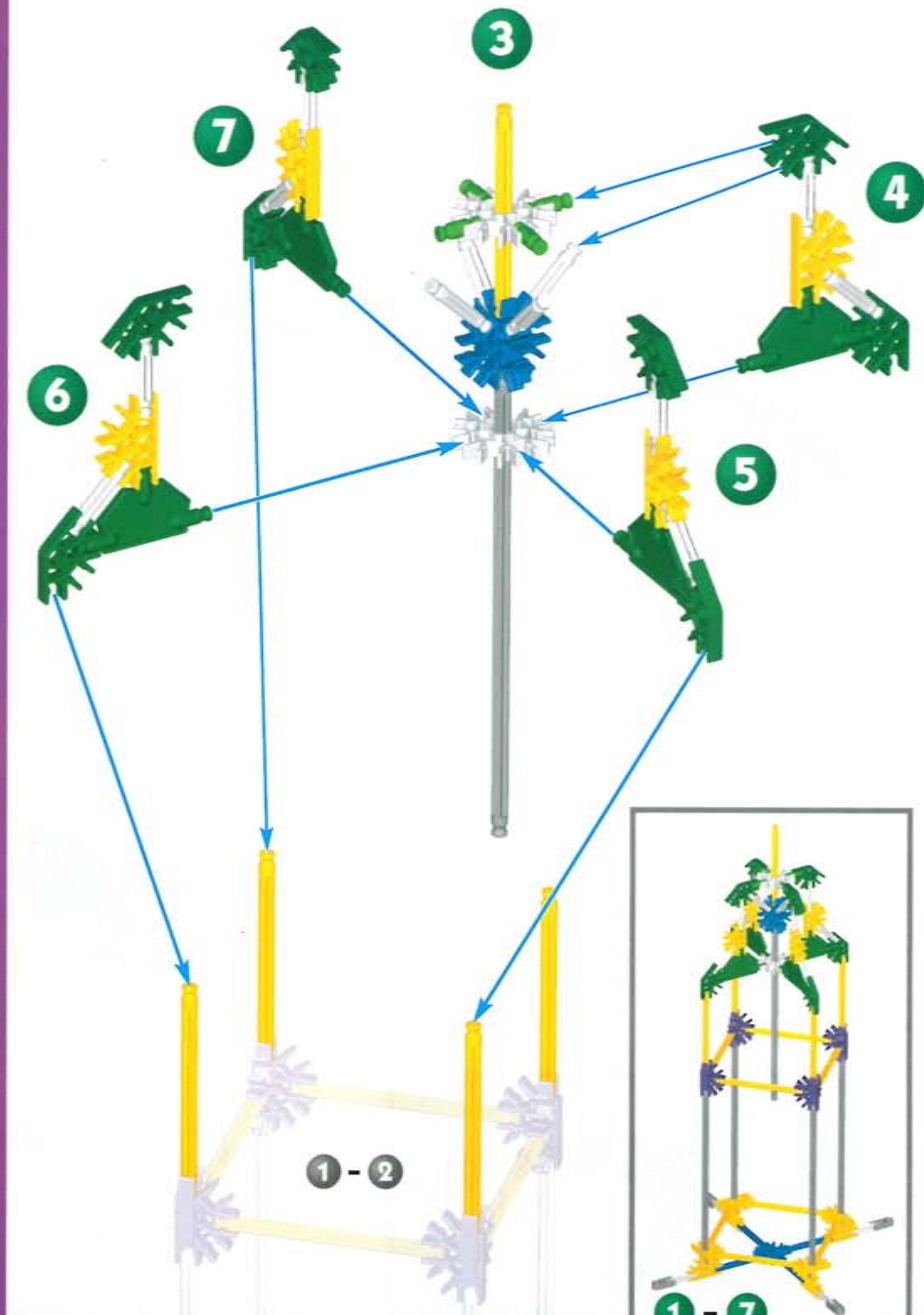
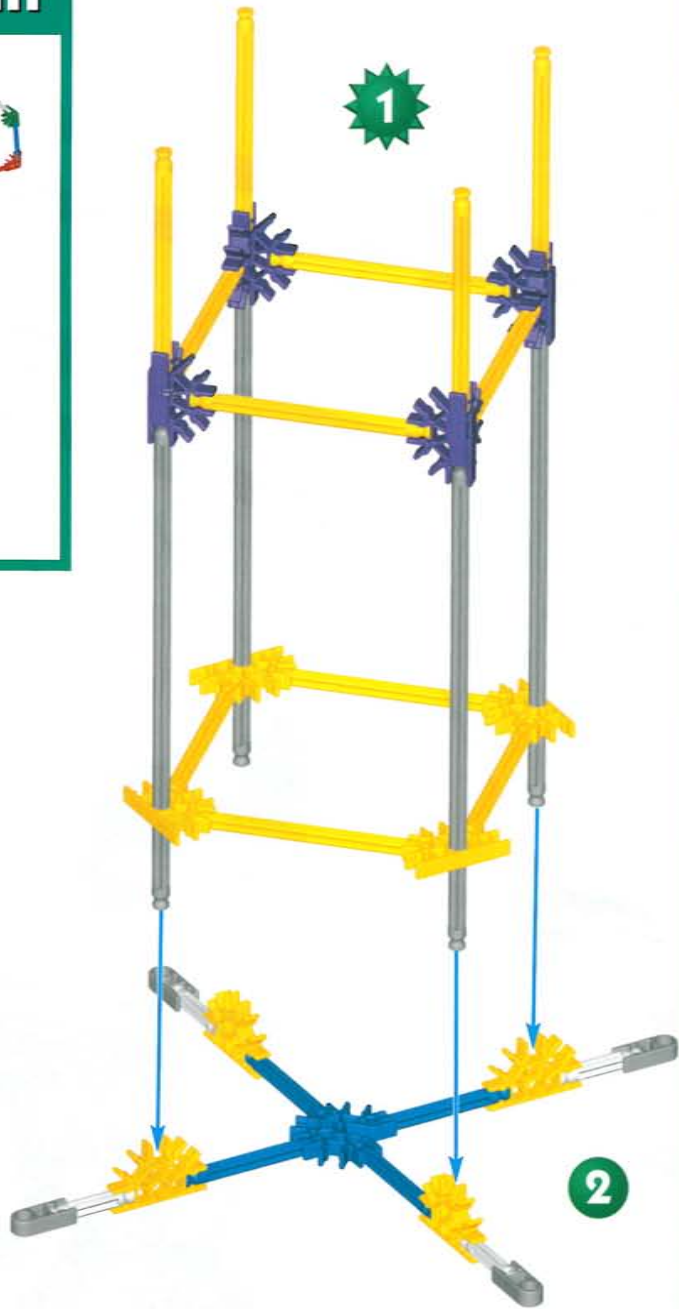

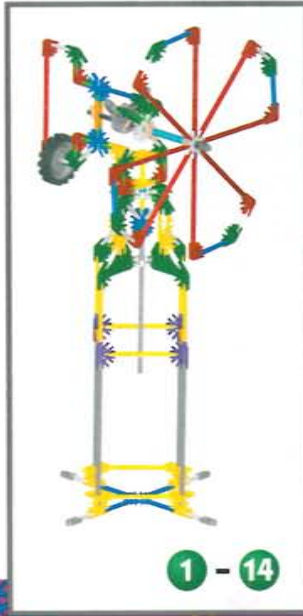
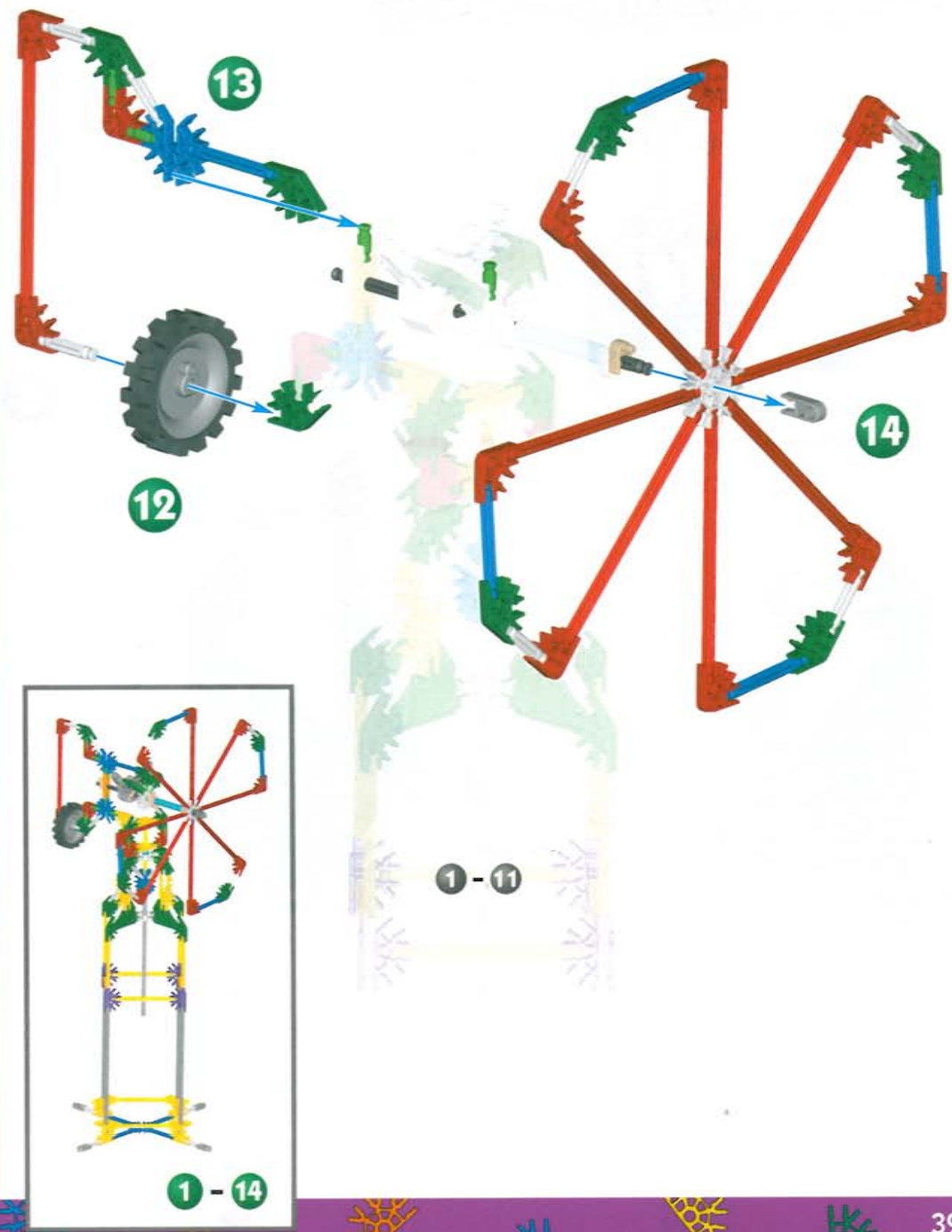
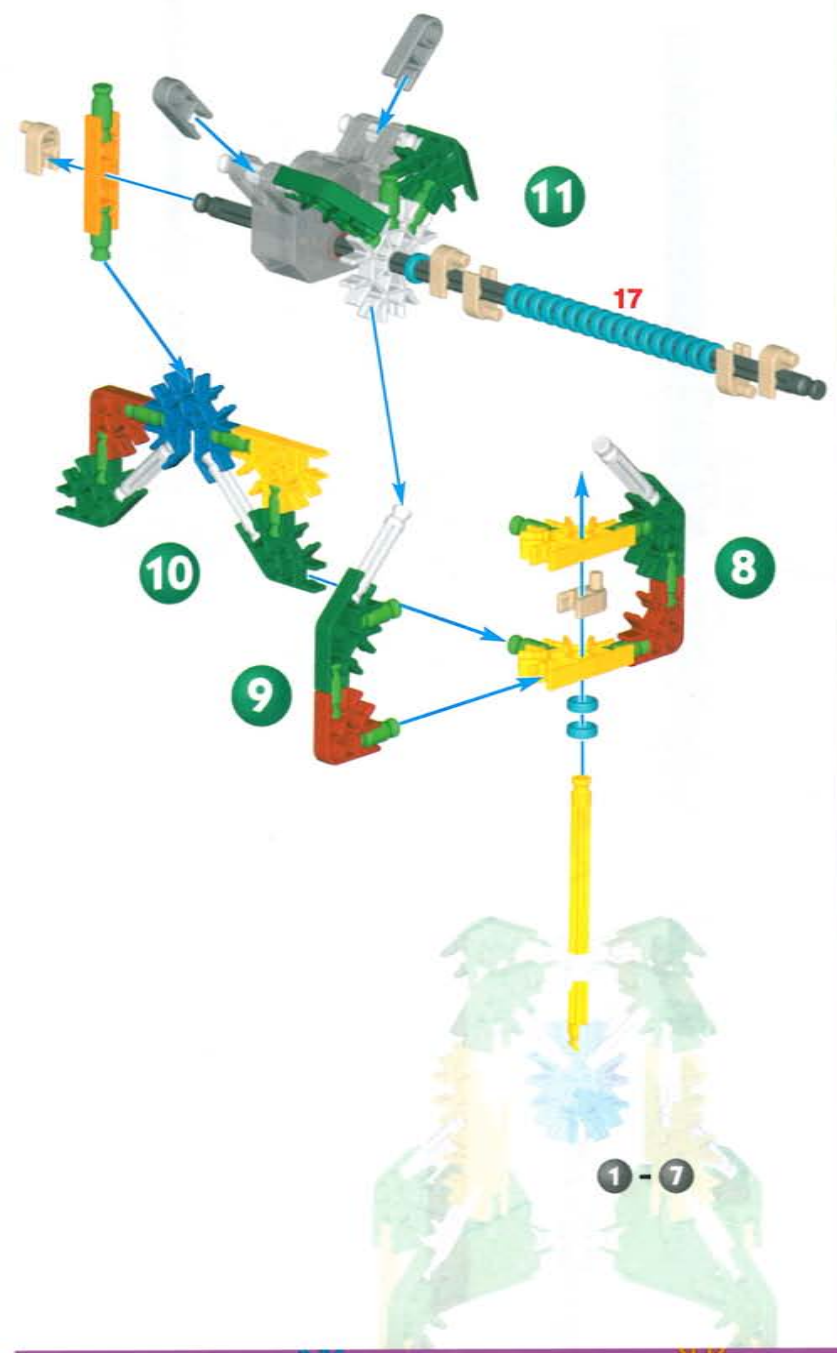

Spaceship Ride

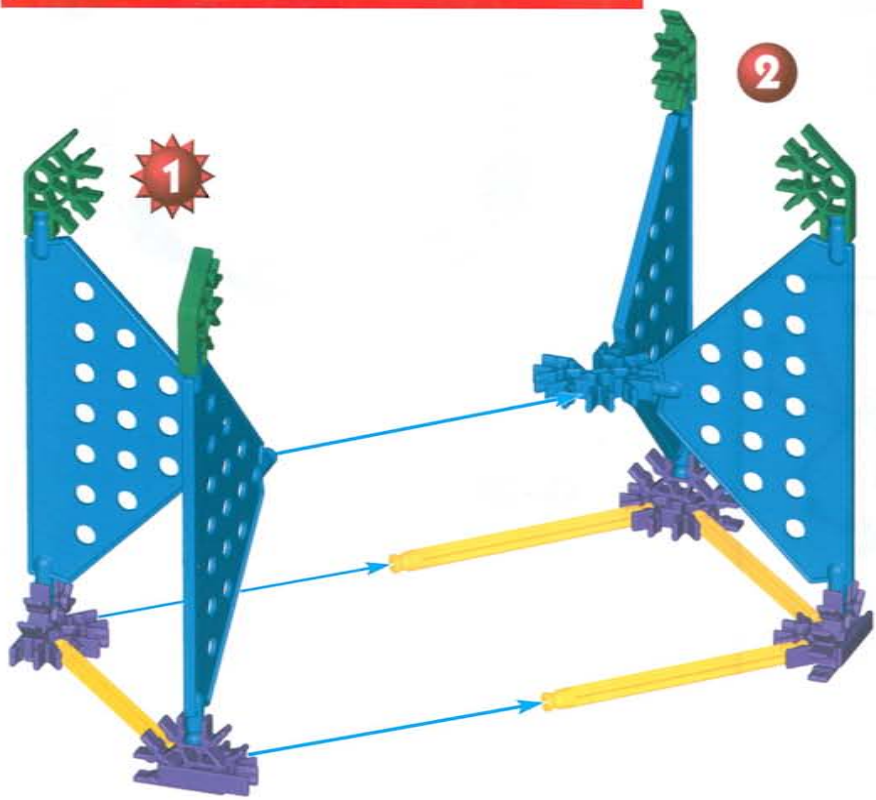

2

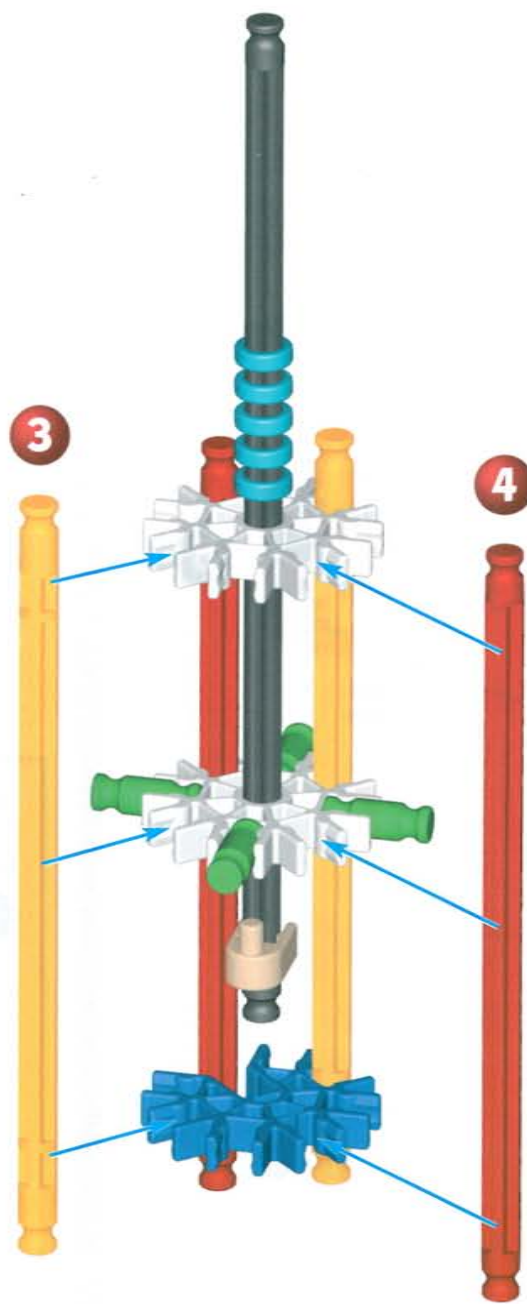

3

4

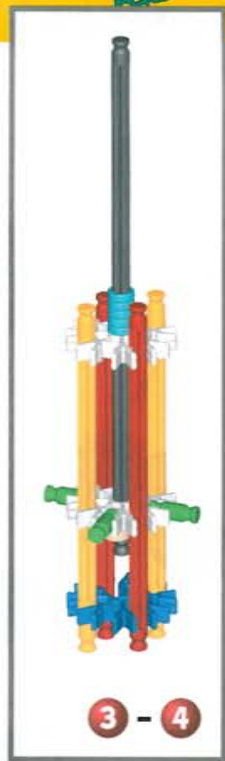

3 - 4

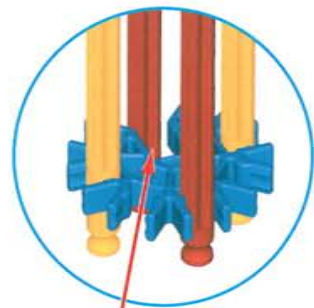

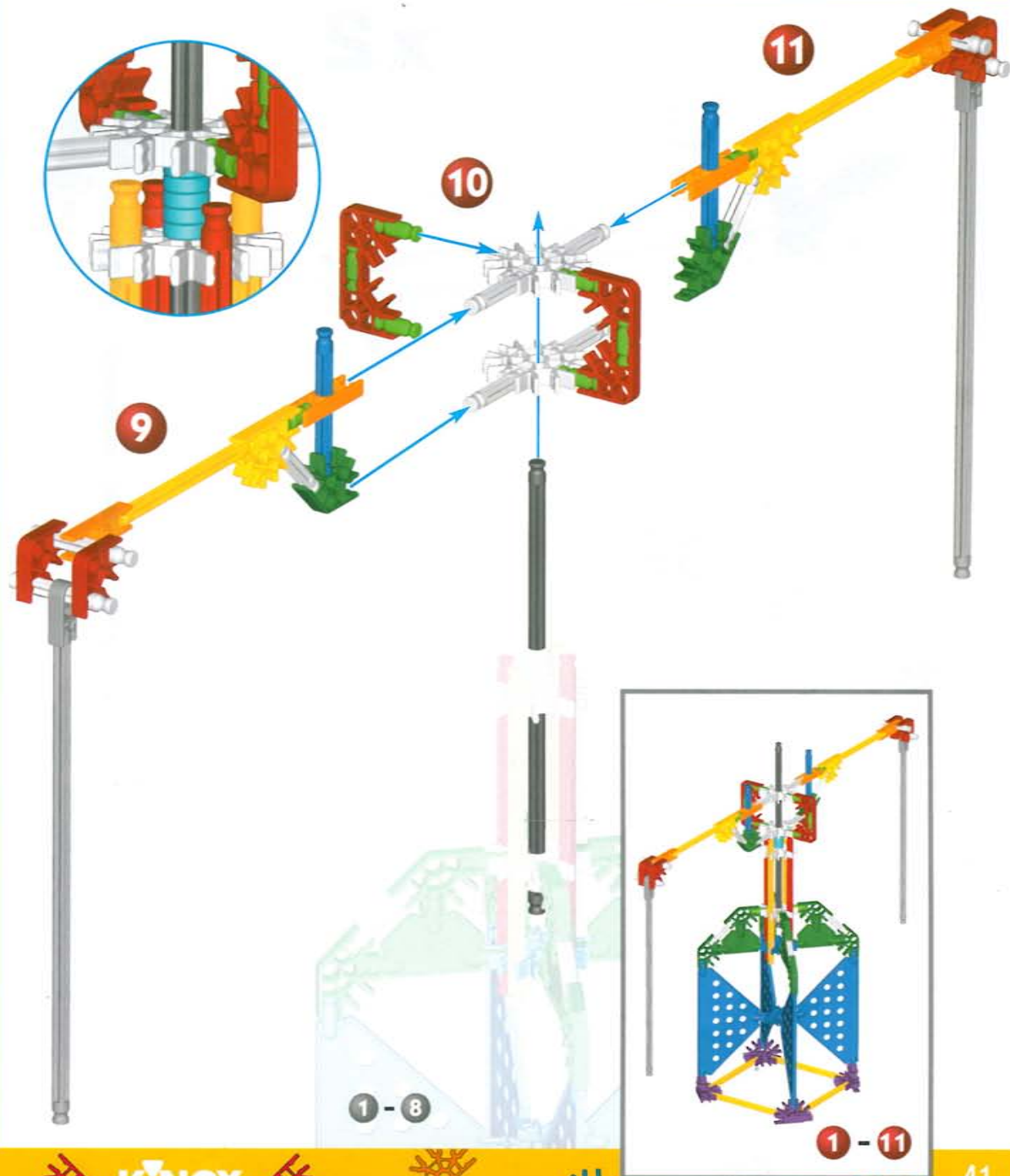
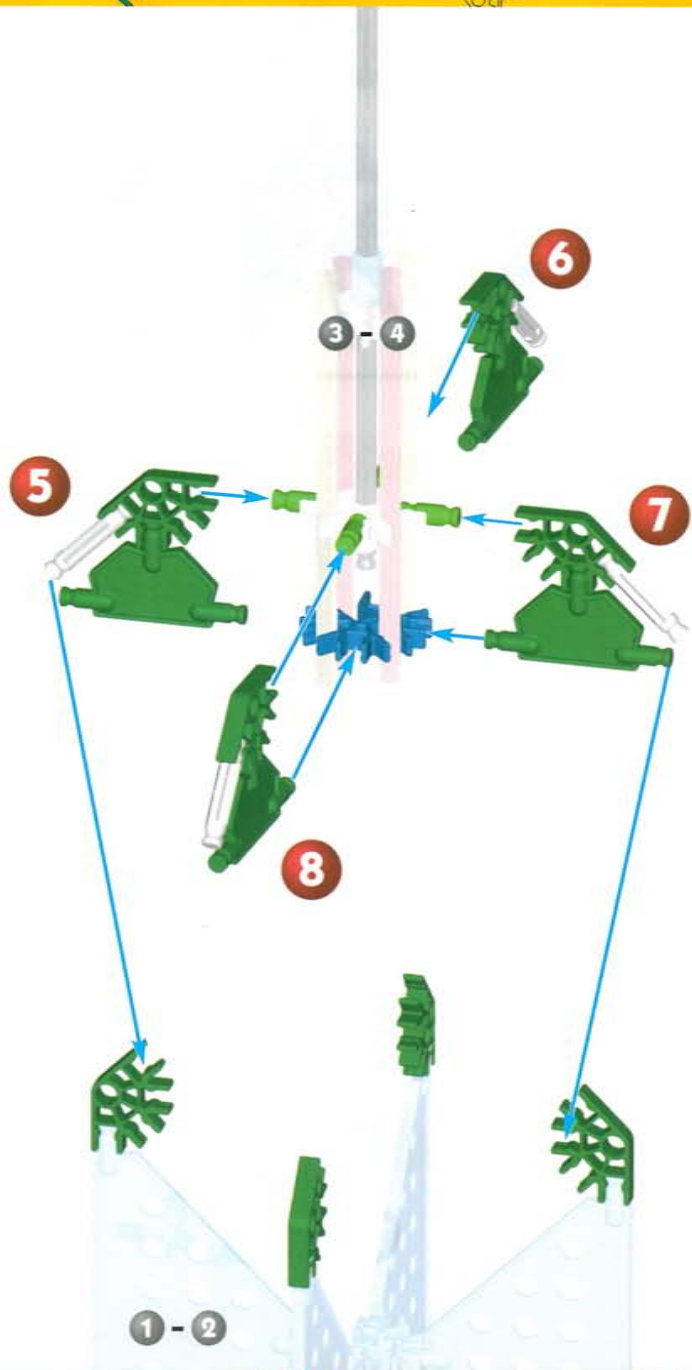

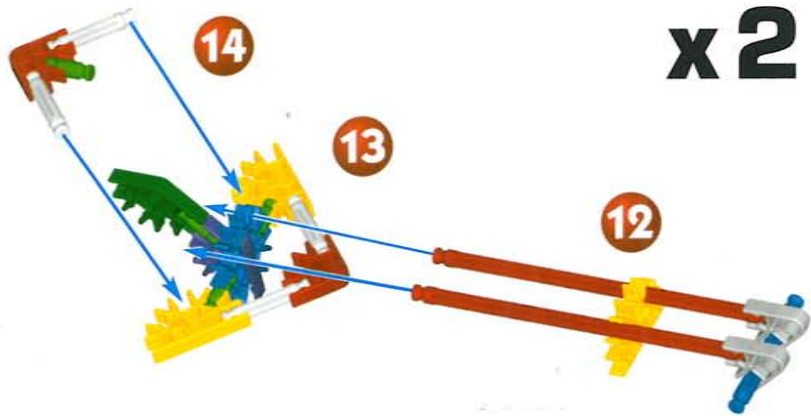

x2

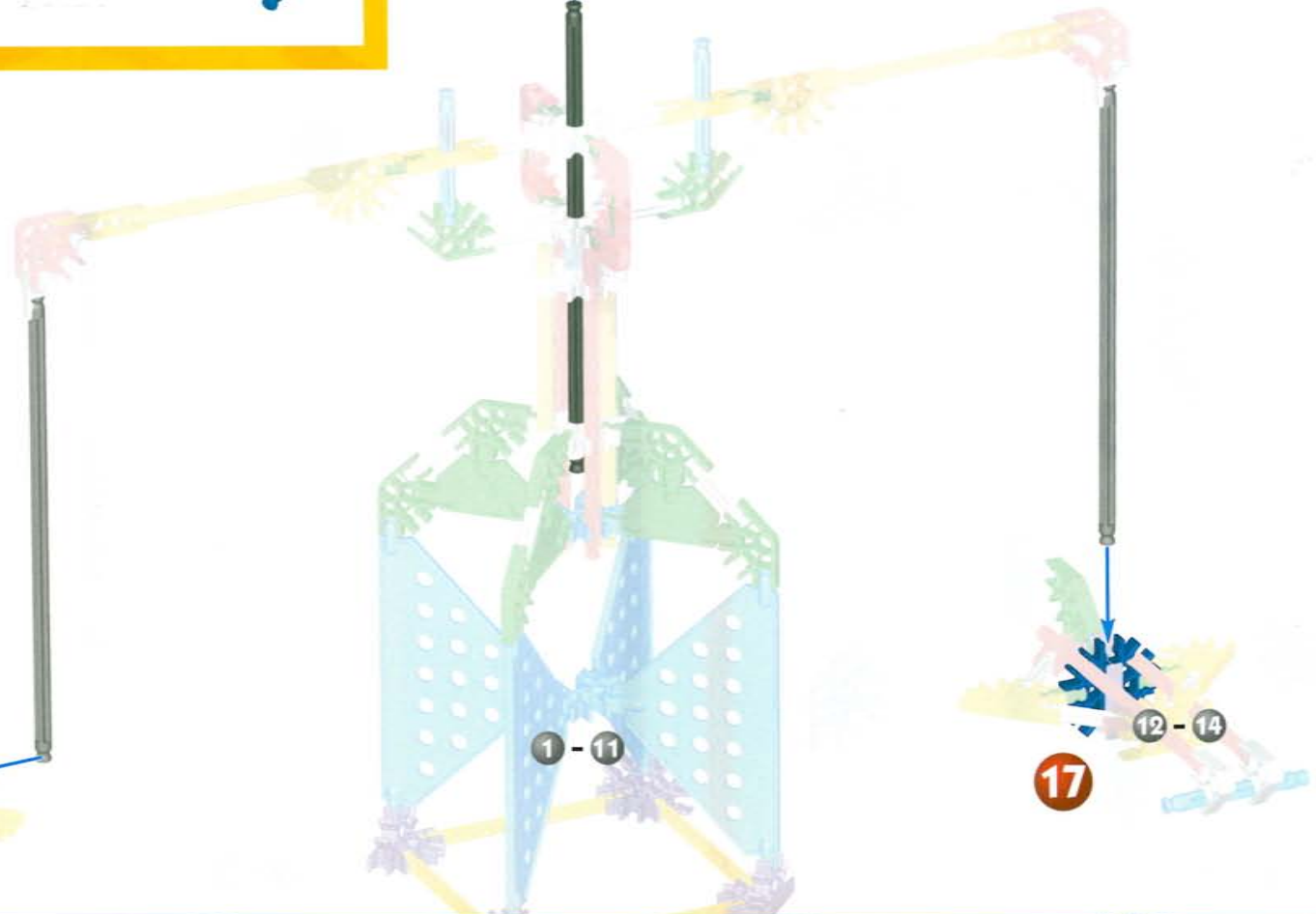
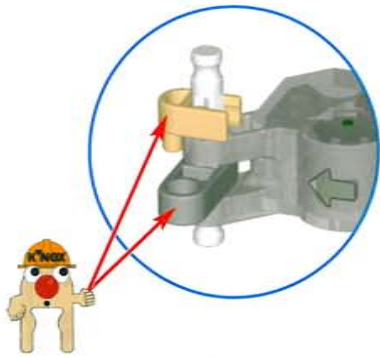
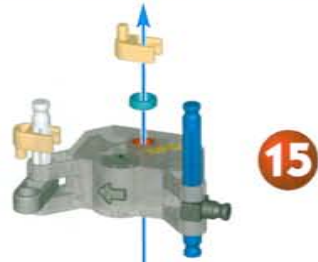

Robot

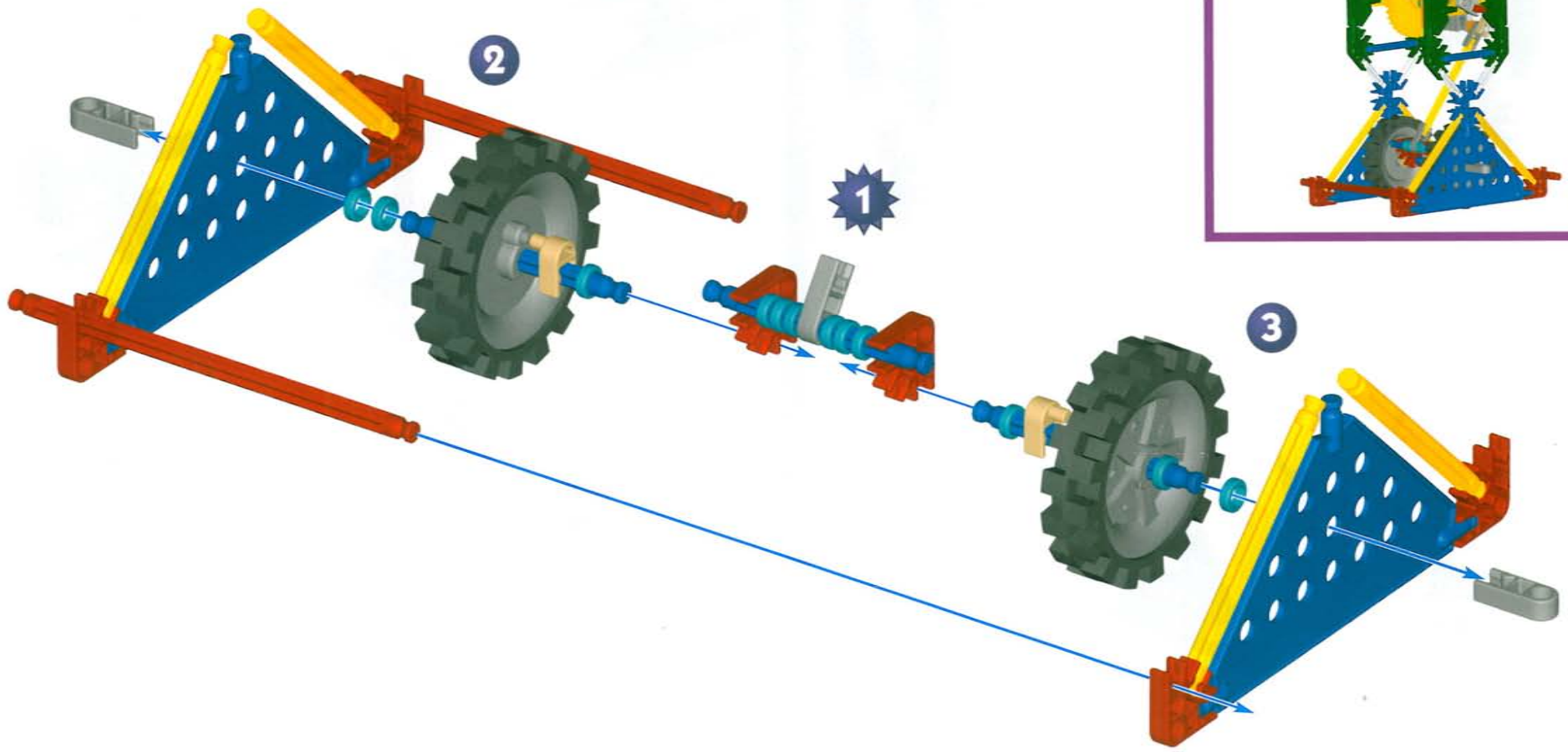
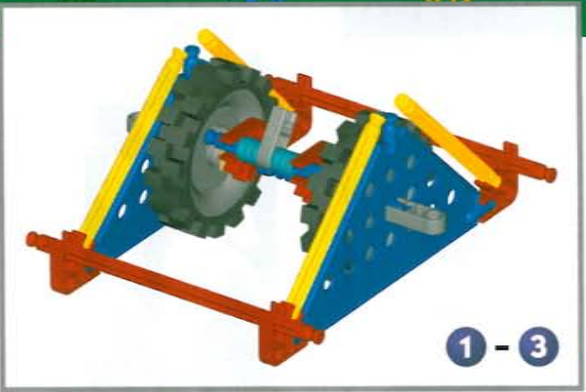

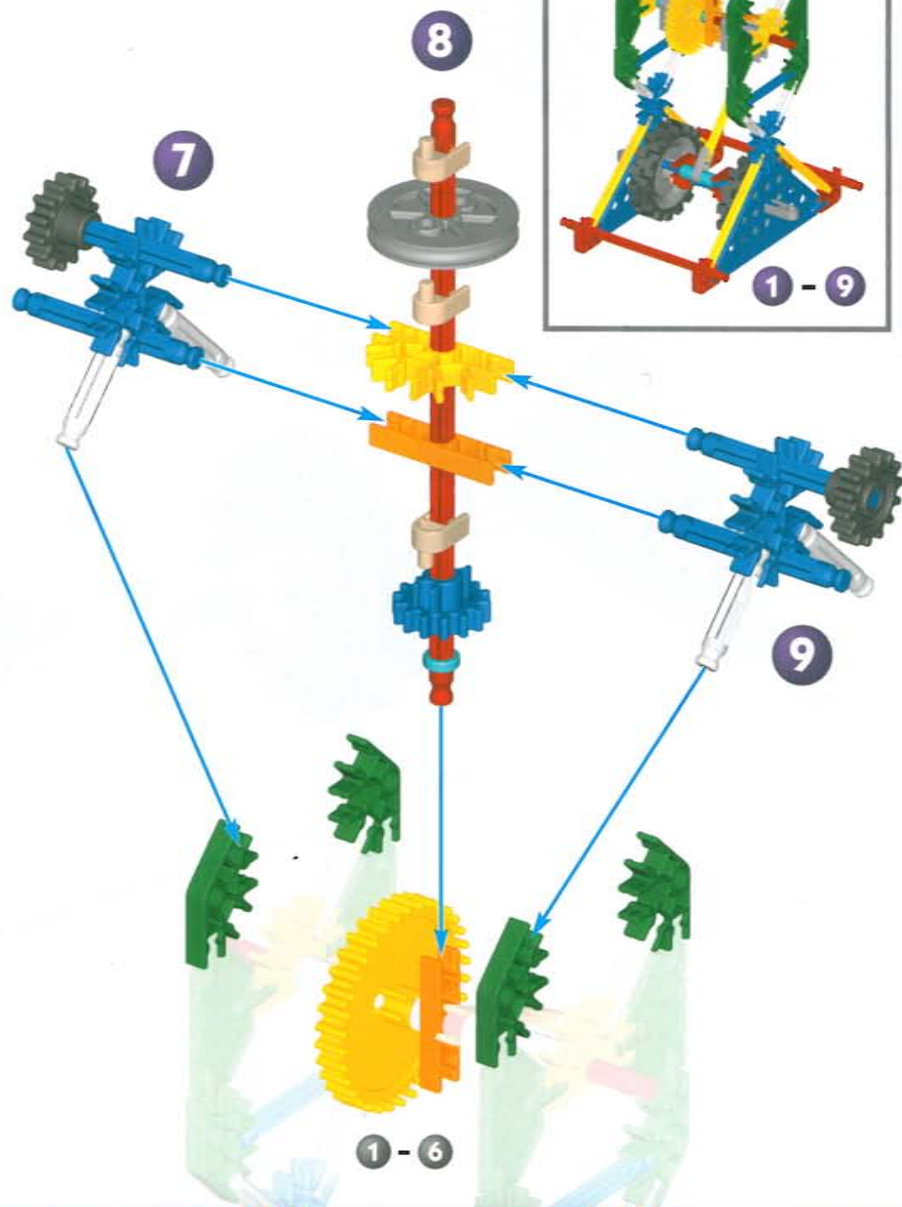
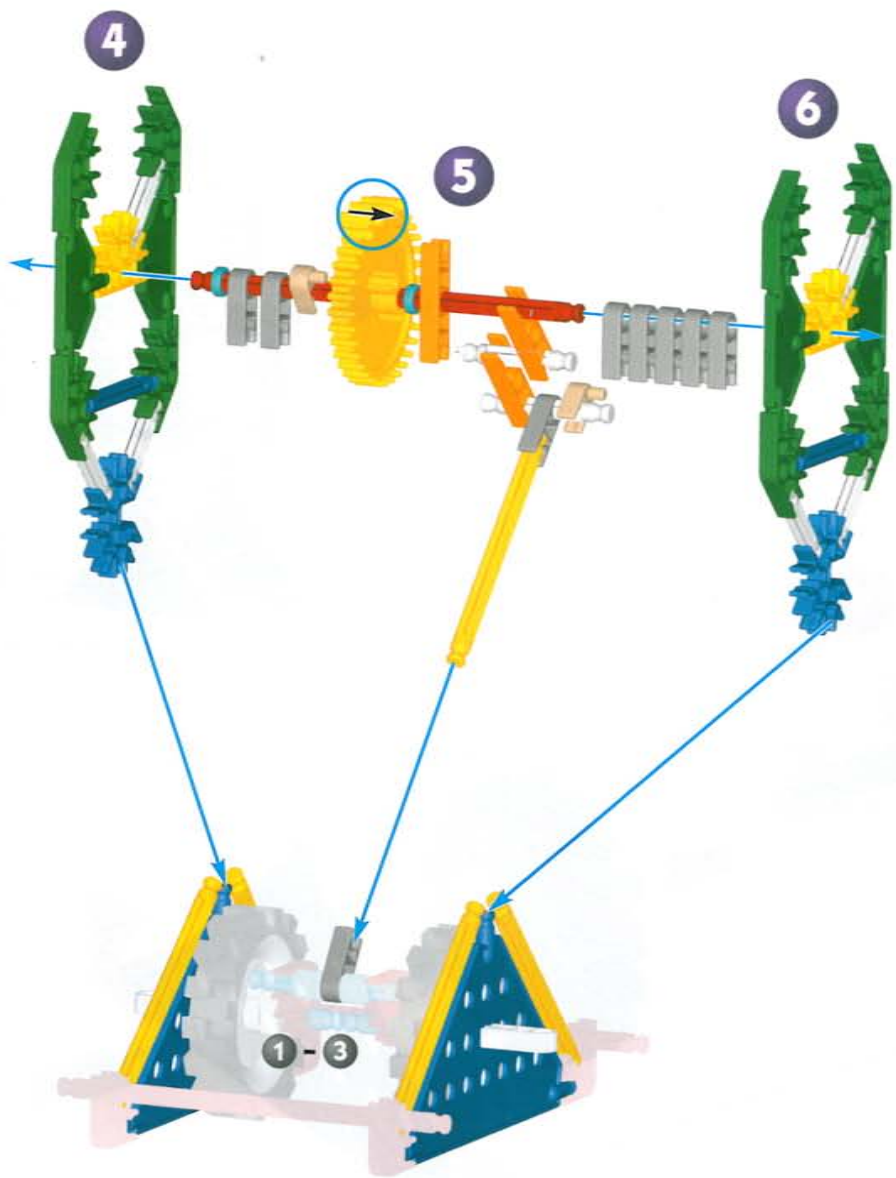

x2

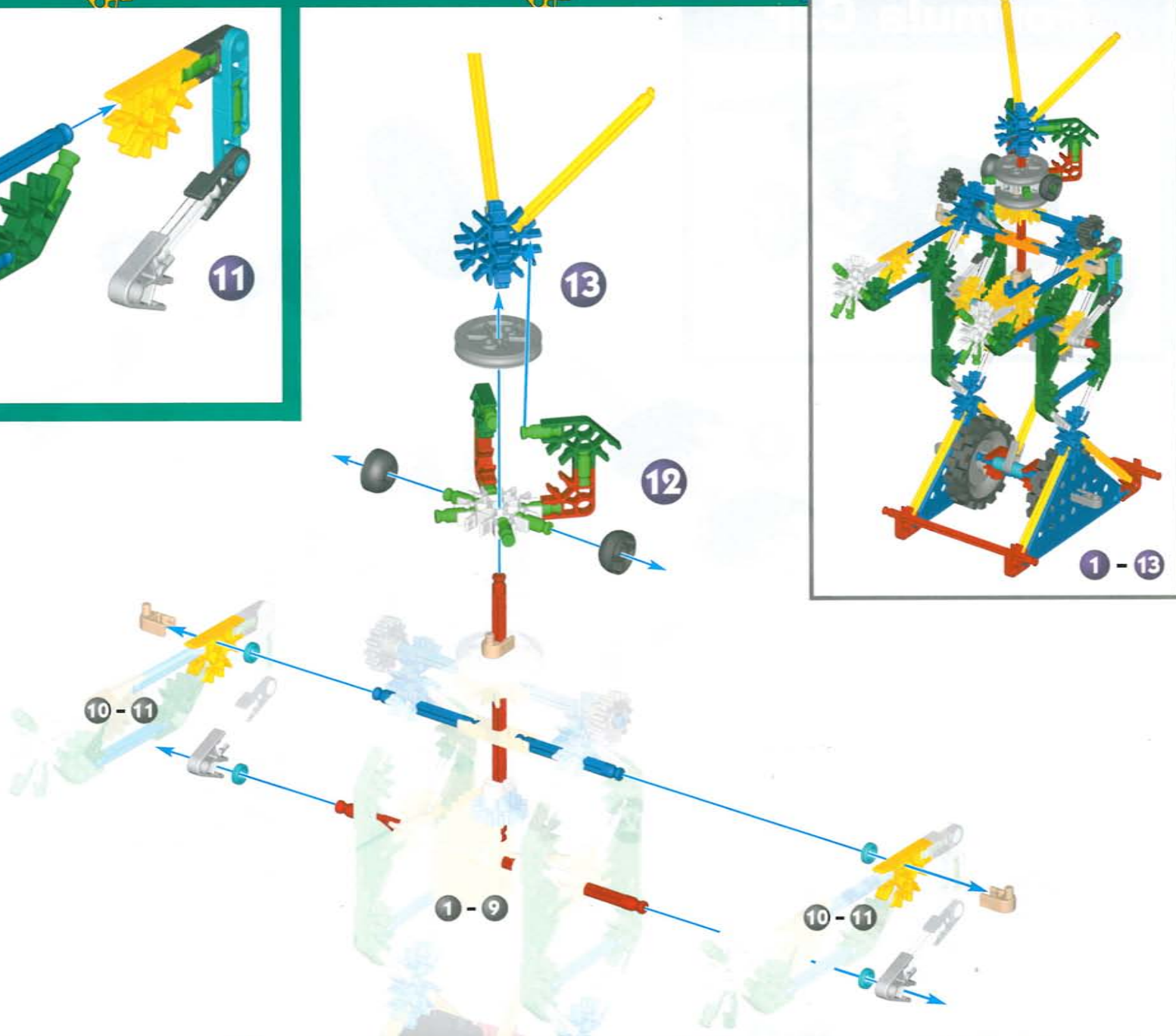
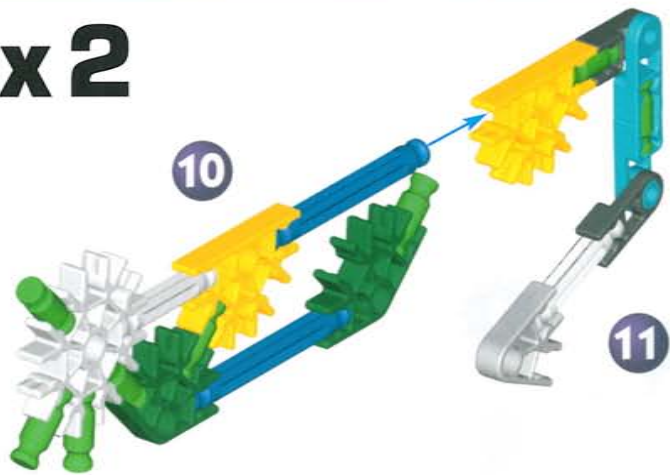

Formula Car

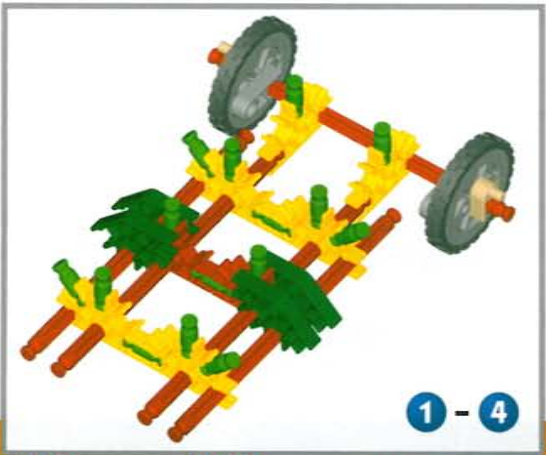
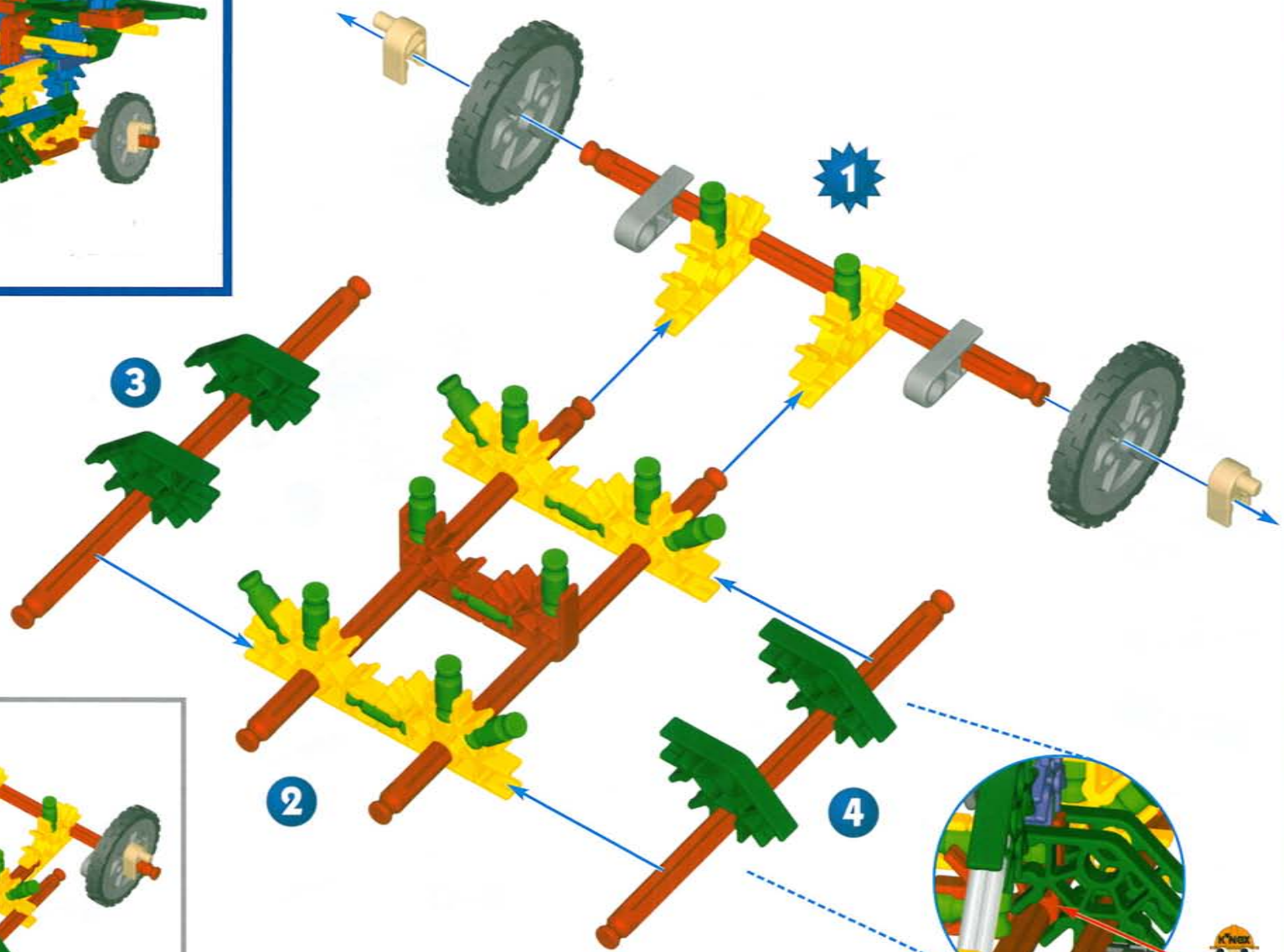
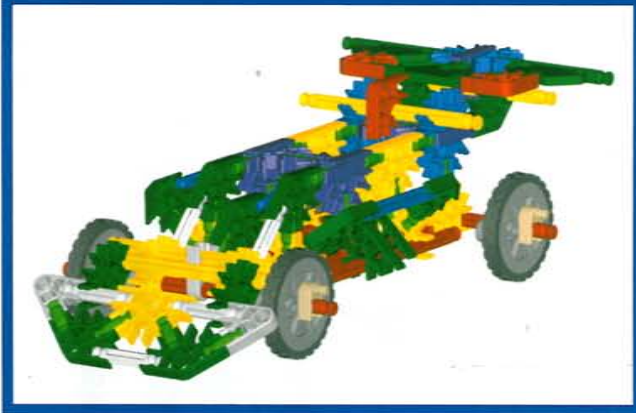

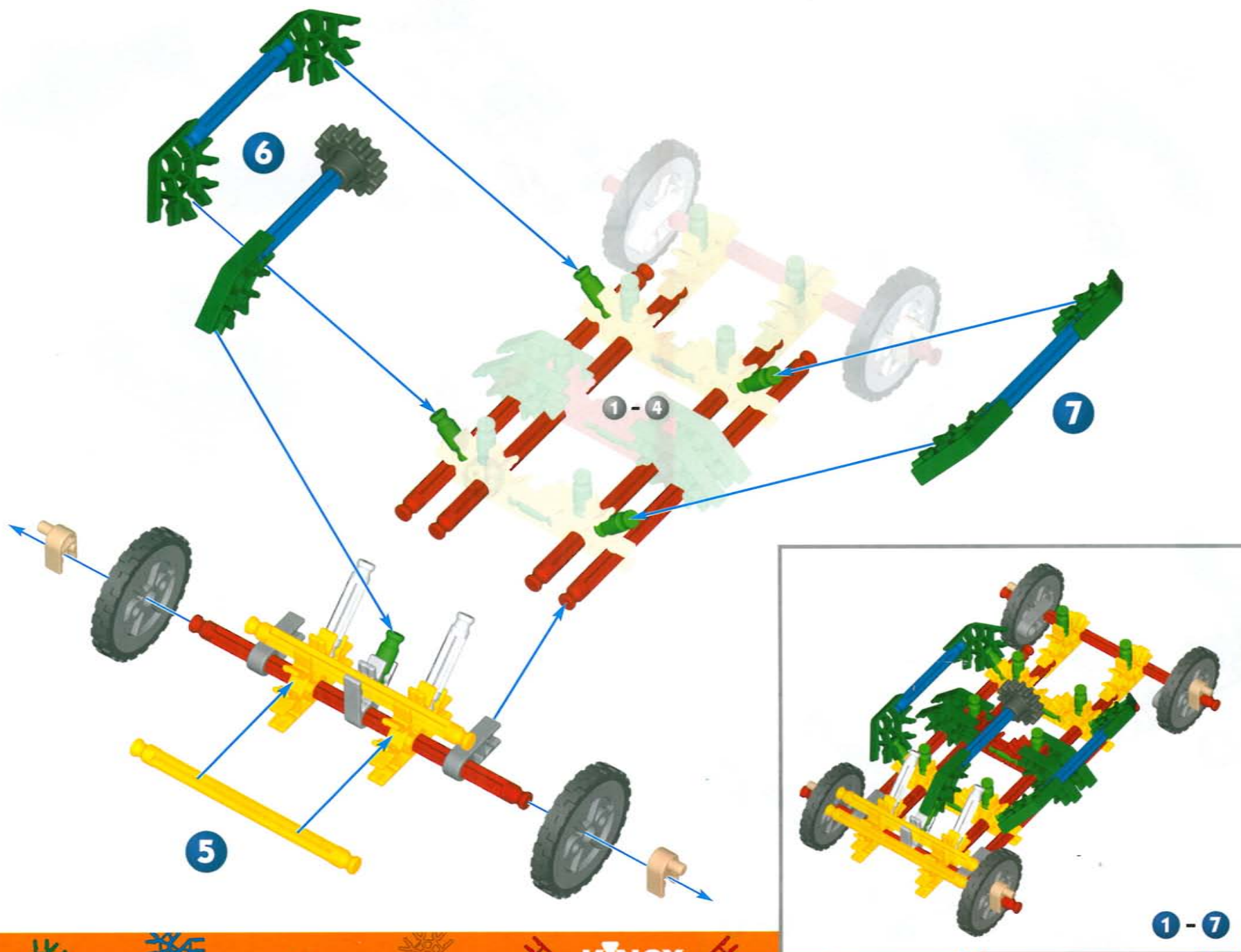

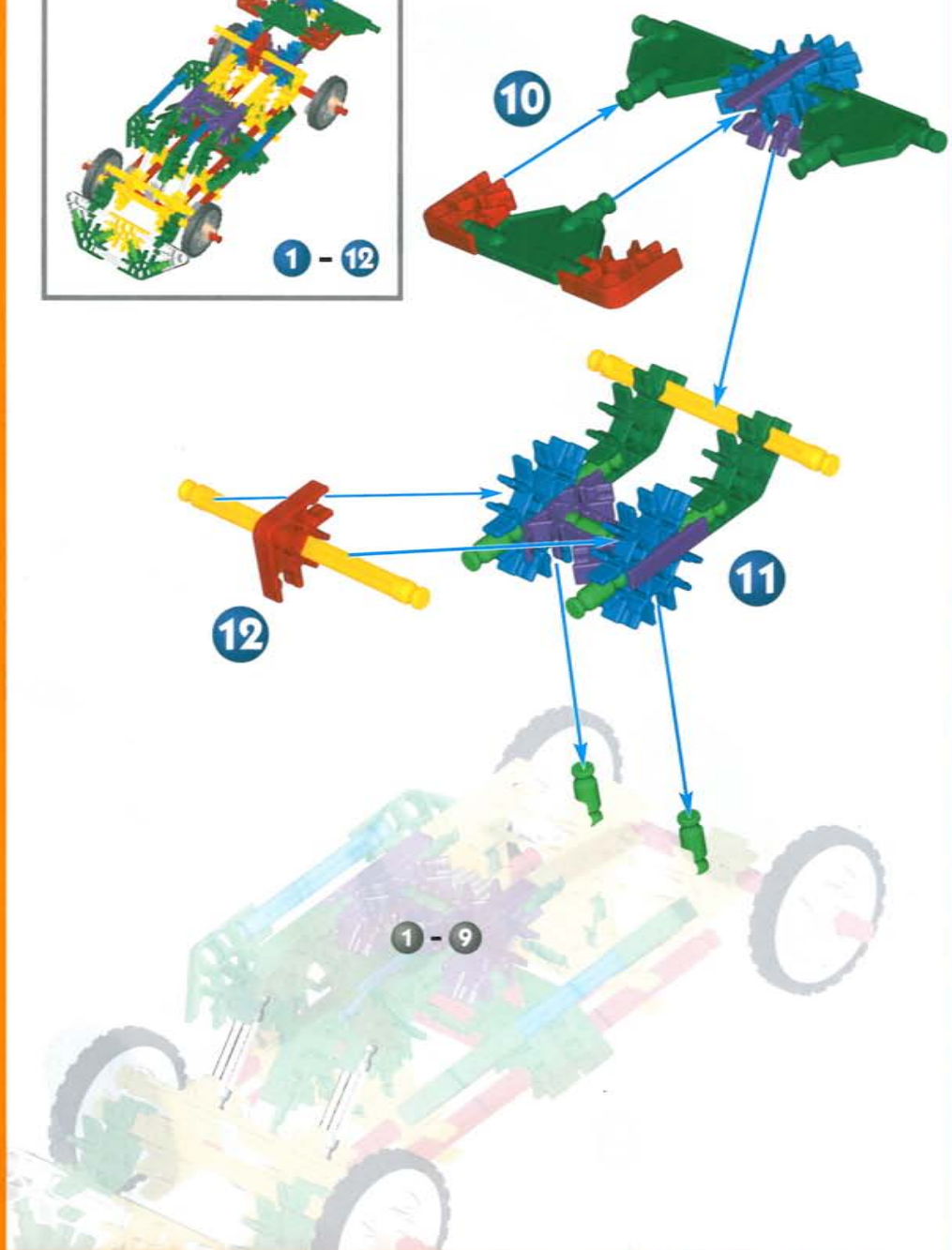
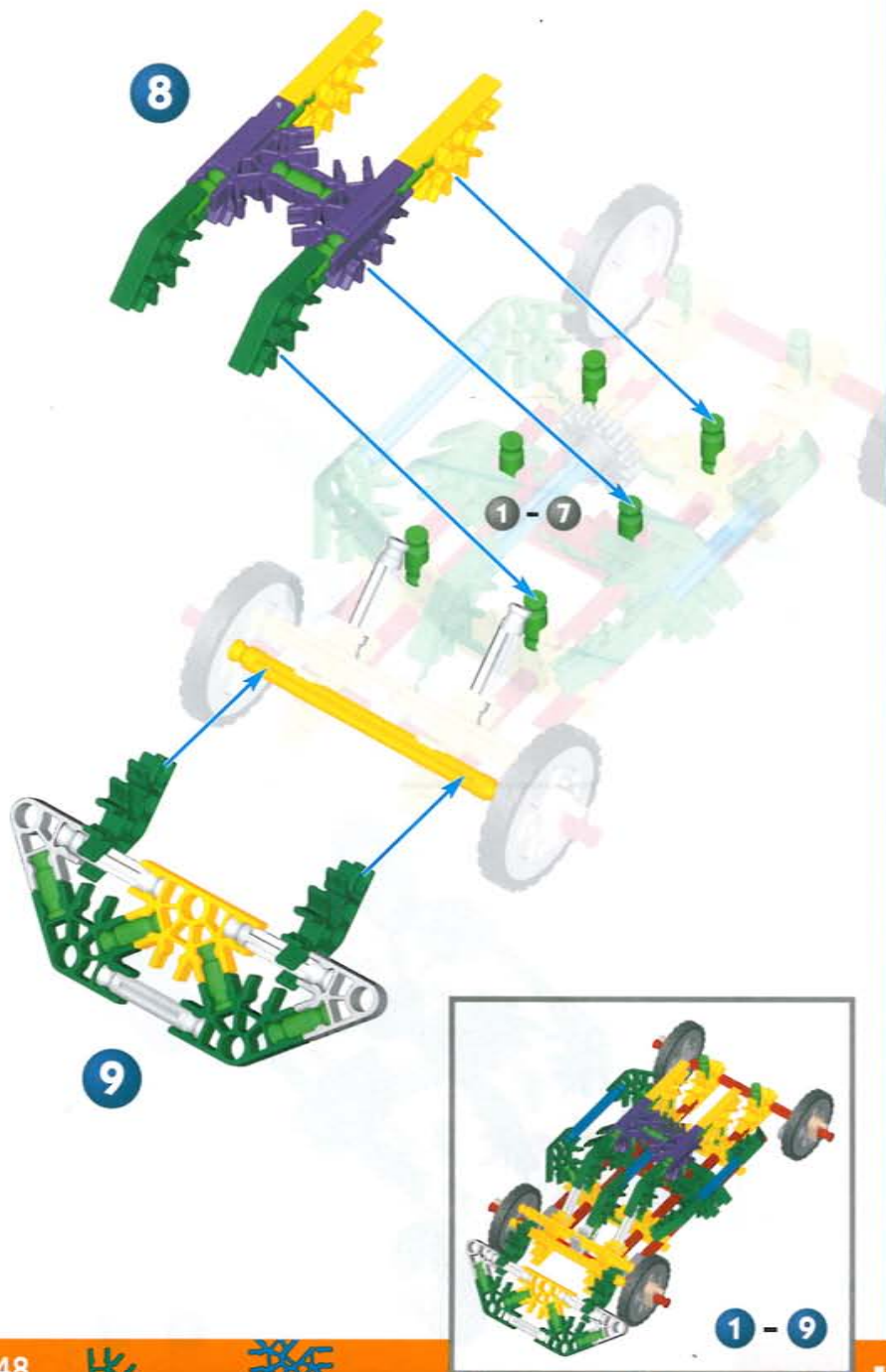

Sport Bike

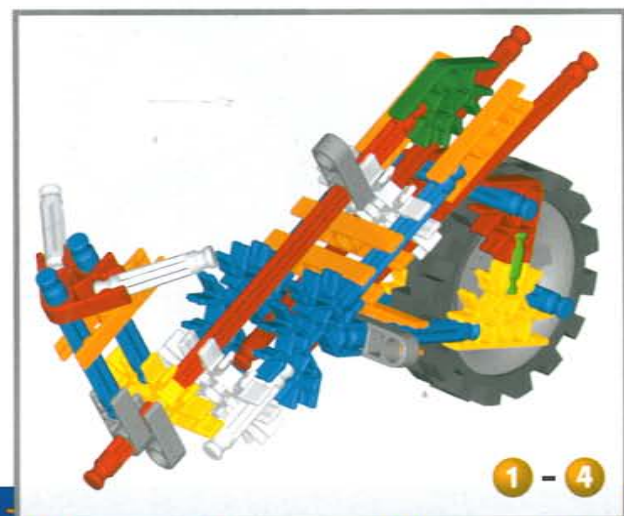
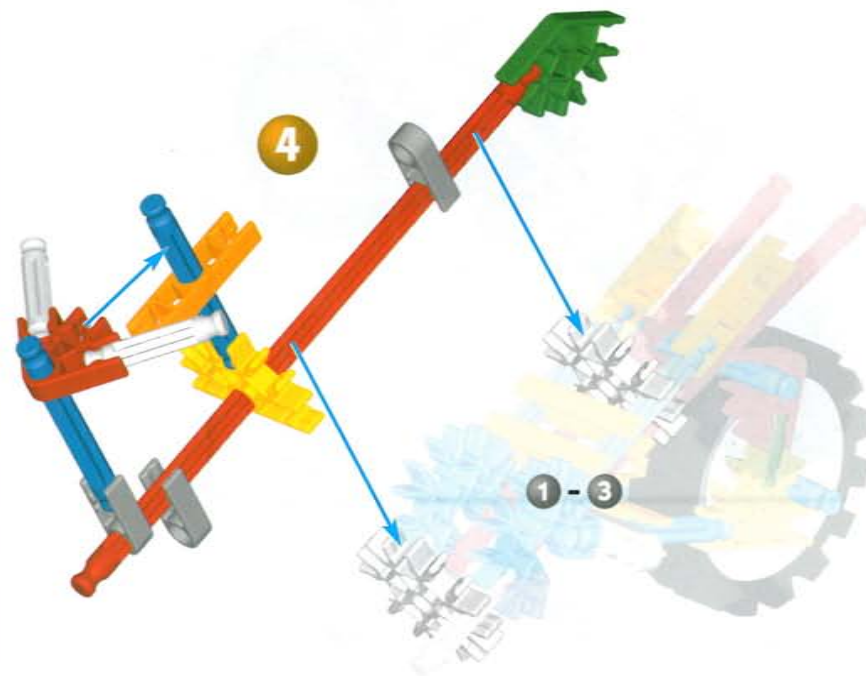
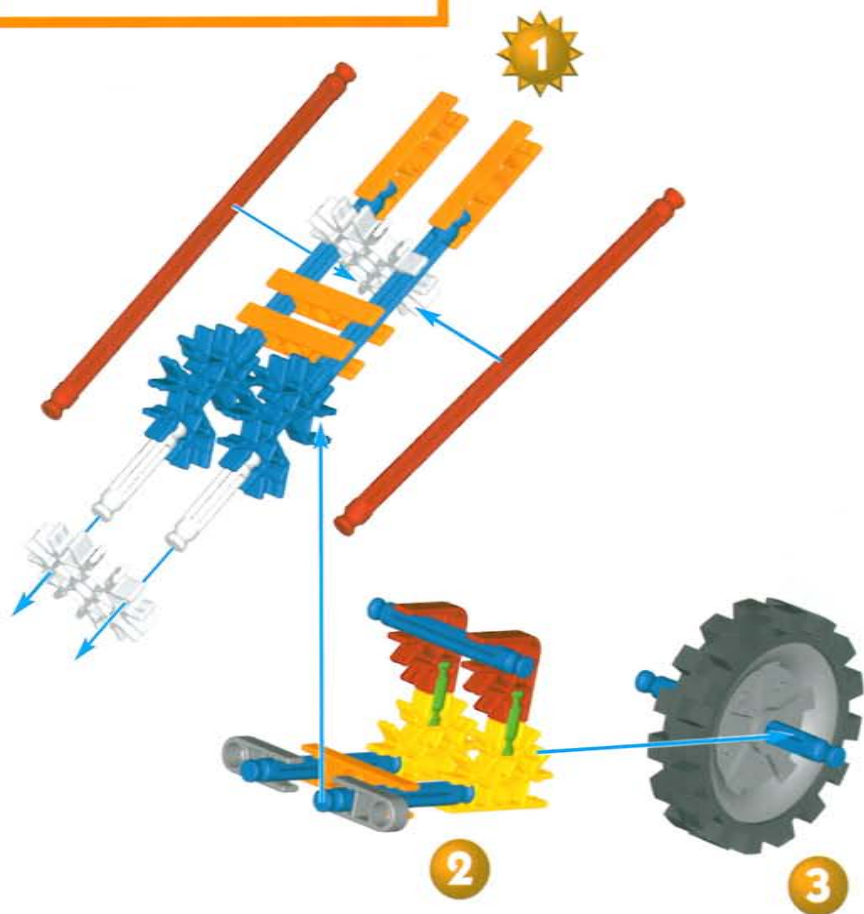

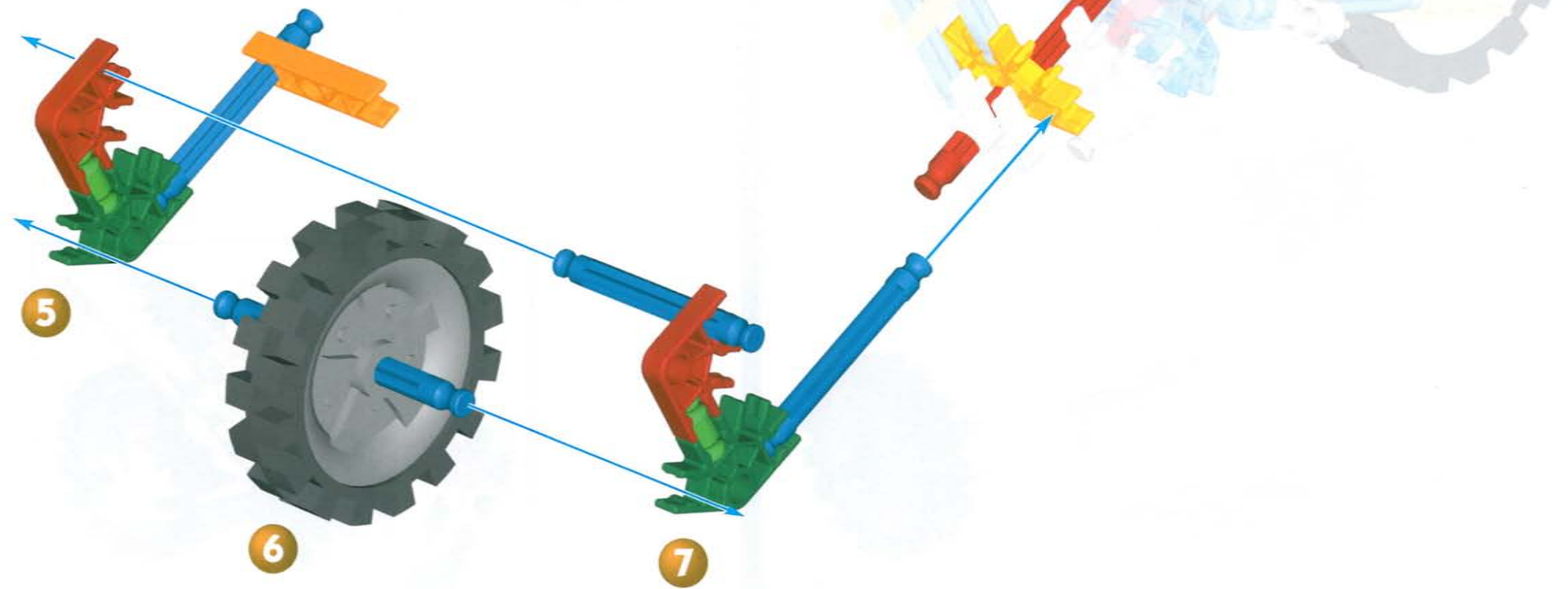
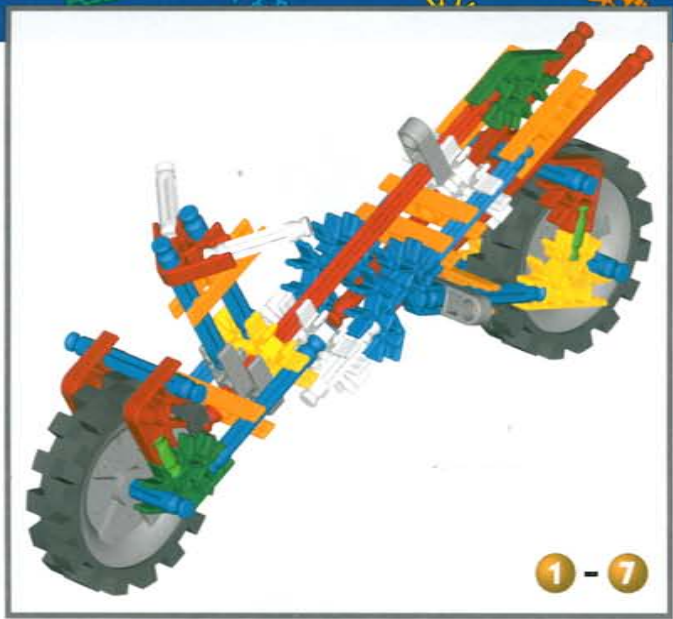

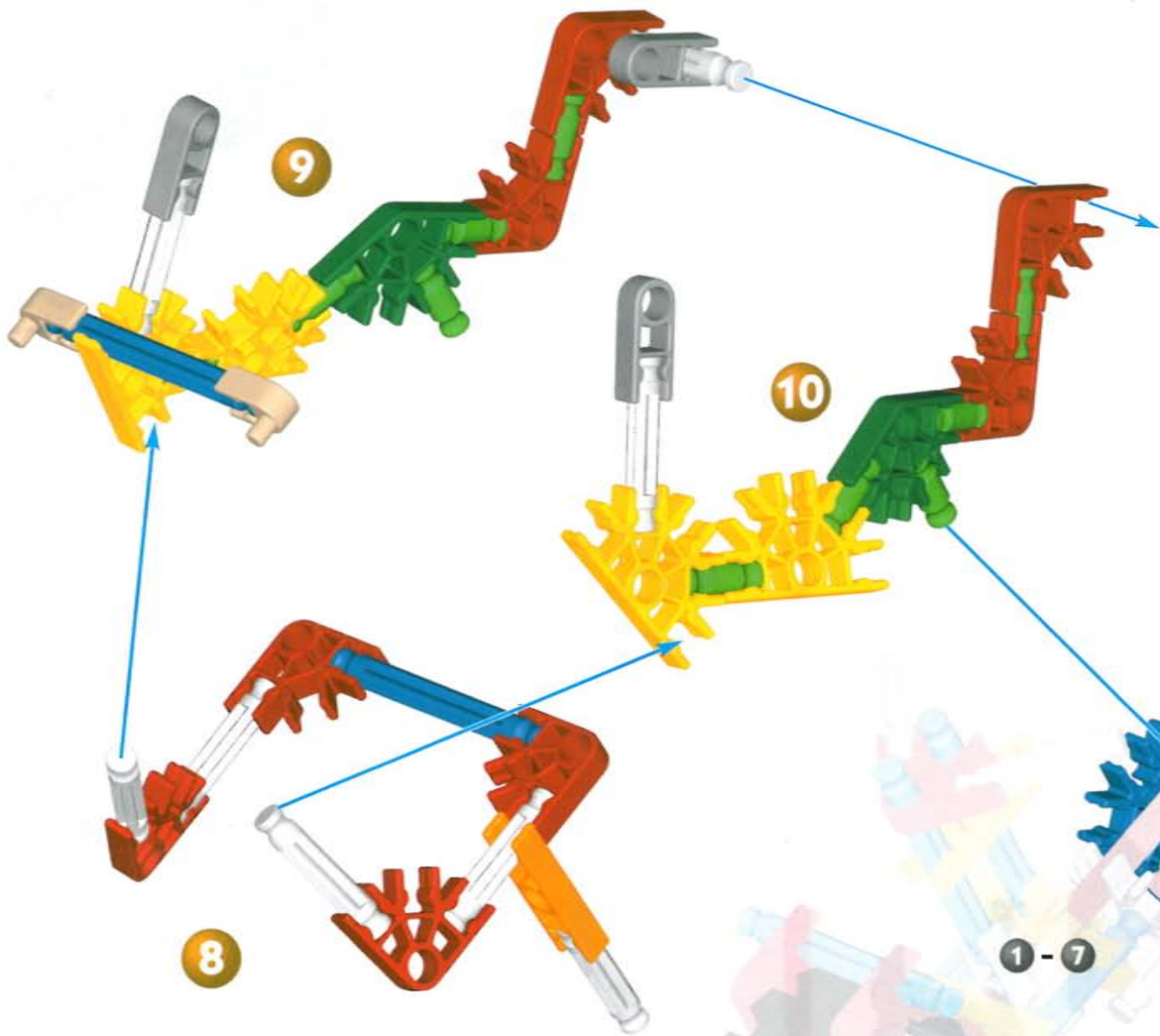

Camera

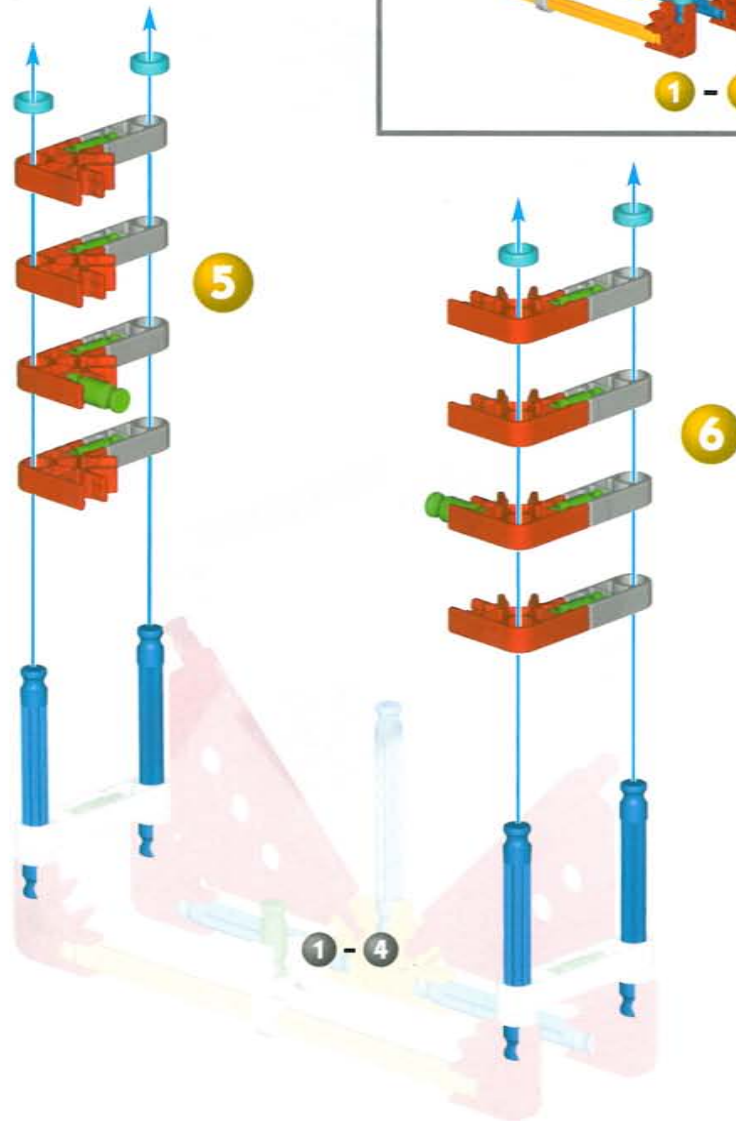
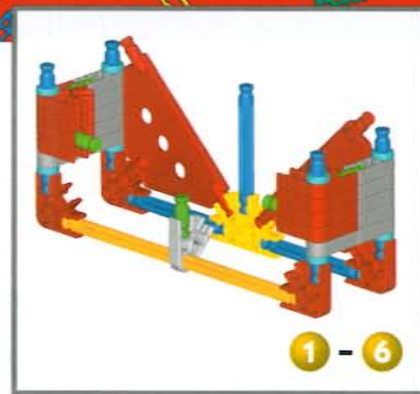
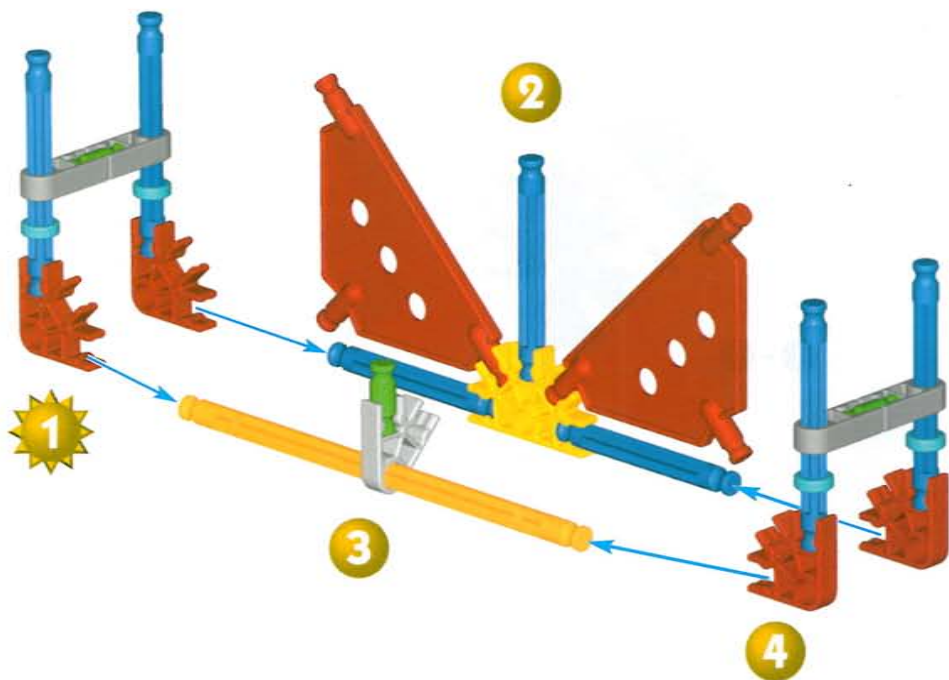
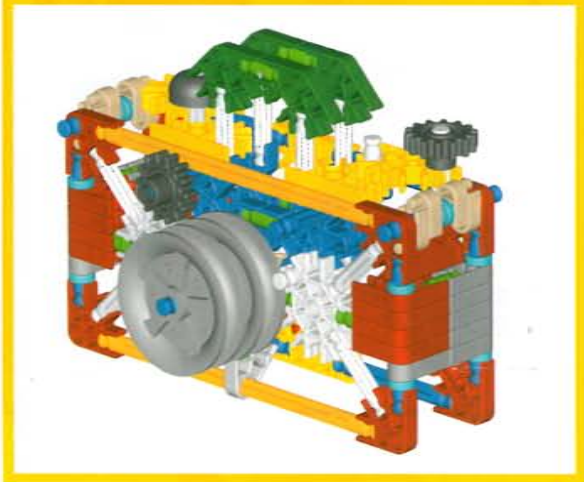

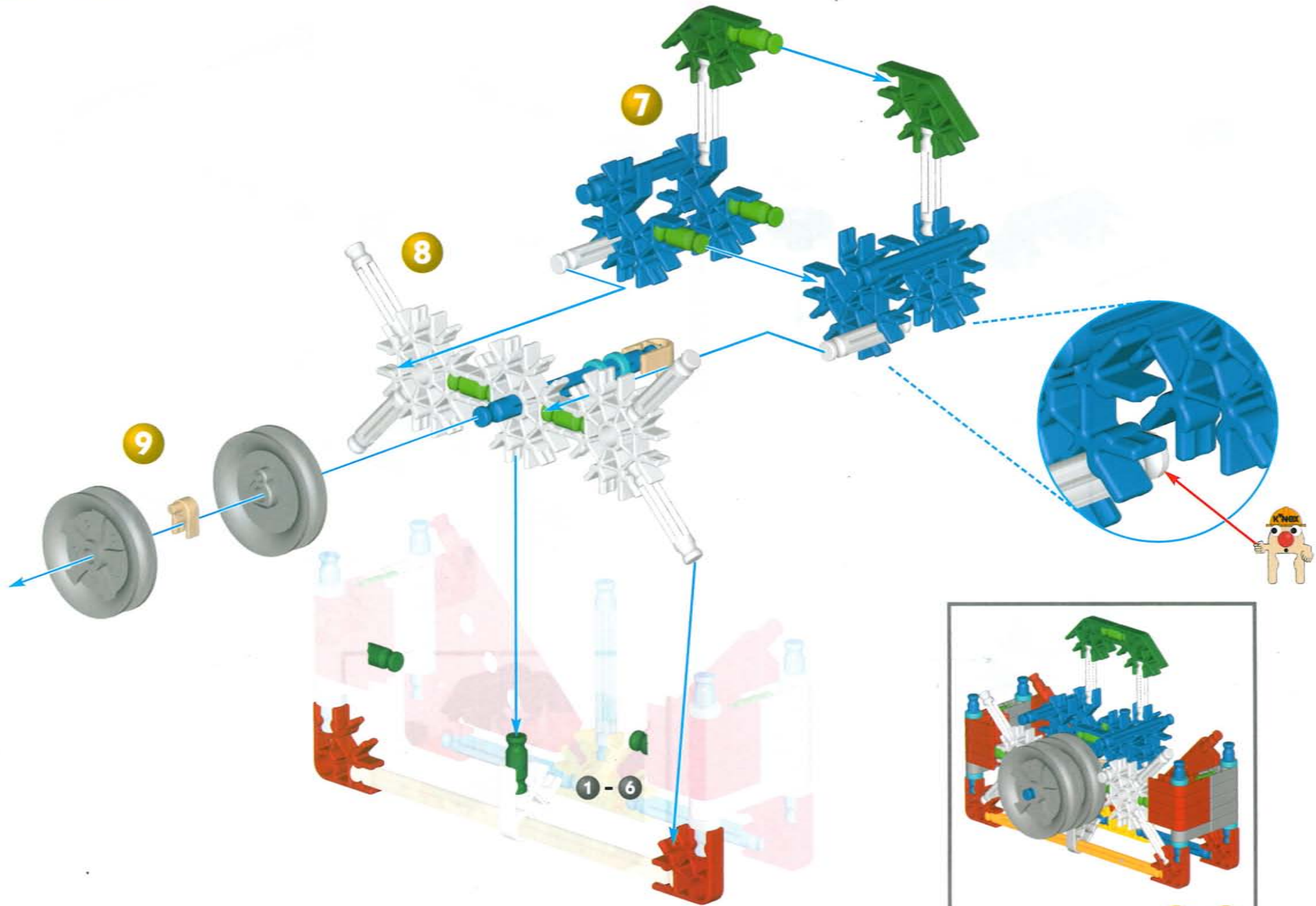

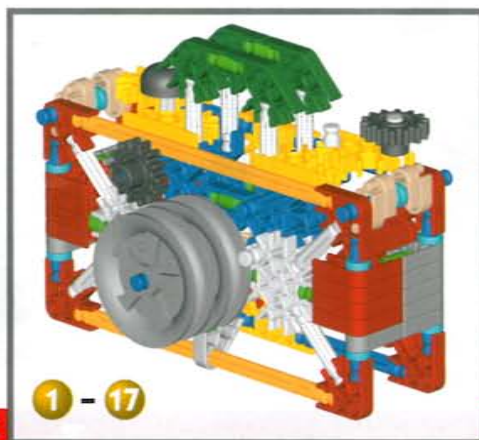
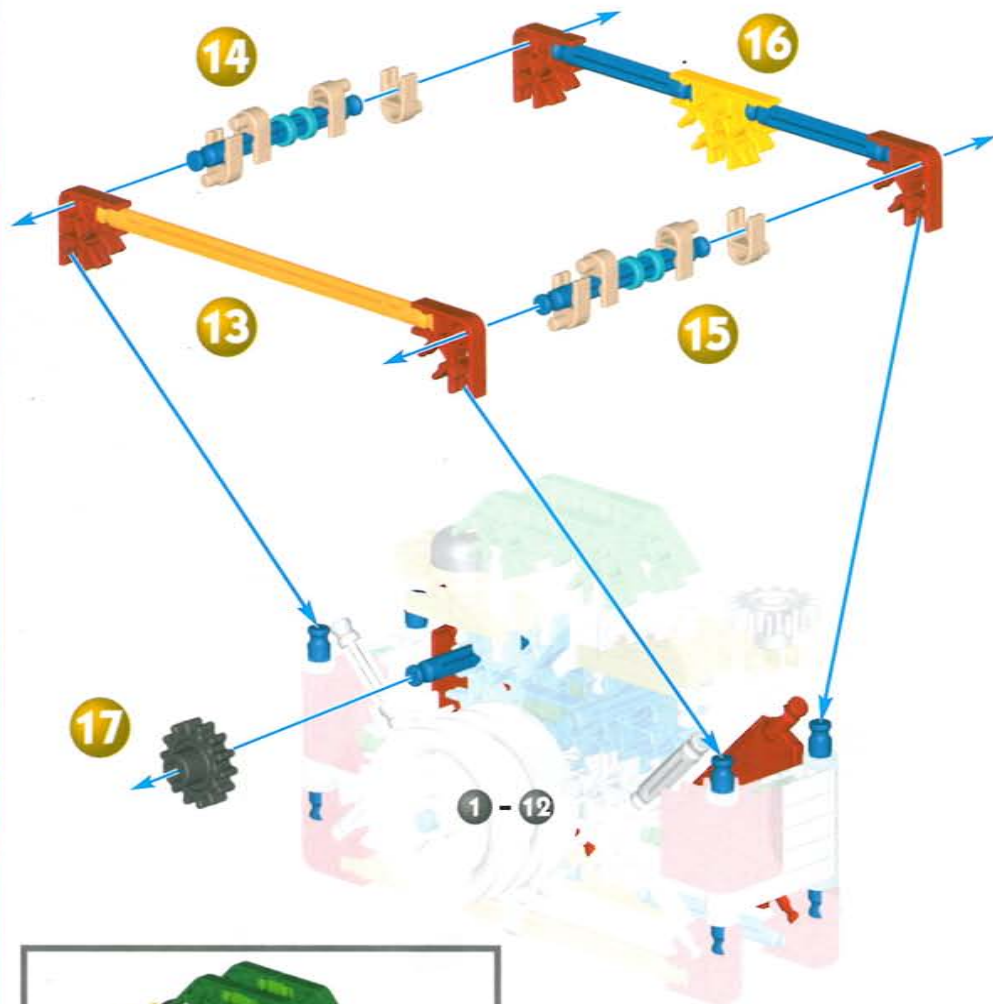
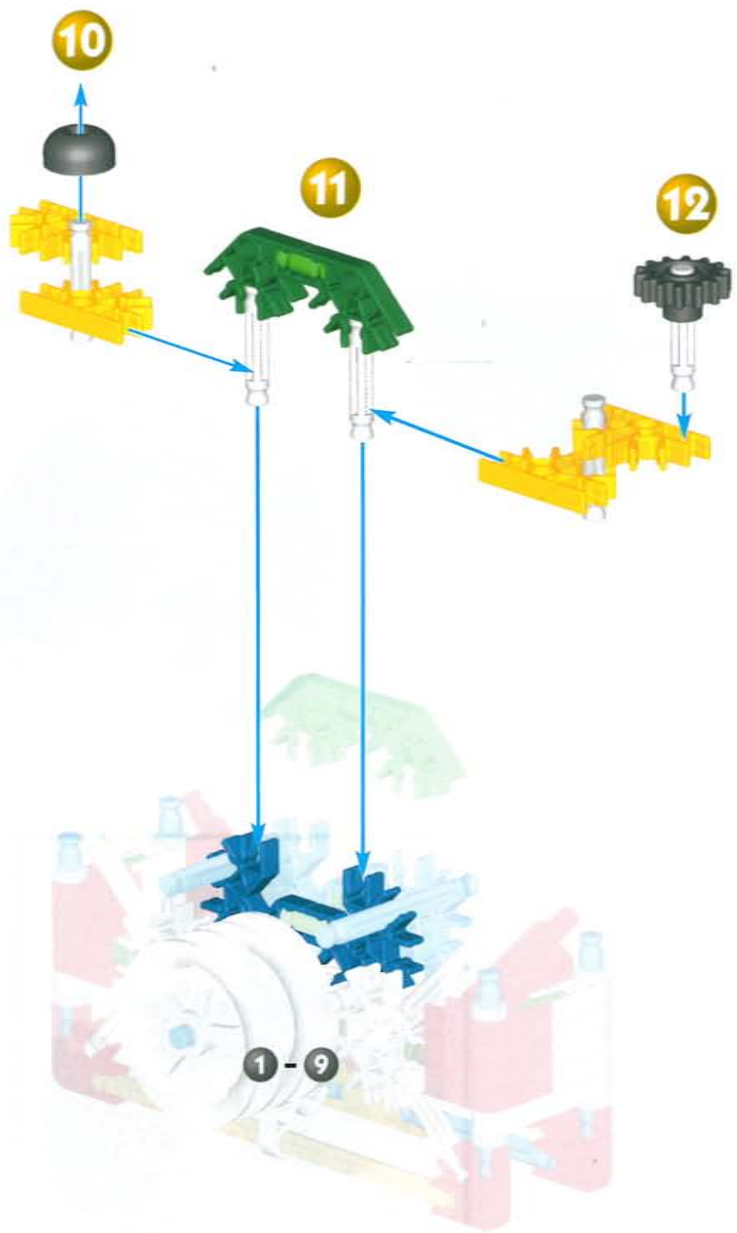

Boom Ride

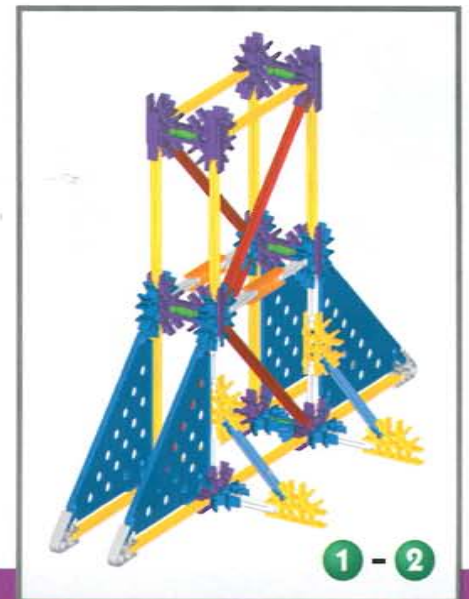
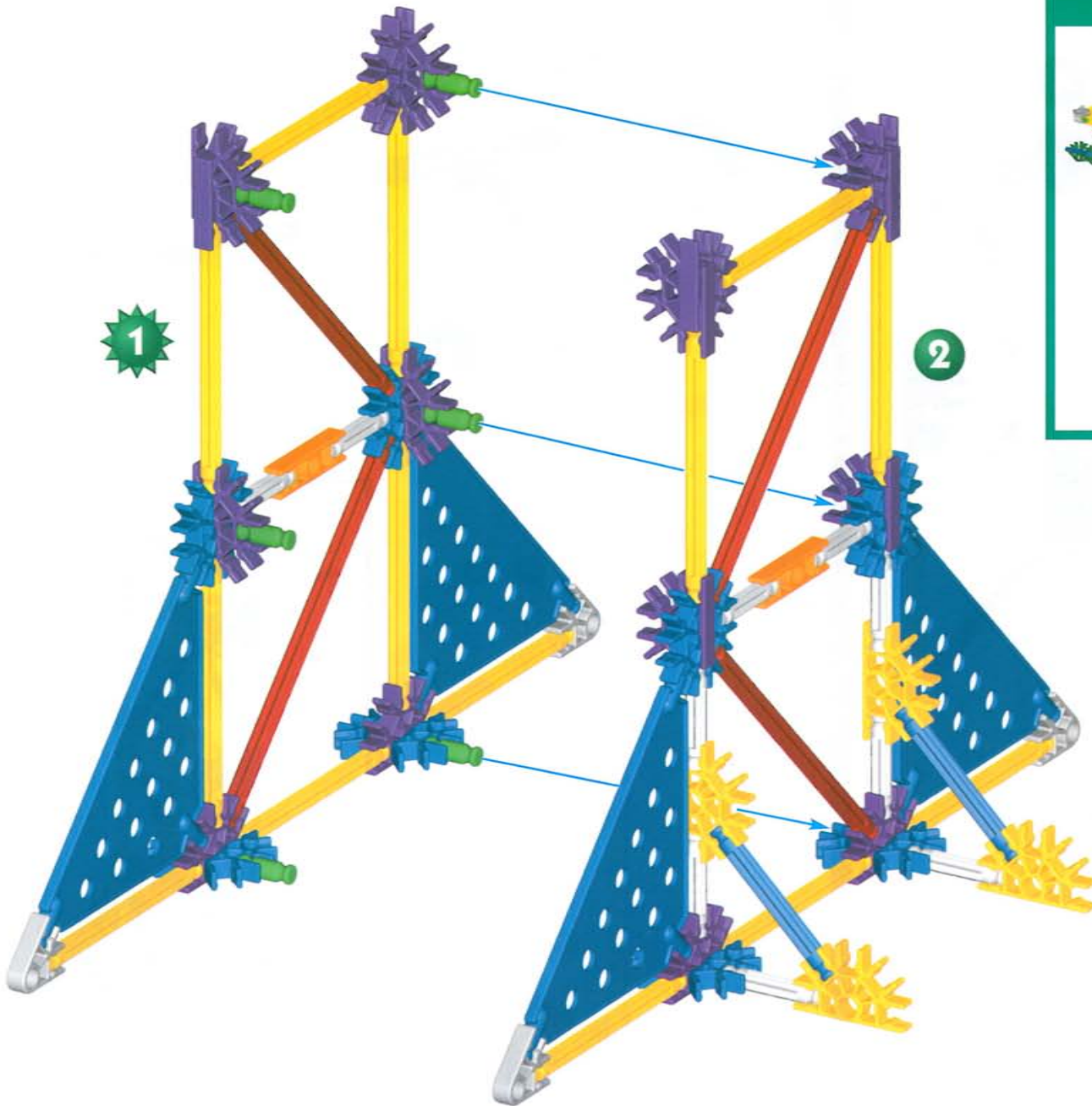

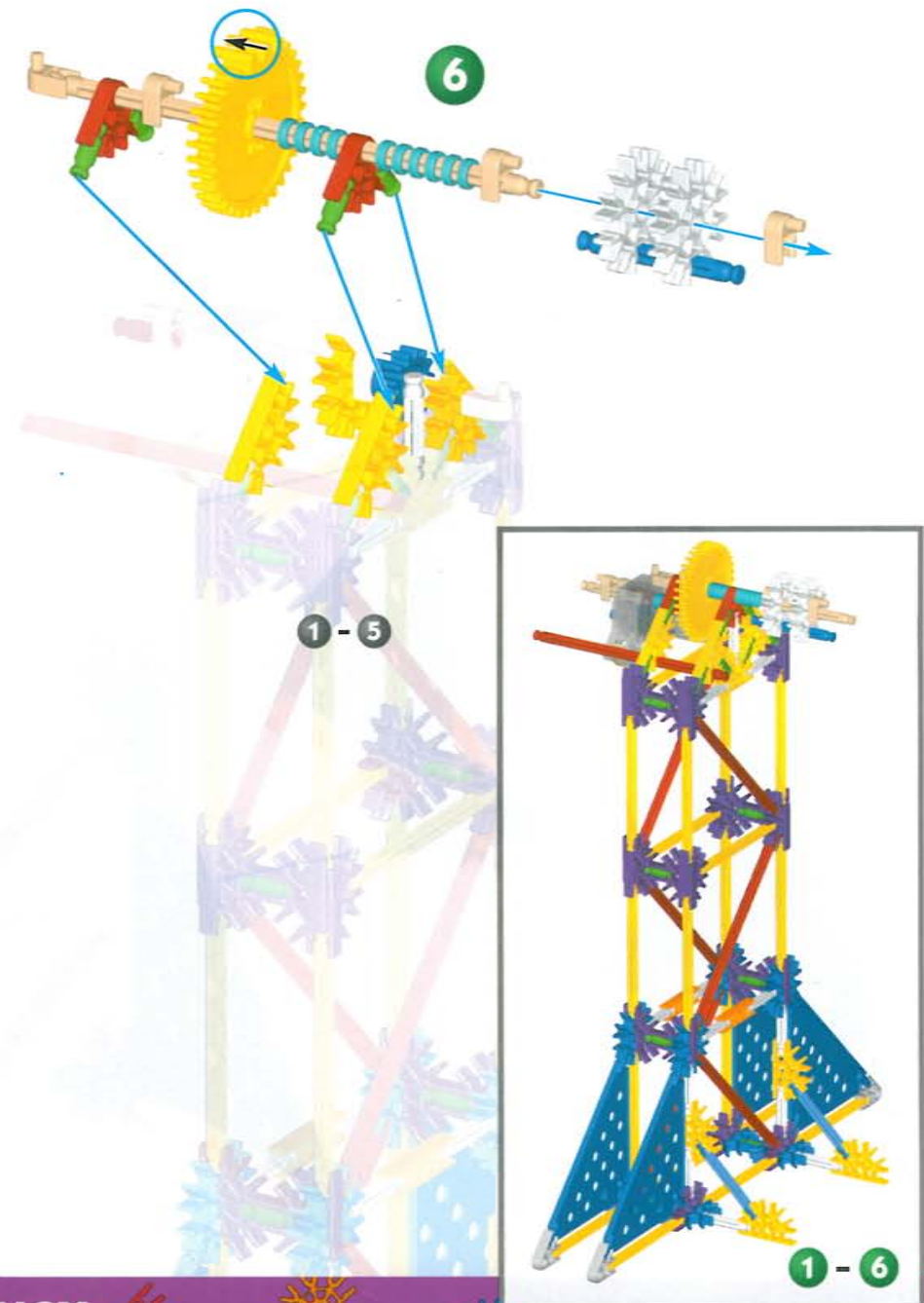
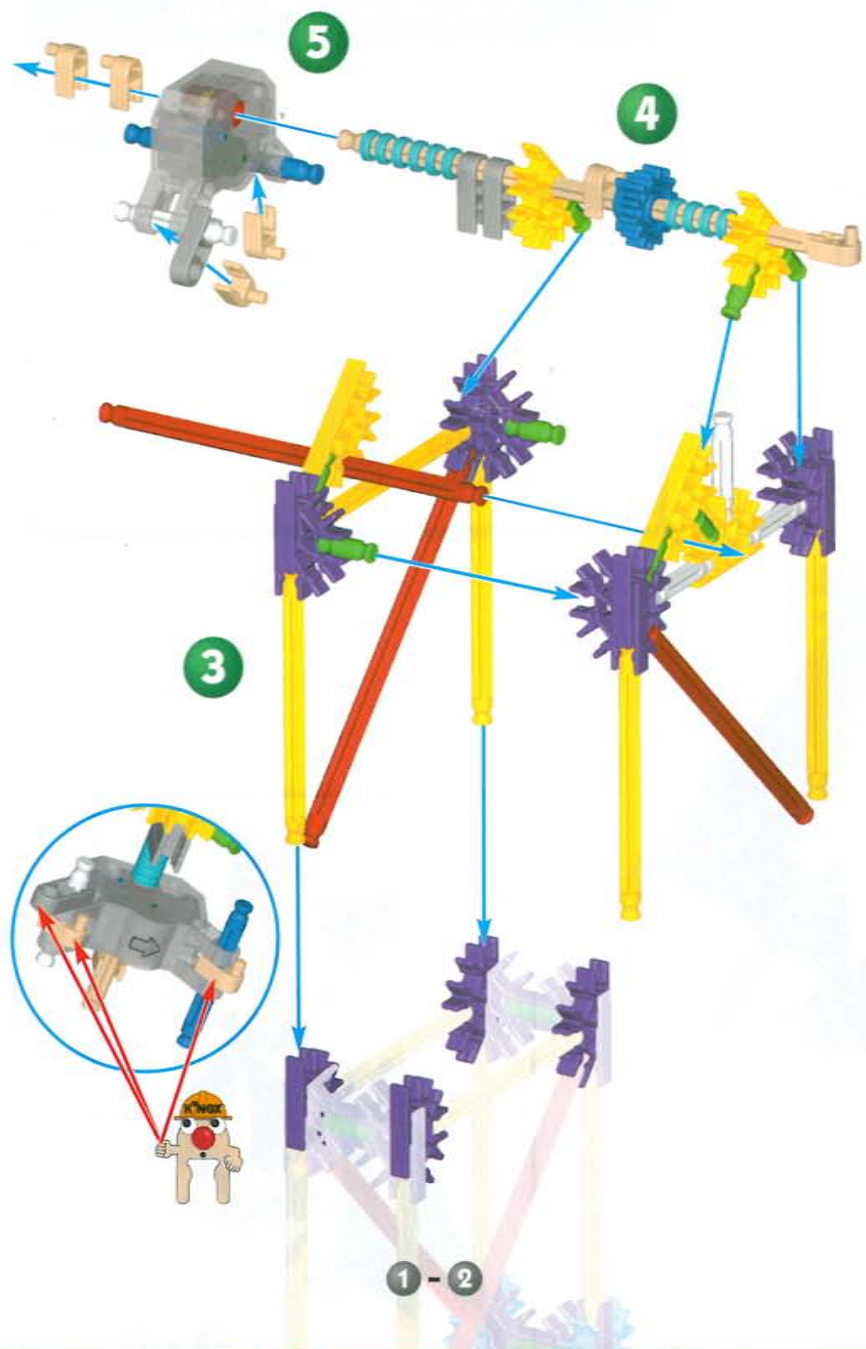

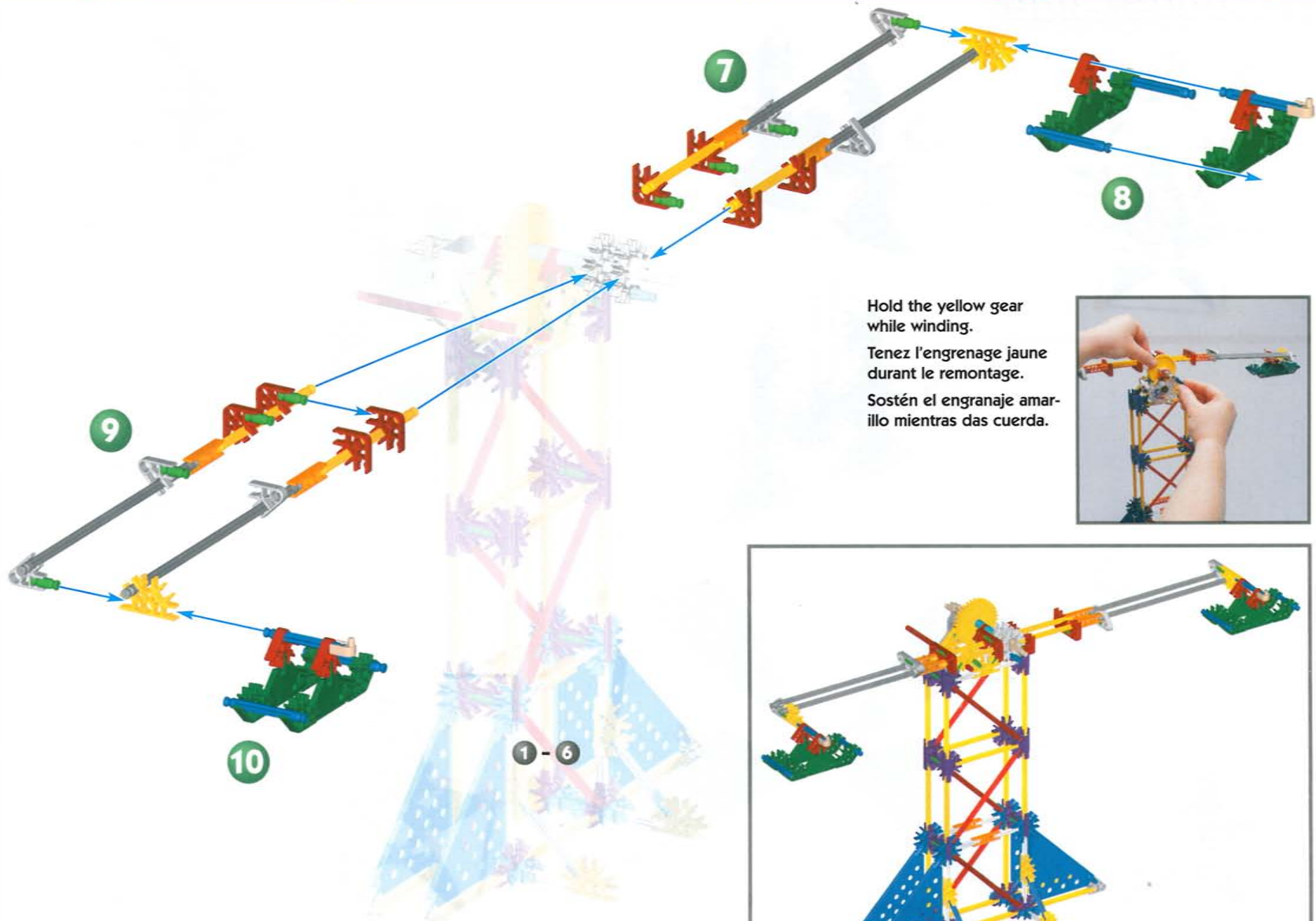

Hold the yellow gear while winding.

Tenez l'engrenage jaune durant le remontage.

Sostén el engranaje amarillo mientras das cuerda.

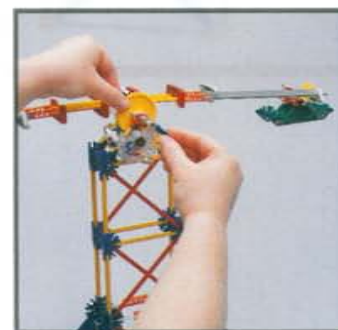

Octopus Ride

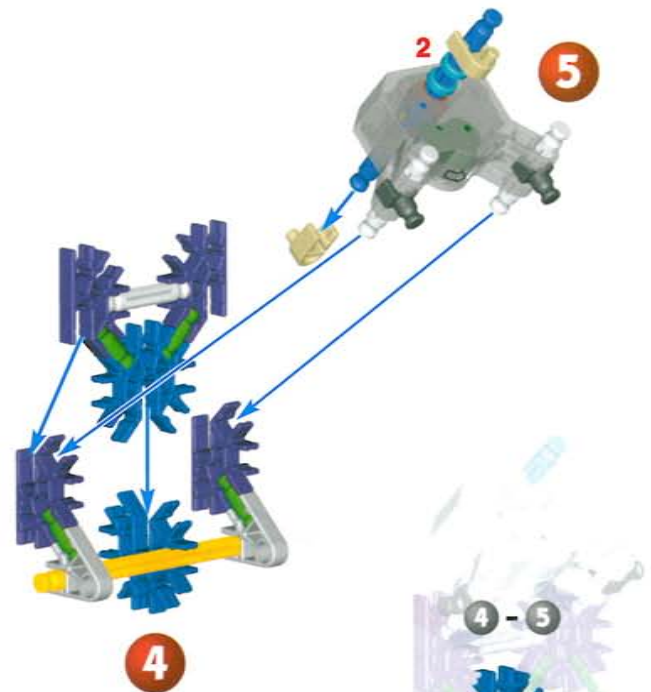
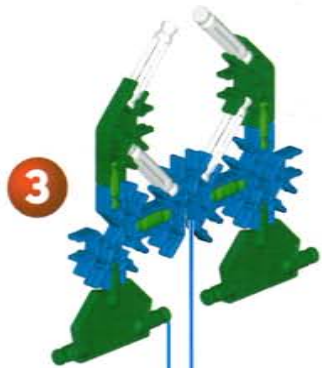
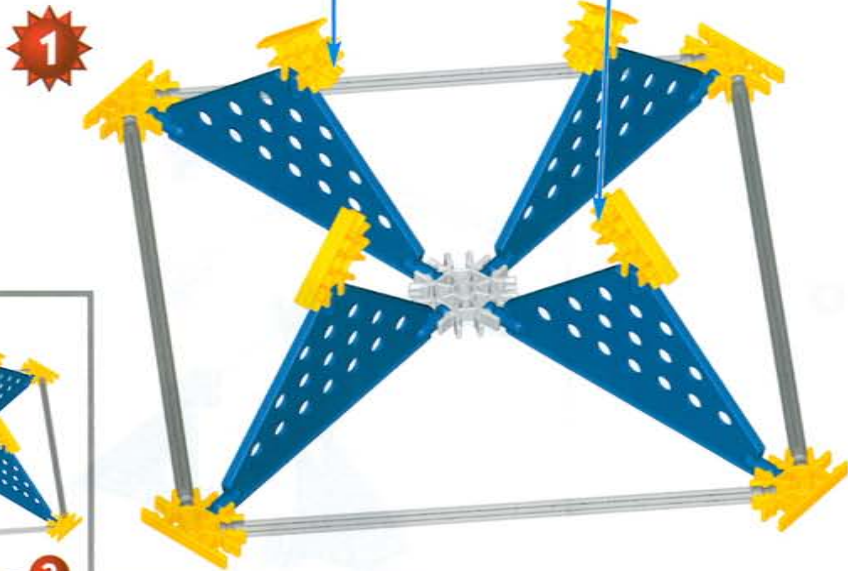
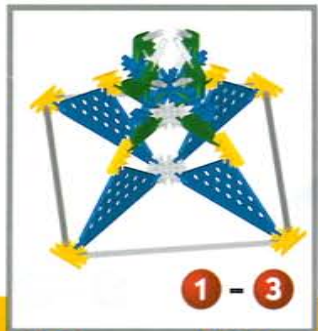
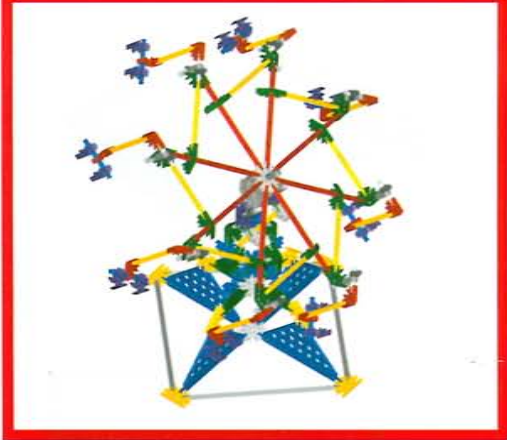

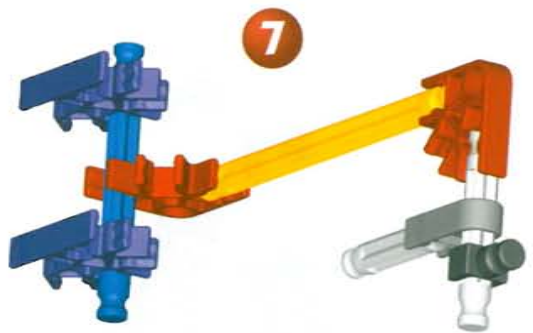

x 8

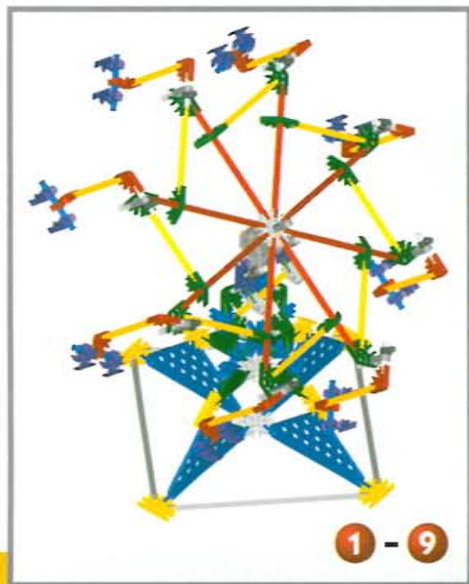
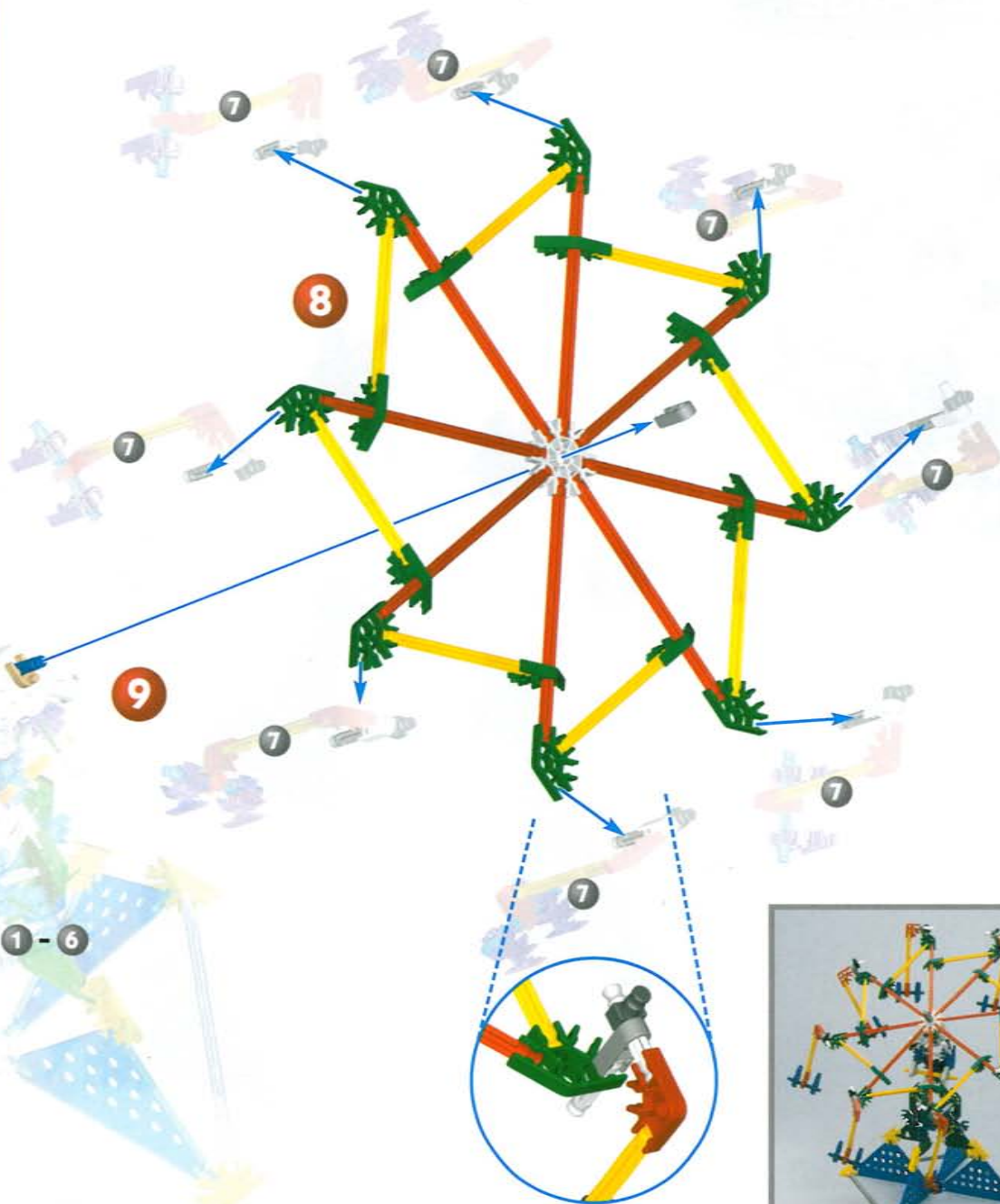

Boat Ride

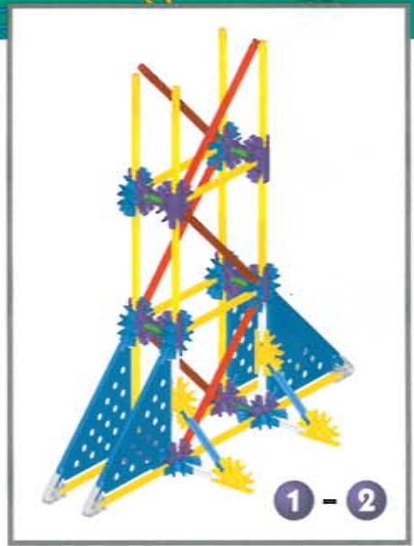
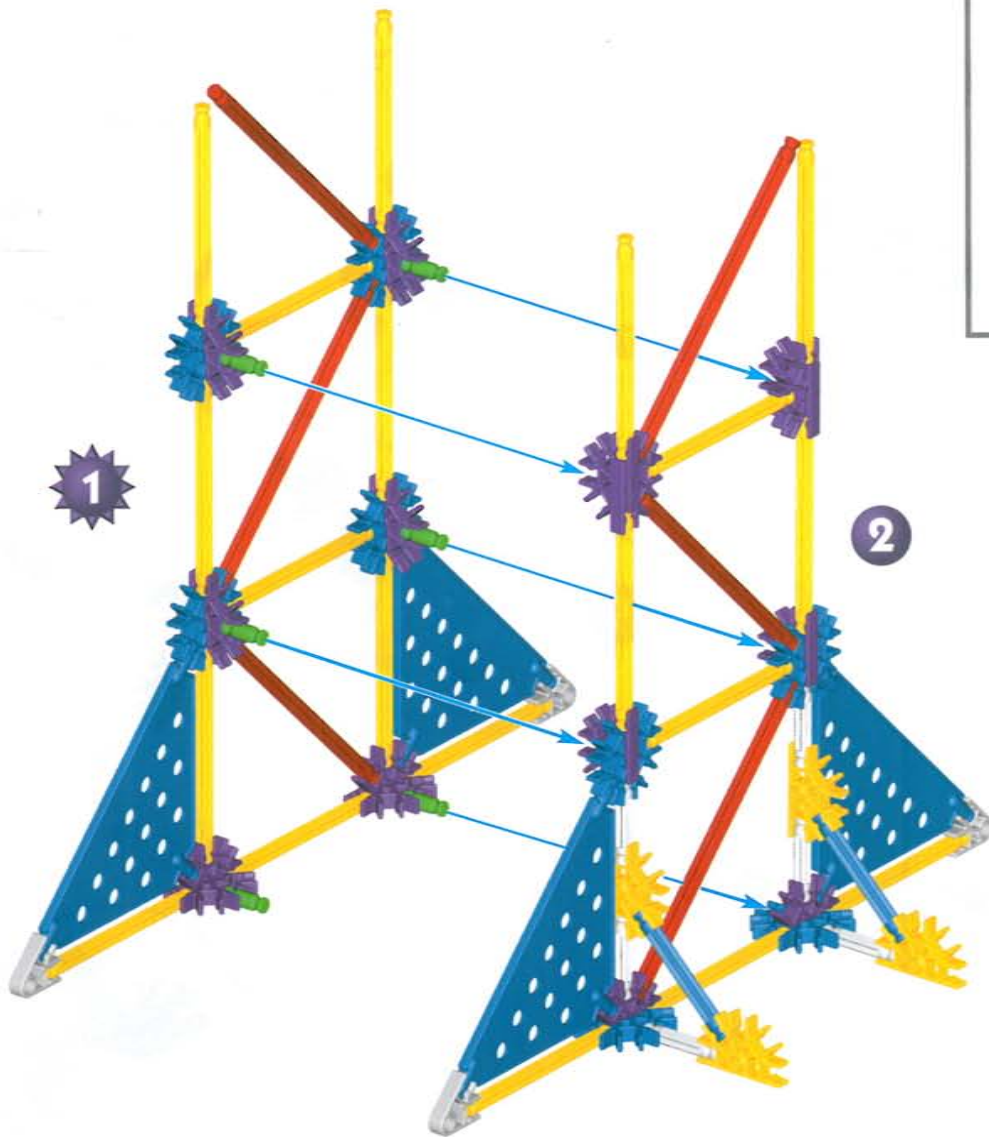

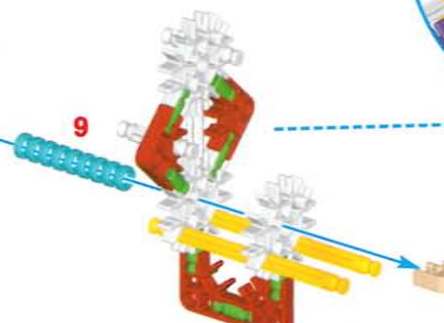
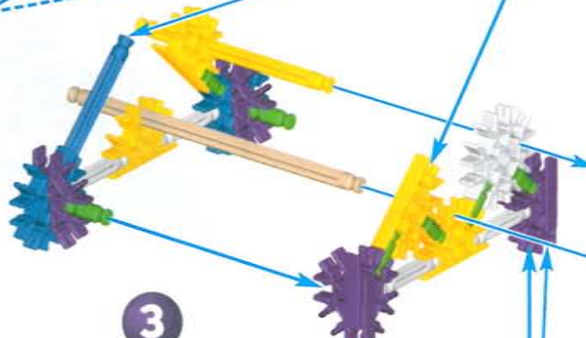
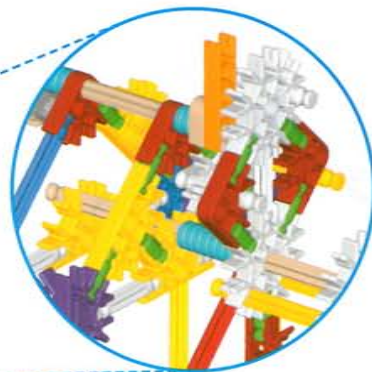
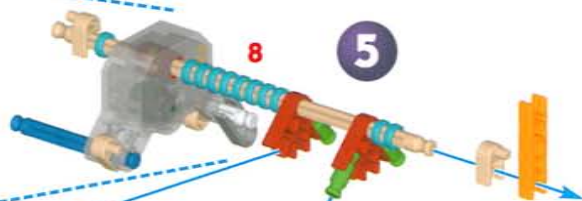
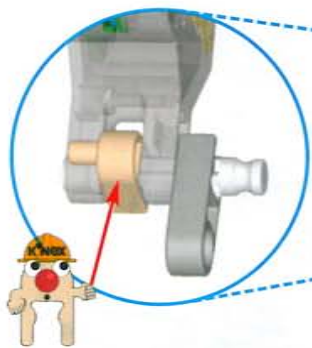

3

4

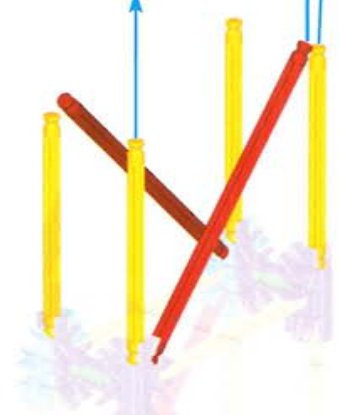

1 - 2



1 - 5

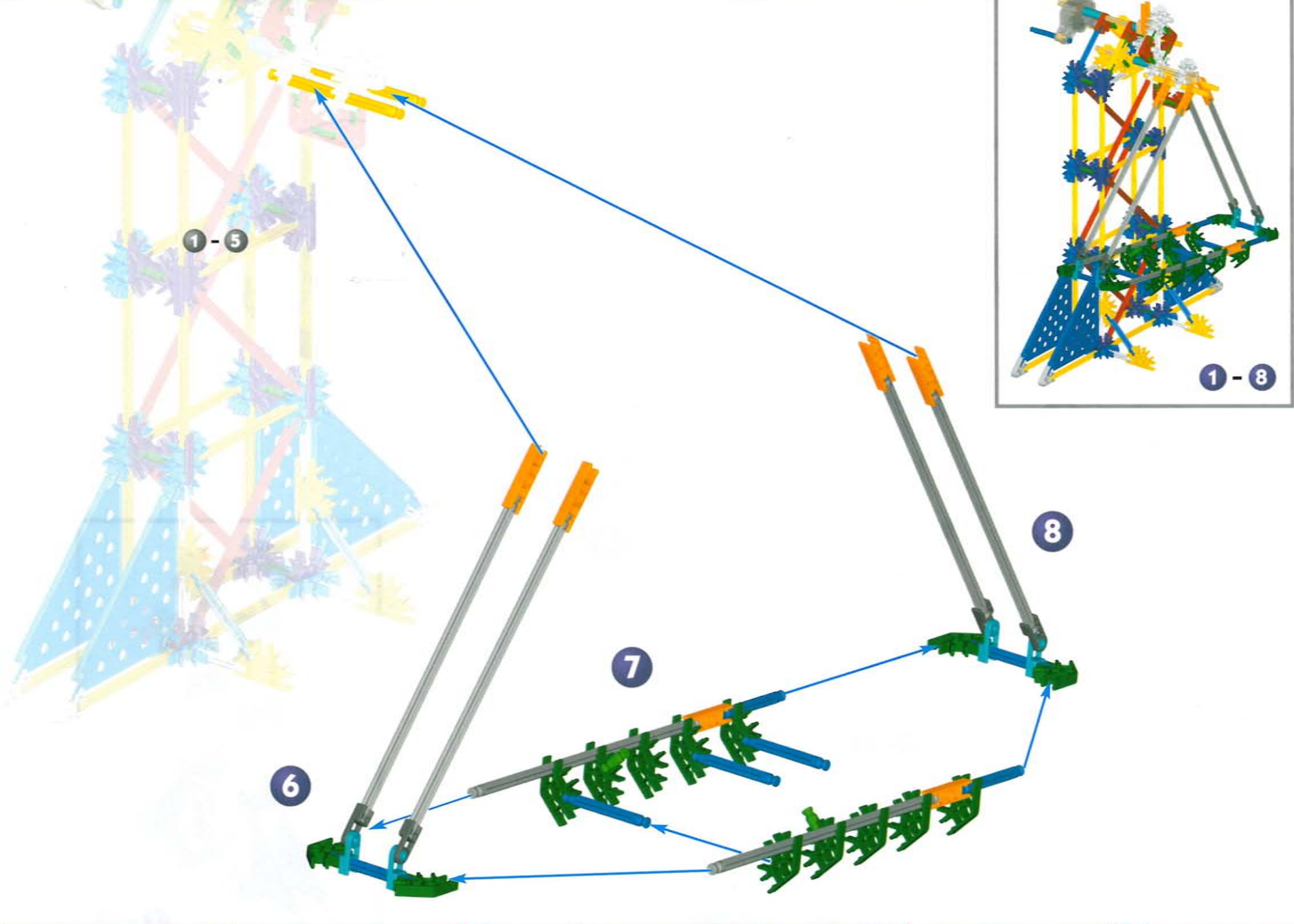

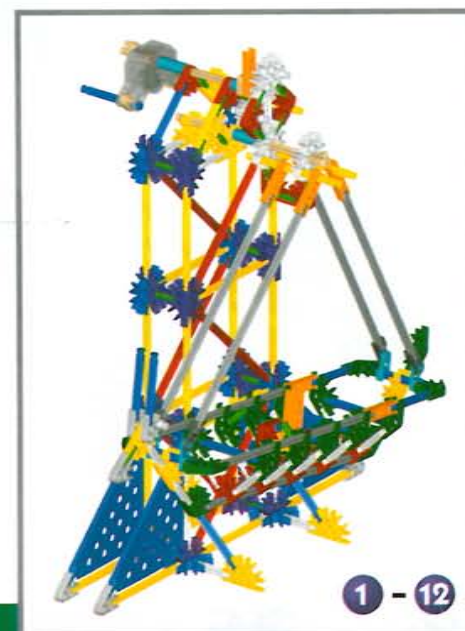
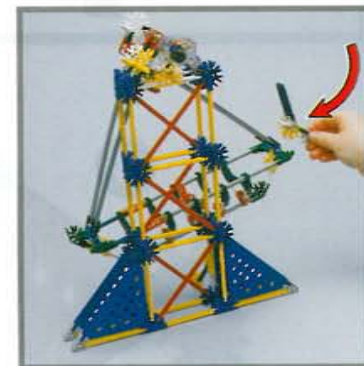
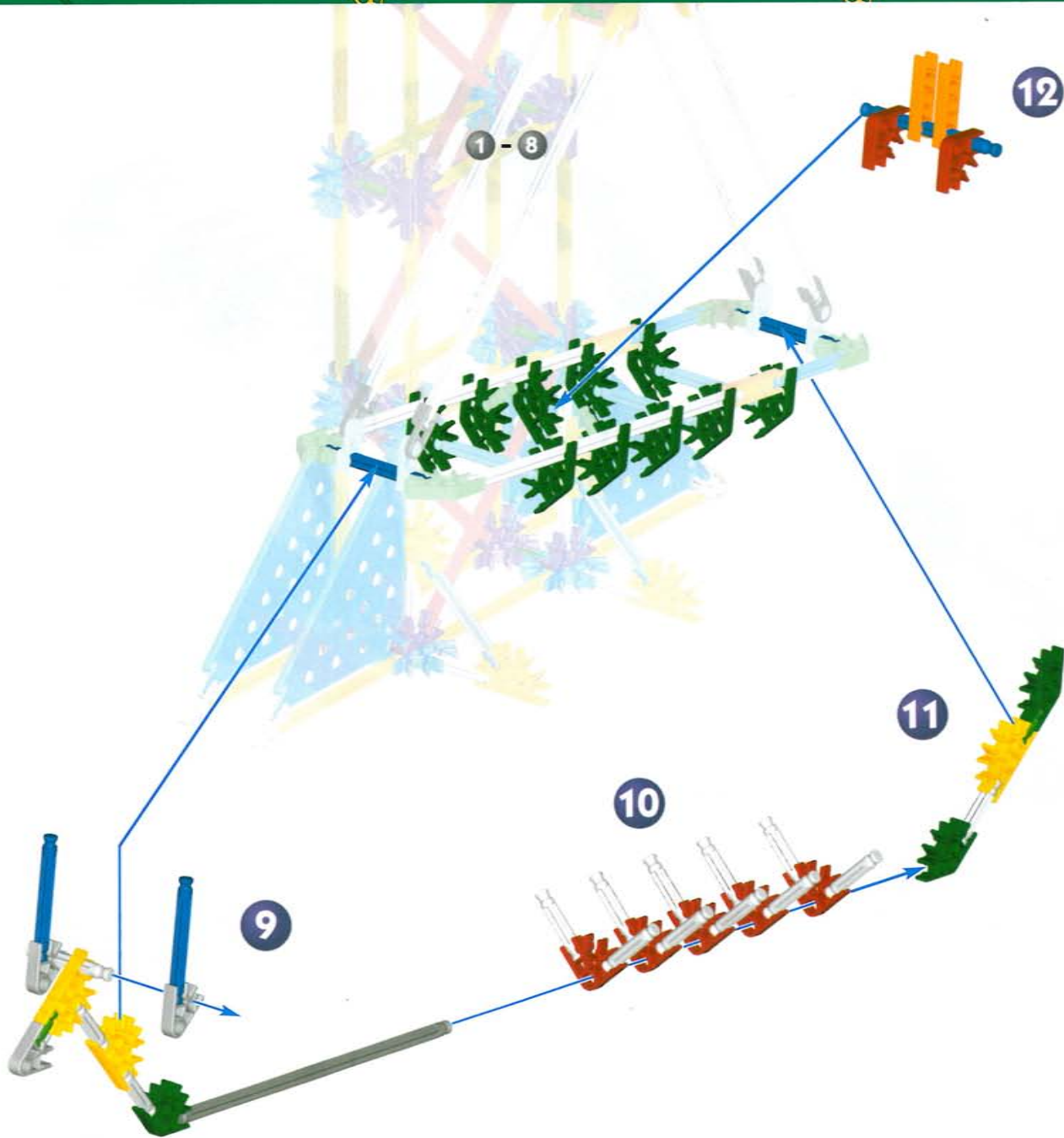

Hippo

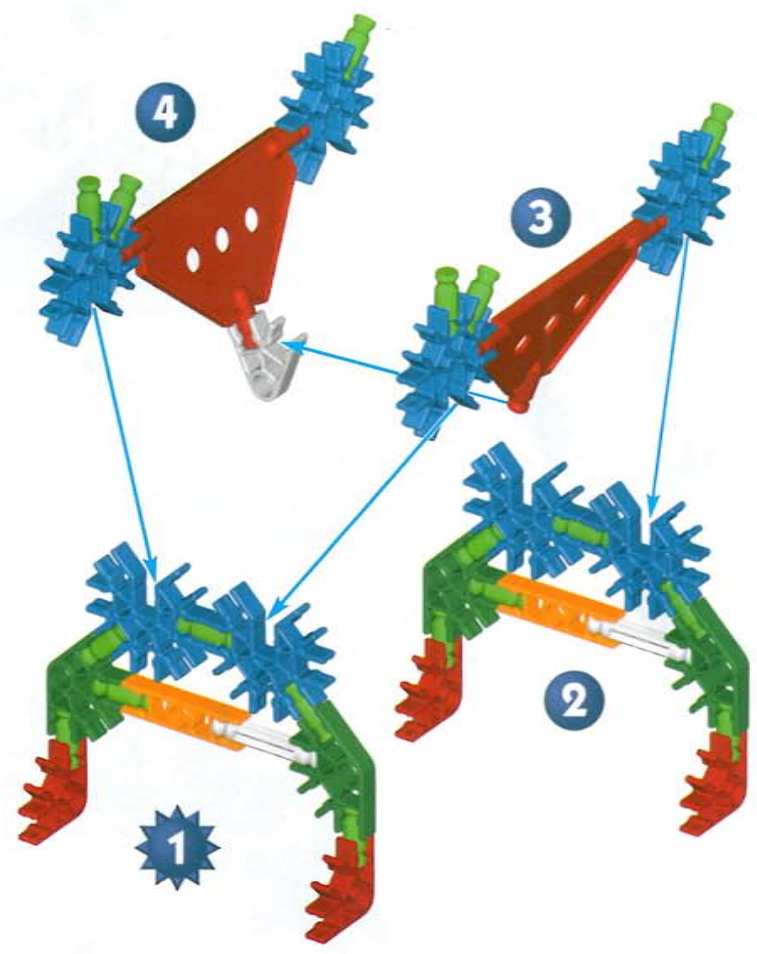
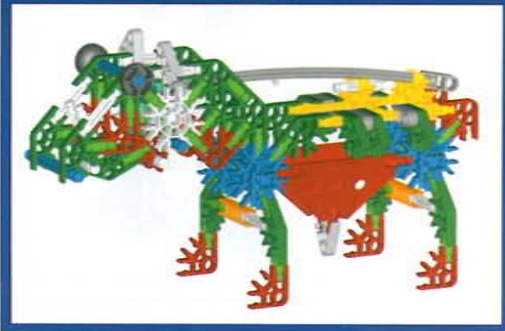

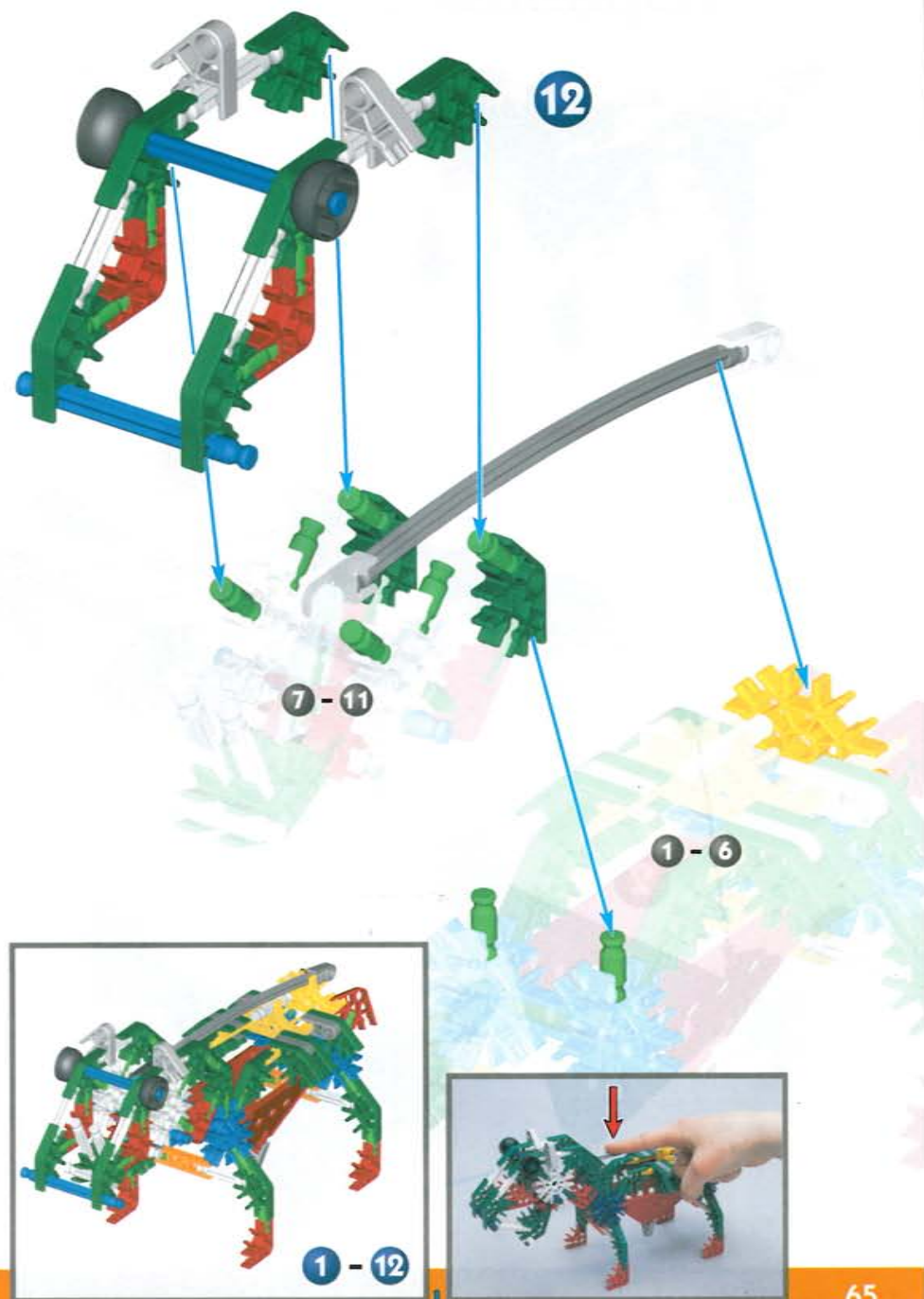
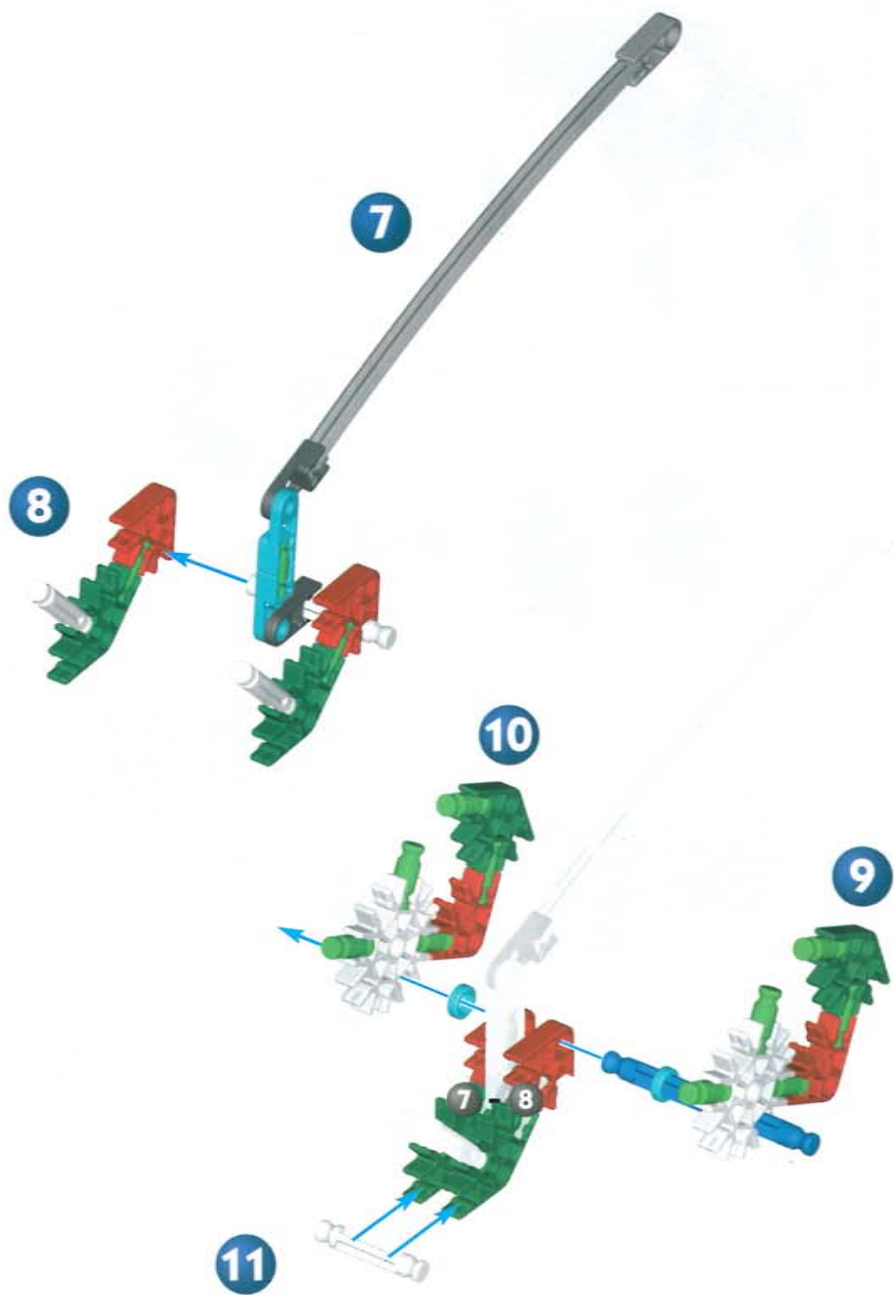

Elephant

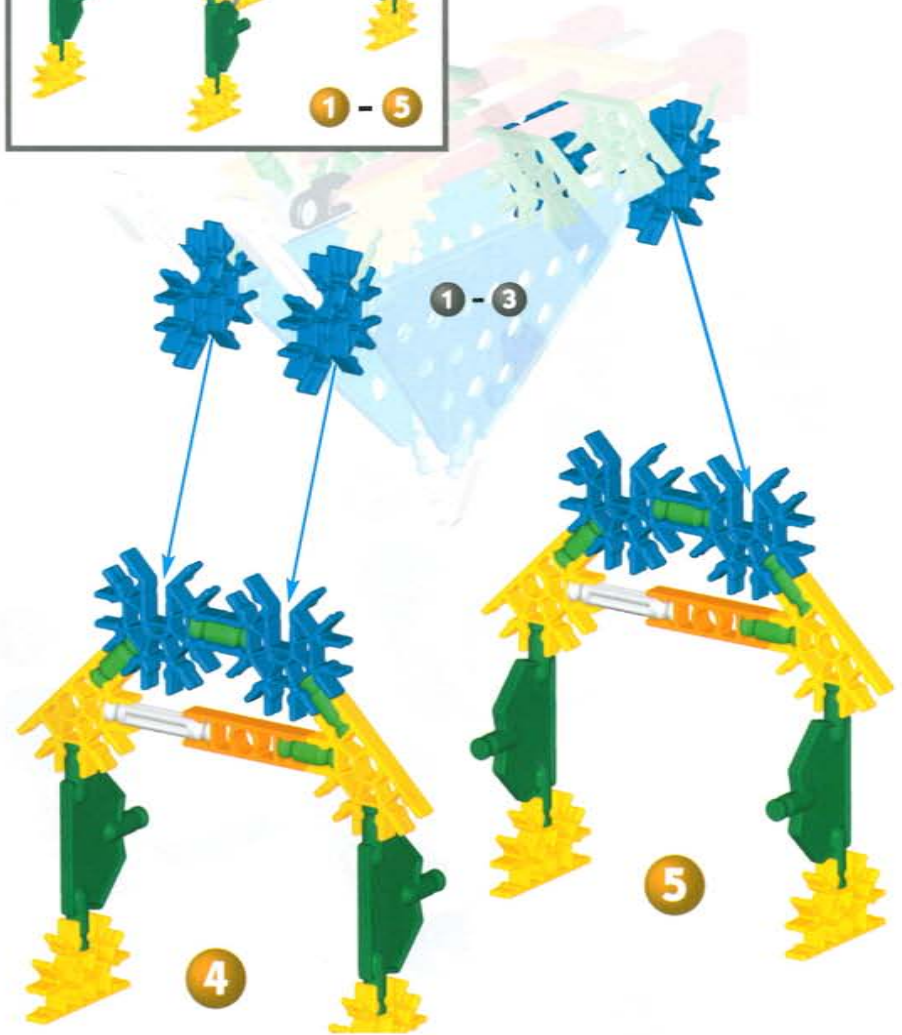
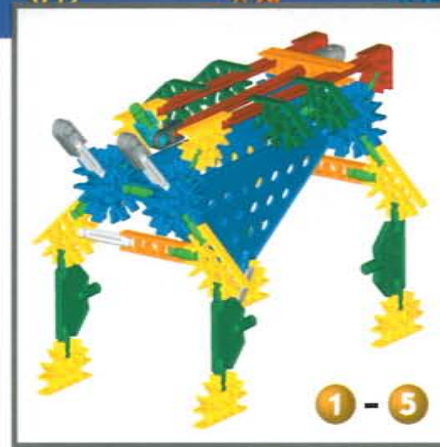
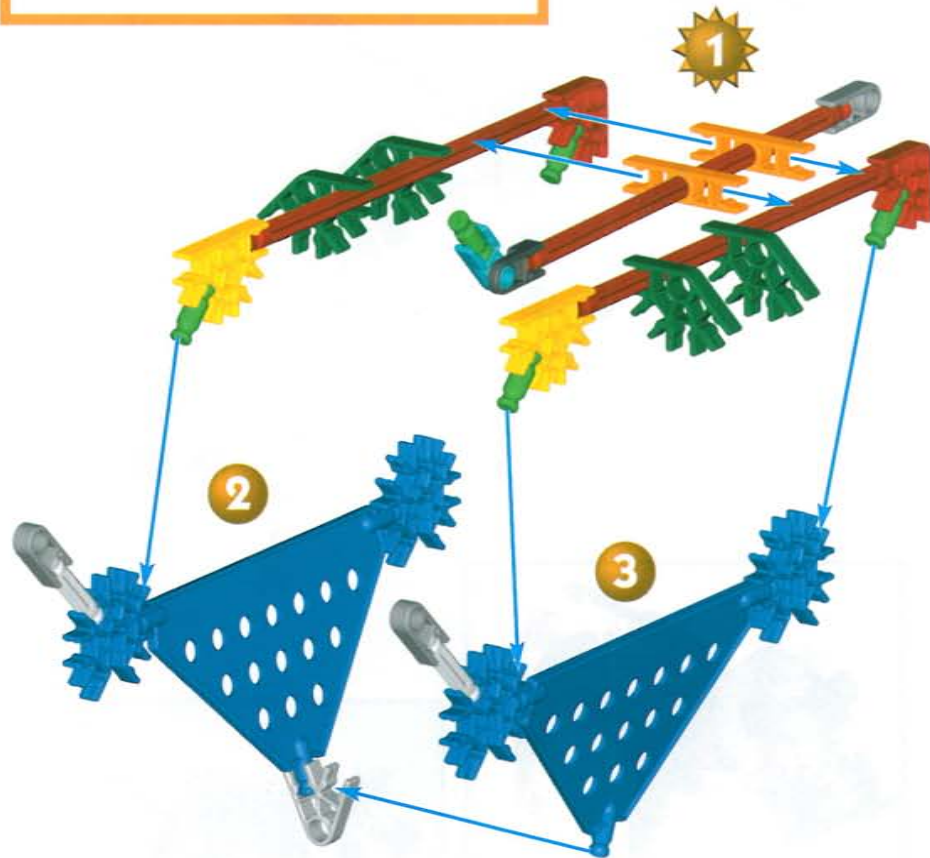

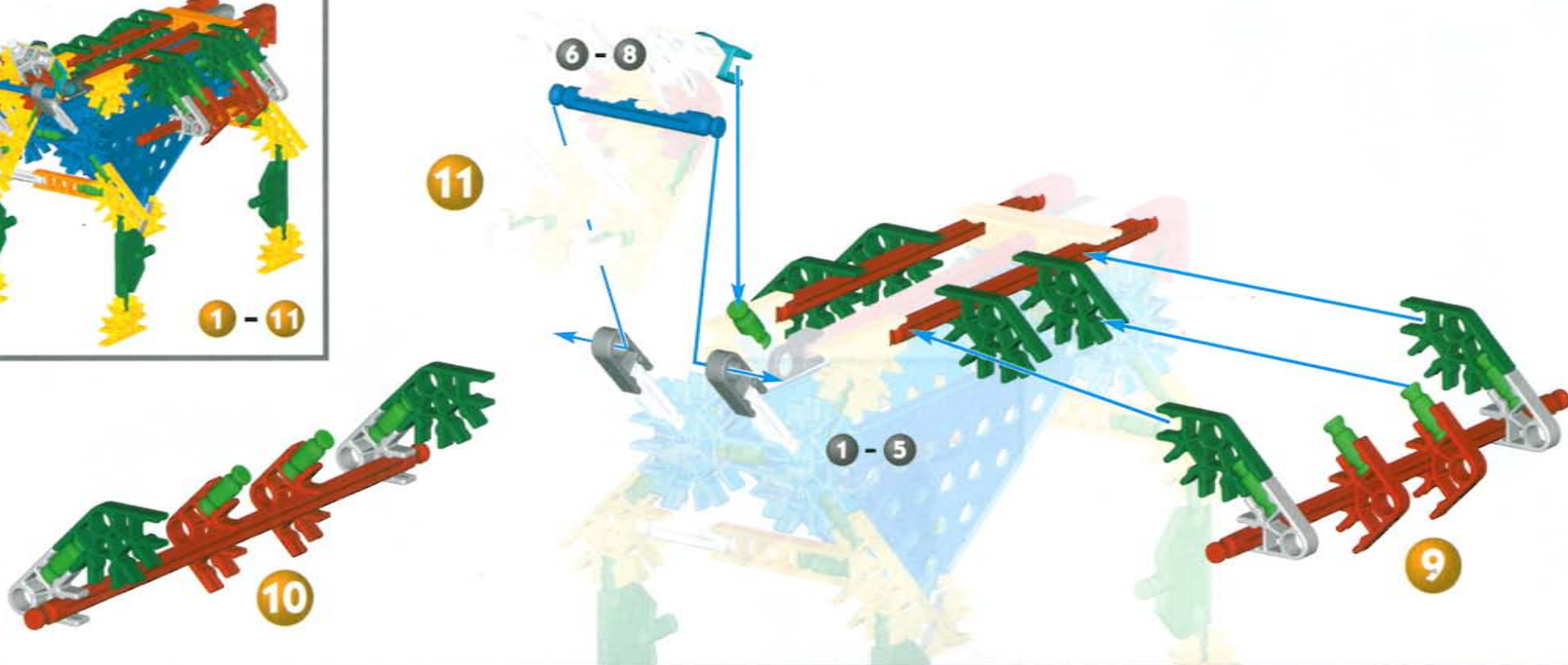
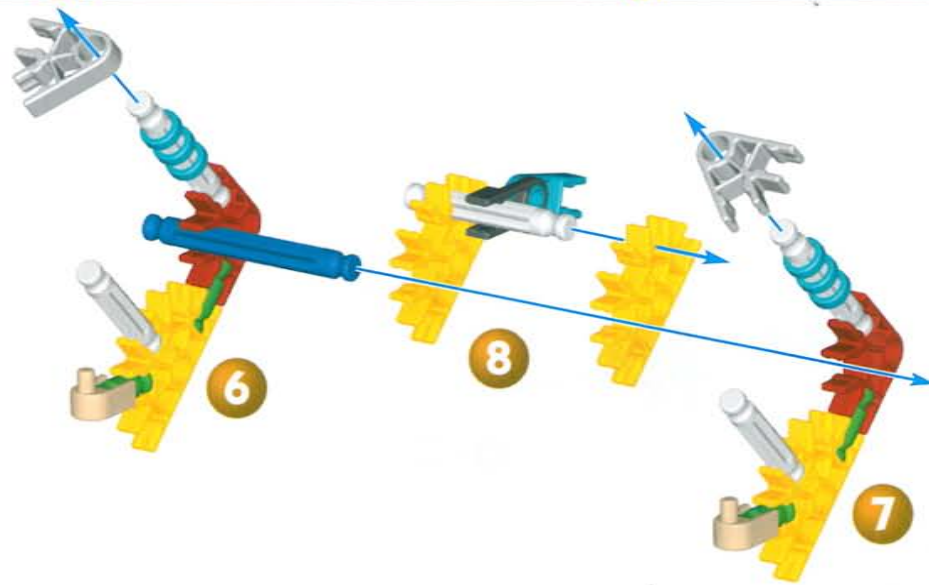

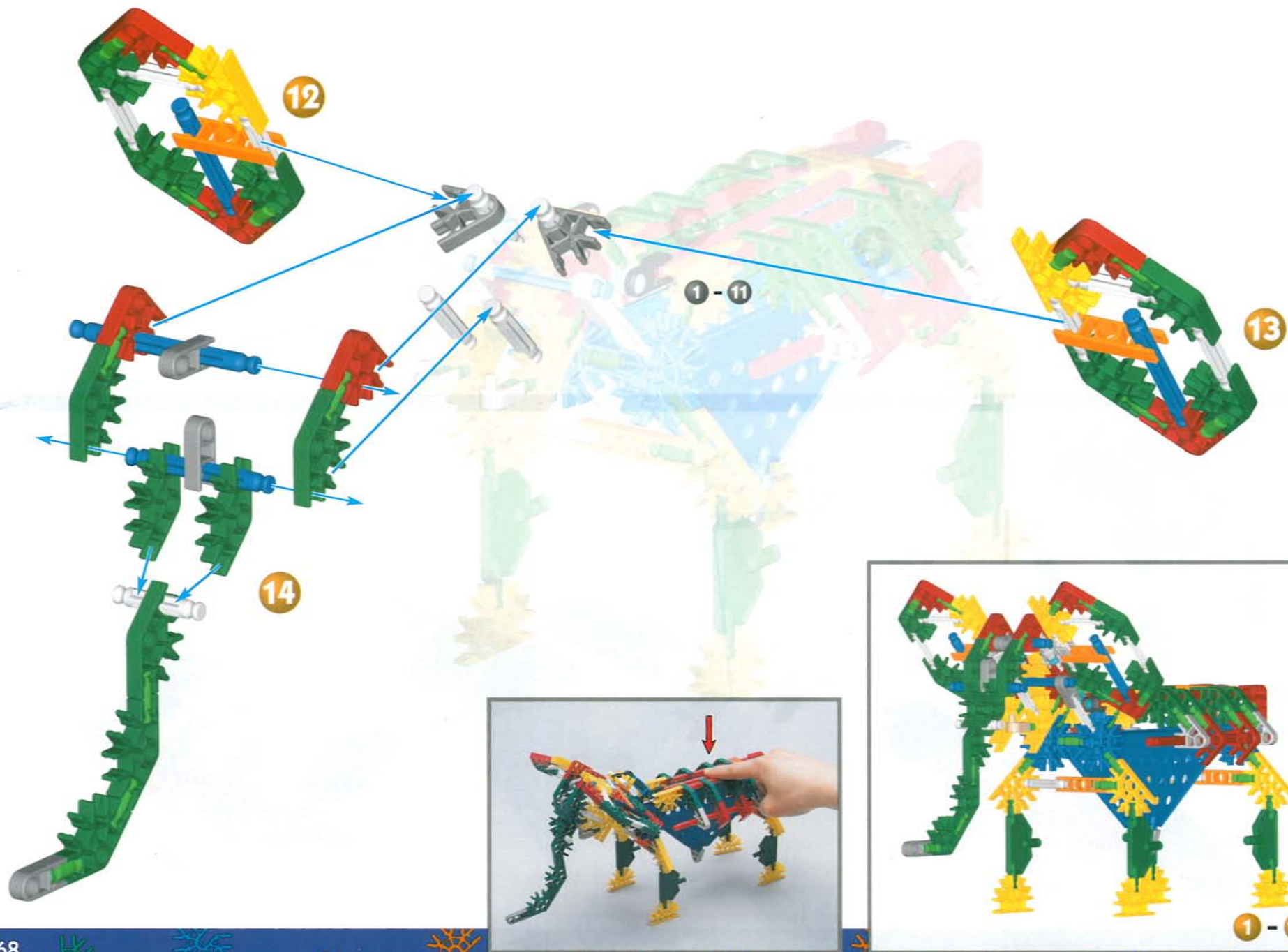

Prop Plane

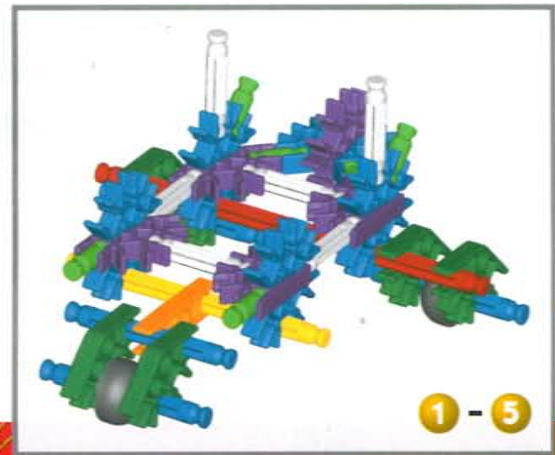
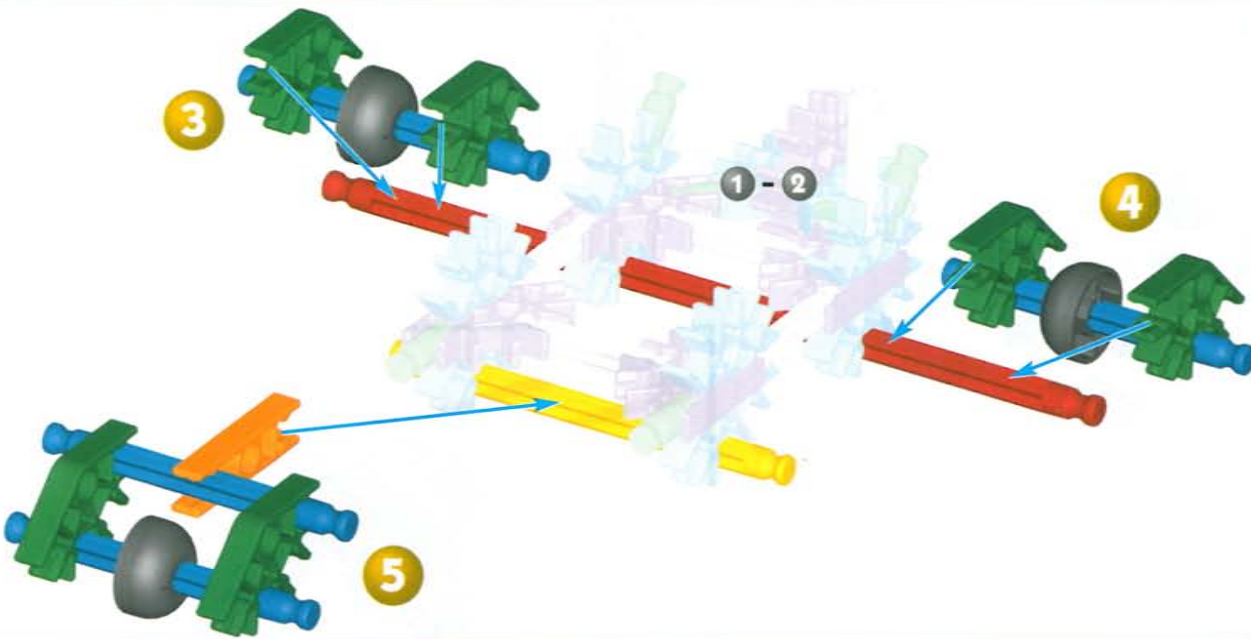
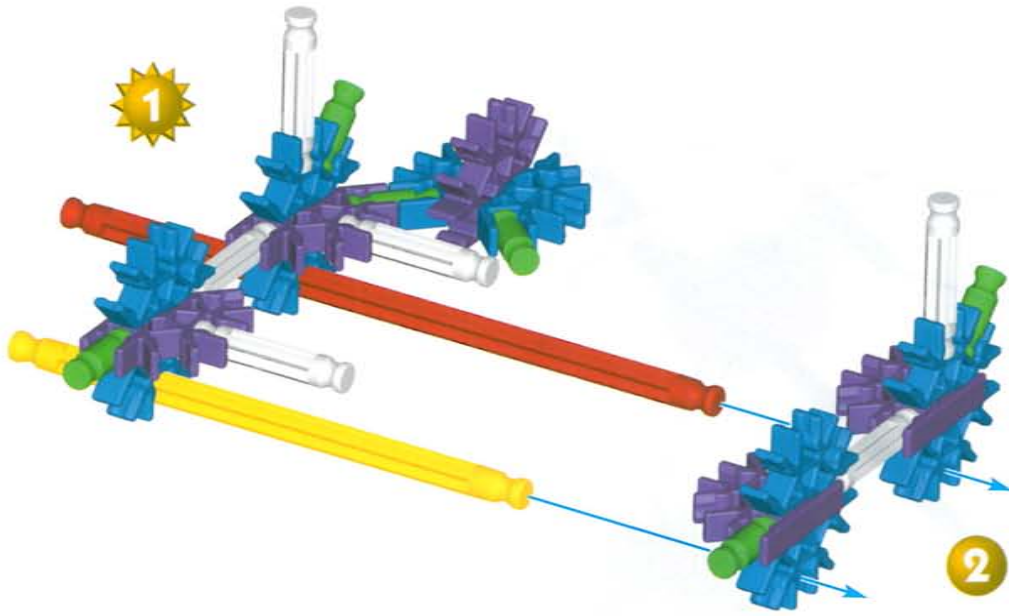

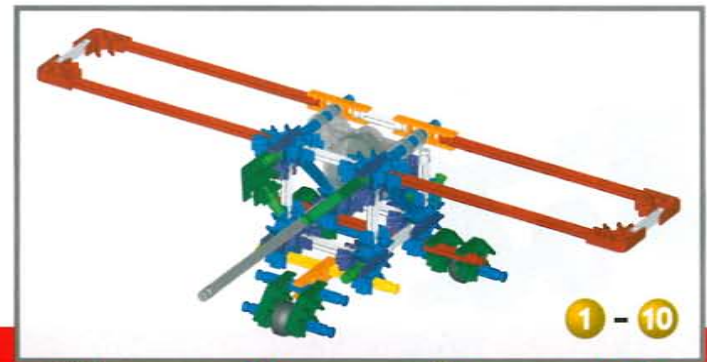
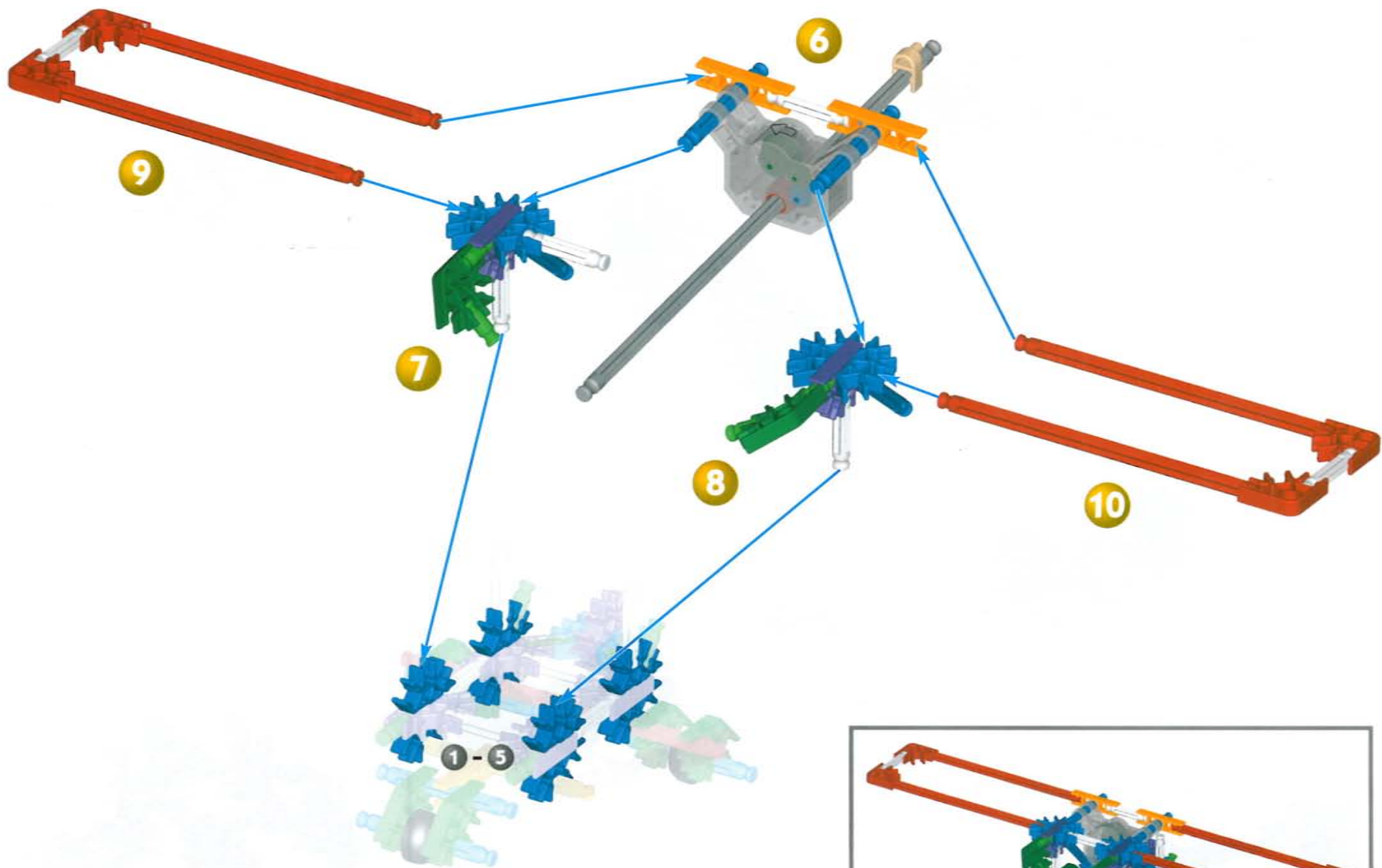

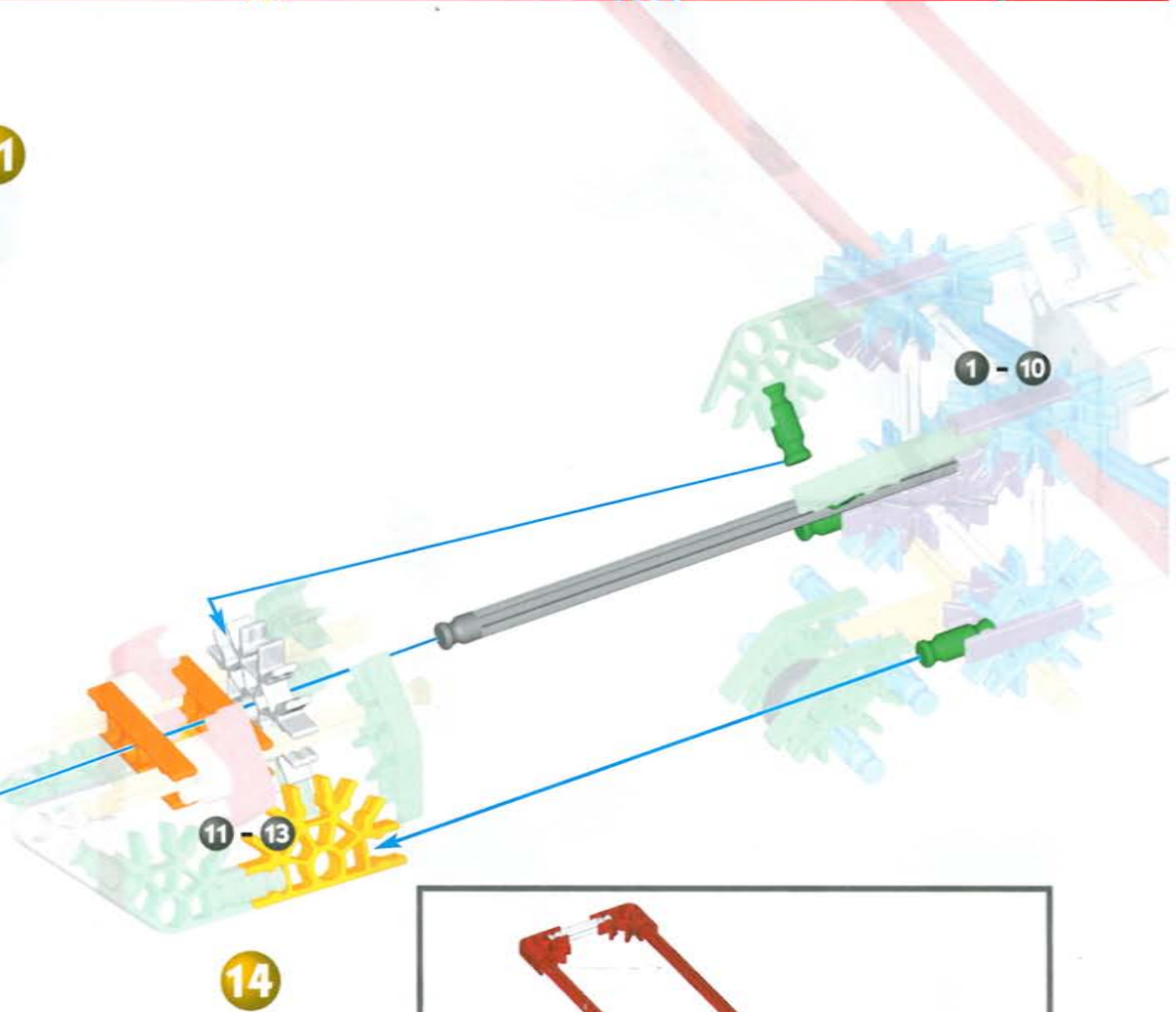
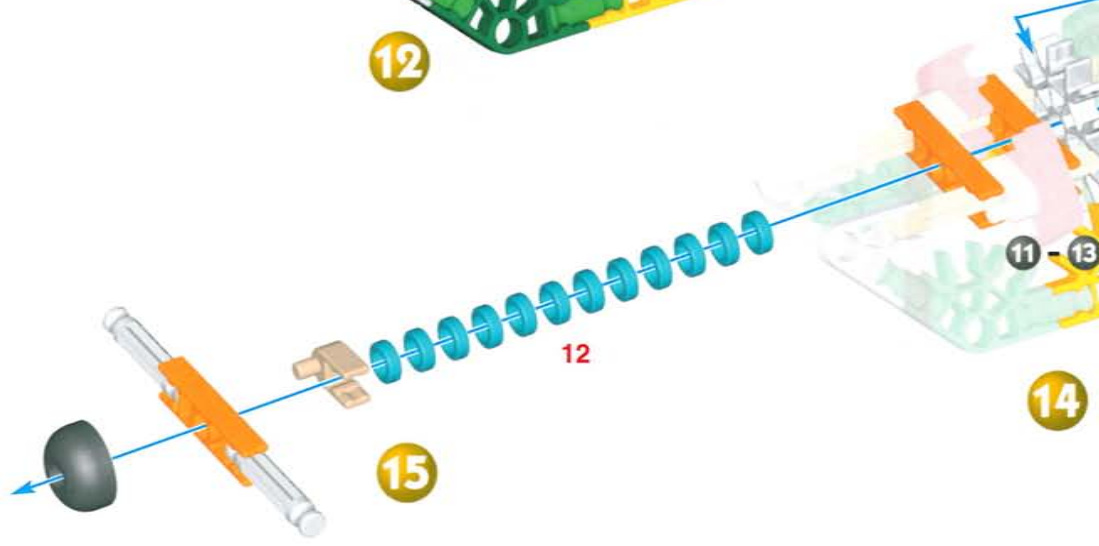
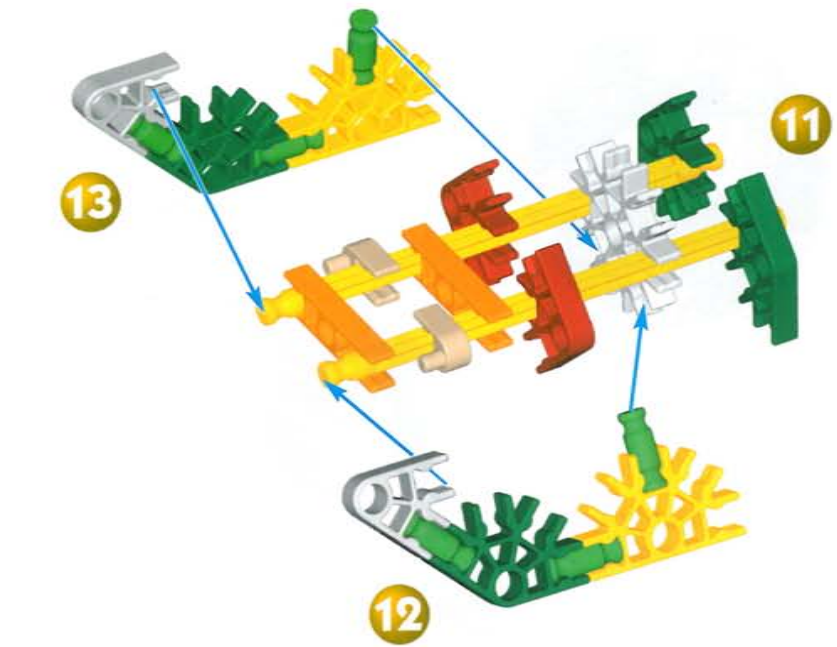

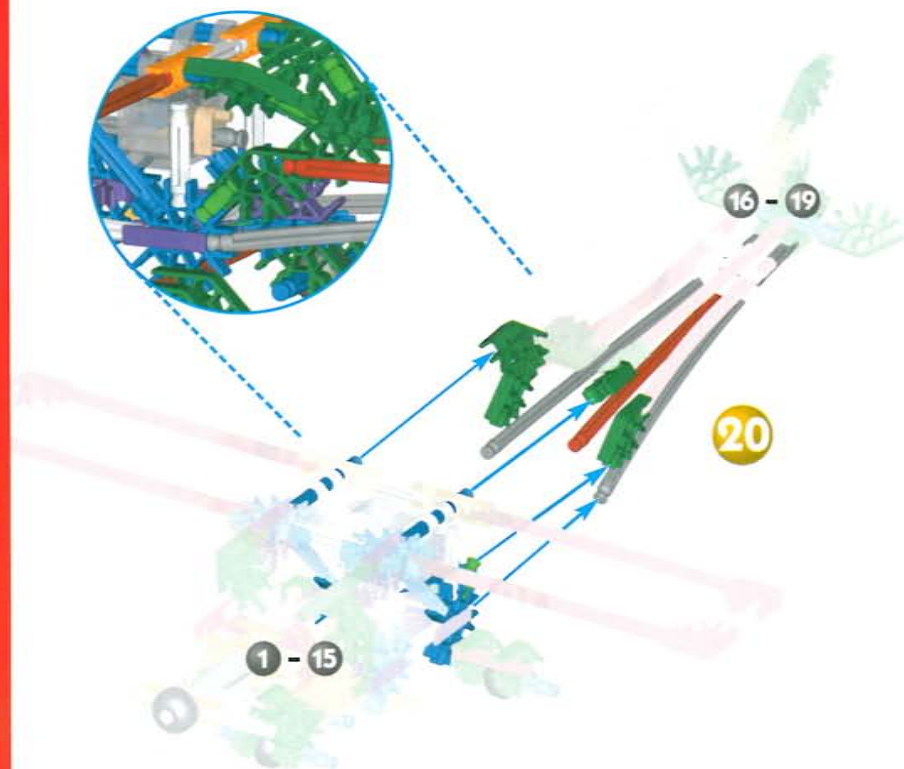
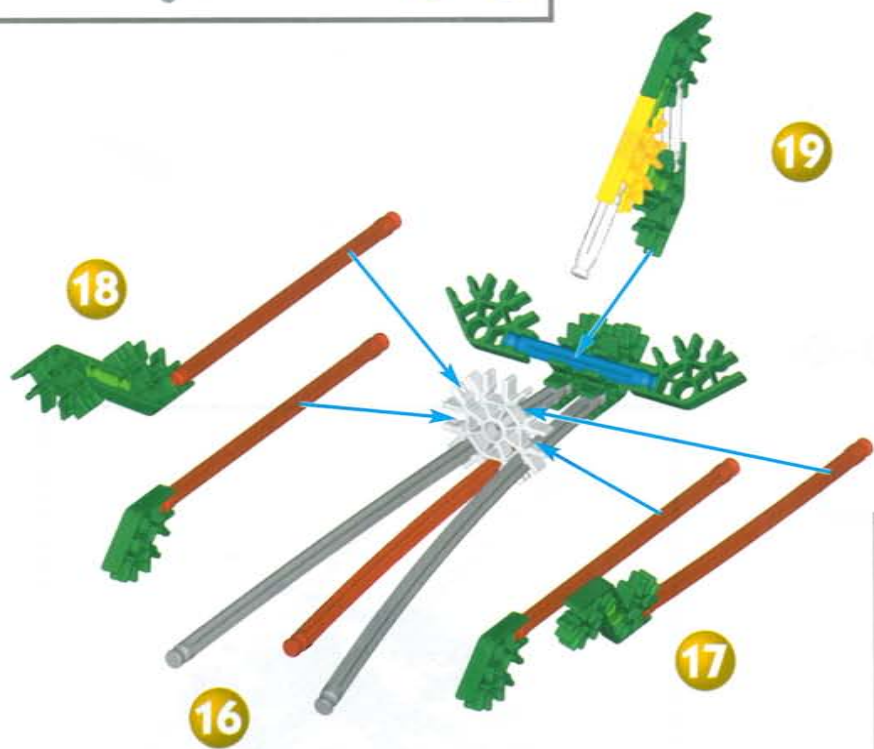
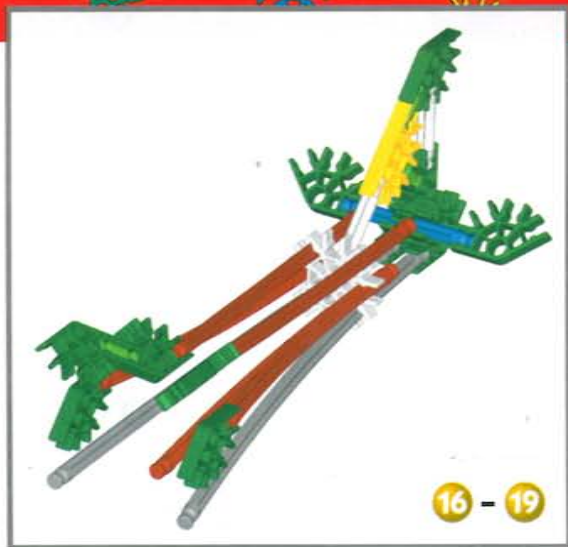

Combine Harvester

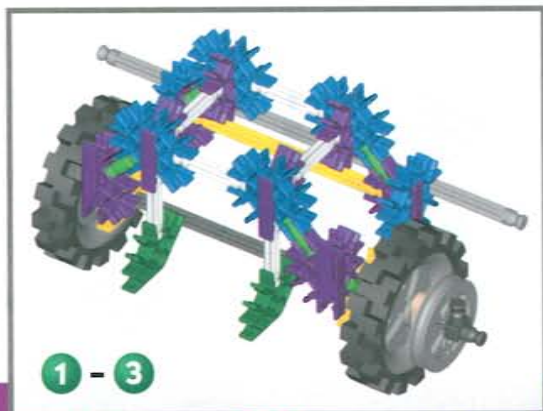
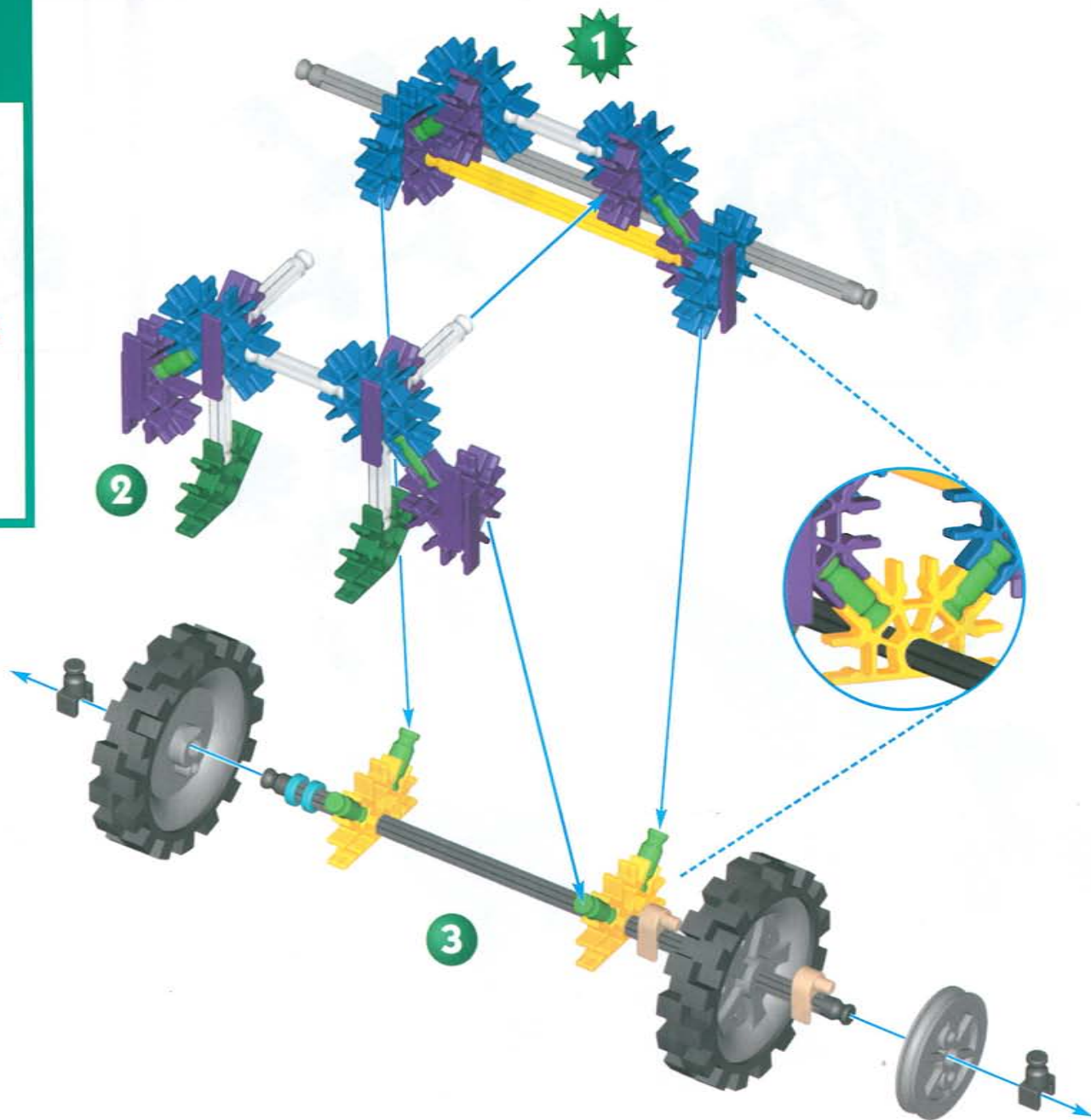

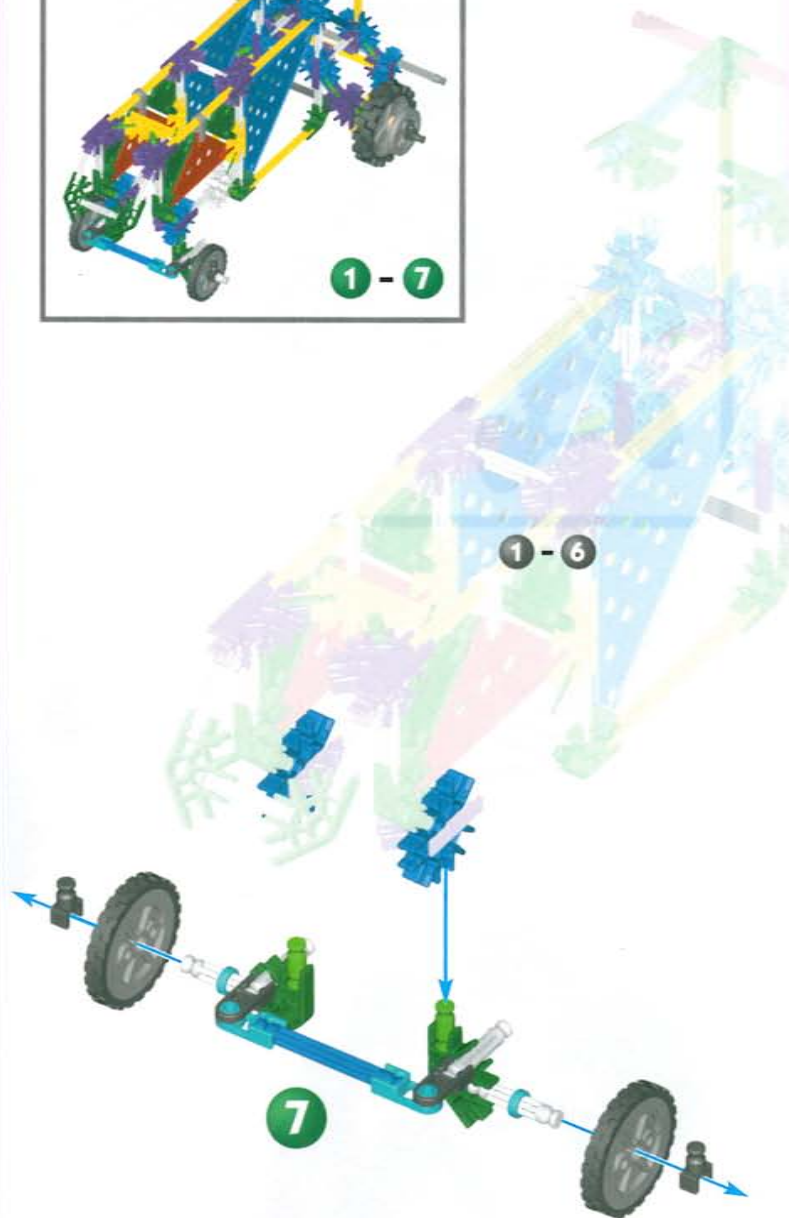
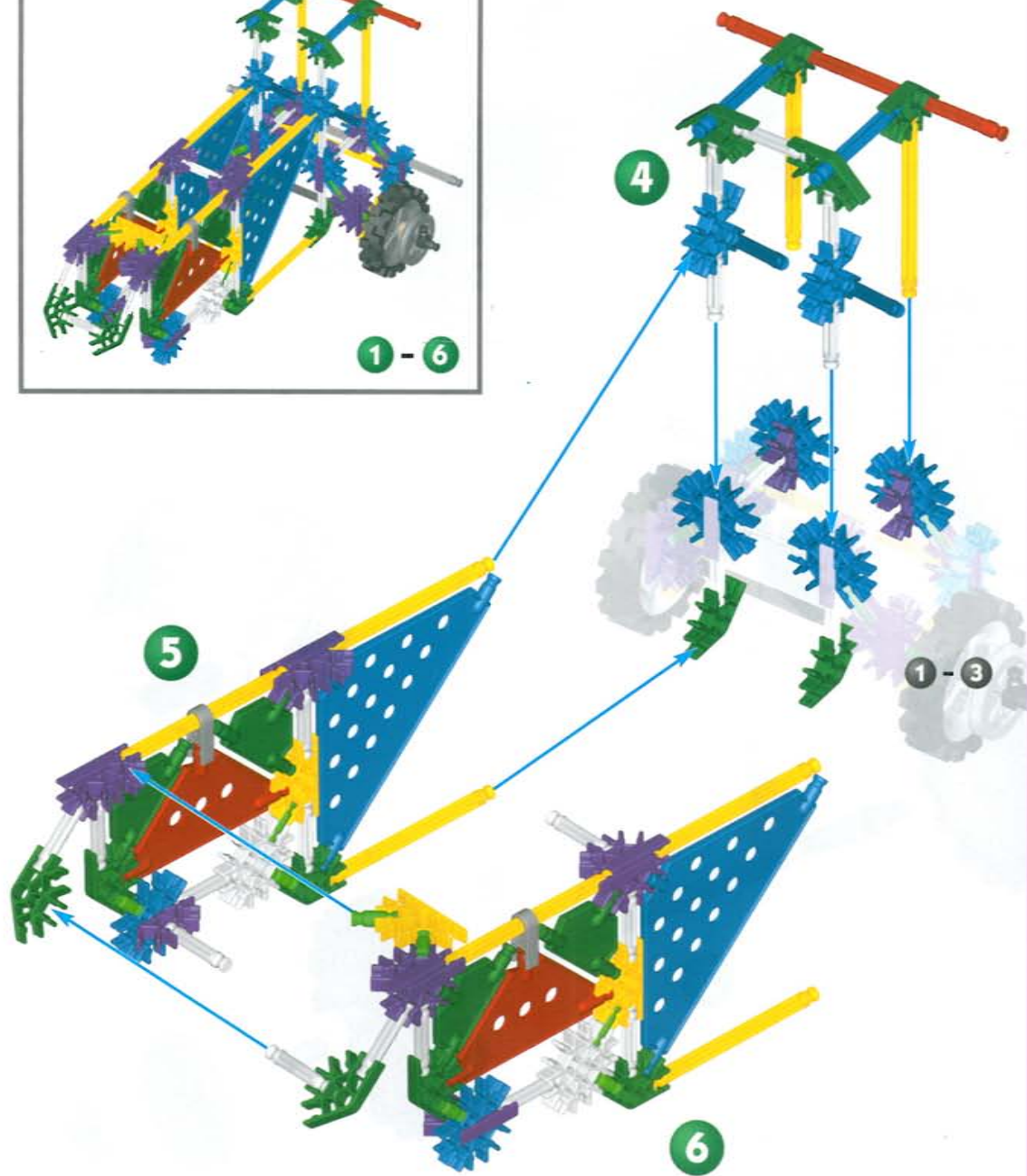

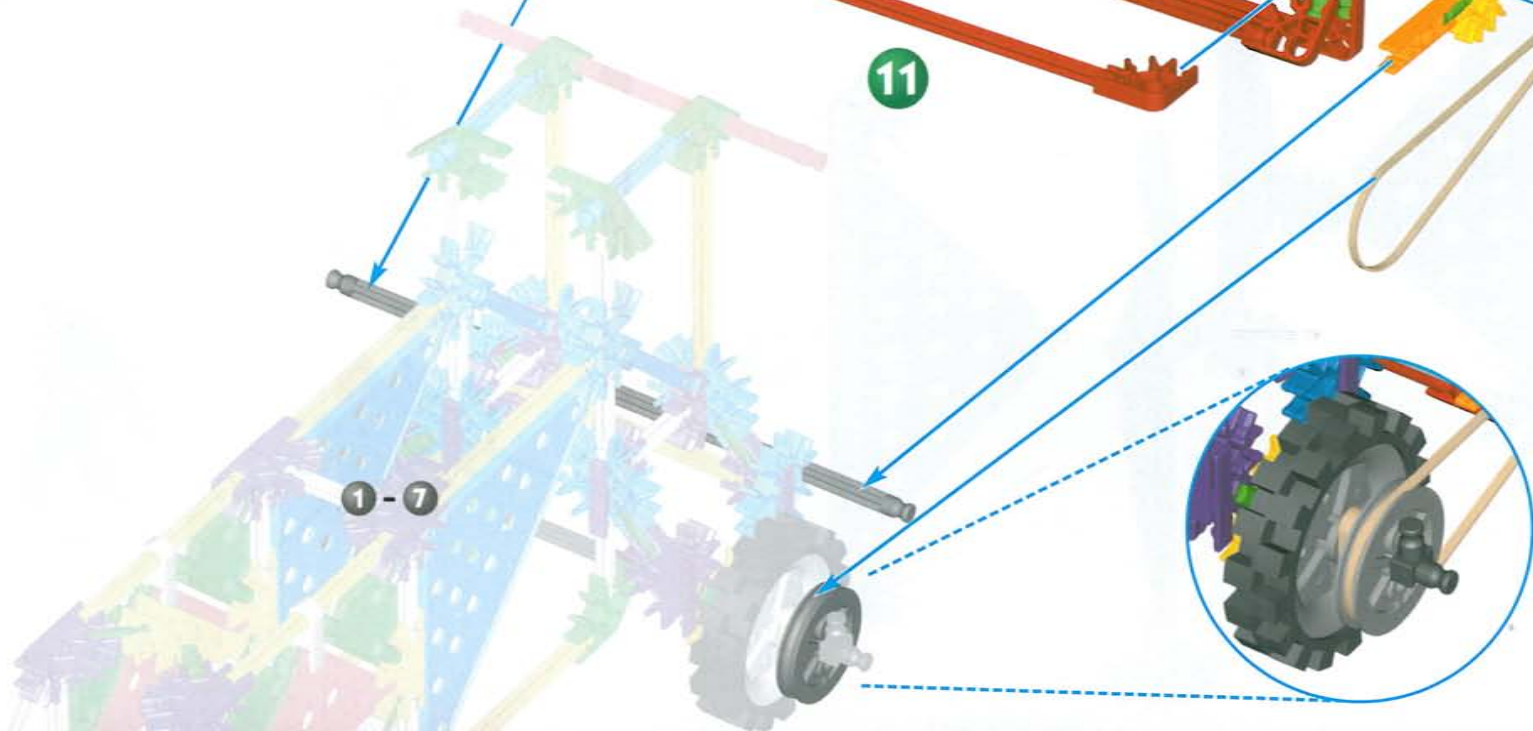
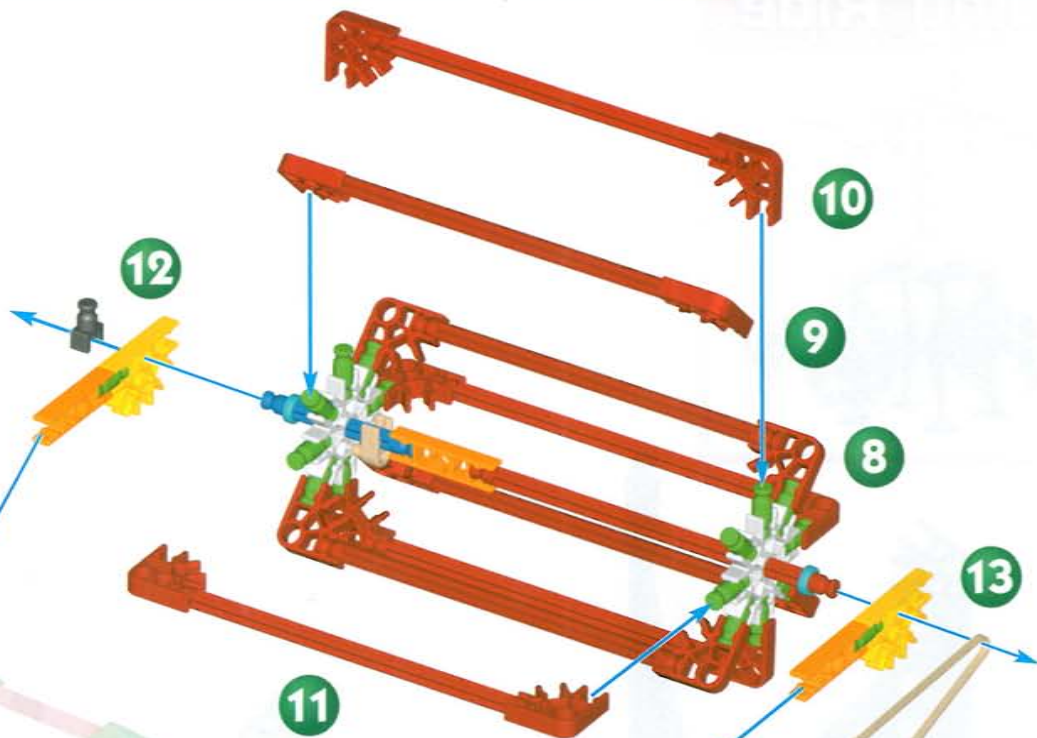

Swing Ride

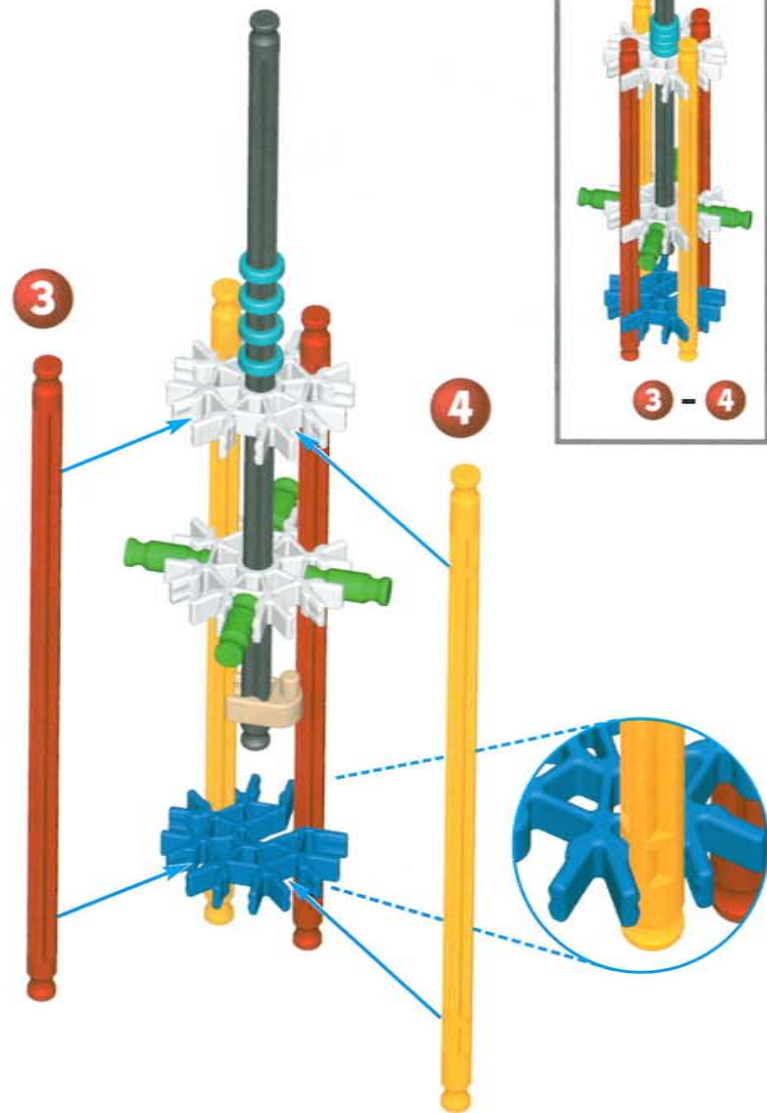
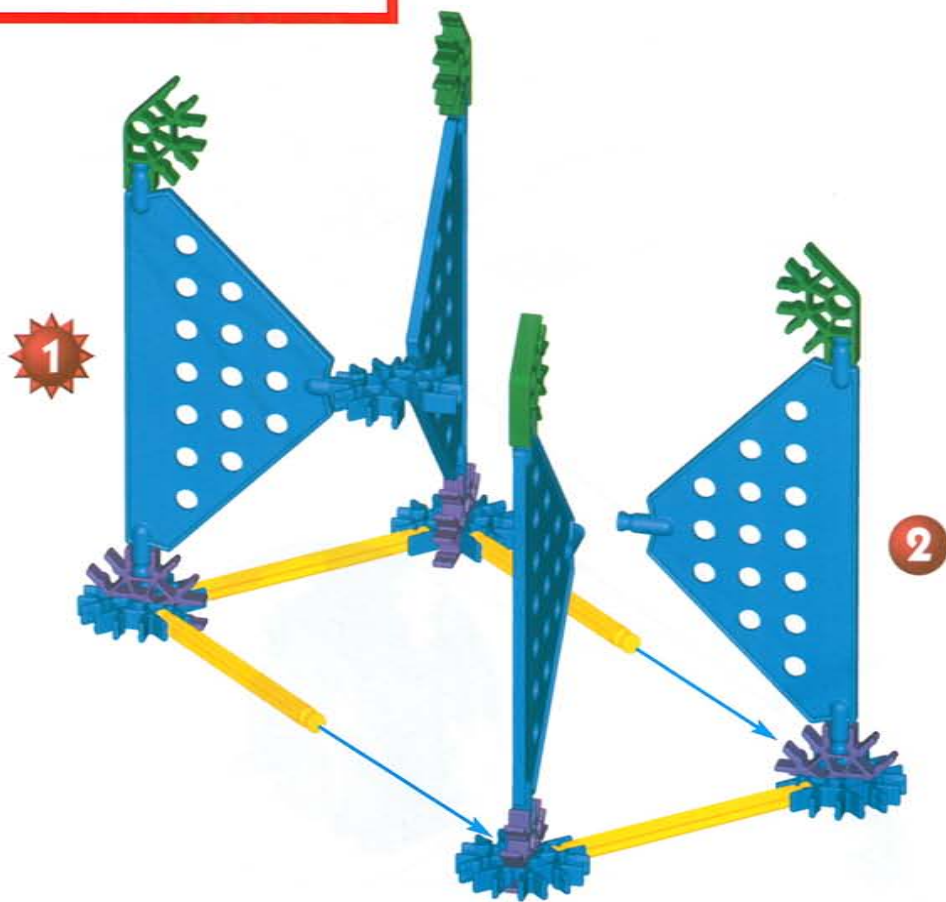

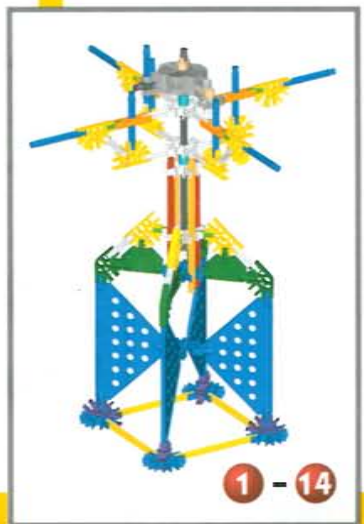
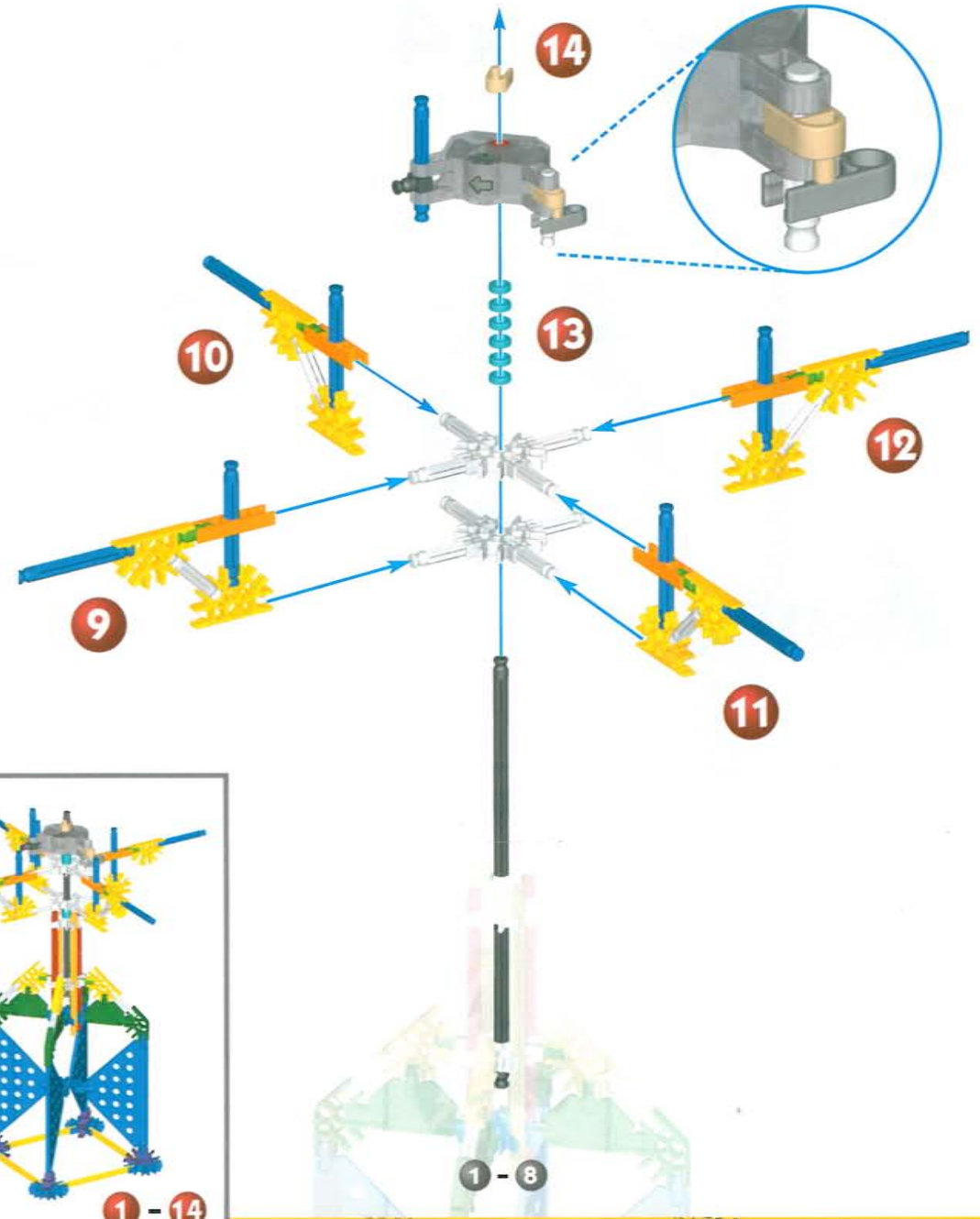
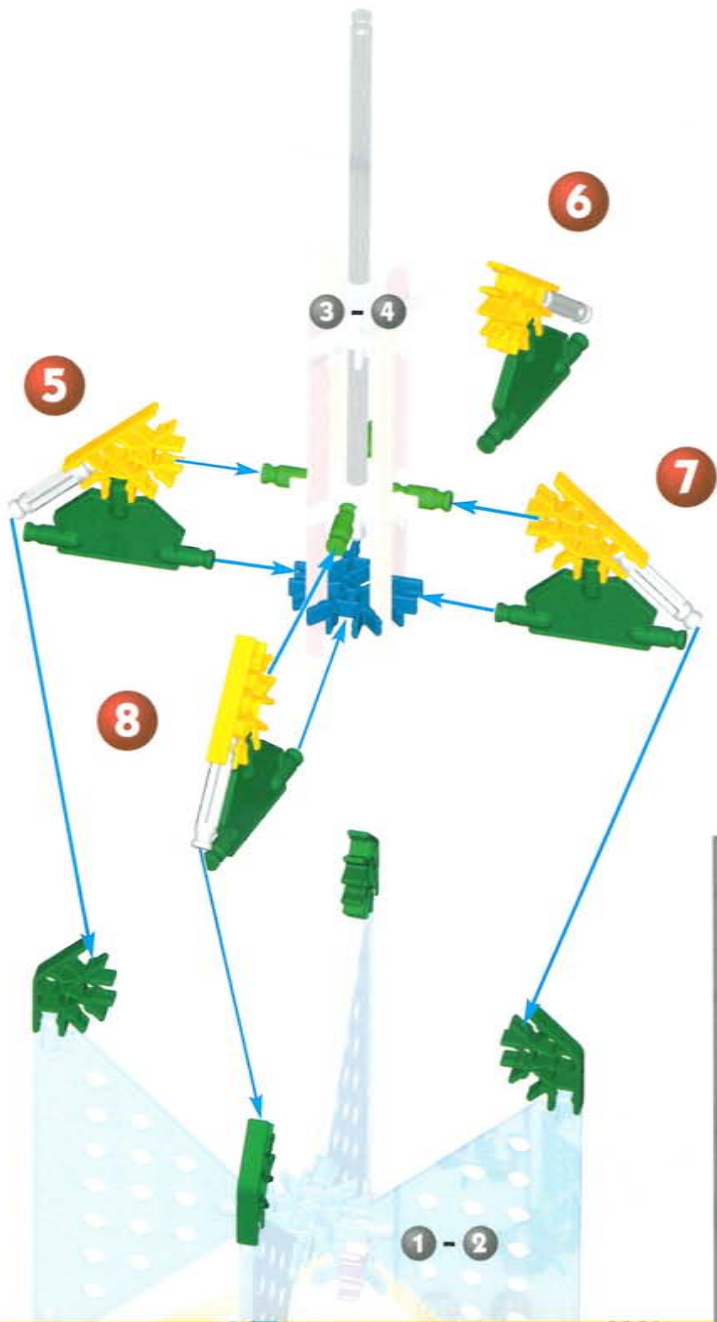

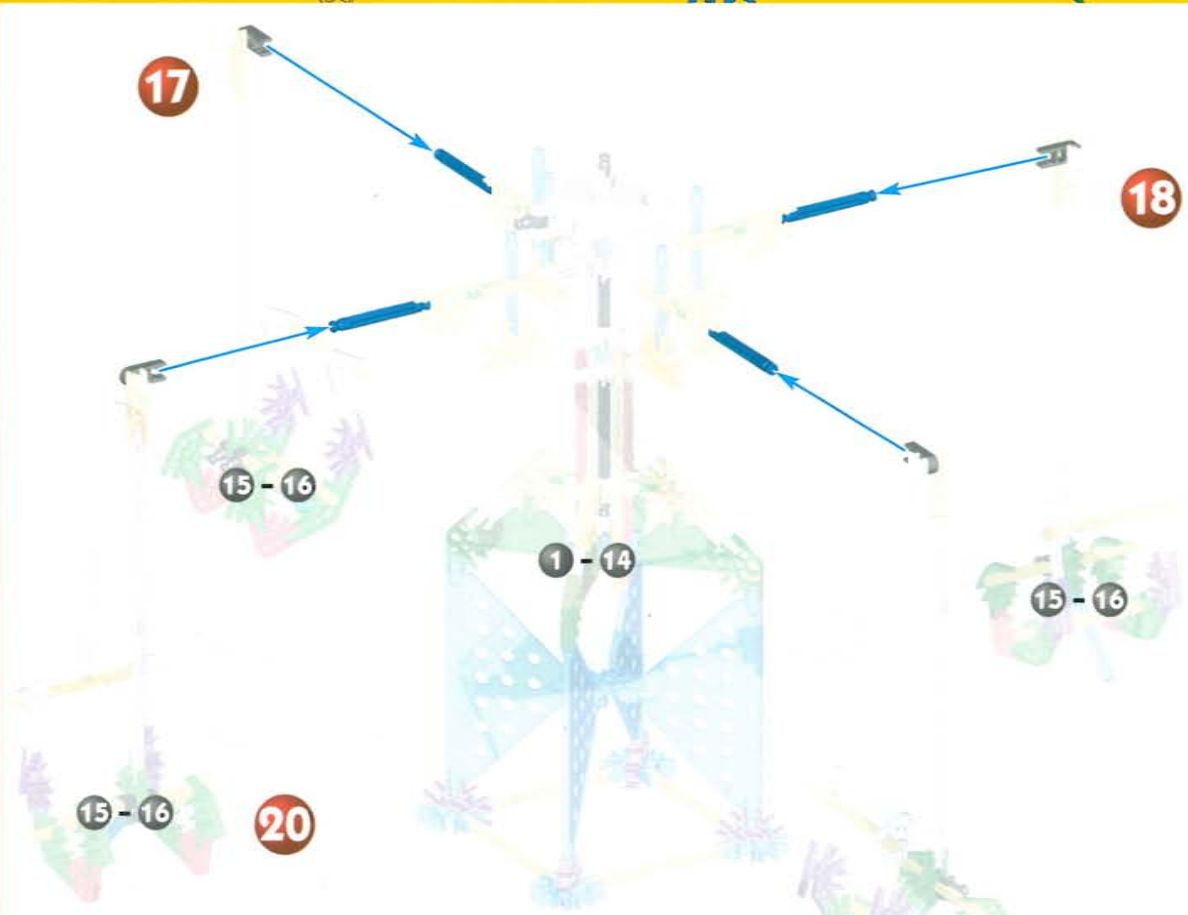
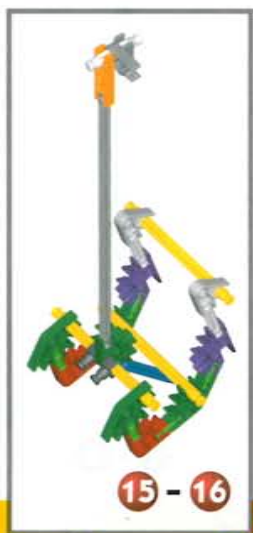
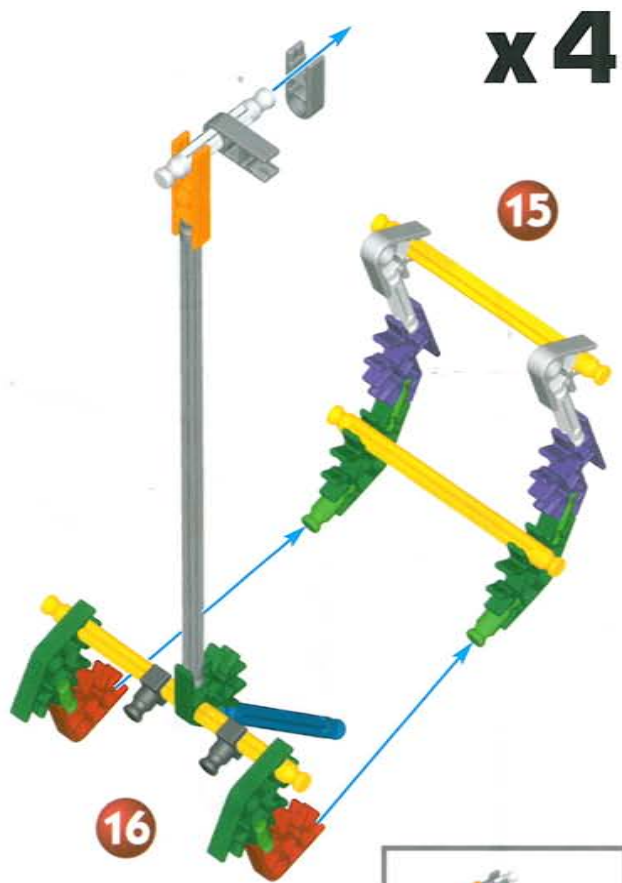

Exploration Vehicle

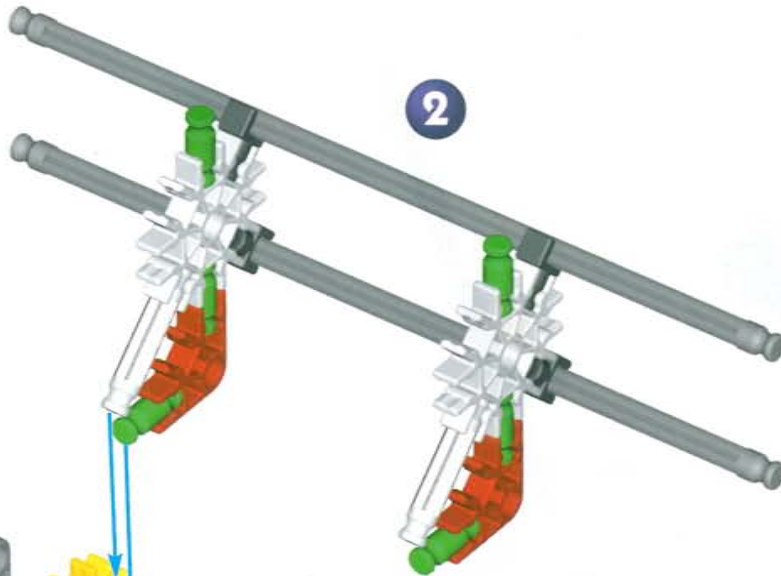
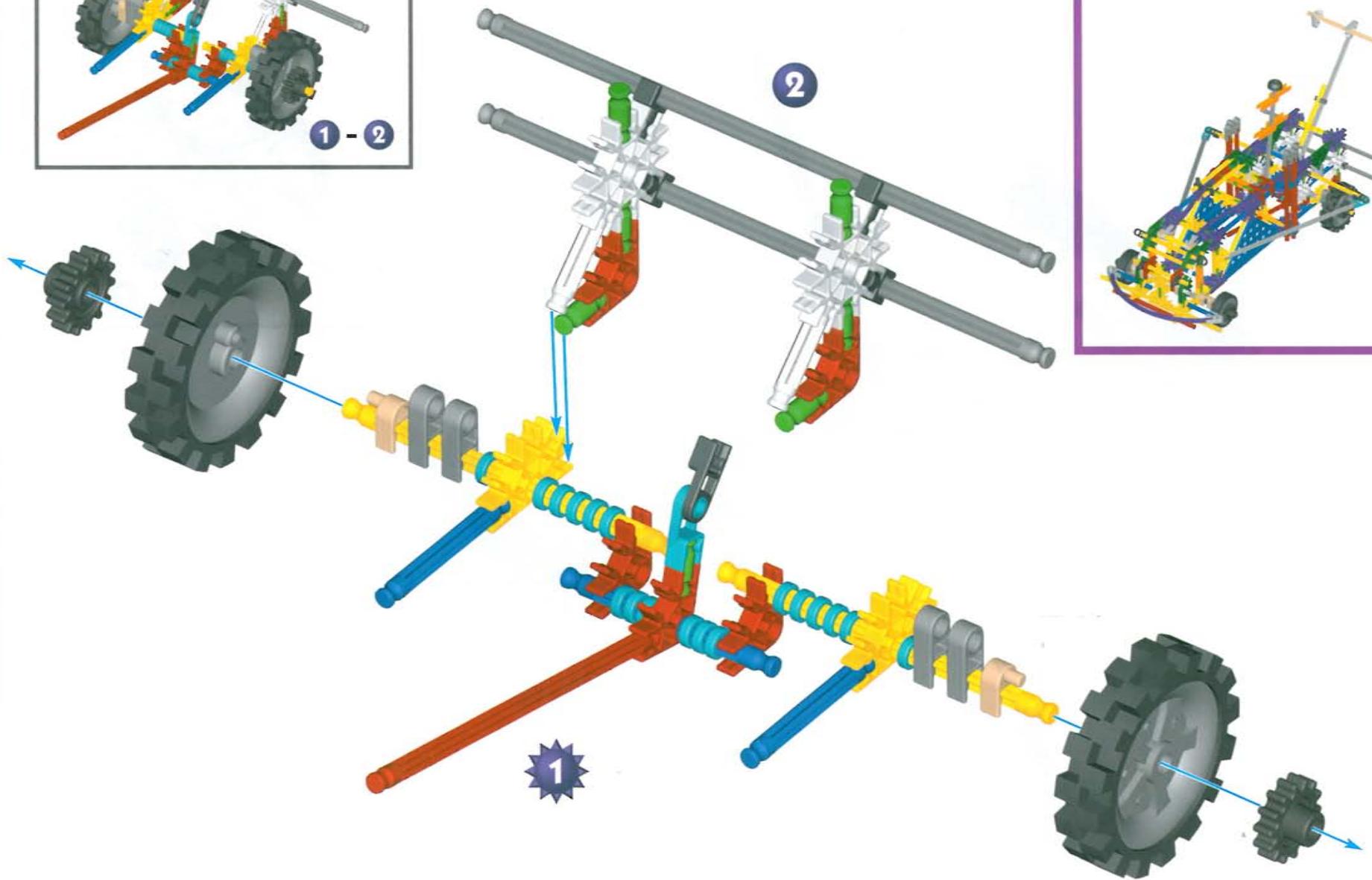
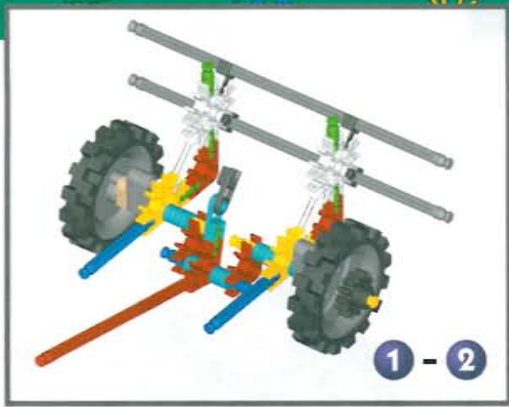

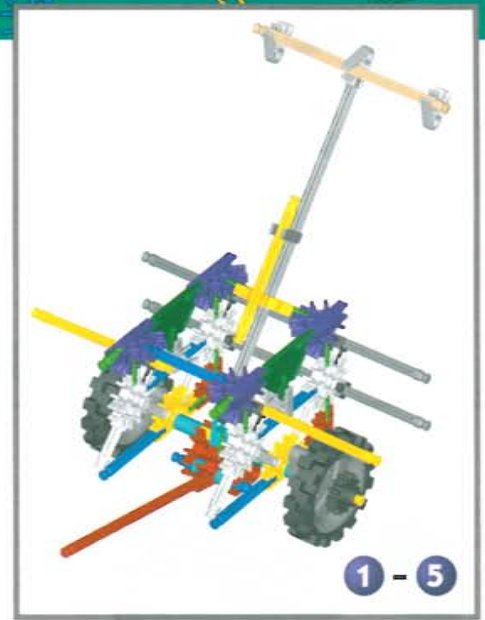
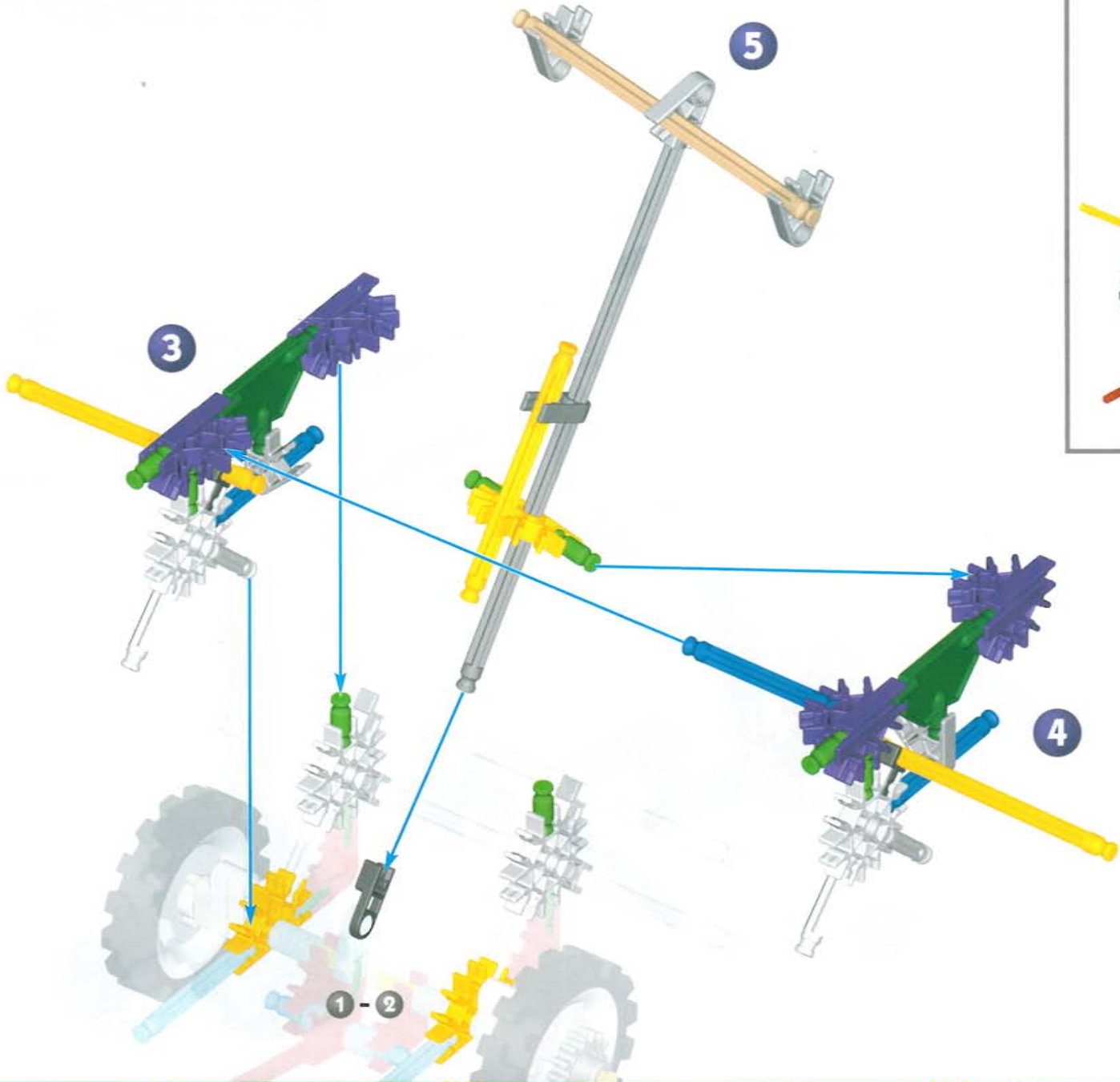

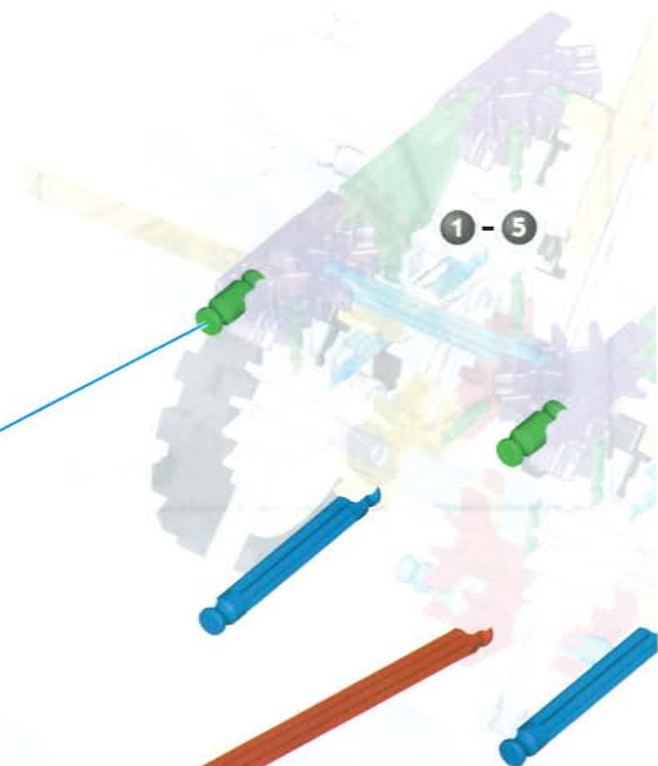
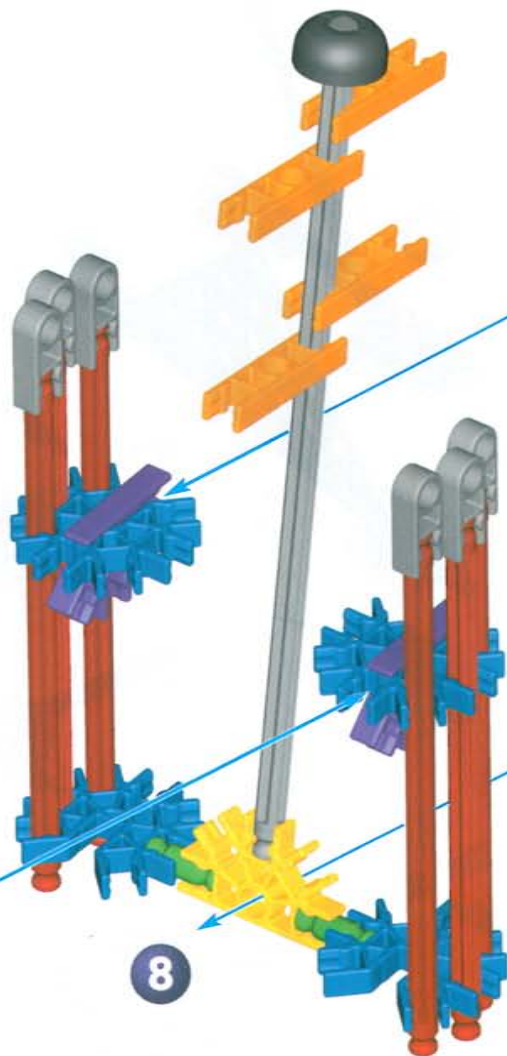
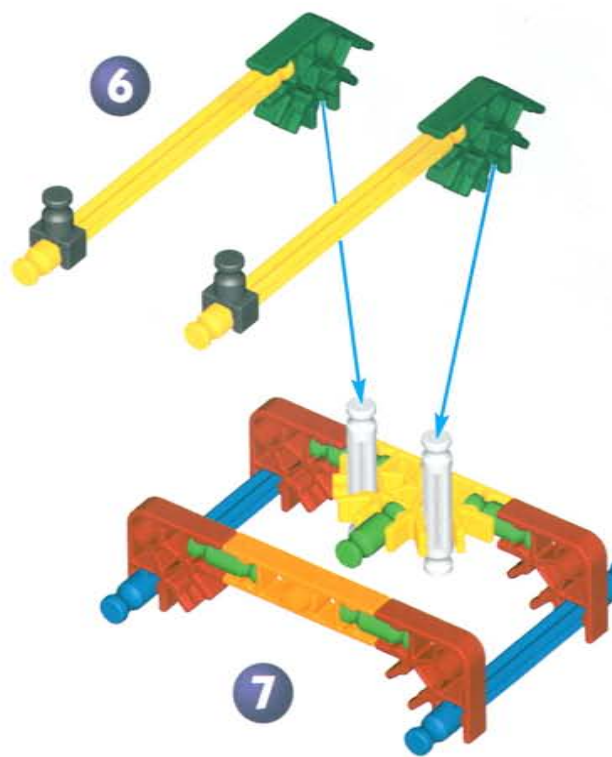

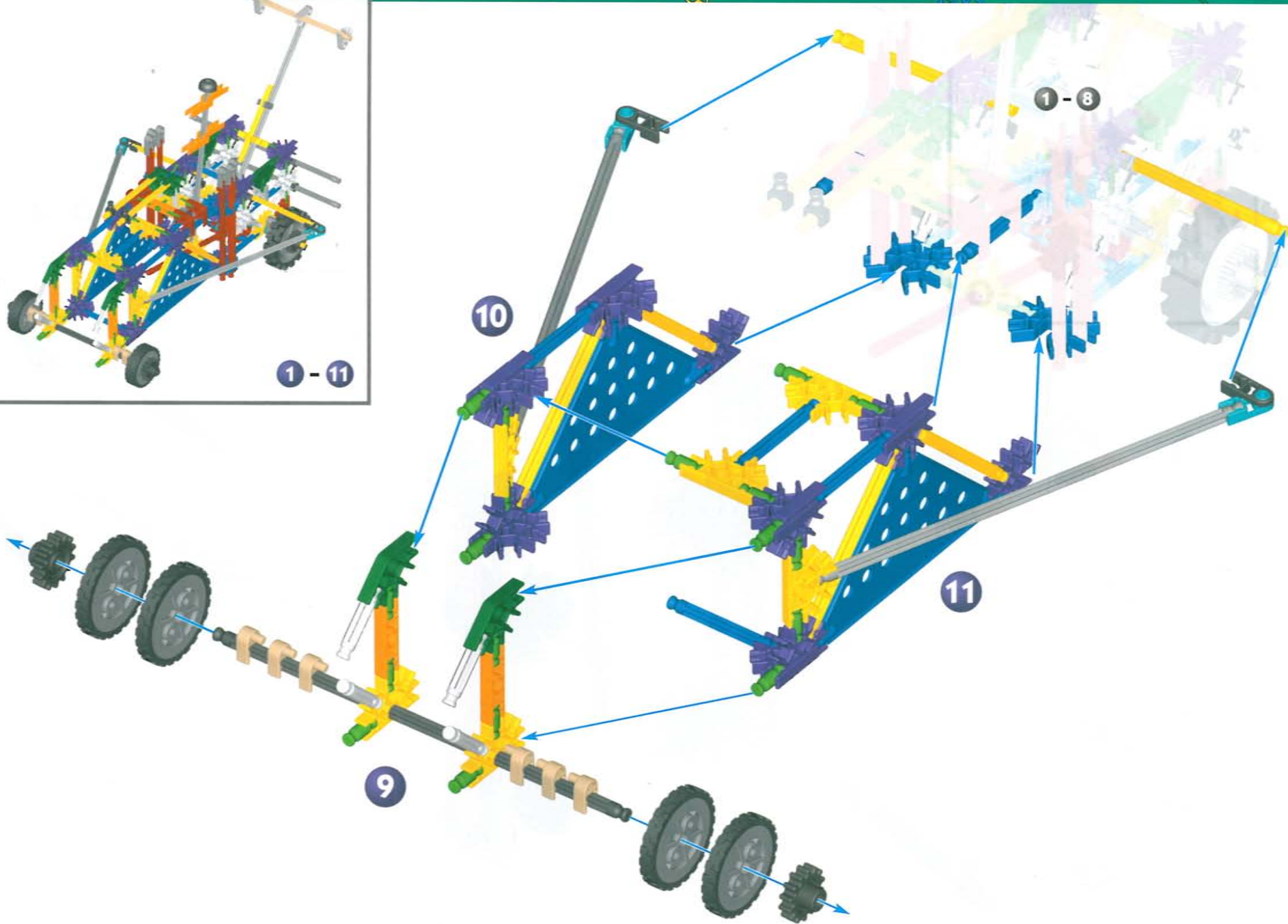

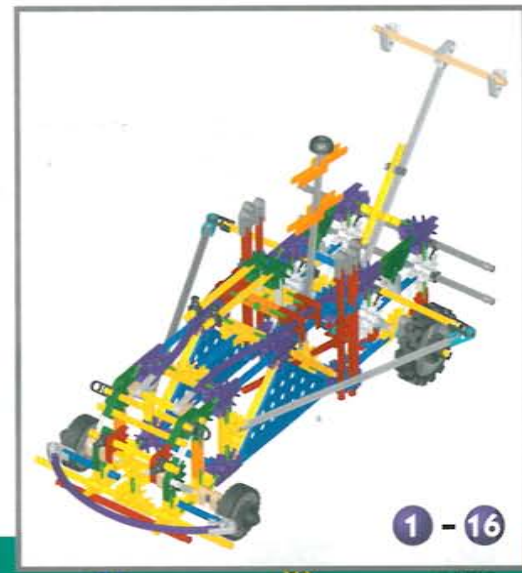
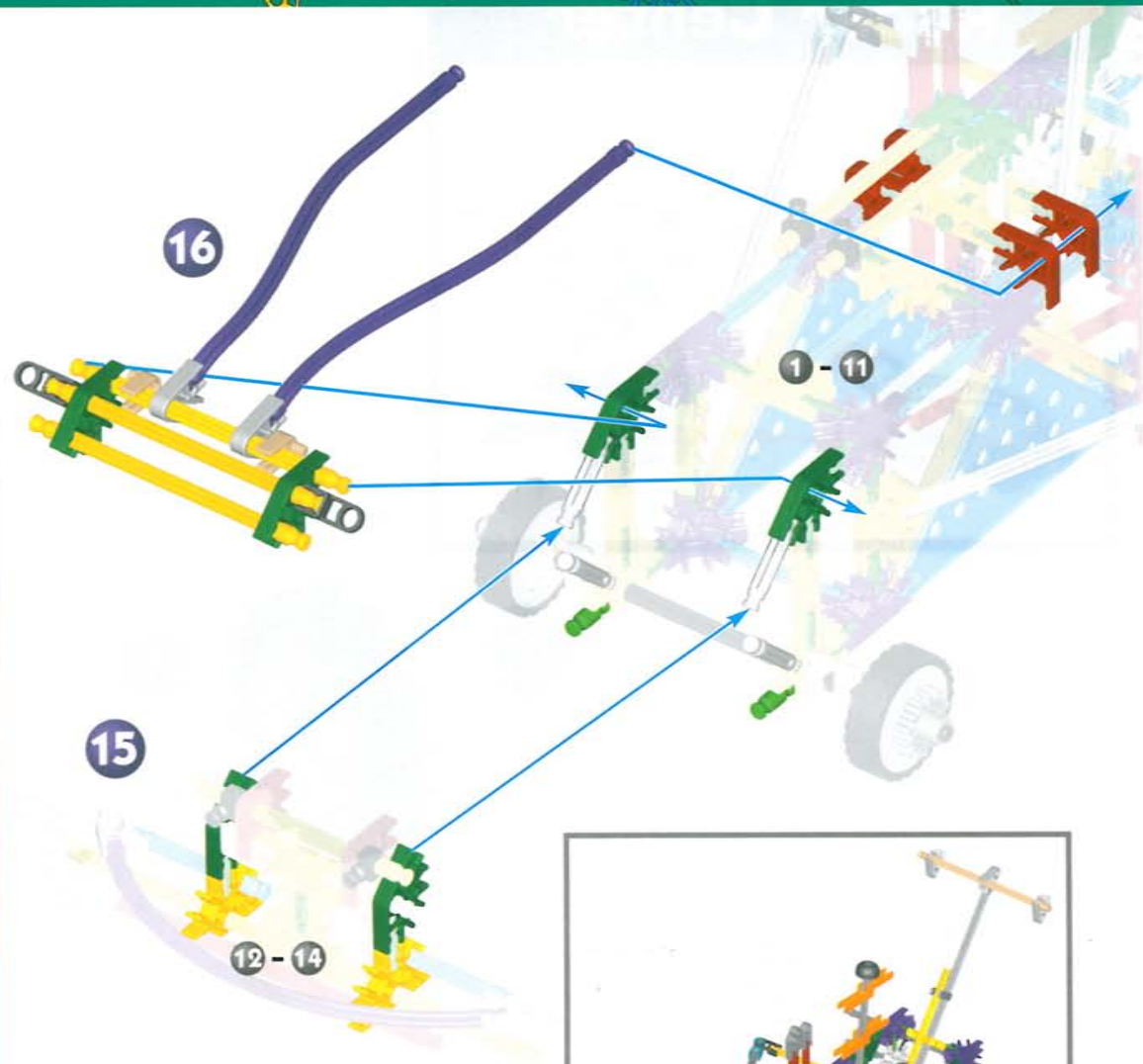
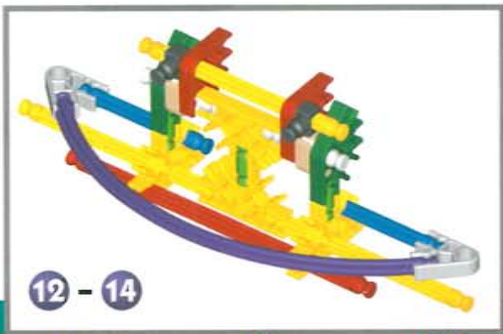
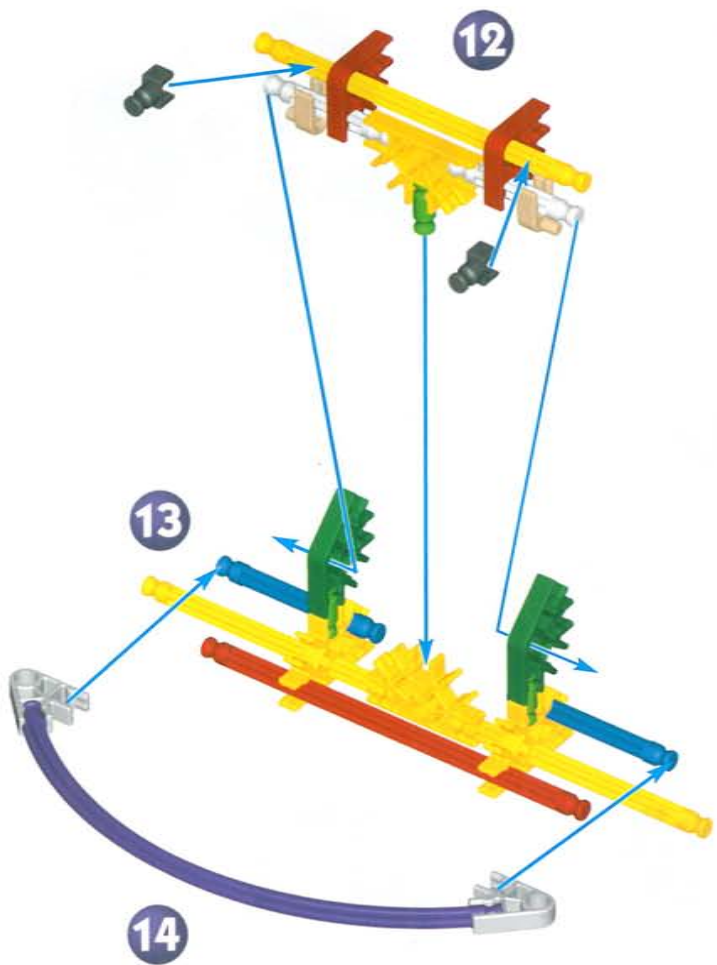

Radar Center

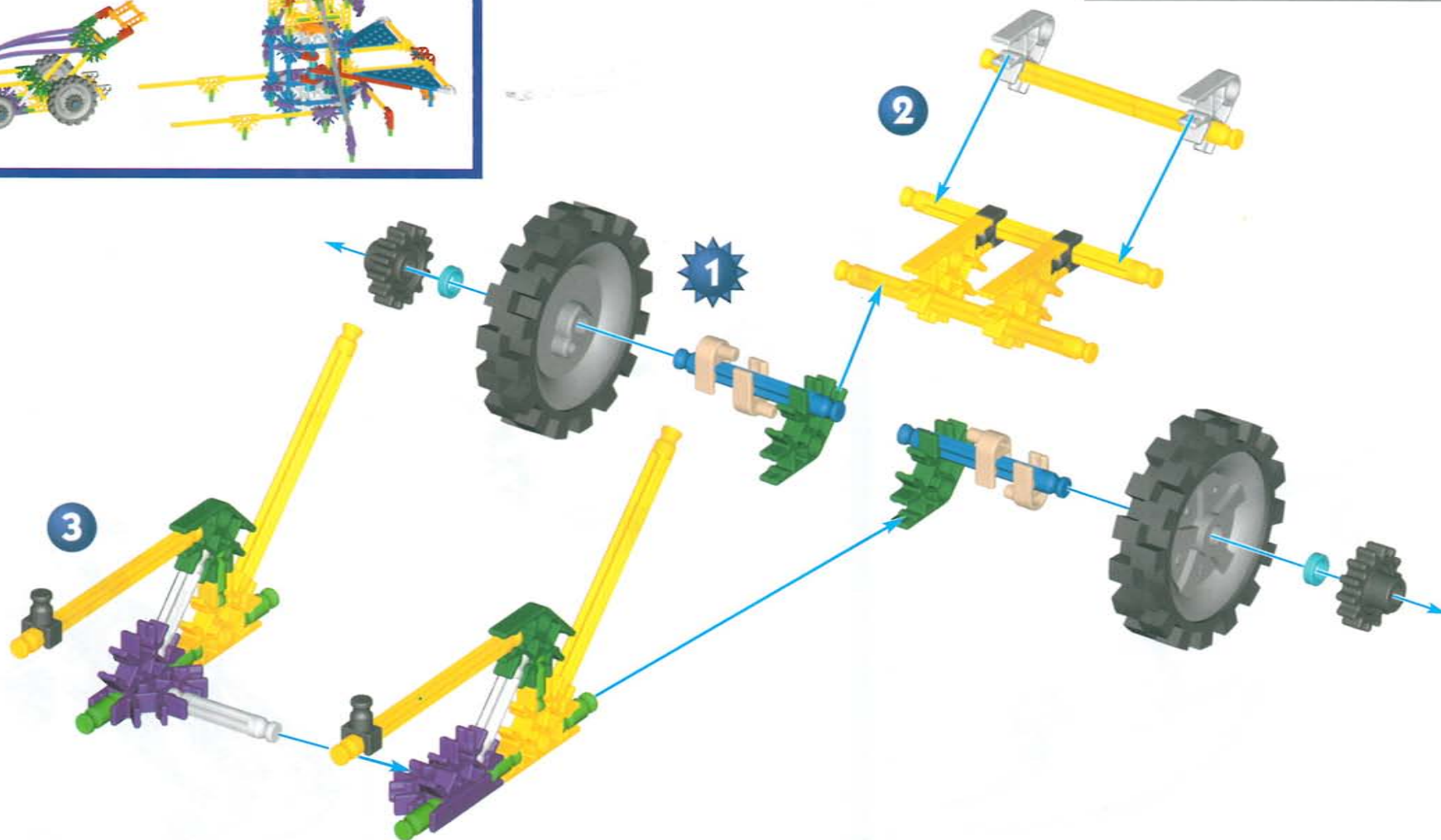
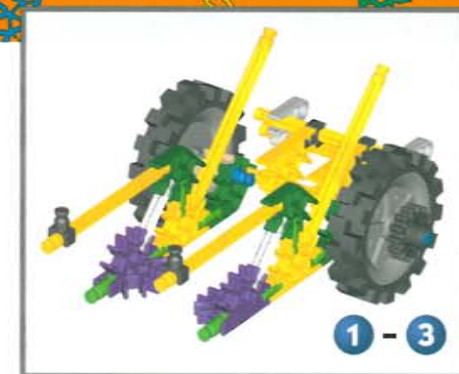
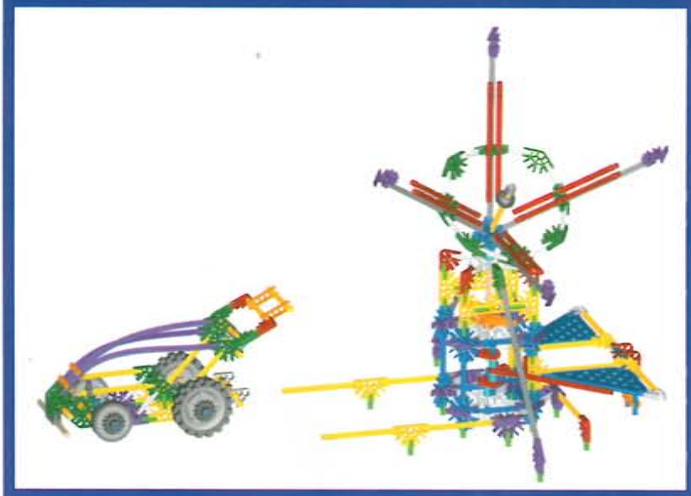

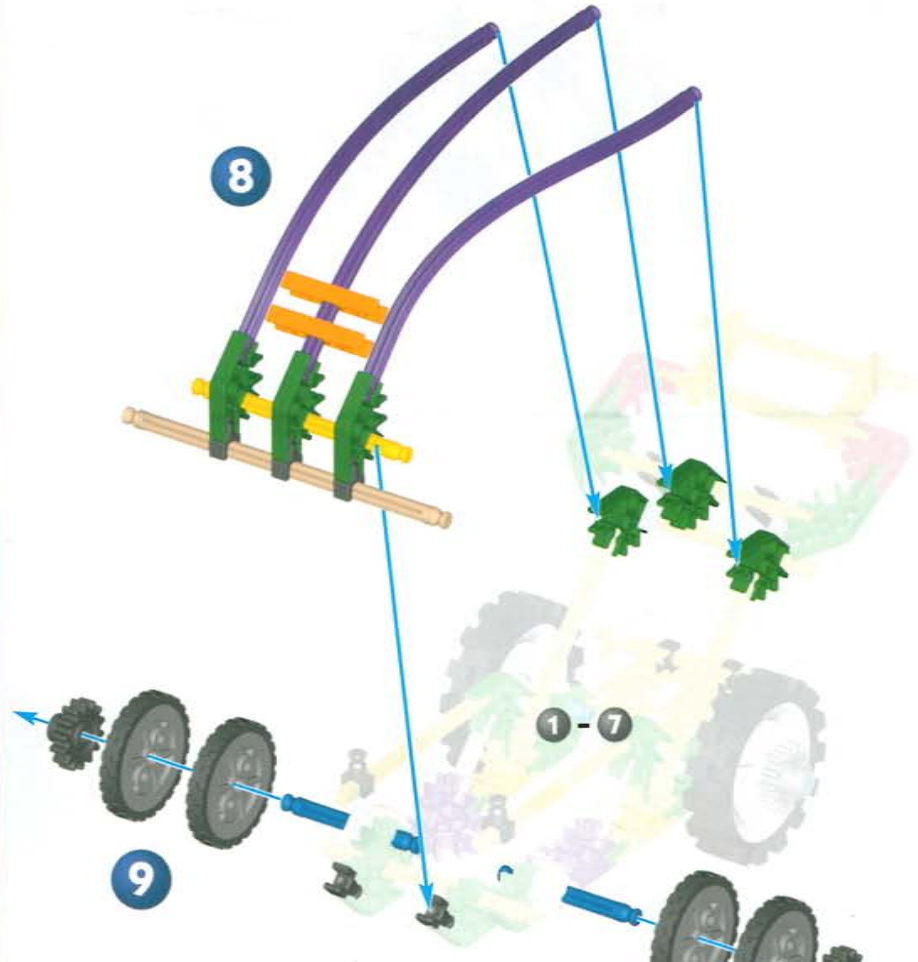

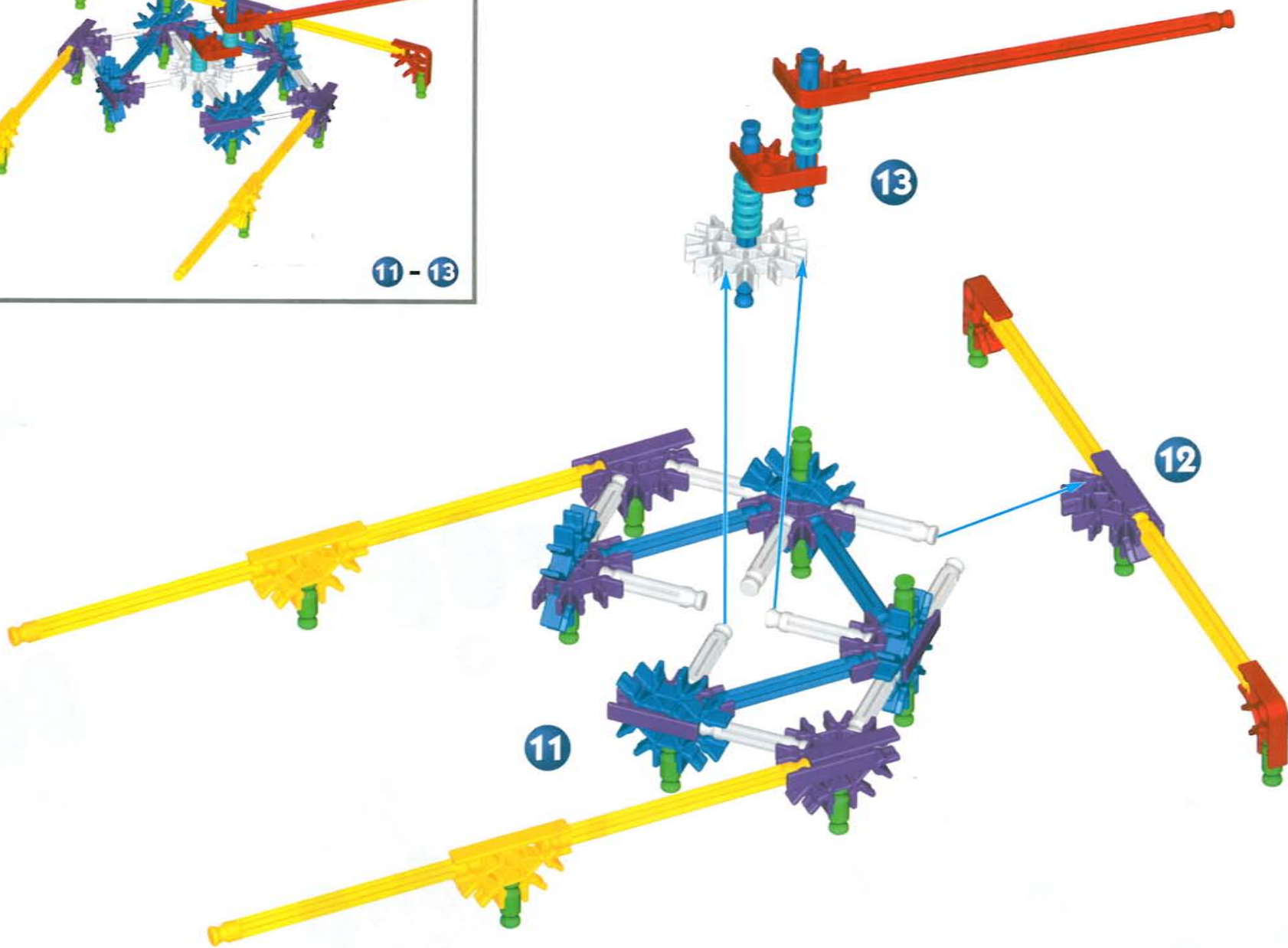
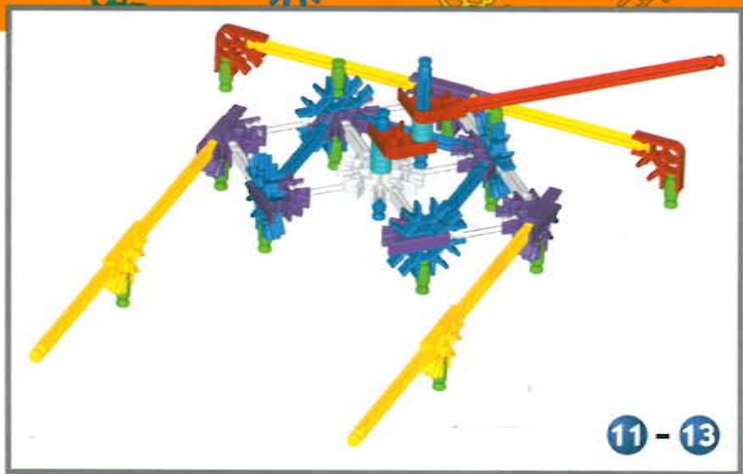

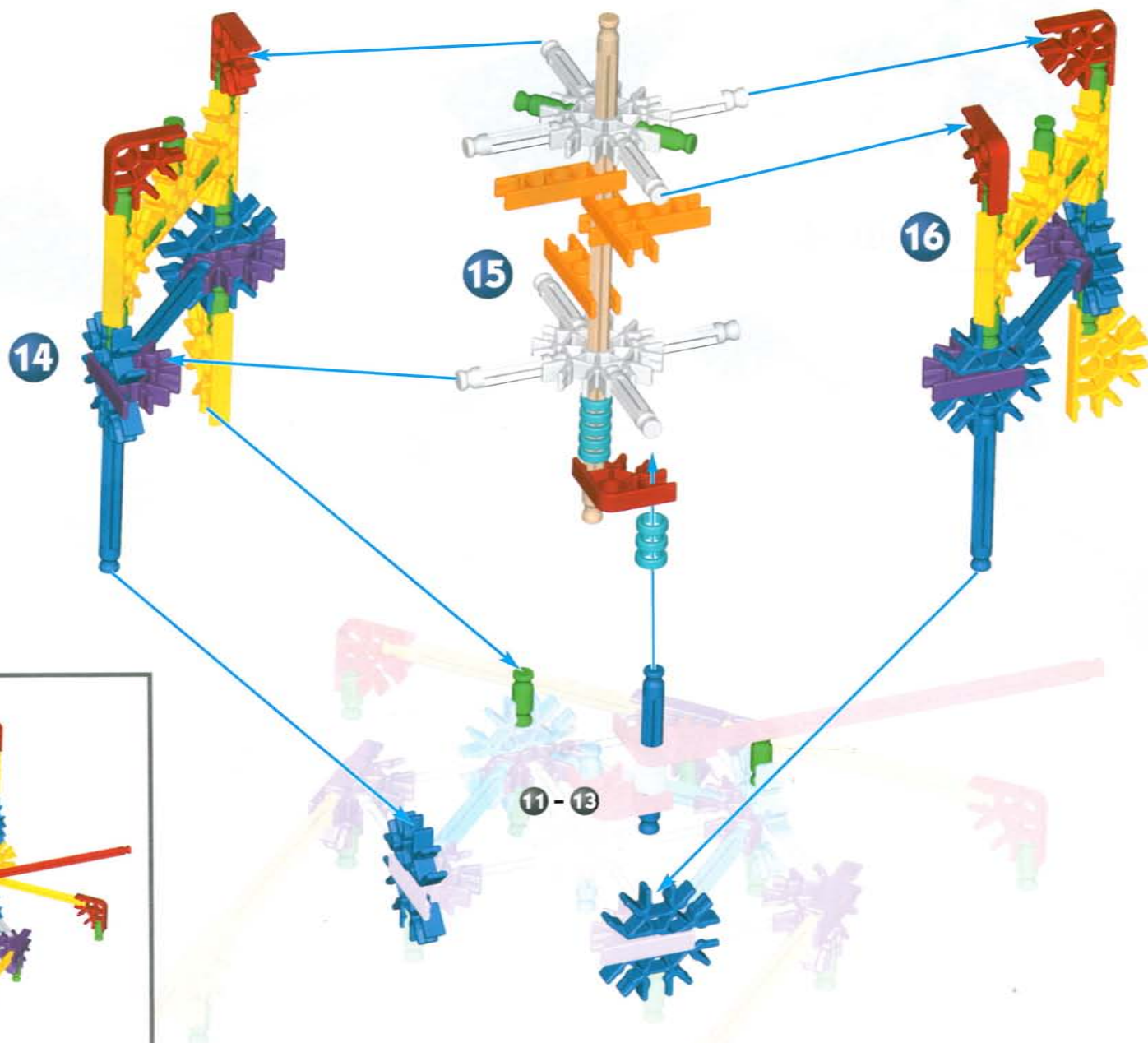

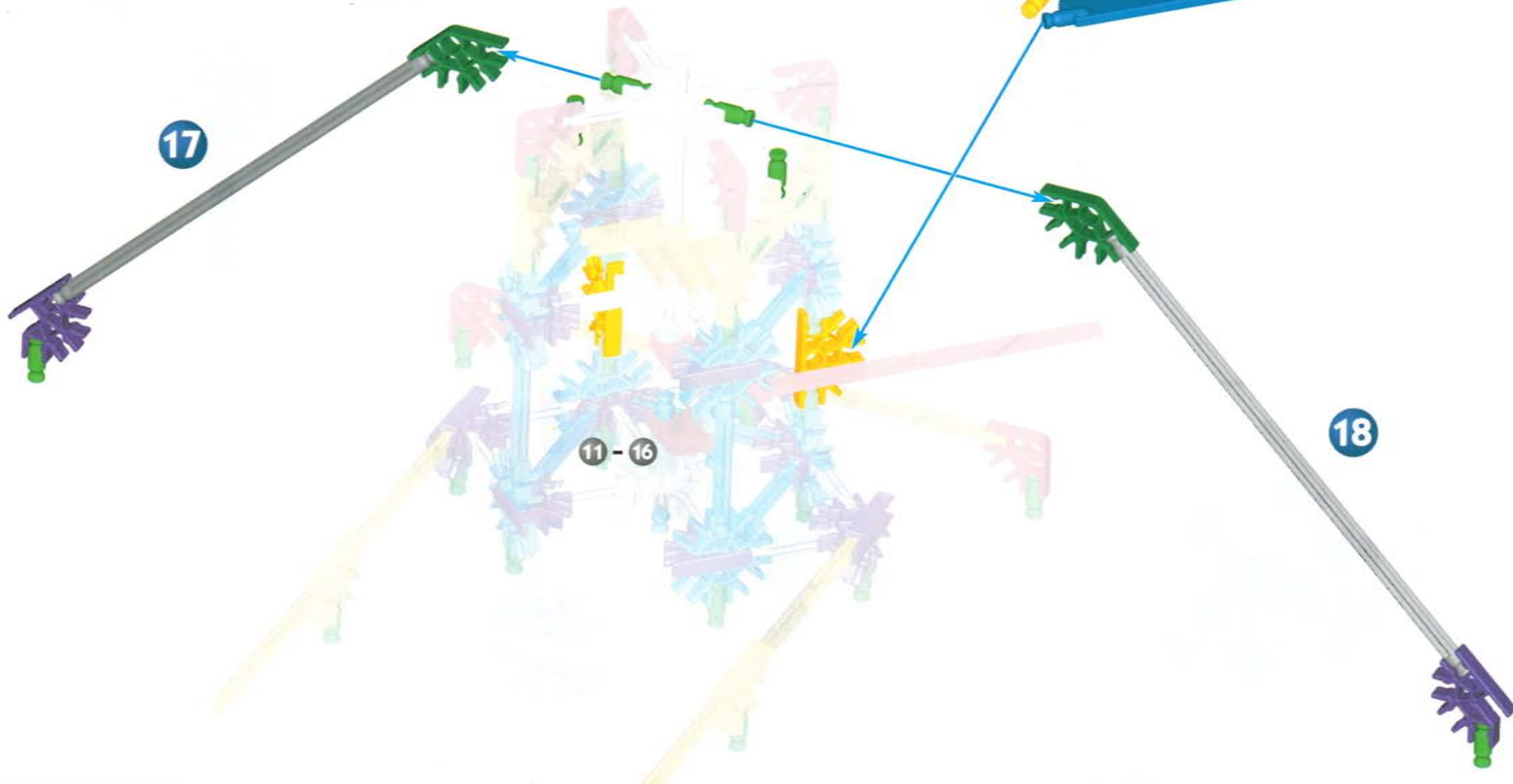
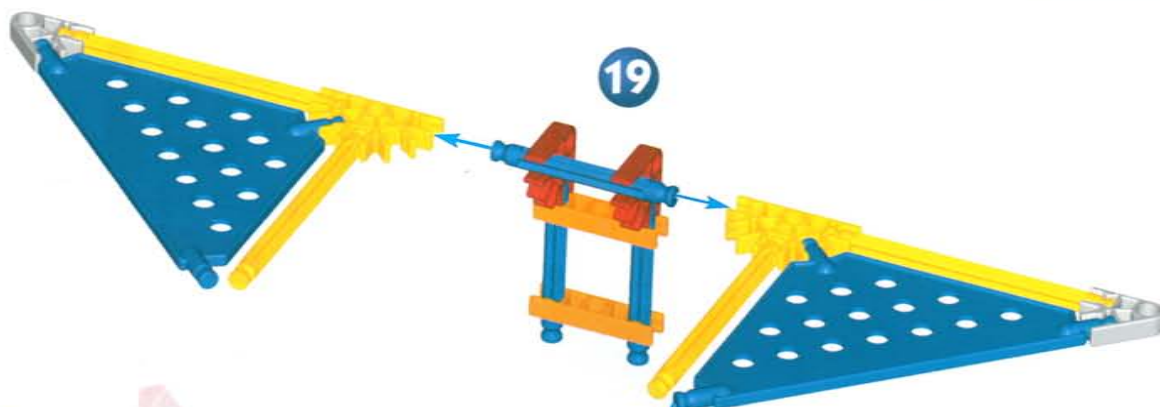

x4

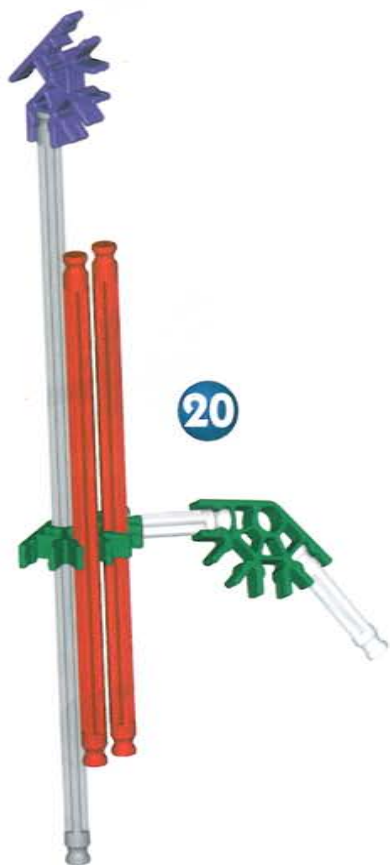

20

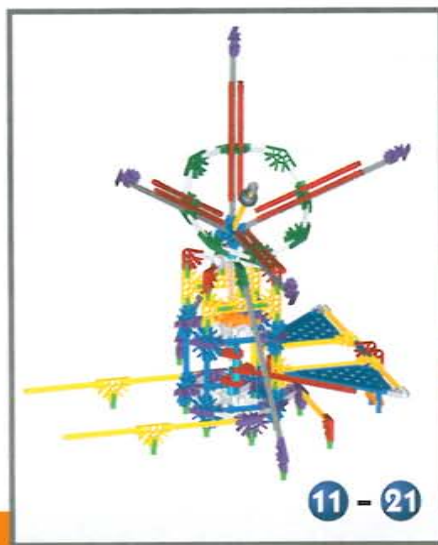

11 - 21

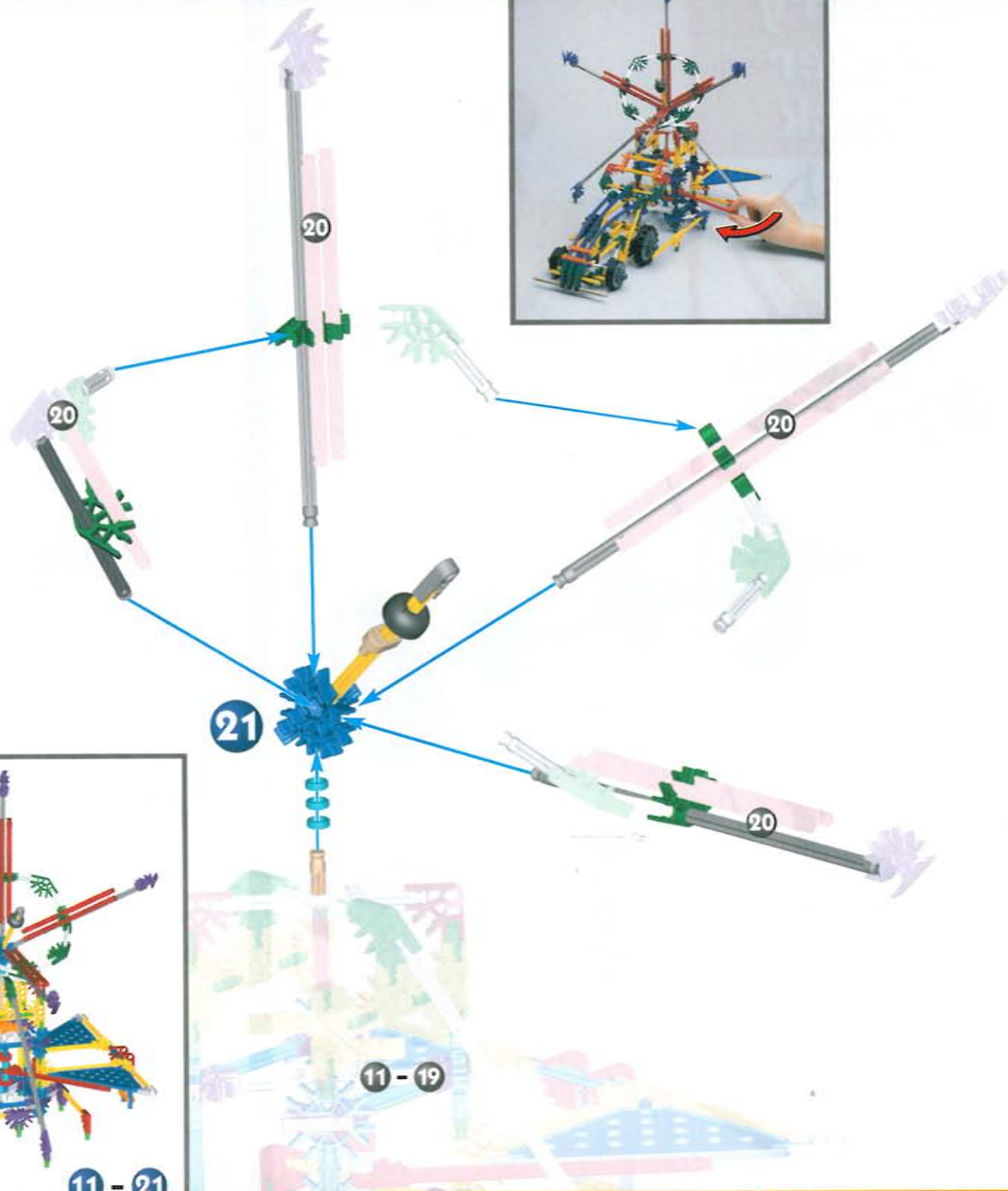

21

20

20

20

20

11 - 19

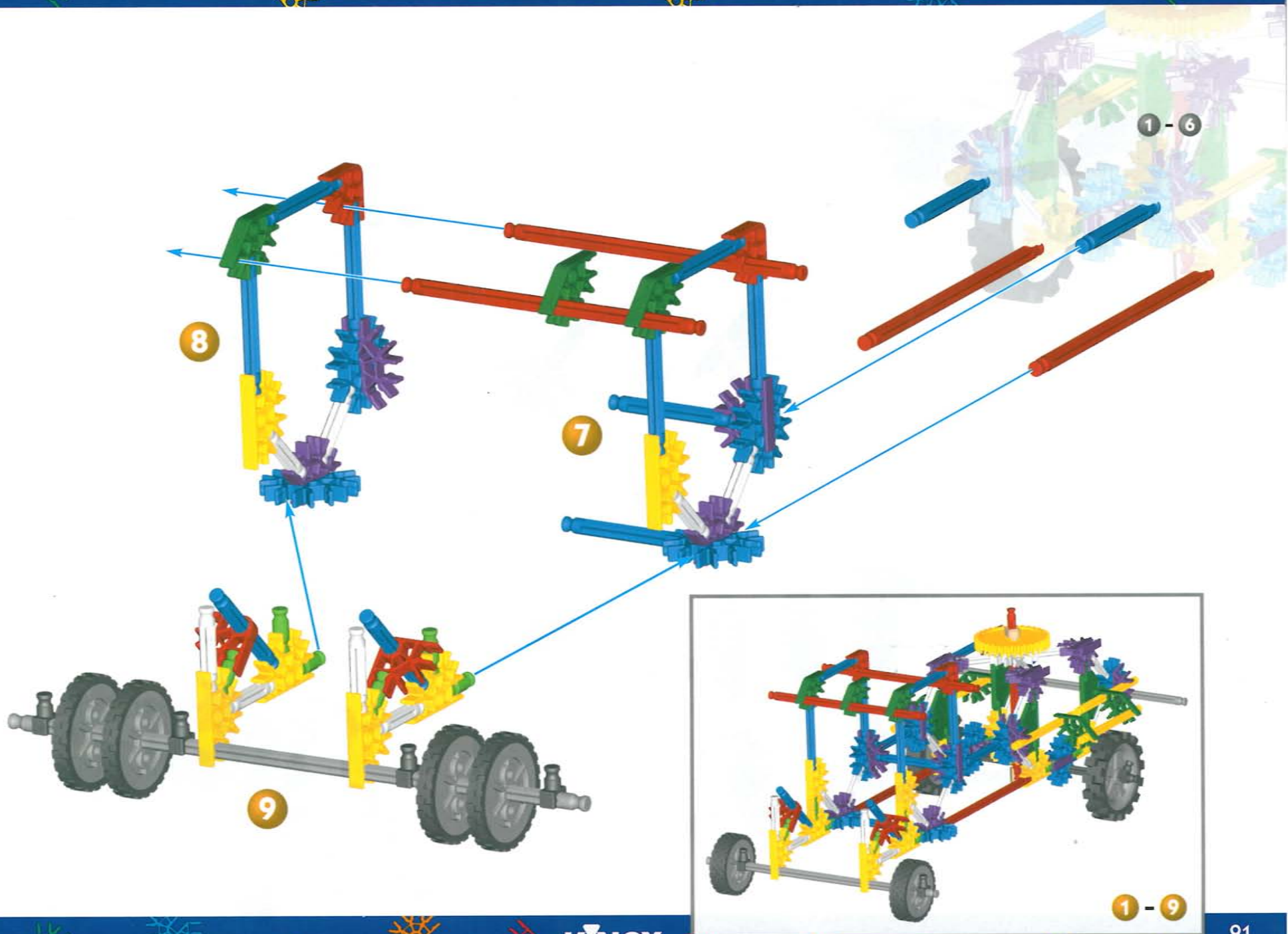

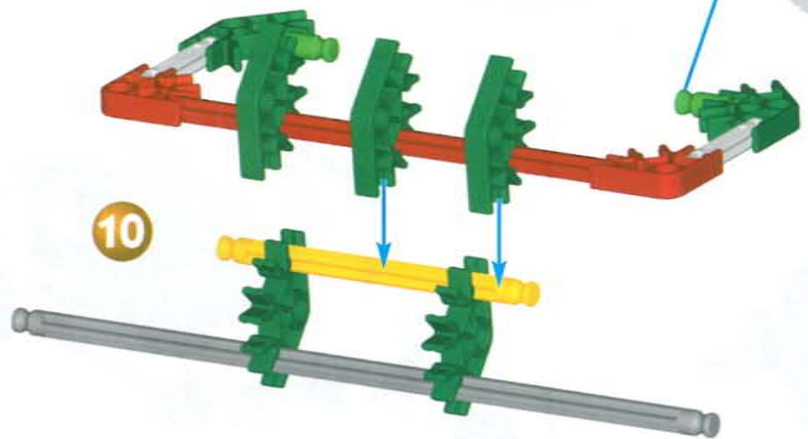
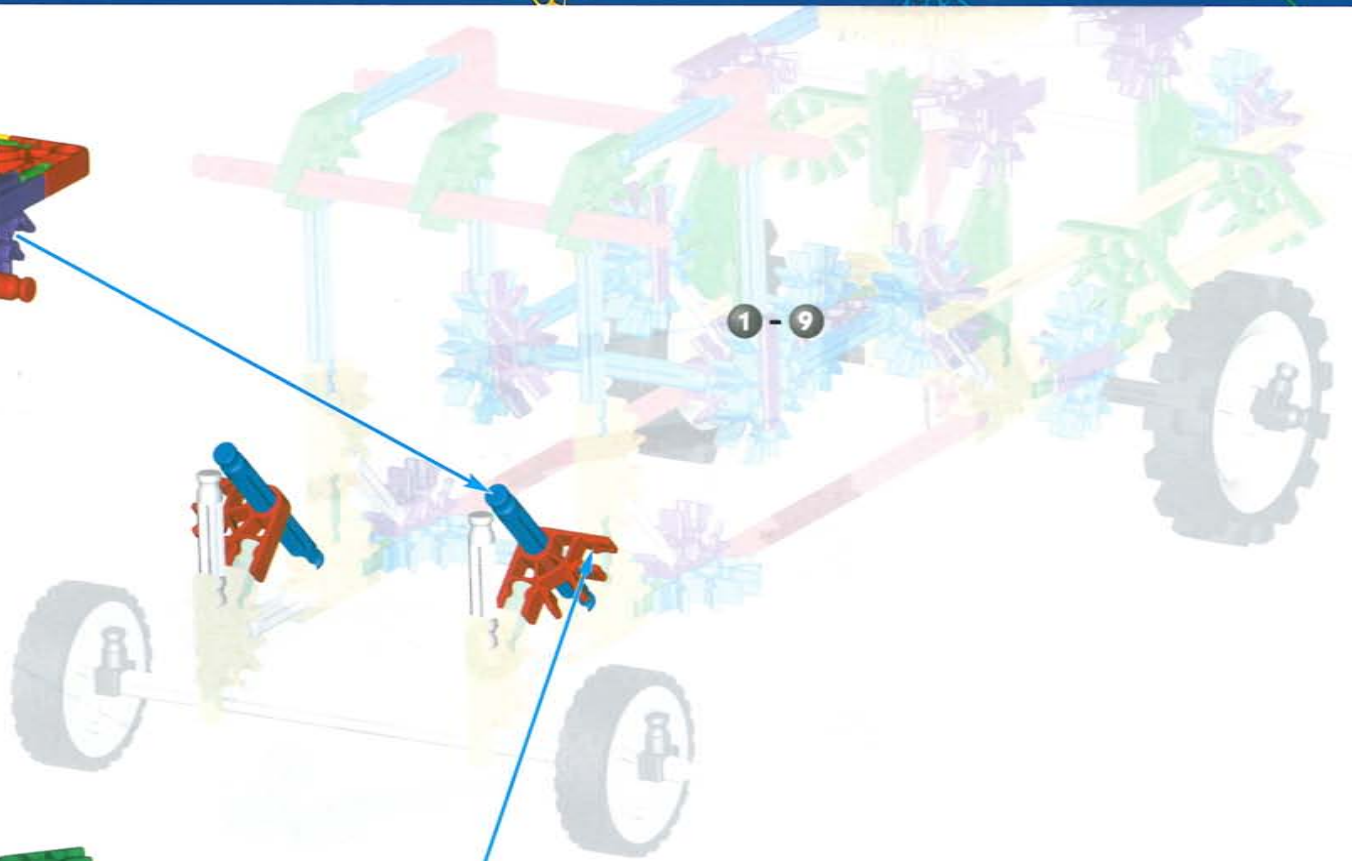
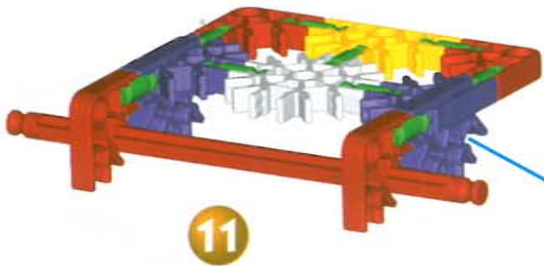

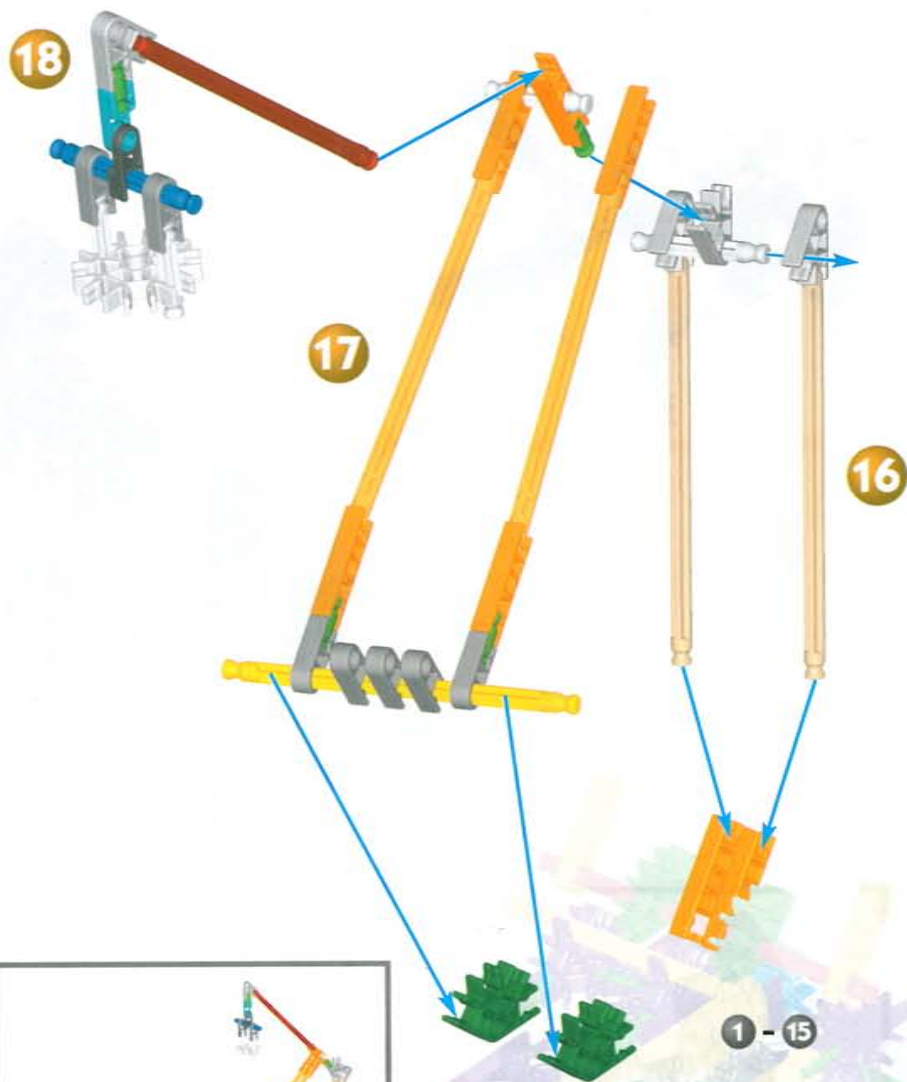
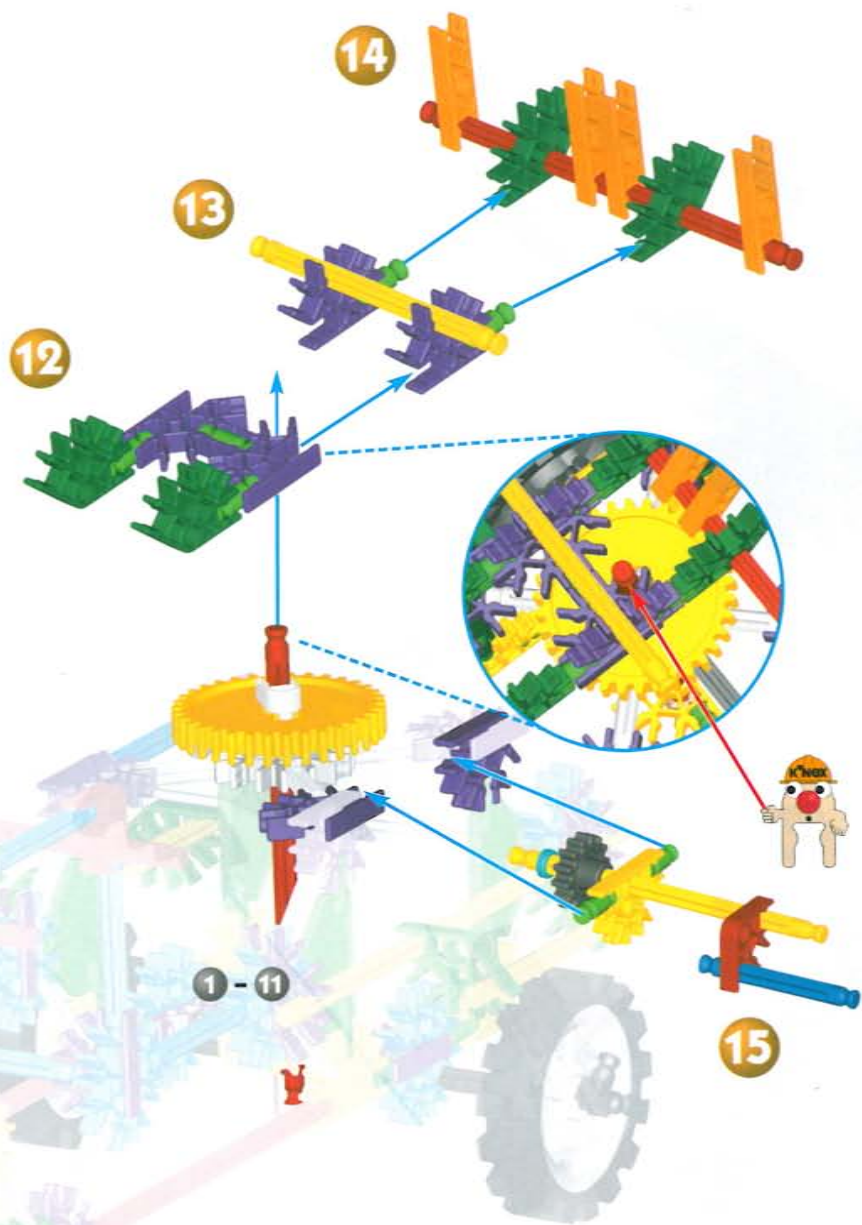

Dragon

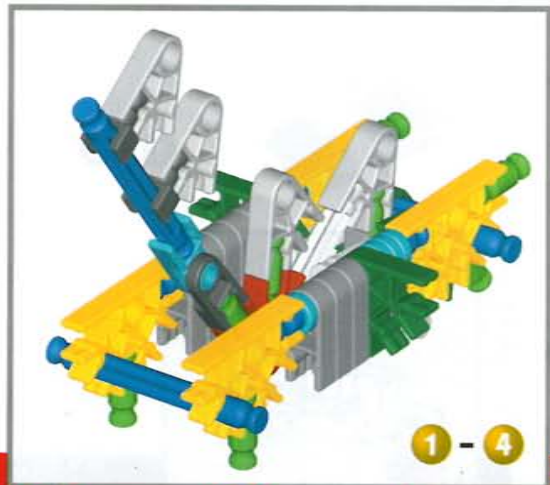
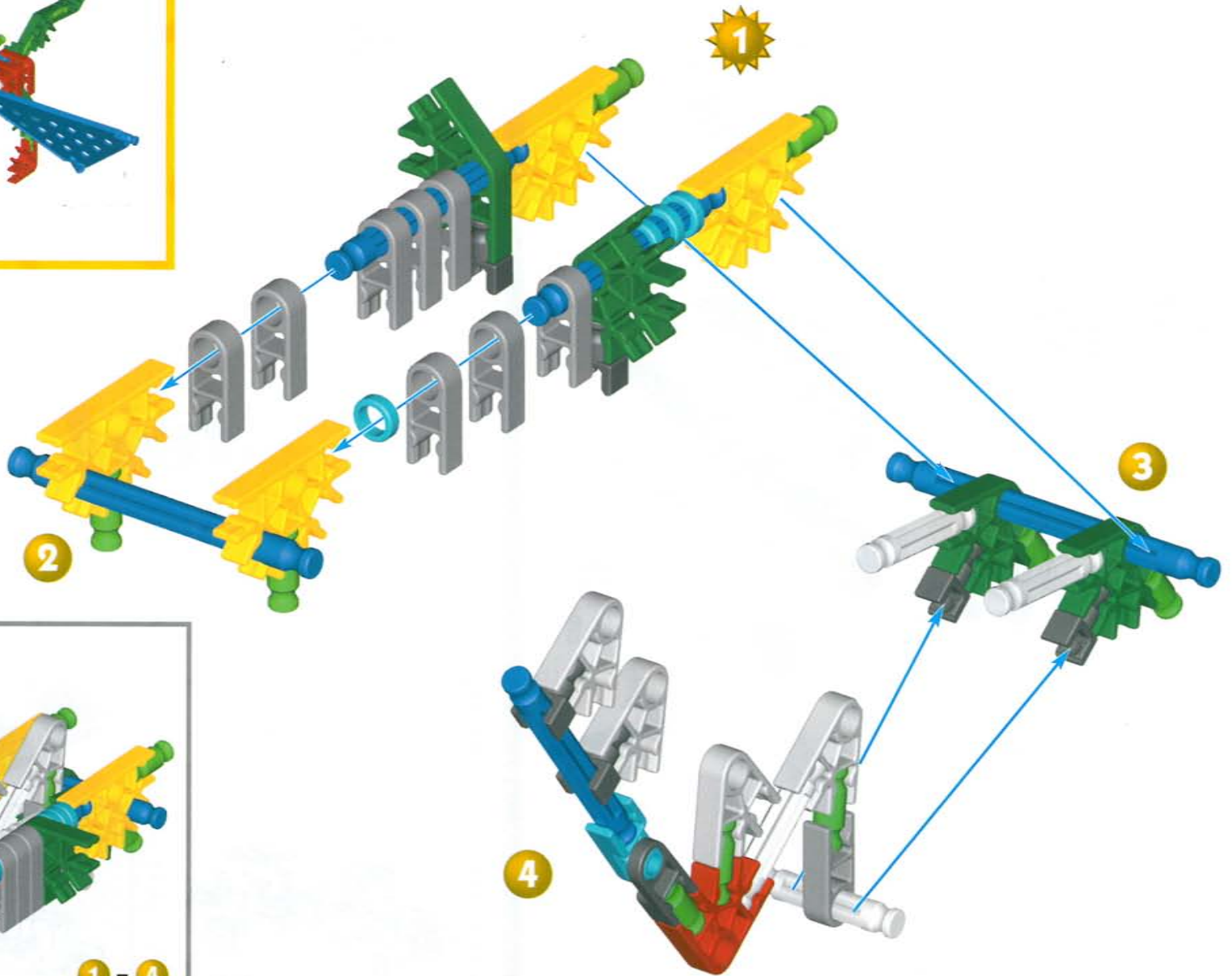

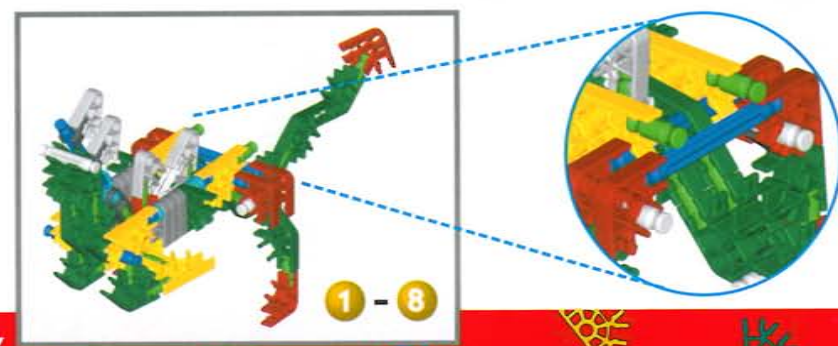
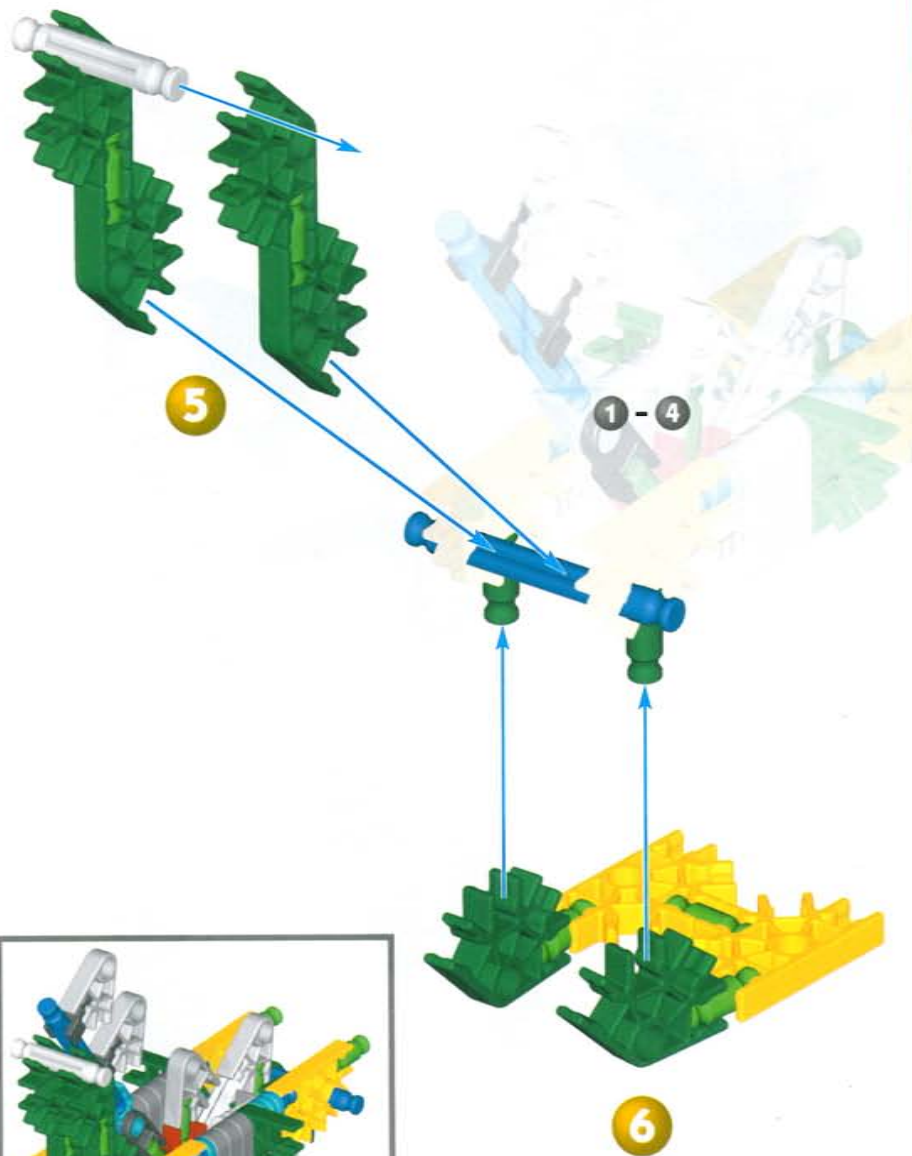

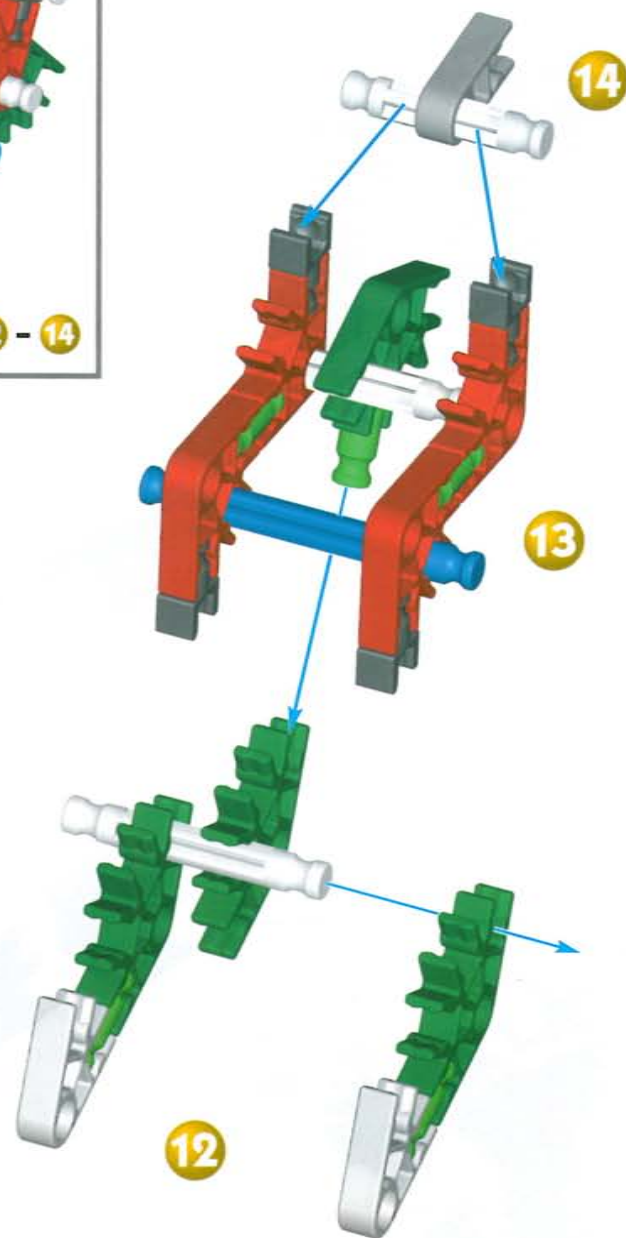
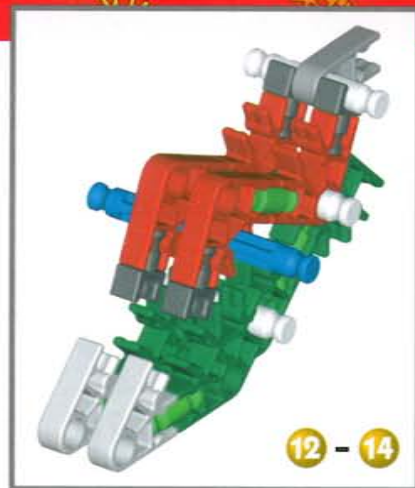
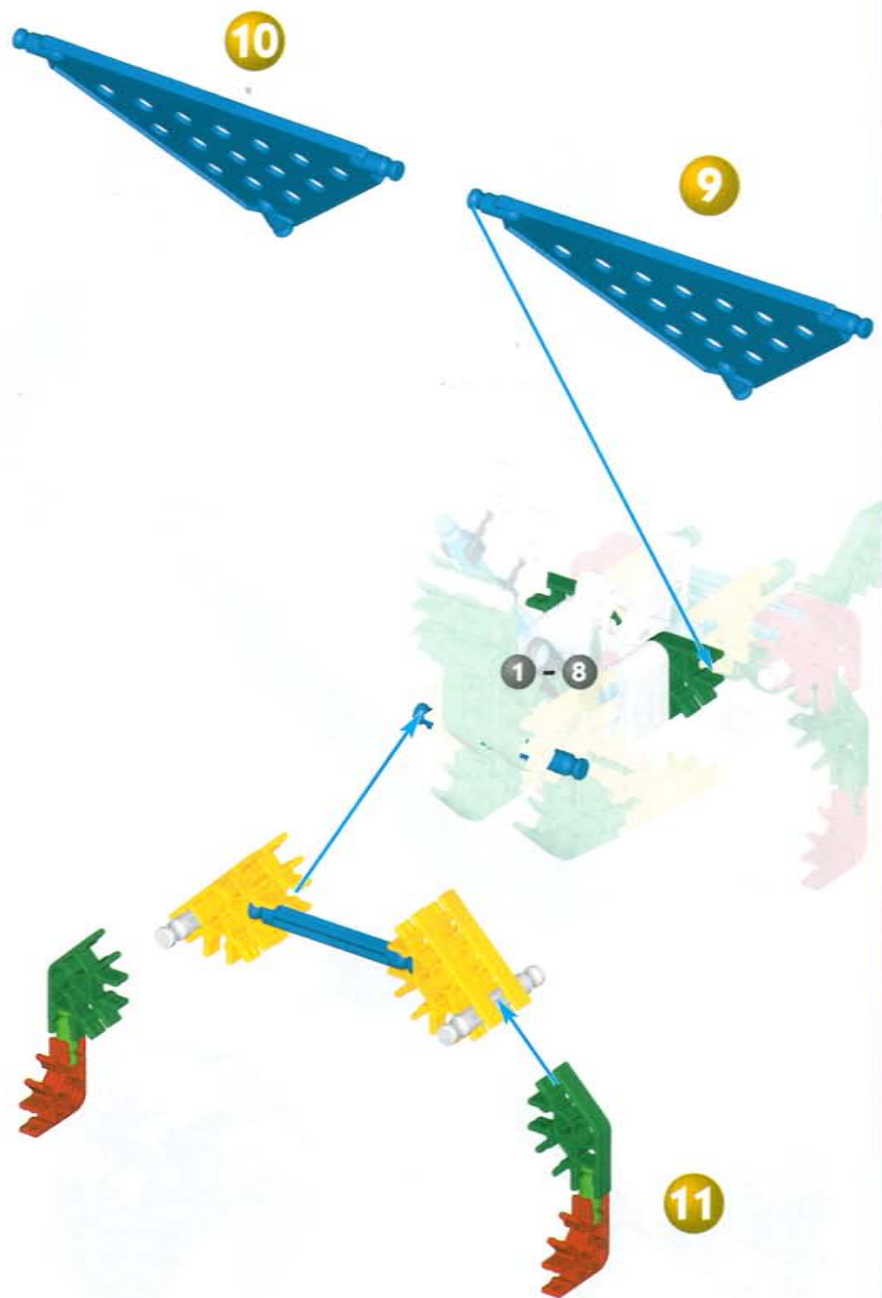

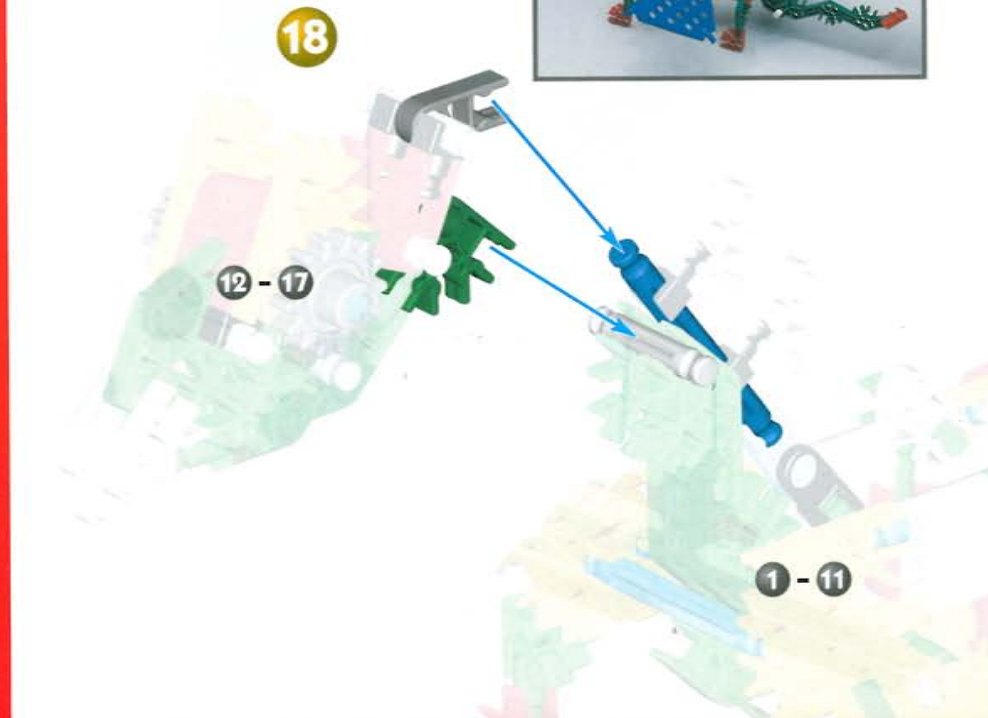
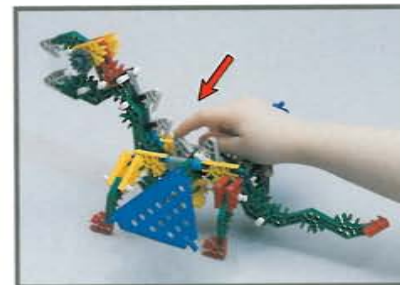
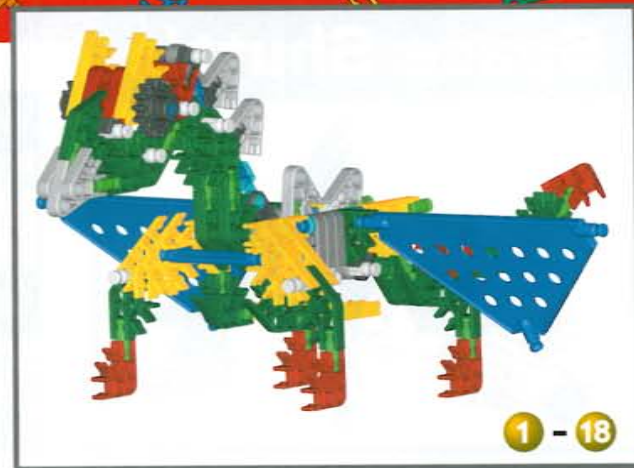
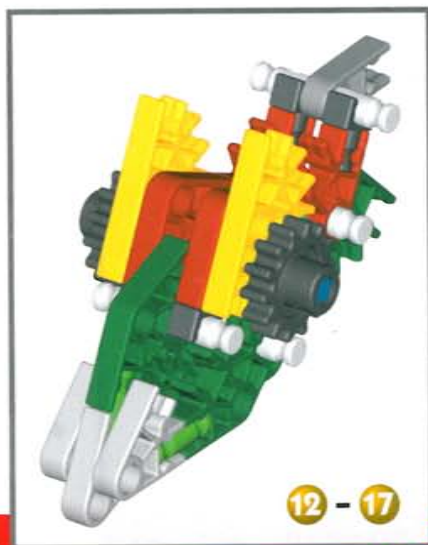
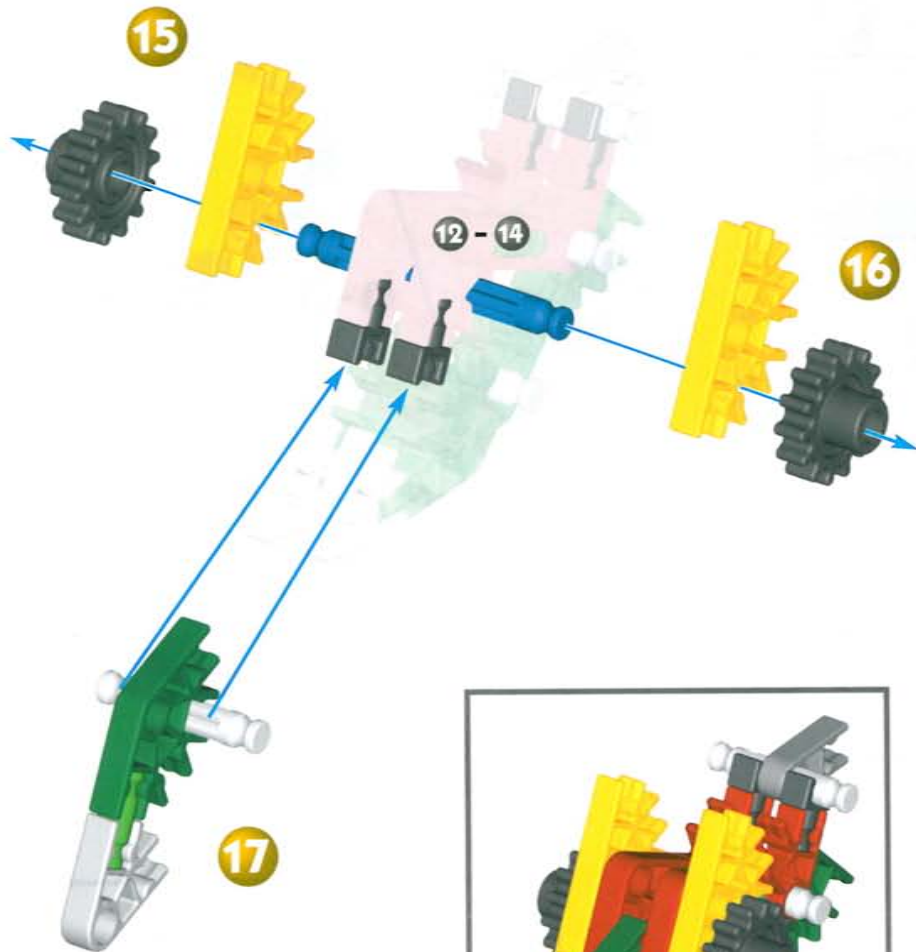

Space Shuttle

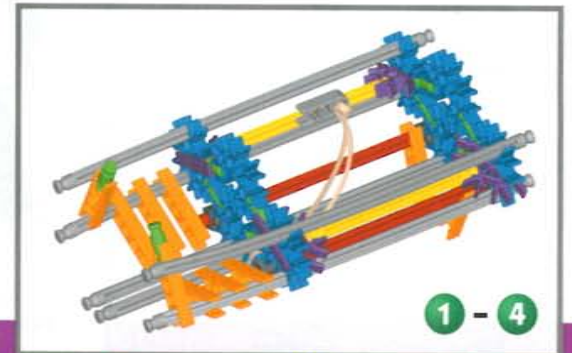
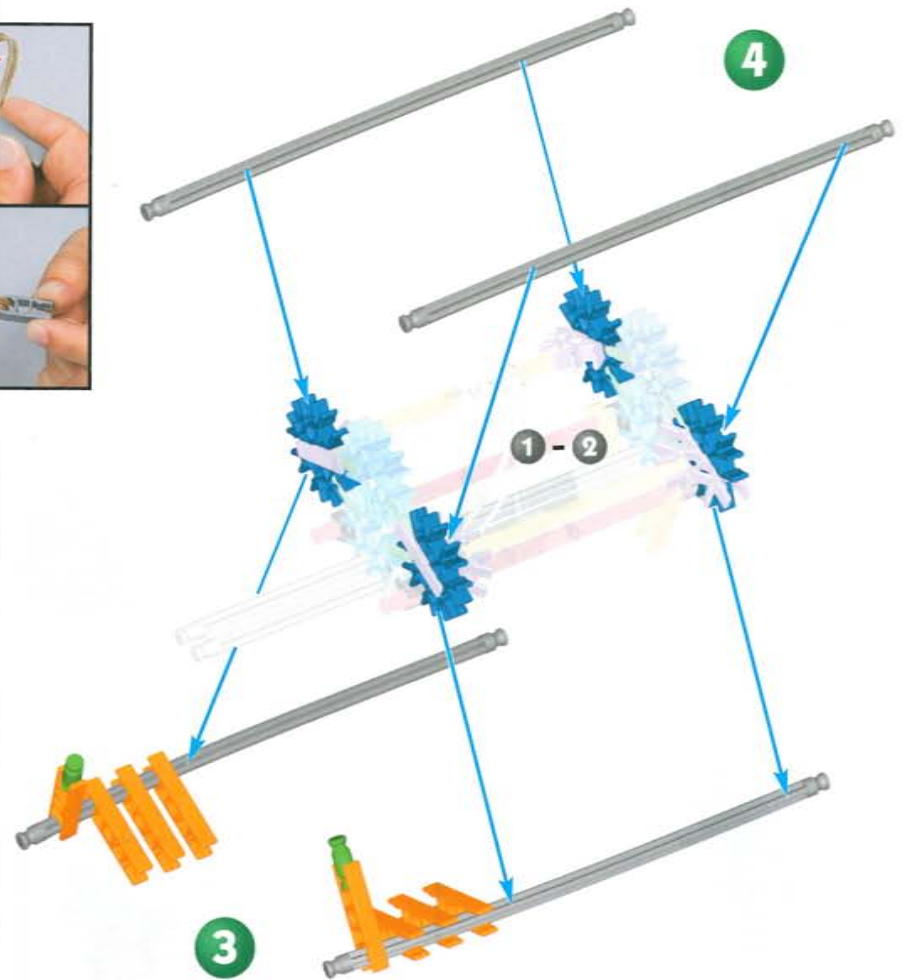
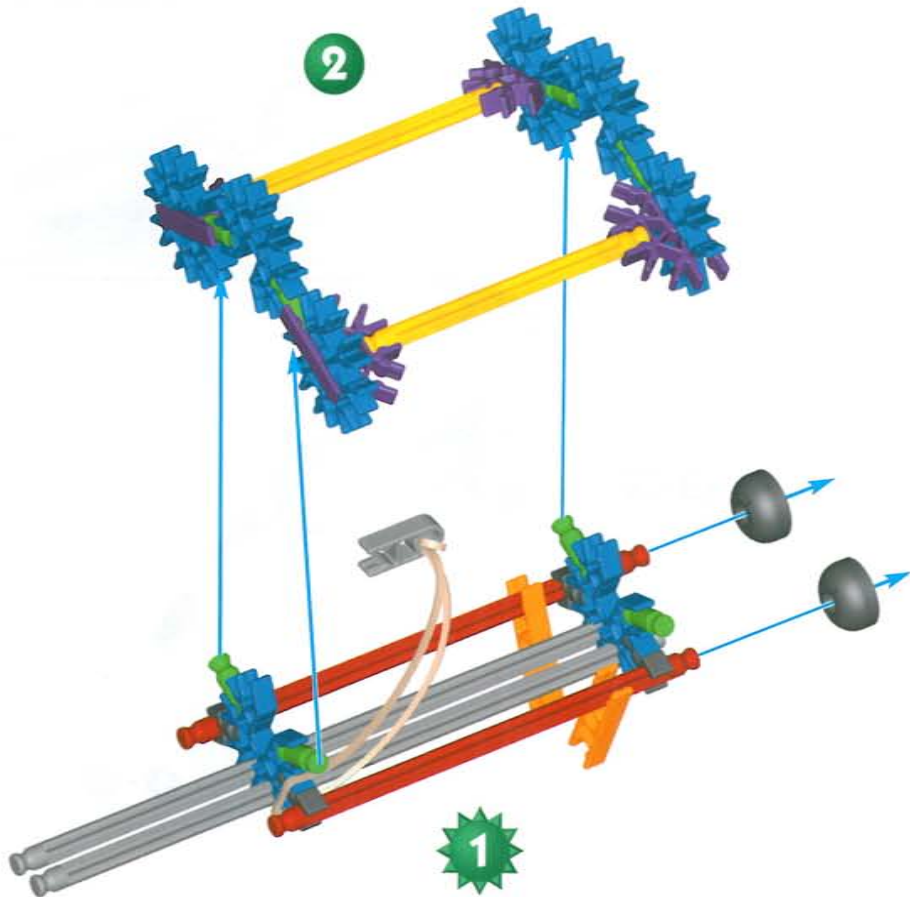
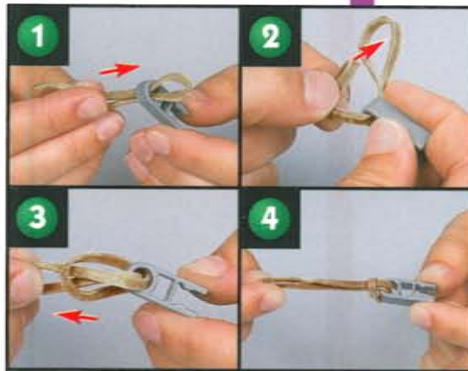
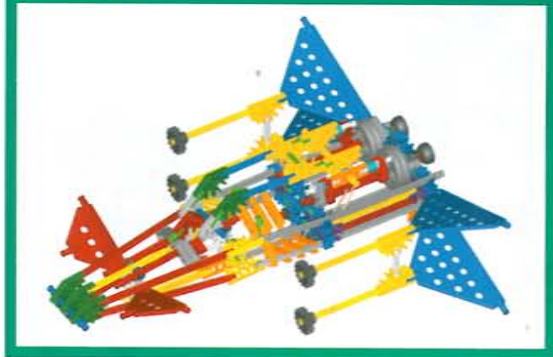

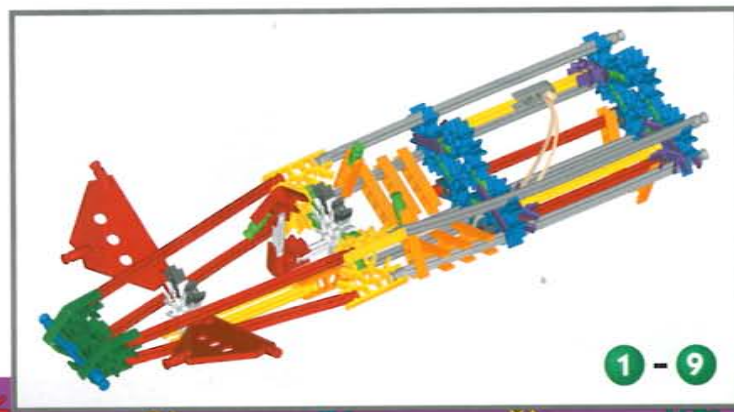
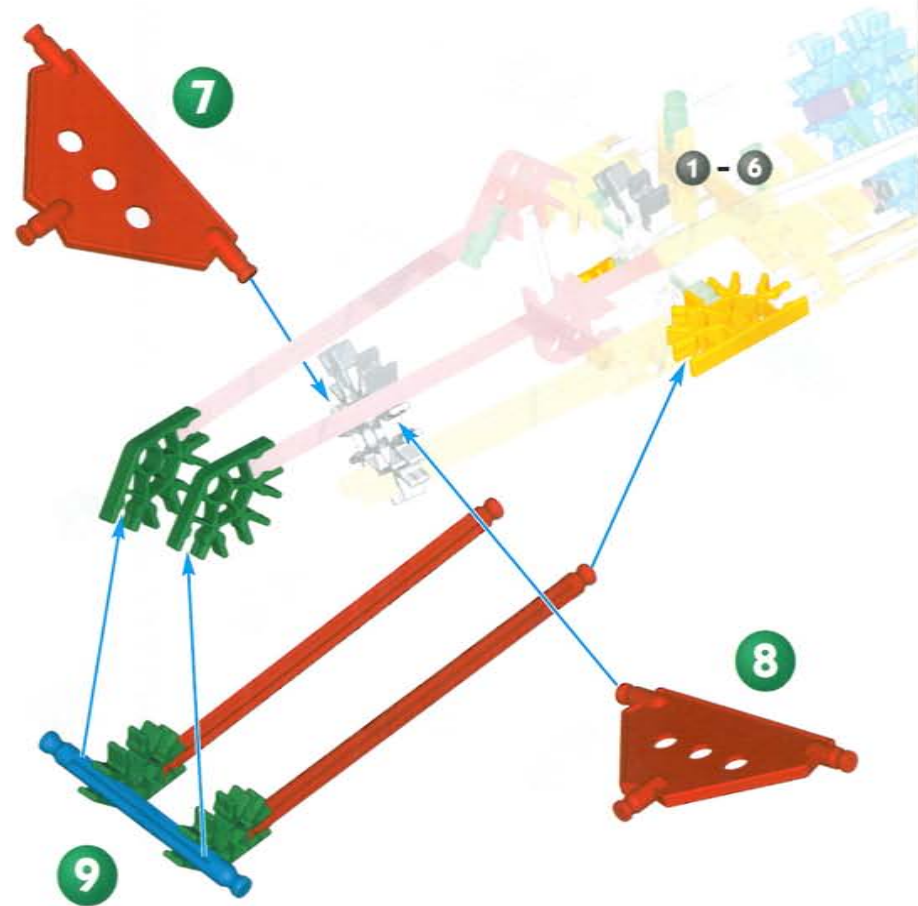
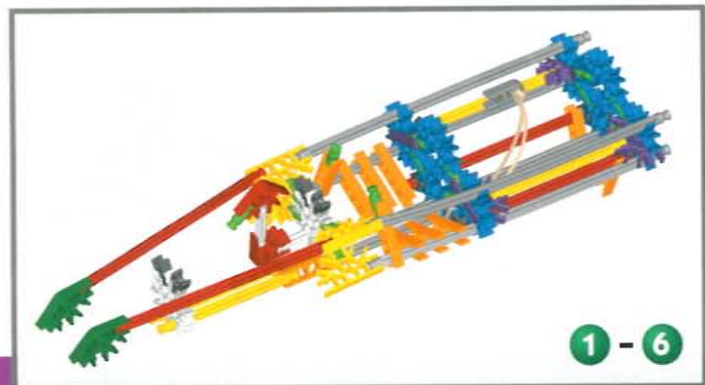
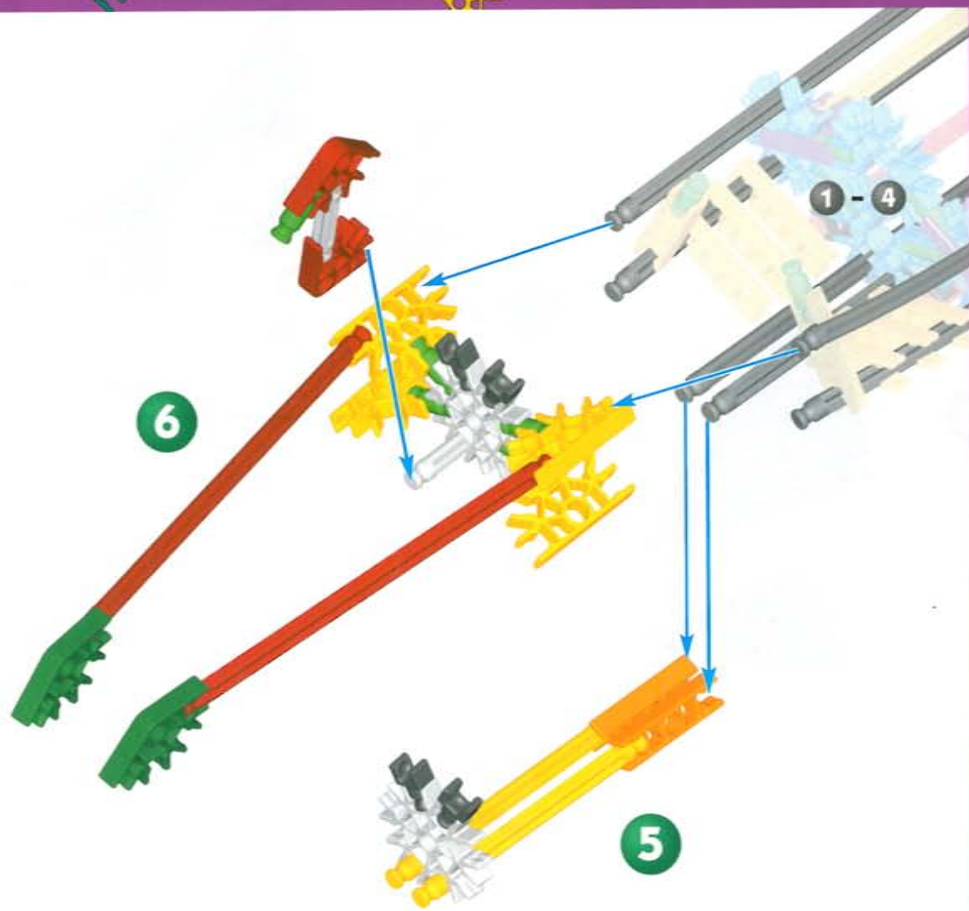

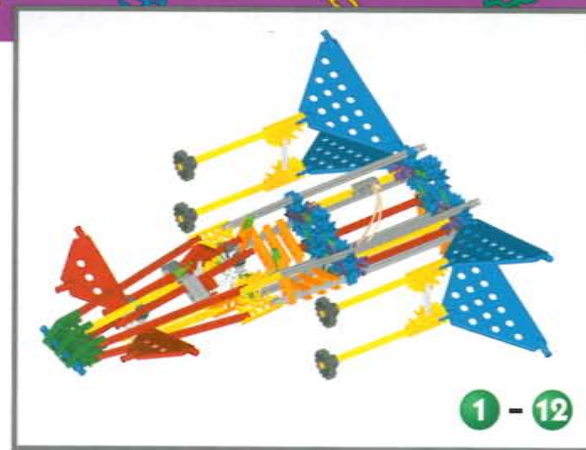
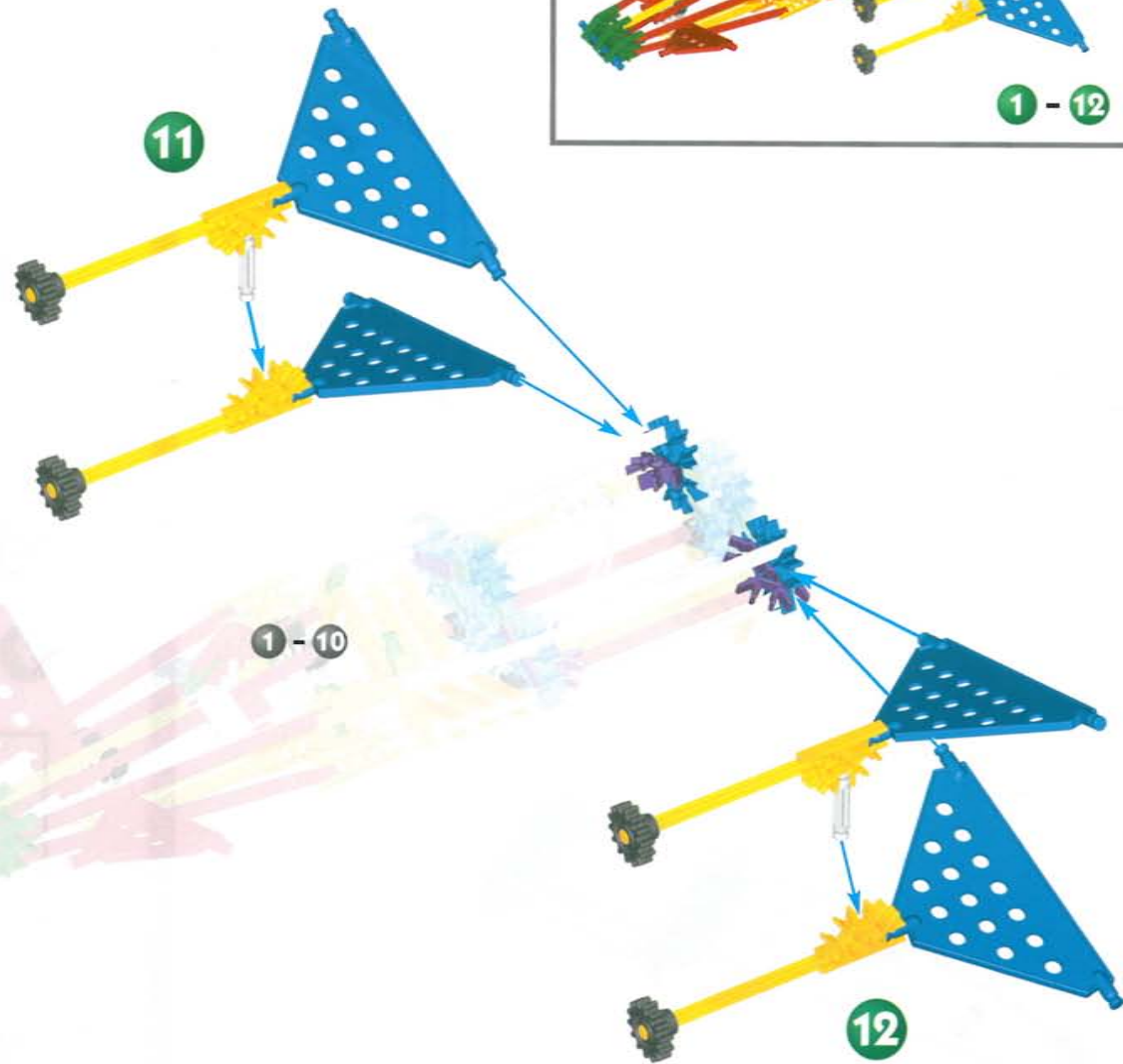
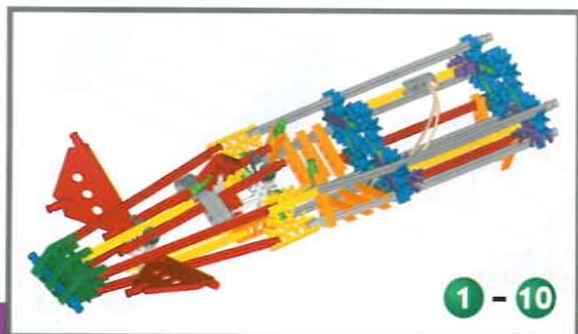

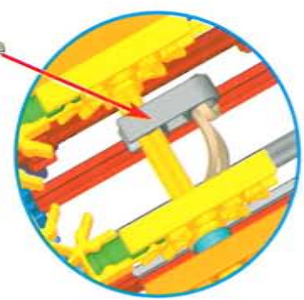
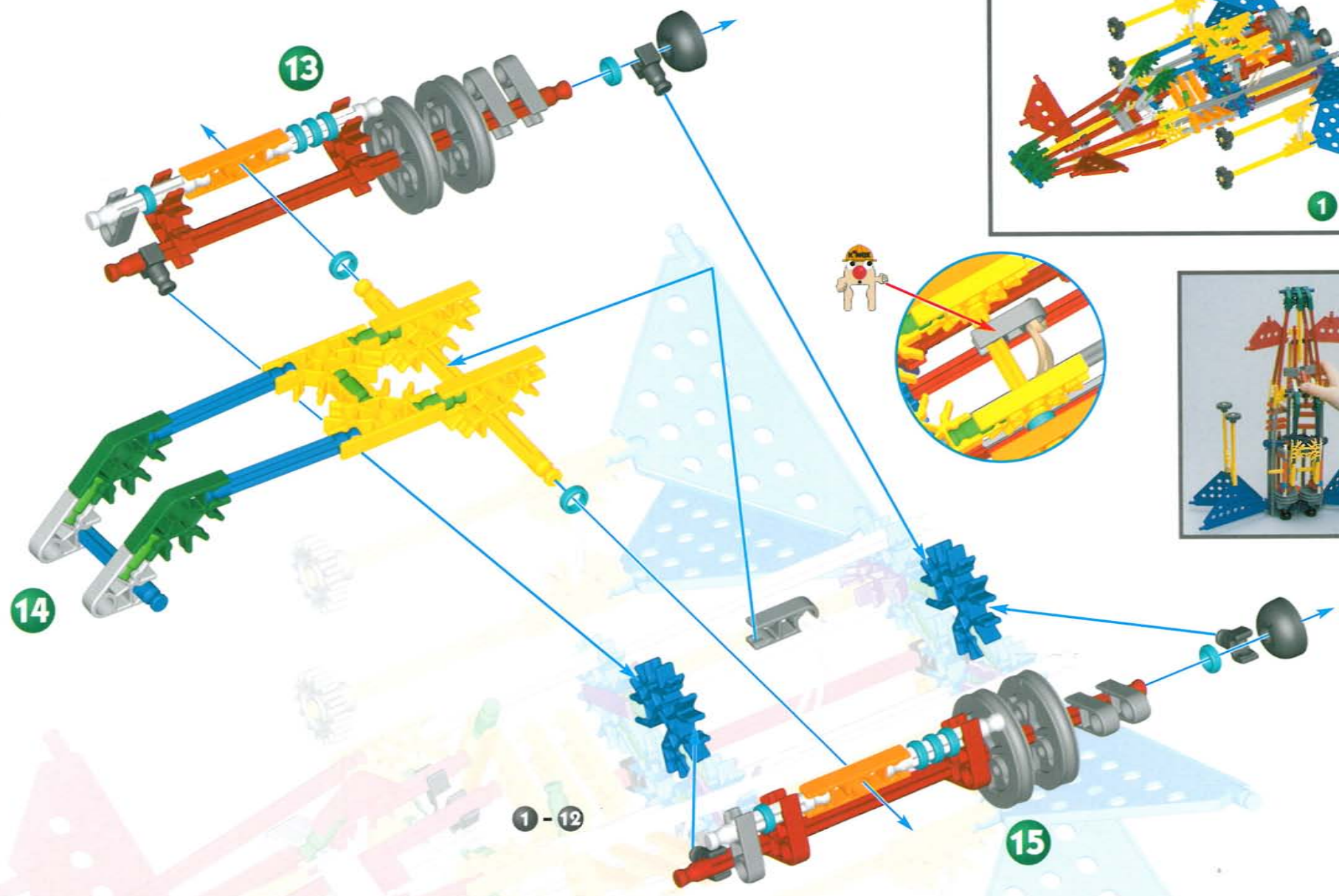



390

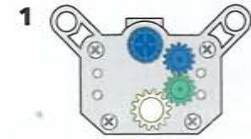
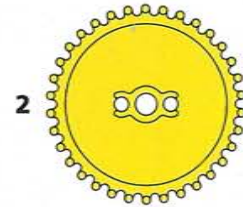
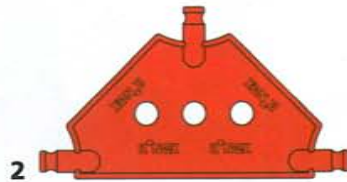
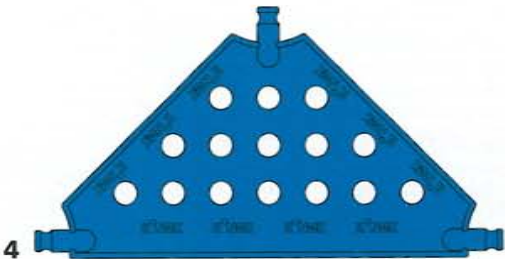
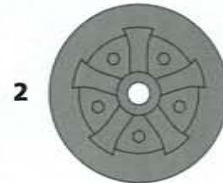
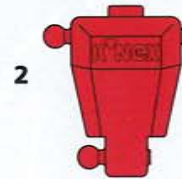
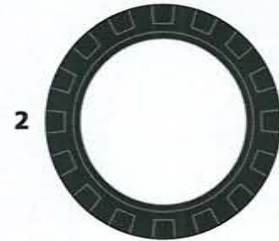
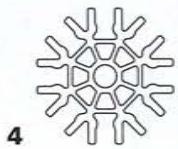

K'NEX[®]

CHALLENGE BUILDING SET

35 MODELS



OCTOPUS RIDE



ROBOT



PROP PLANE



SPRING MOTOR



SPORT BIKE



CAMERA

Most models can be built one at a time. Colors and product may vary. Set contains 1 K'NEX figure. Set contains 1 MicroPower motor.

La plupart des modèles peuvent être construits un à la fois. Le produit et les couleurs peuvent varier. La boîte contient une figurine K'NEX. L'ensemble comprend 1 moteur MicroPower.

La mayoría de los modelos sólo se puede construir uno a la vez. El producto y los colores pueden variar. El juego contiene 1 figura K'NEX. El juego contiene 1 motor MicroPower.

K'NEX is a registered trademark of/K'NEX est une marque déposée de K'NEX Industries, Inc.

Manufactured under U.S. Patents/Fabriqué sous brevets américains 5,061,219; 5,137,486; 5,199,919; 5,238,438; 5,346,420; 5,350,331; 5,368,514; 5,421,762; 5,423,707; 5,427,559; 5,518,435; D383,509; D388,475; D389,203; D391,843; D391,921; D392,555. Other U.S. and foreign patents pending./Autres brevets américains et étrangers en instance.

Conforms to the Requirements of ASTM Standard Consumer Safety Specification on Toy Safety, F963-96a./Conforme aux spécifications de sécurité du consommateur sur la sécurité des jouets de la norme ASTM F963-96a.

Questions? Call us
at 1-800-KID-KNEX
(USA/Canada only)
www.knex.com



©1999 K'NEX Industries, Inc.
P.O. Box 700
Hatfield, PA 19440-0700

Made in the U.S.A.
Fabriqué aux États-Unis.

3247-V2-1/00