

## 4 Wheeler

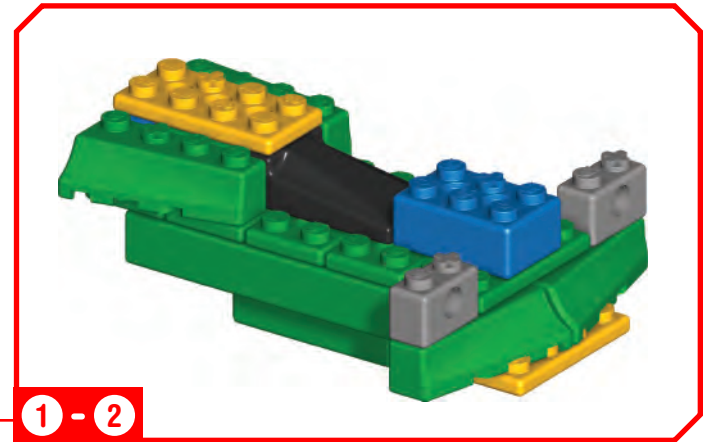

1 - 2

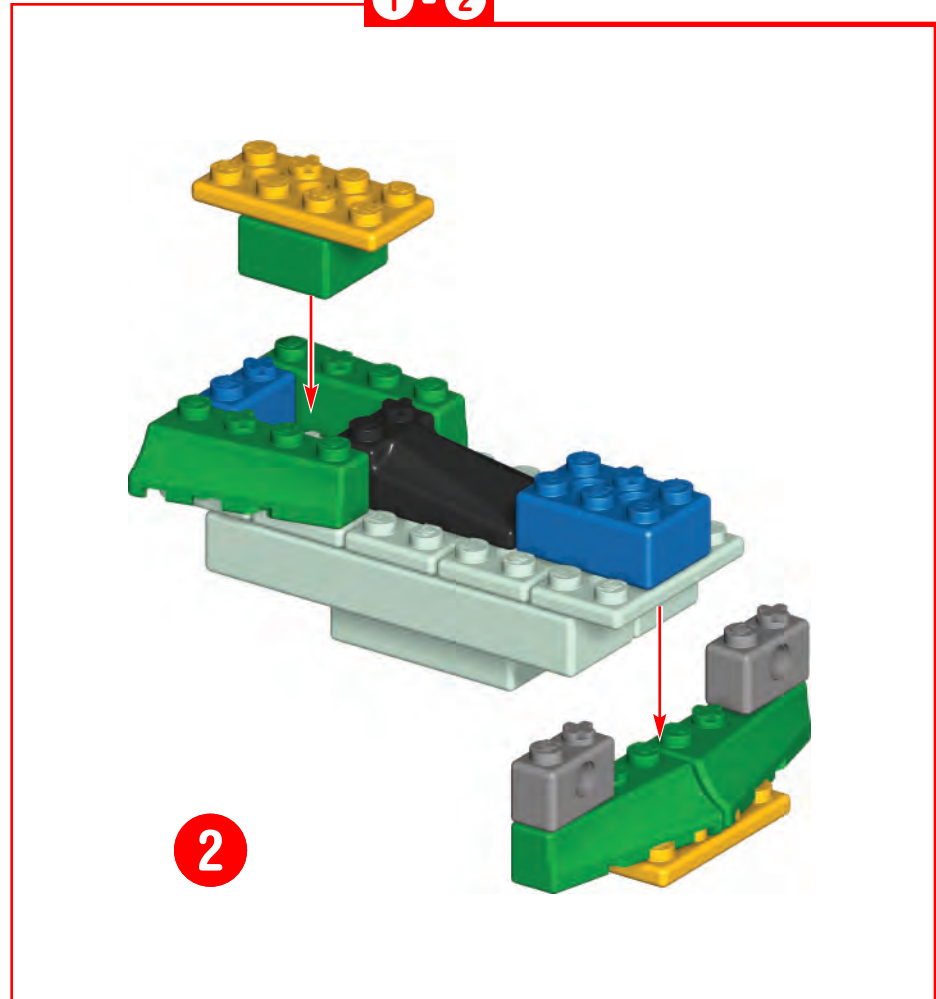
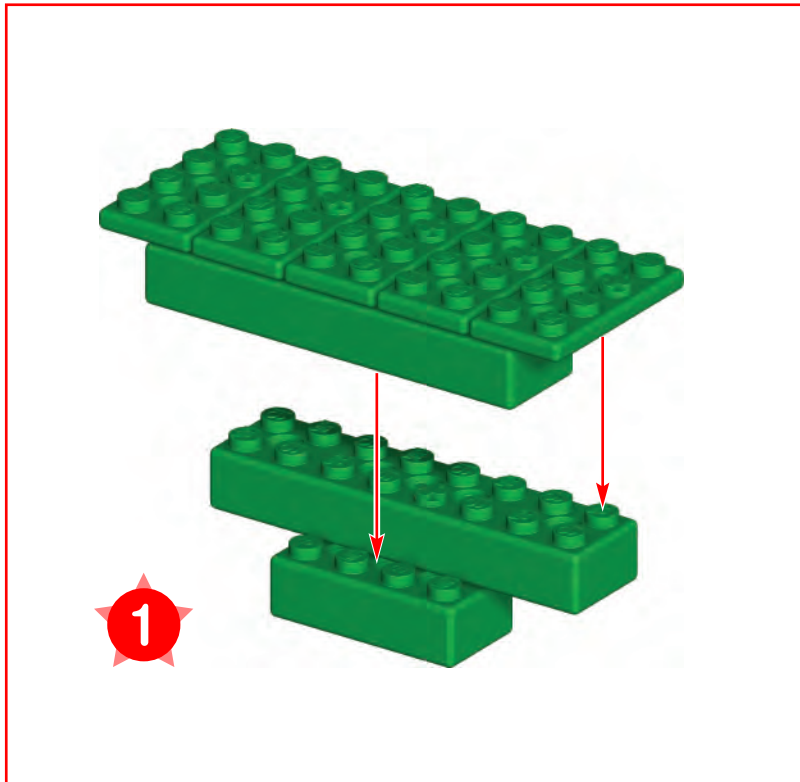

Turn your model upside down and add the wheels.

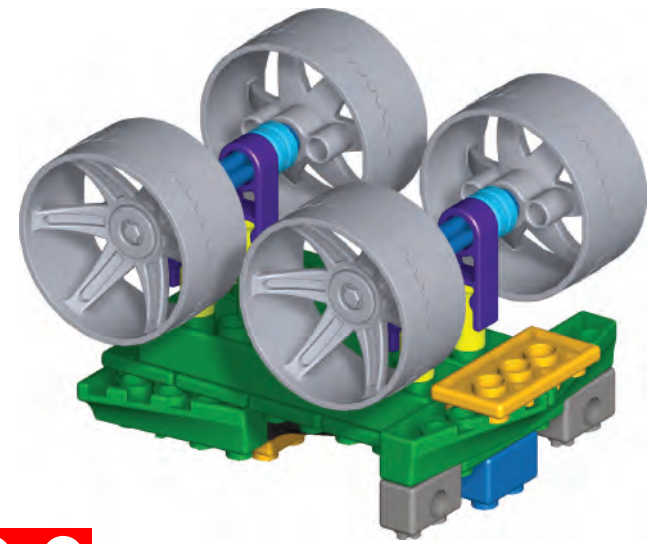
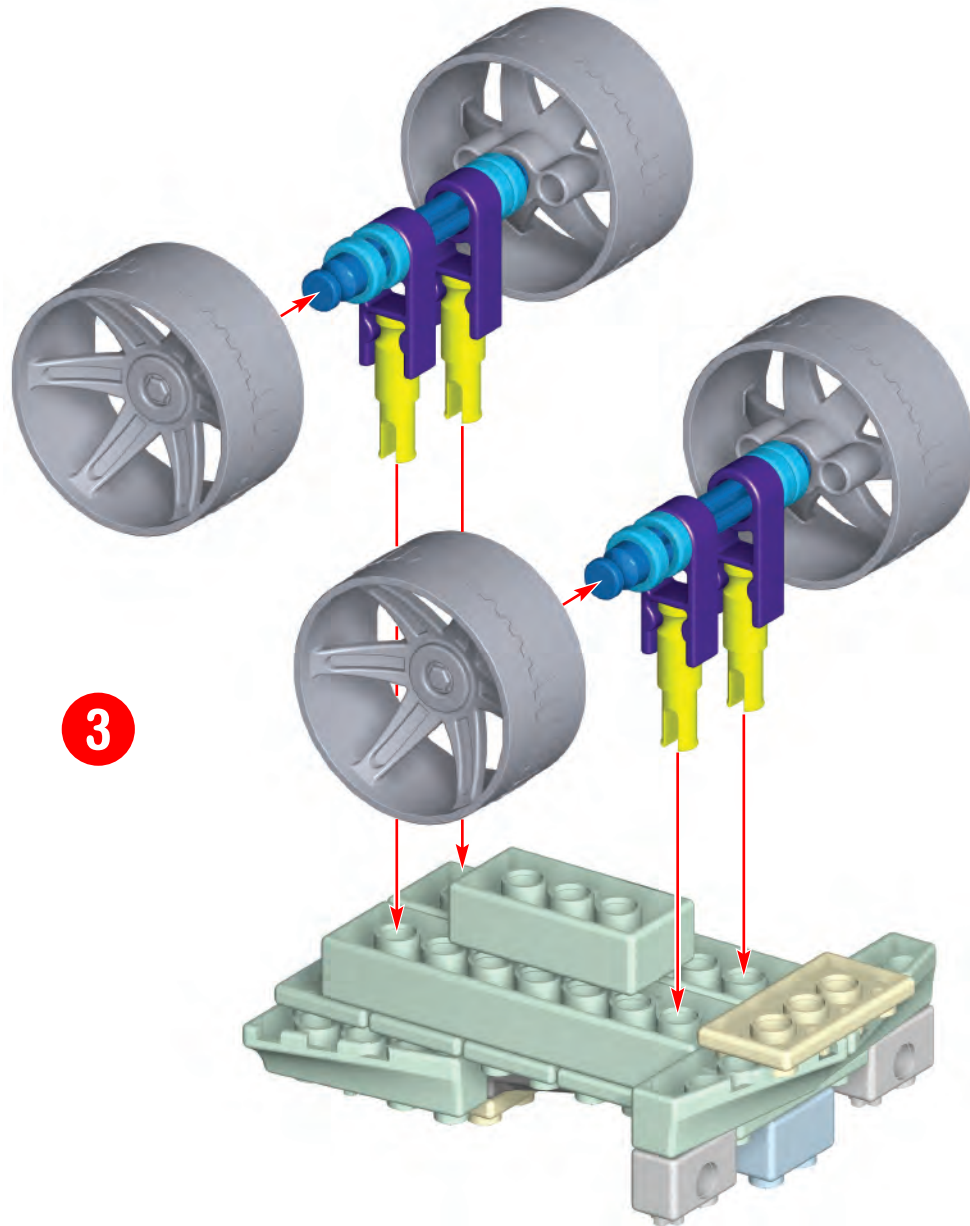

1 - 3

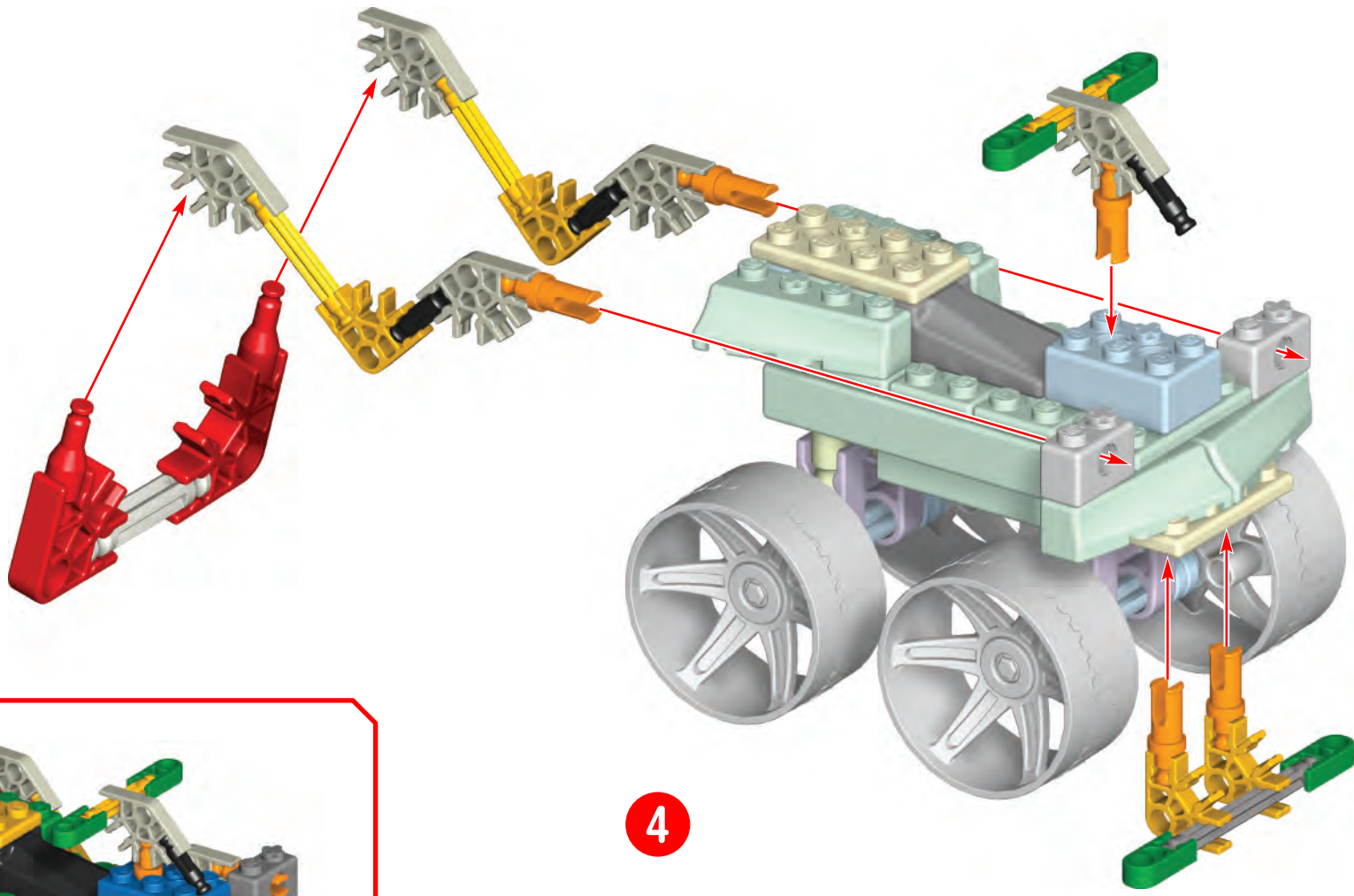

4



1 - 4



# 4x4 Truck

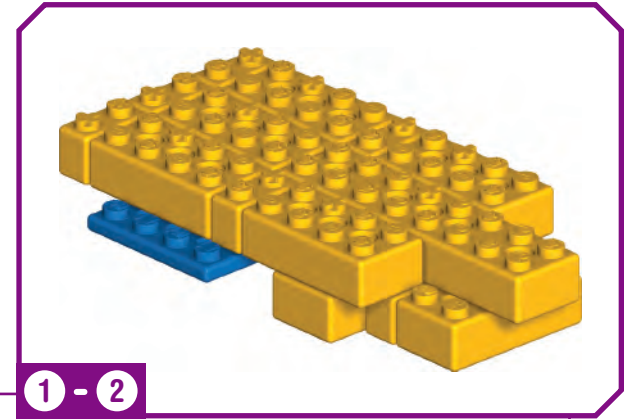

1 - 2

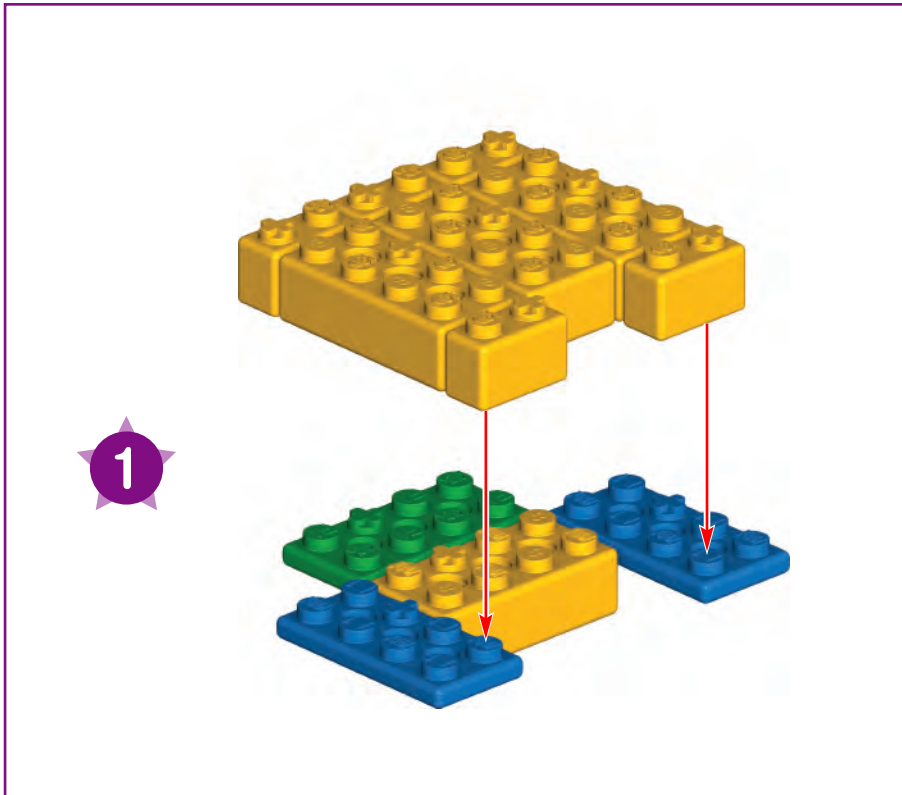

1

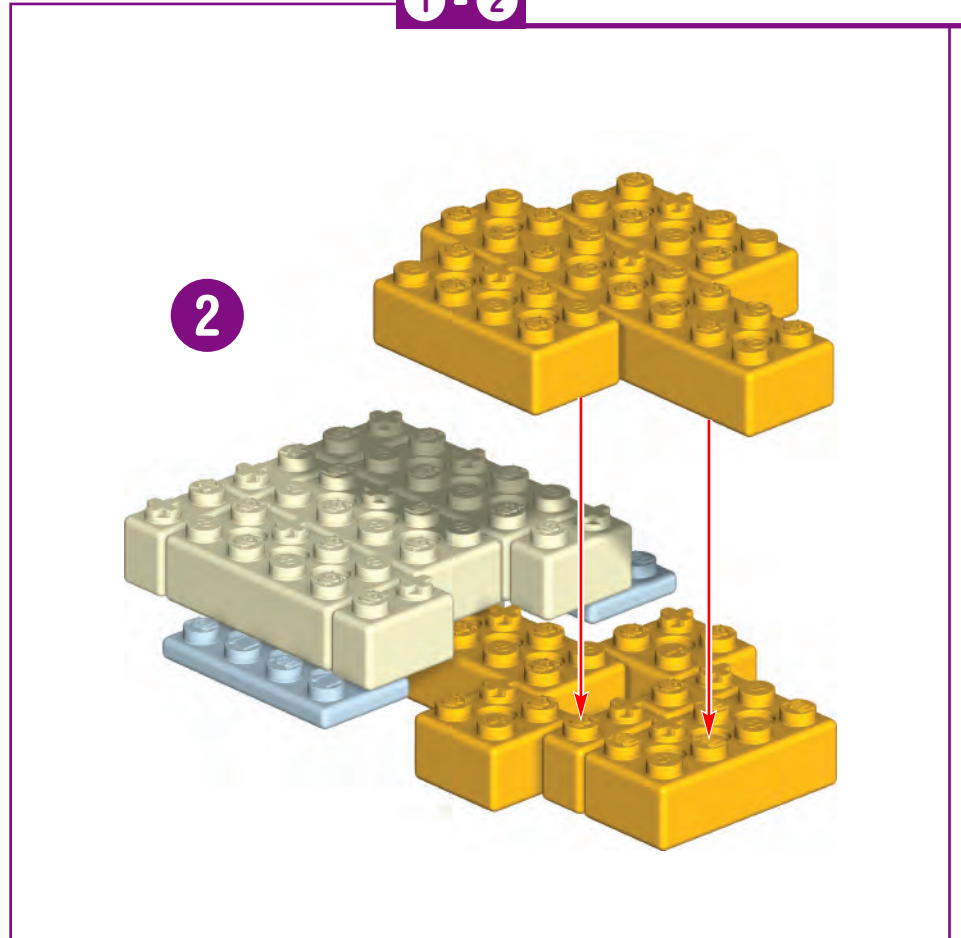

2

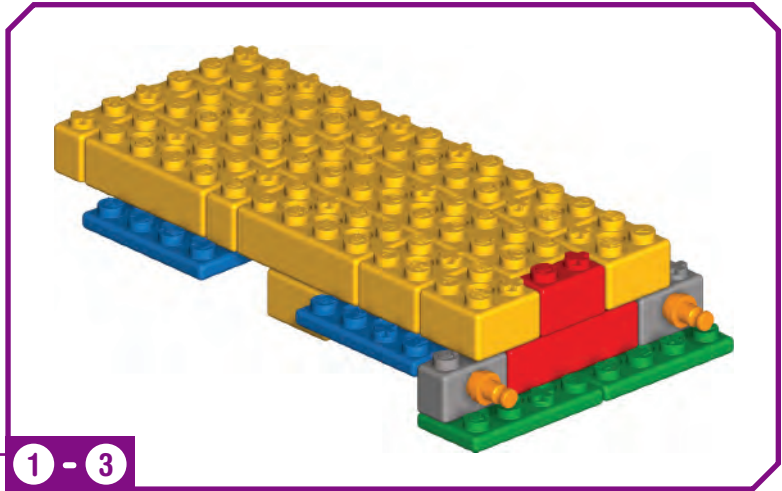

1 - 3

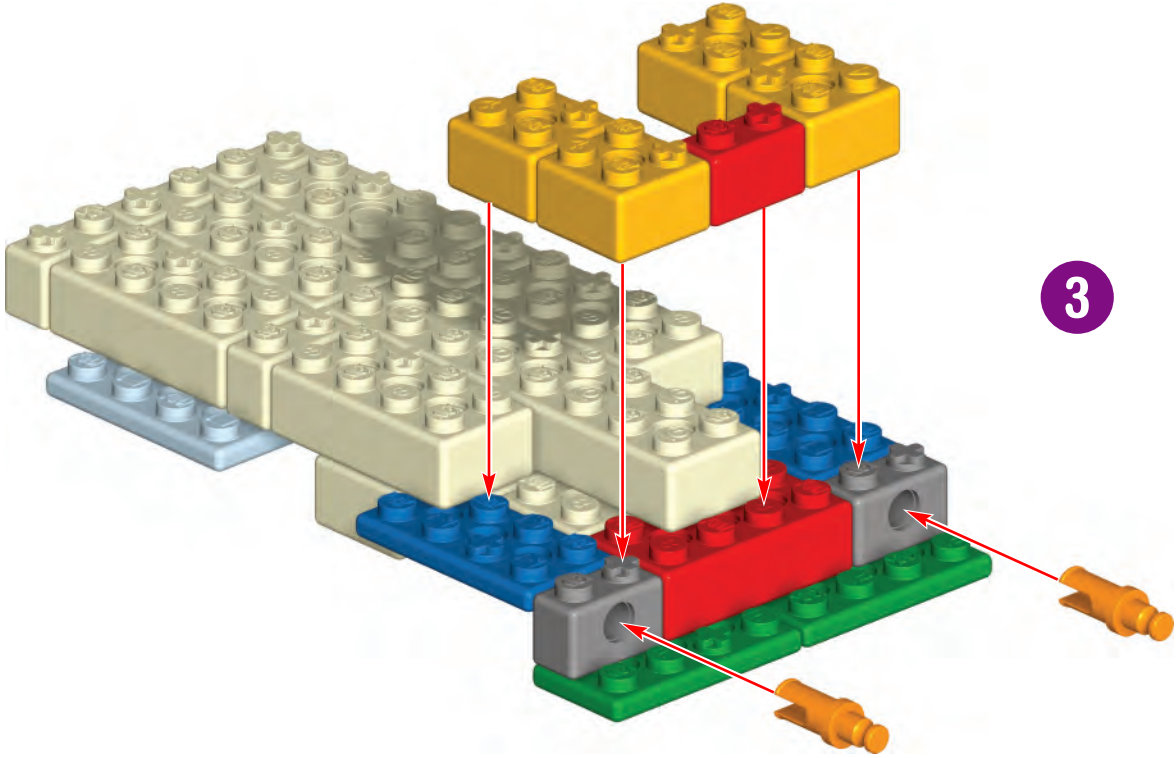

3

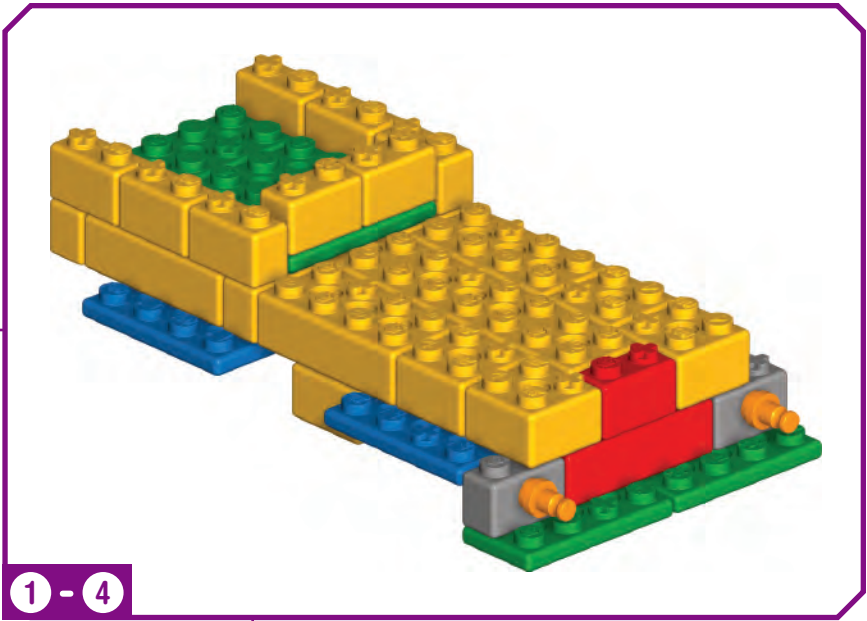
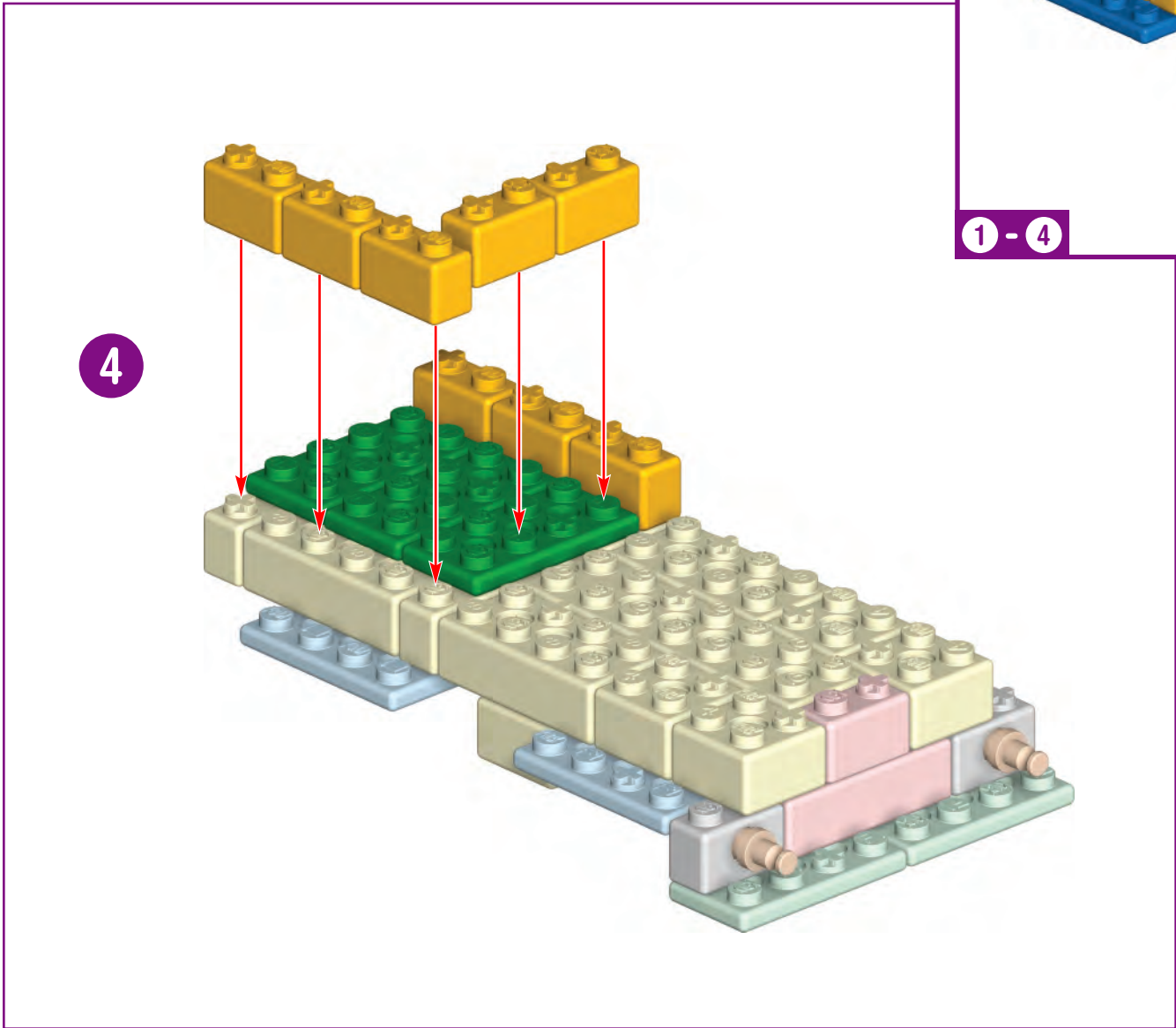

5

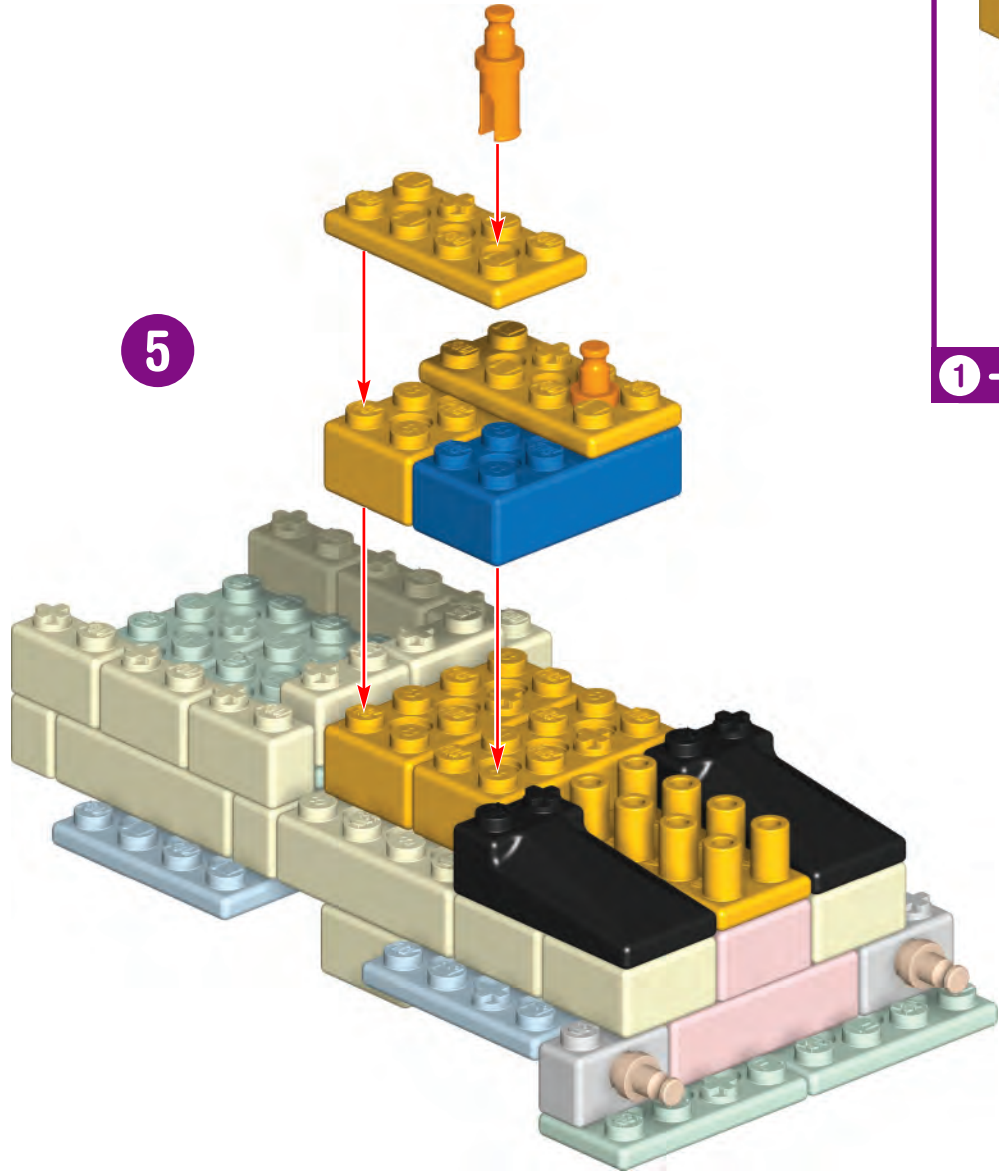

1 - 5

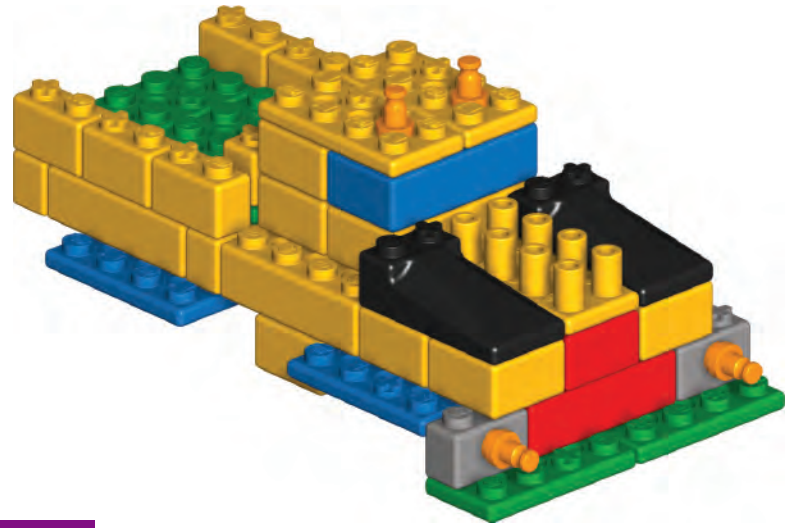

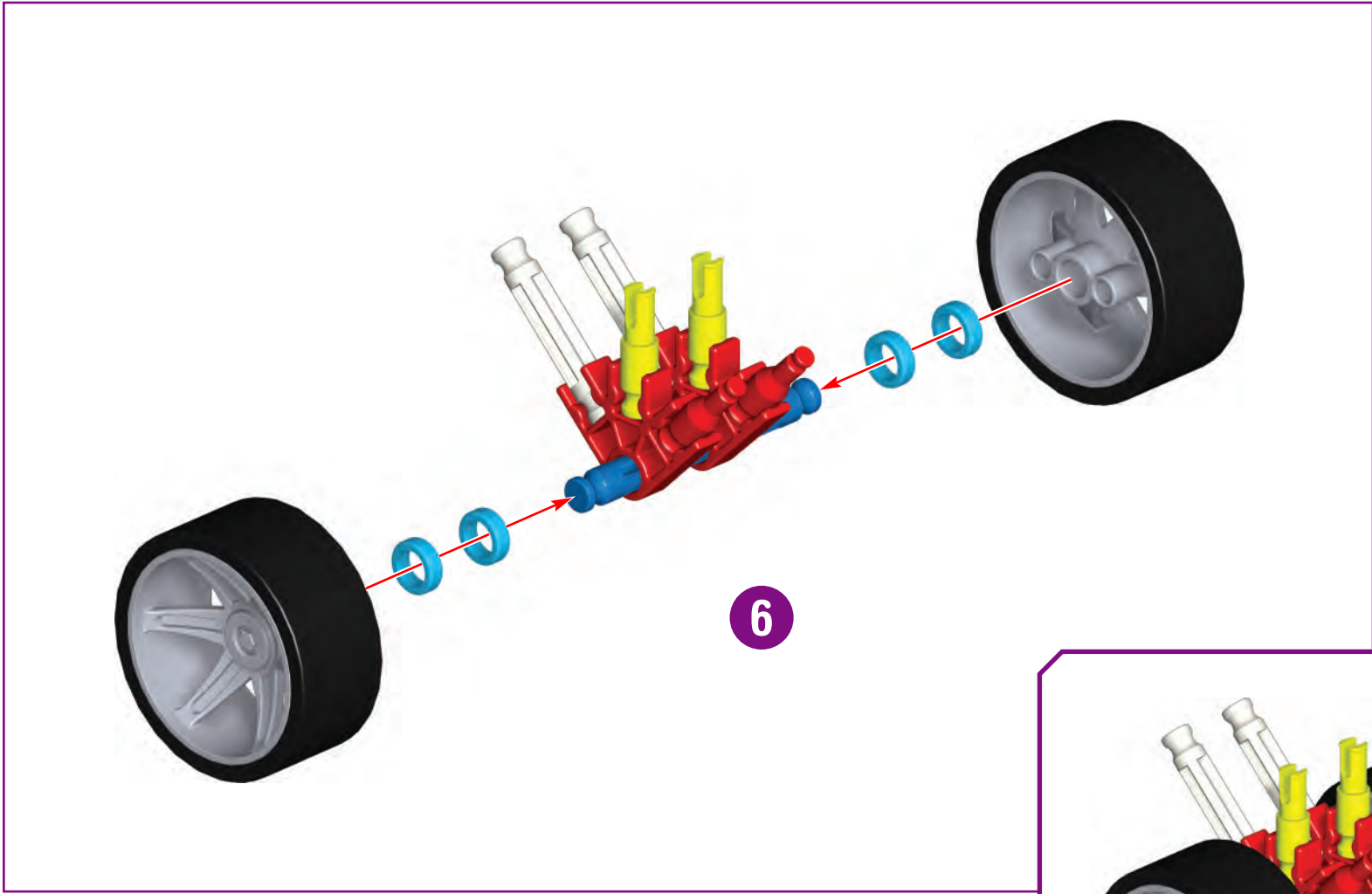

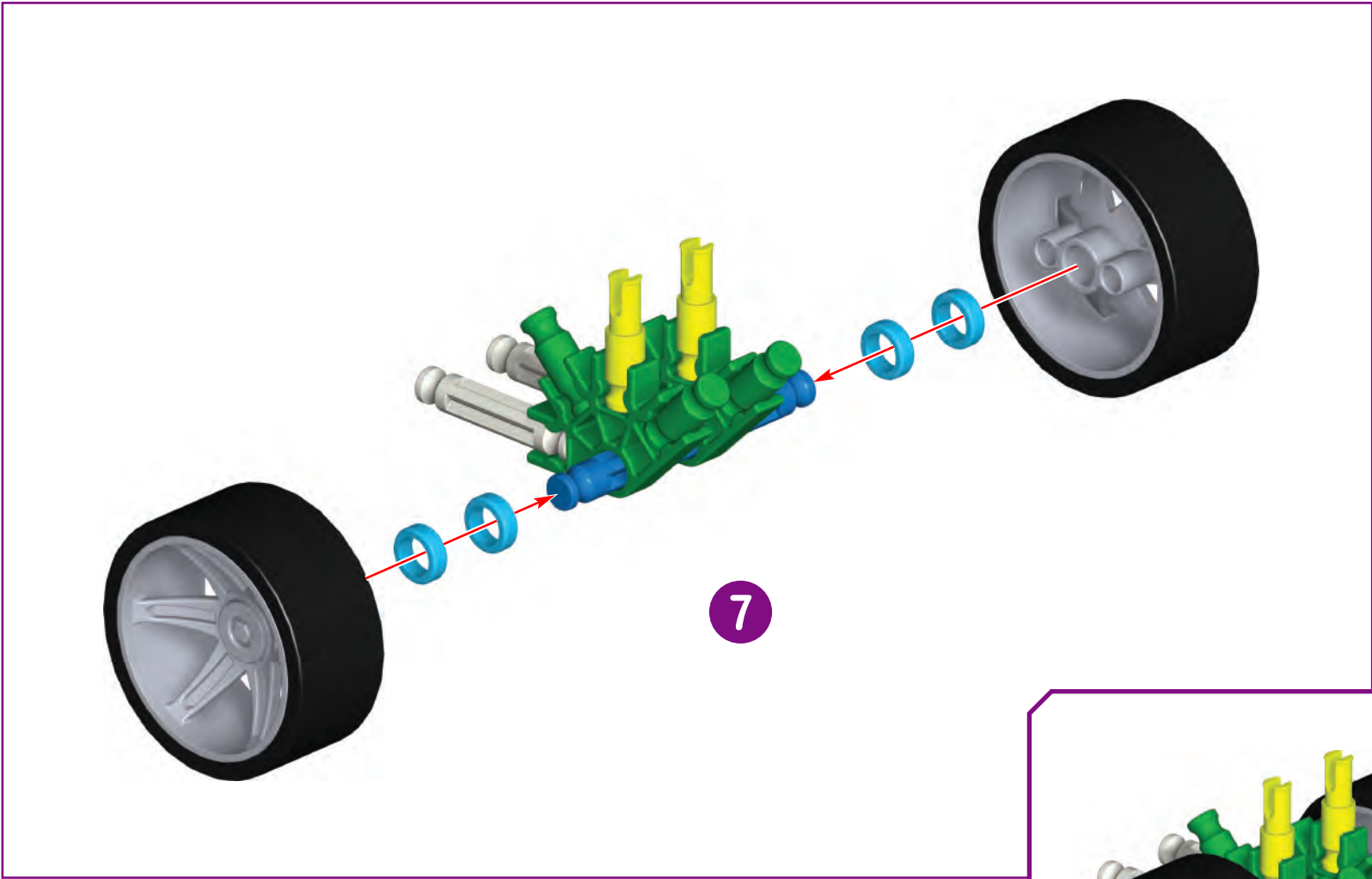

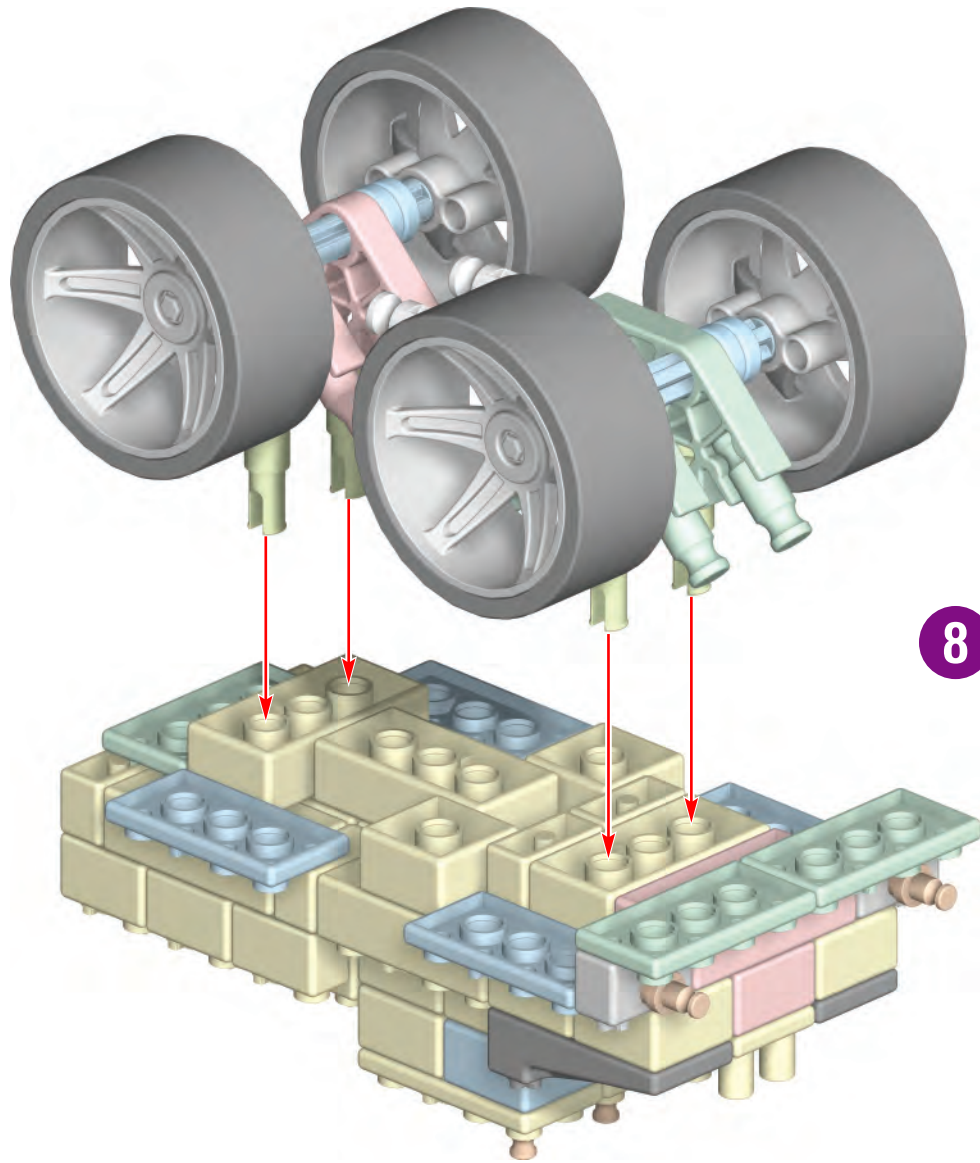

1 - 8



Now turn the truck upside down to attach the wheels.

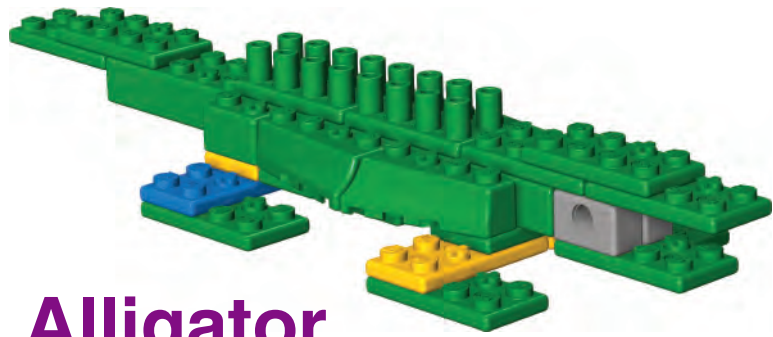

Alligator

1 - 2

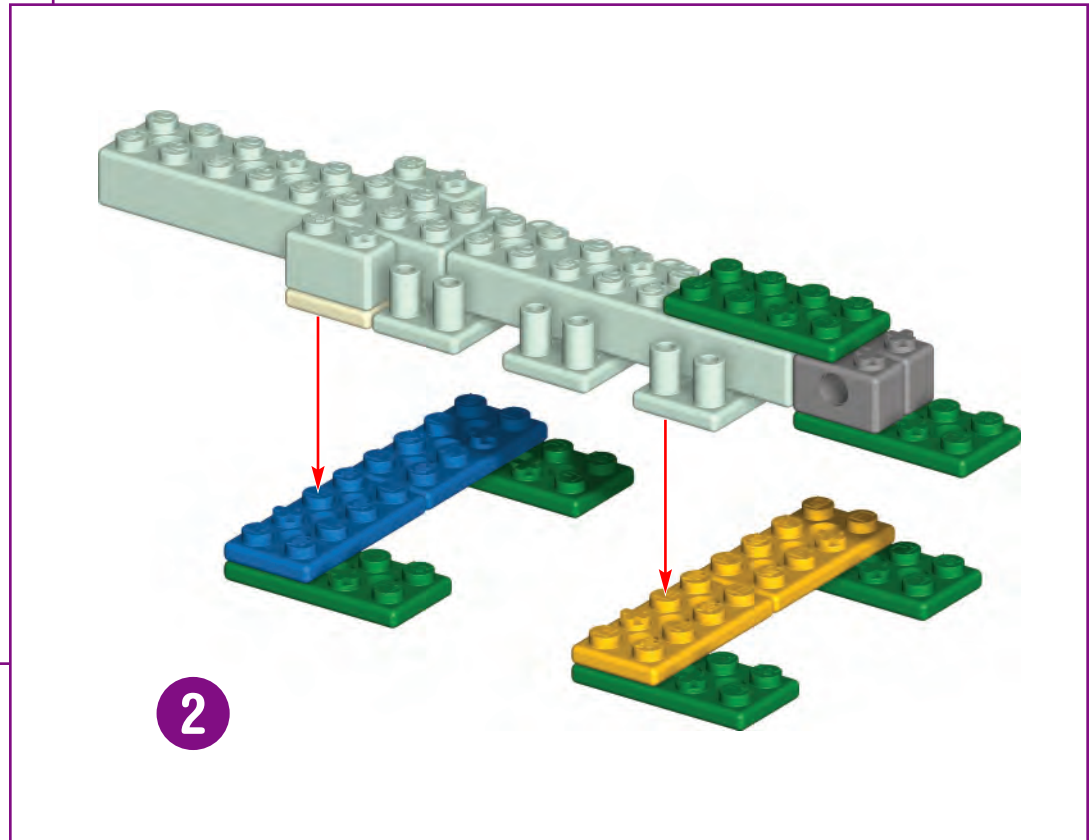
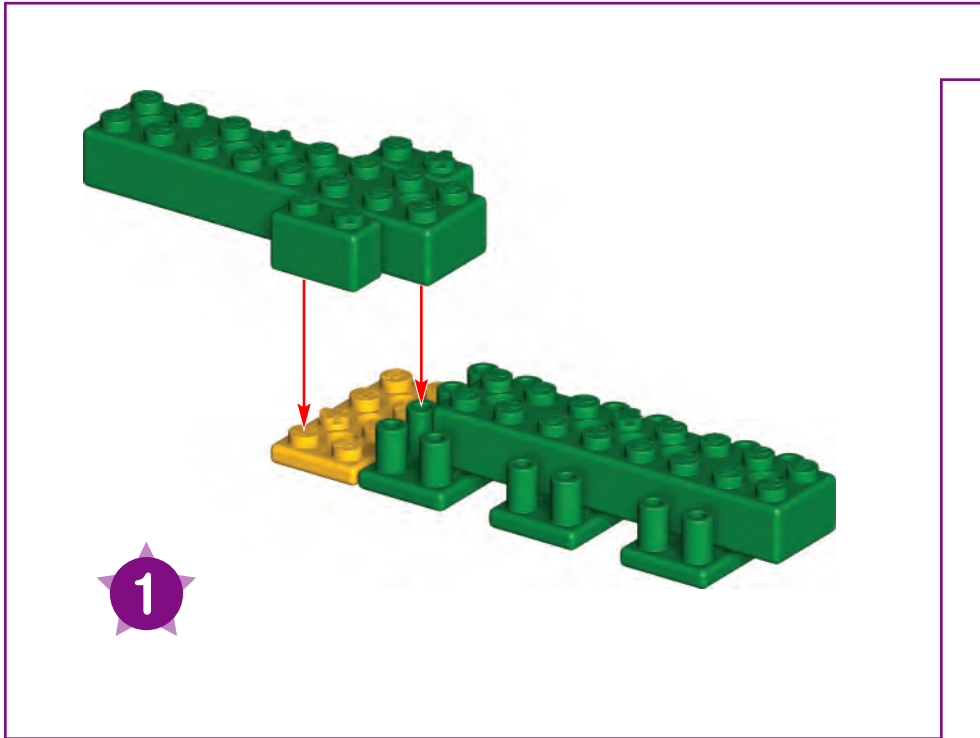
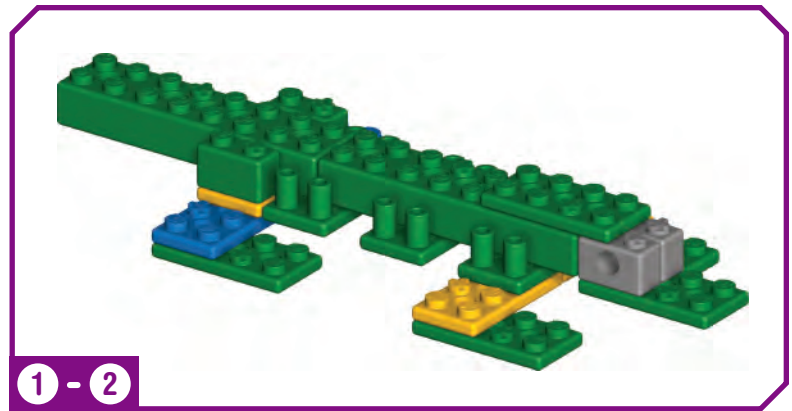

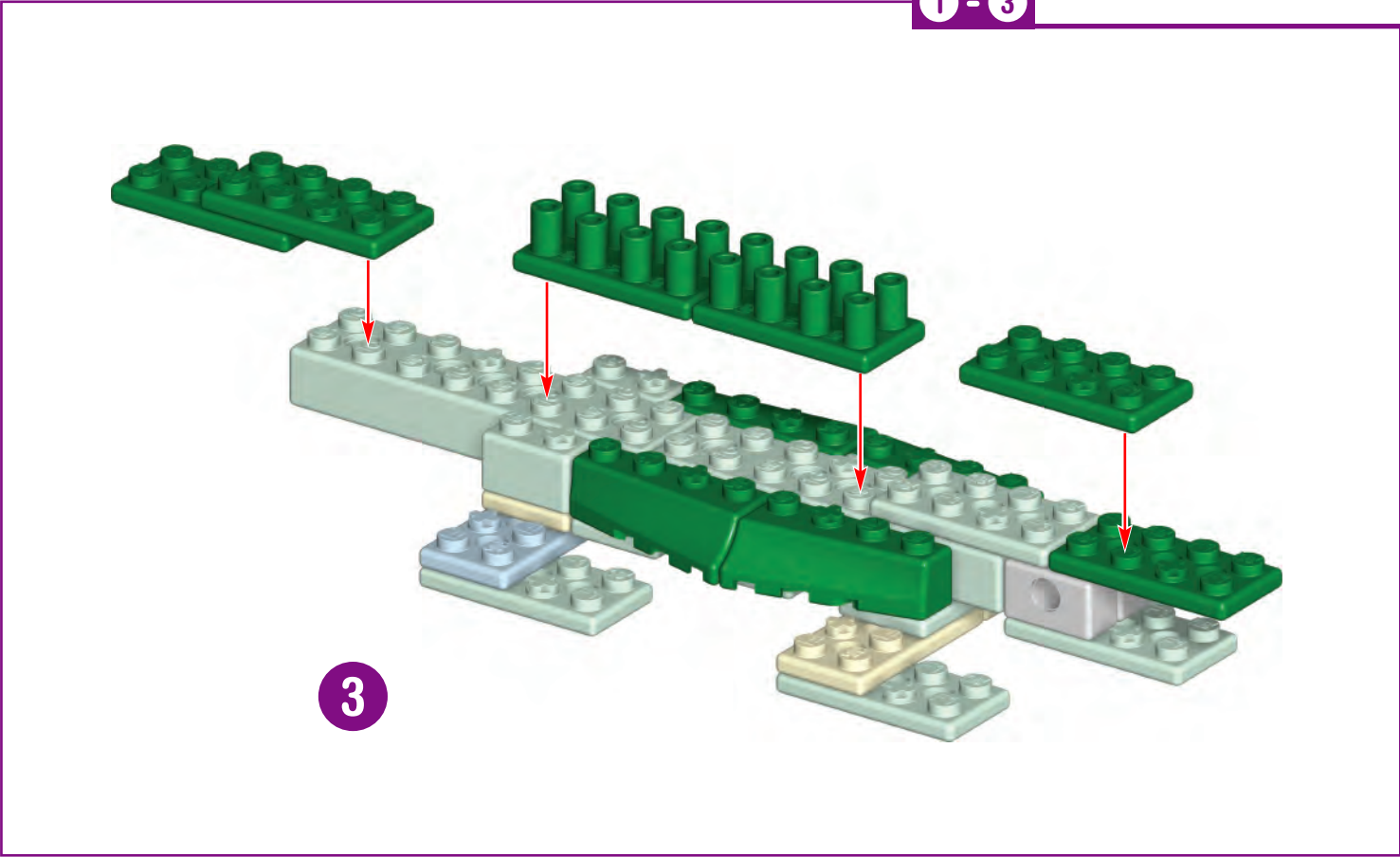
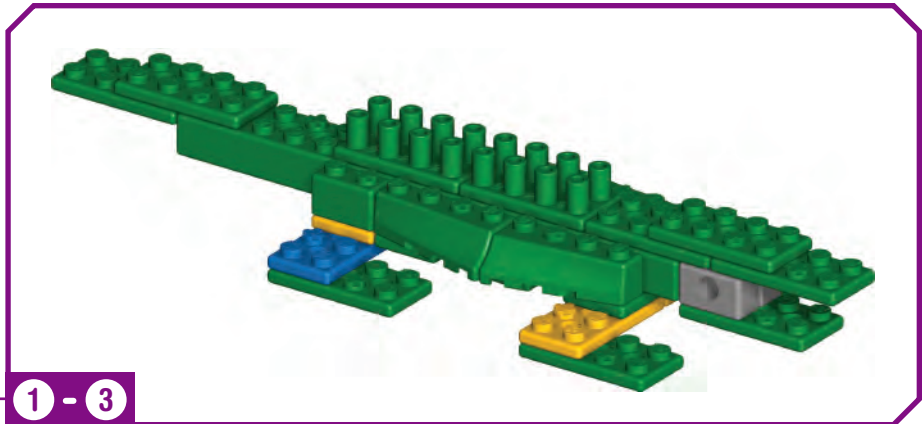

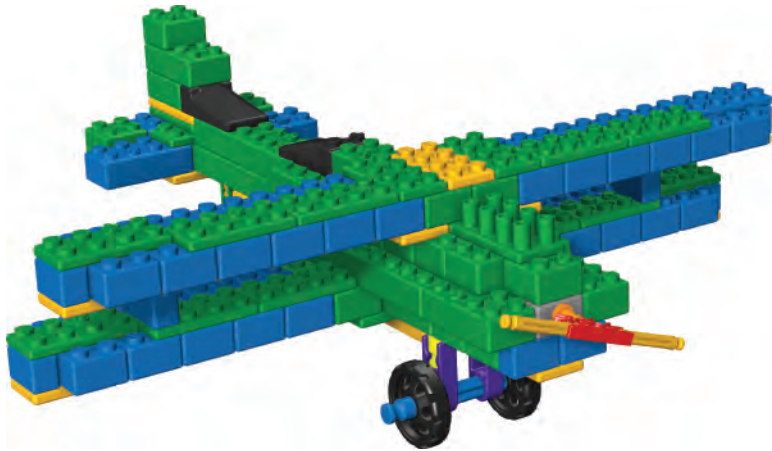

# Biplane

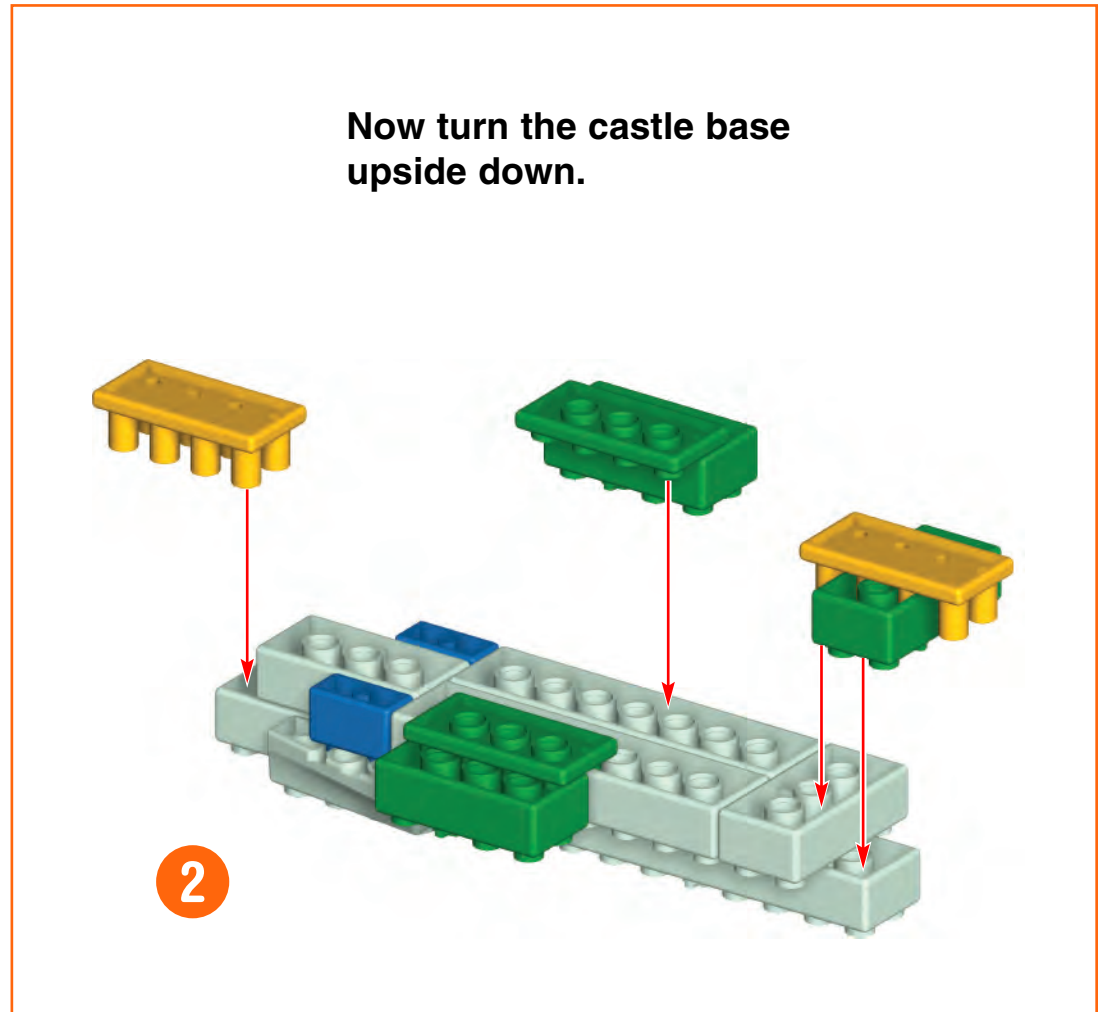
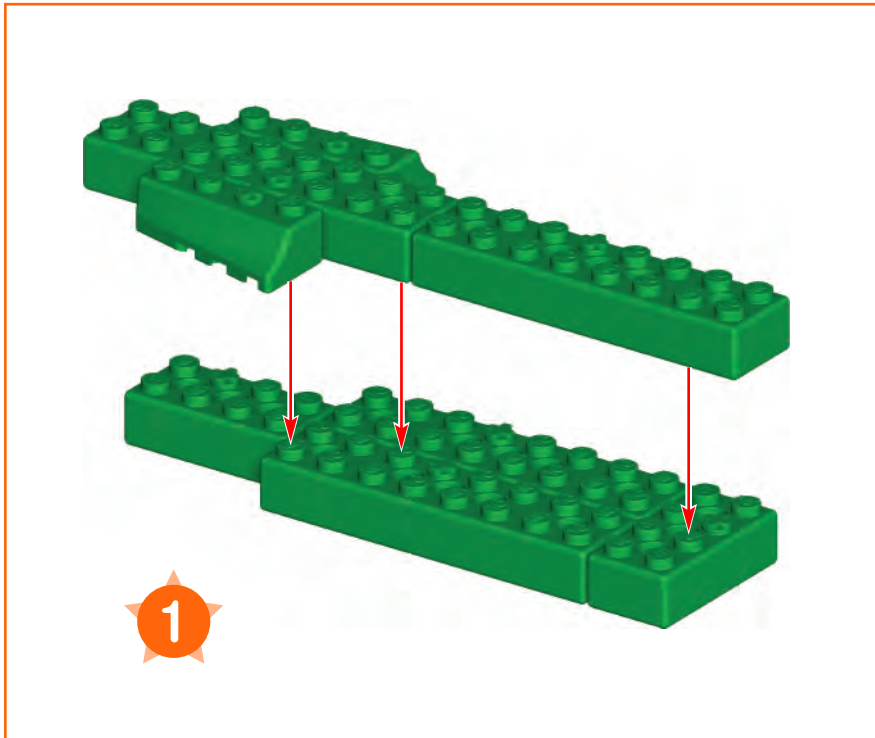
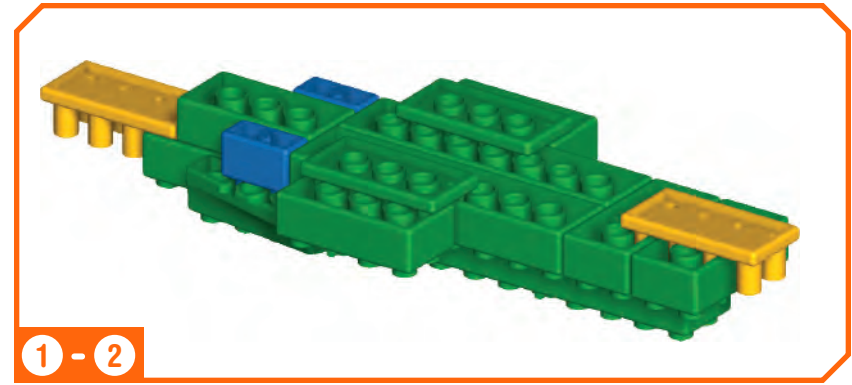

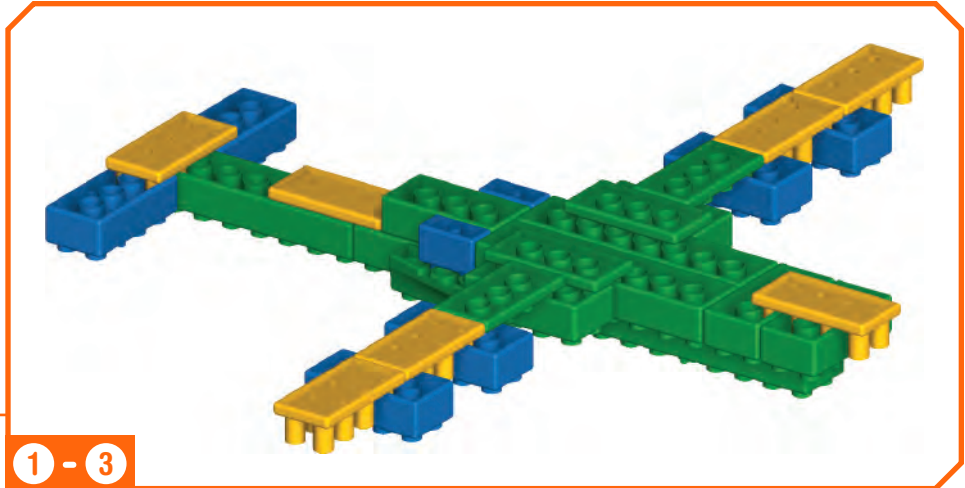

1 - 3

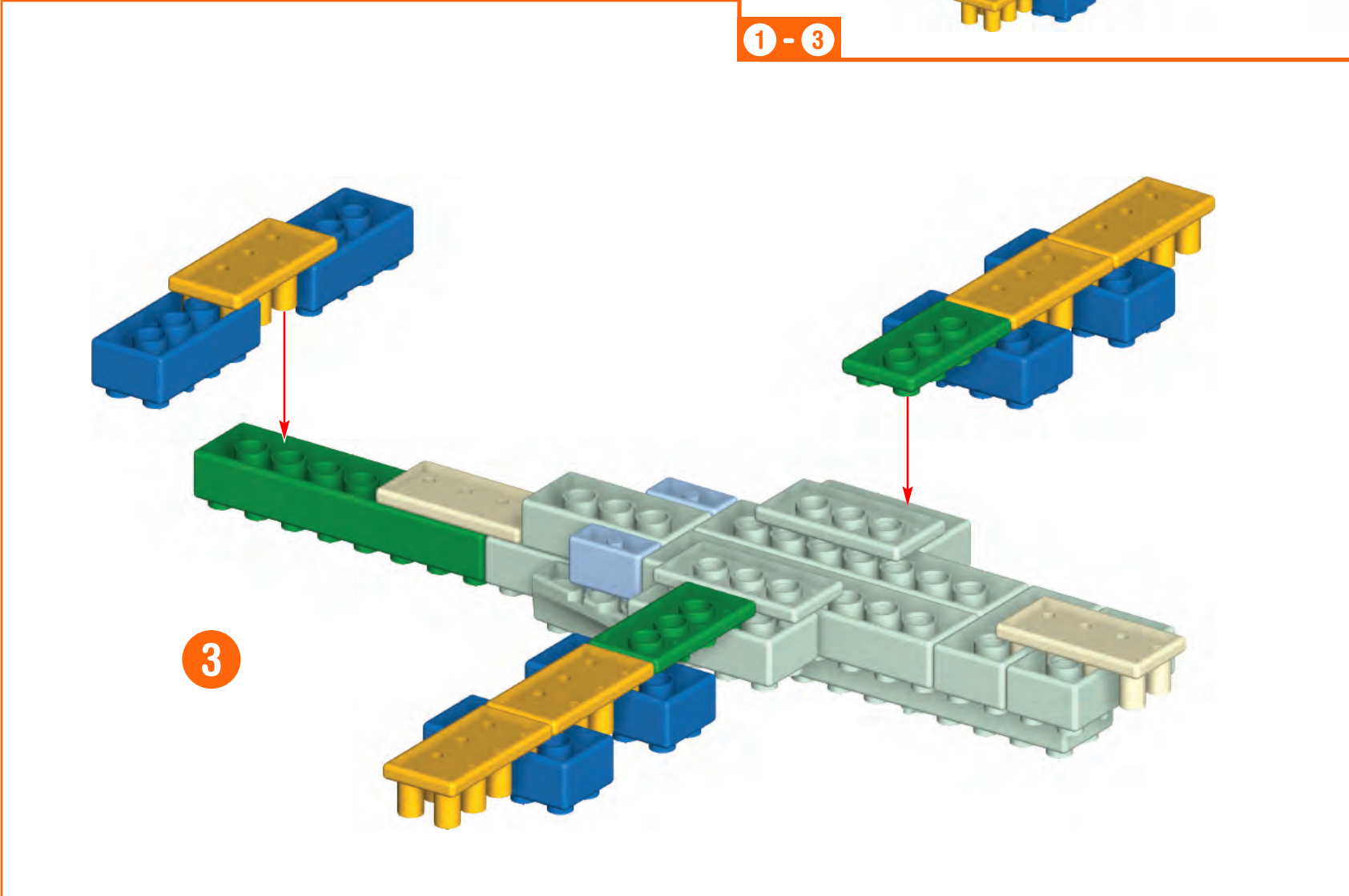

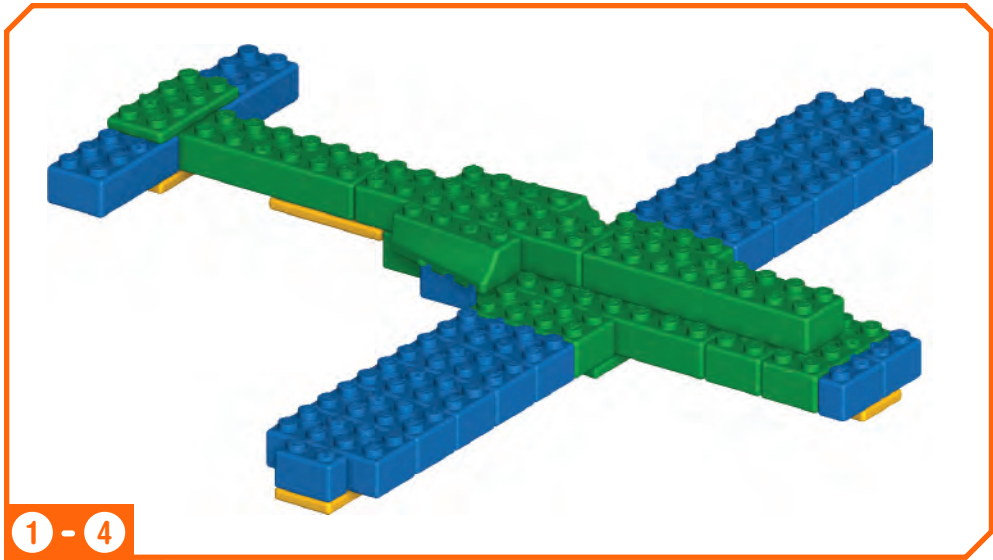

1 - 4

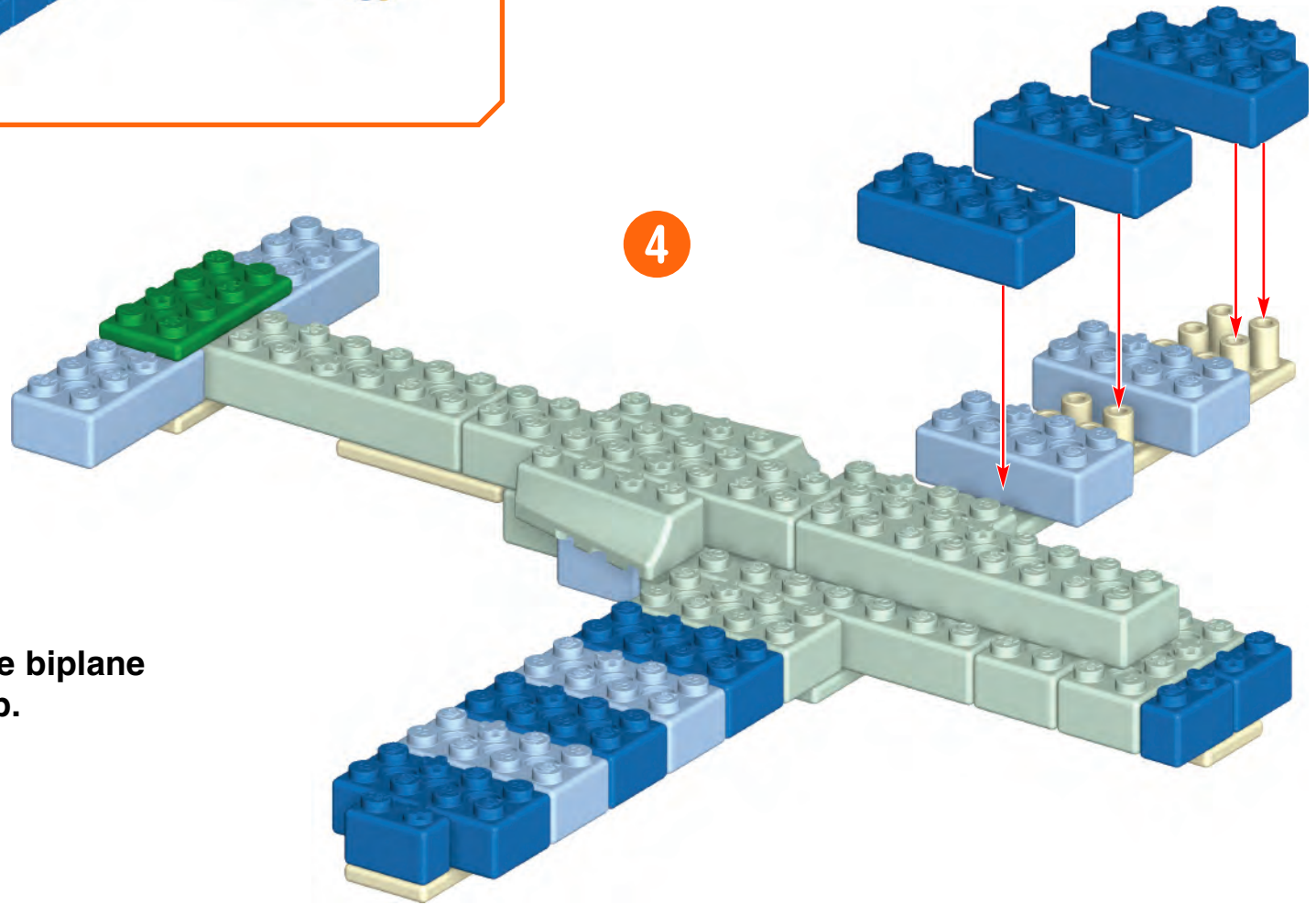

Now turn the biplane right side up.

1 - 5

5

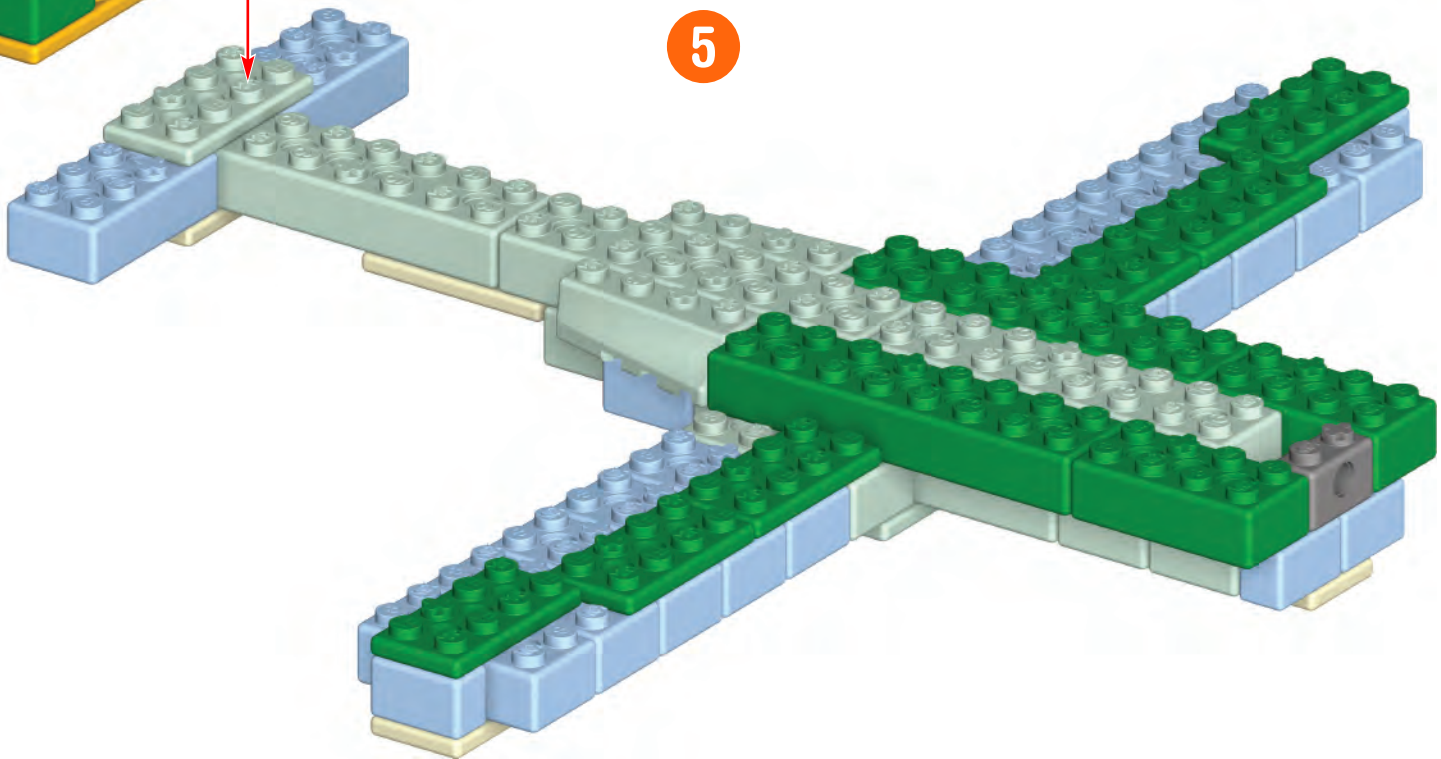
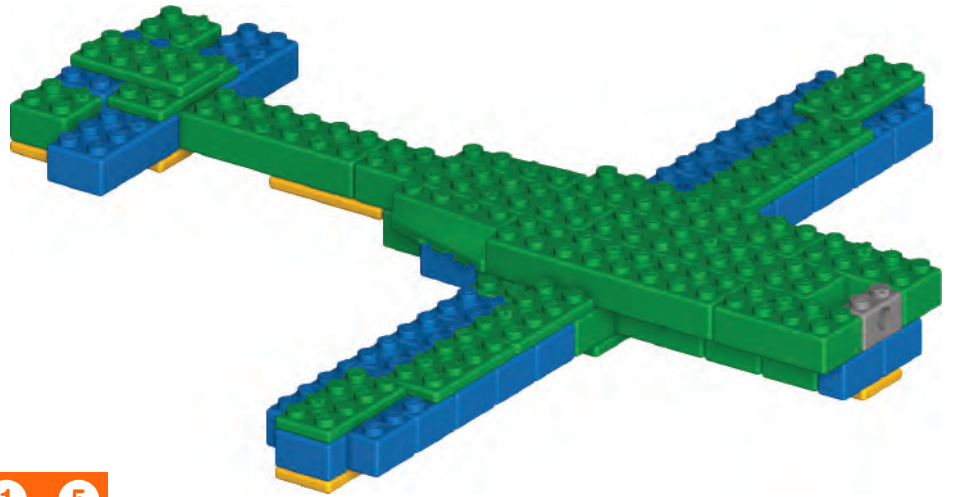
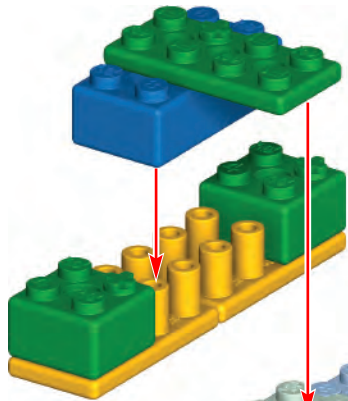

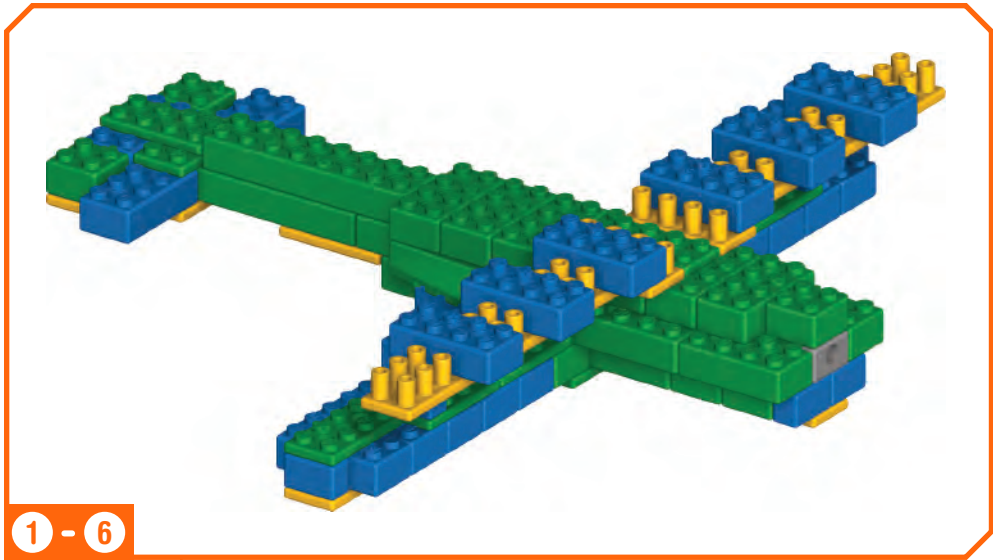

1 - 6

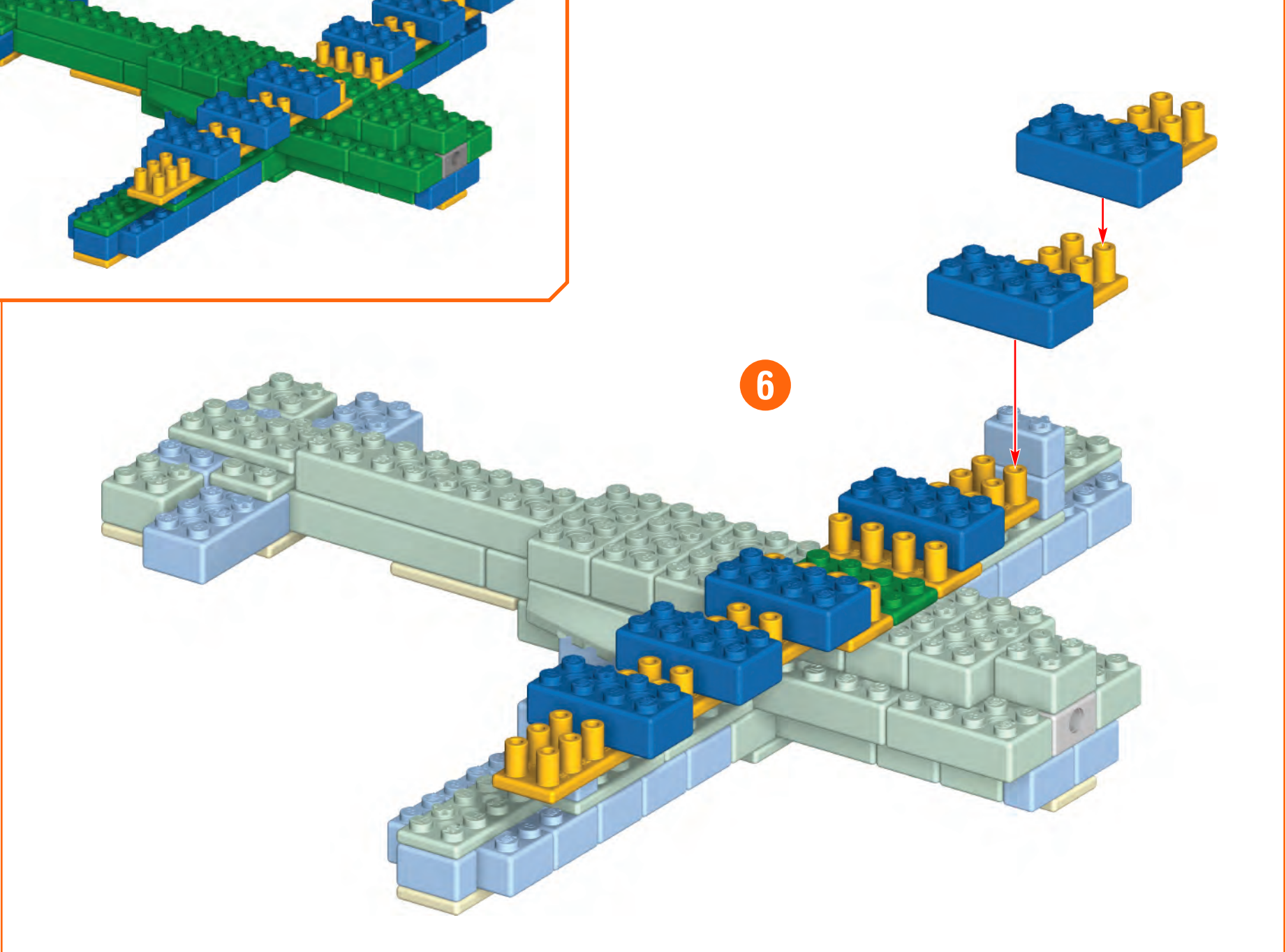

6

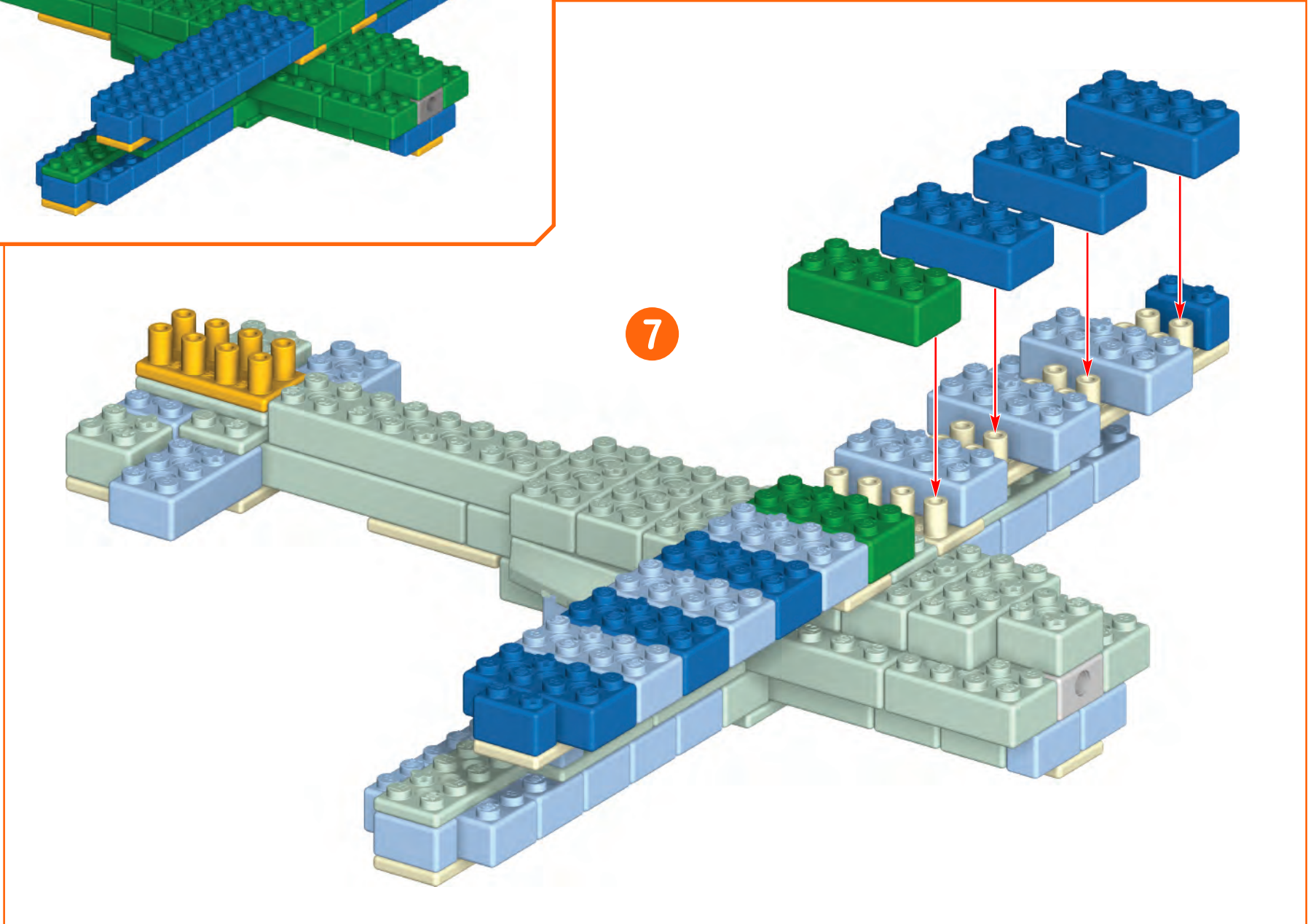
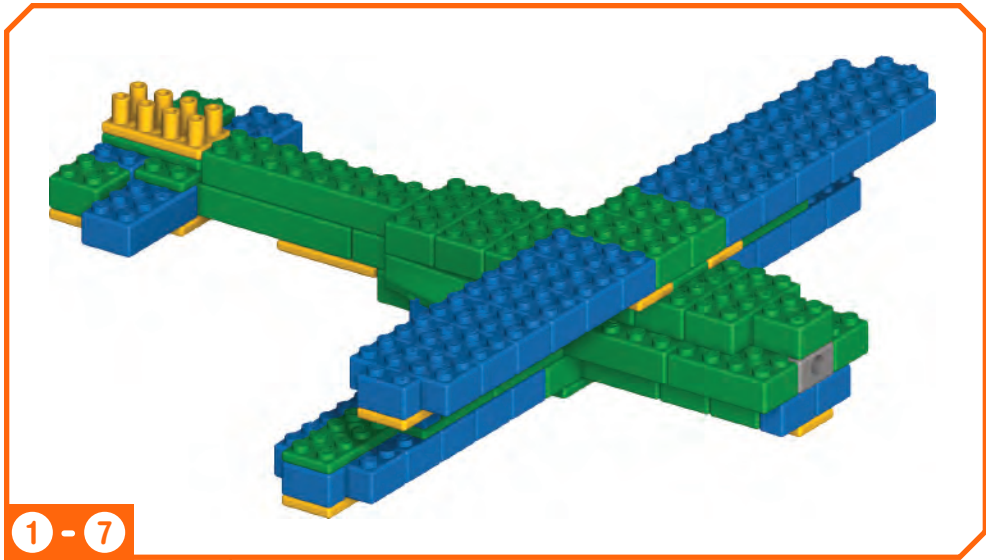

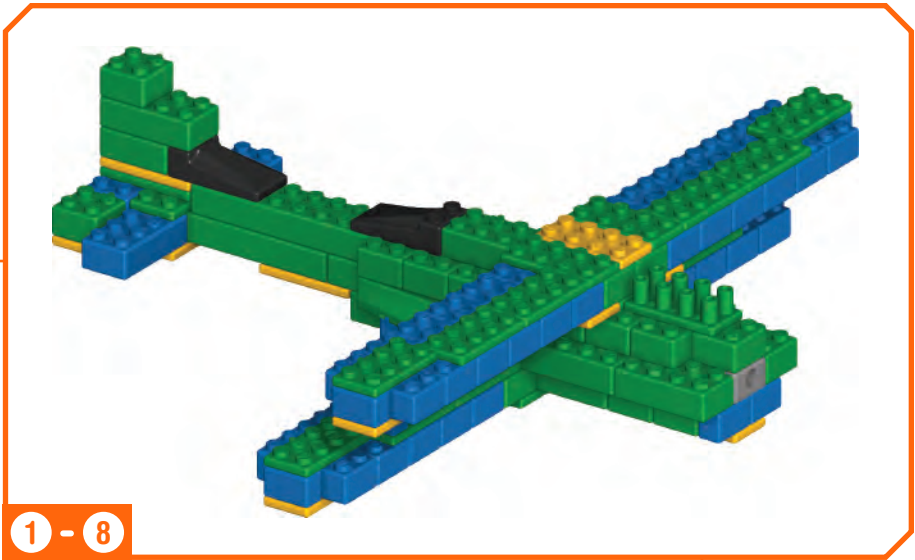

8

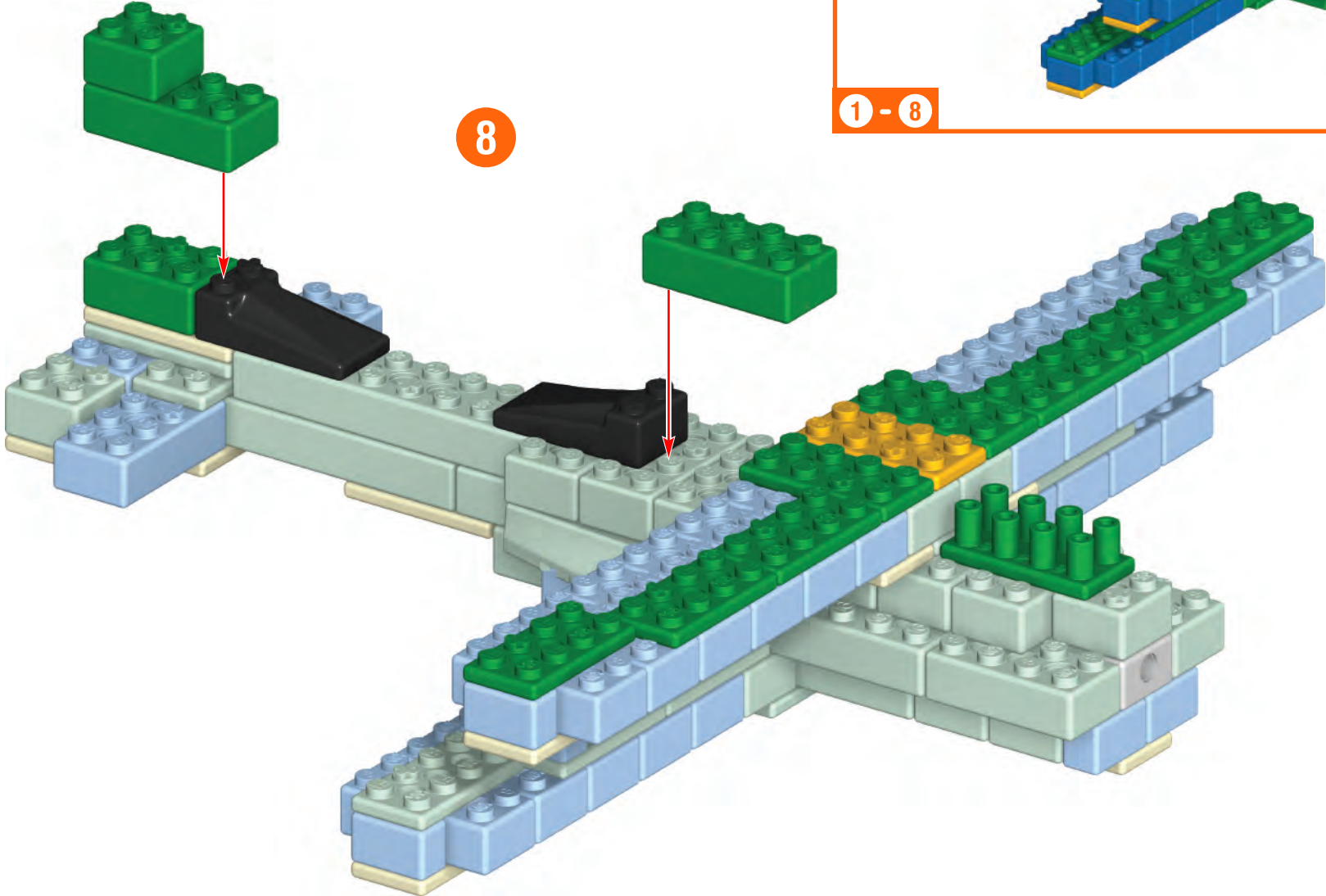

9

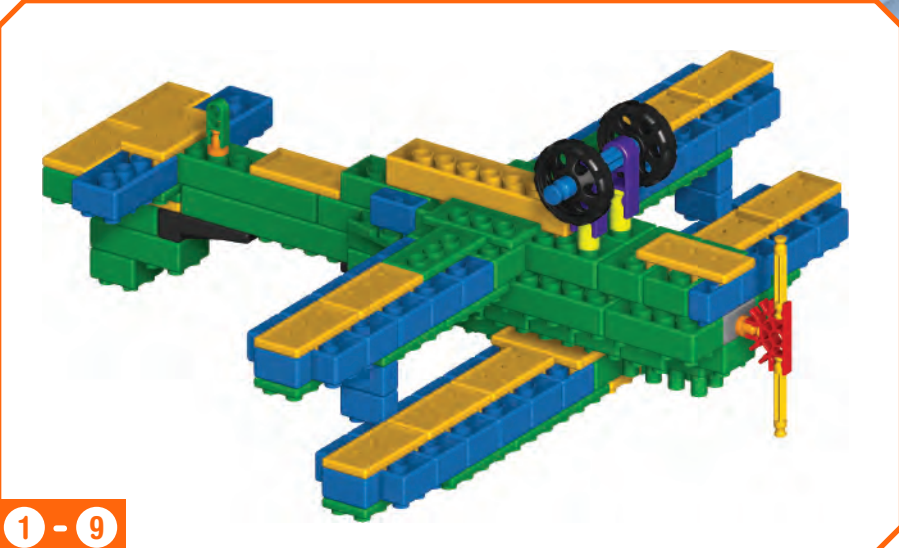
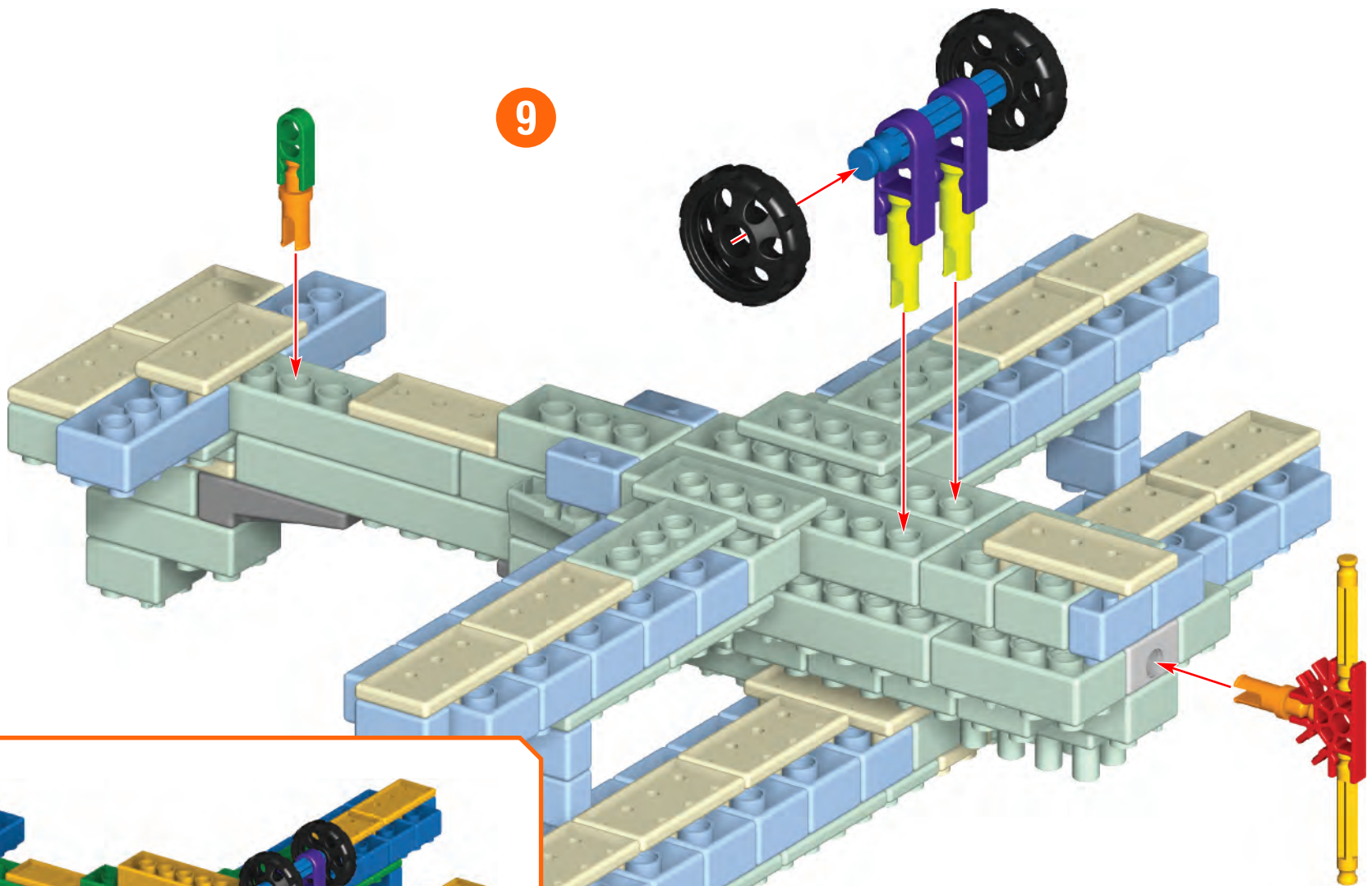

Turn your model upside down again and add the wheels.

1 - 9

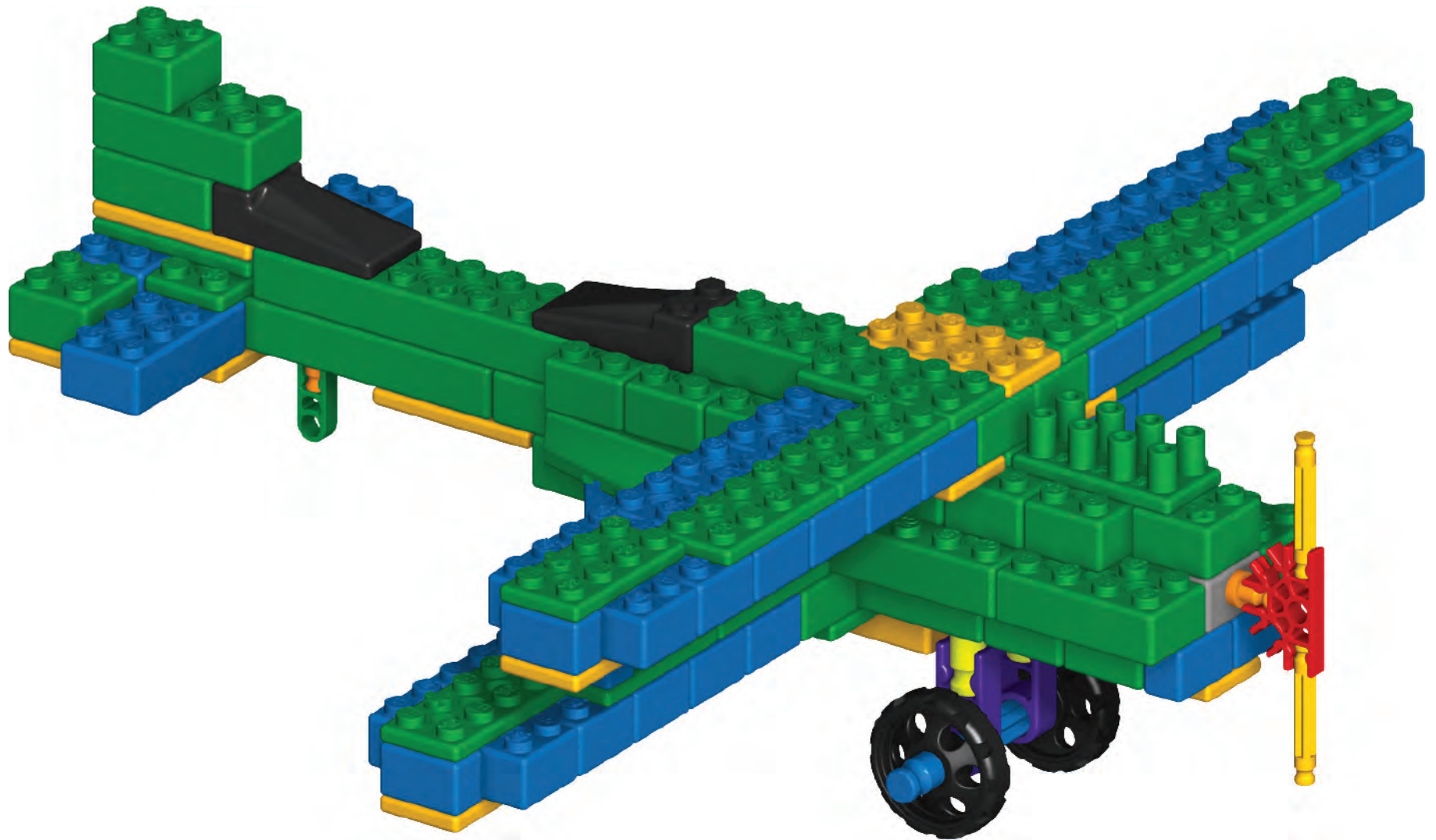

1 - 9

# Dog House

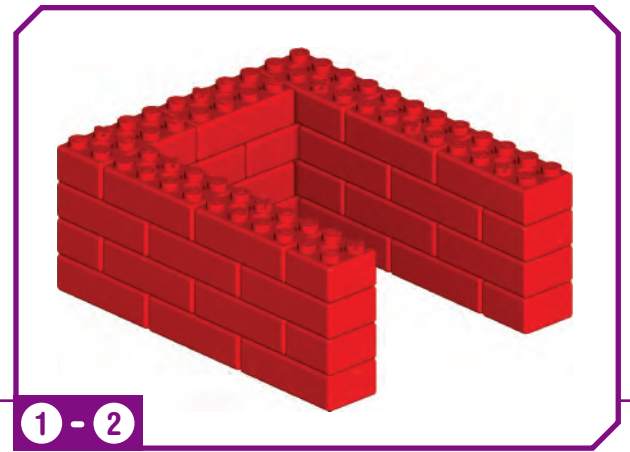
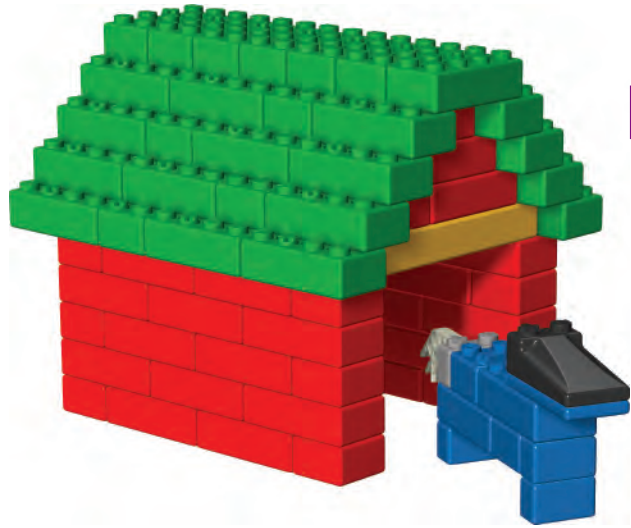

1 - 2

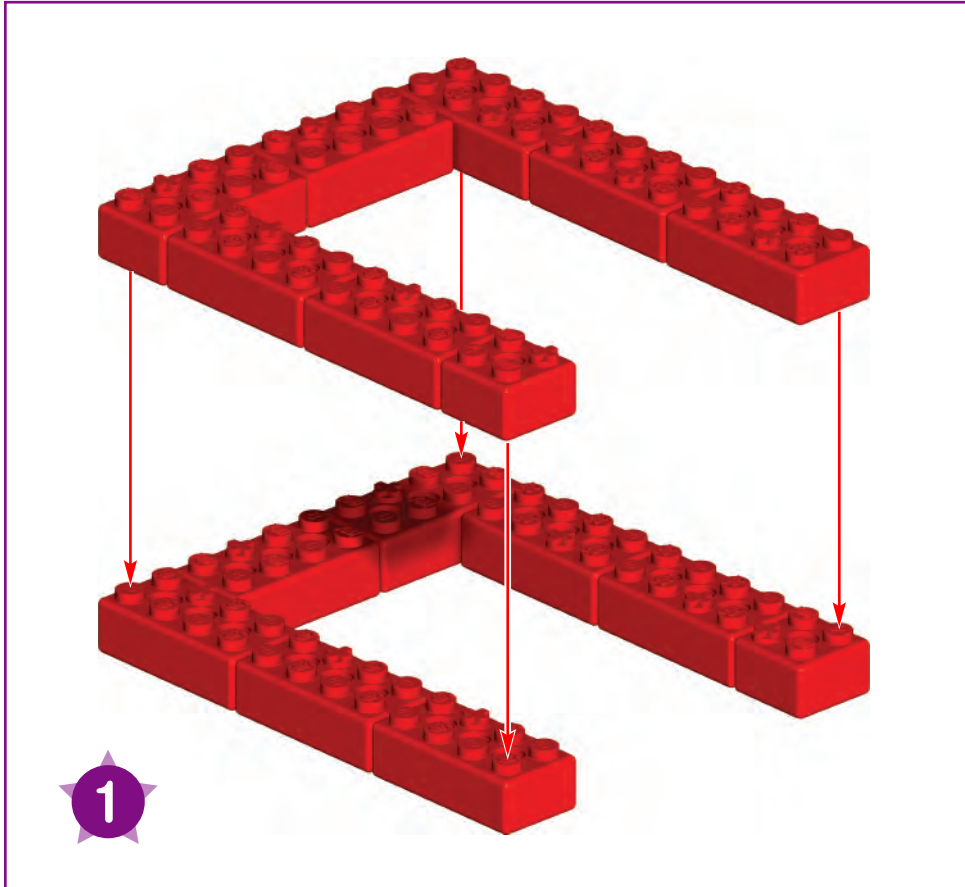

1

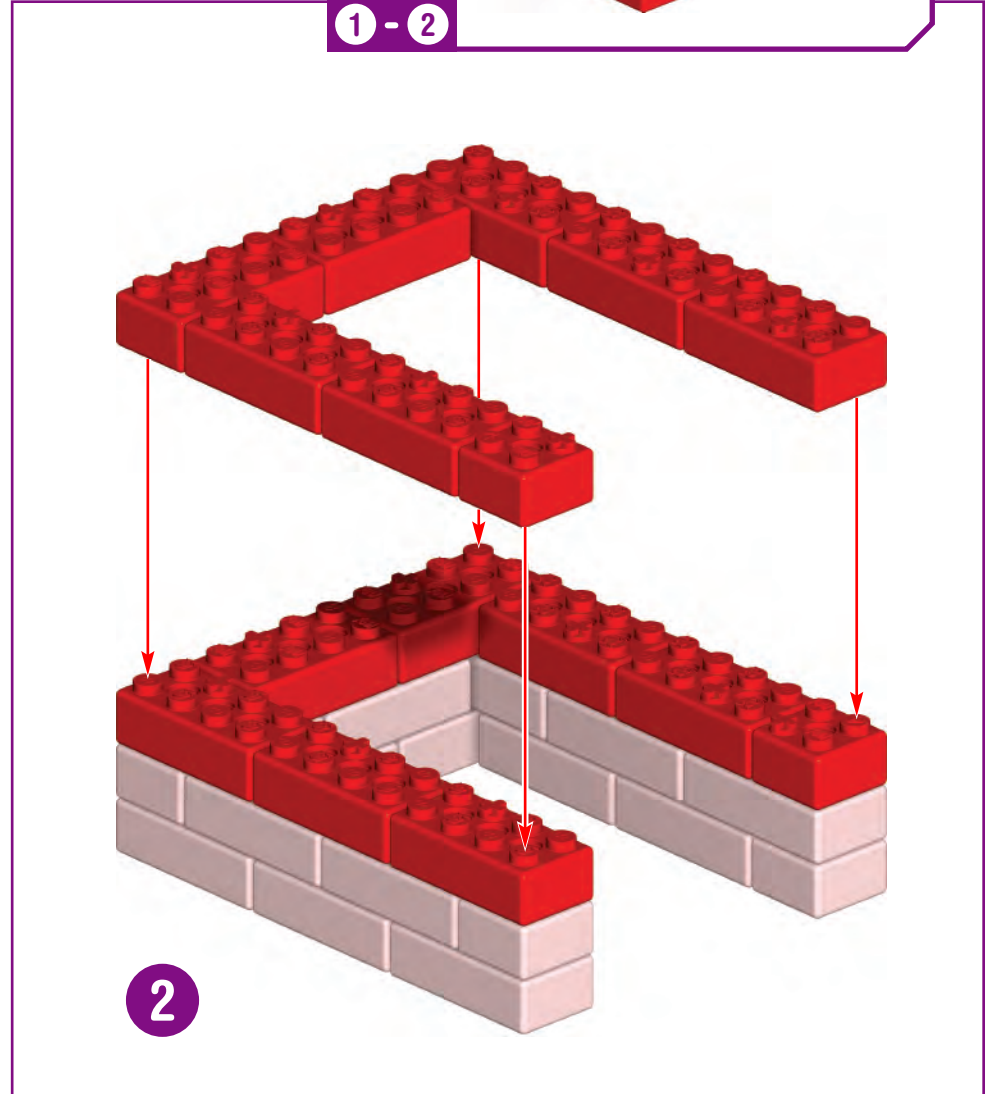

2

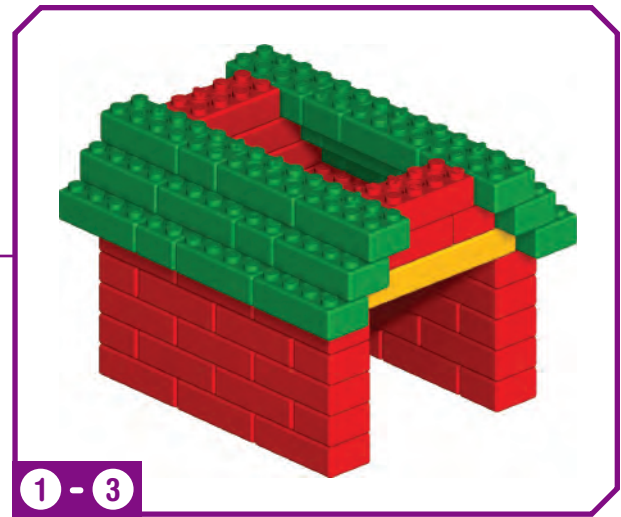
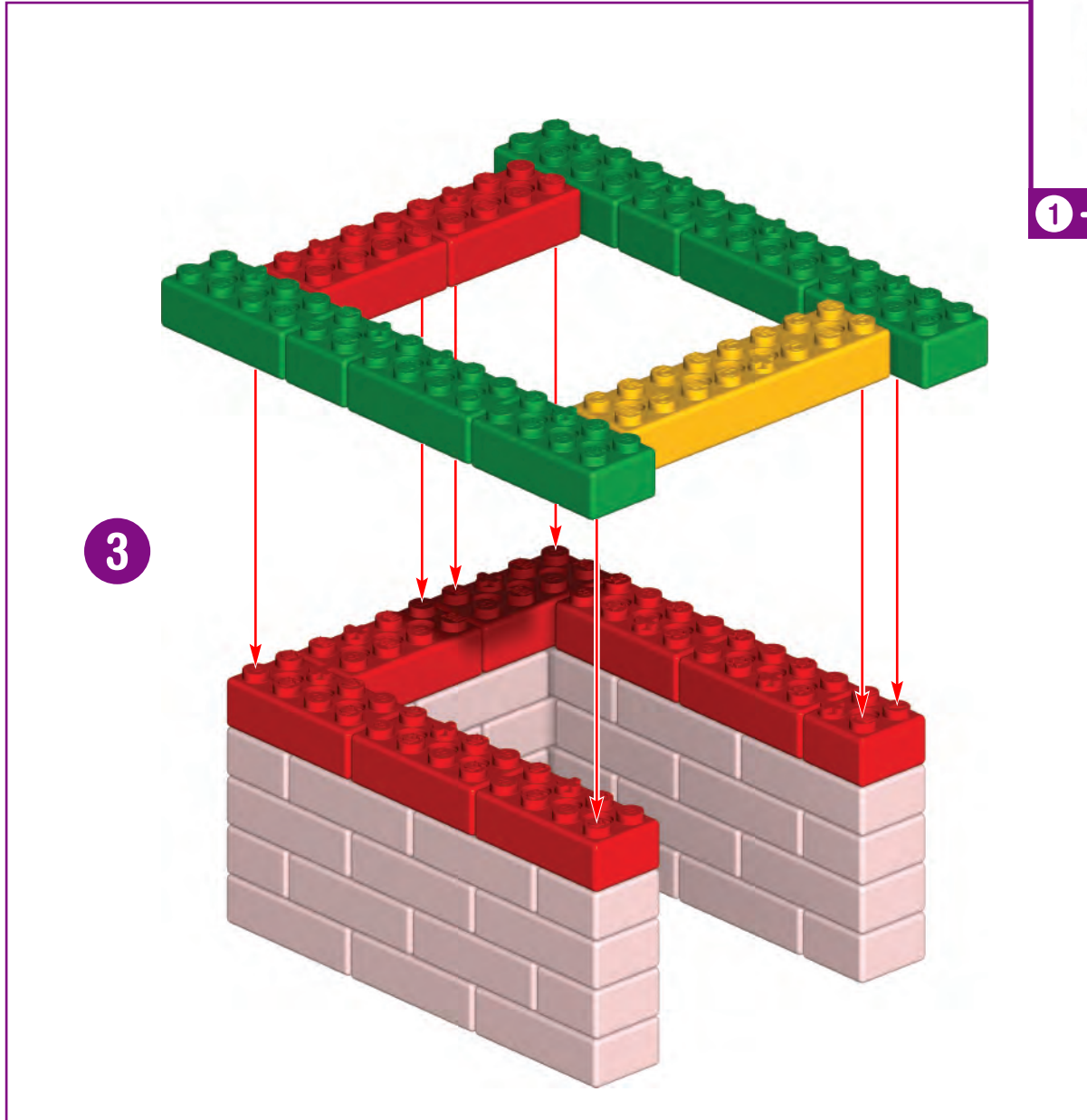

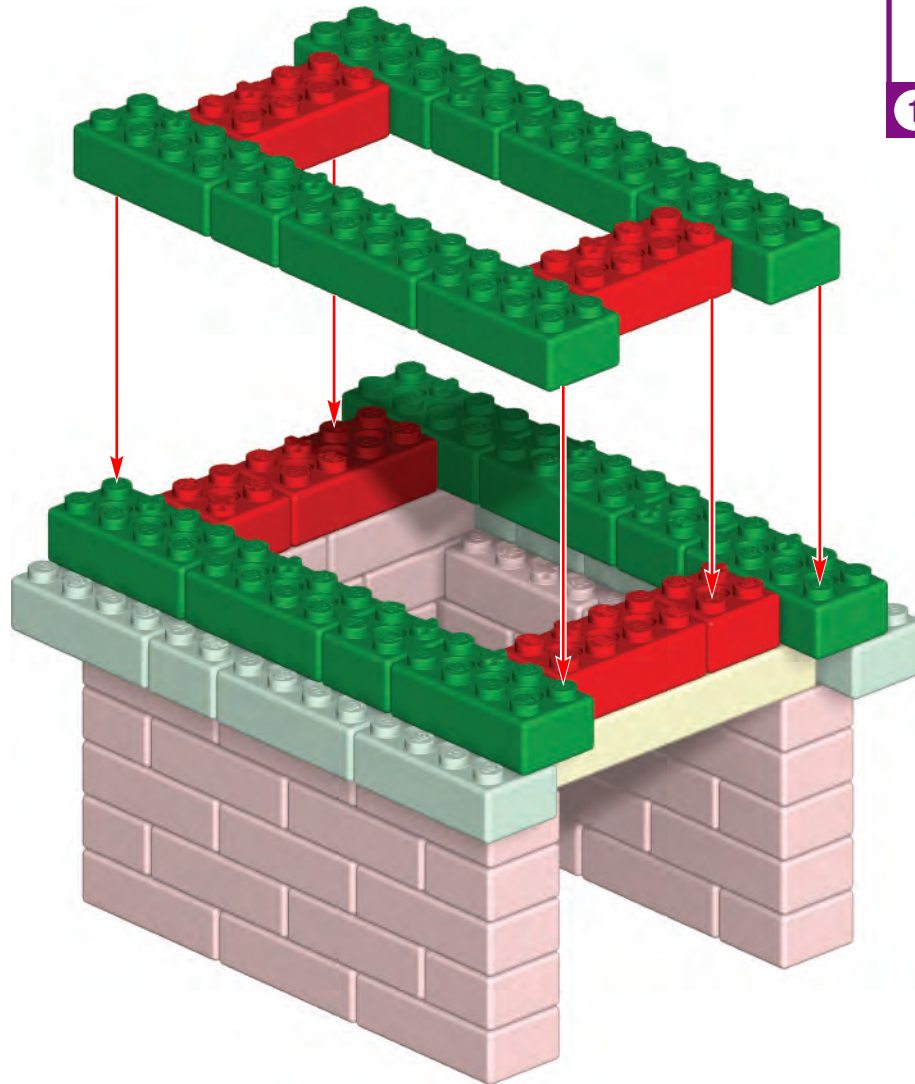

1 - 4

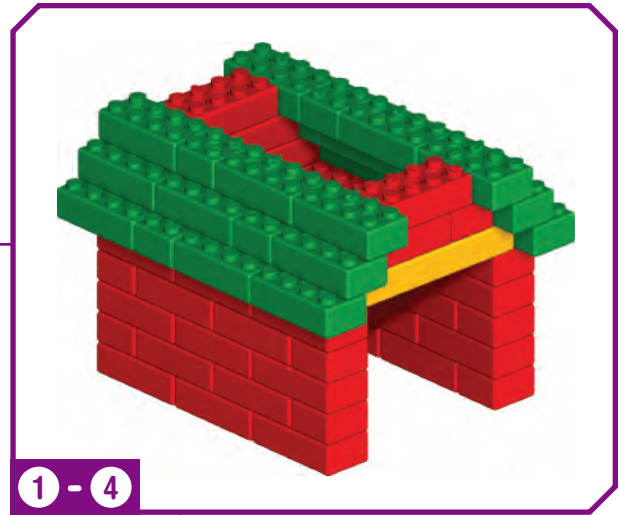

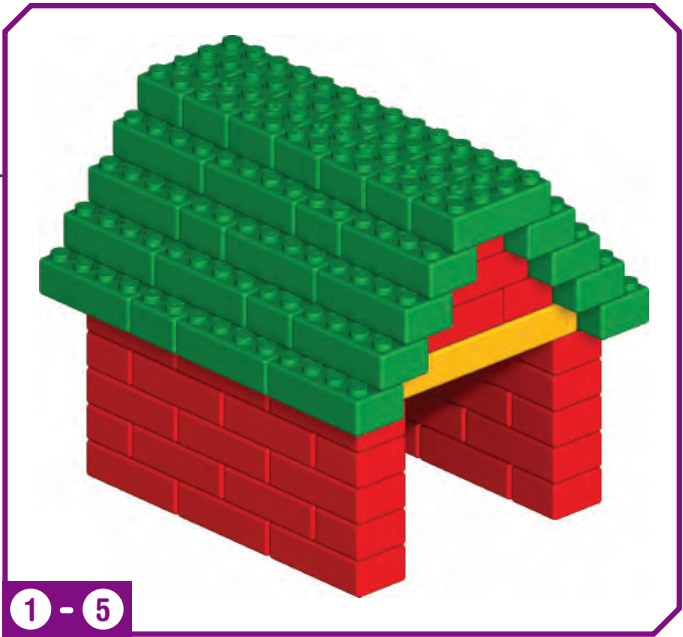
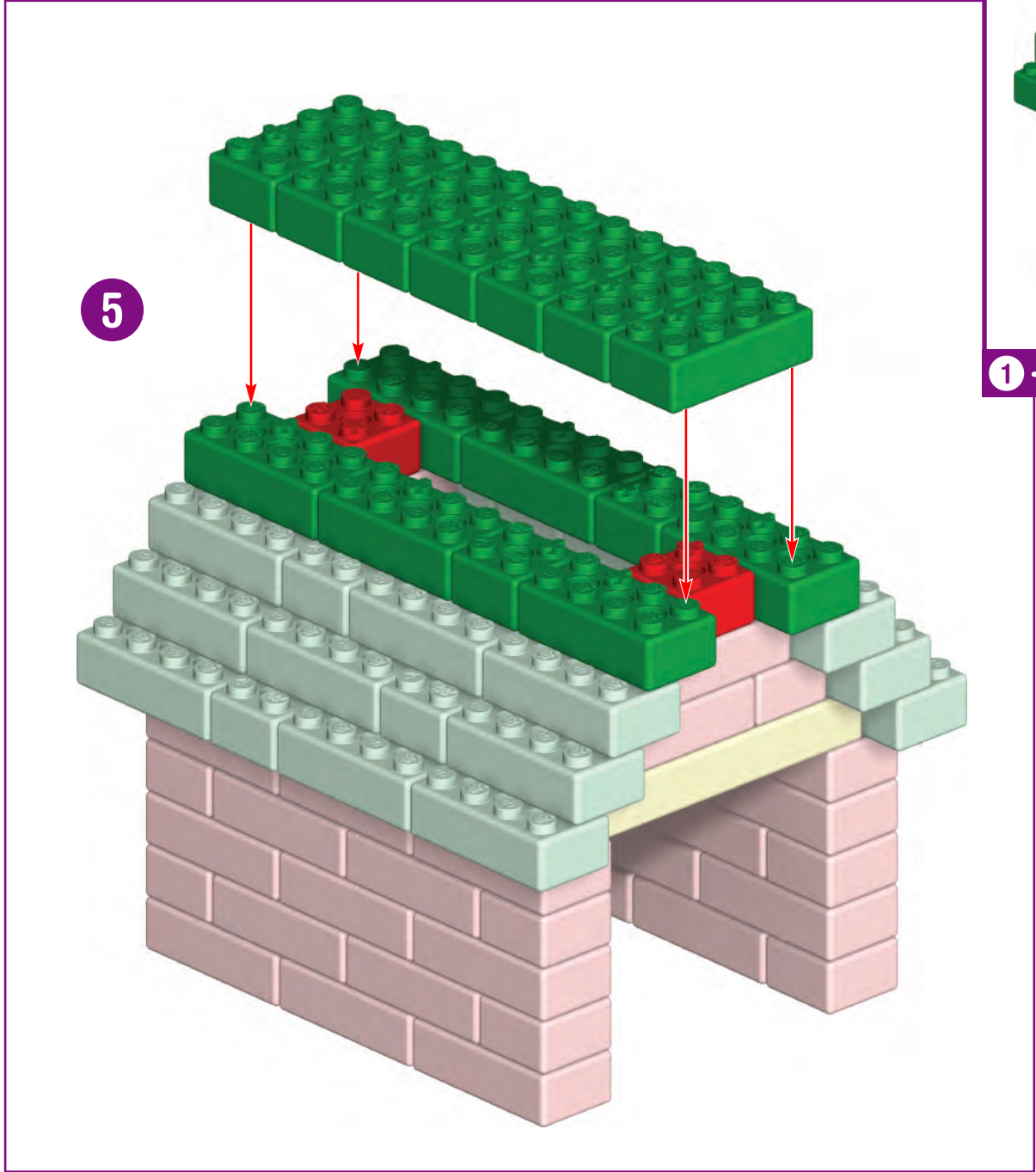

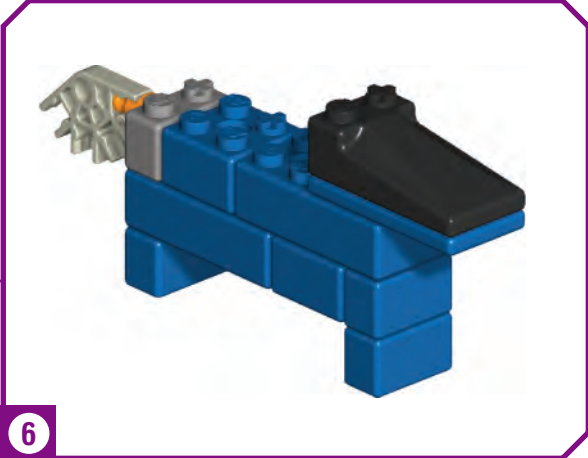
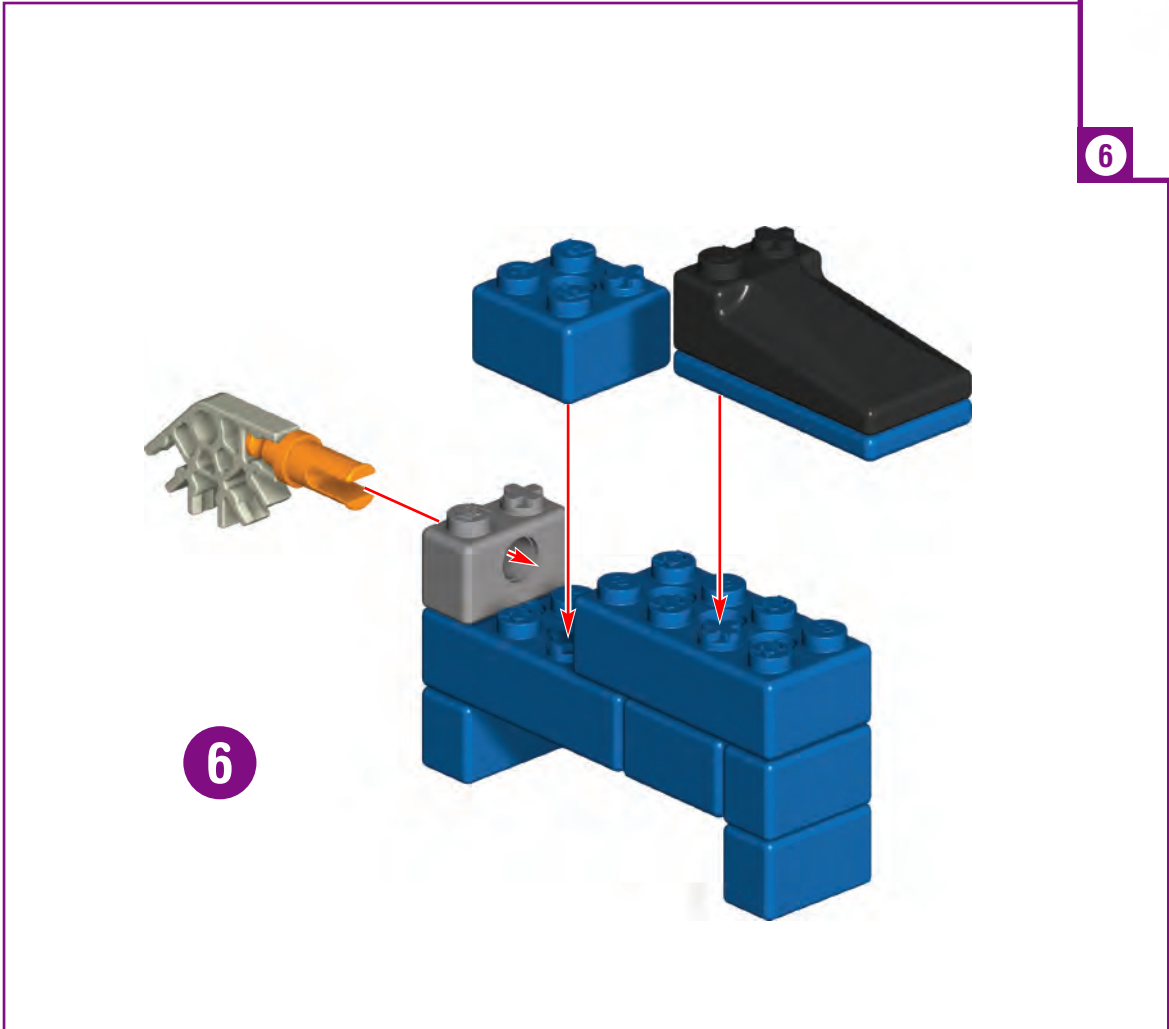

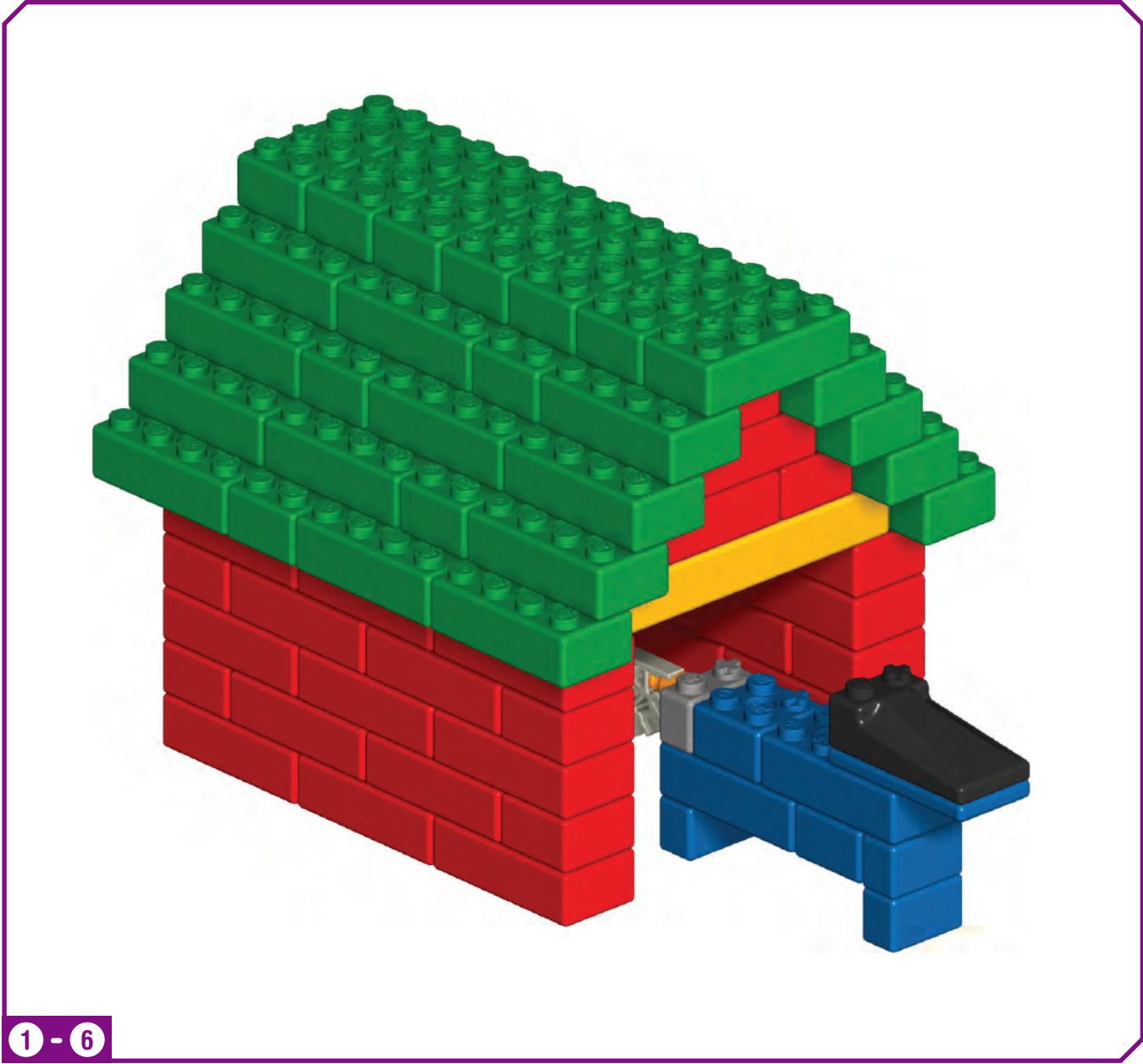

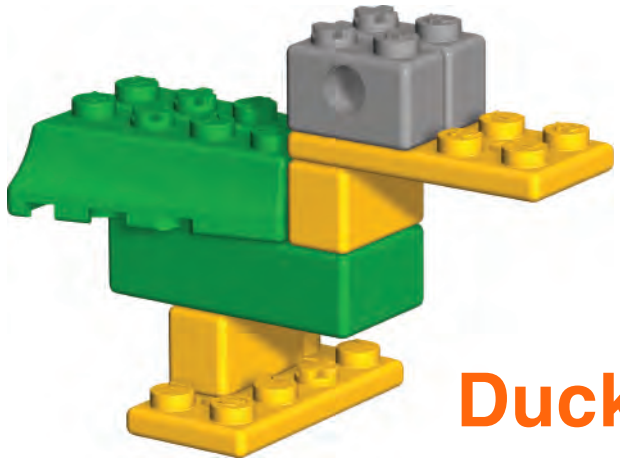

Duck

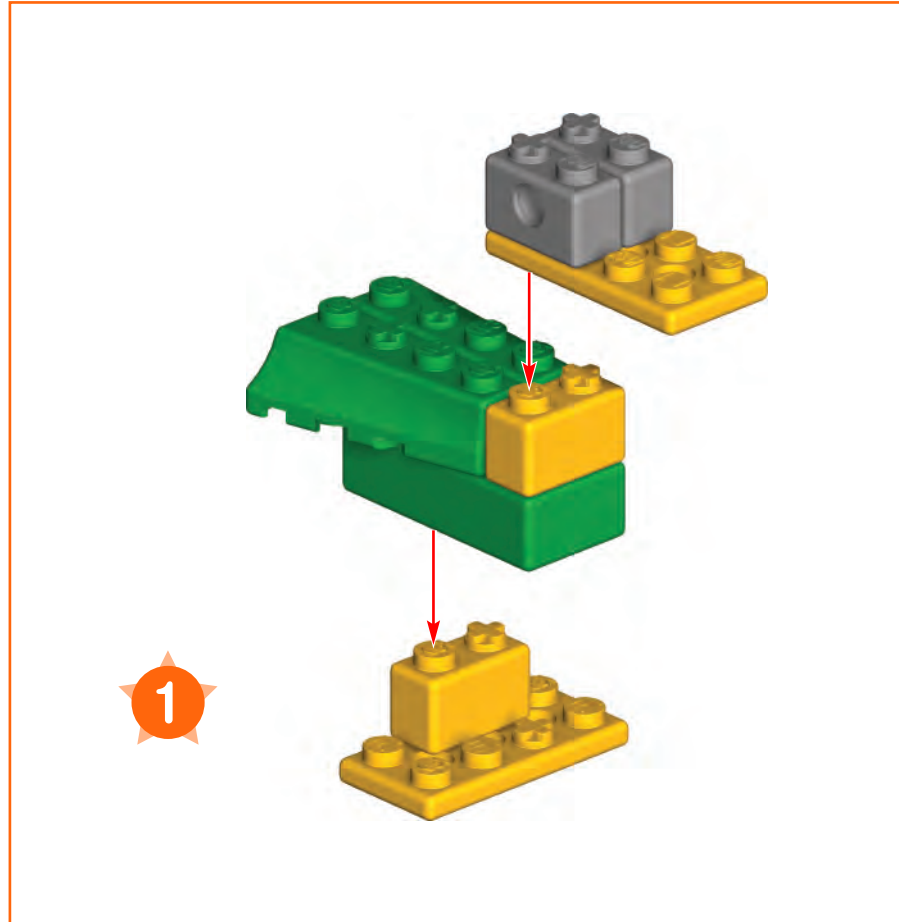

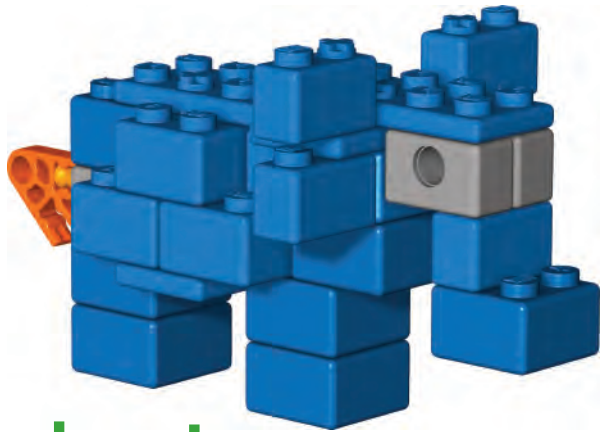

# Elephant

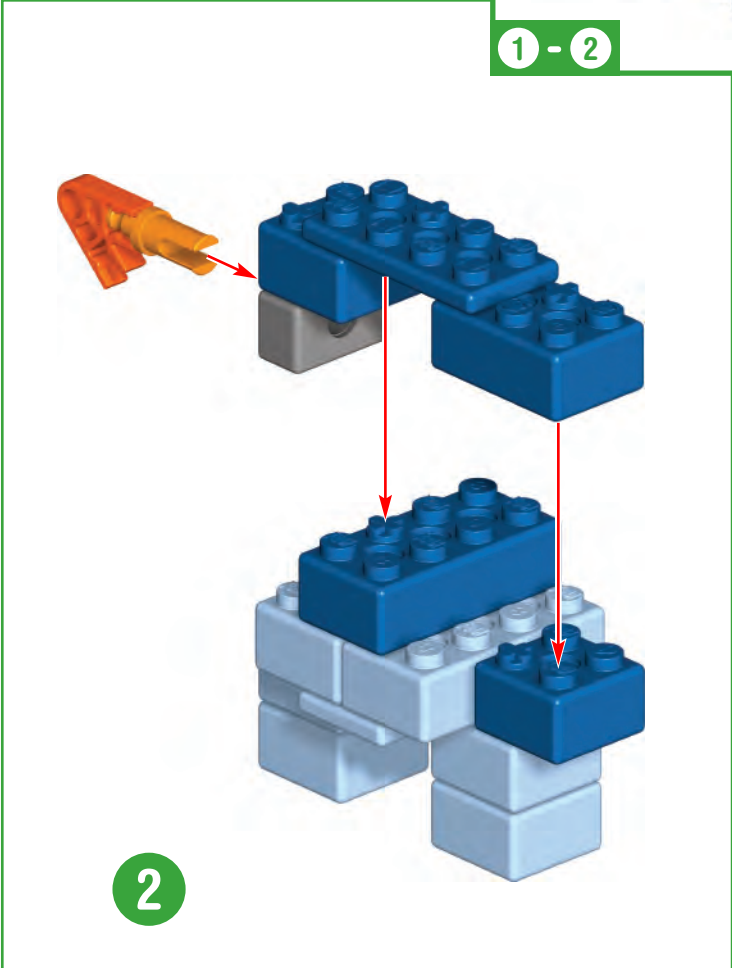
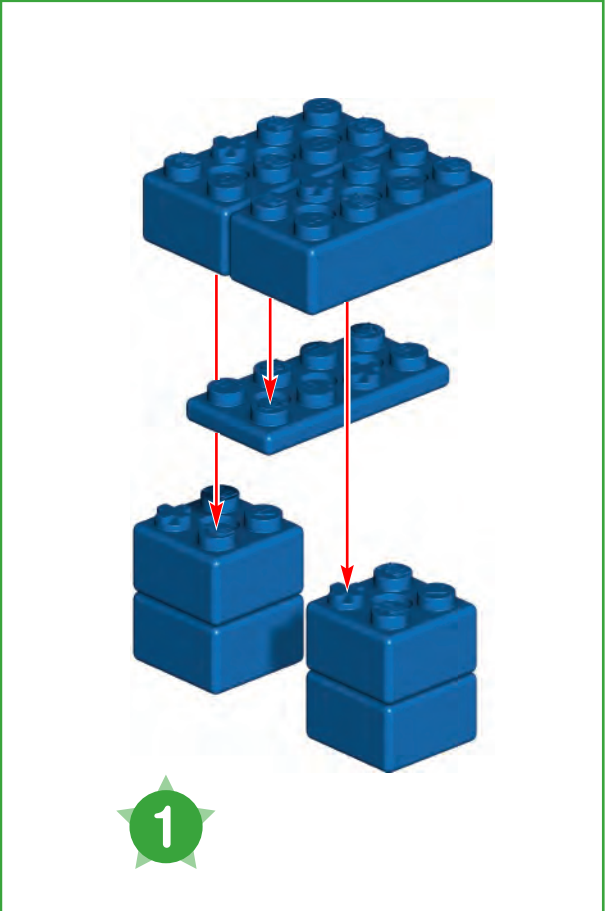
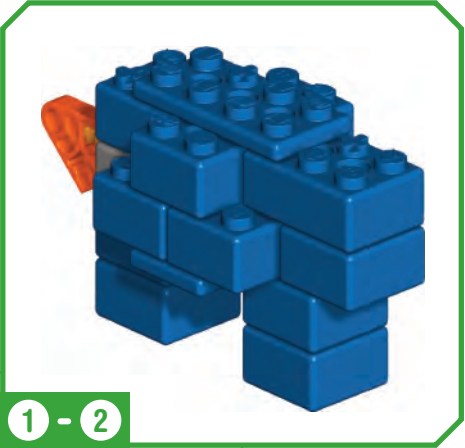

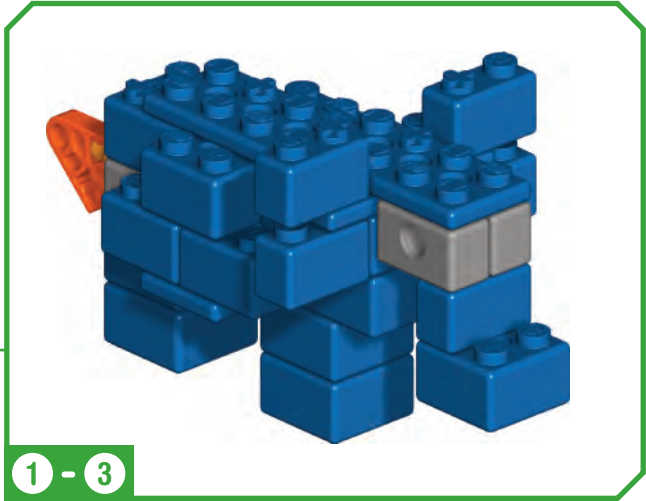
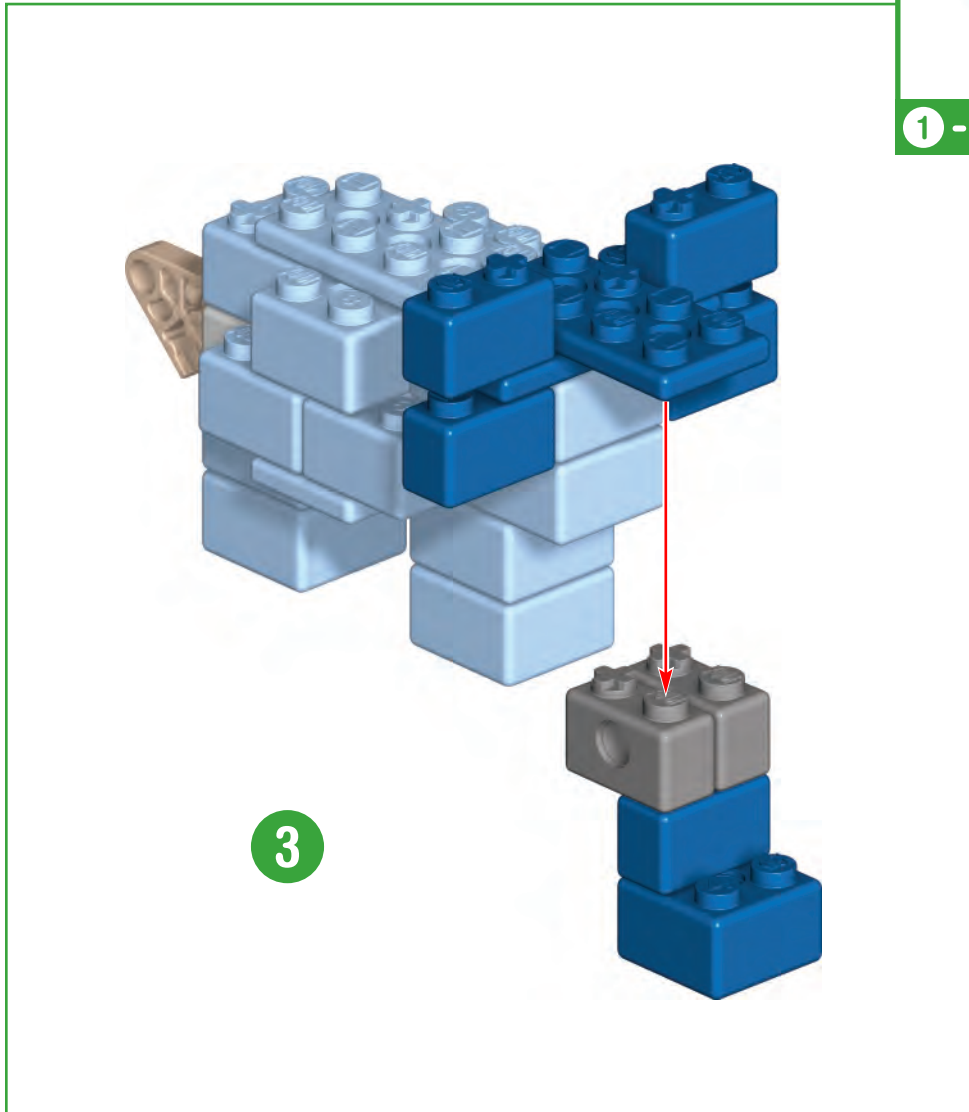



# Front End Loader

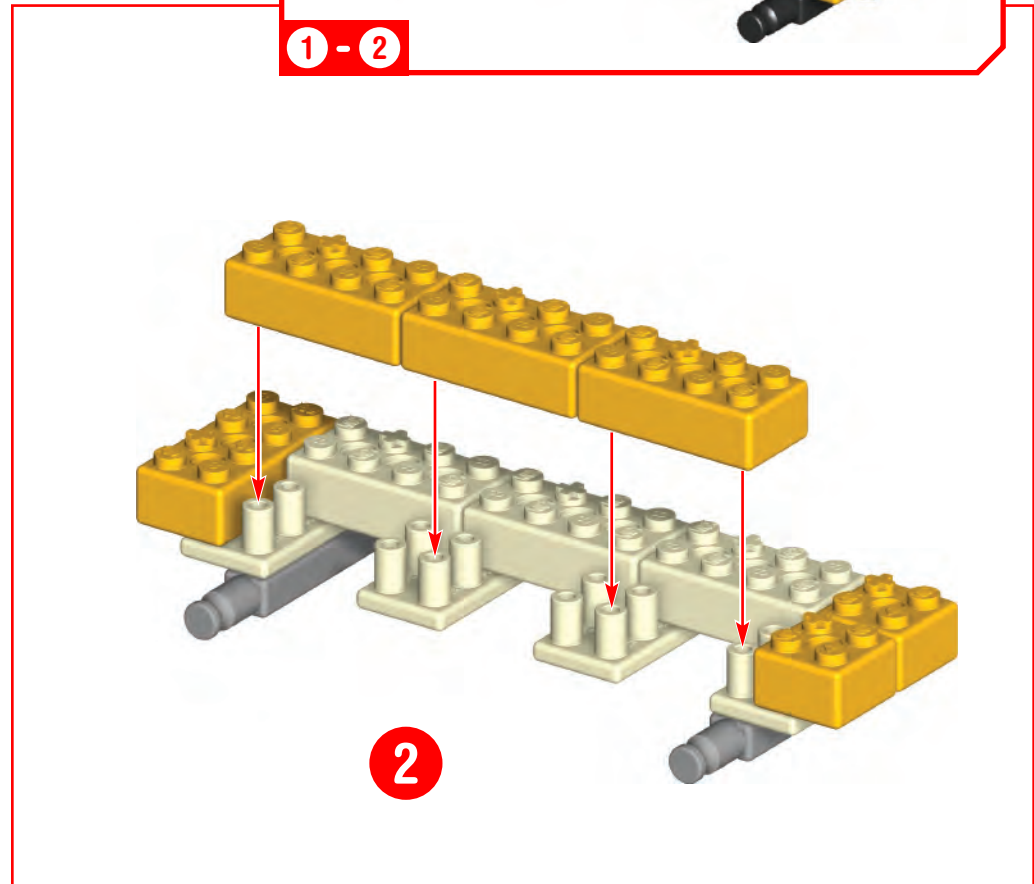
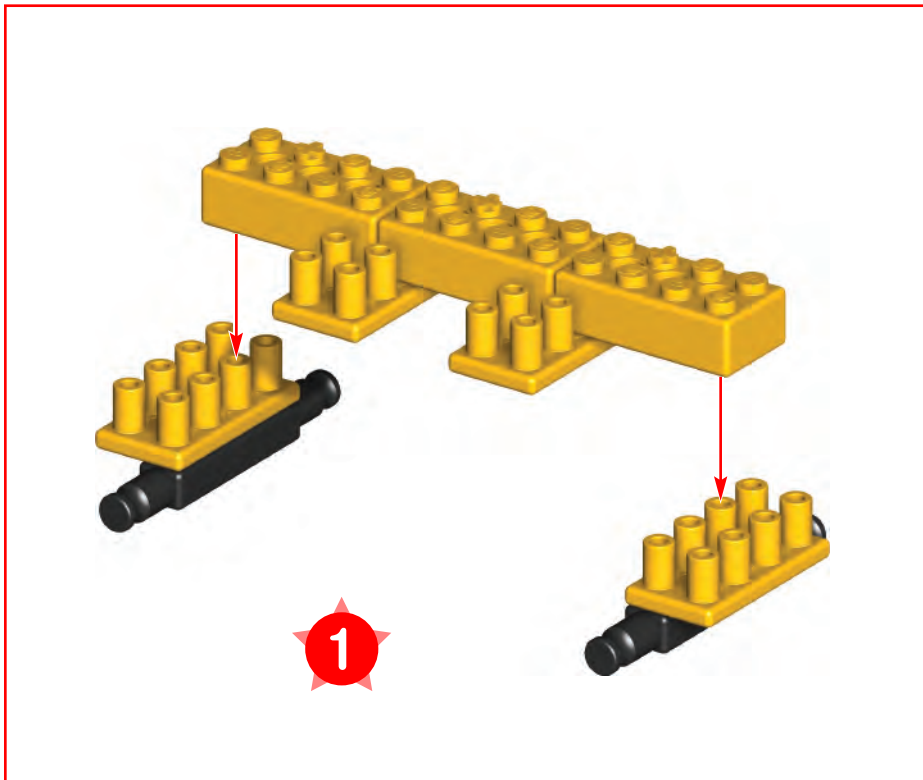
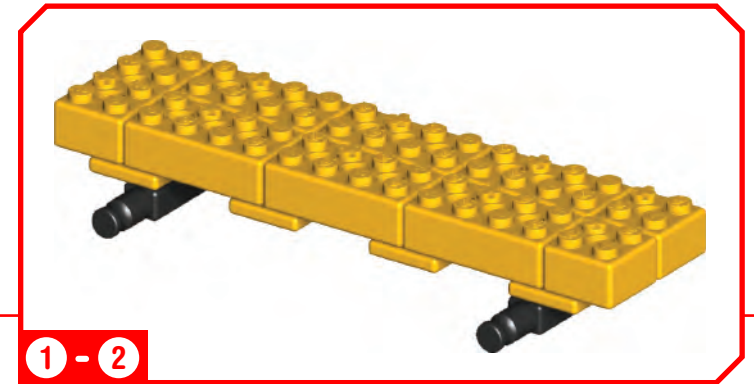

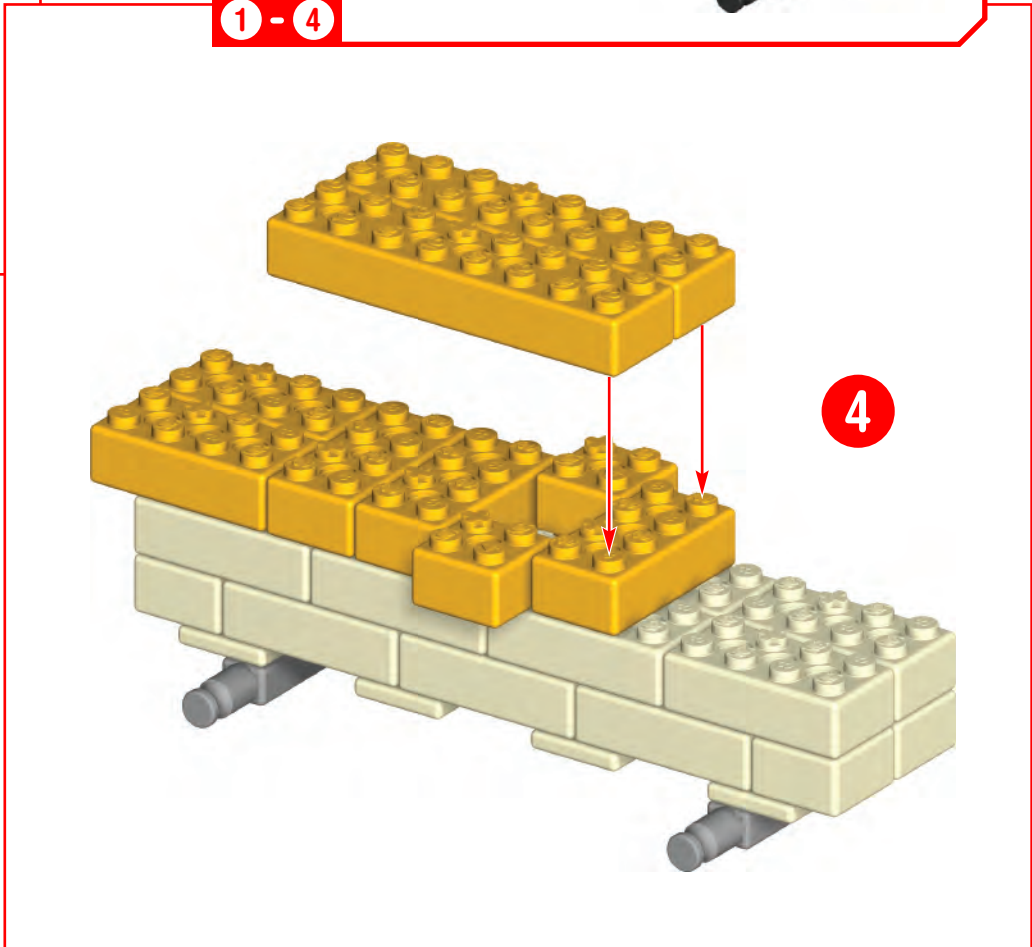
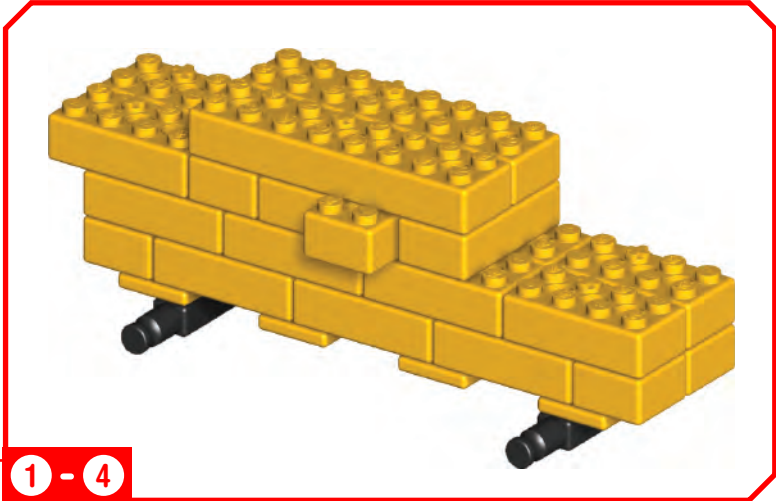
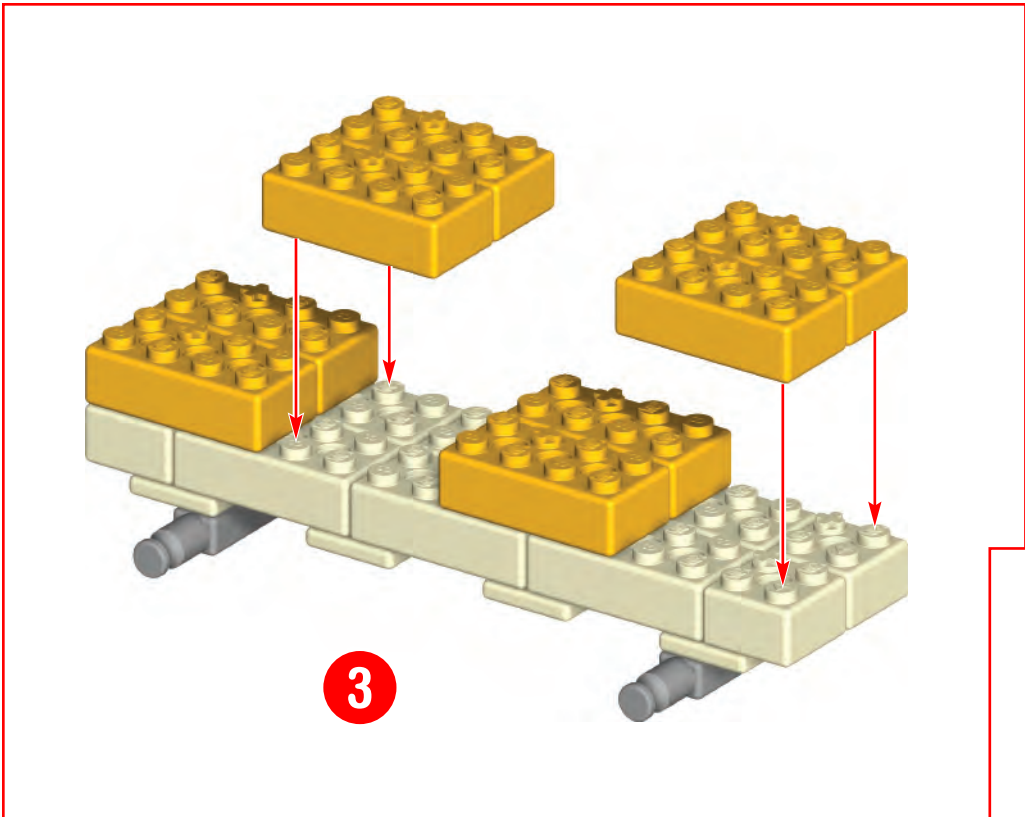

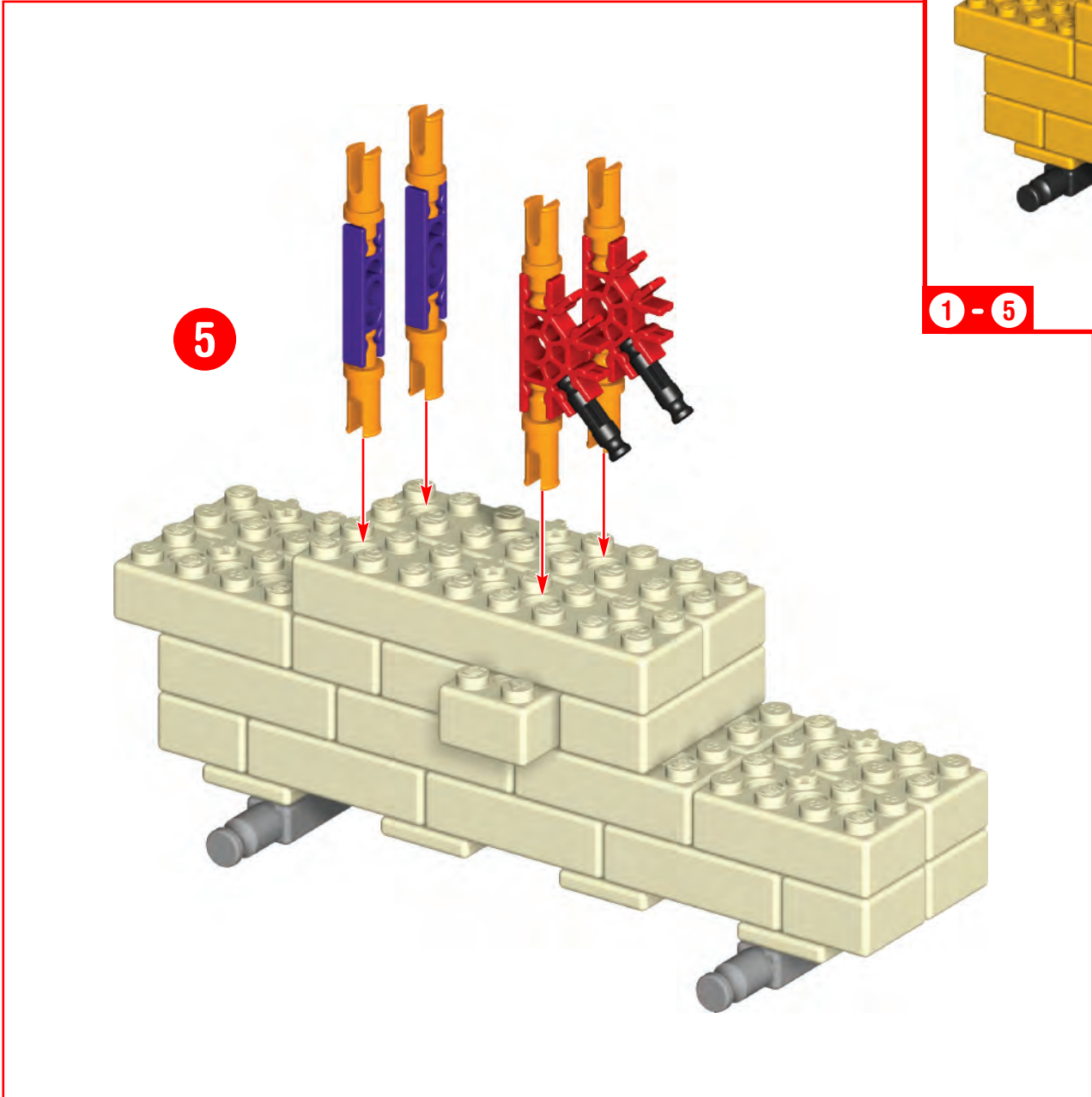

6

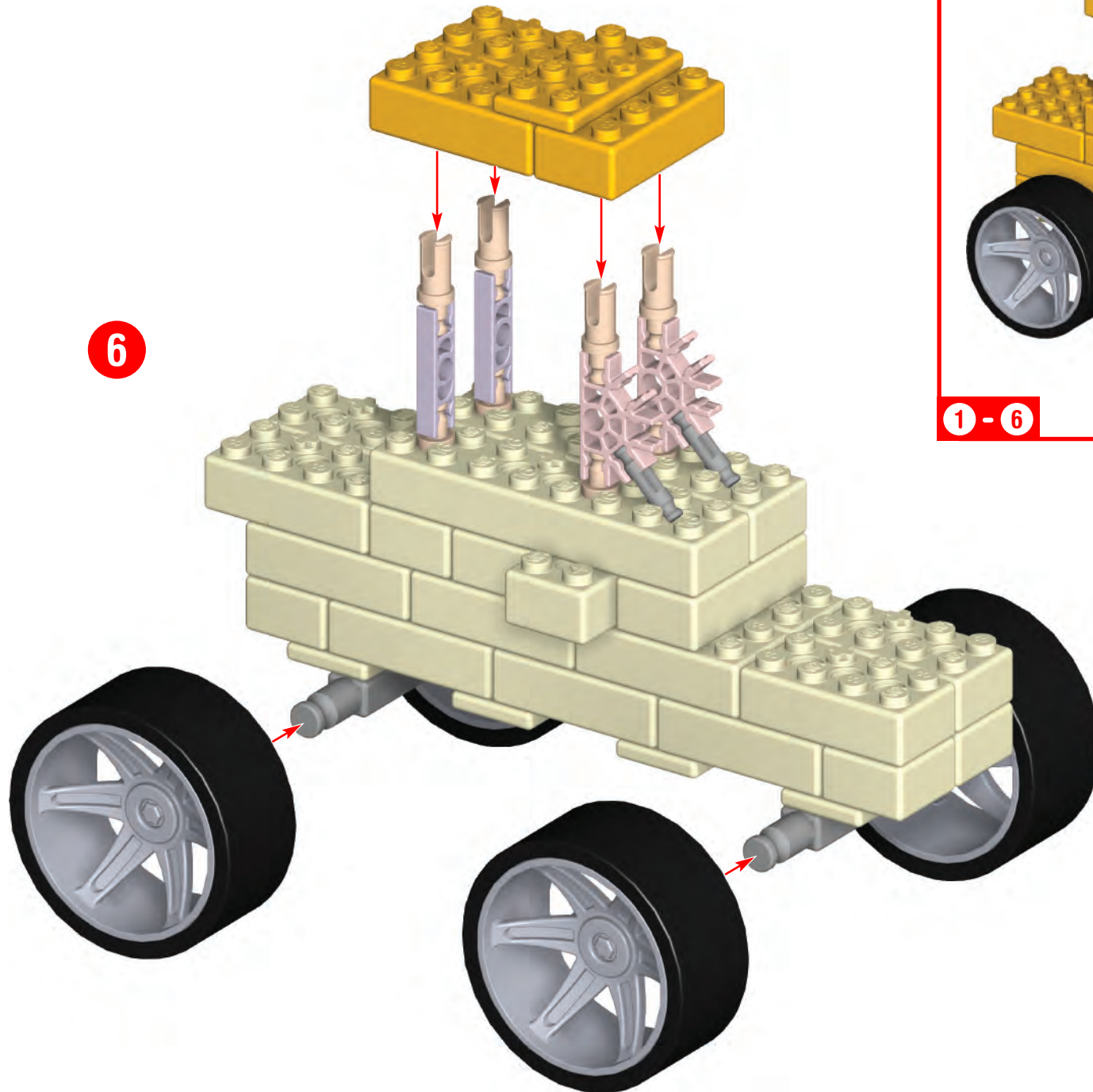

1 - 6



7

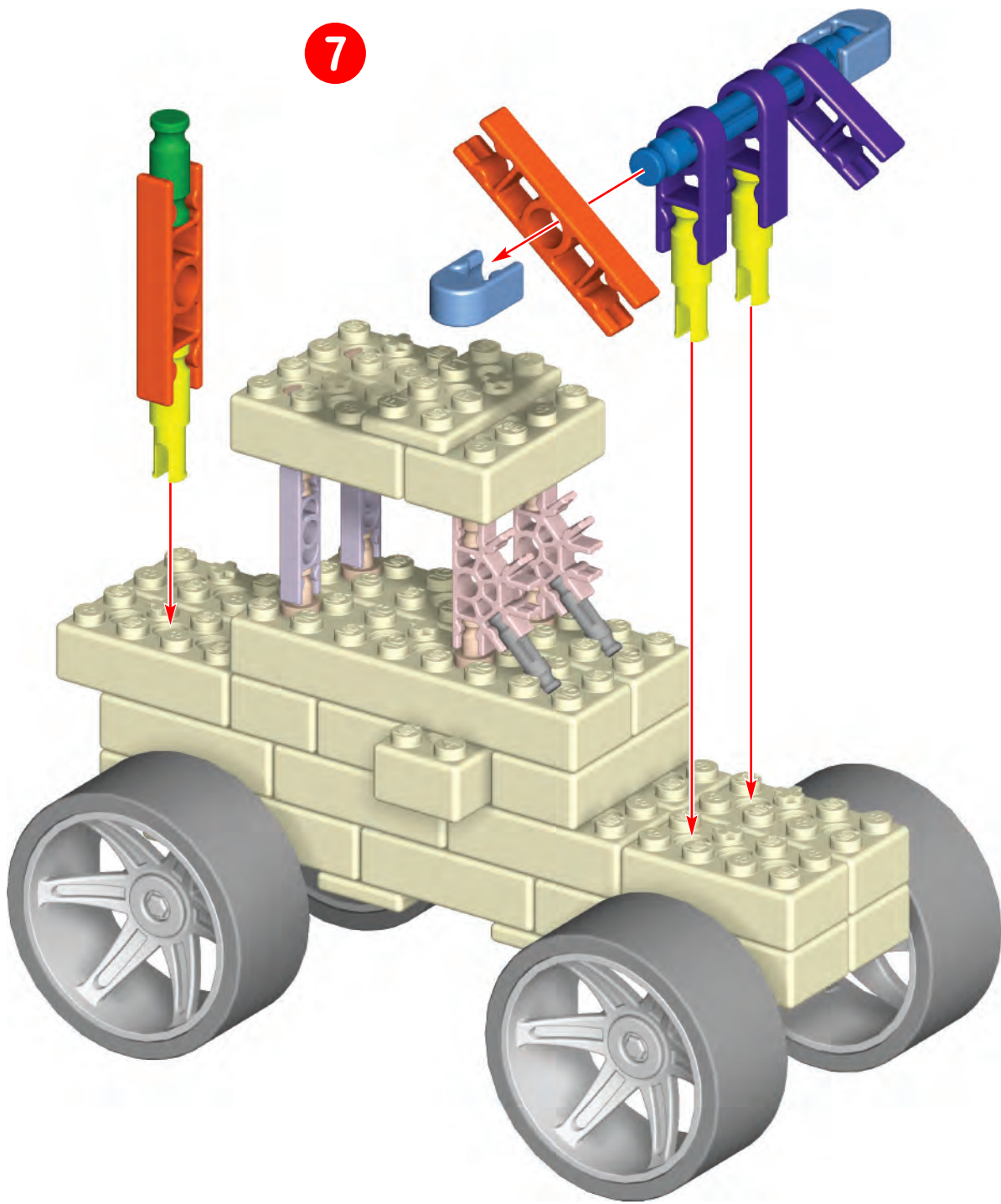

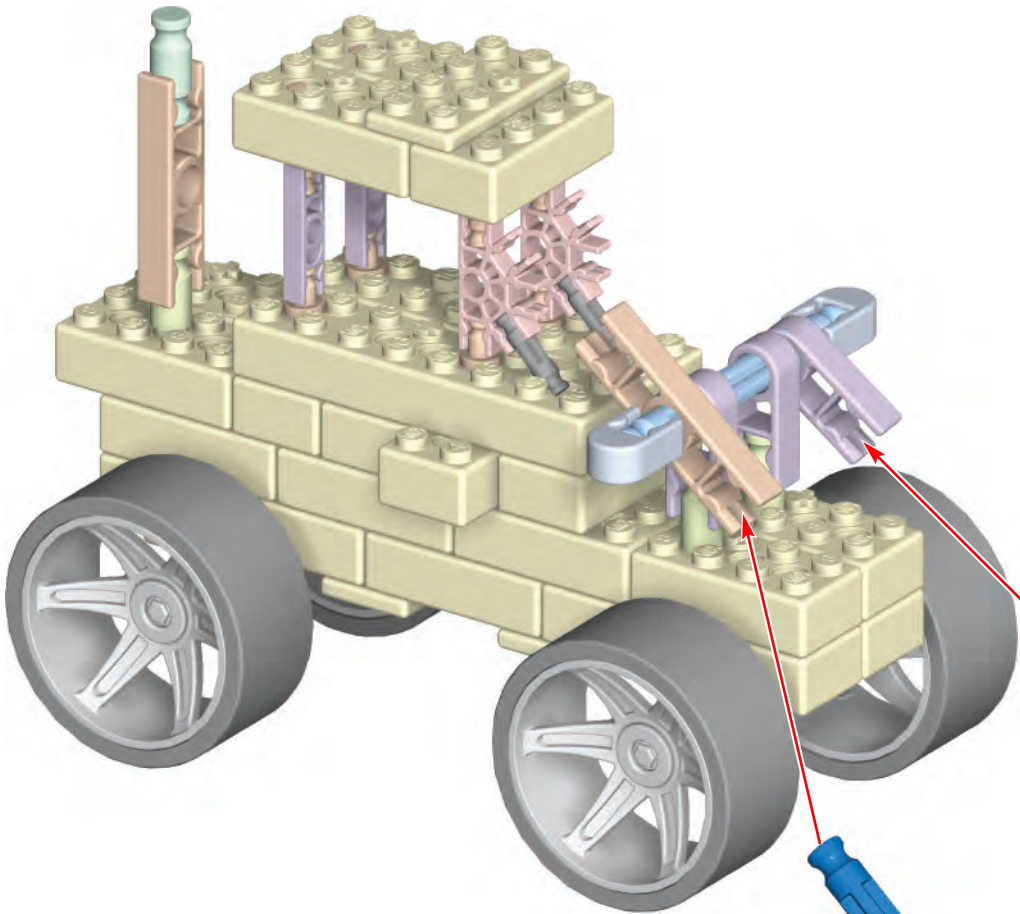

8

1 - 8



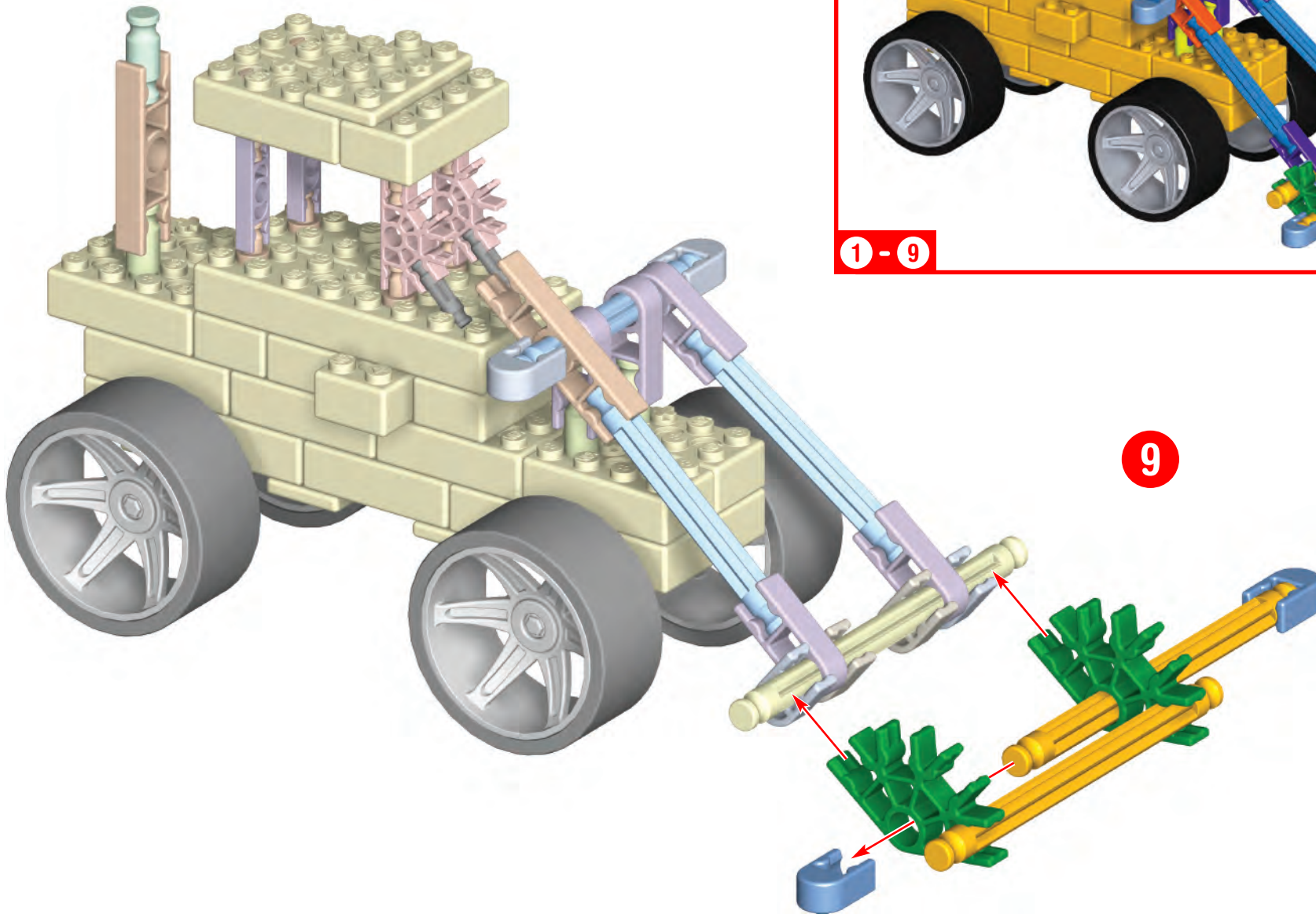

1 - 9





# Jet Plane

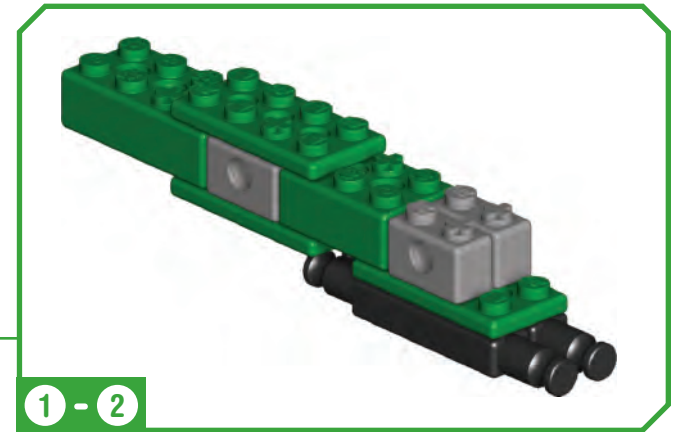

1 - 2

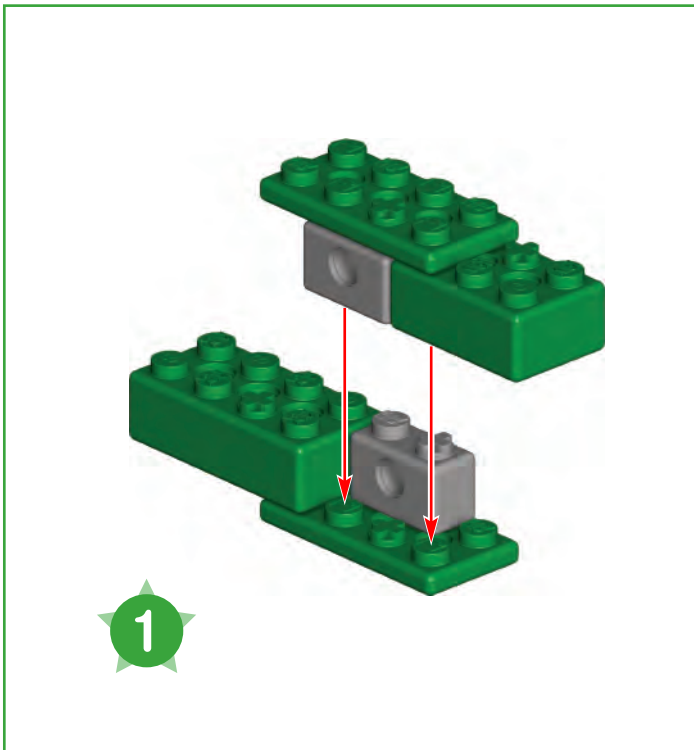

1

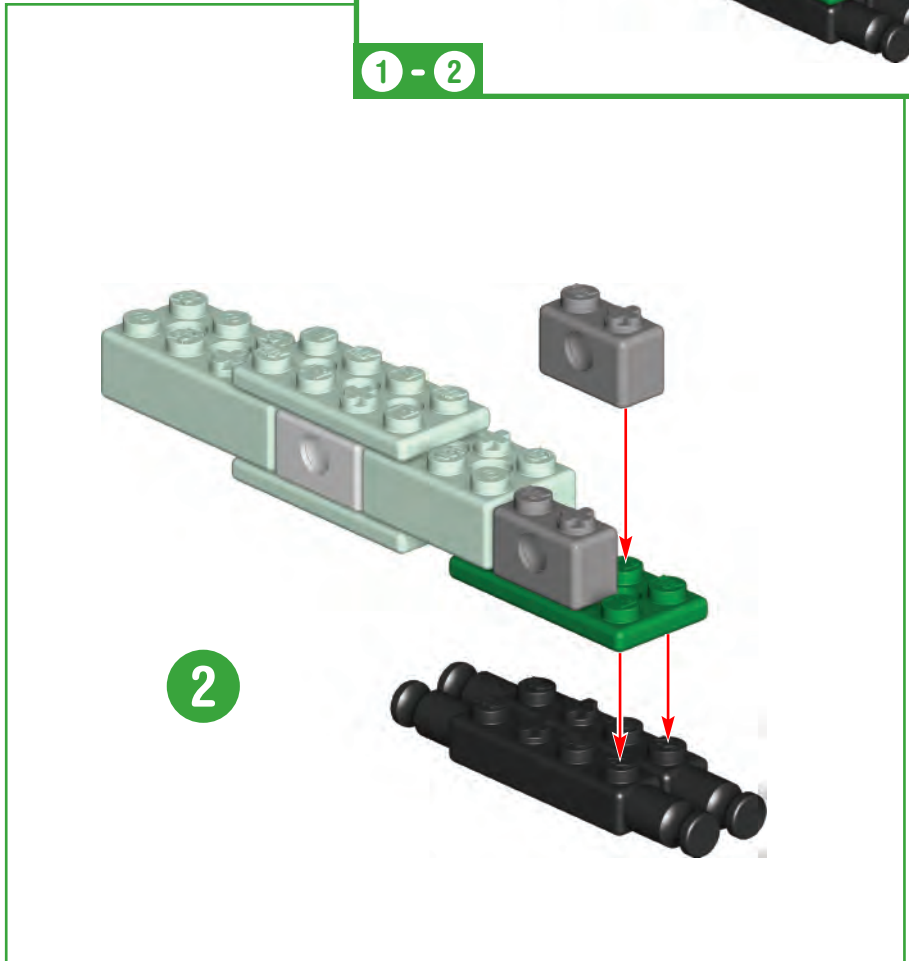

2

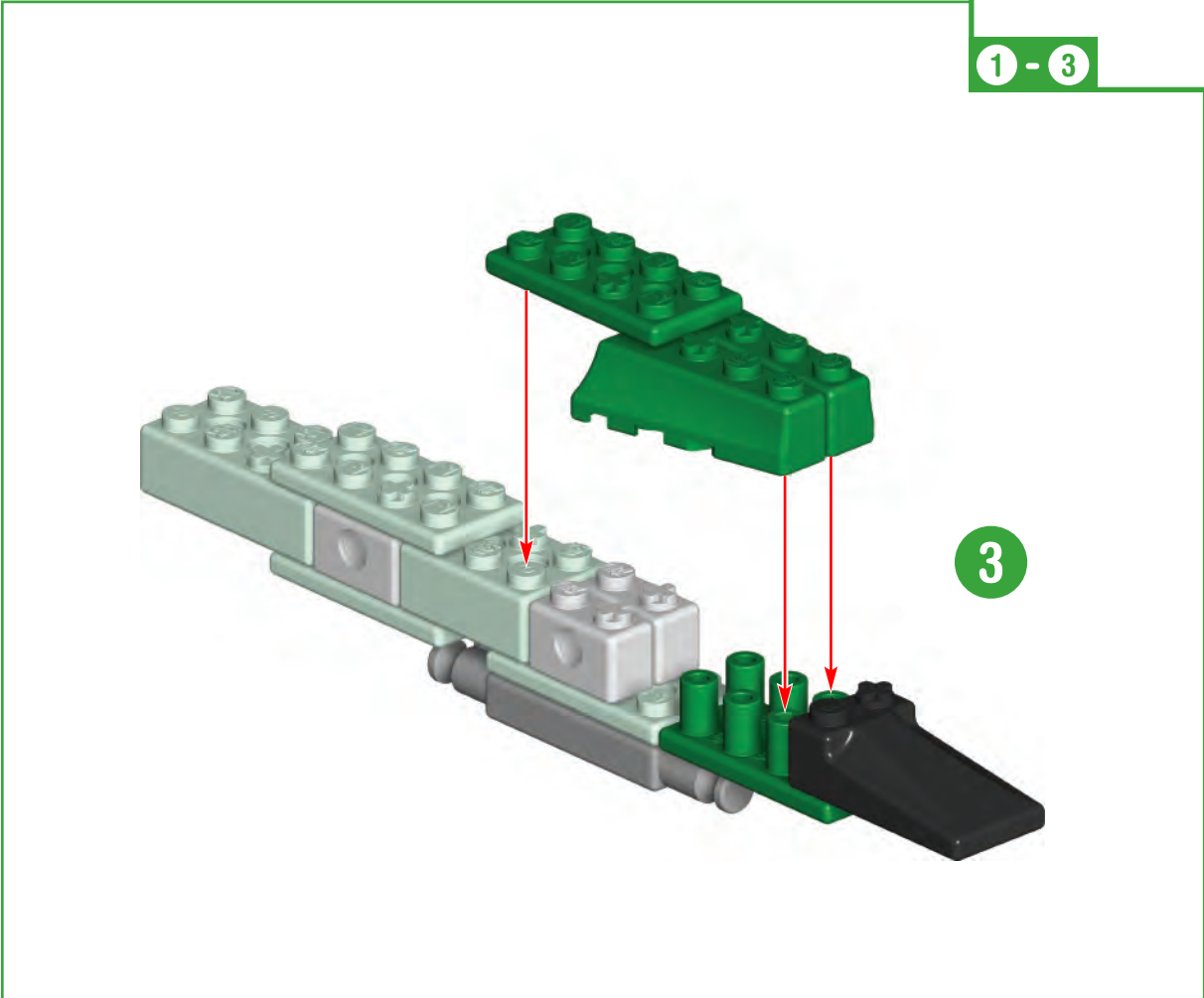
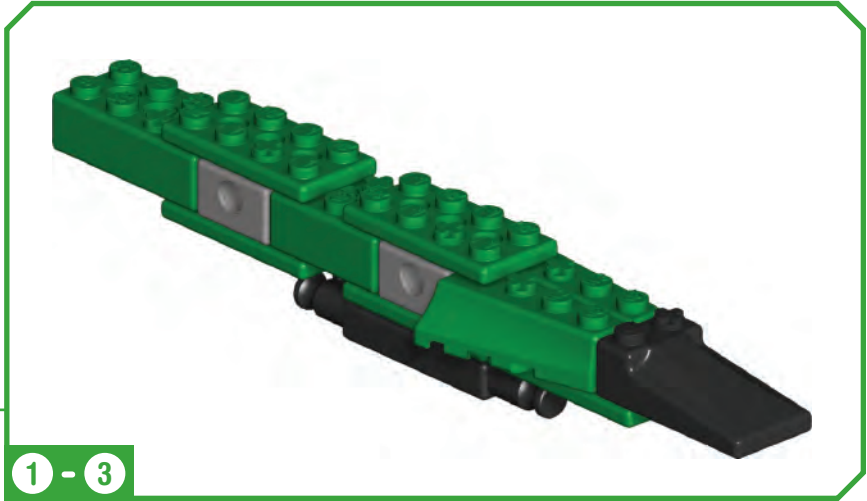

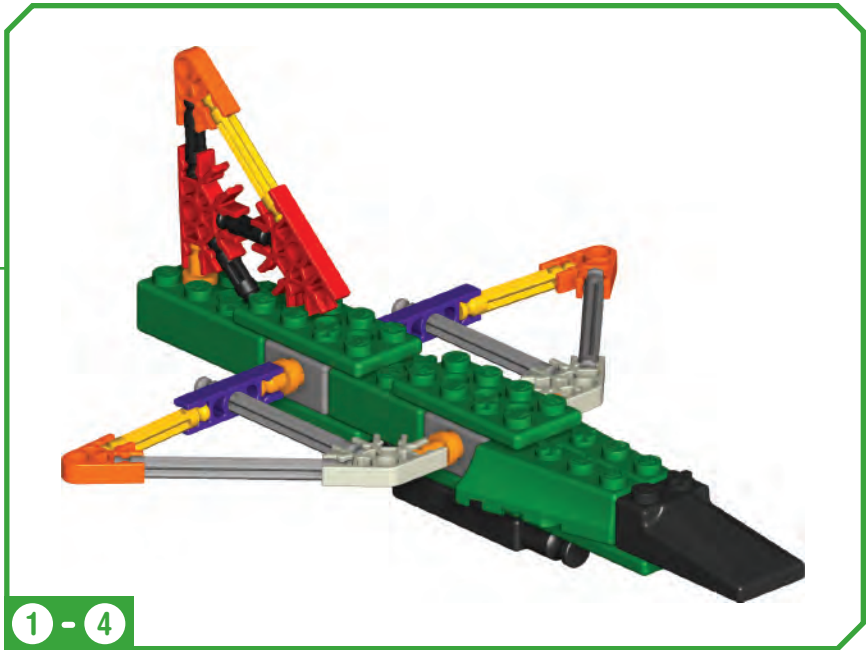
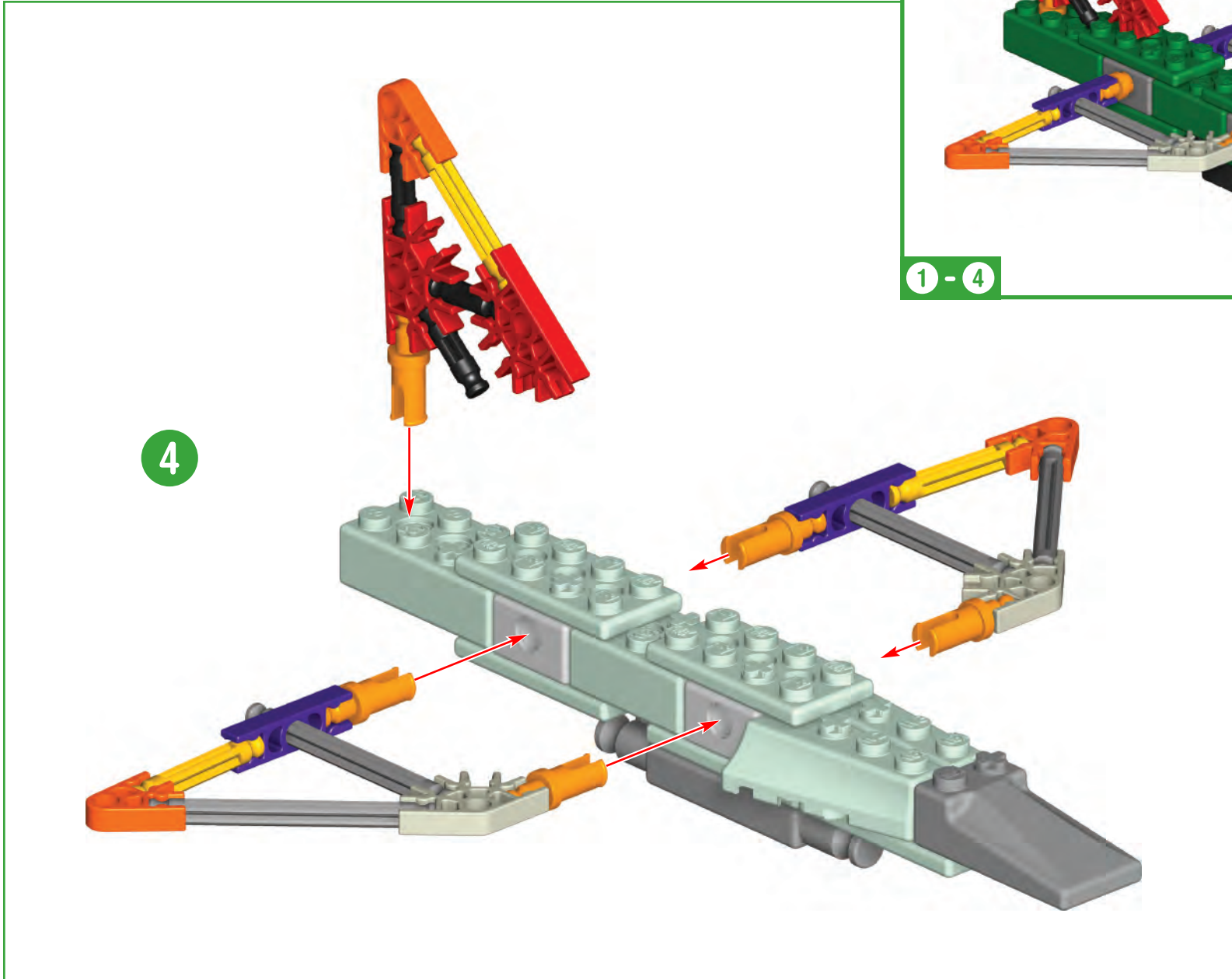

# Mayan Temple

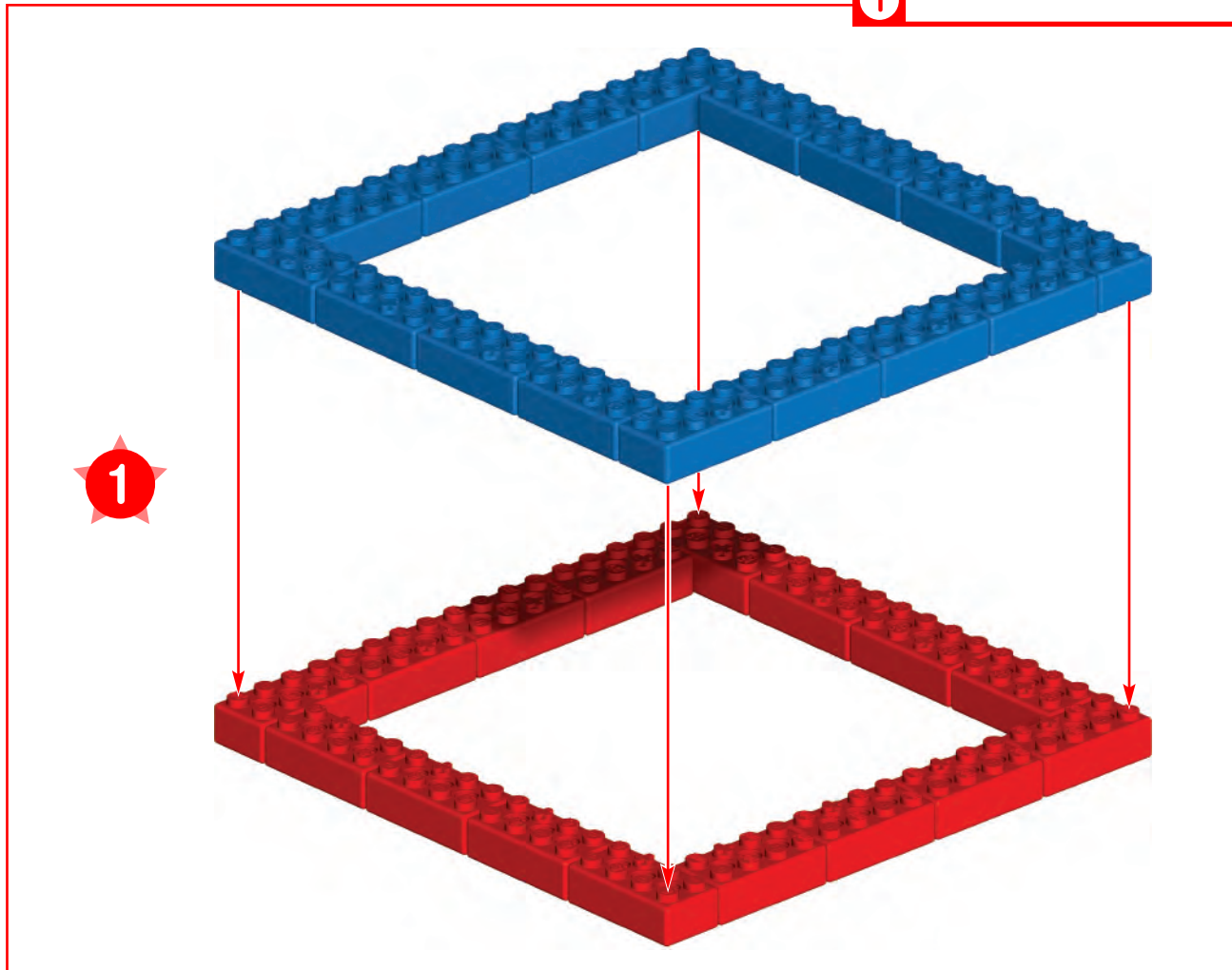
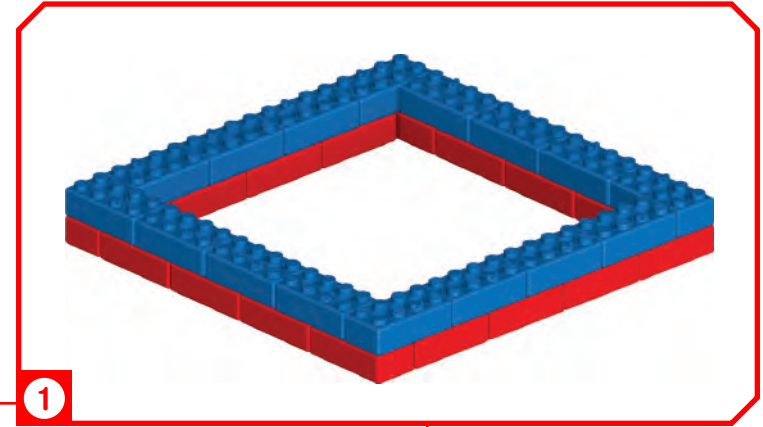

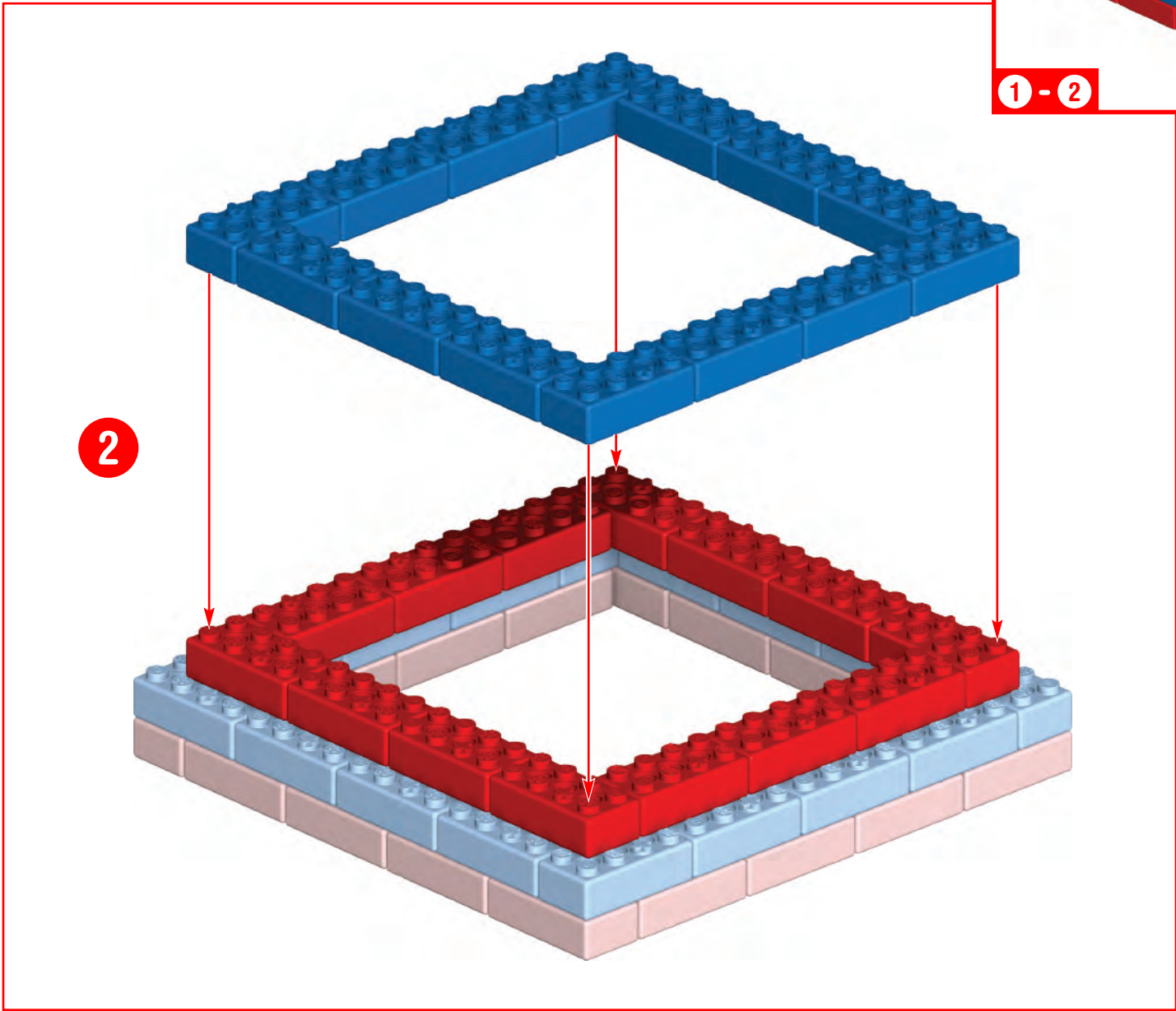
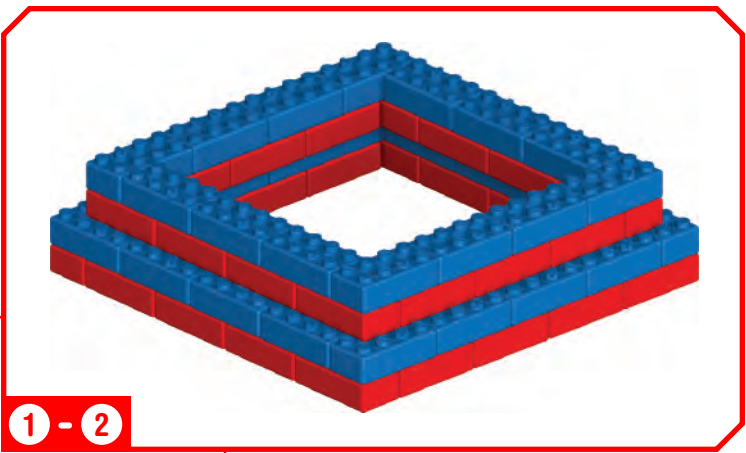

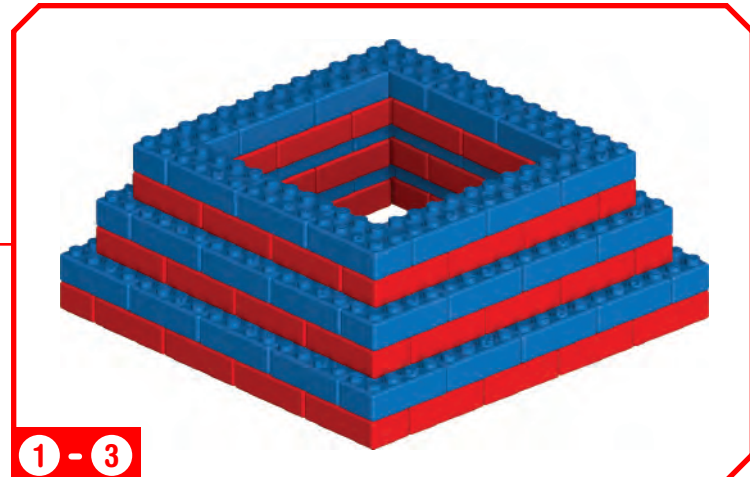
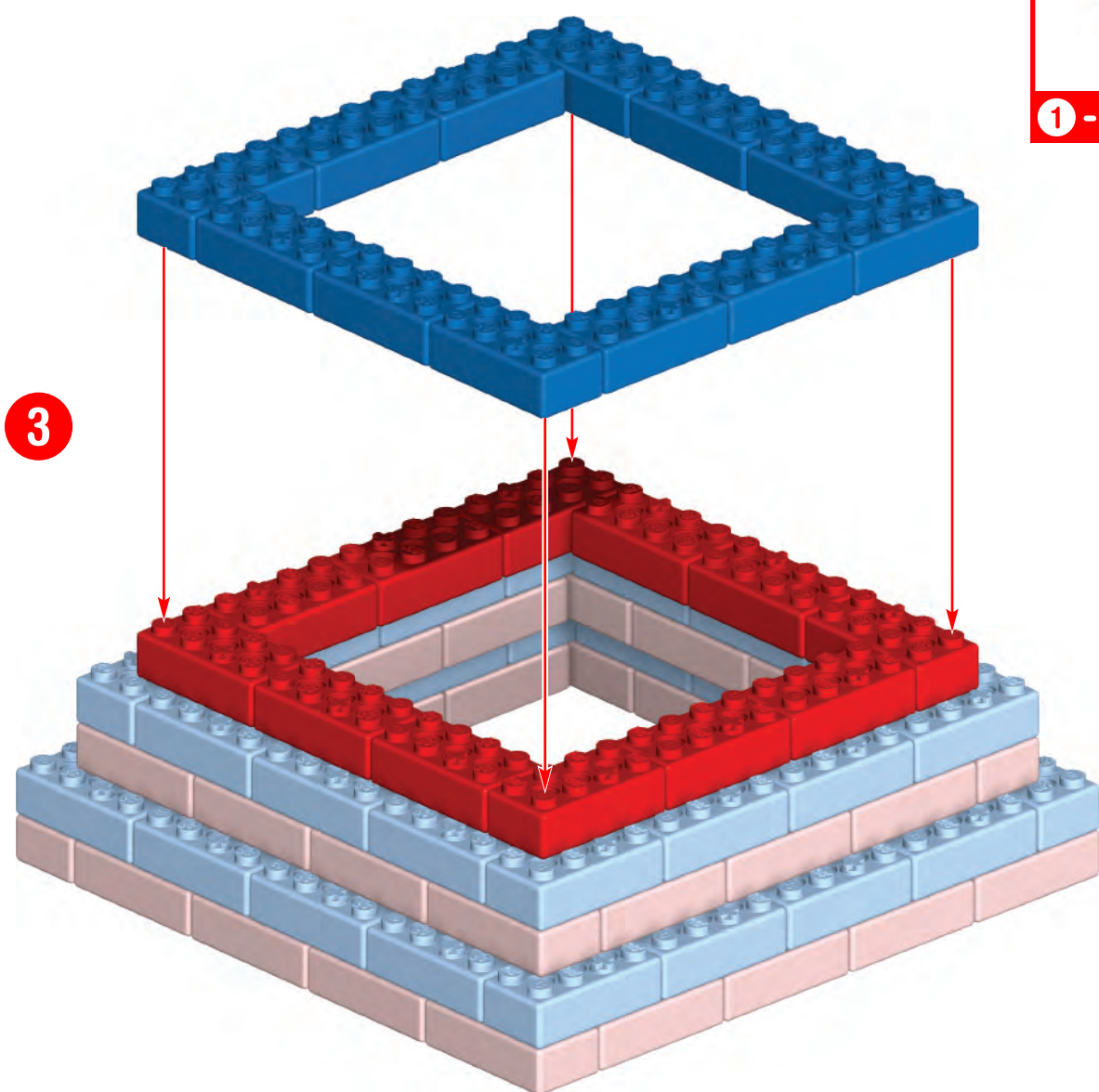

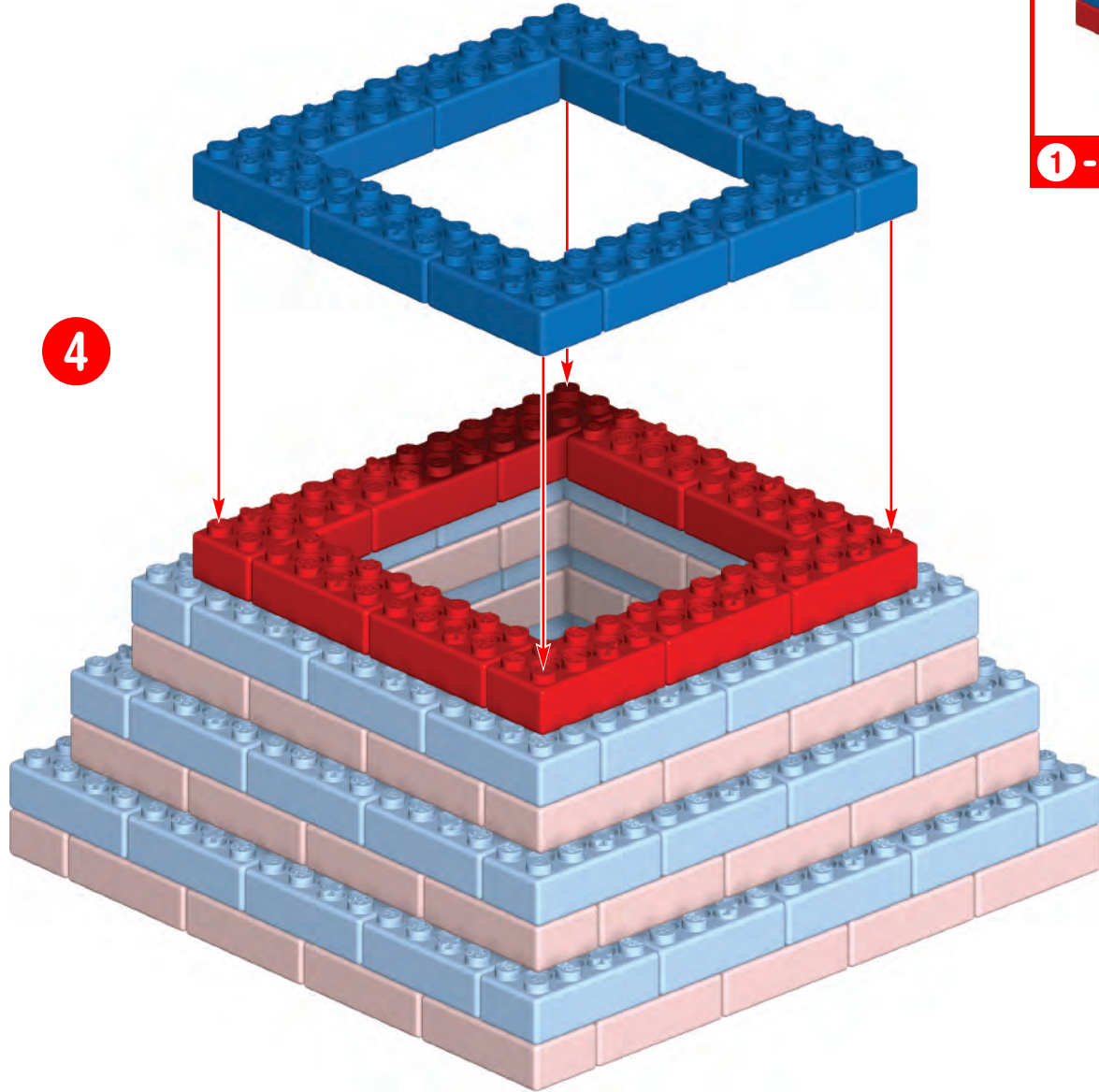

1 - 4

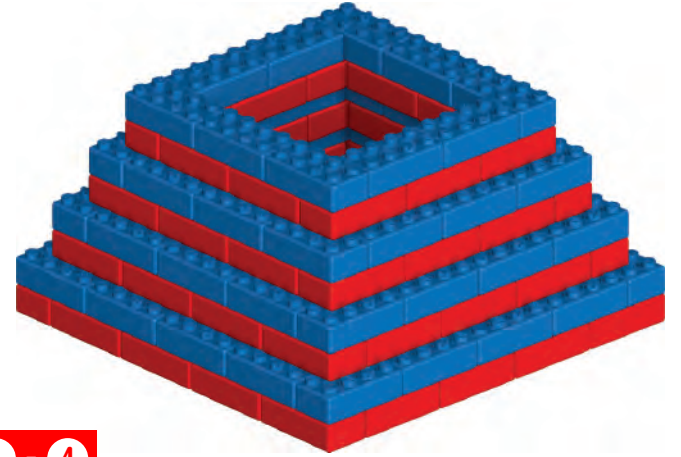

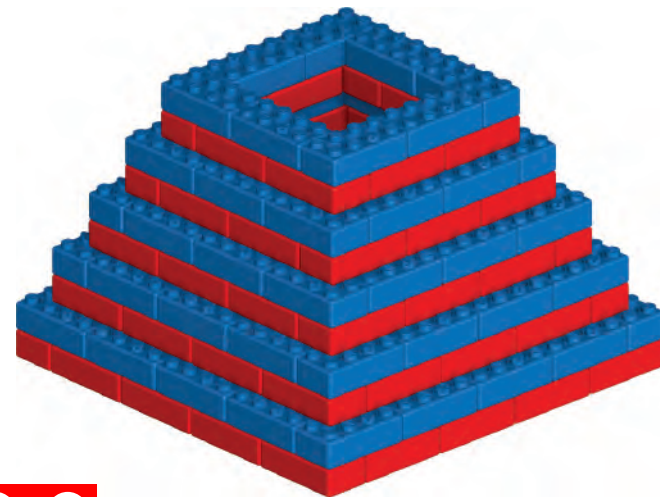
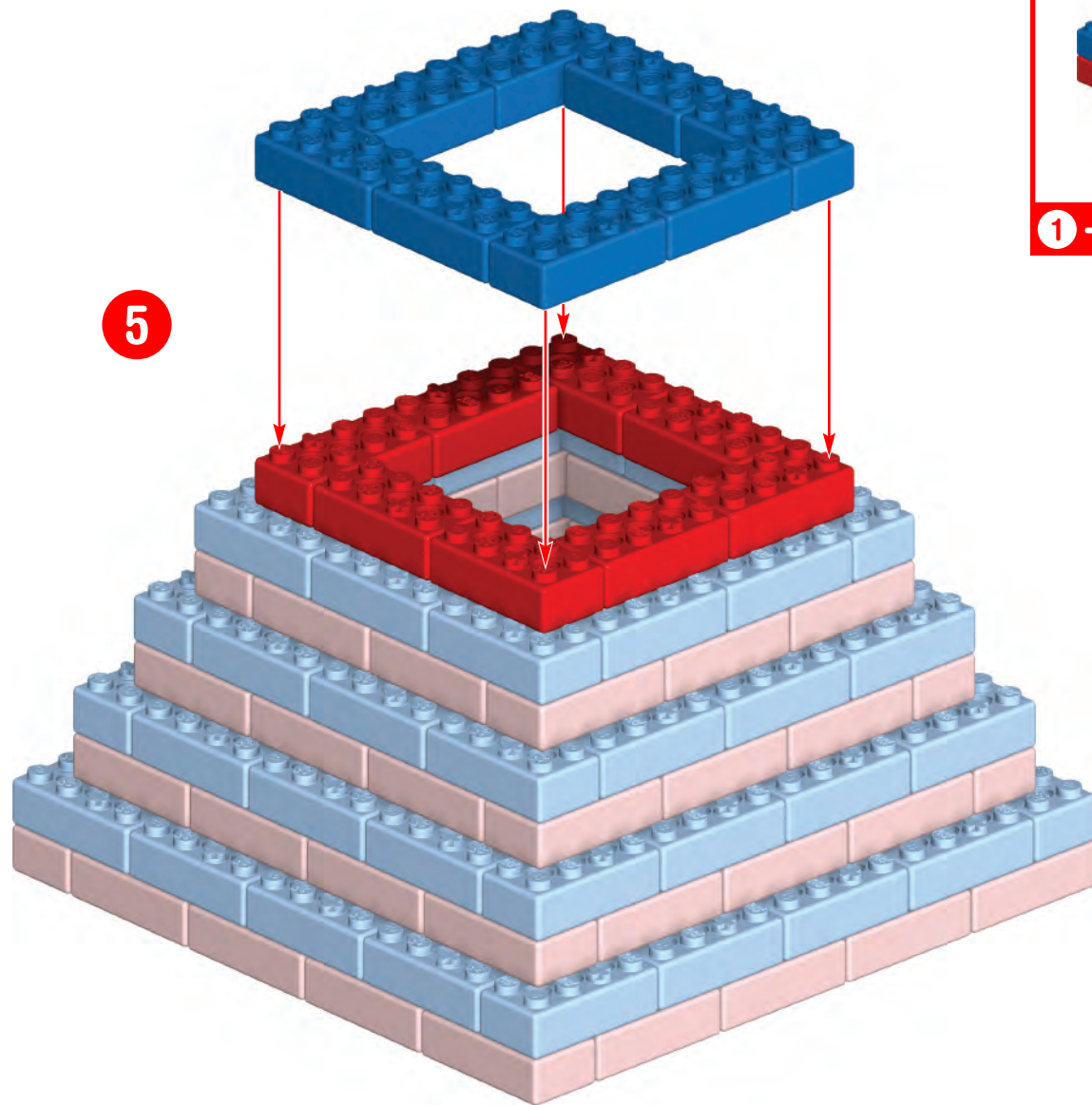

1 - 5

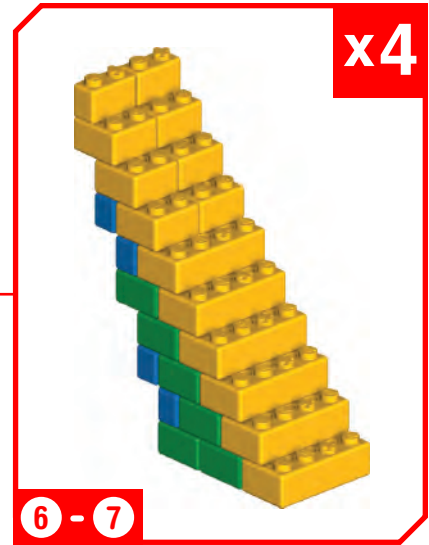
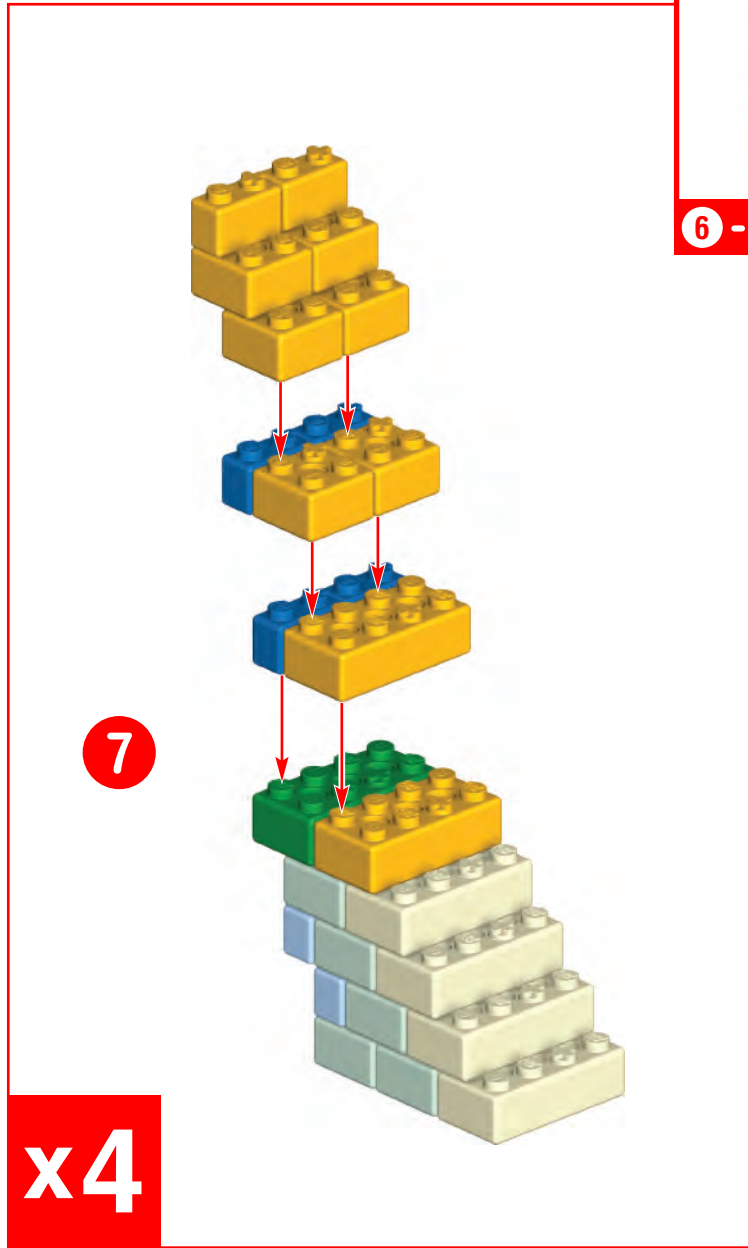
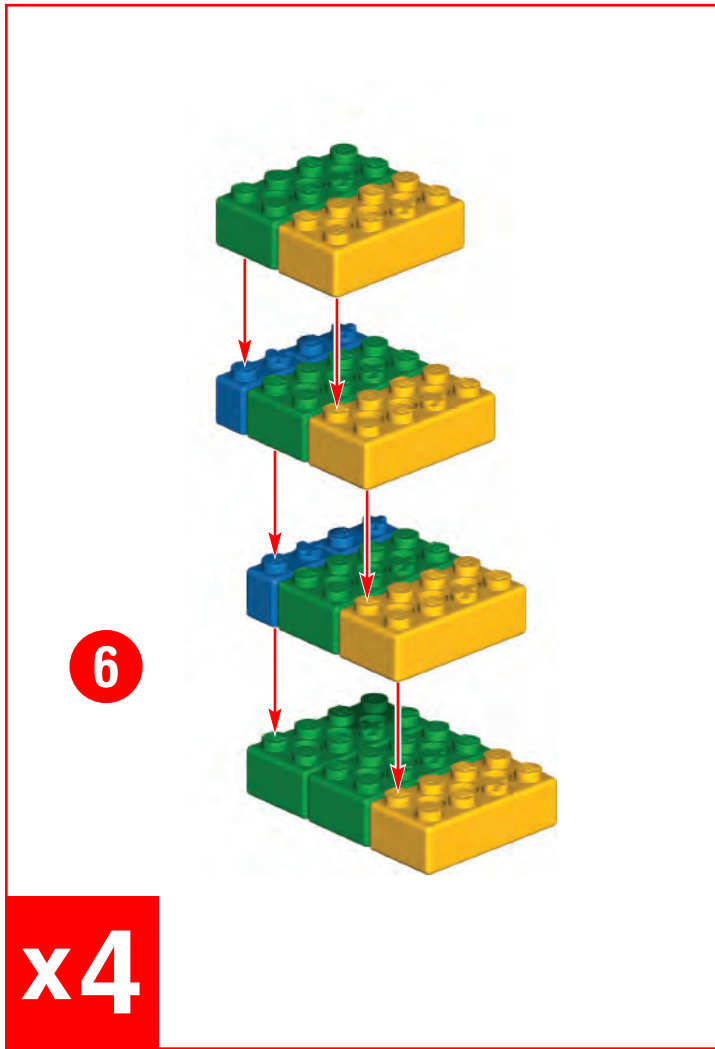

8

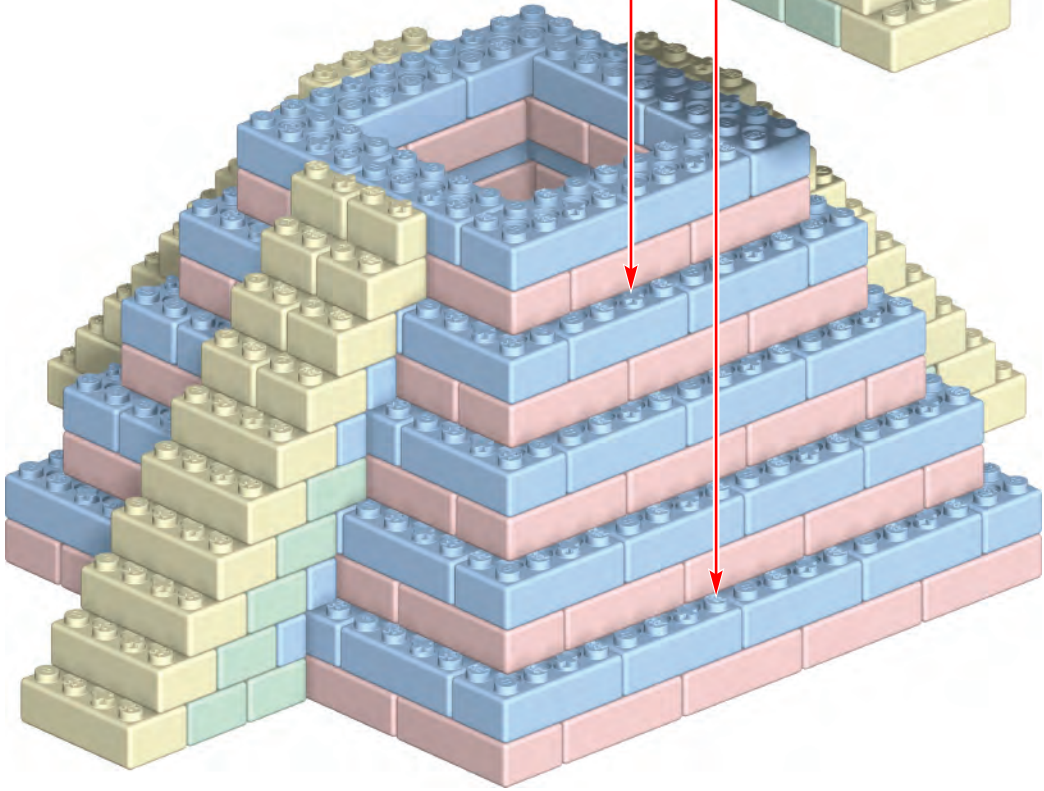
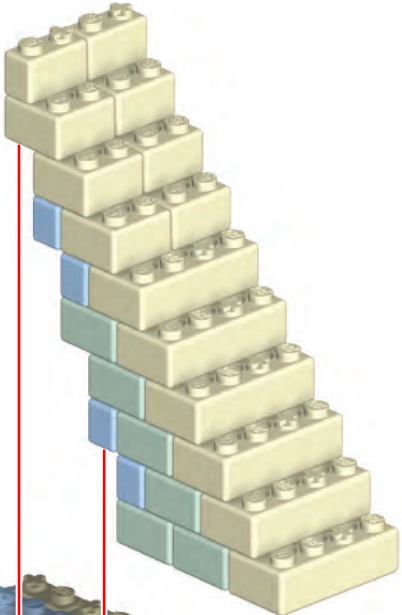

1 - 8

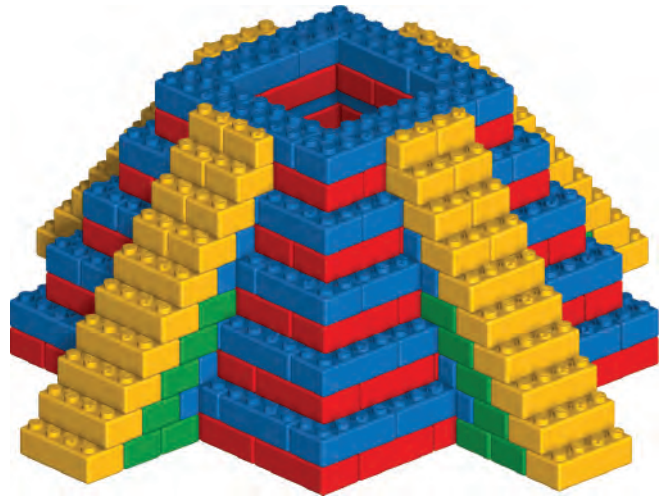

9

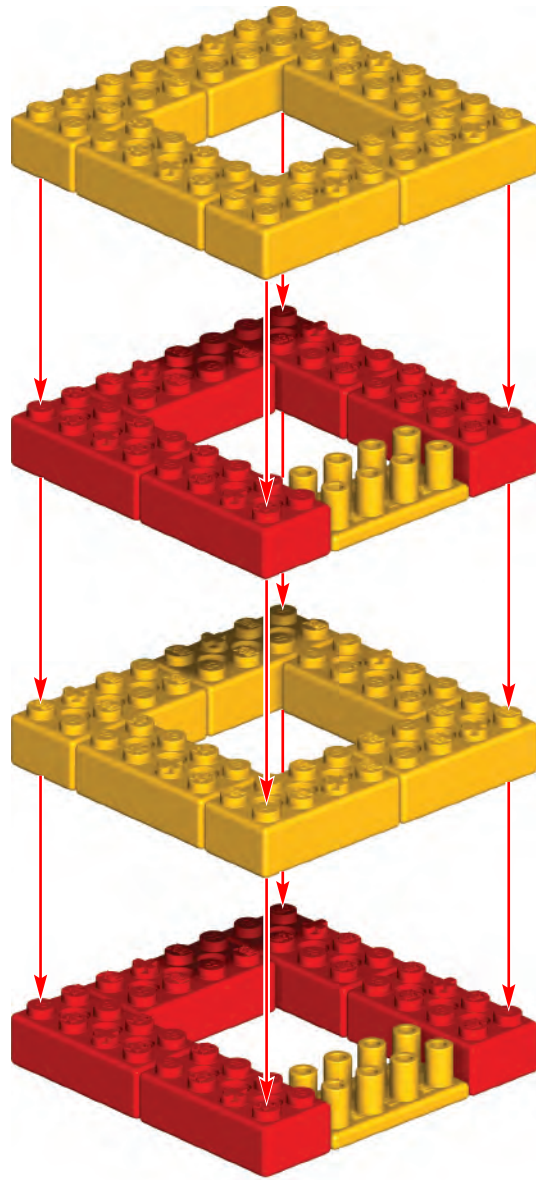

9

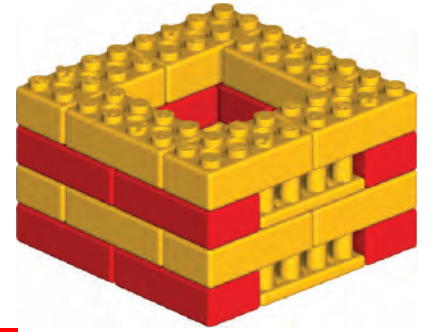

10

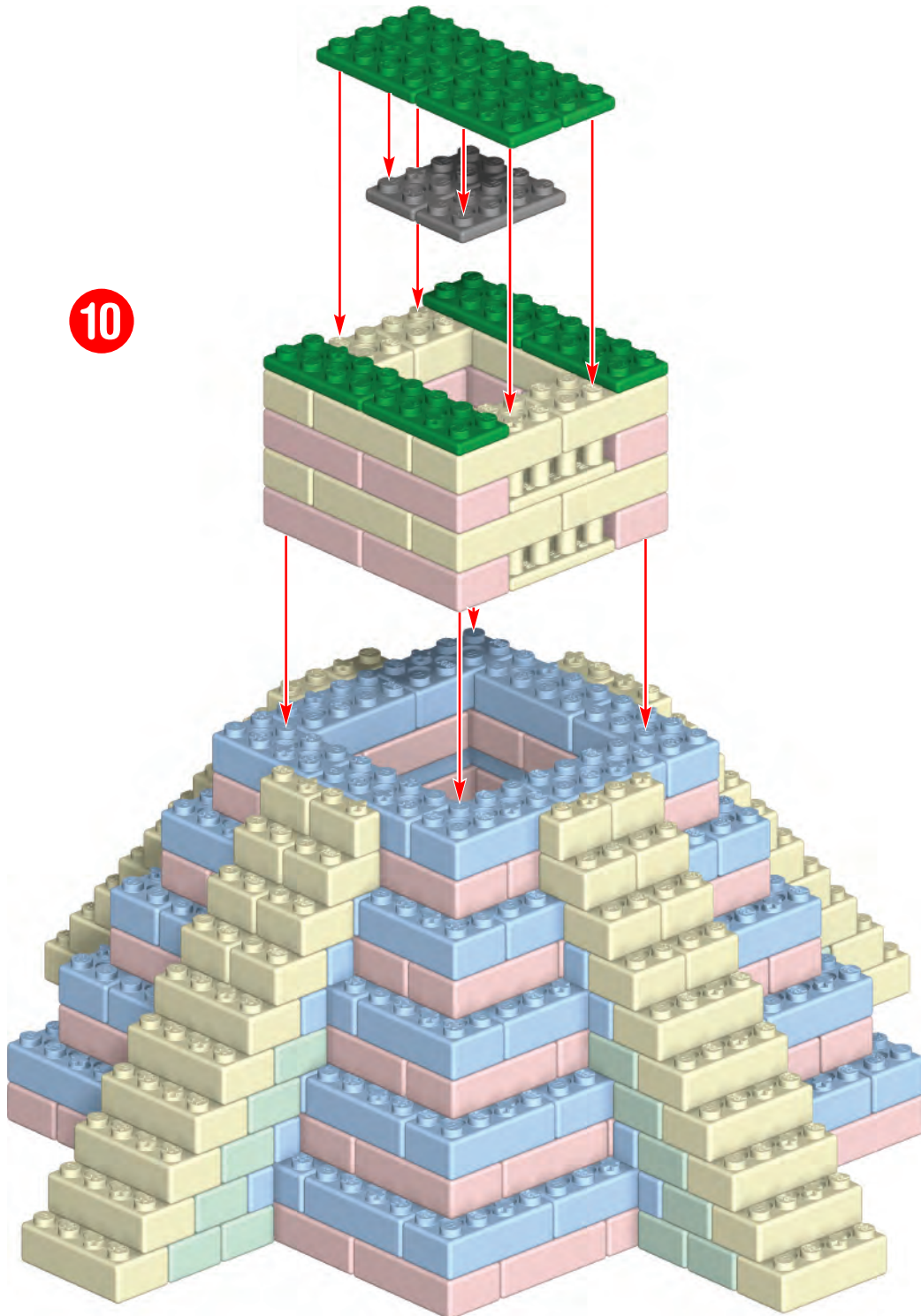

1 - 10

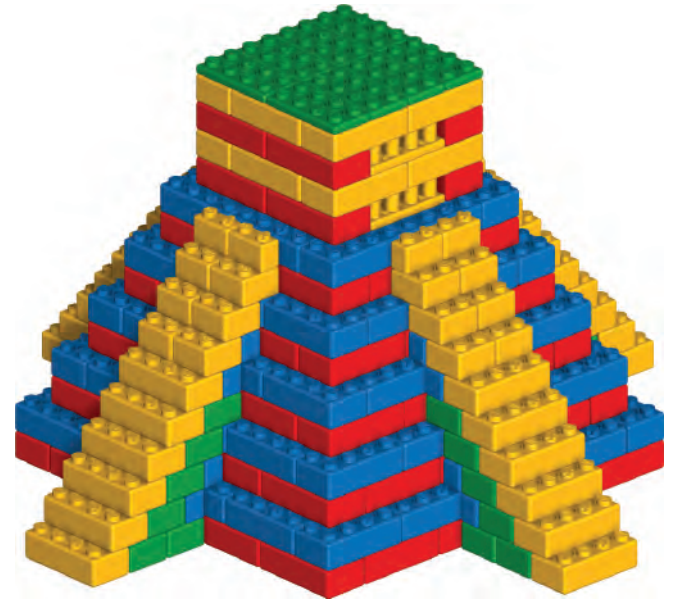

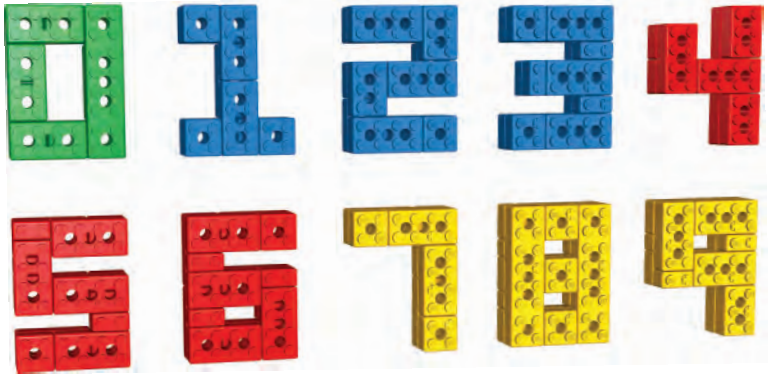

# Numbers

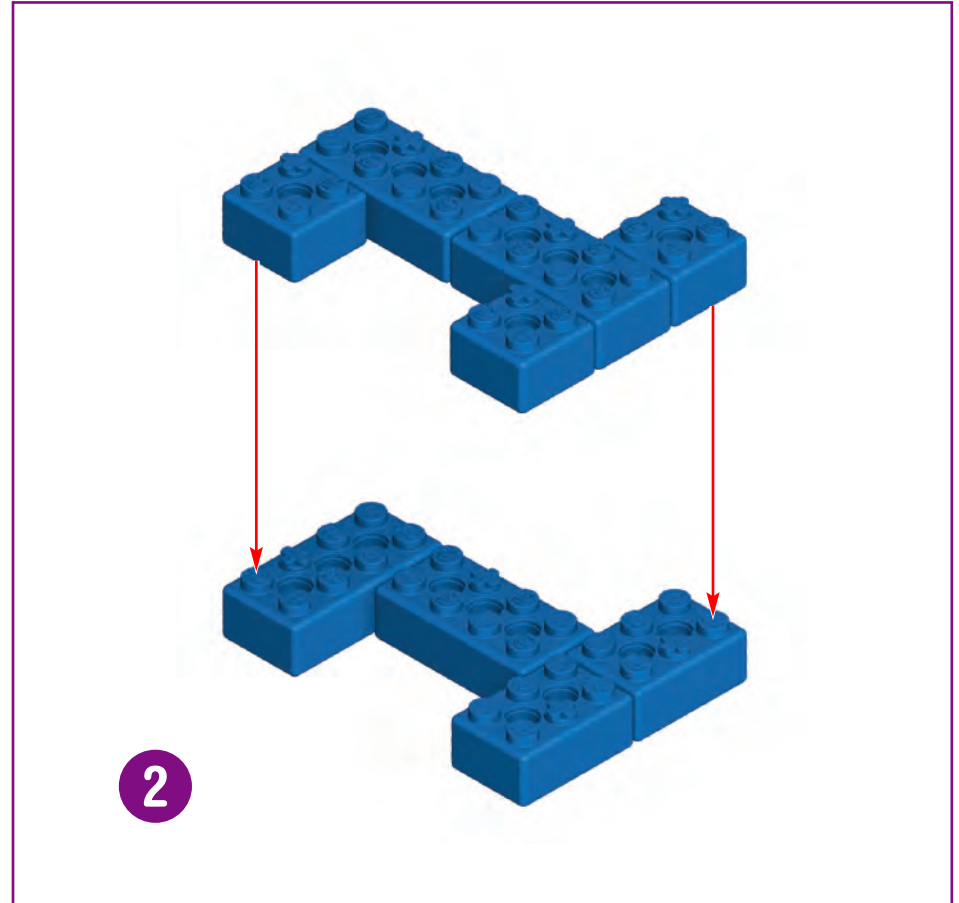
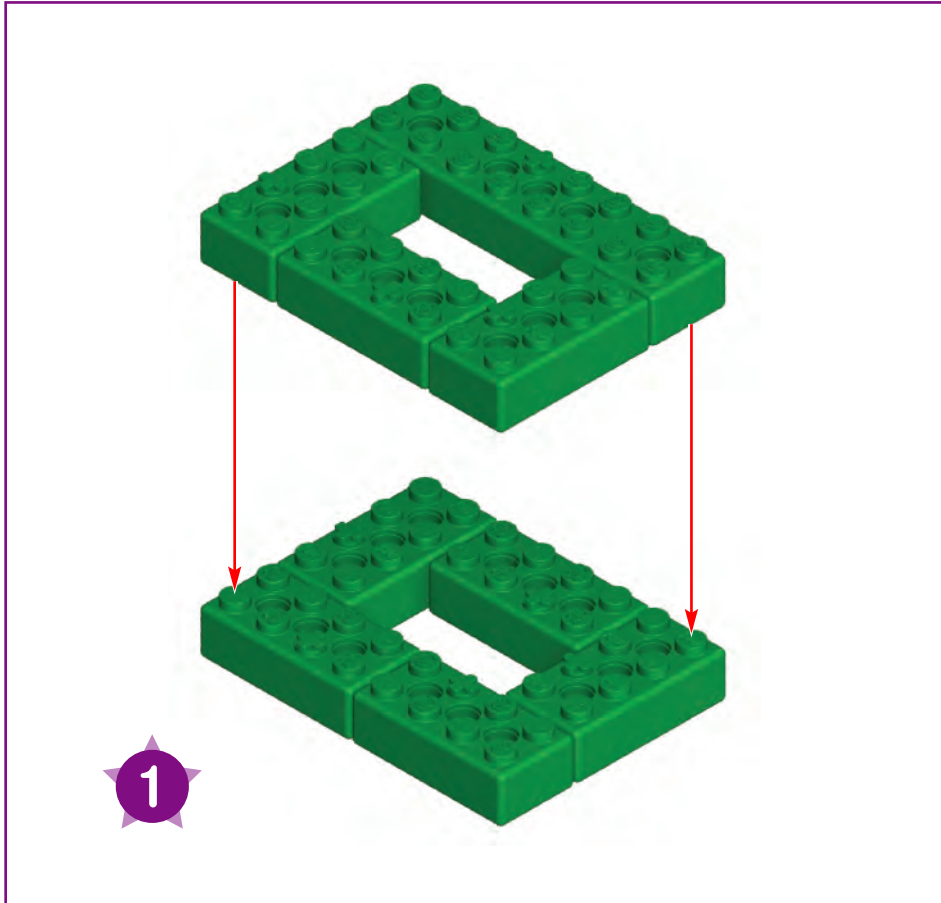
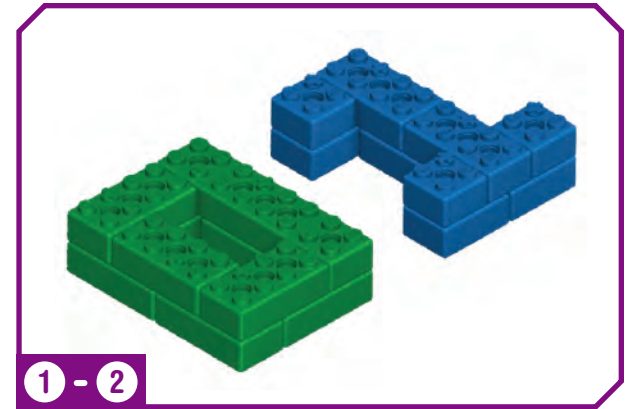

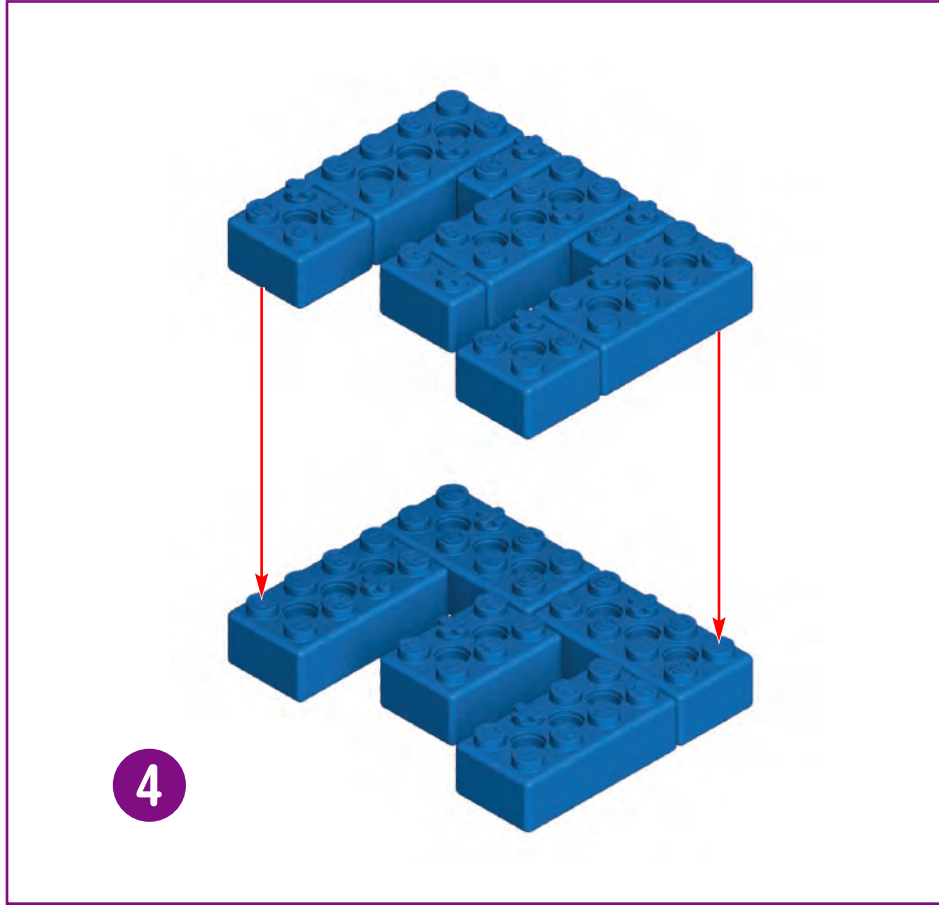
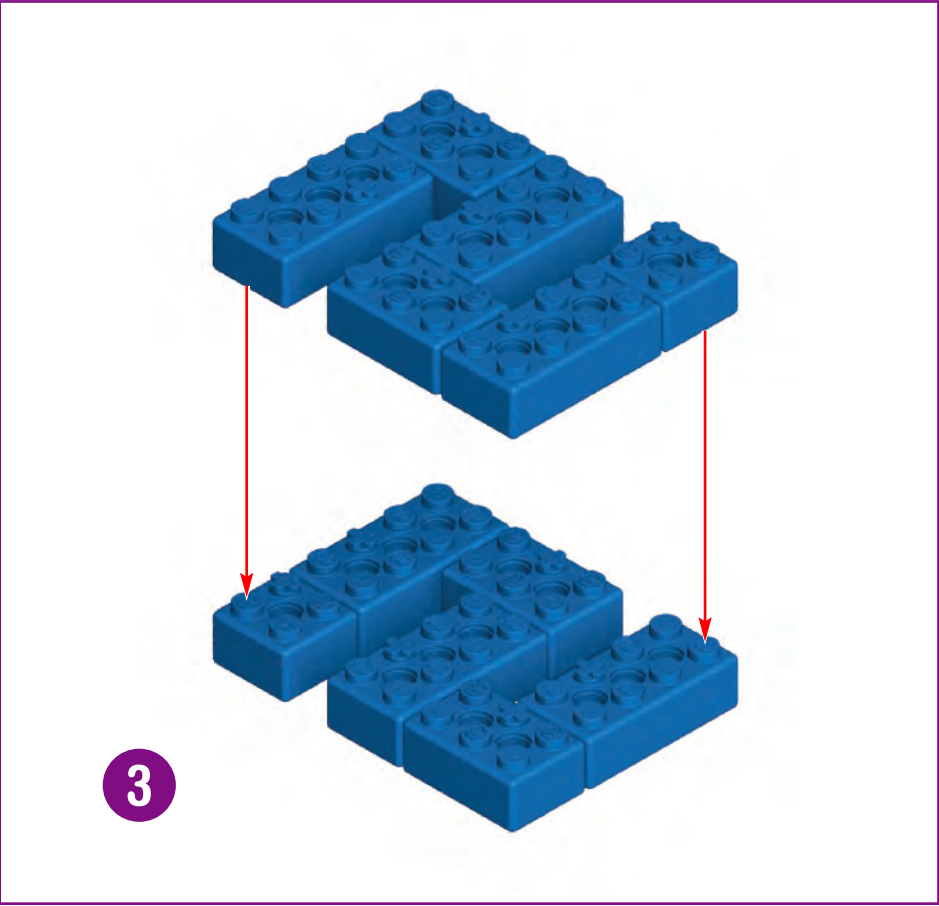
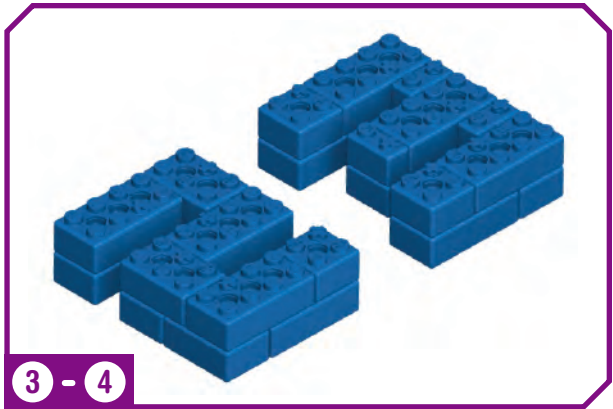

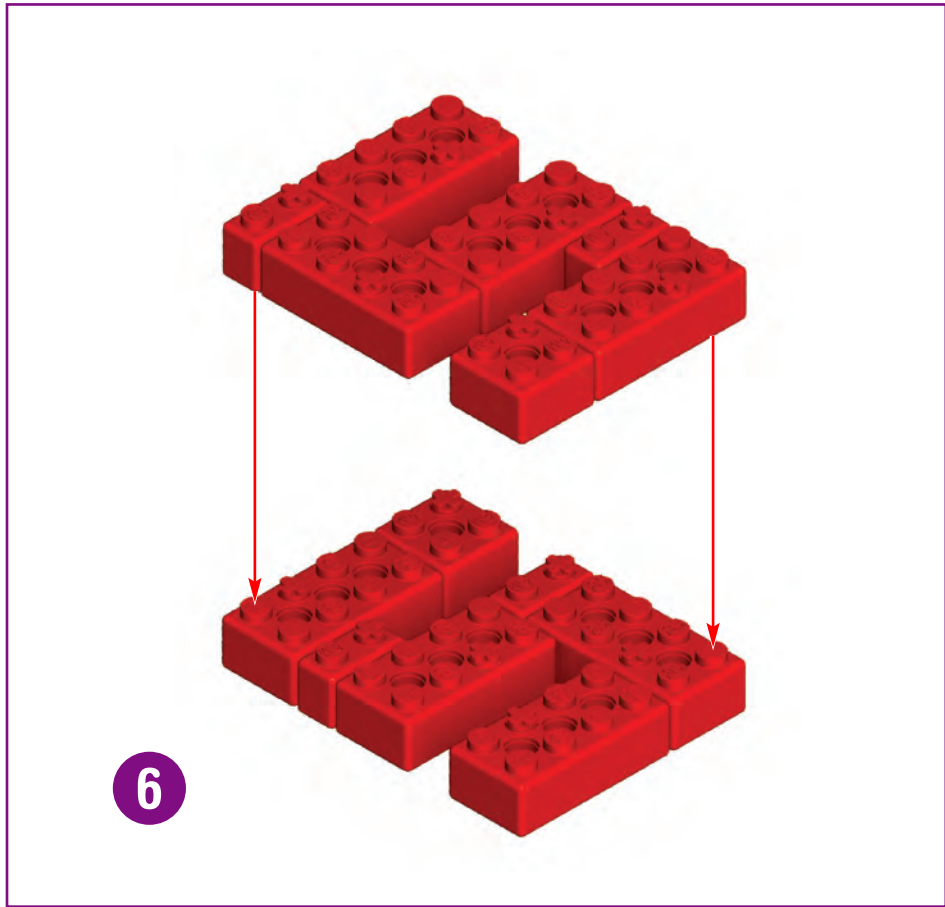
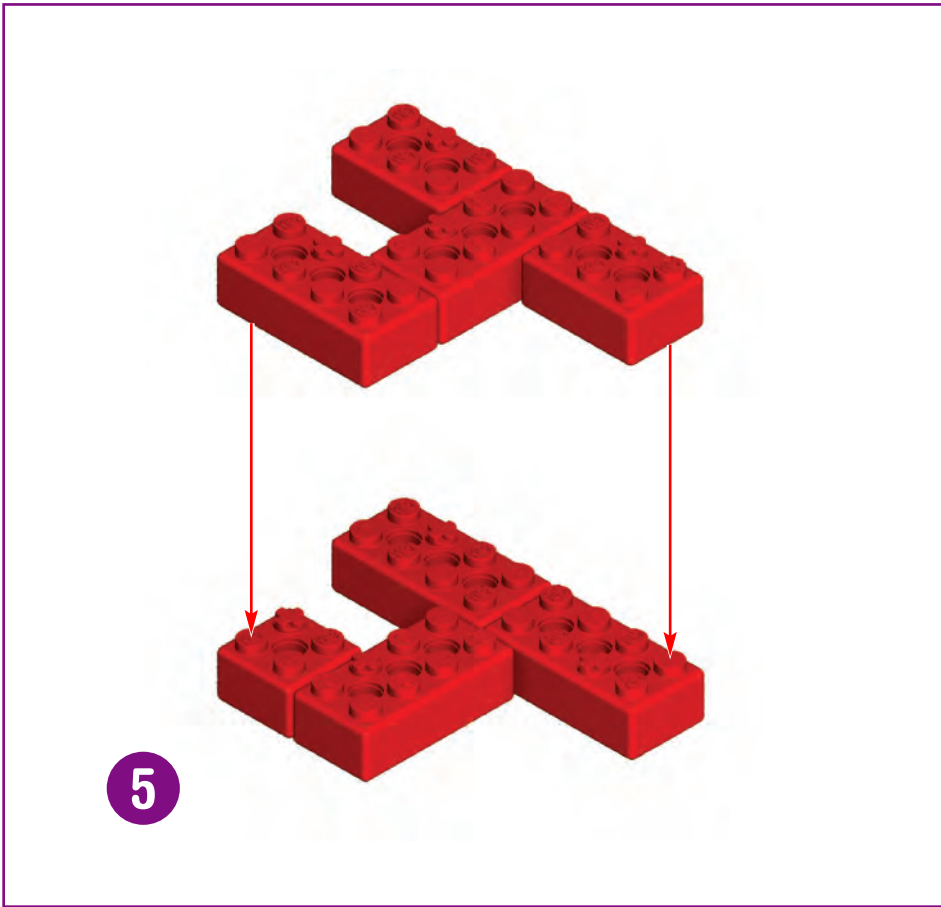
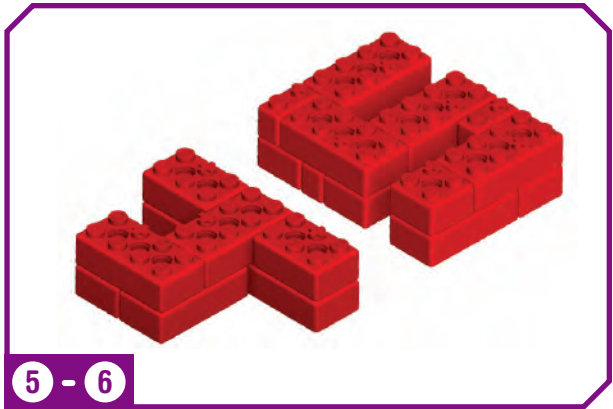

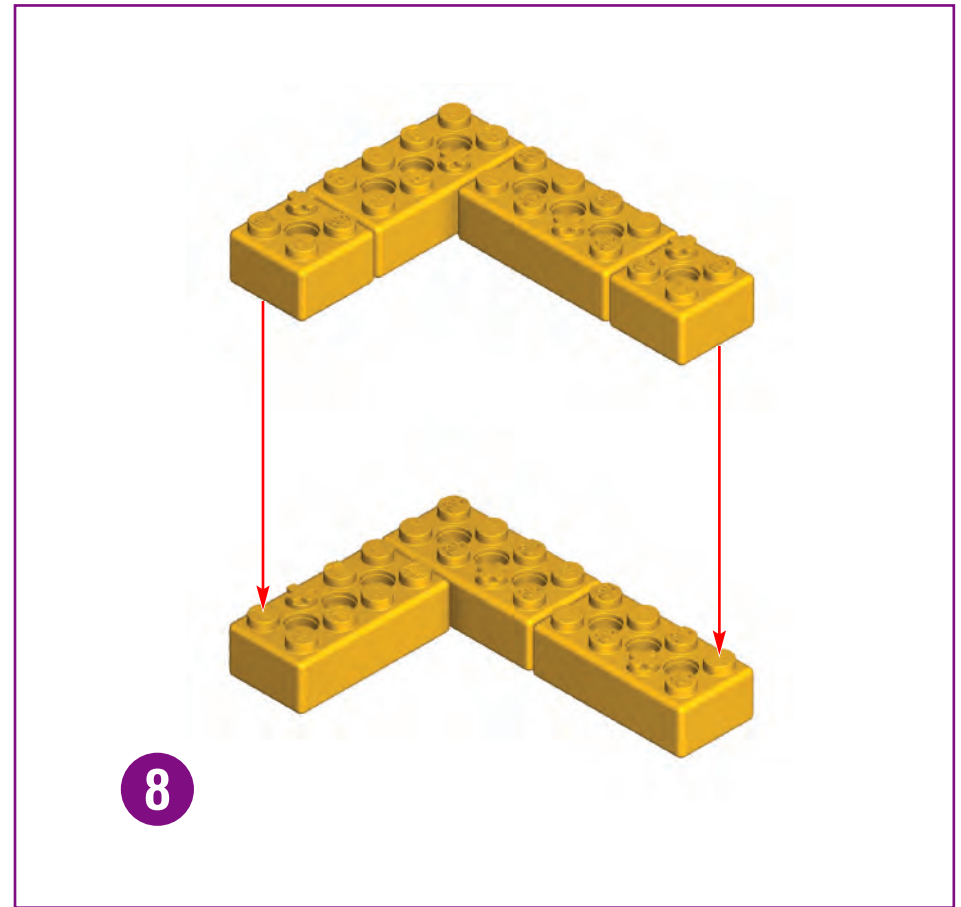
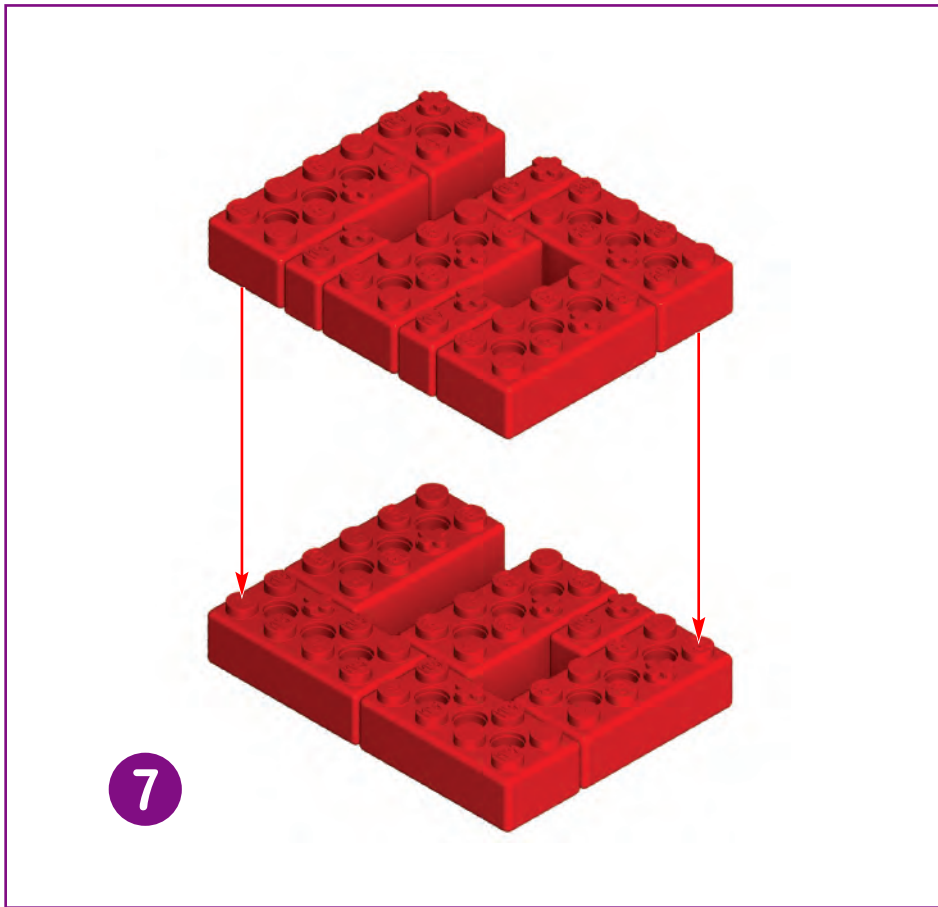
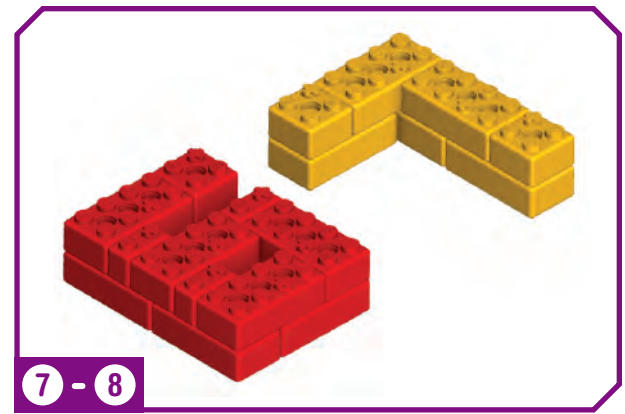

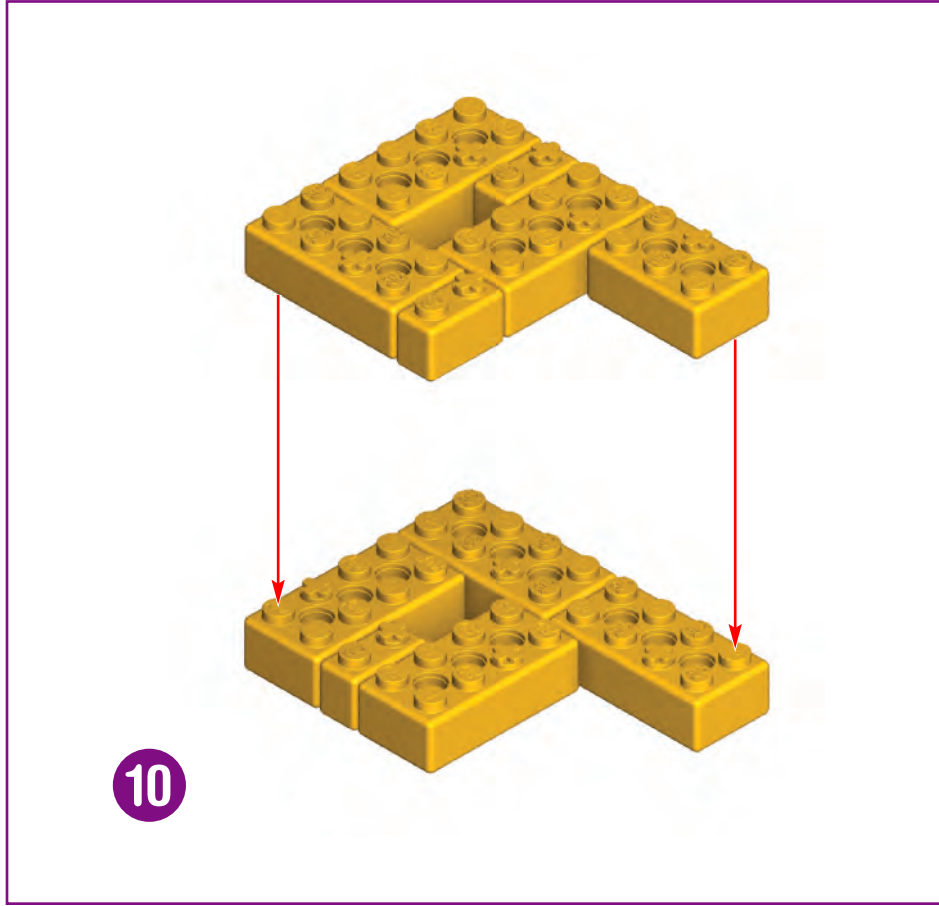
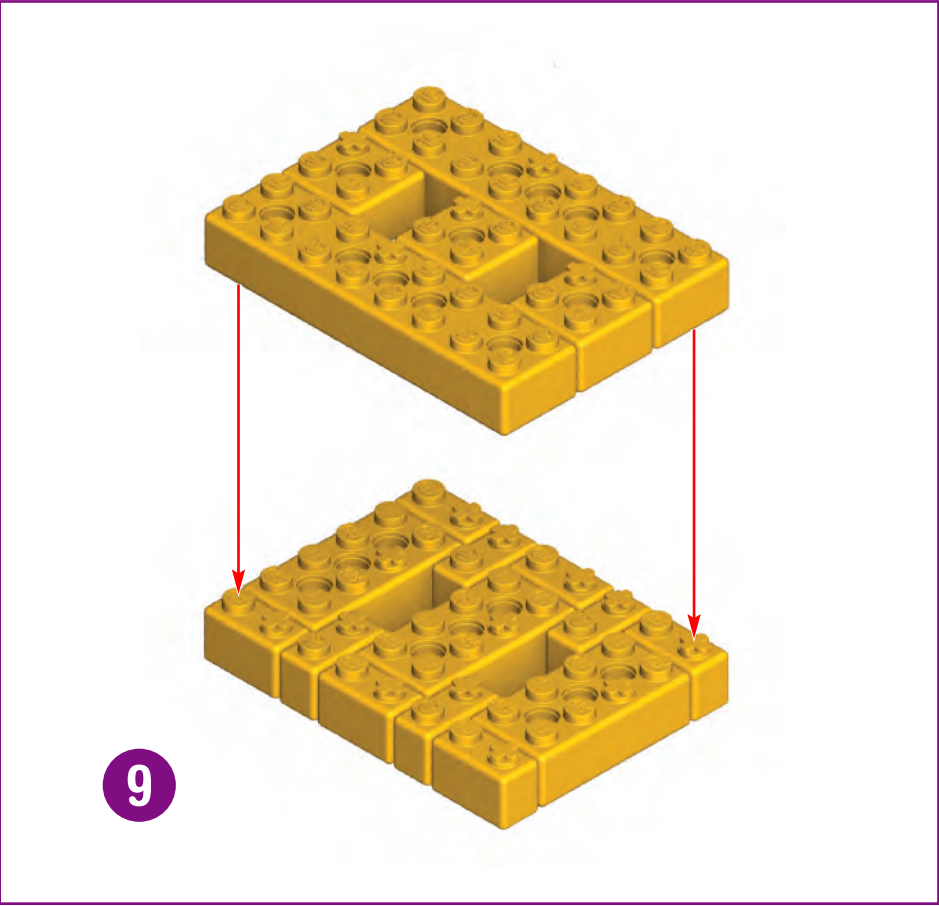
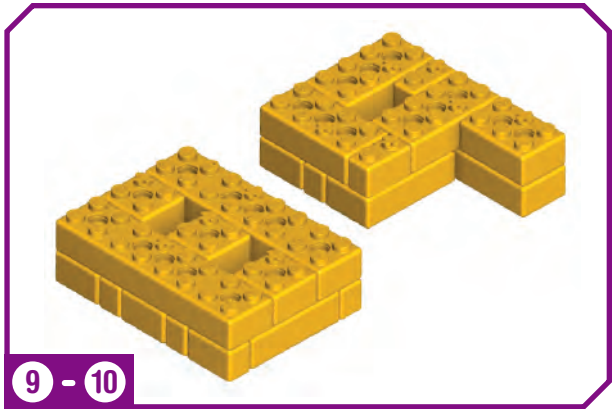



# Tyrannosaurus Rex

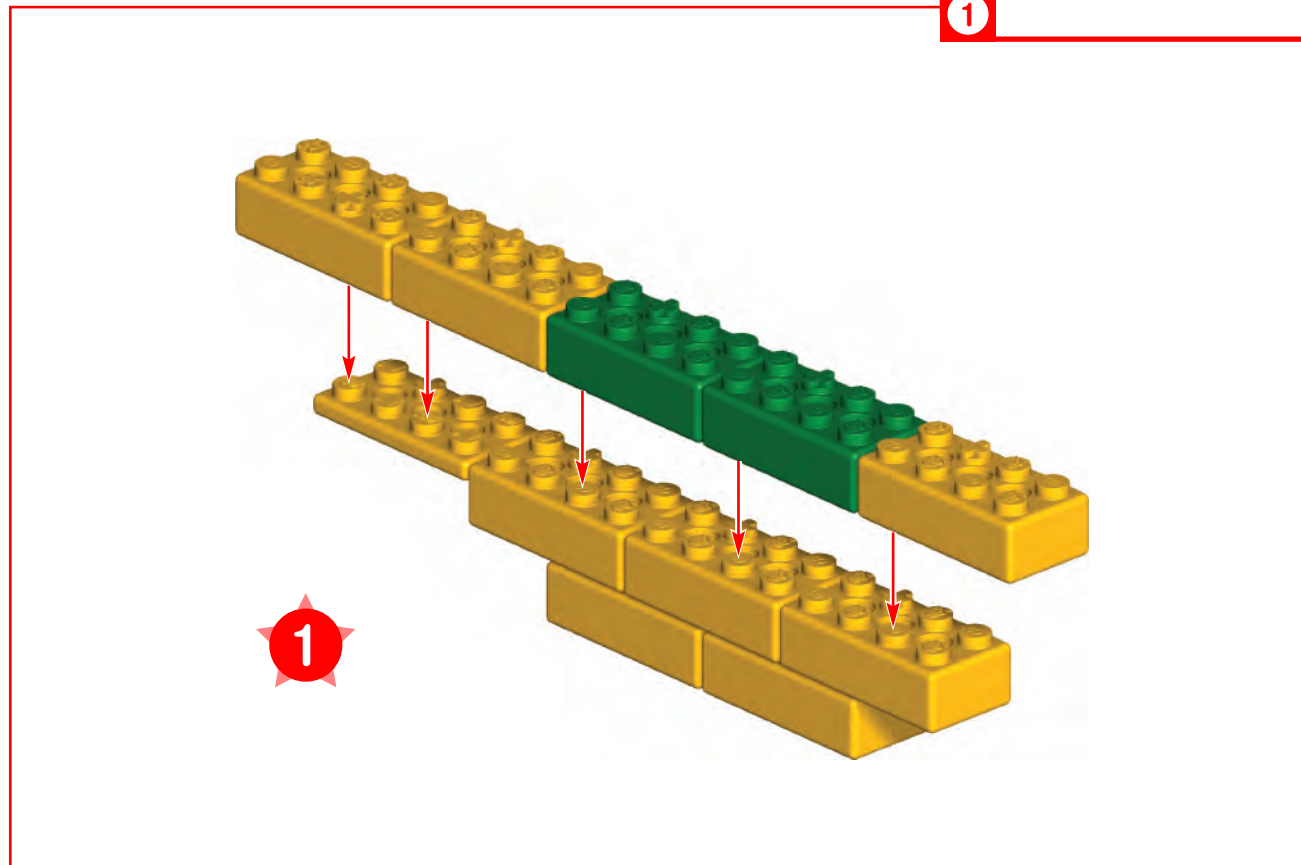
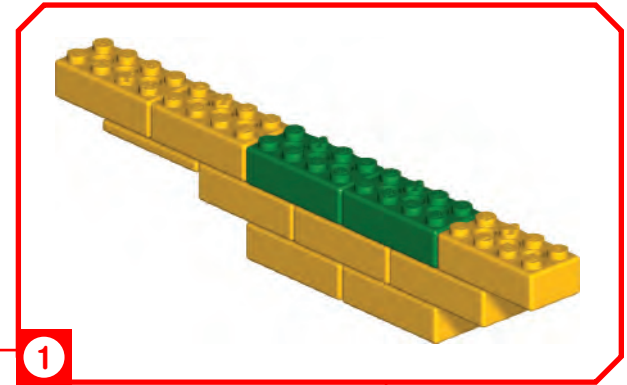

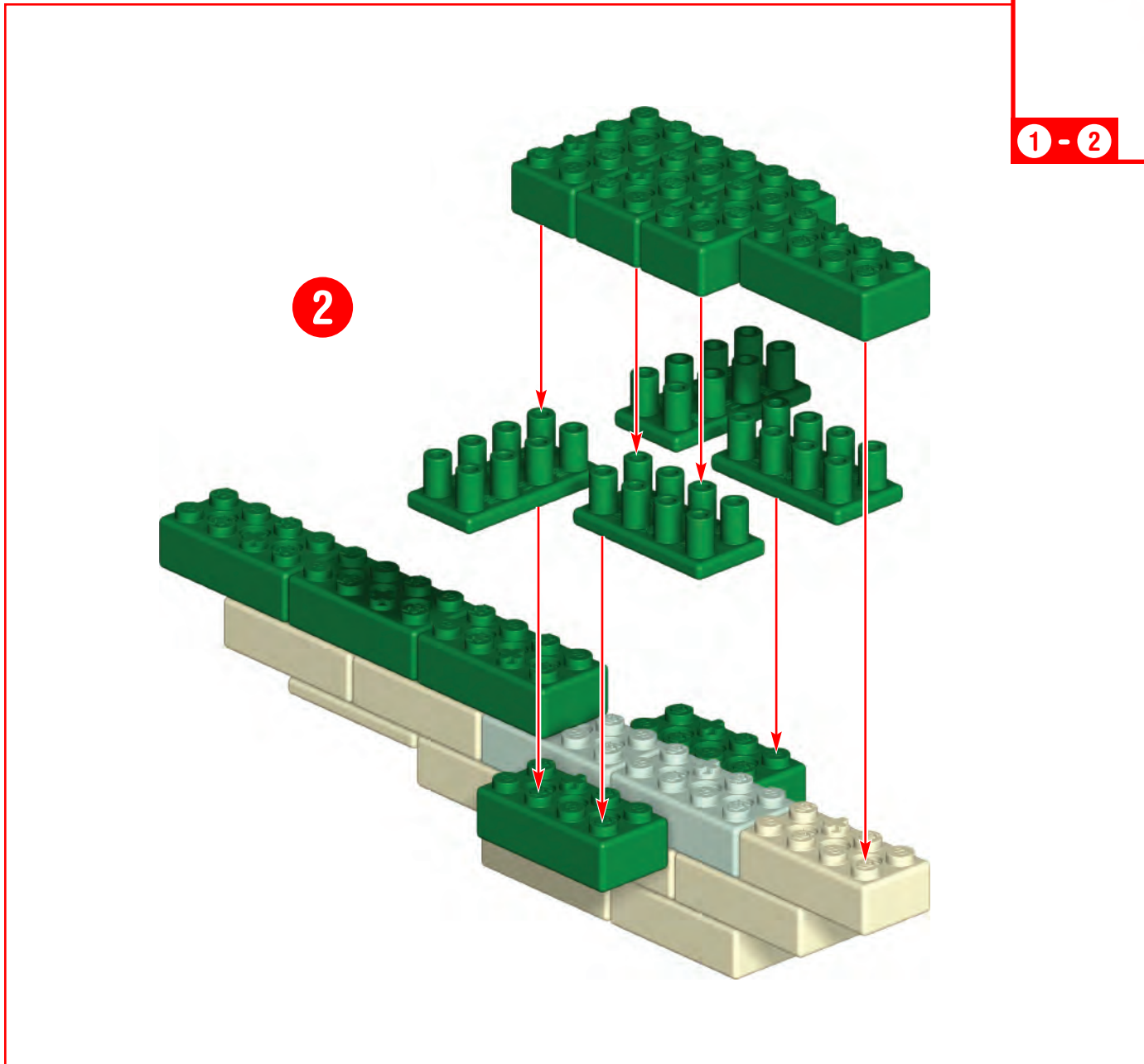
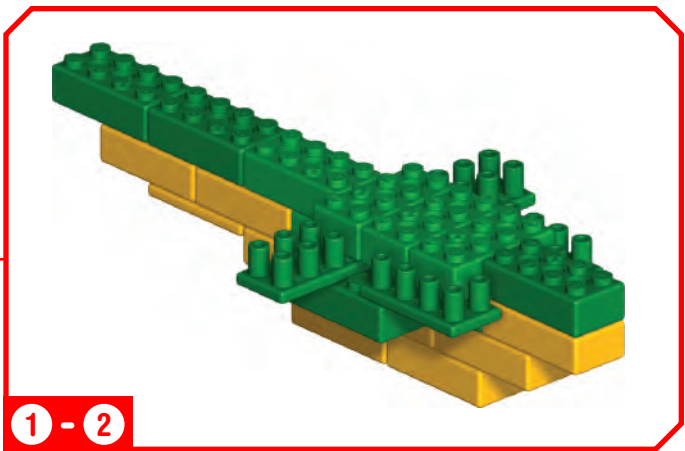

x2

3

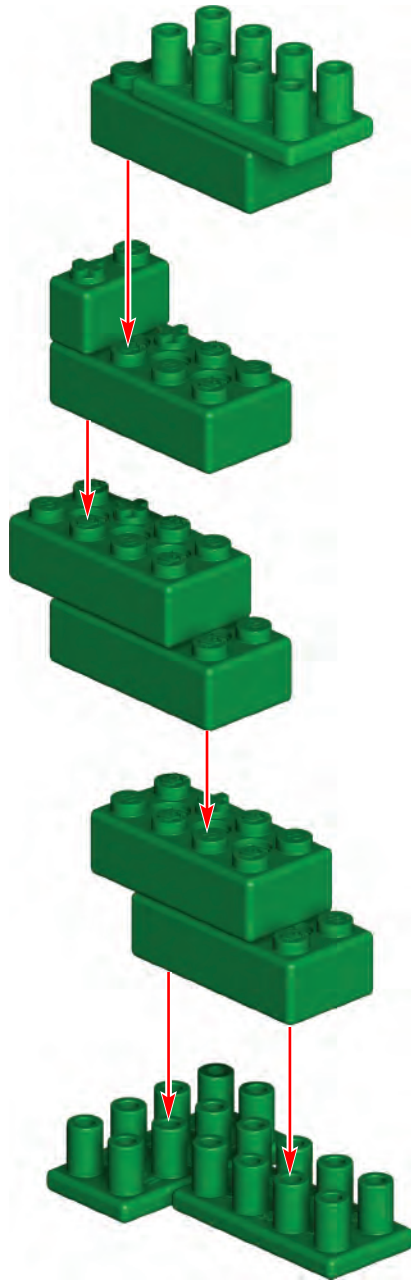

3

x2



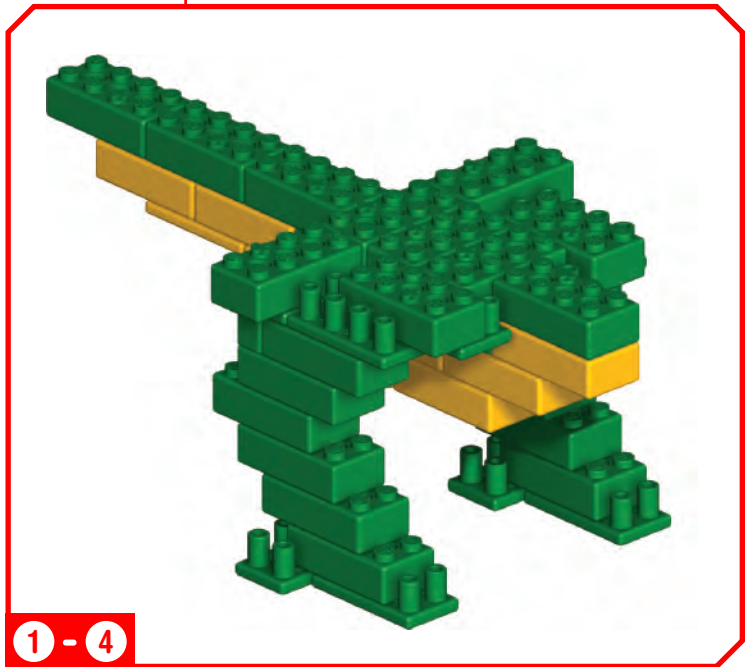
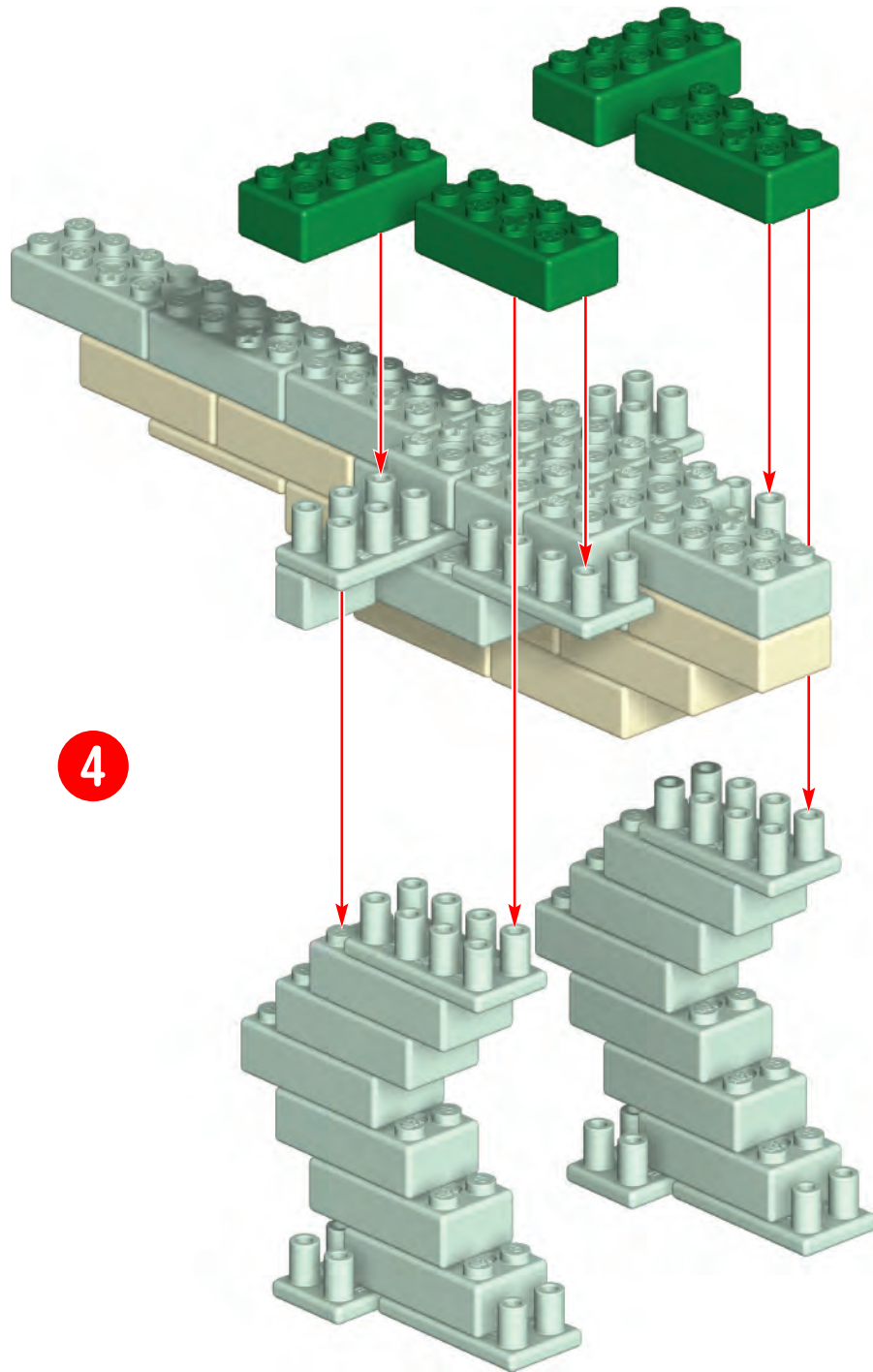

5

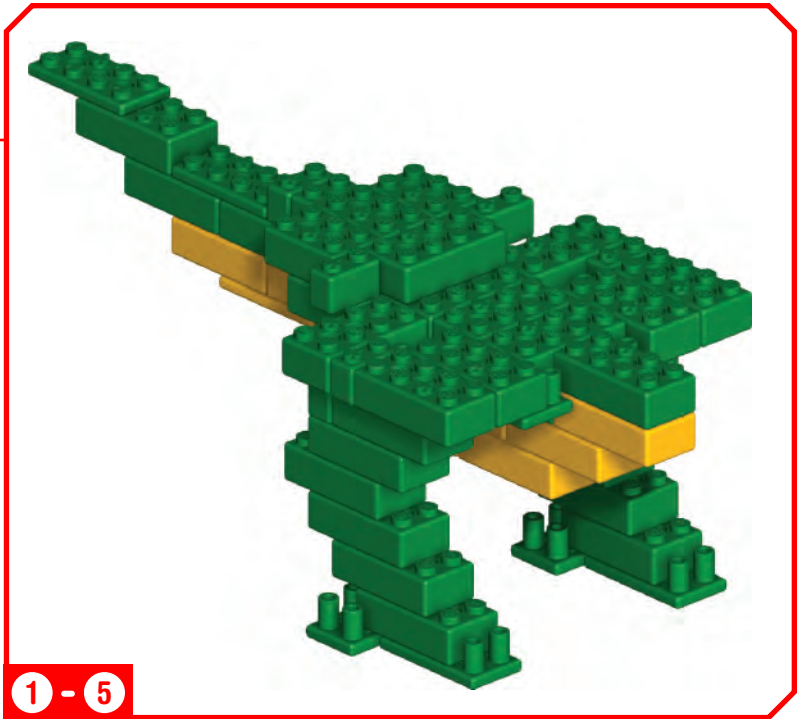
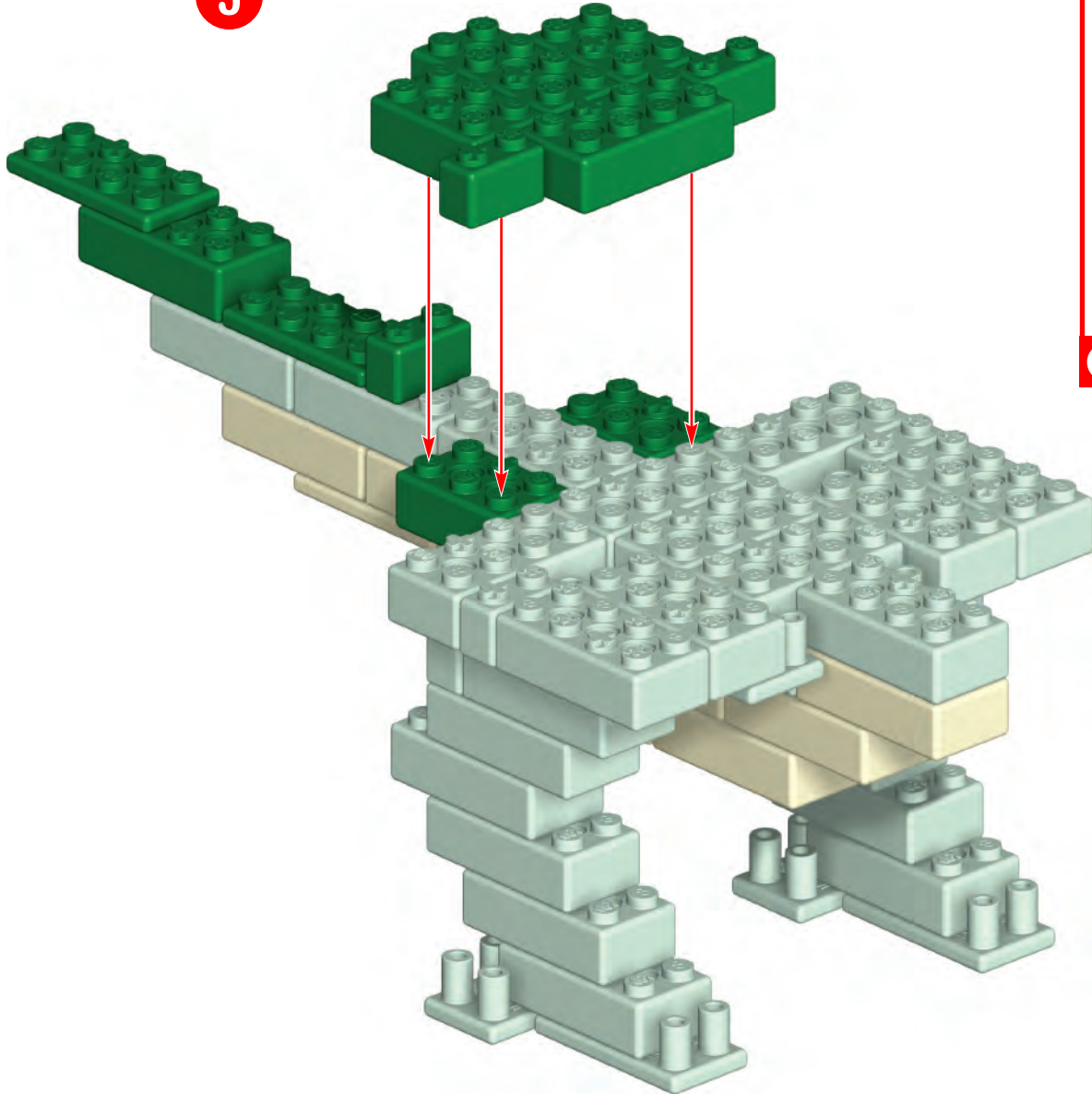

6

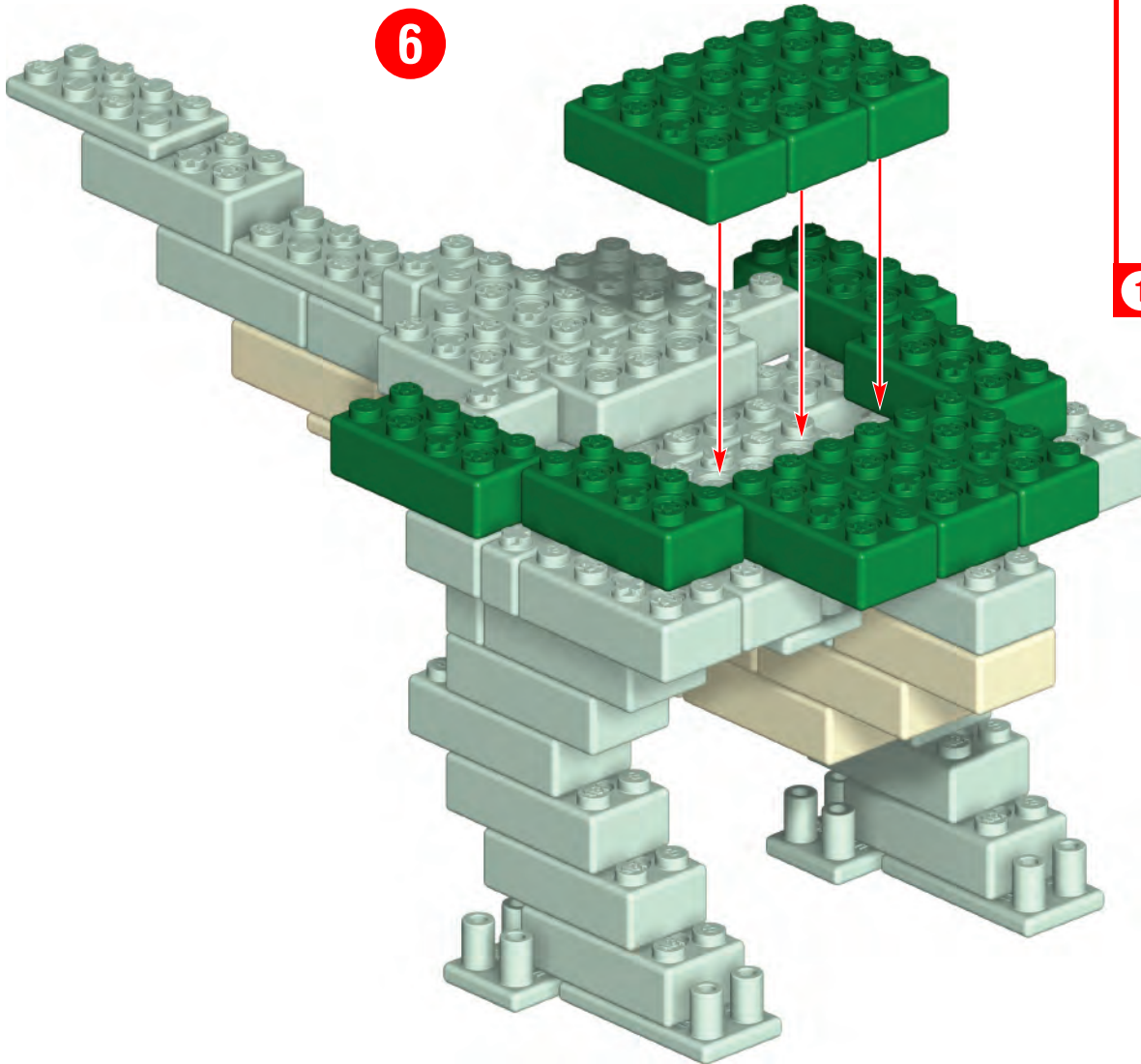

1 - 6

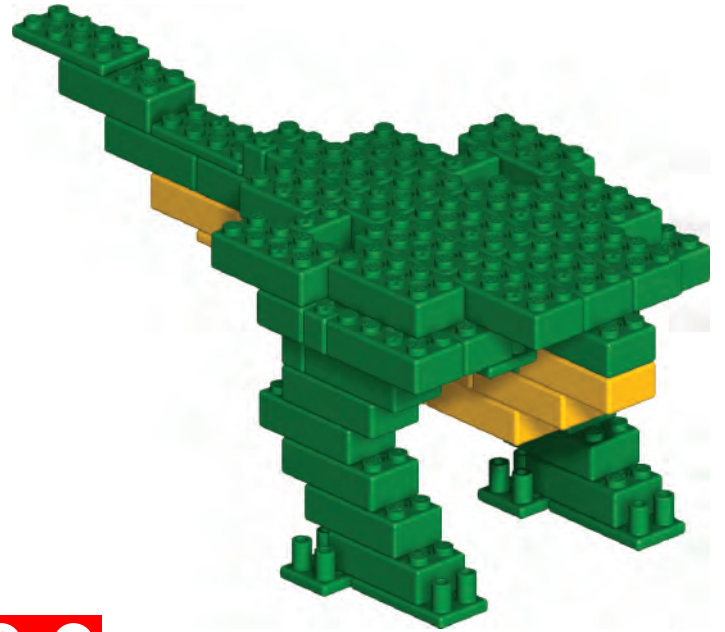

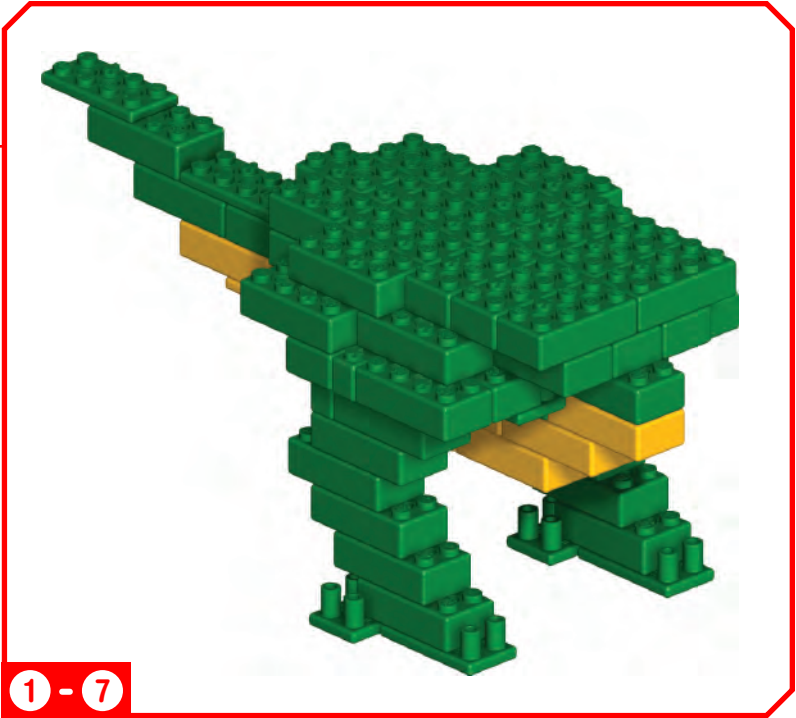
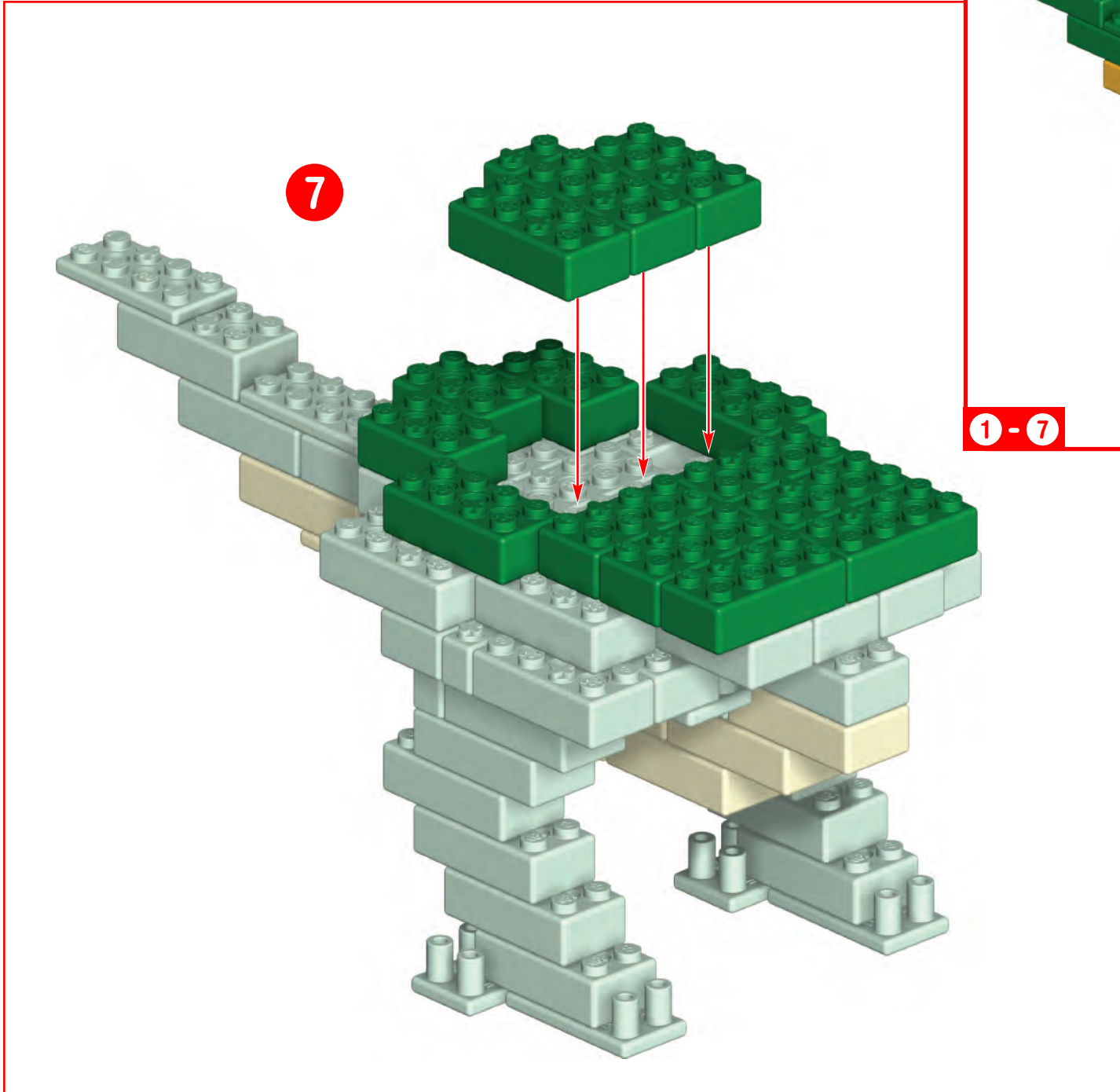

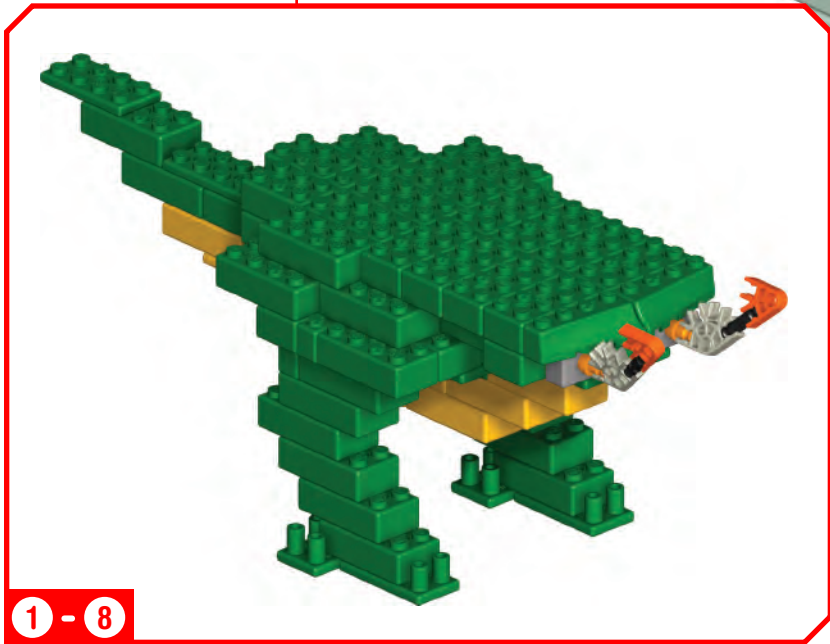
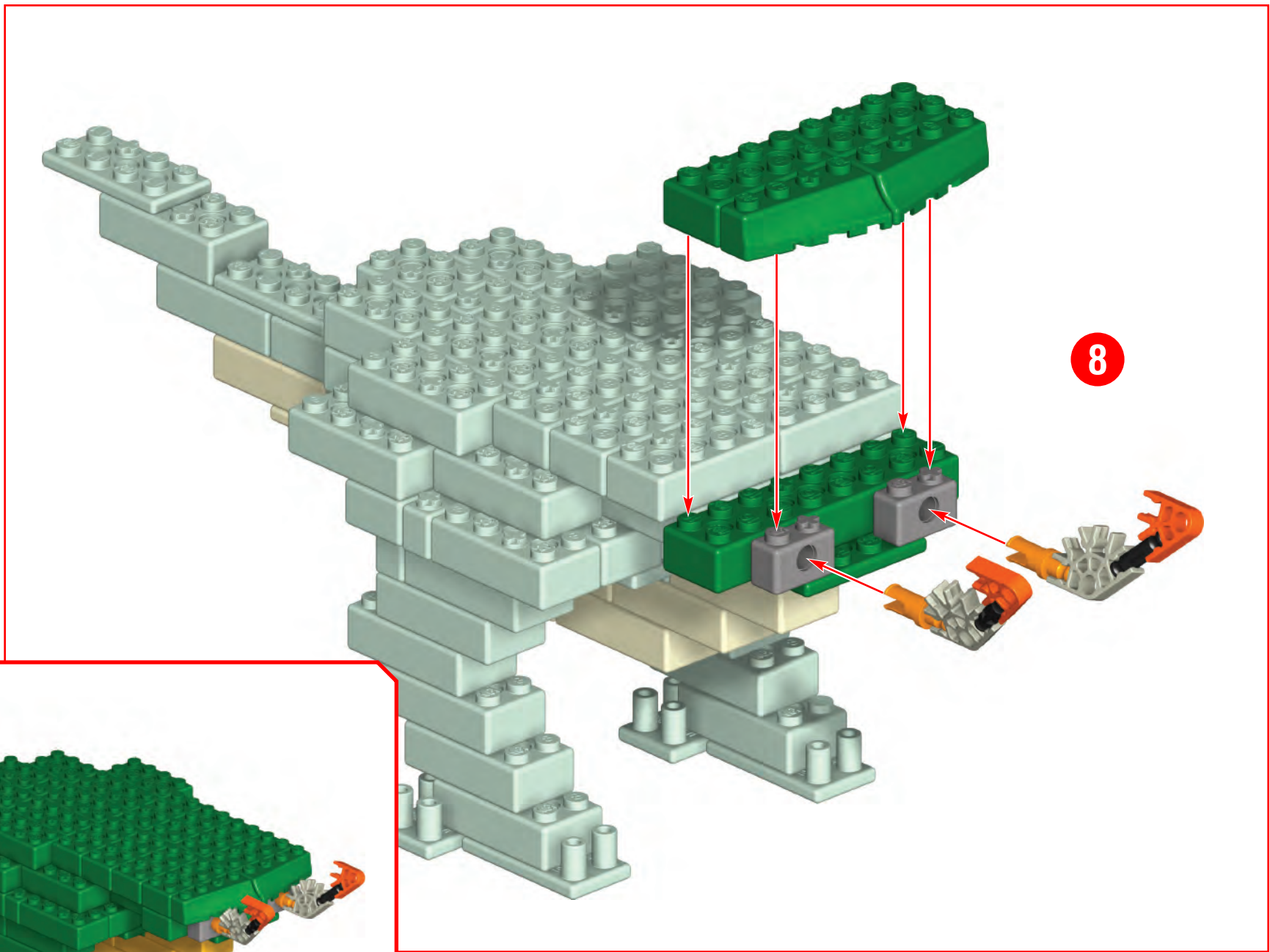

1 - 8

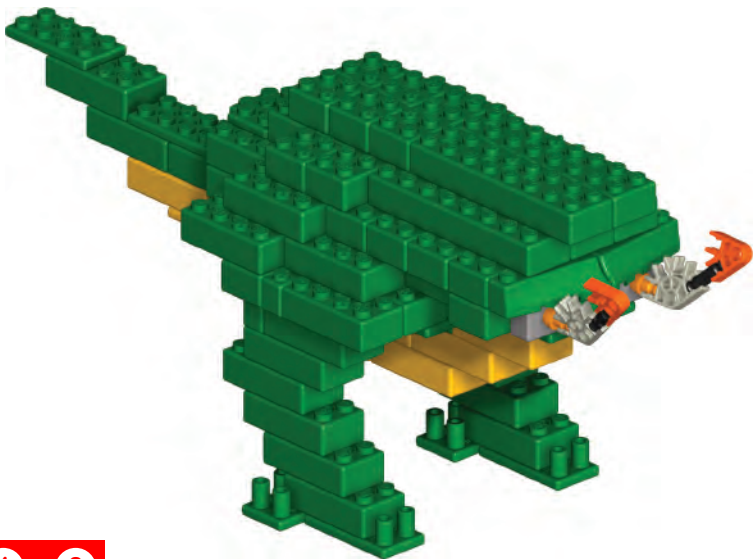
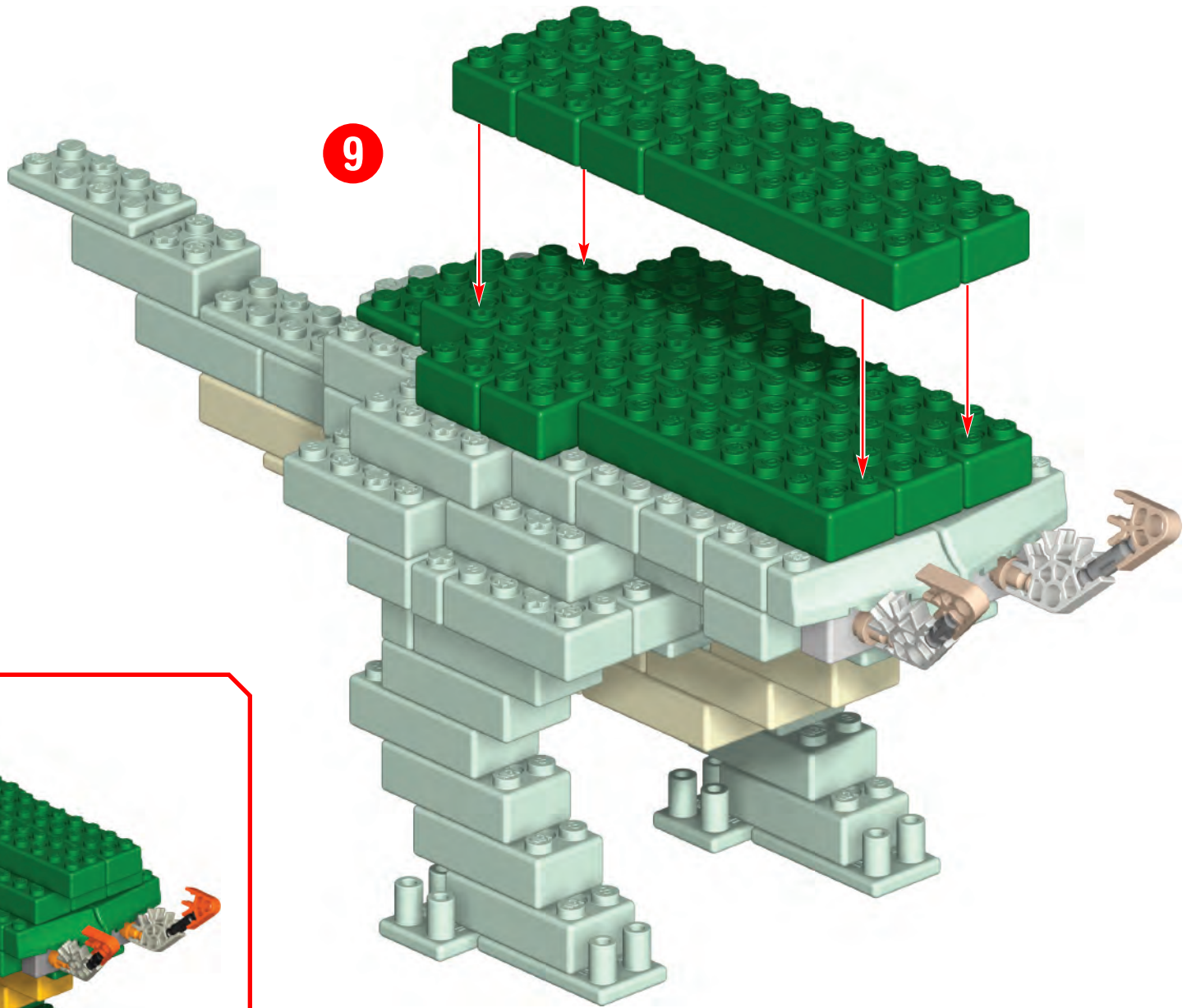

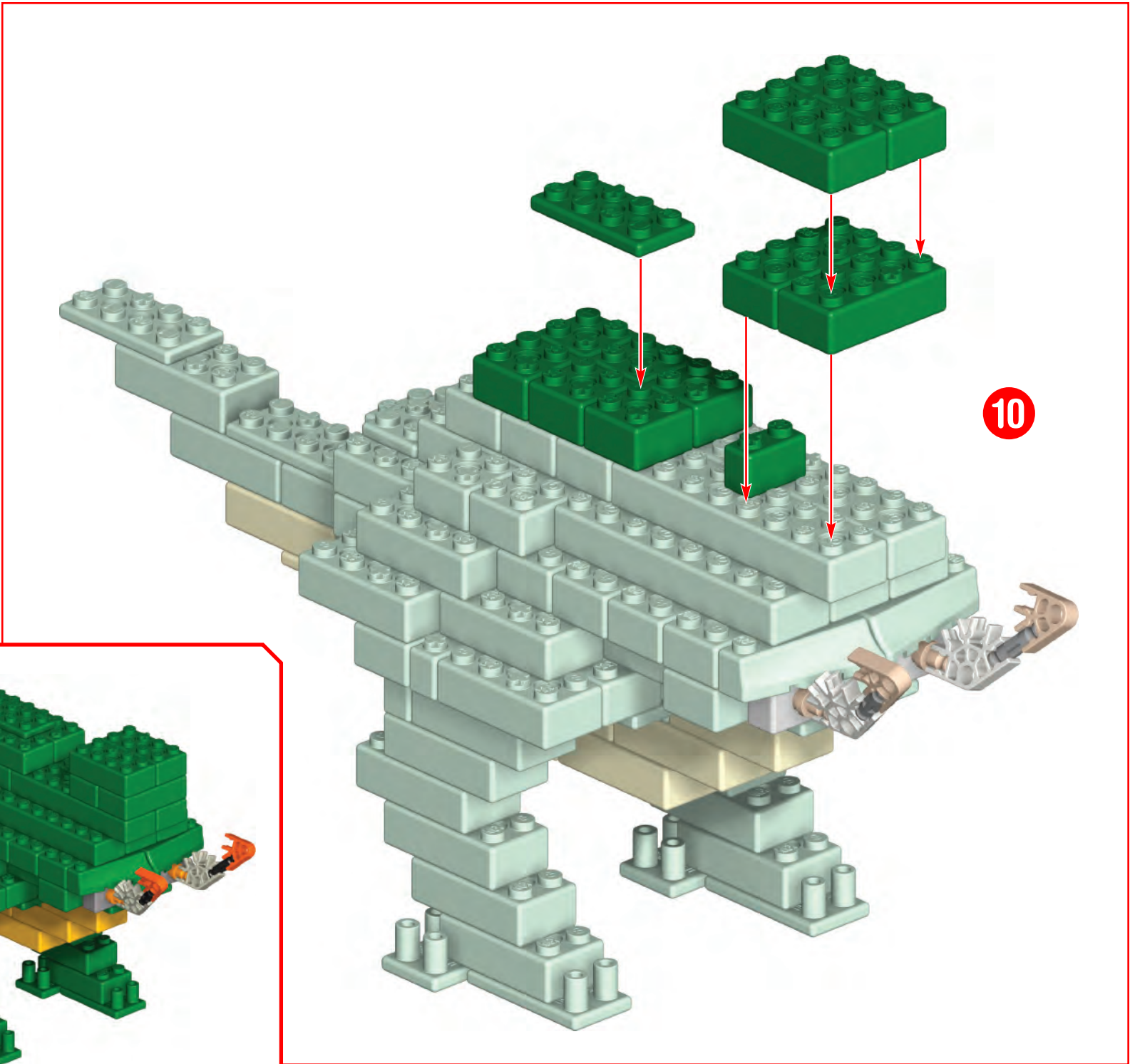
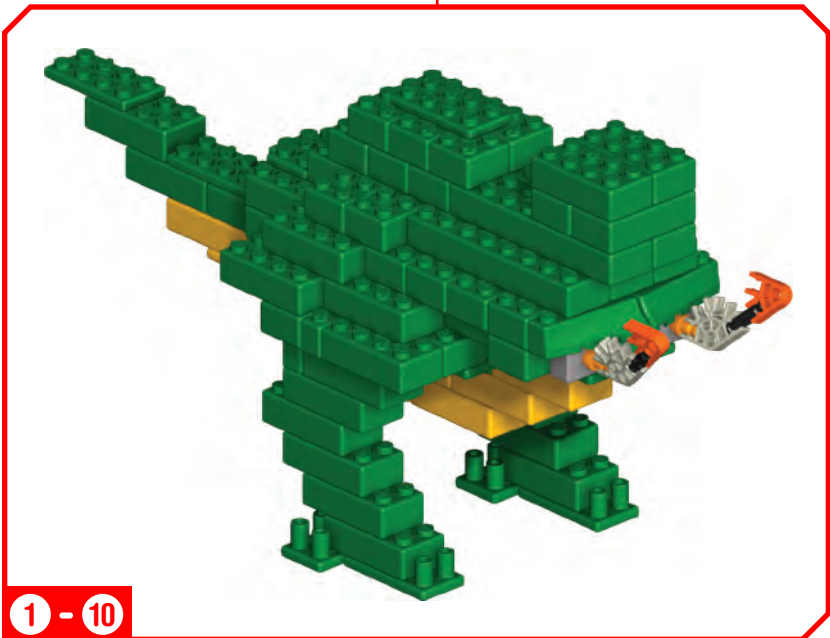

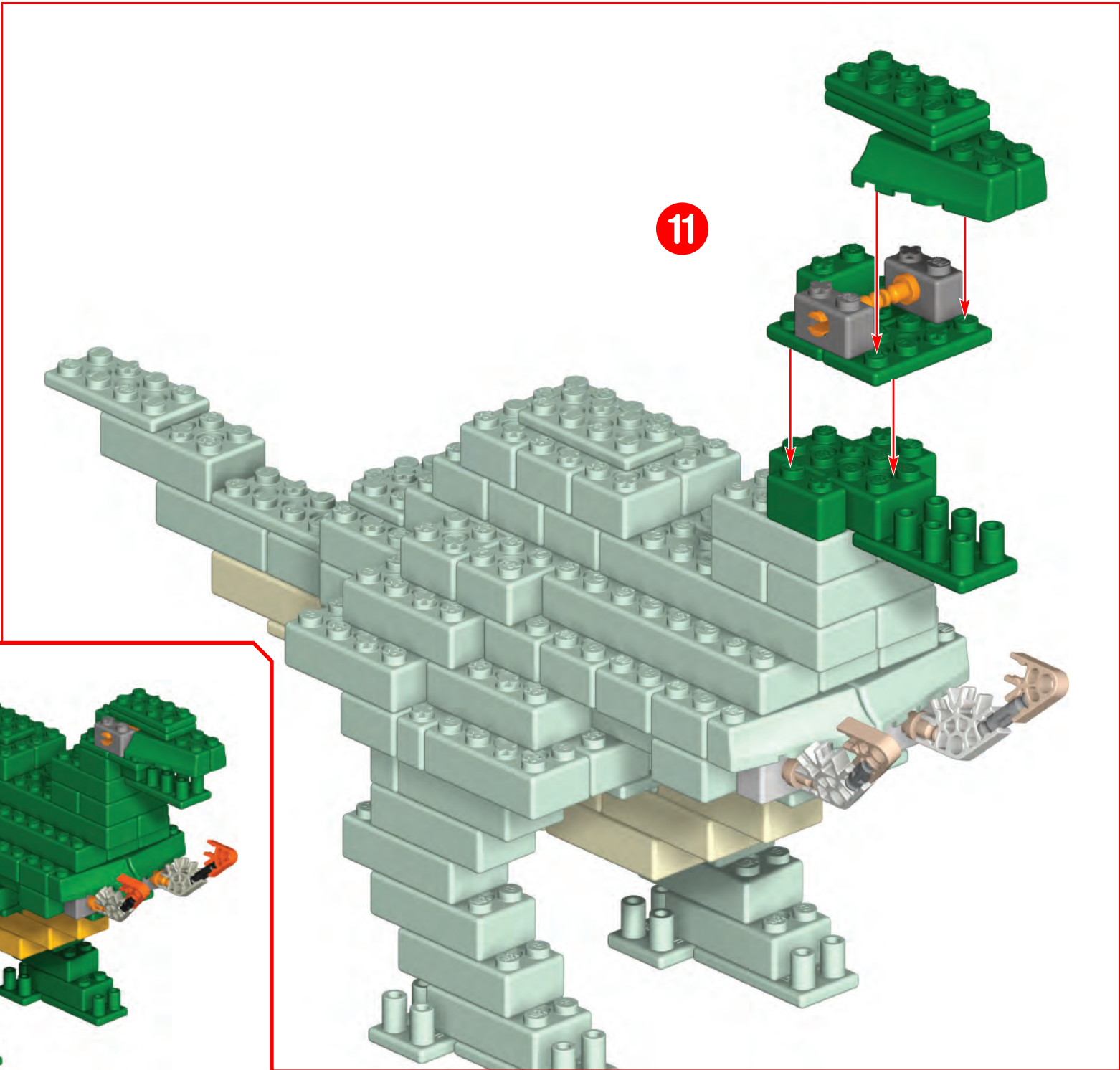
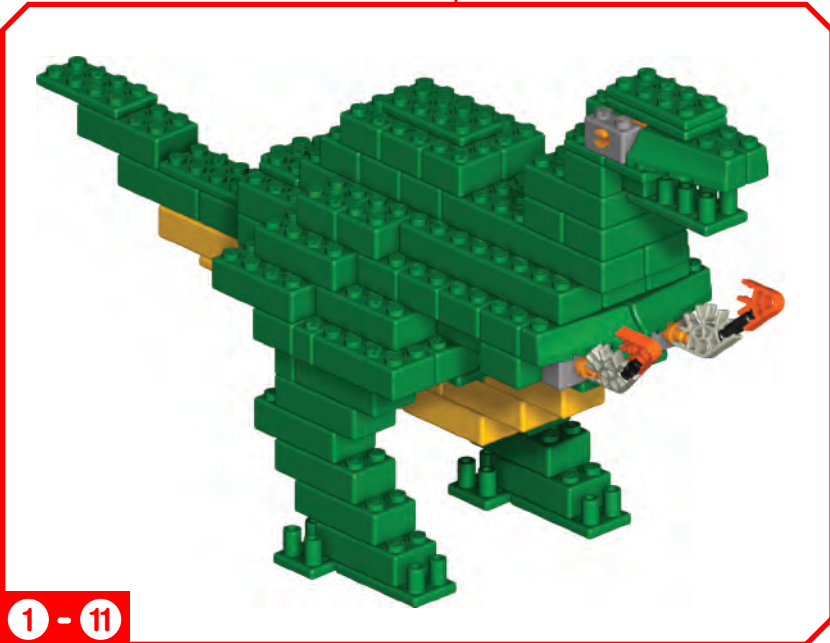

# Tow Truck

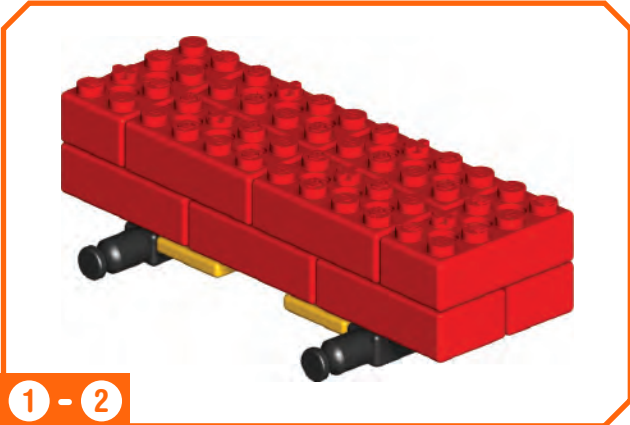

1 - 2

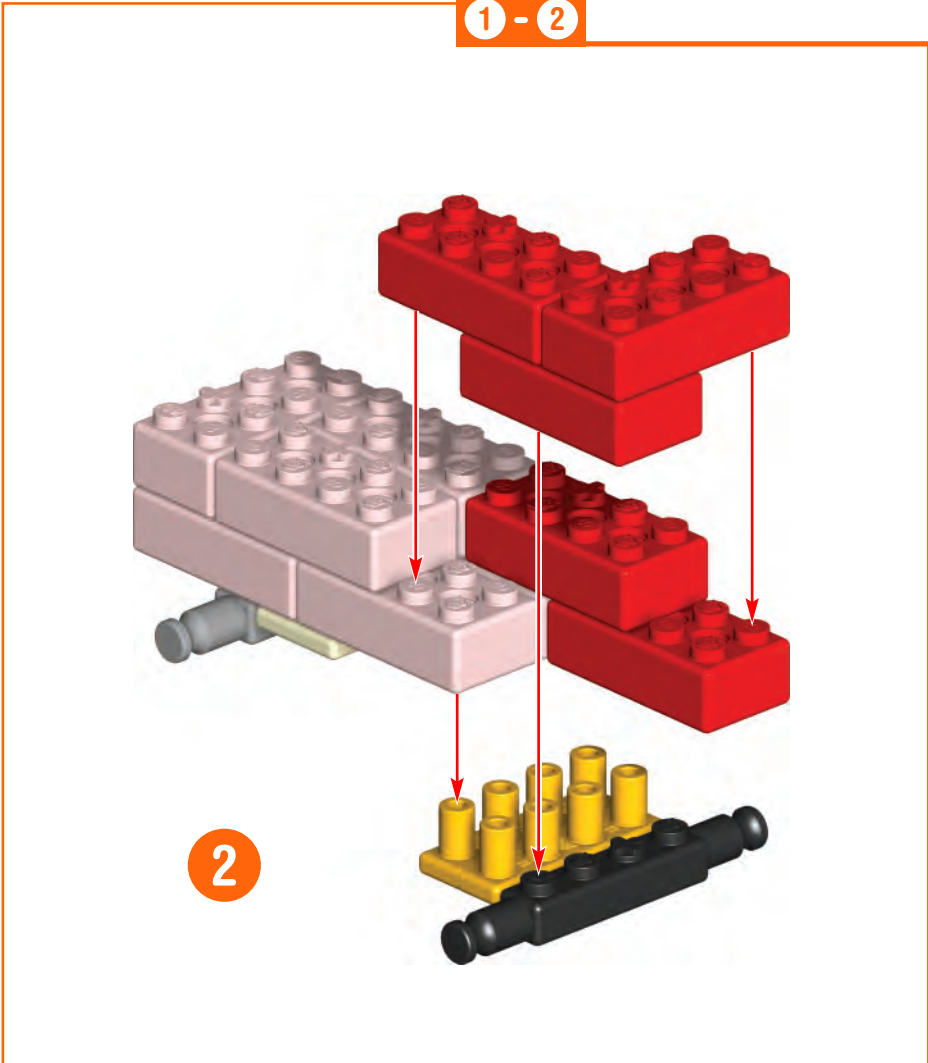
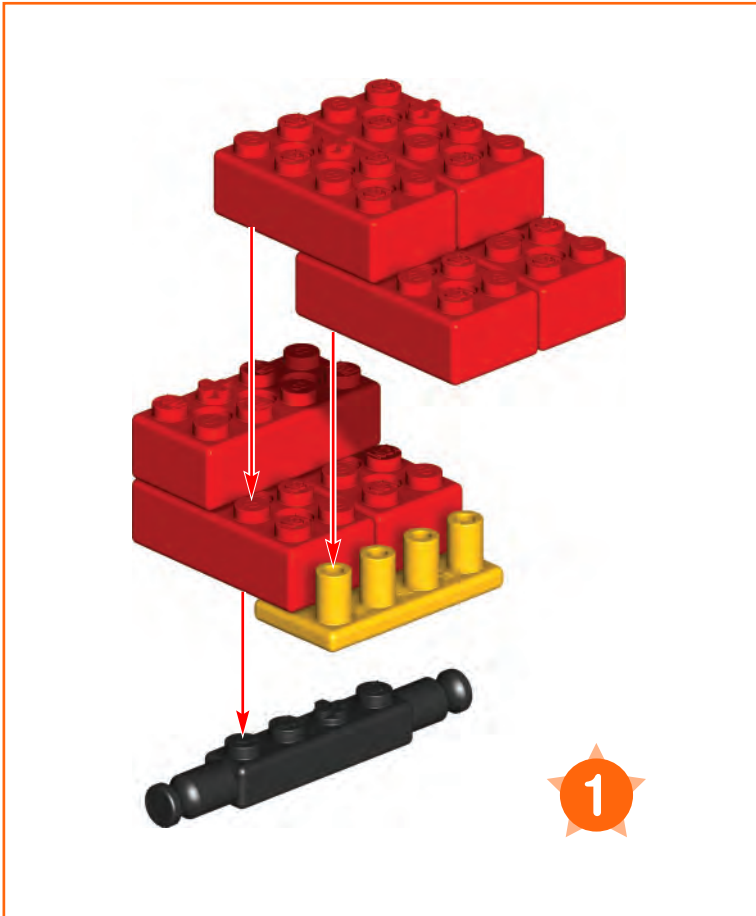



3

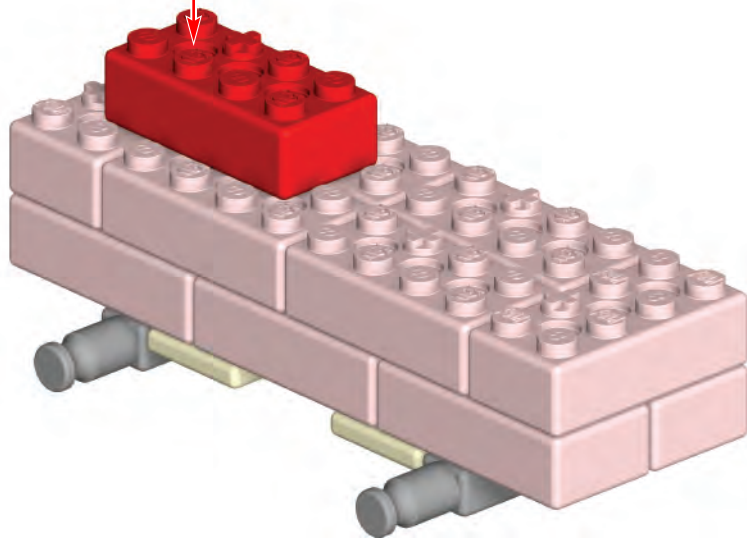

1 - 3

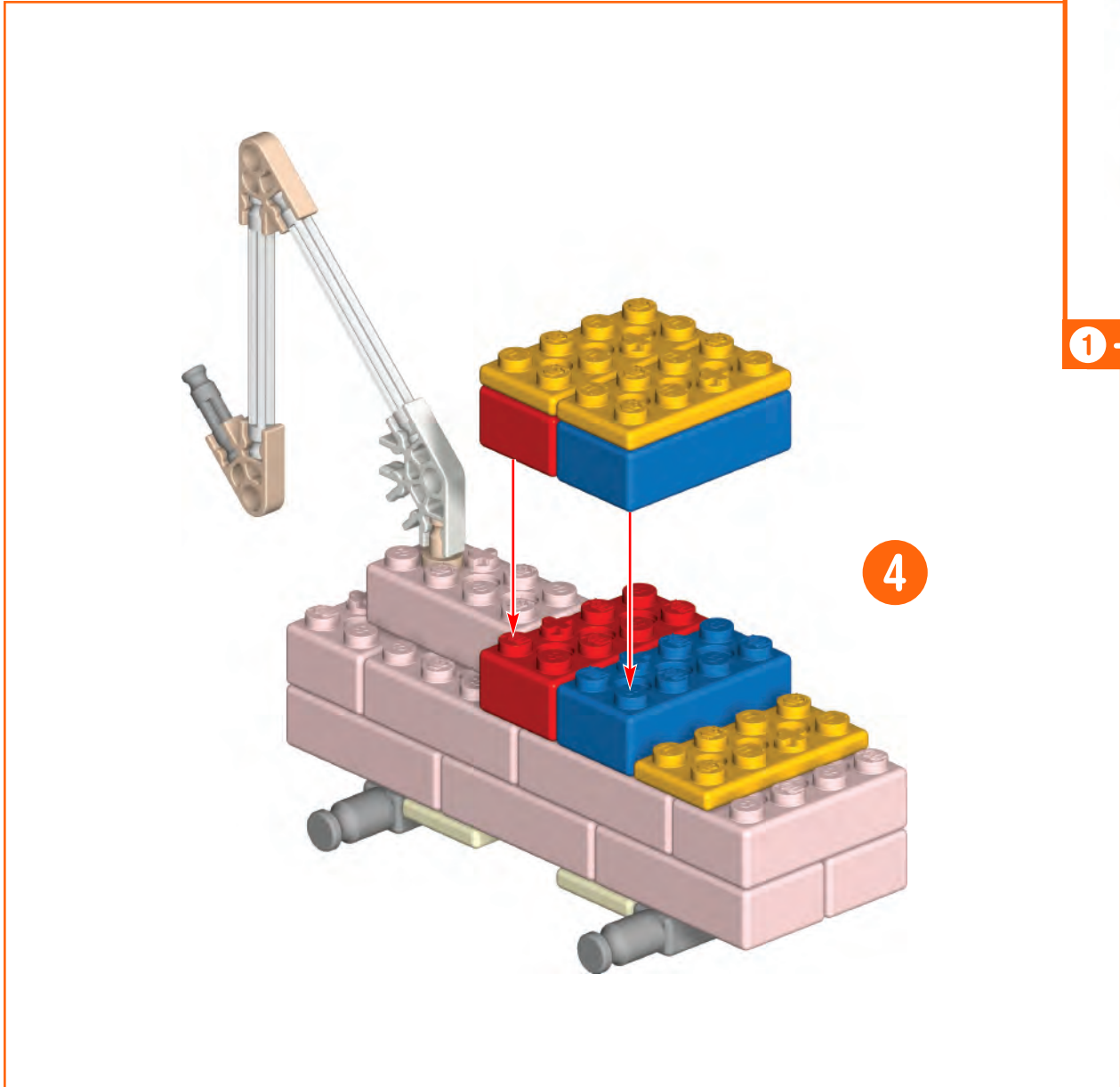

1 - 4



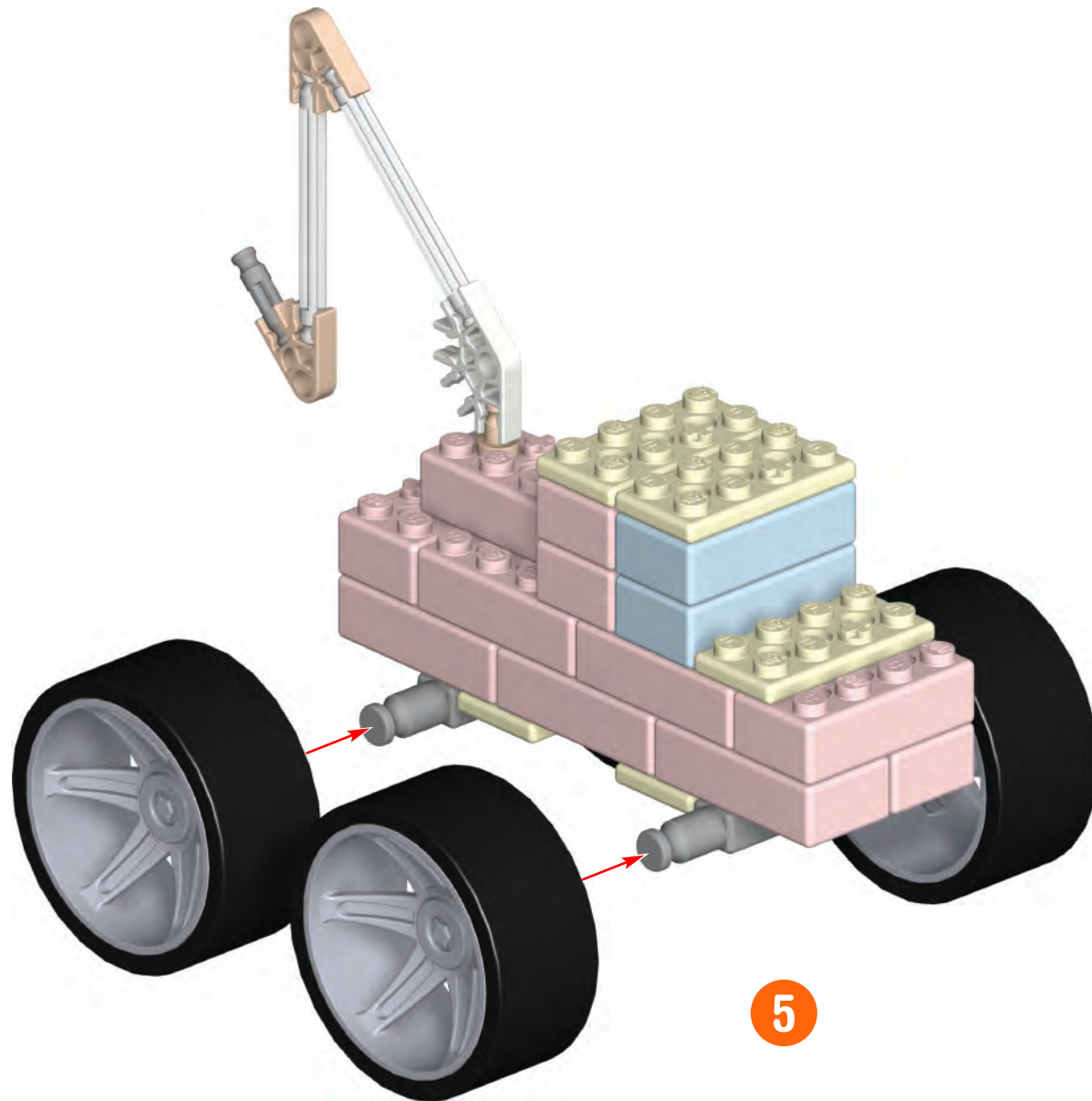

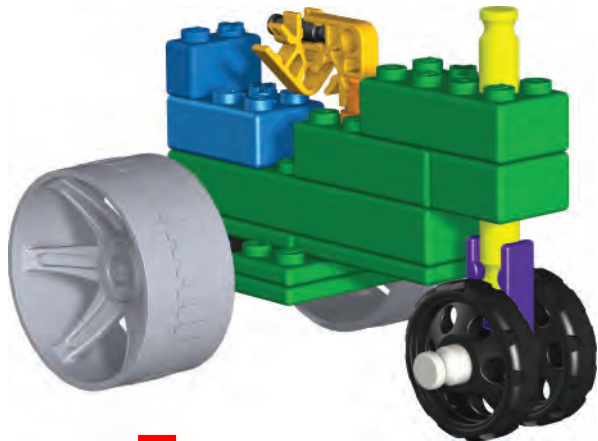

# Farm Tractor

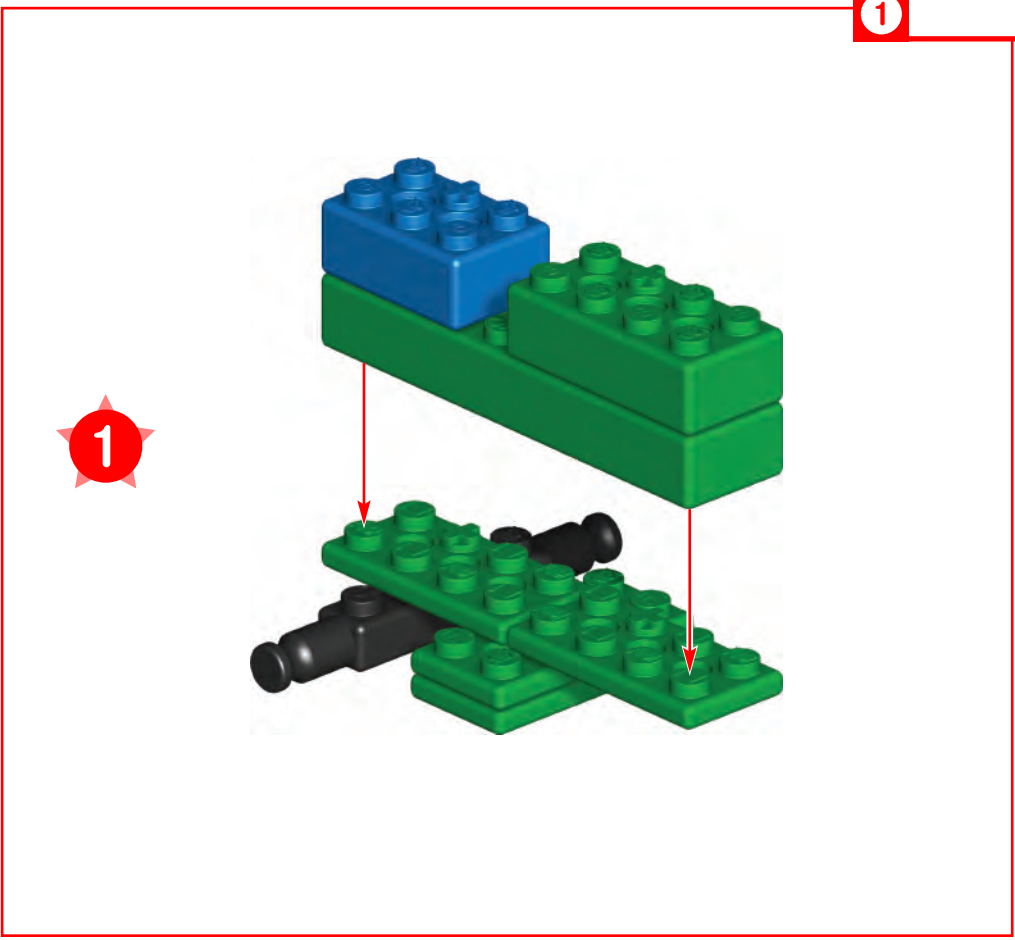
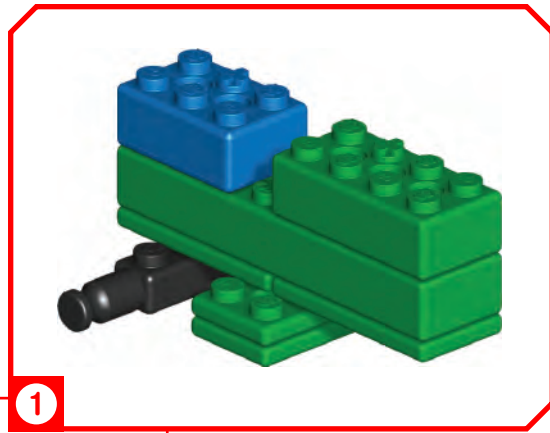

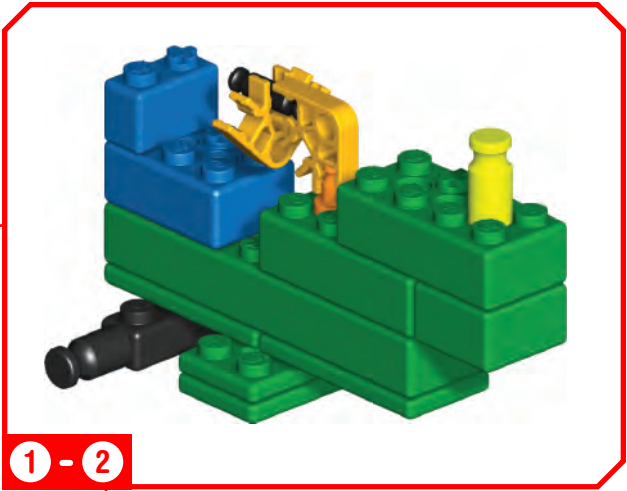
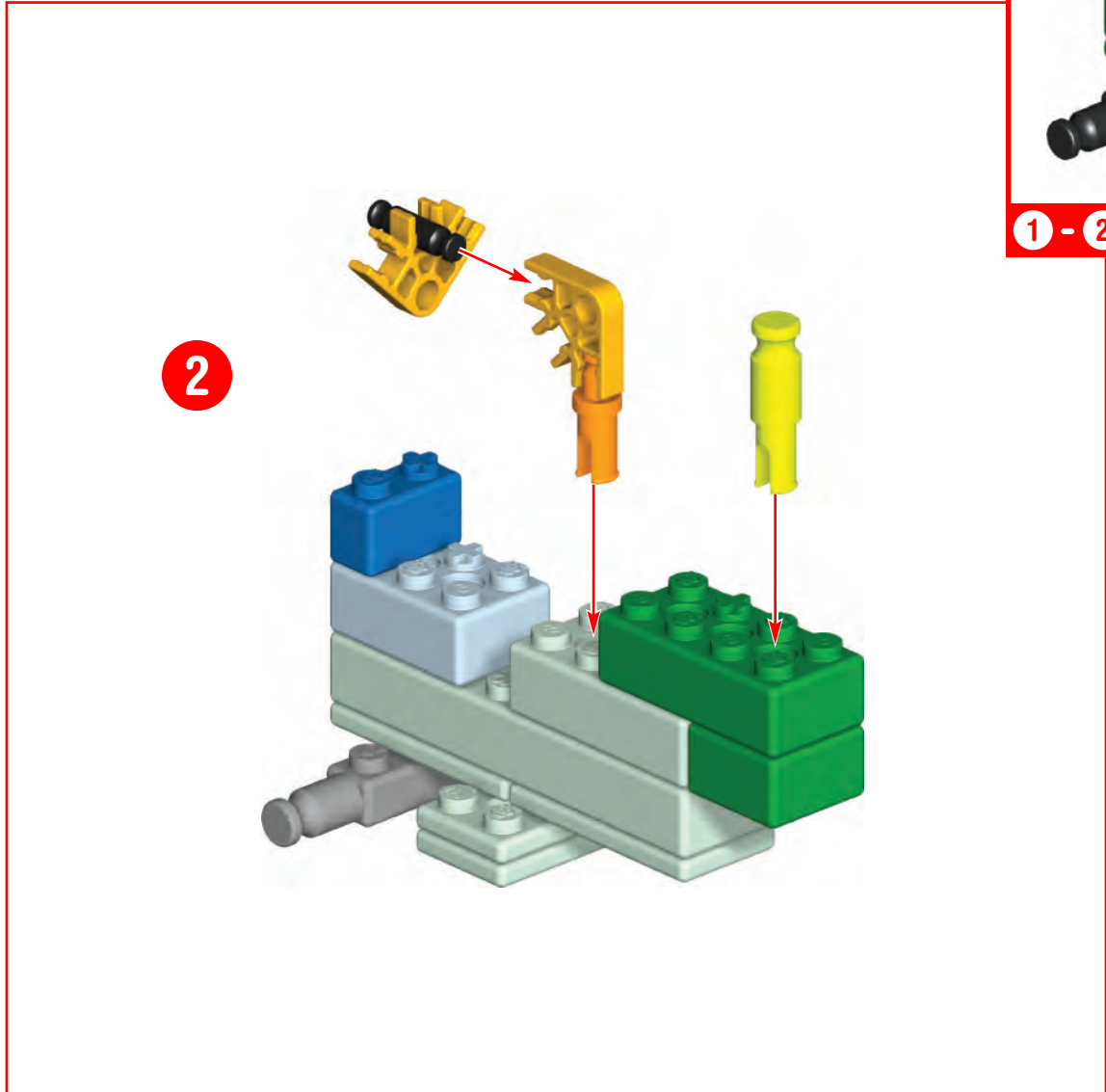

1 - 3

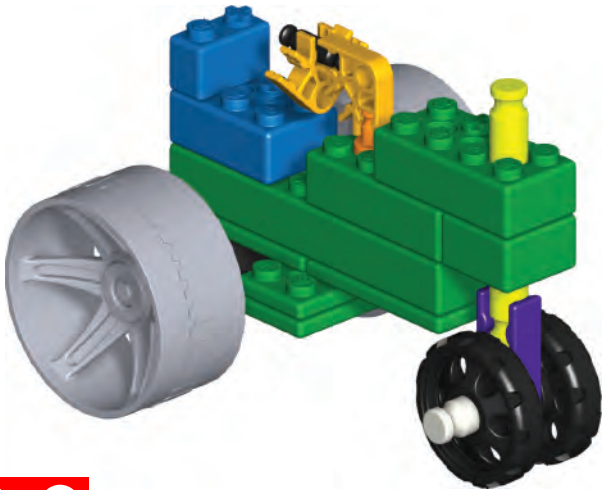

3

