

4 Wheeler

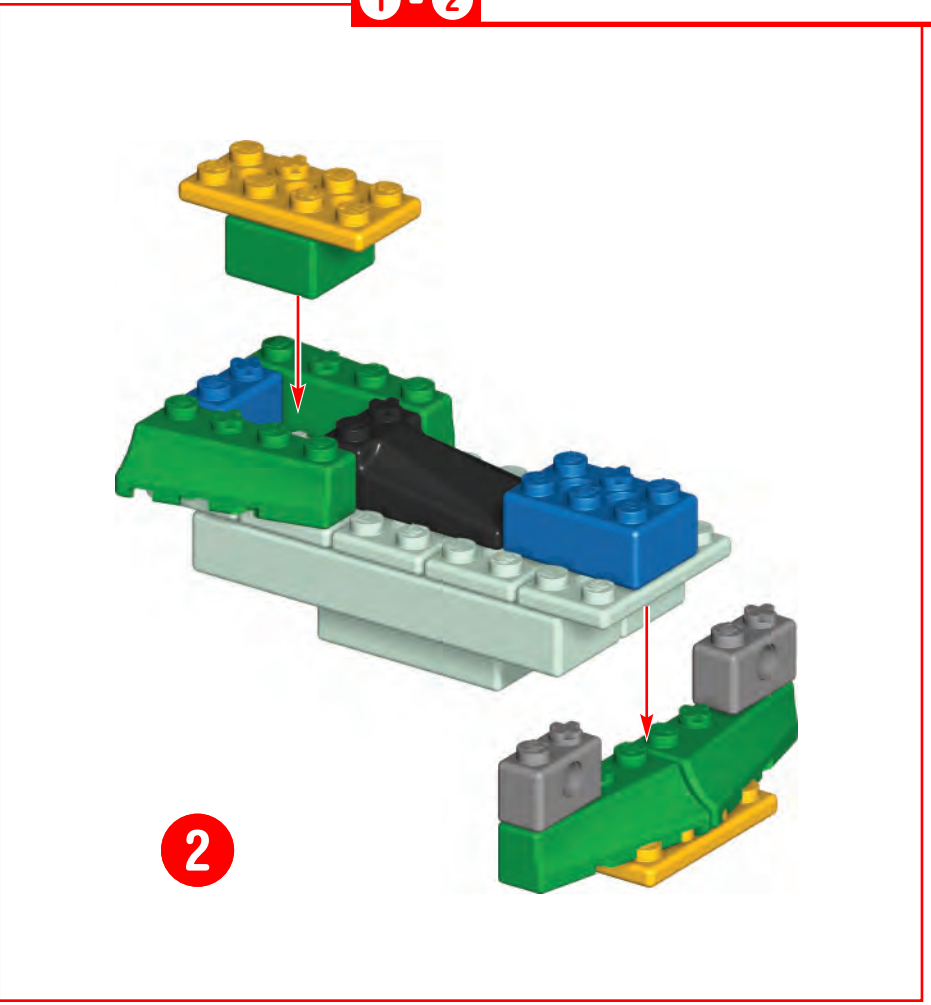

Turn your model upside down and add the wheels.

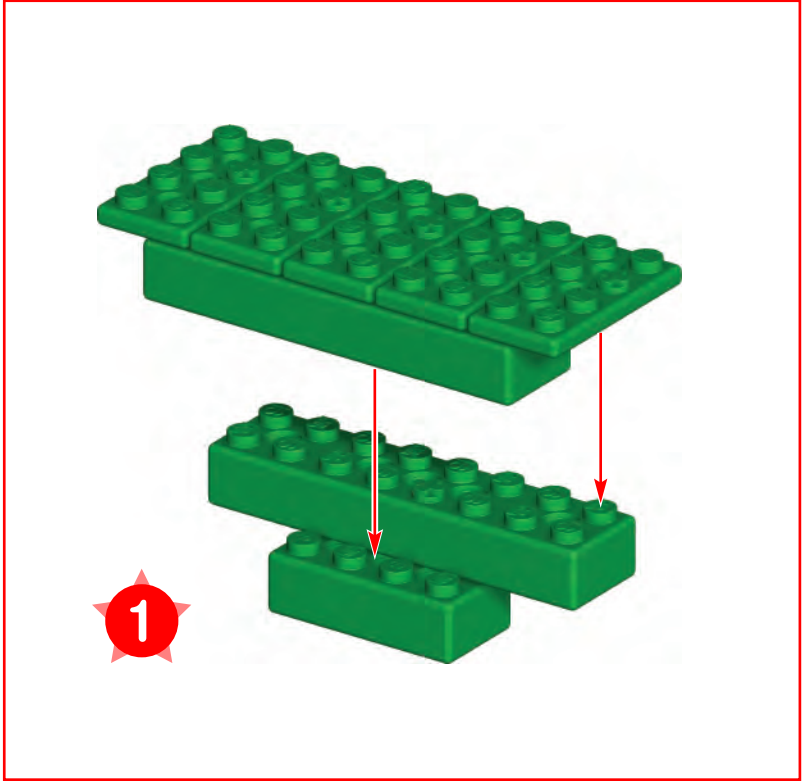
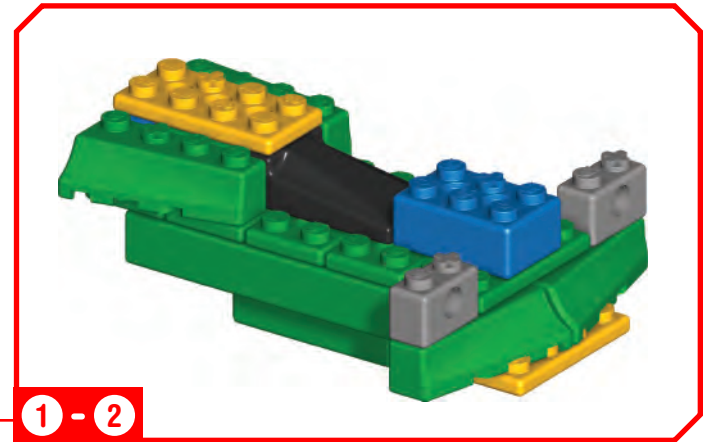
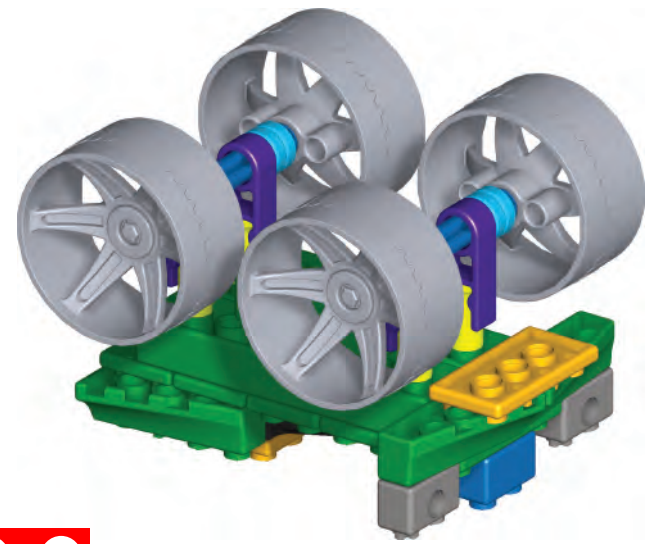
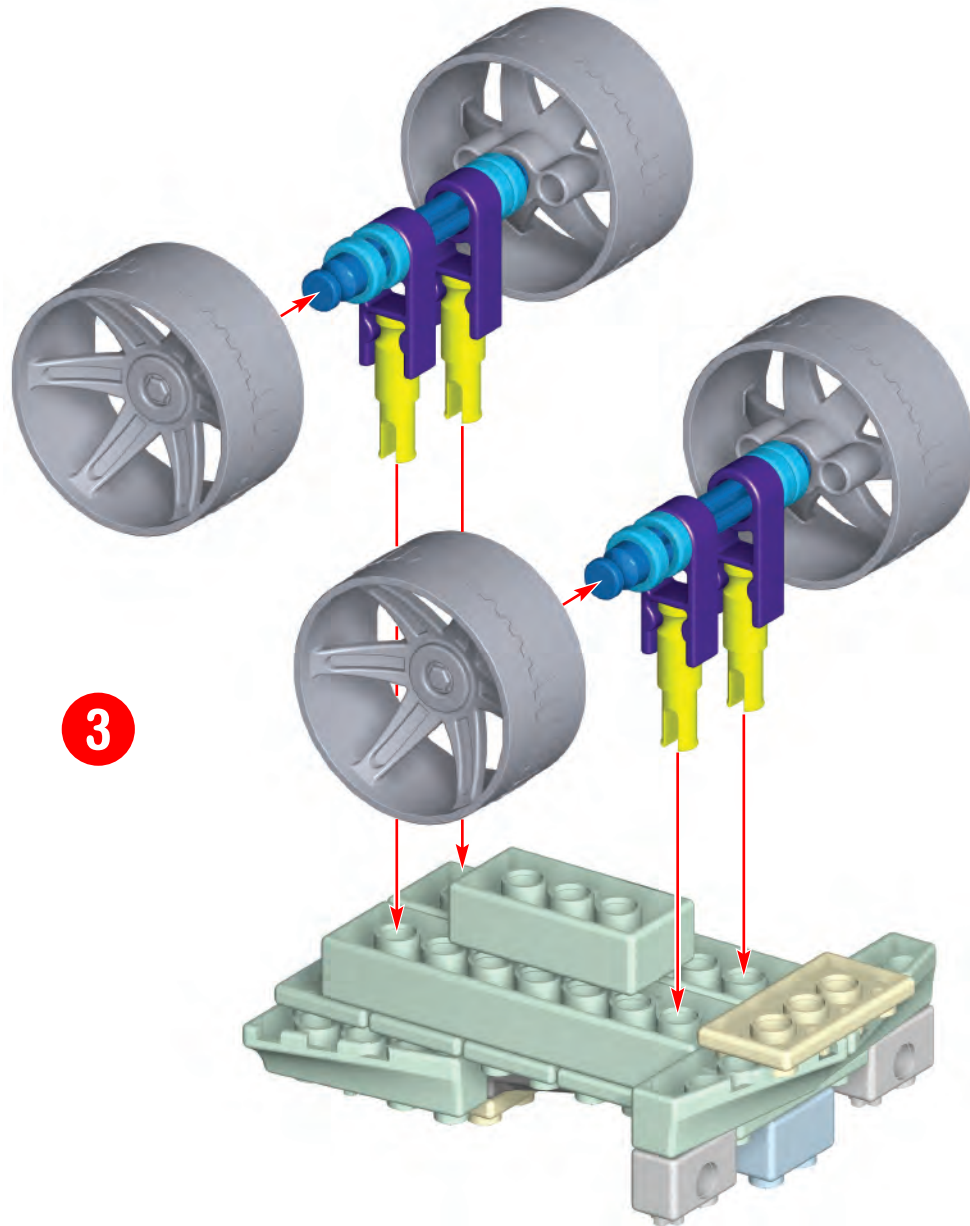

1 - 3

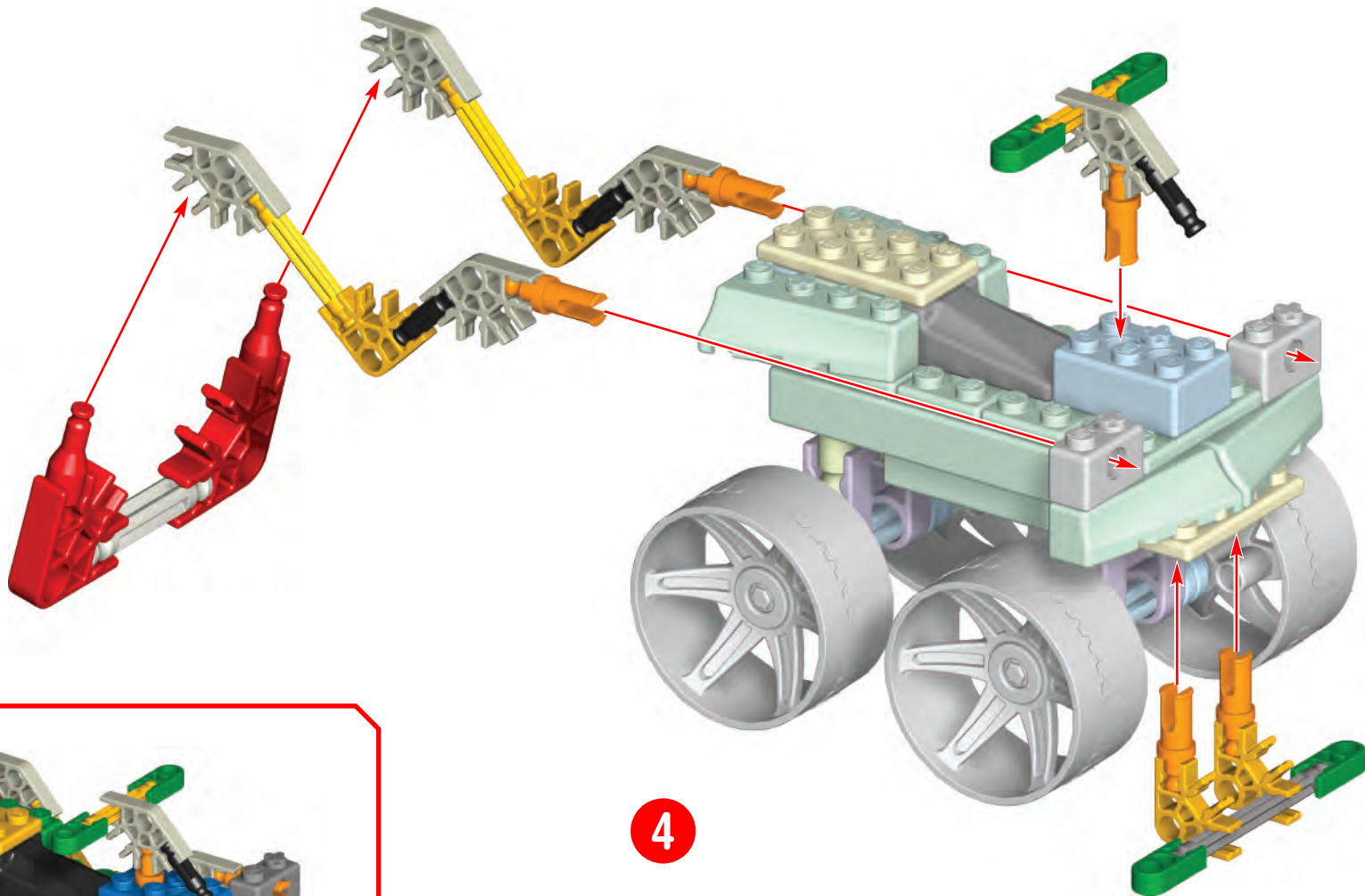

4



1 - 4



4x4 Truck

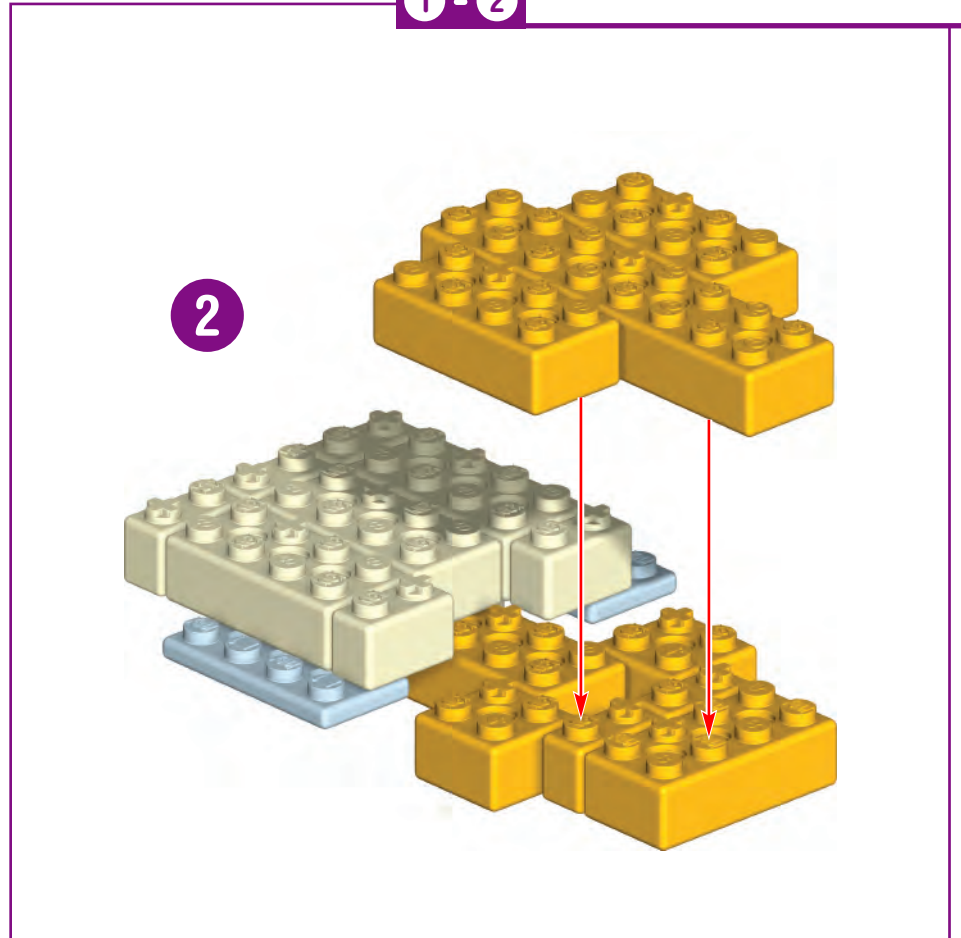
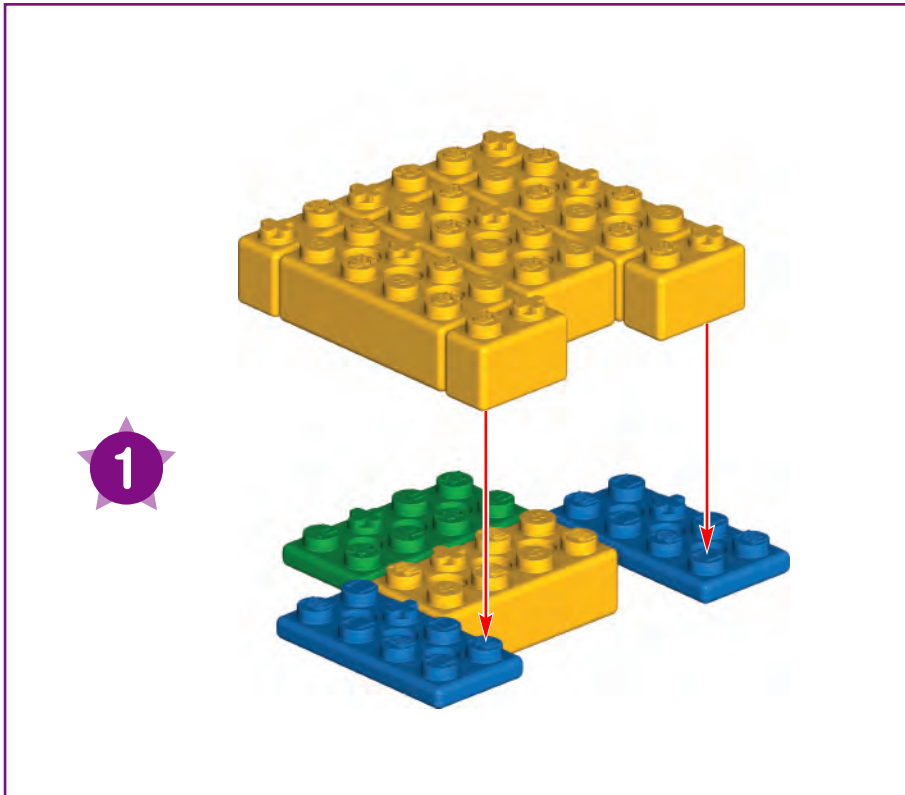
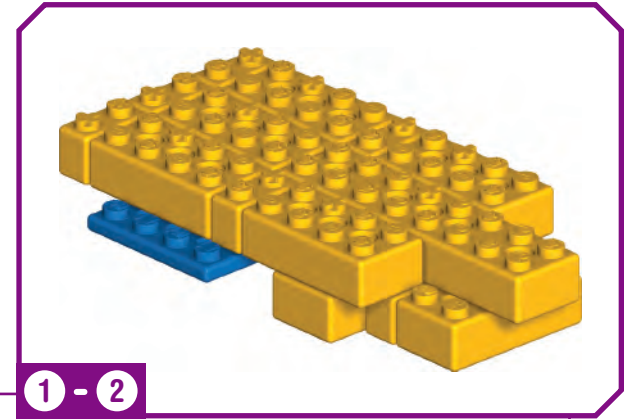

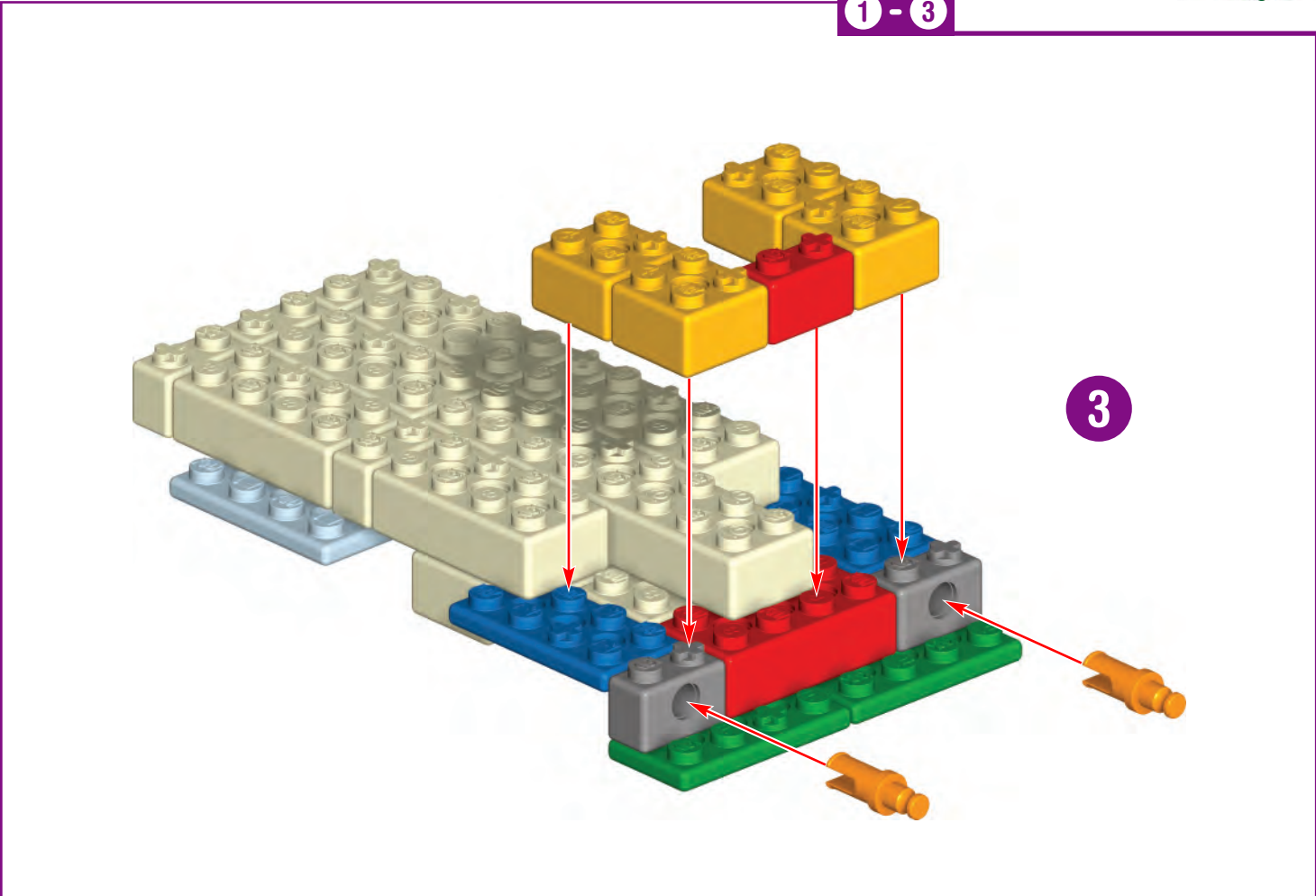
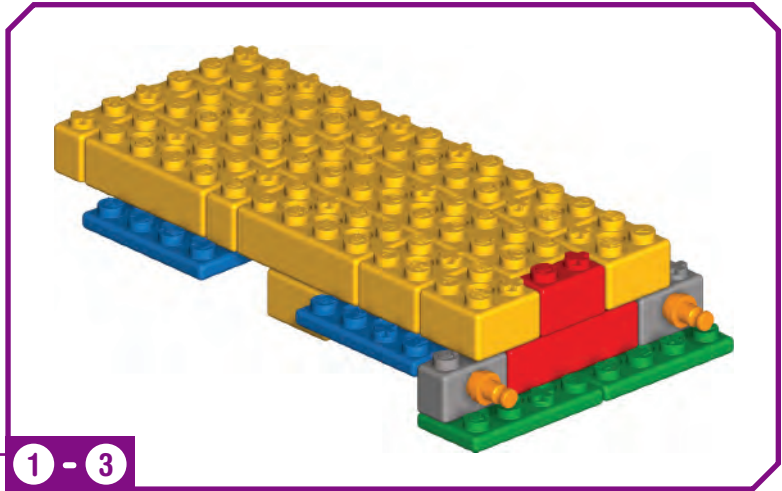

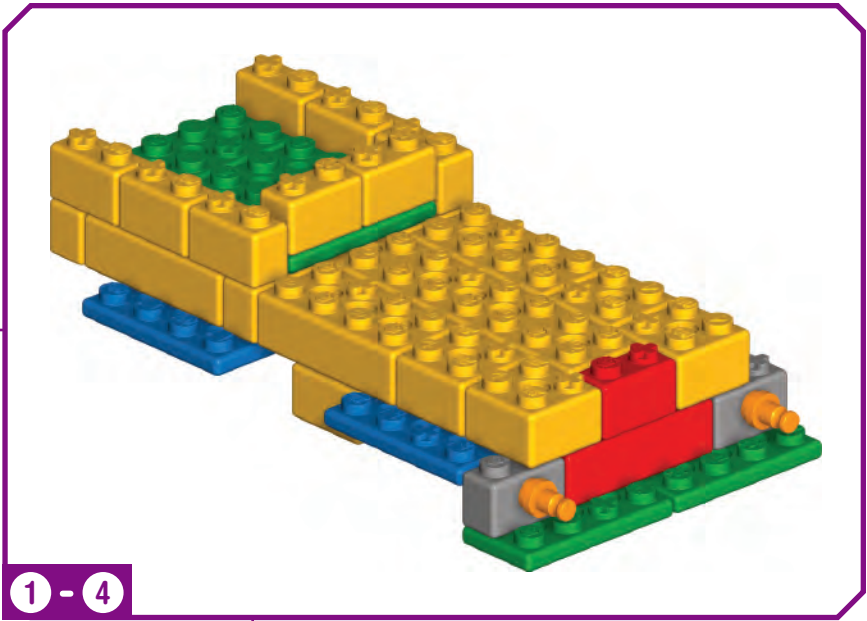
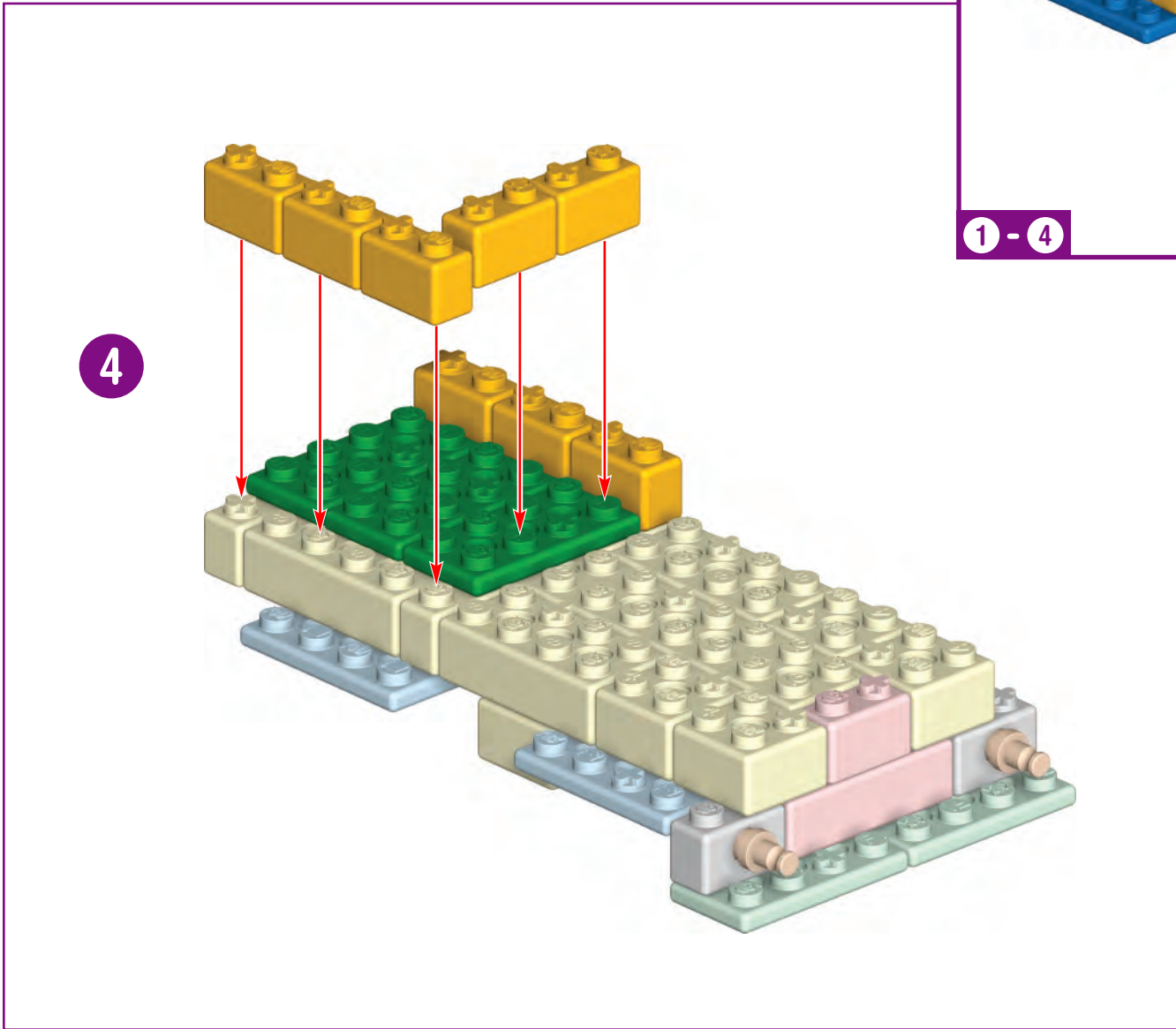

5

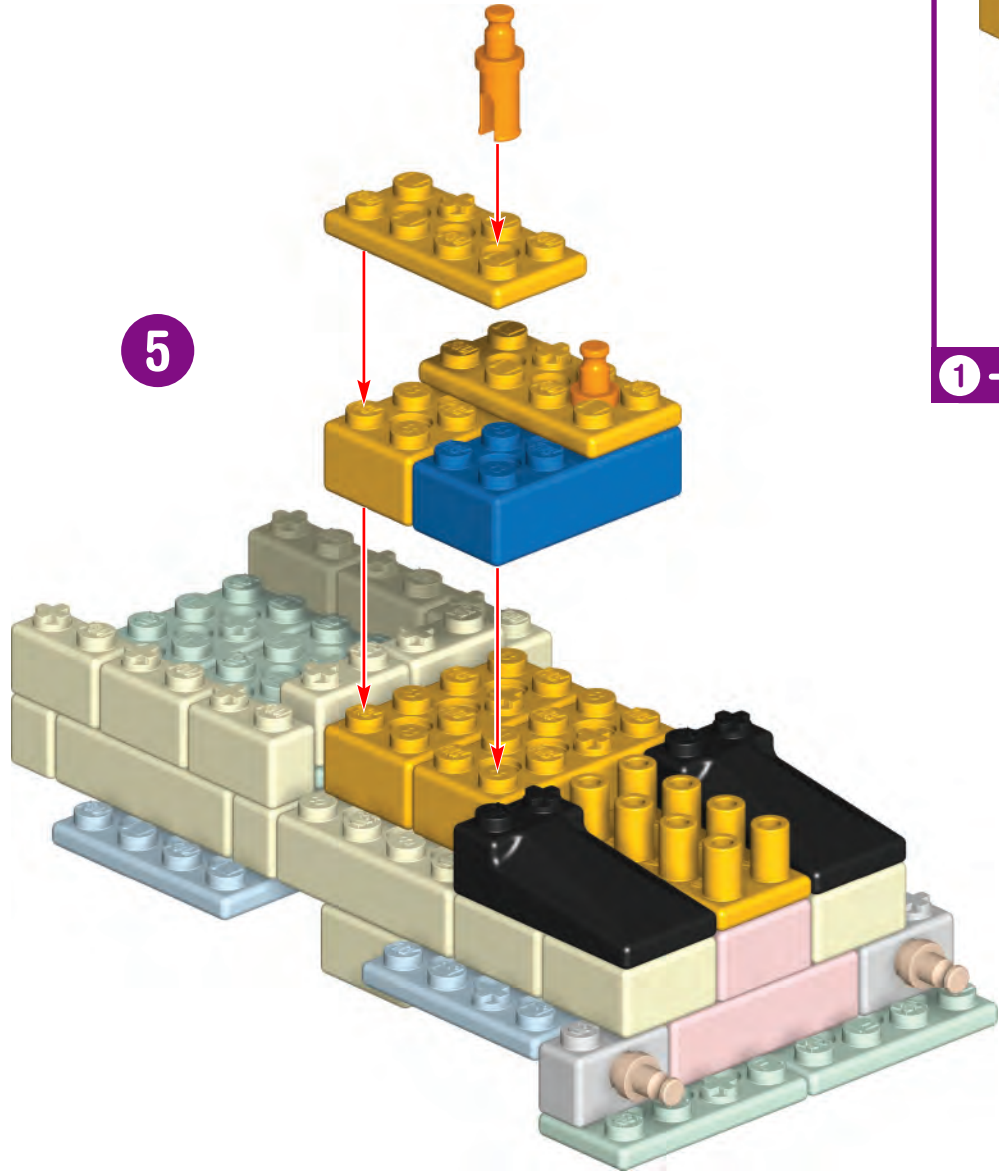

1 - 5

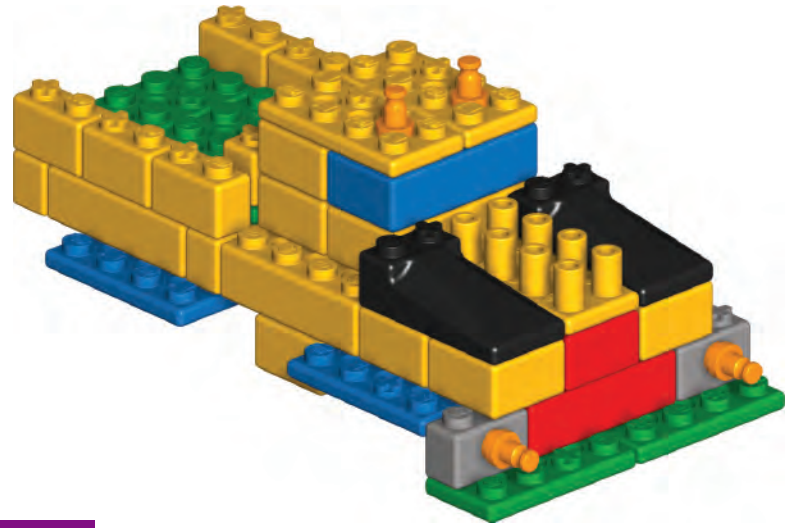

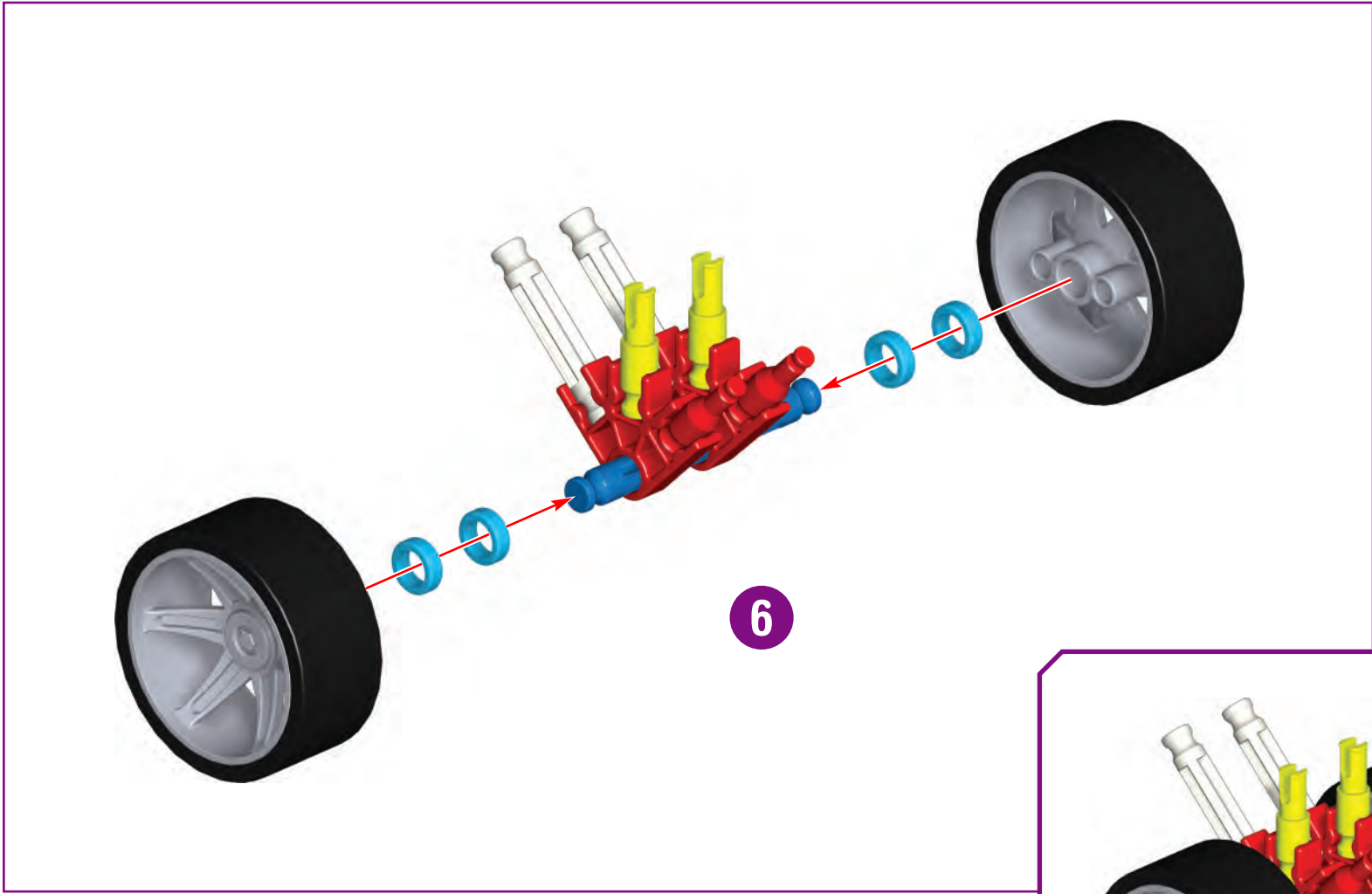

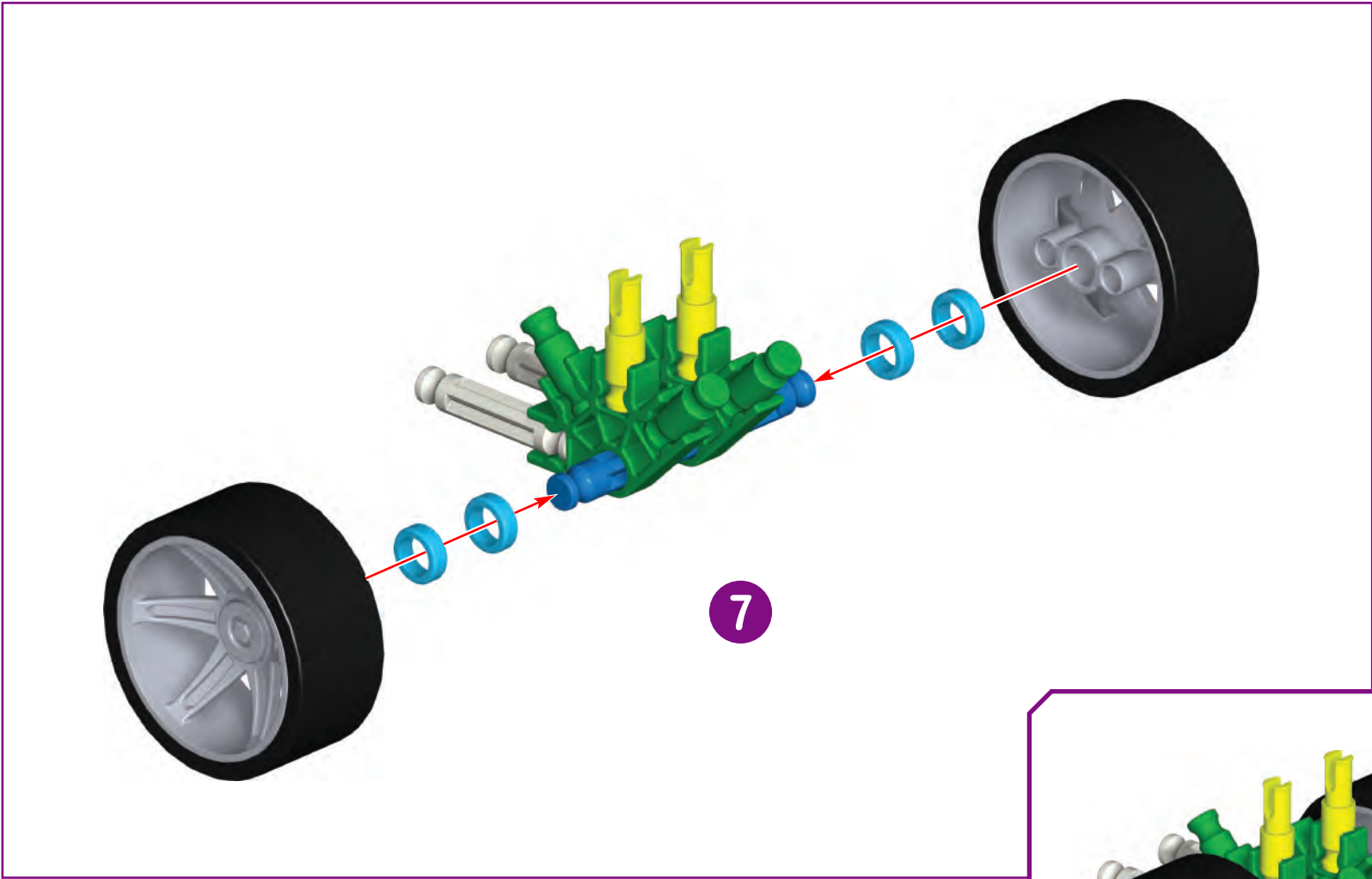

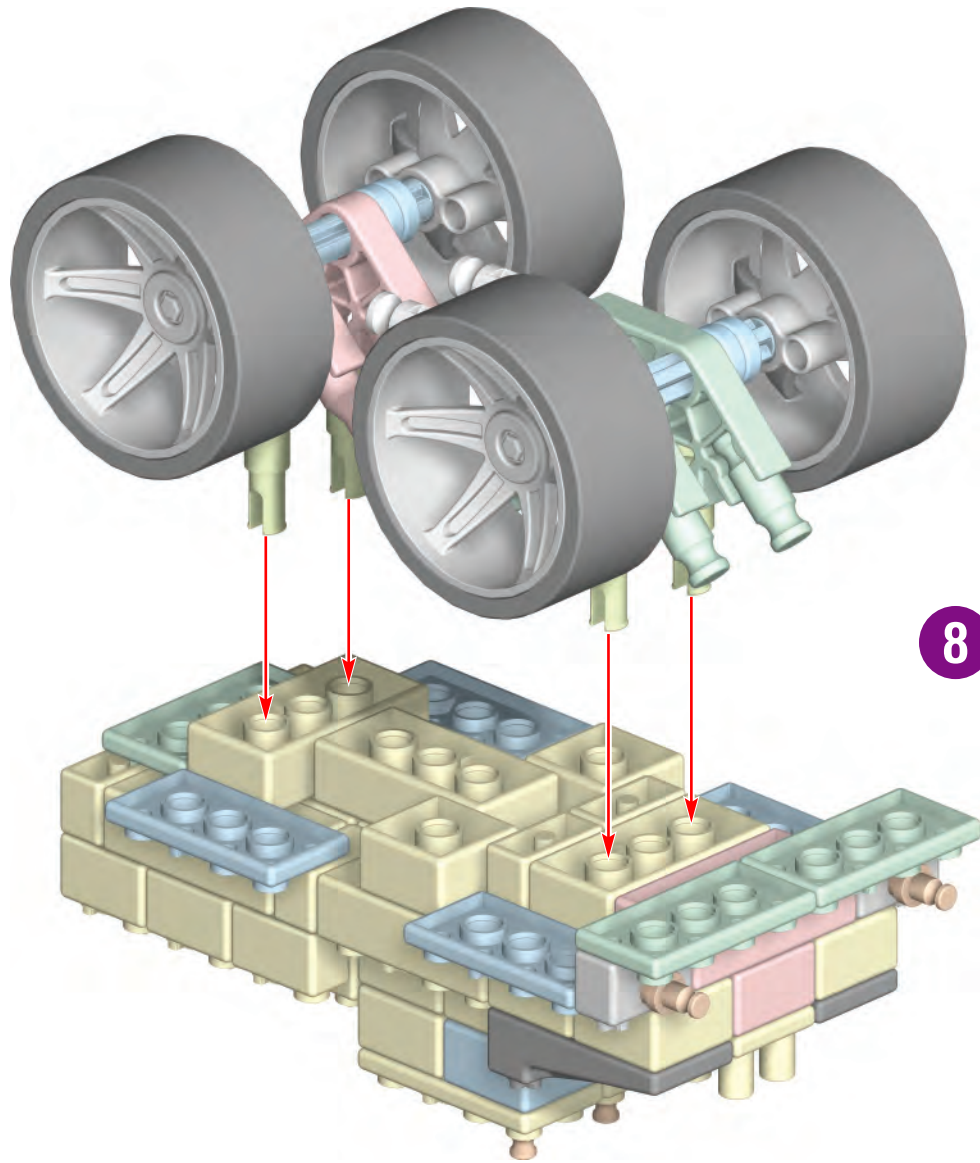

1 - 8



Now turn the truck upside down to attach the wheels.

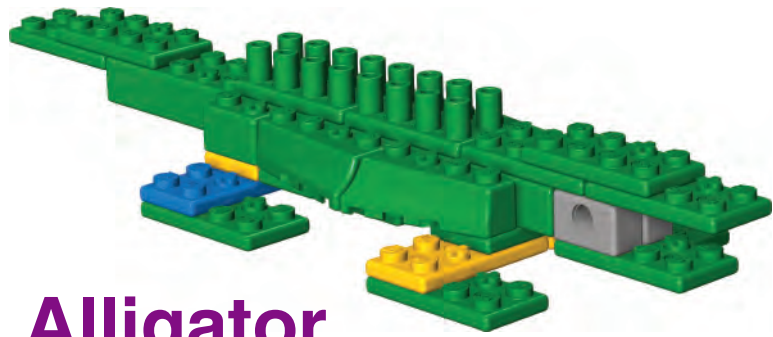

Alligator

1 - 2

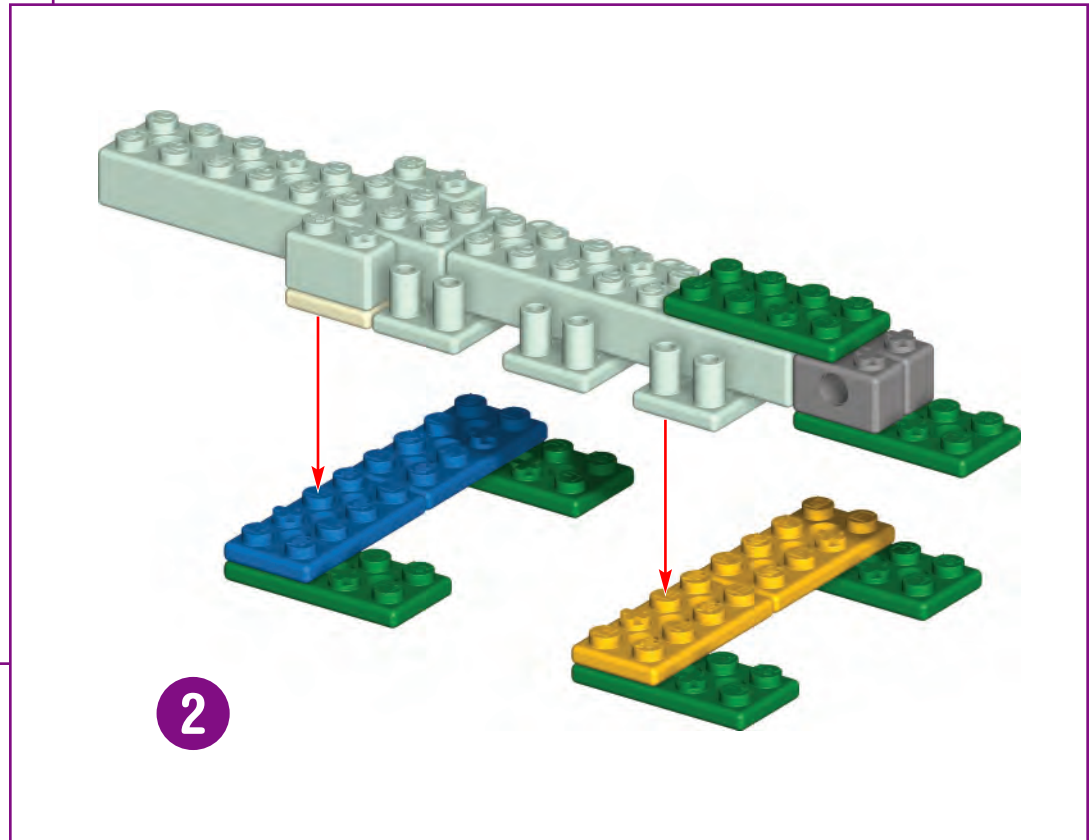
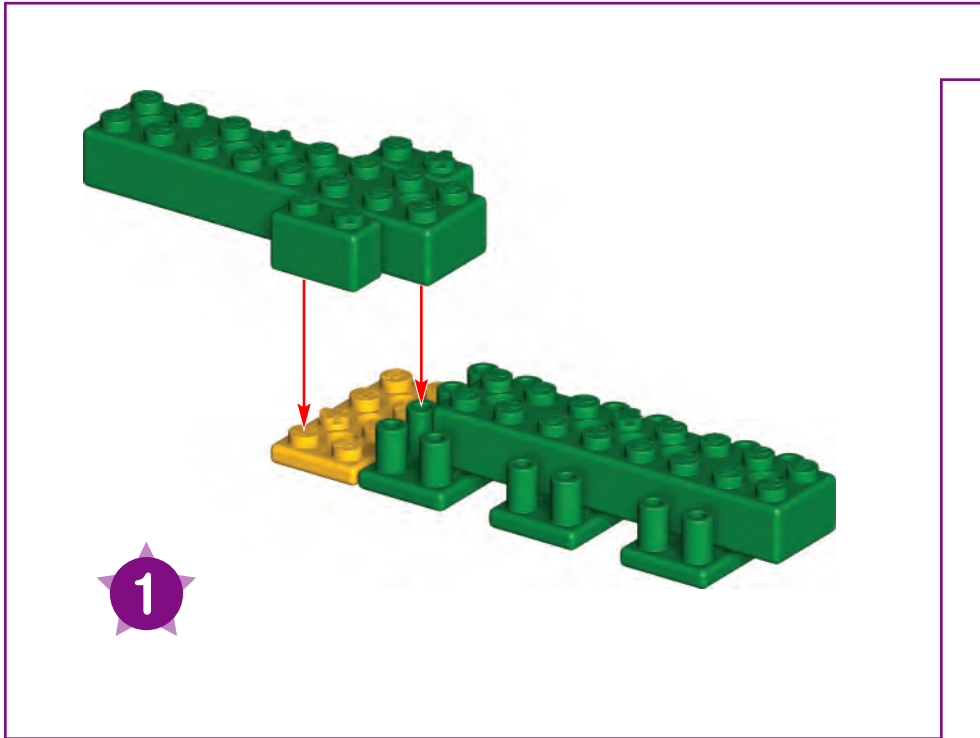
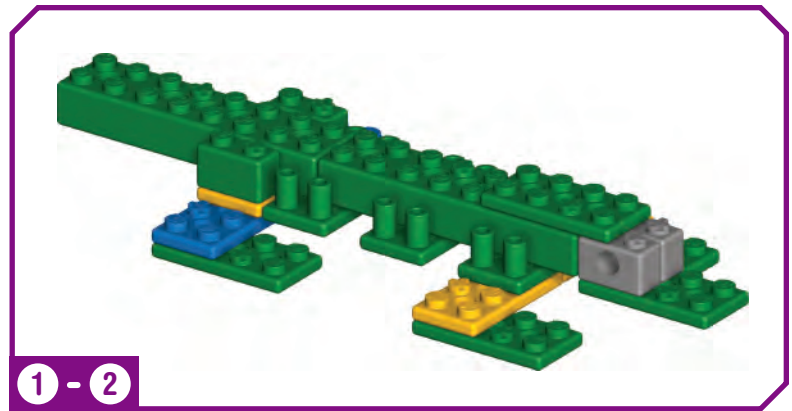

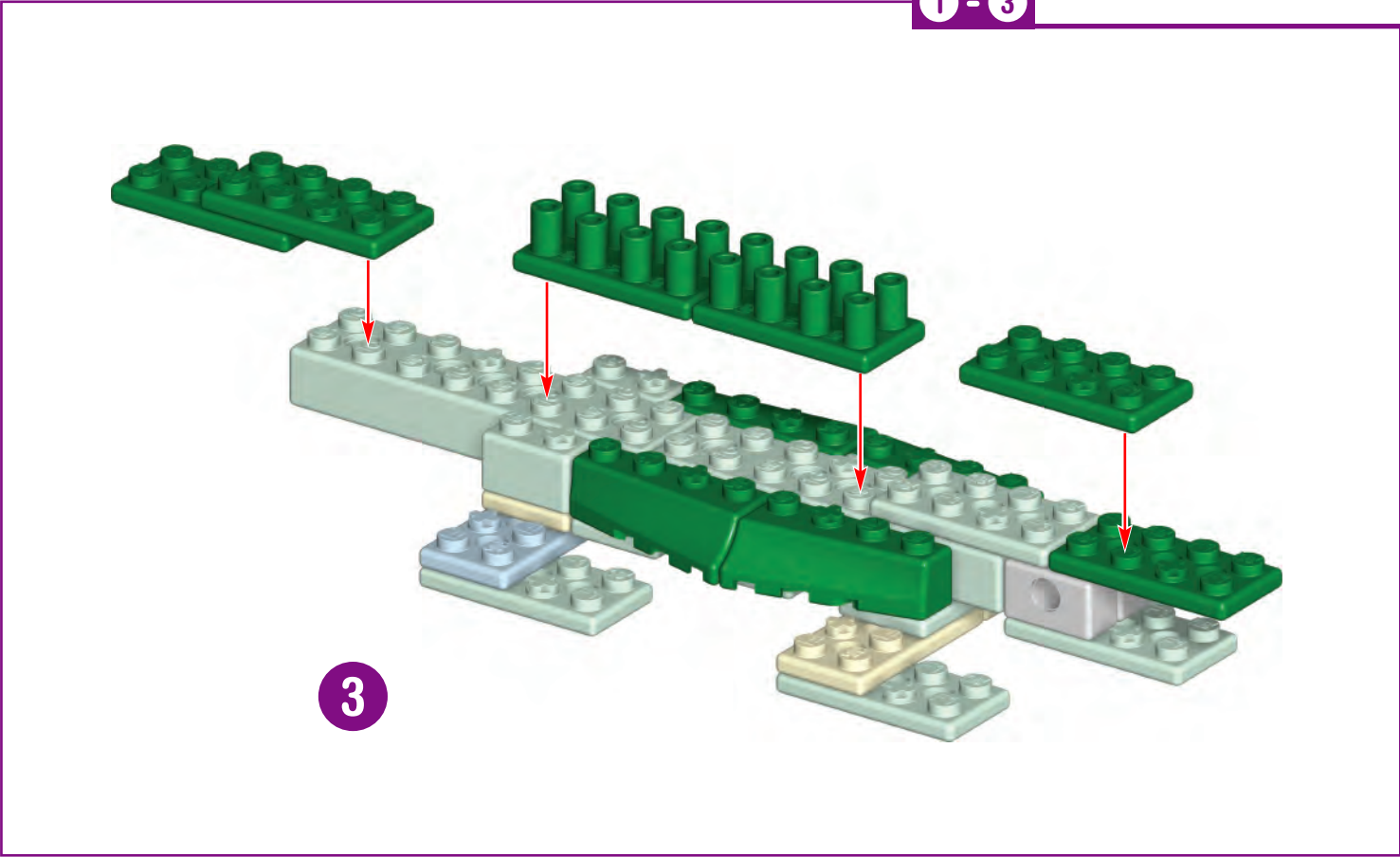
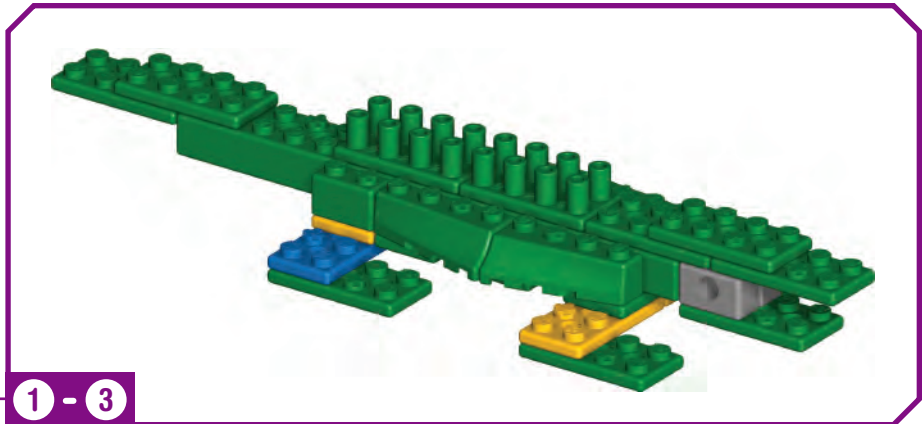

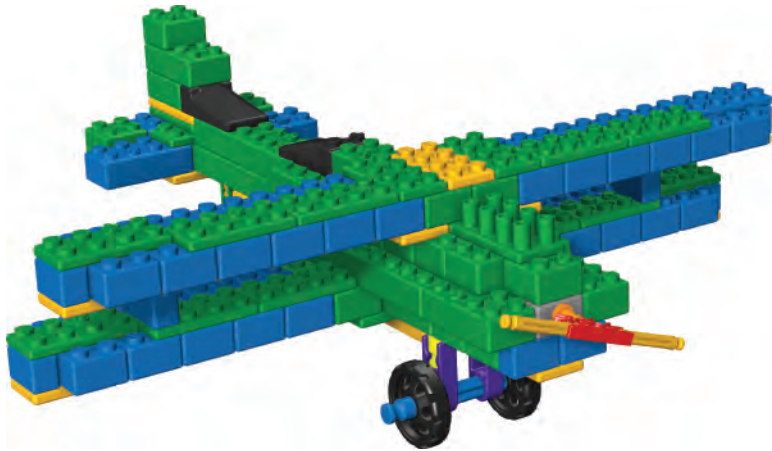

Biplane

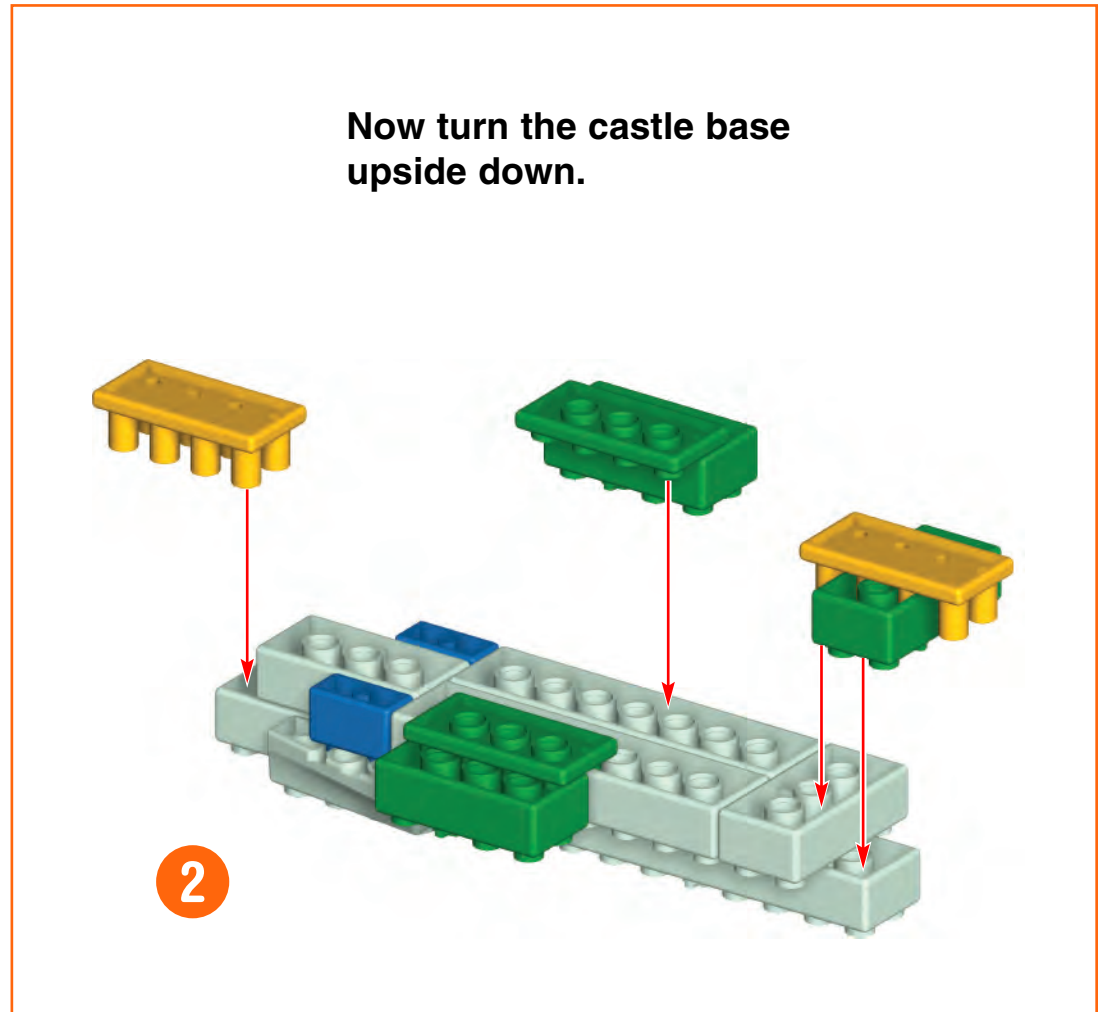
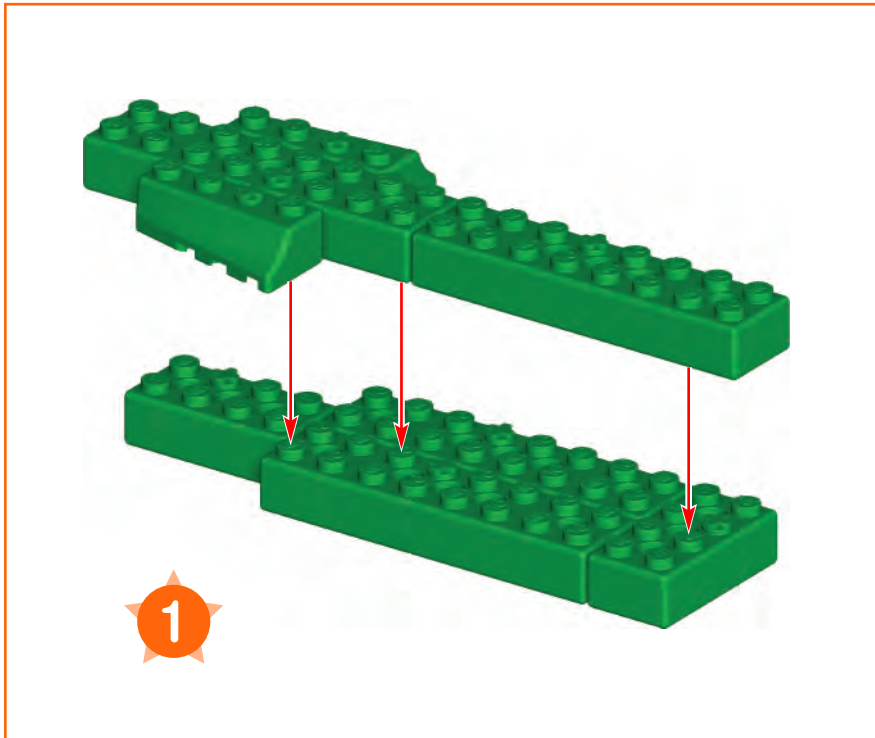
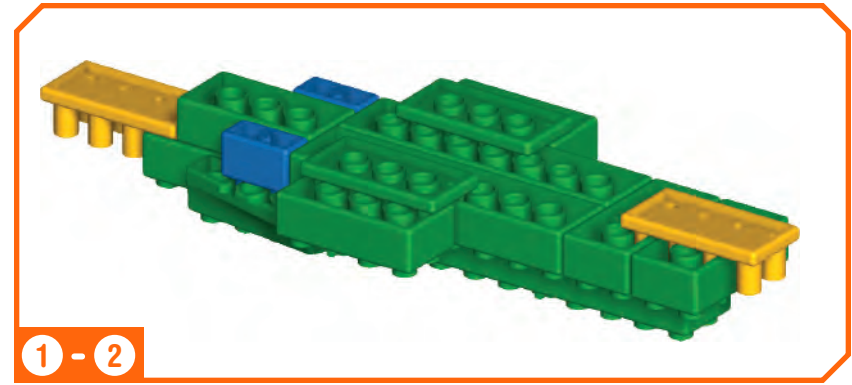

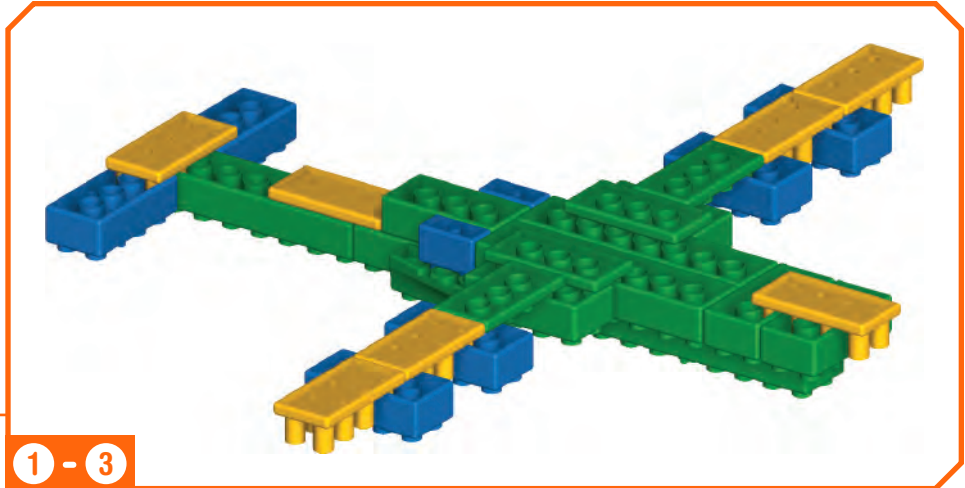

1 - 3

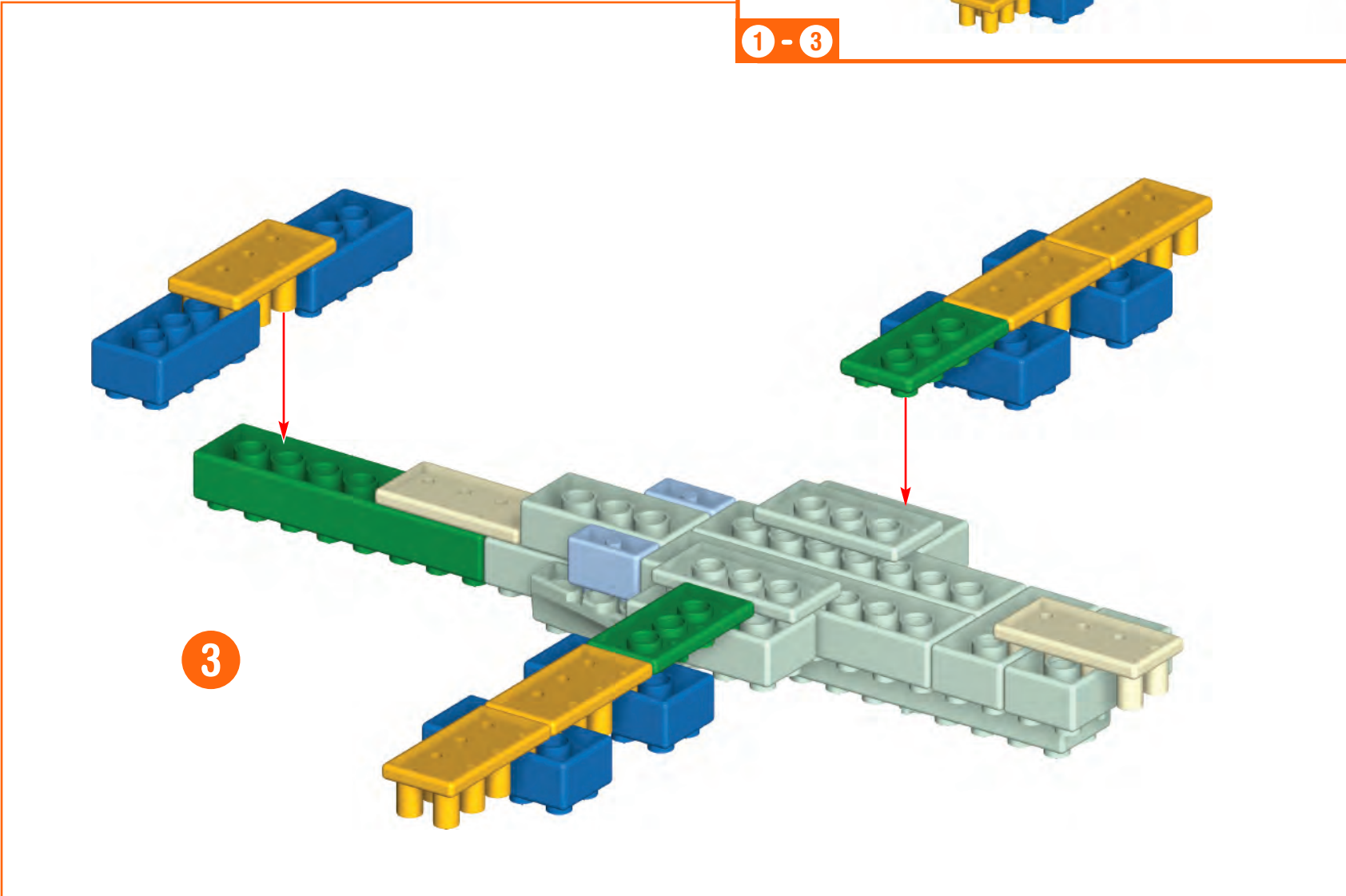

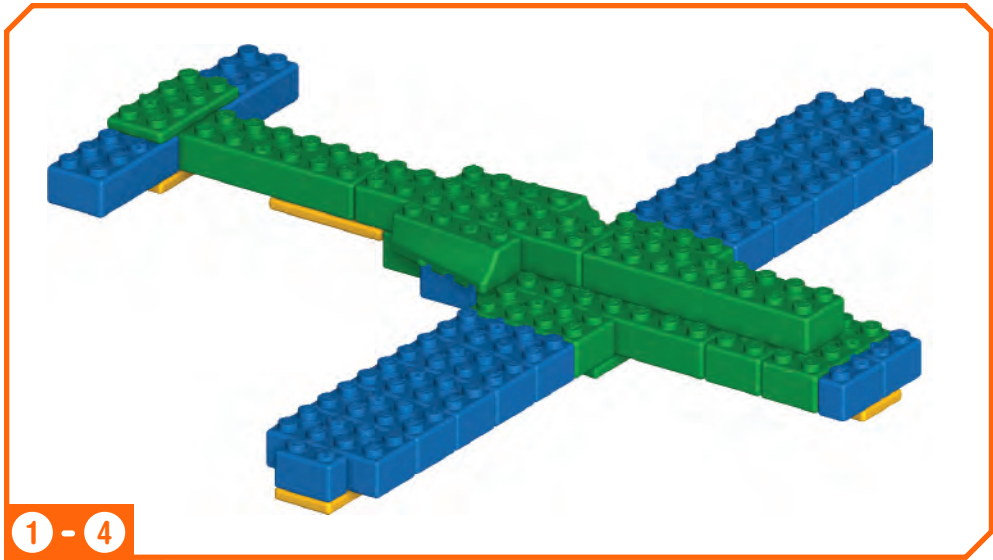

1 - 4

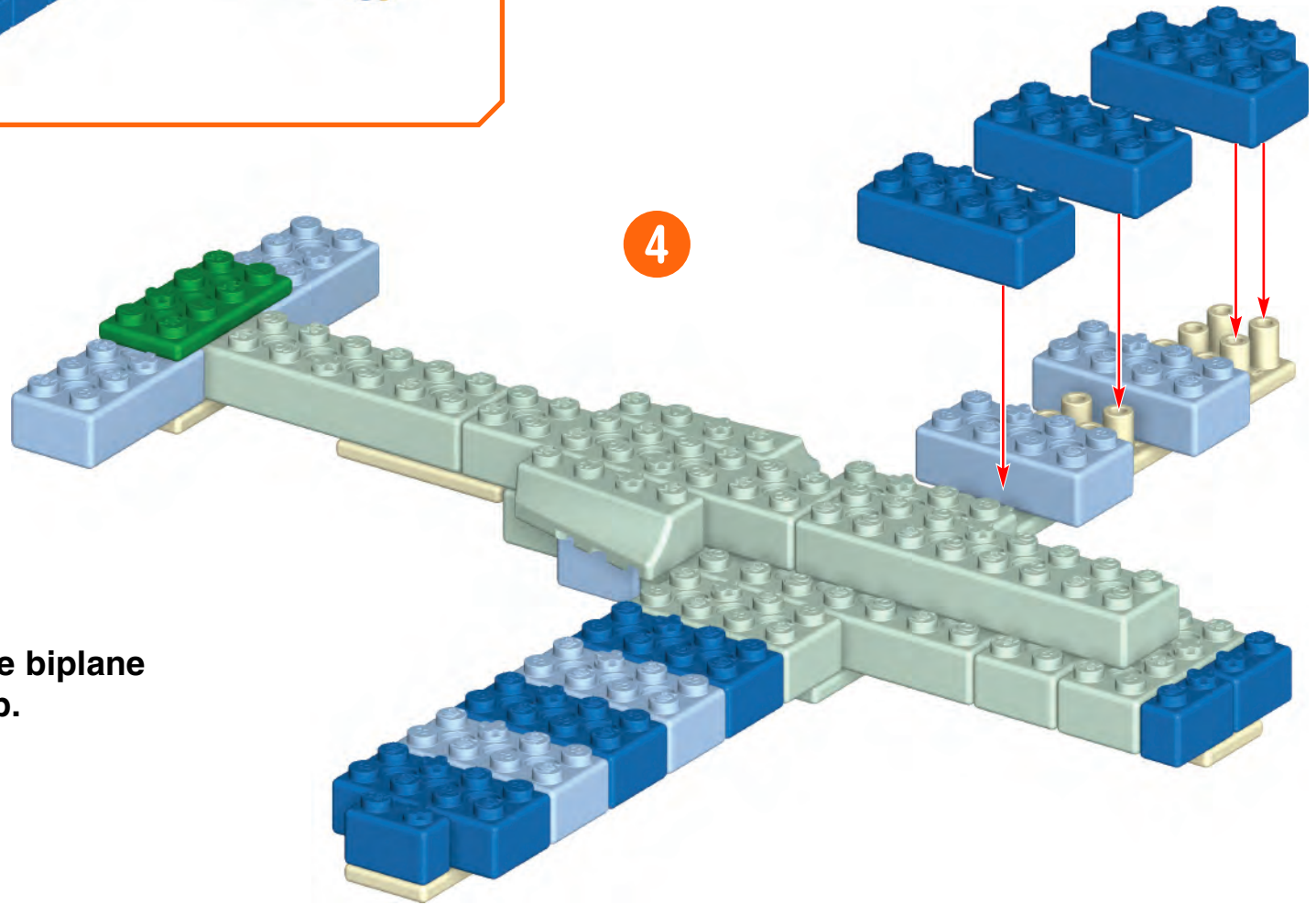

Now turn the biplane right side up.

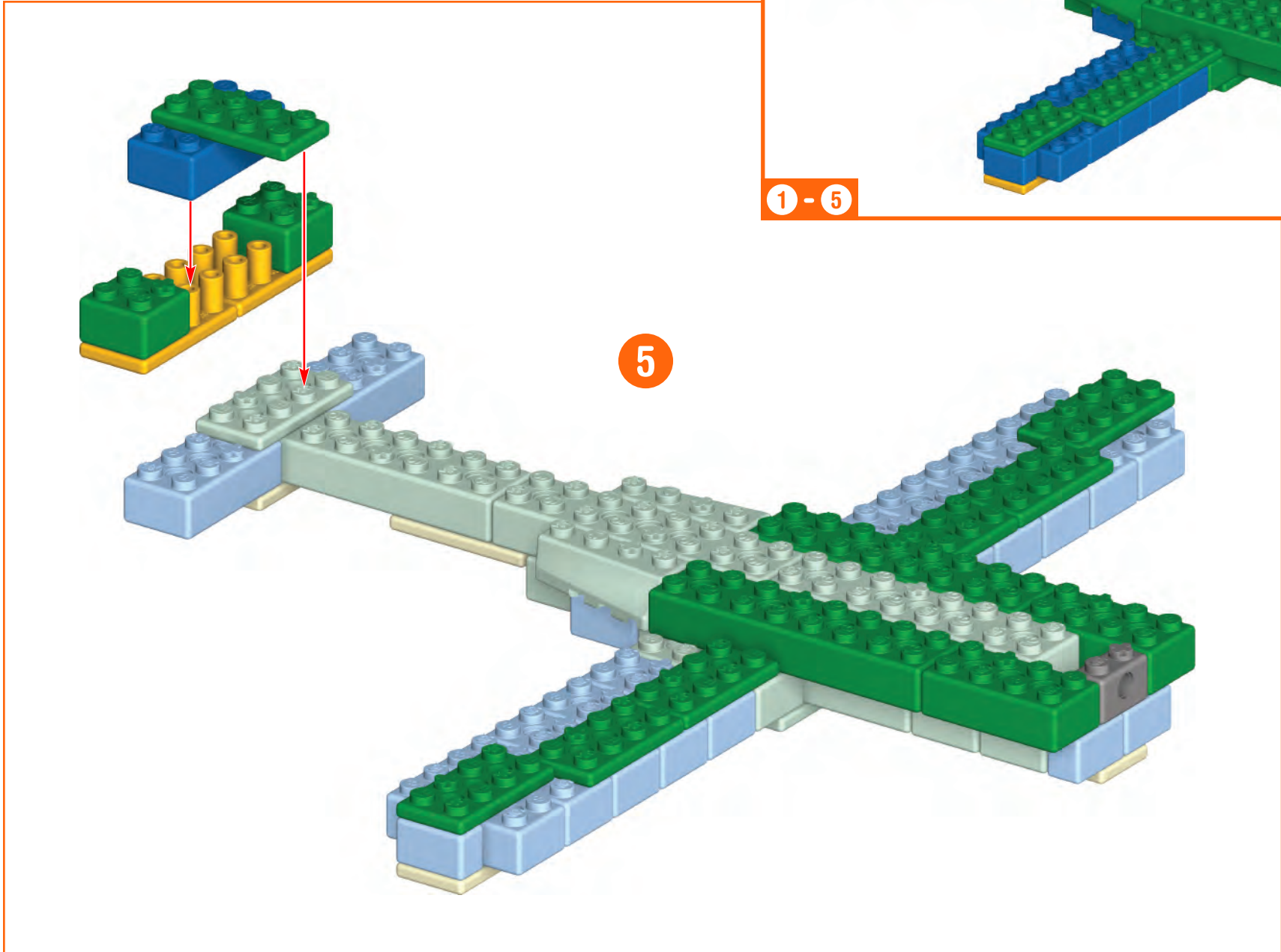
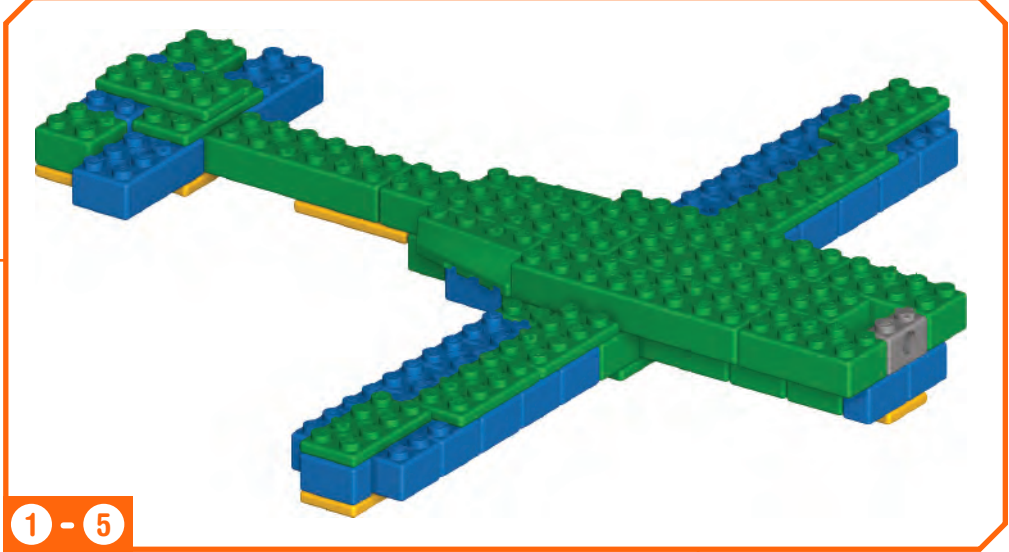

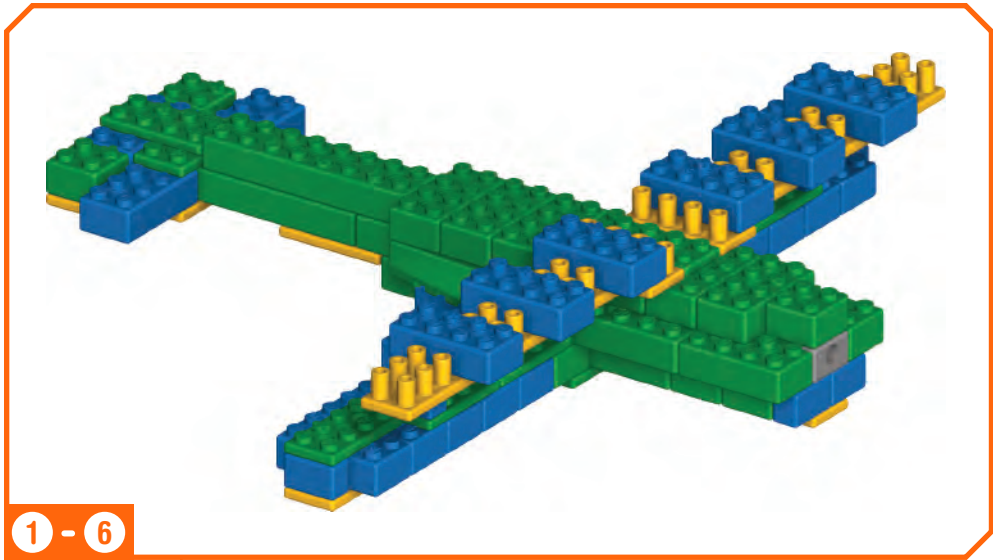

1 - 6

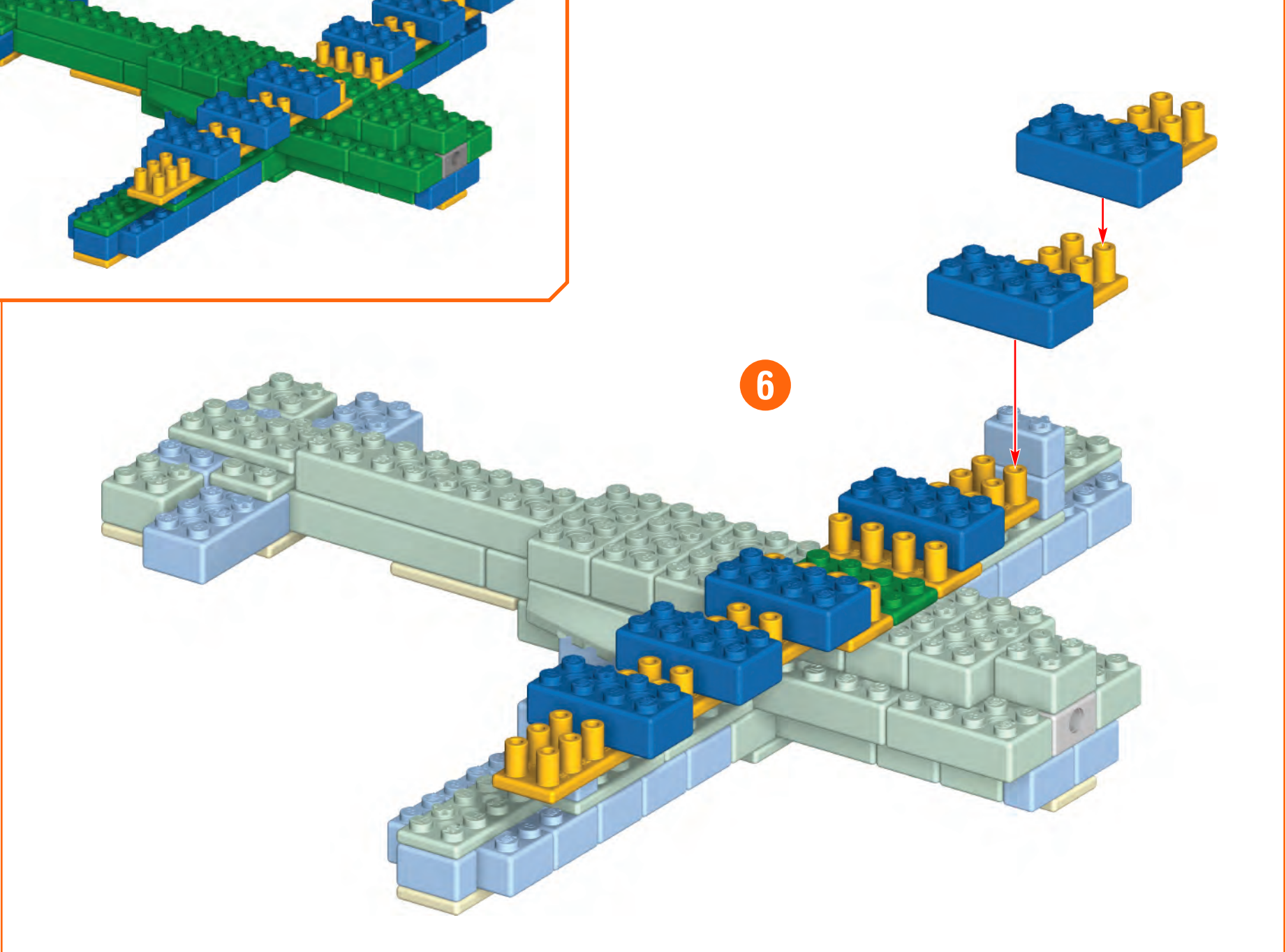

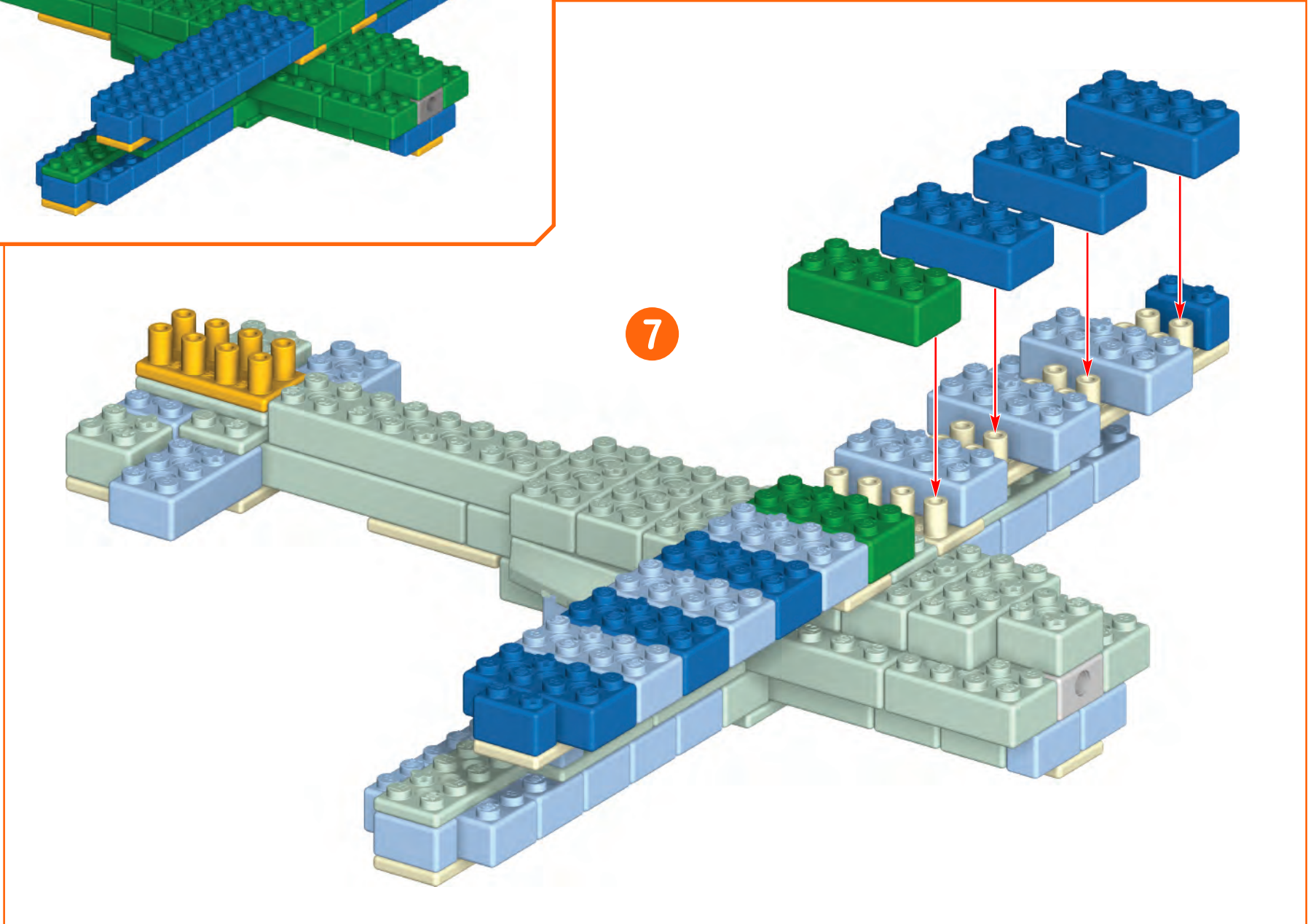
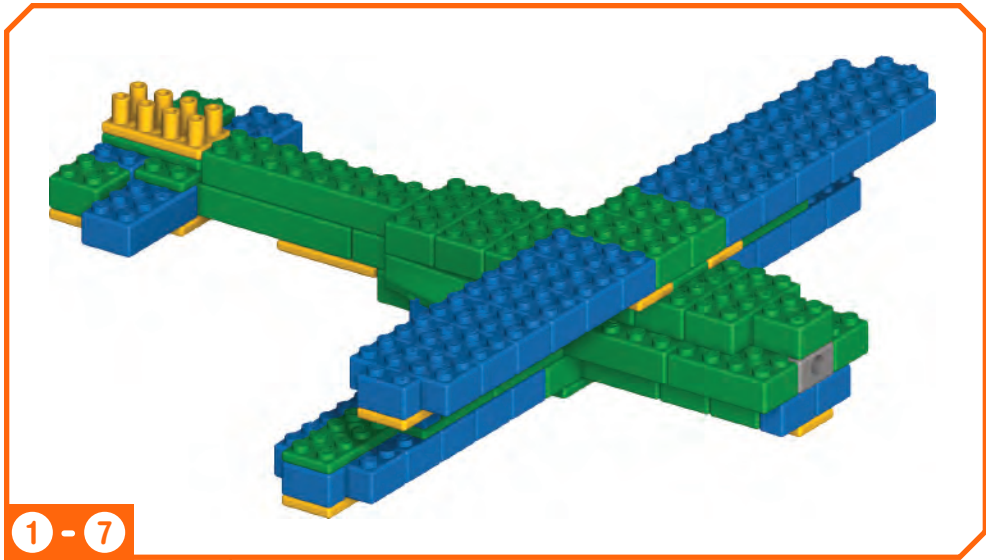

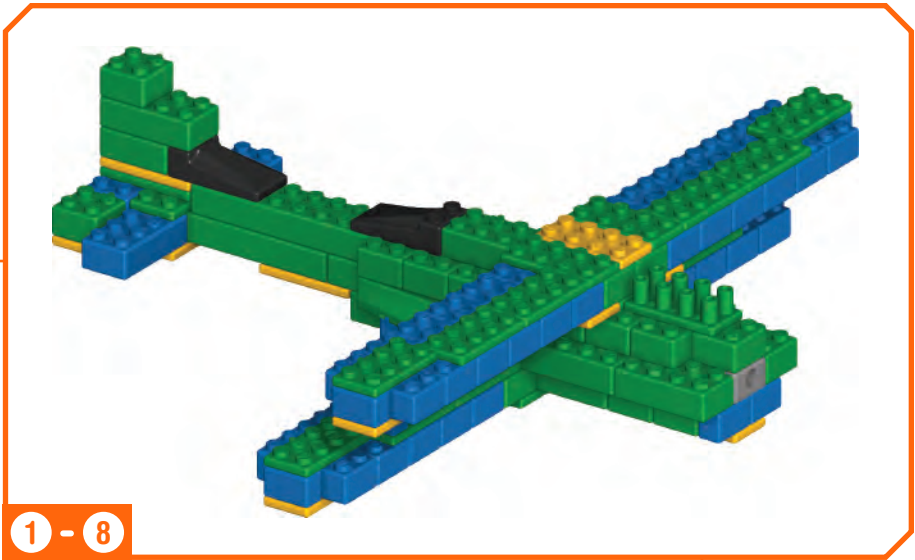

8

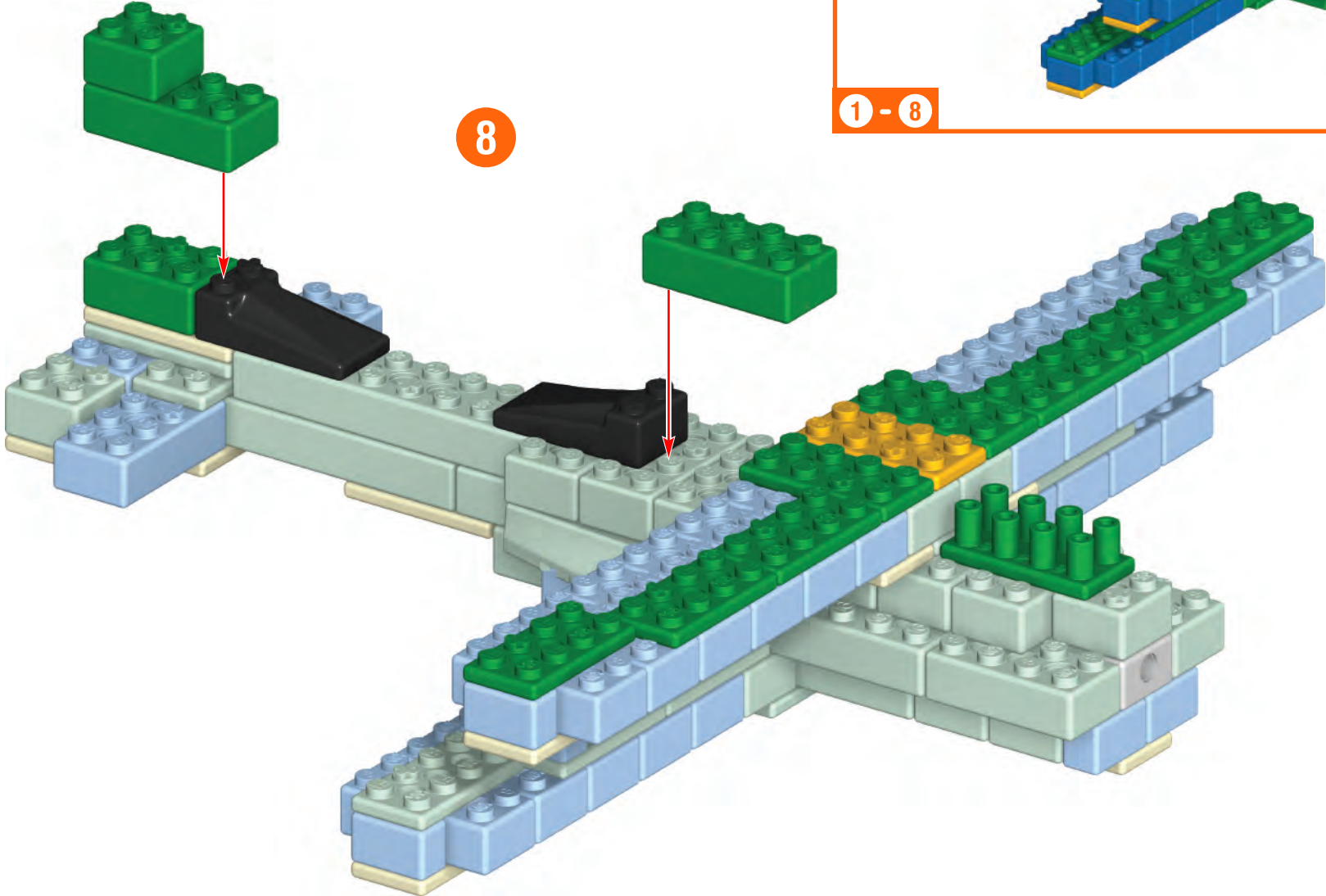

9

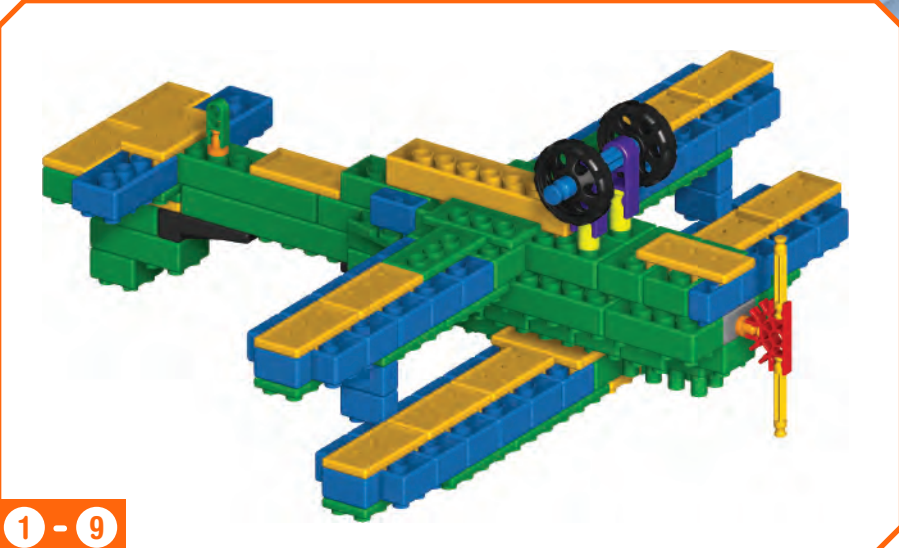
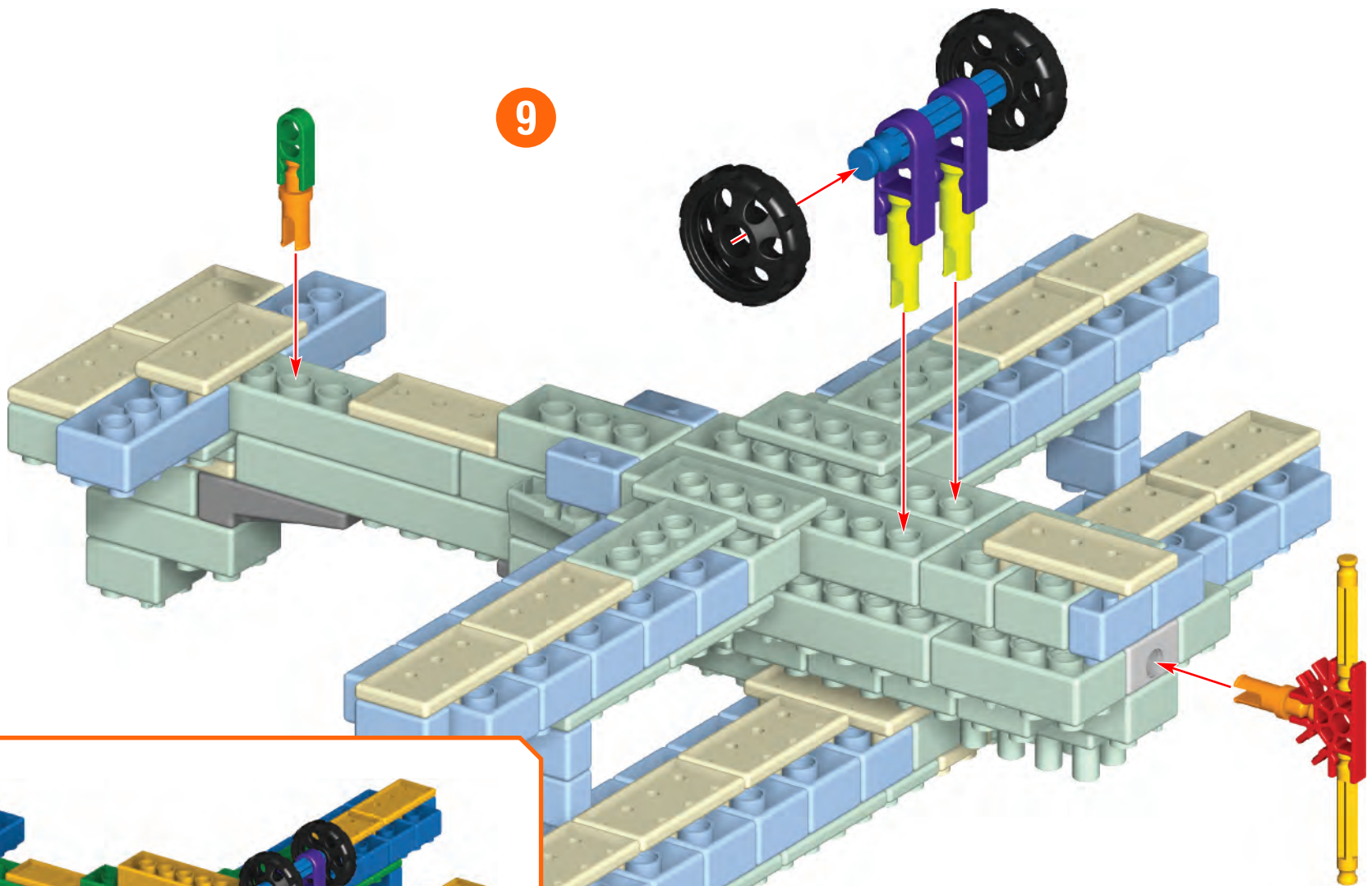

Turn your model upside down again and add the wheels.

1 - 9

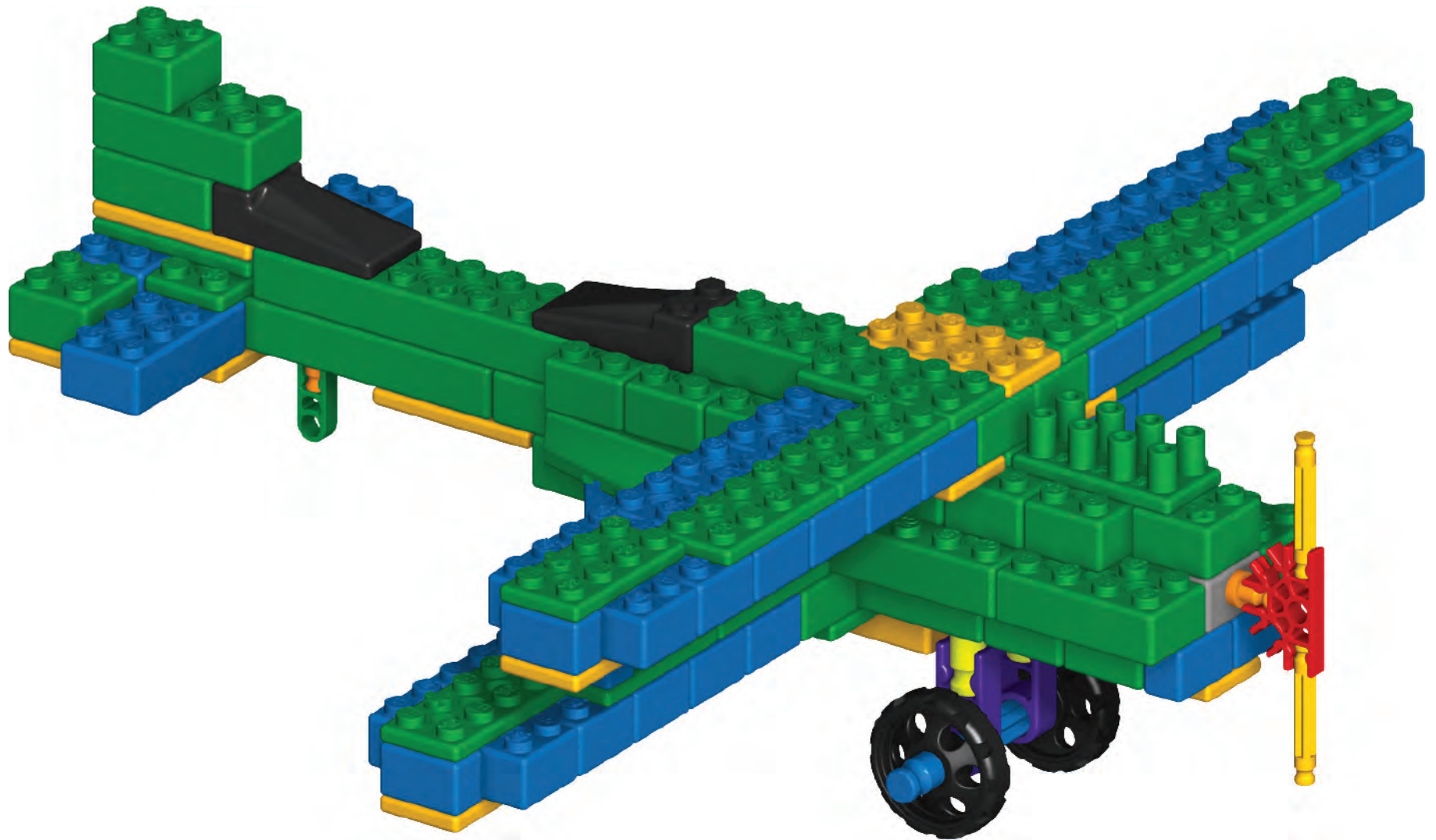

1 - 9

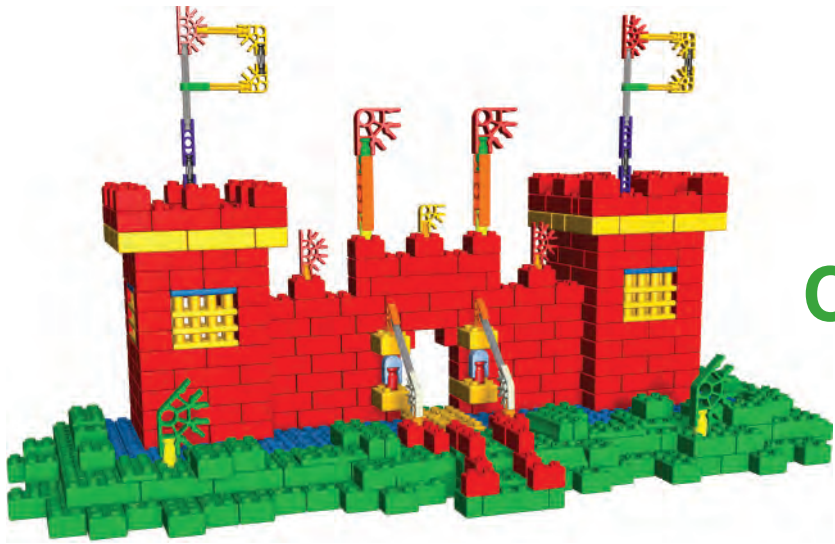

Castle

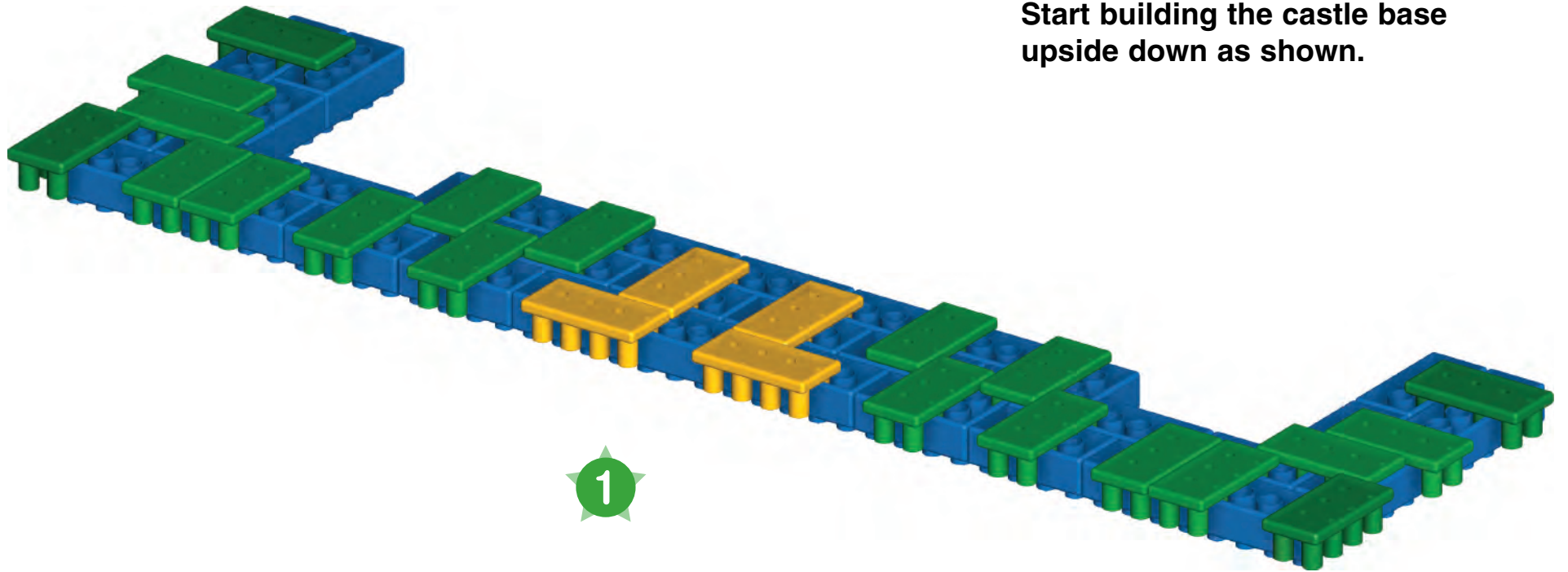

Start building the castle base upside down as shown.

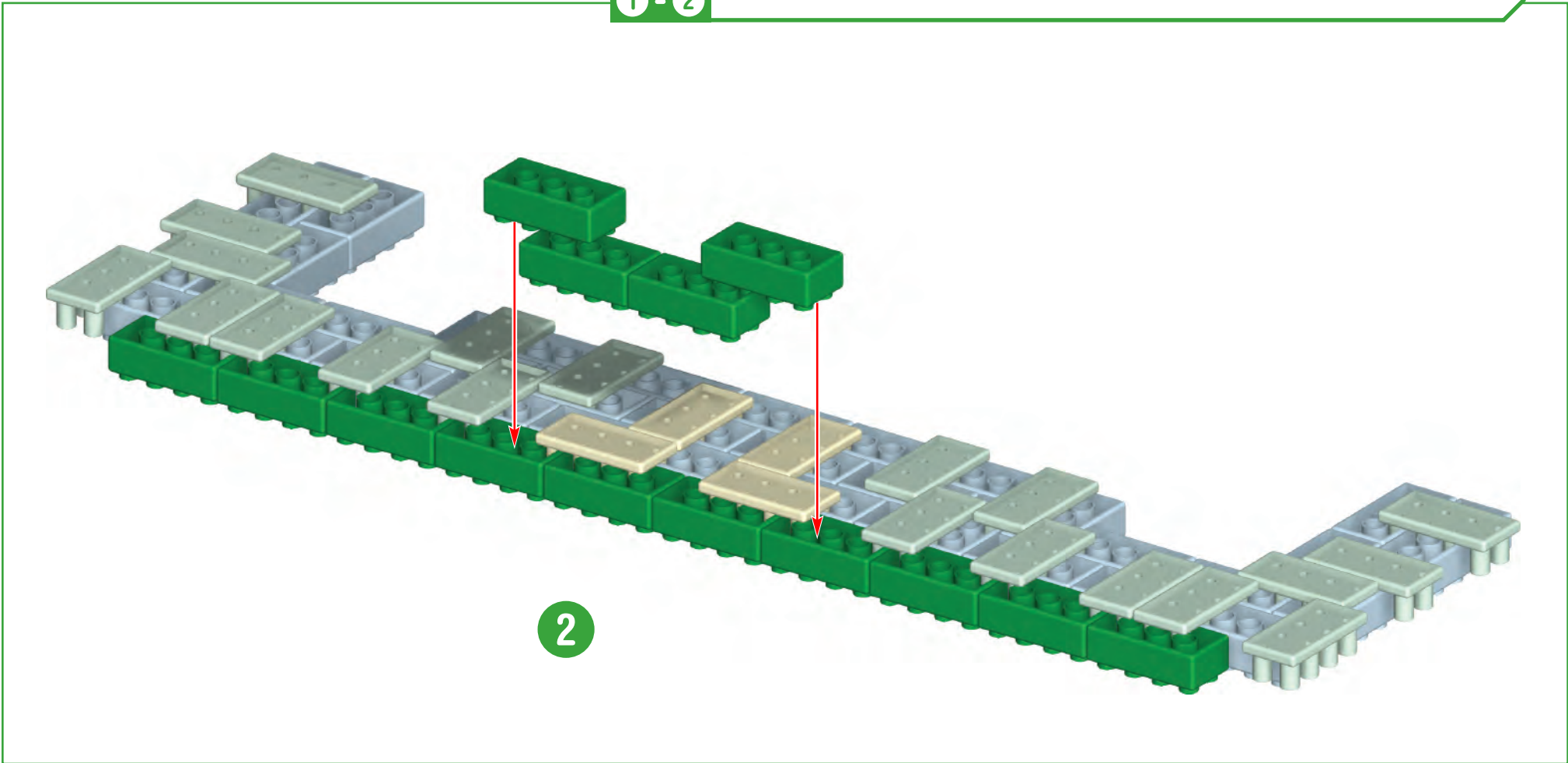
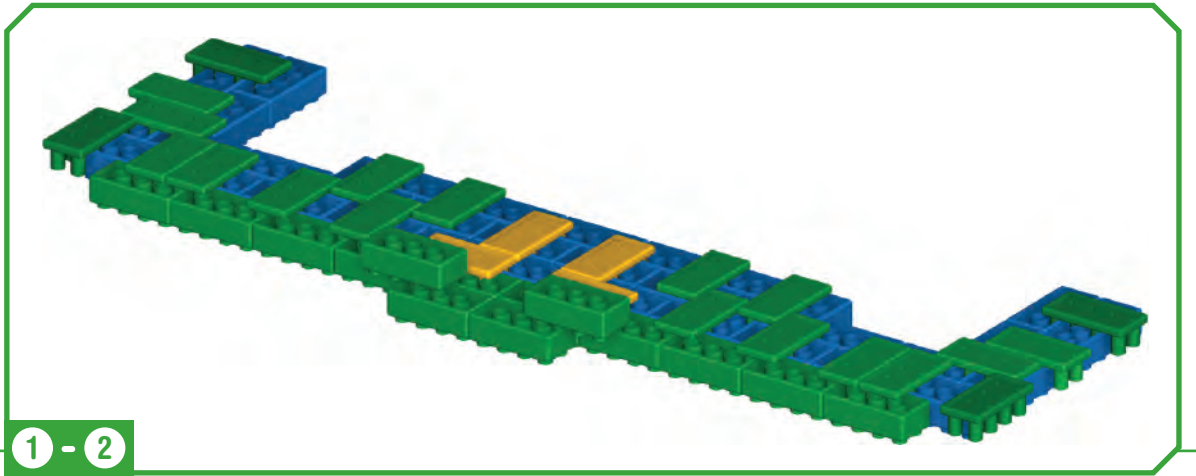

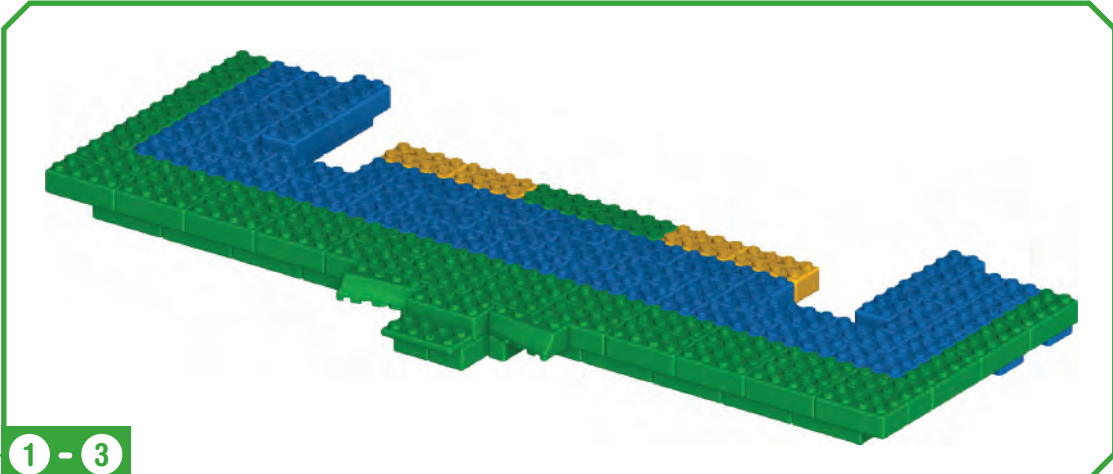

1 - 3

Now turn the castle base right side up.

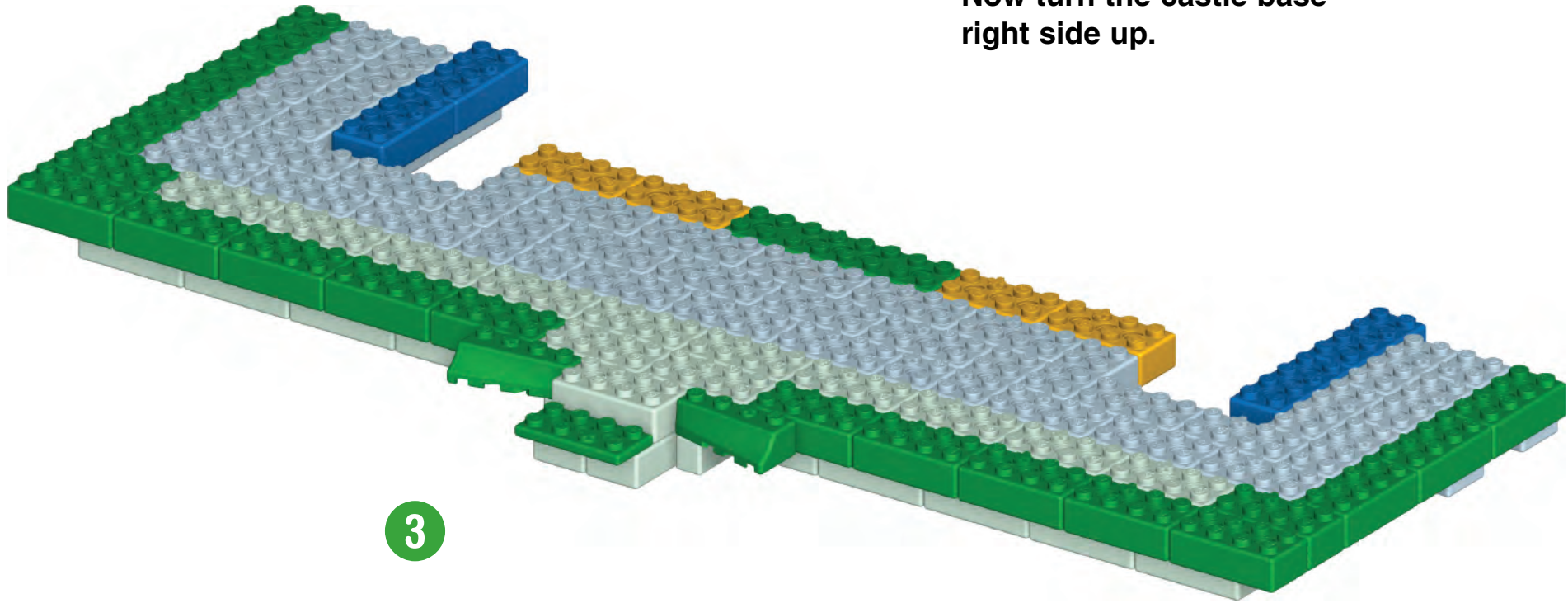

3

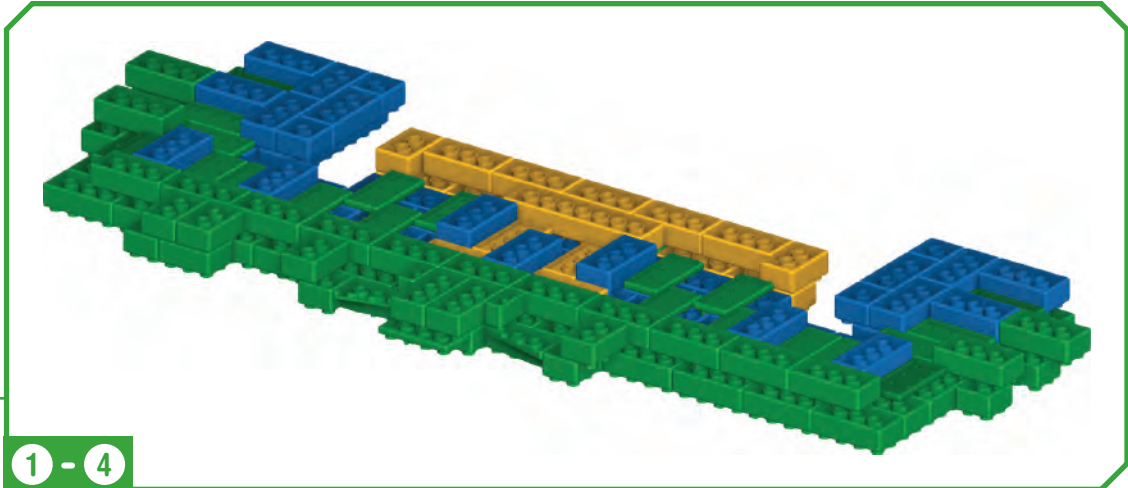

1 - 4

Now turn the castle base upside down.

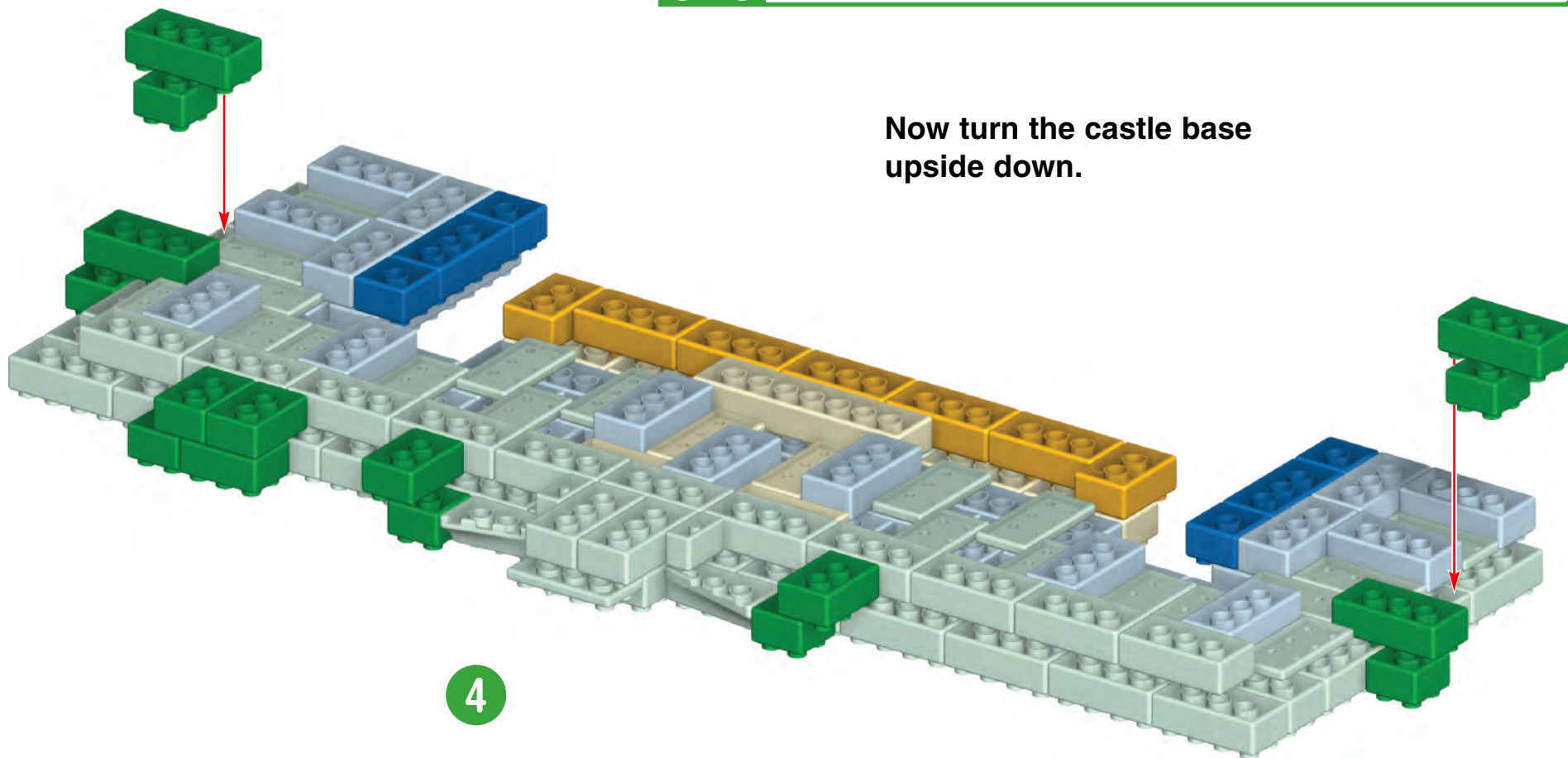

4

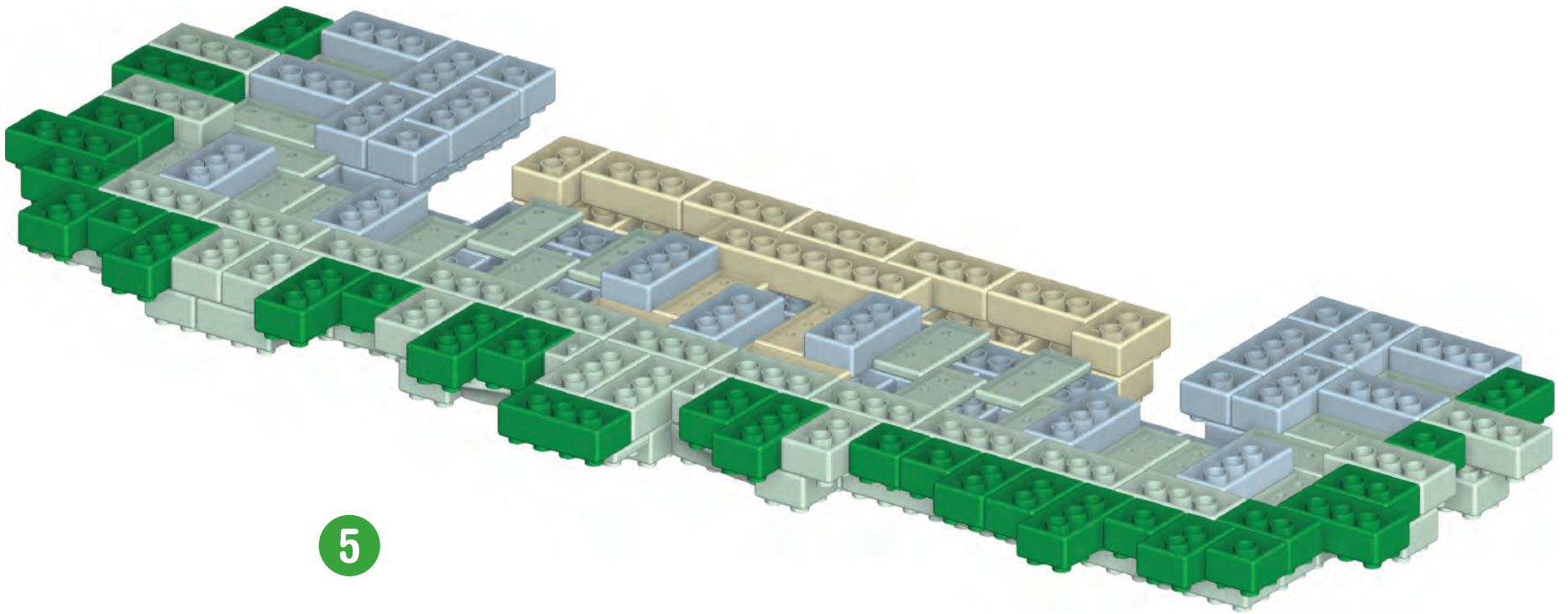

5

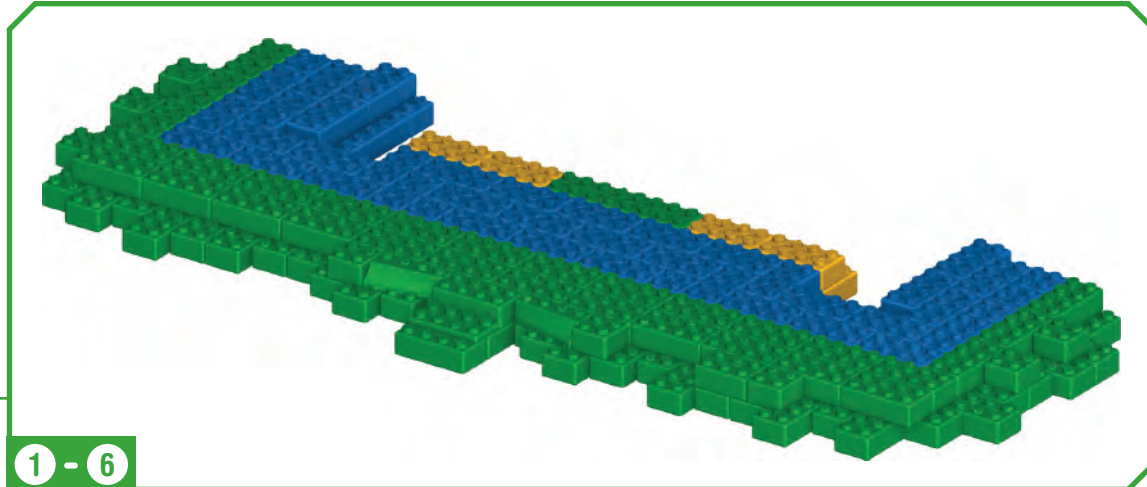

1 - 6

Now turn the castle base
right side up again.

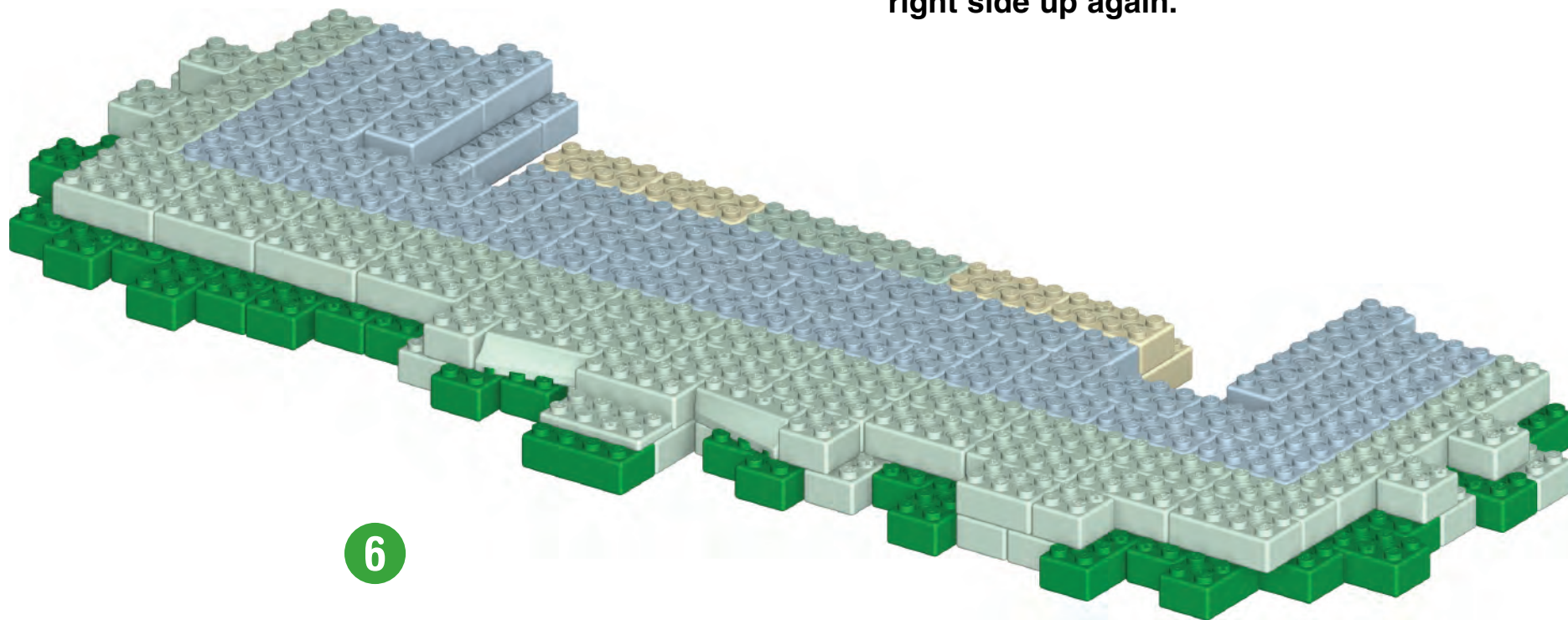

6

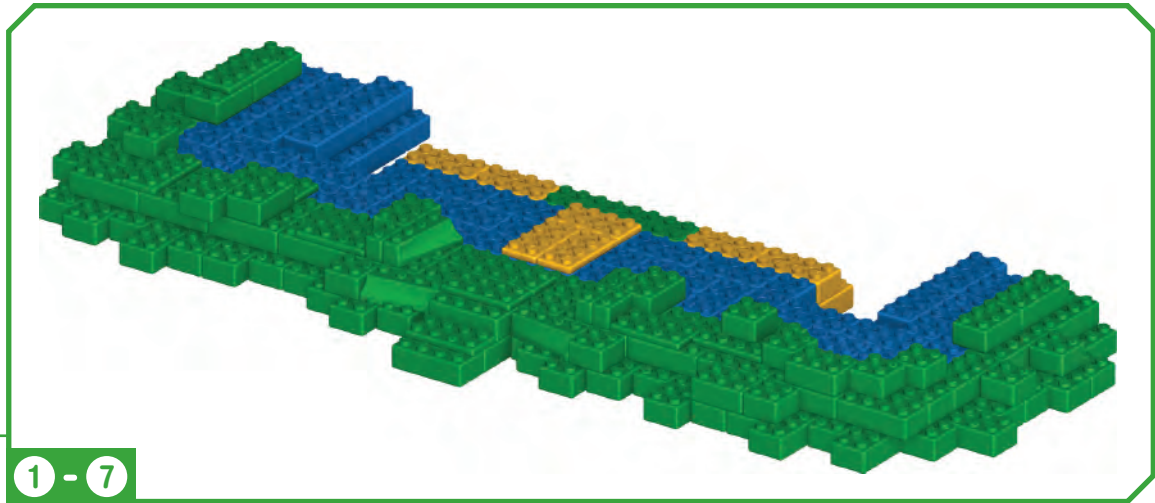

1 - 7

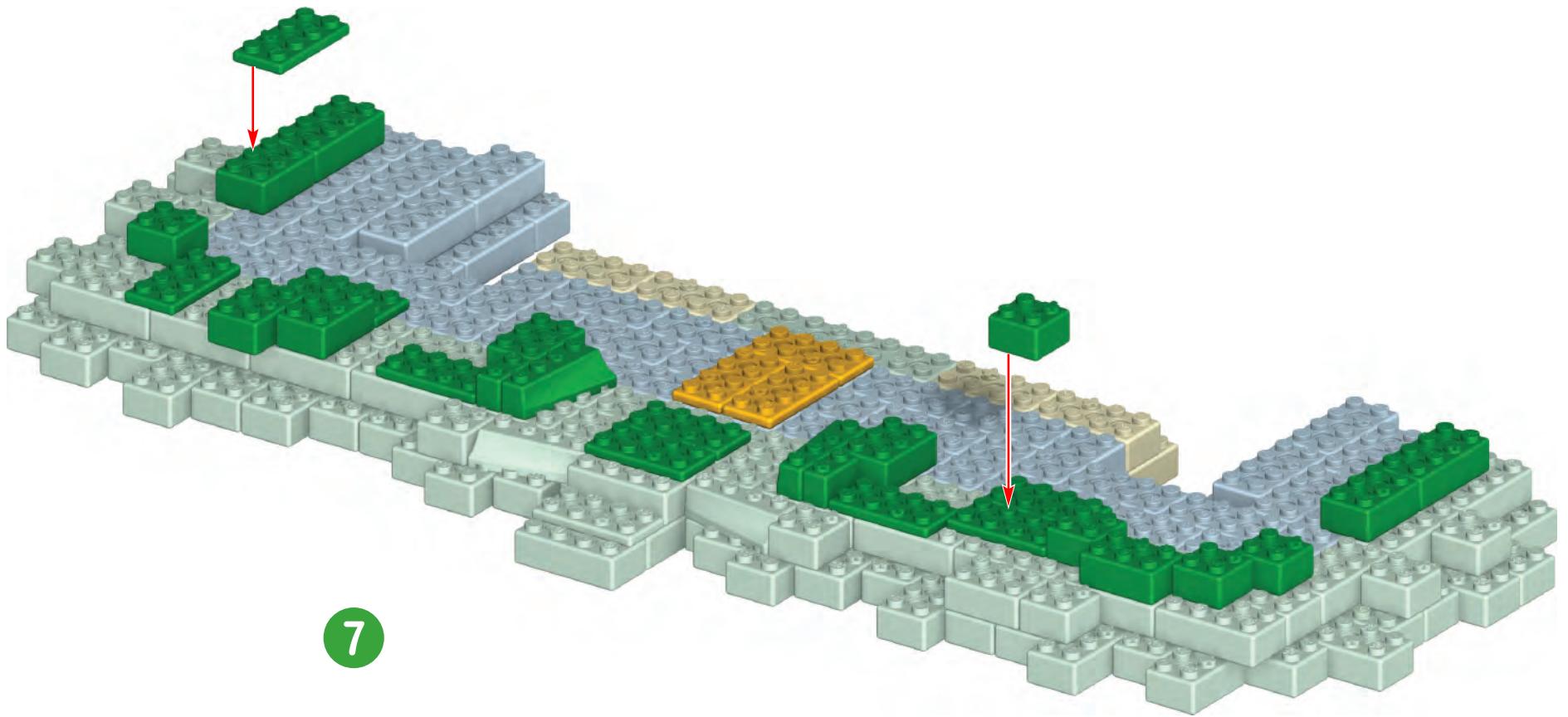

7

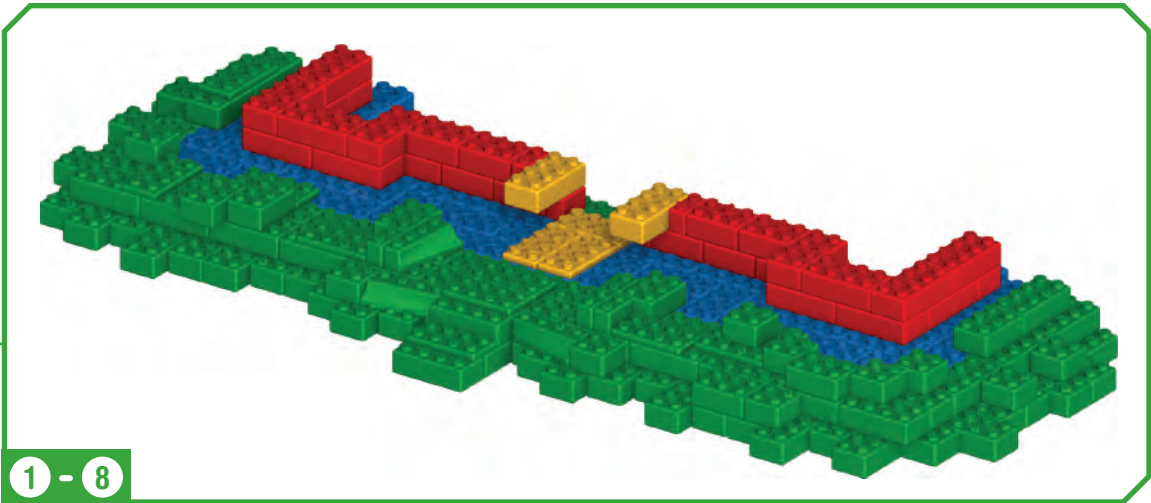

1 - 8

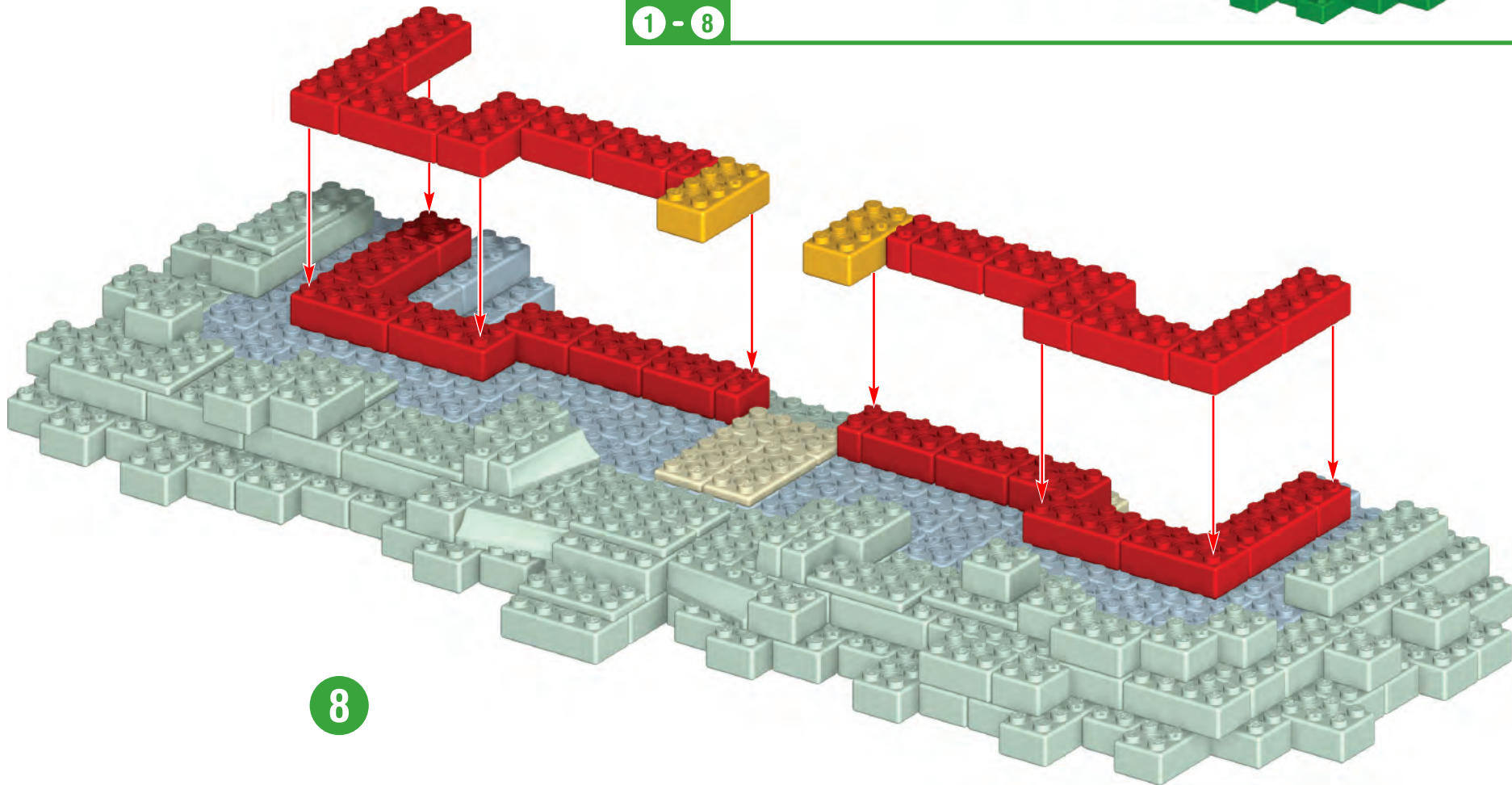

8

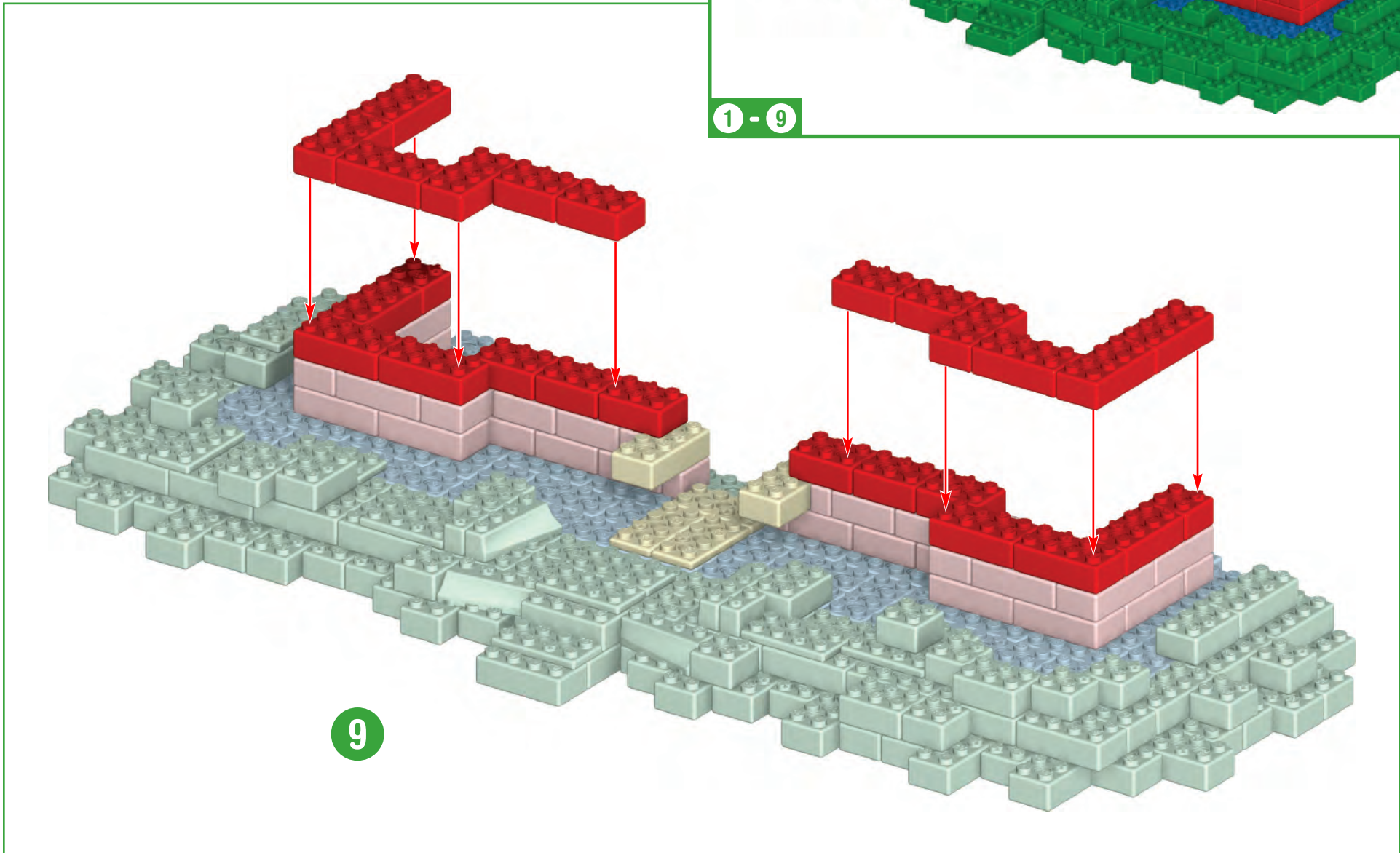
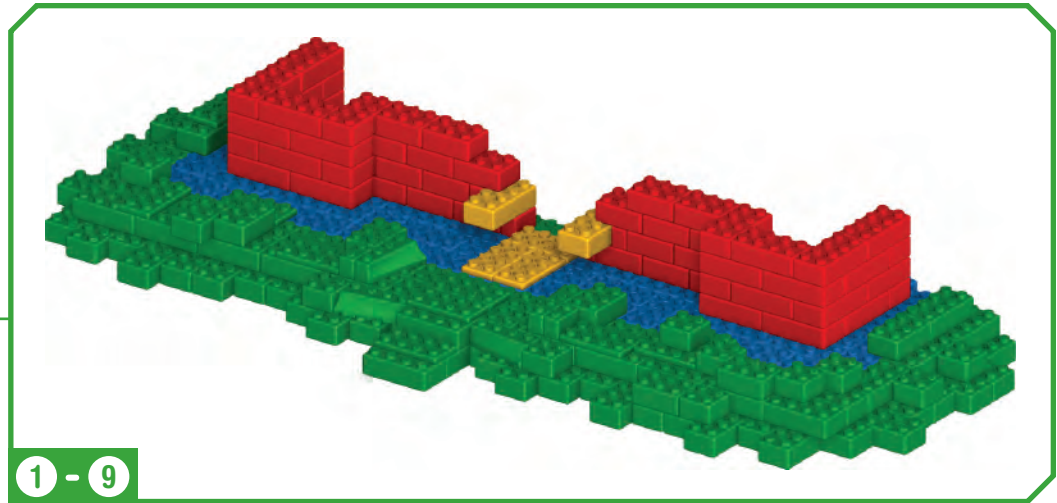

1 - 10

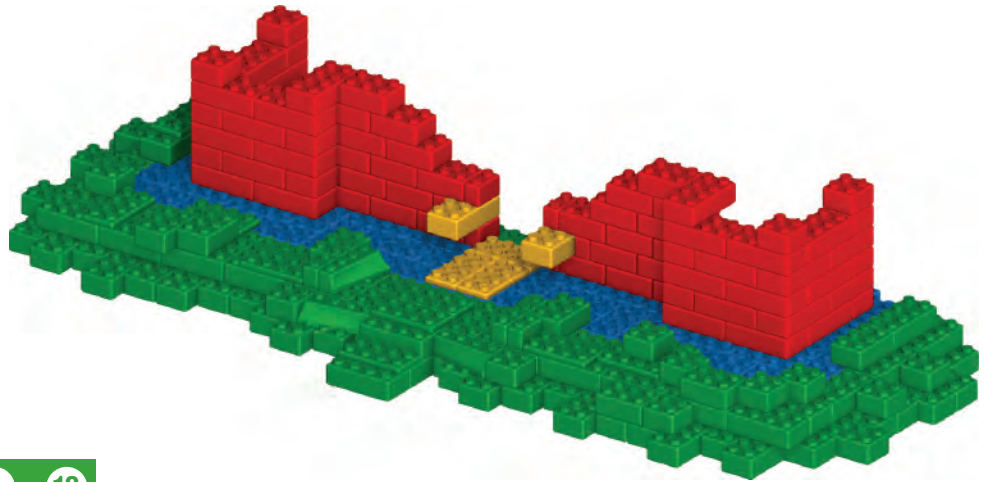

10

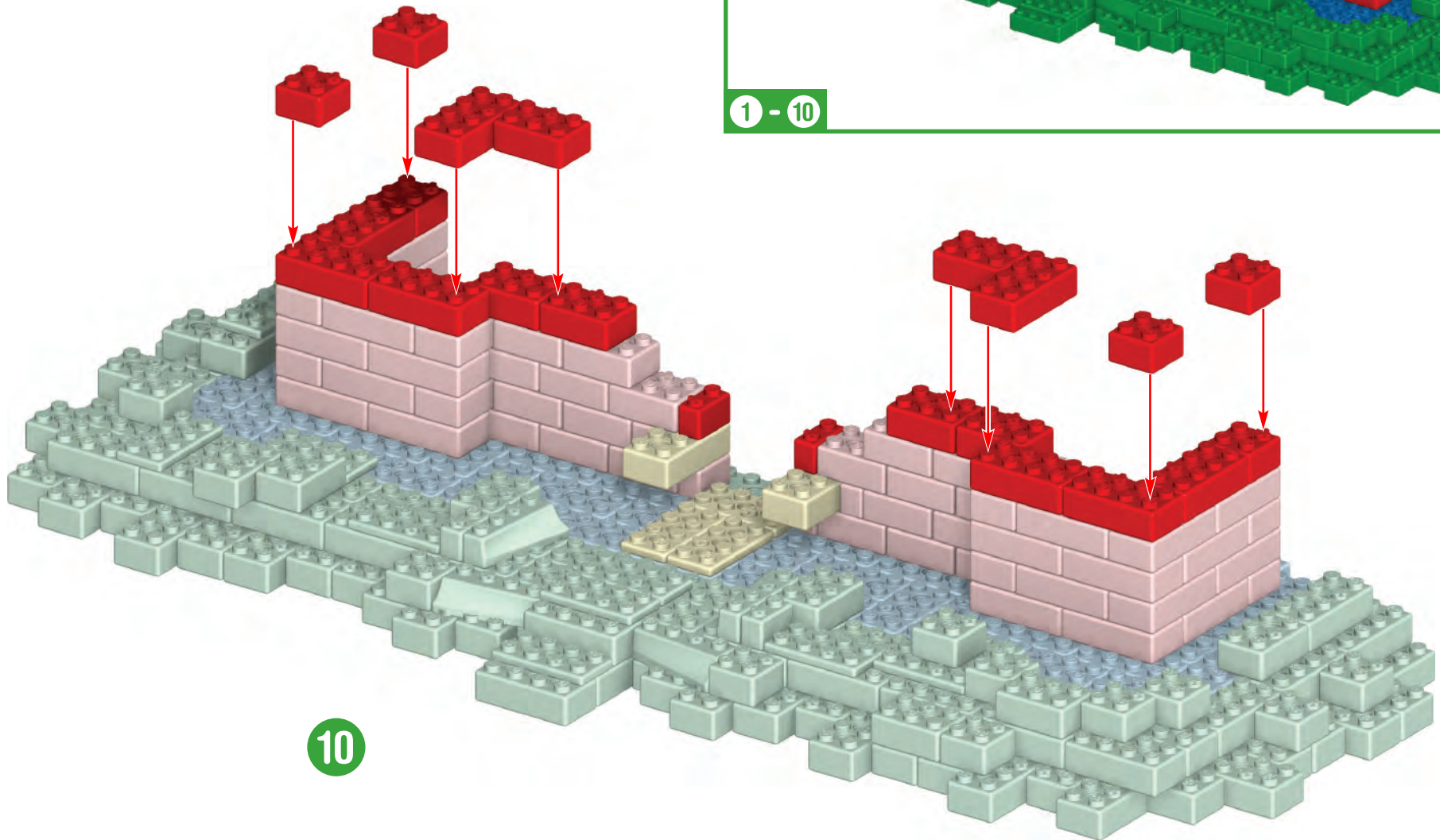

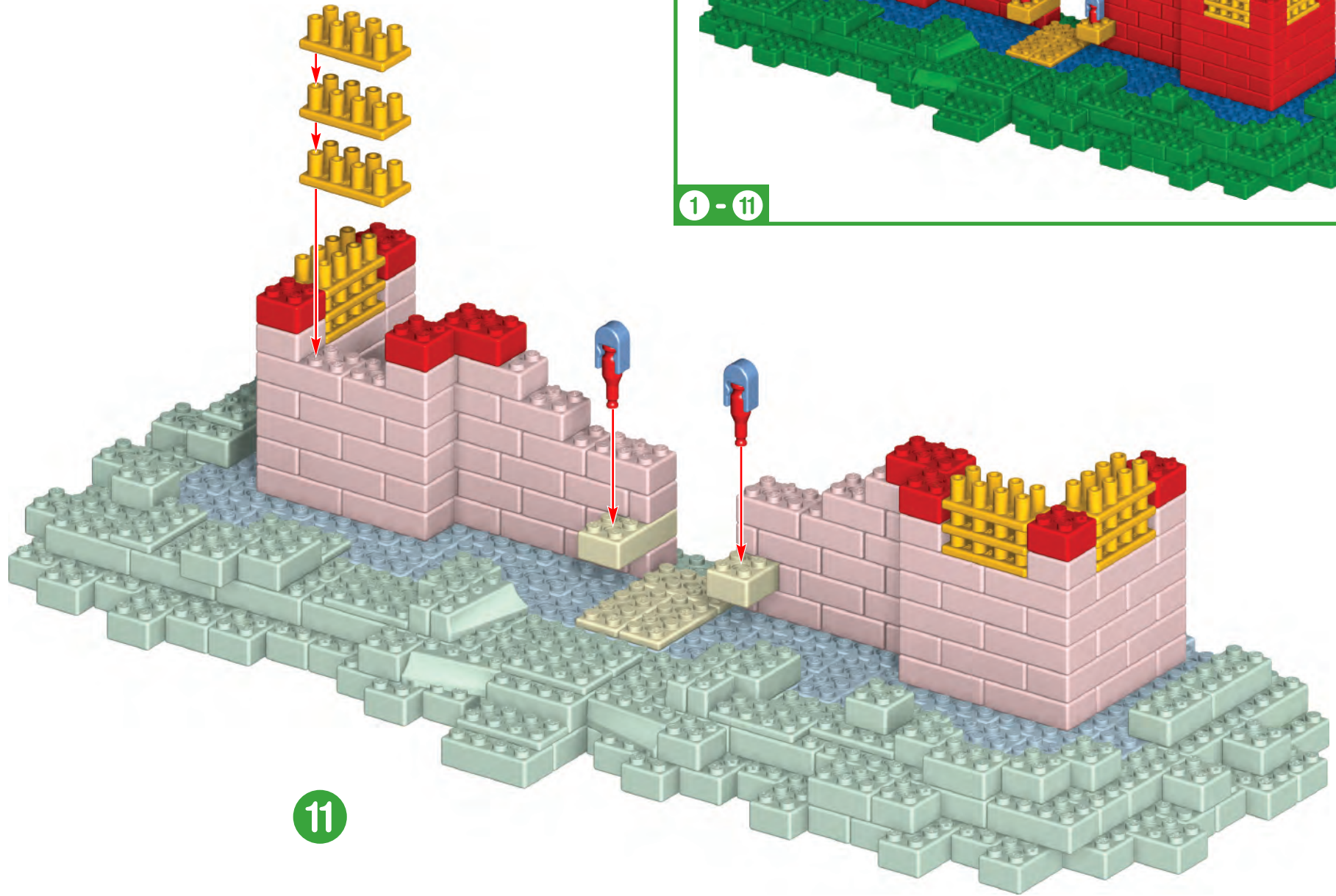
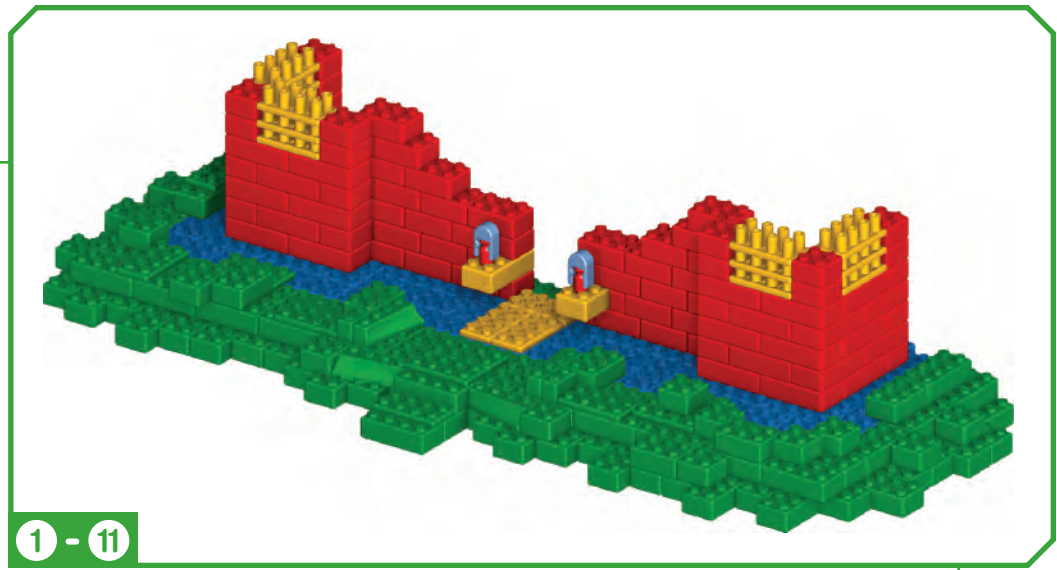

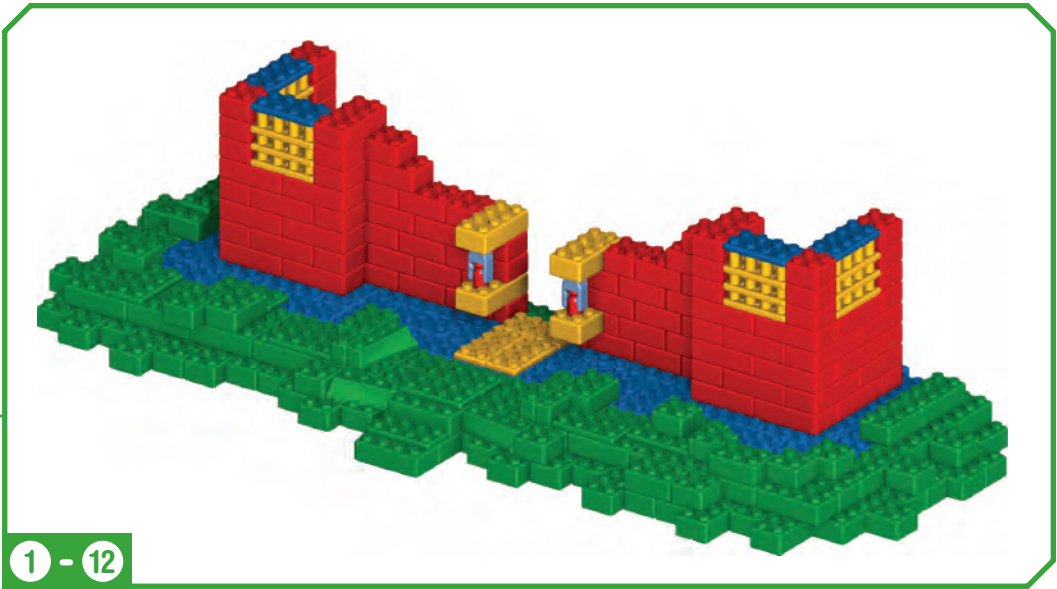

1 - 12

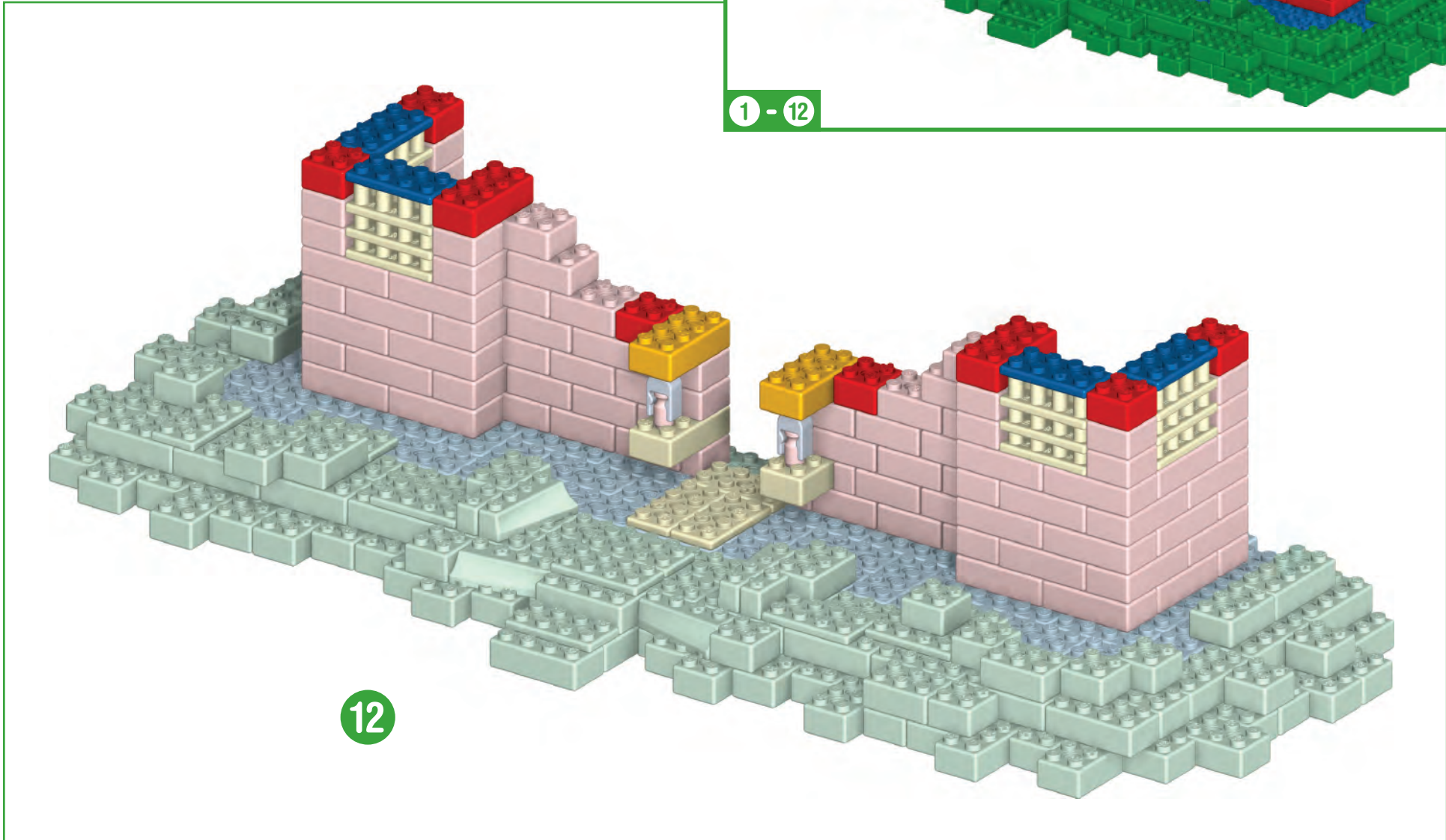

12

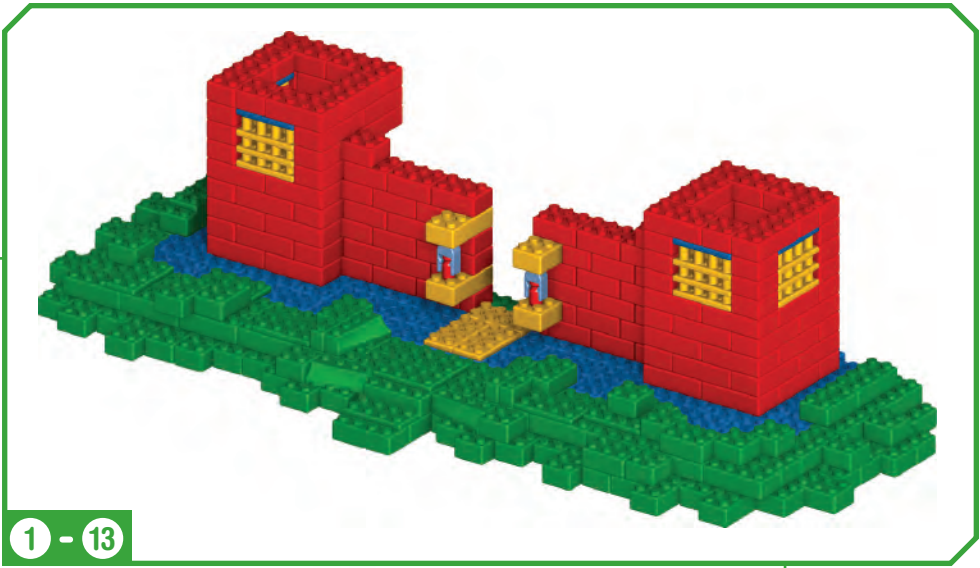
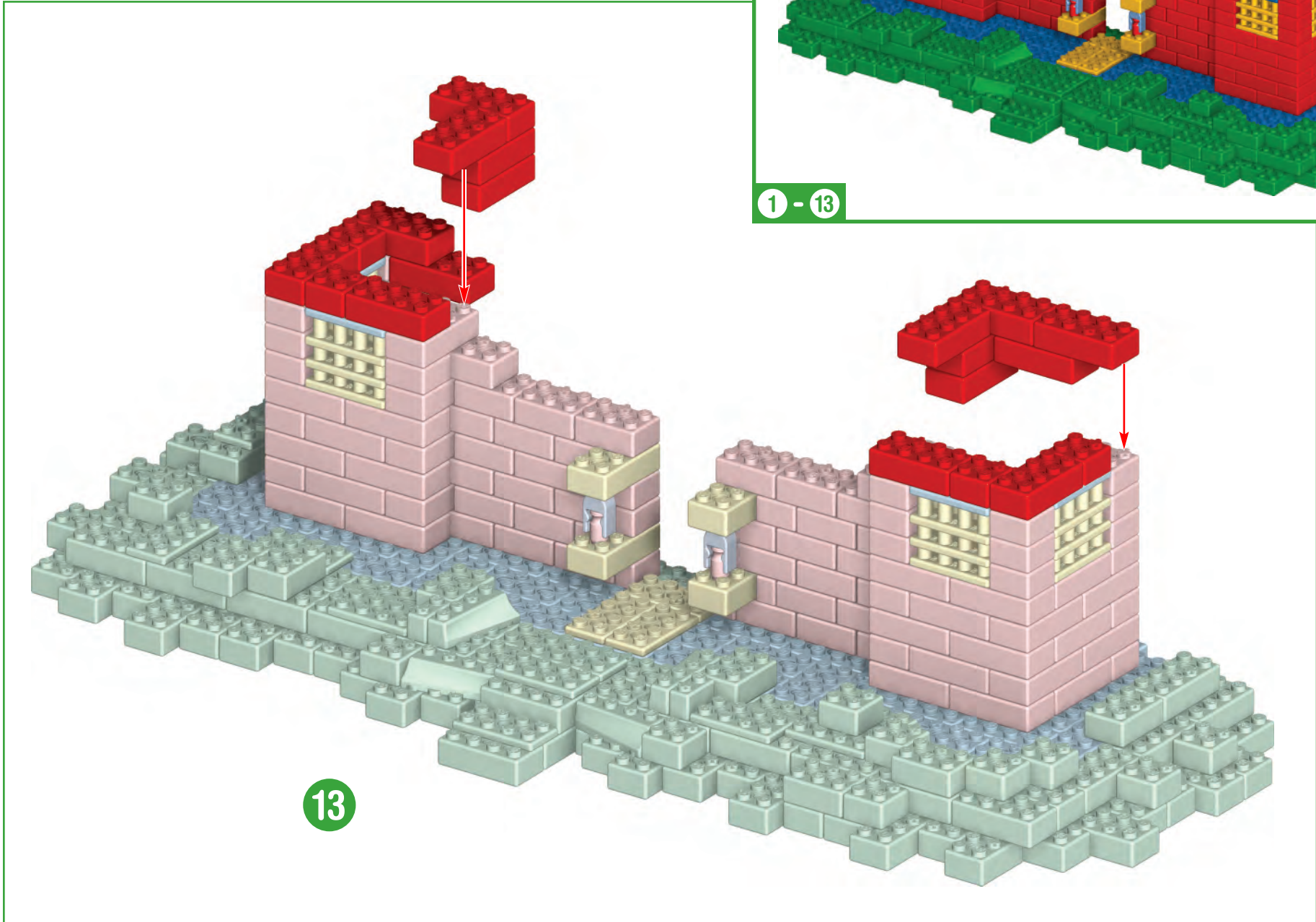

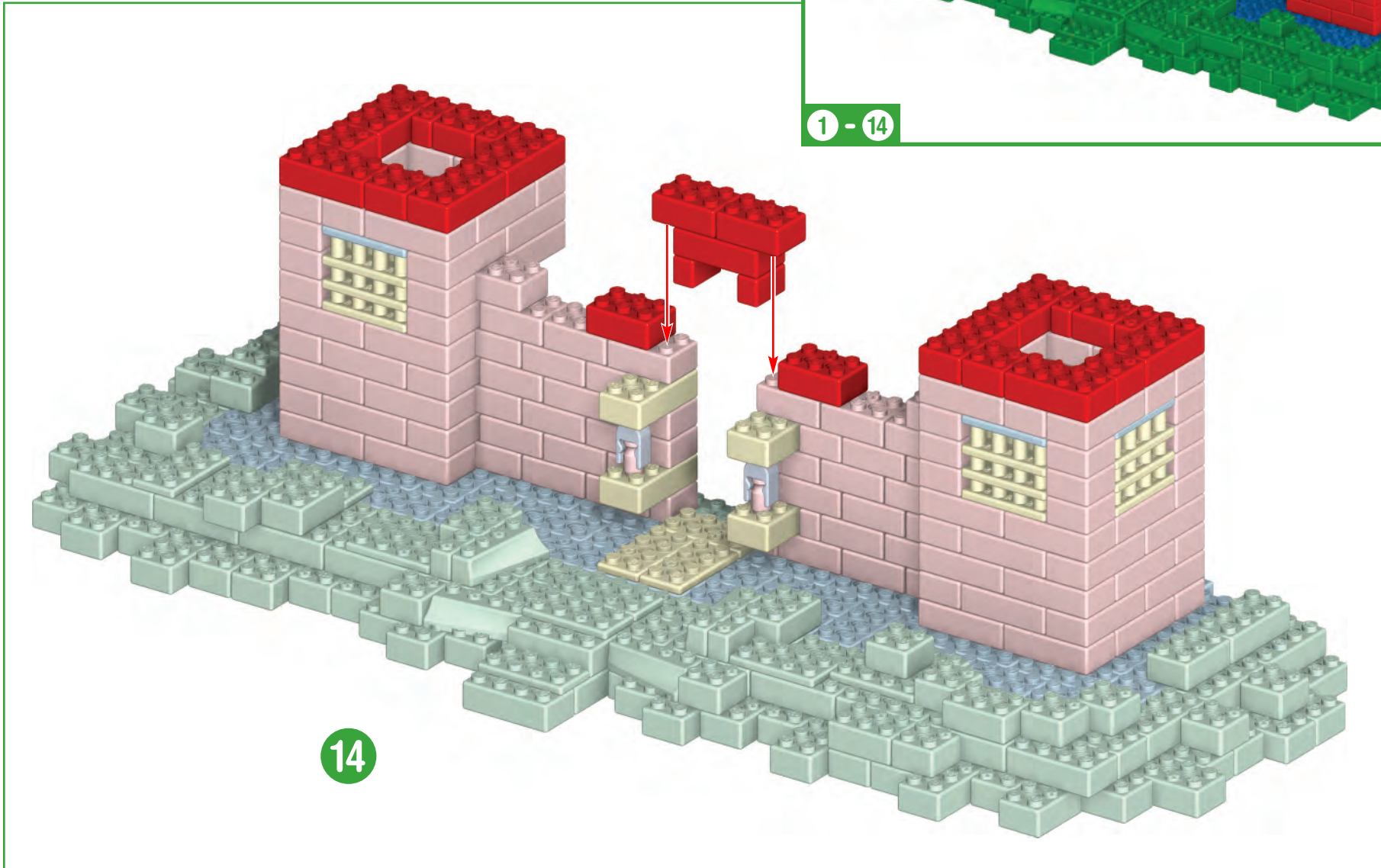
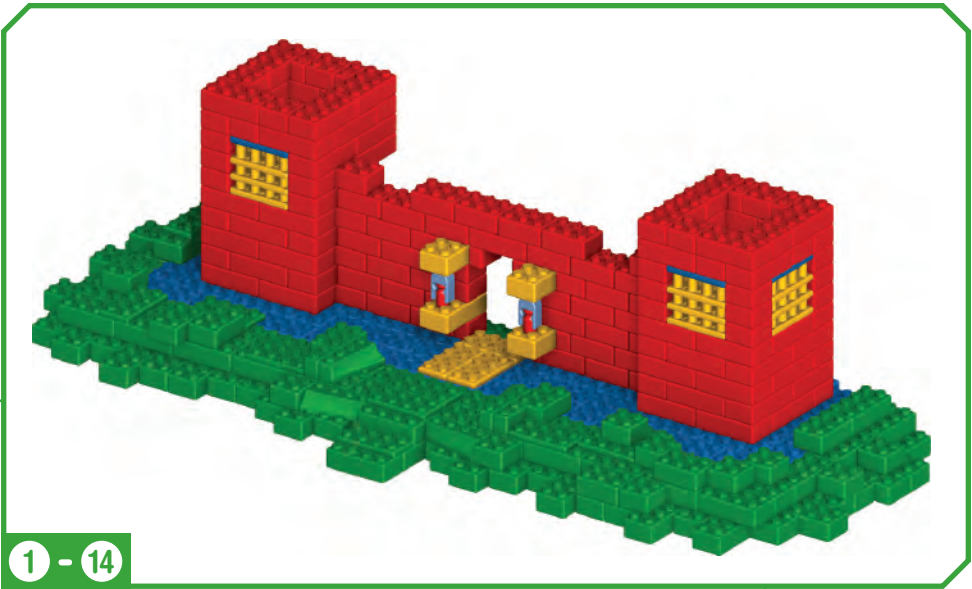

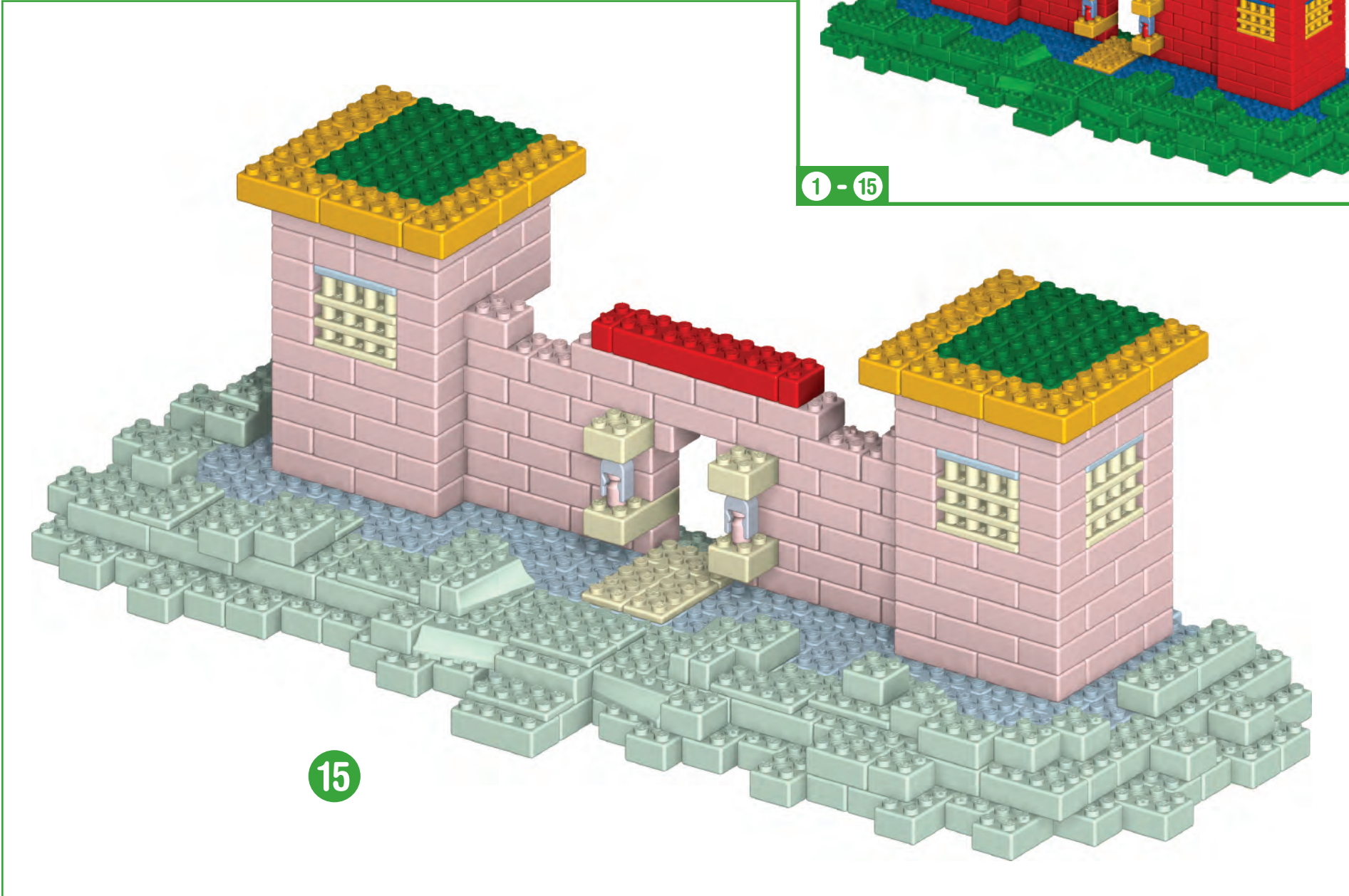
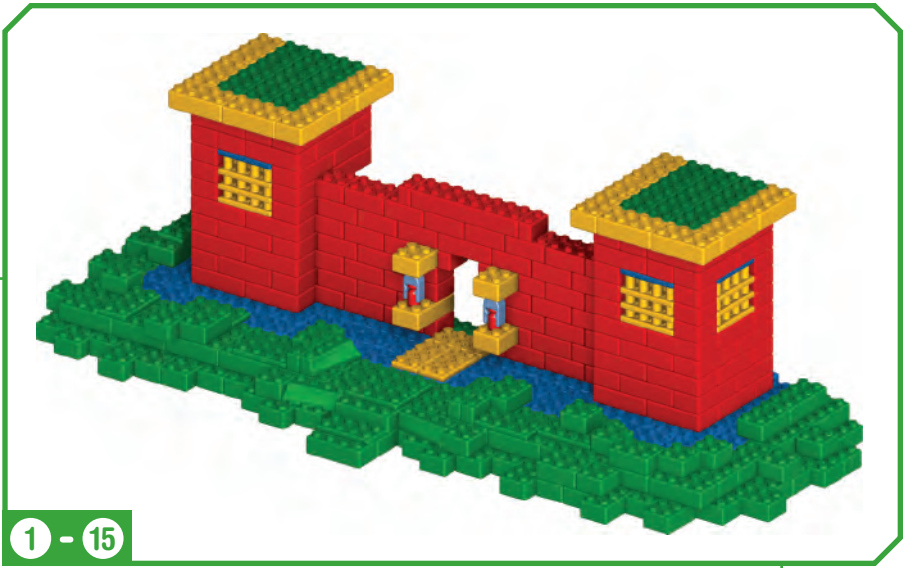

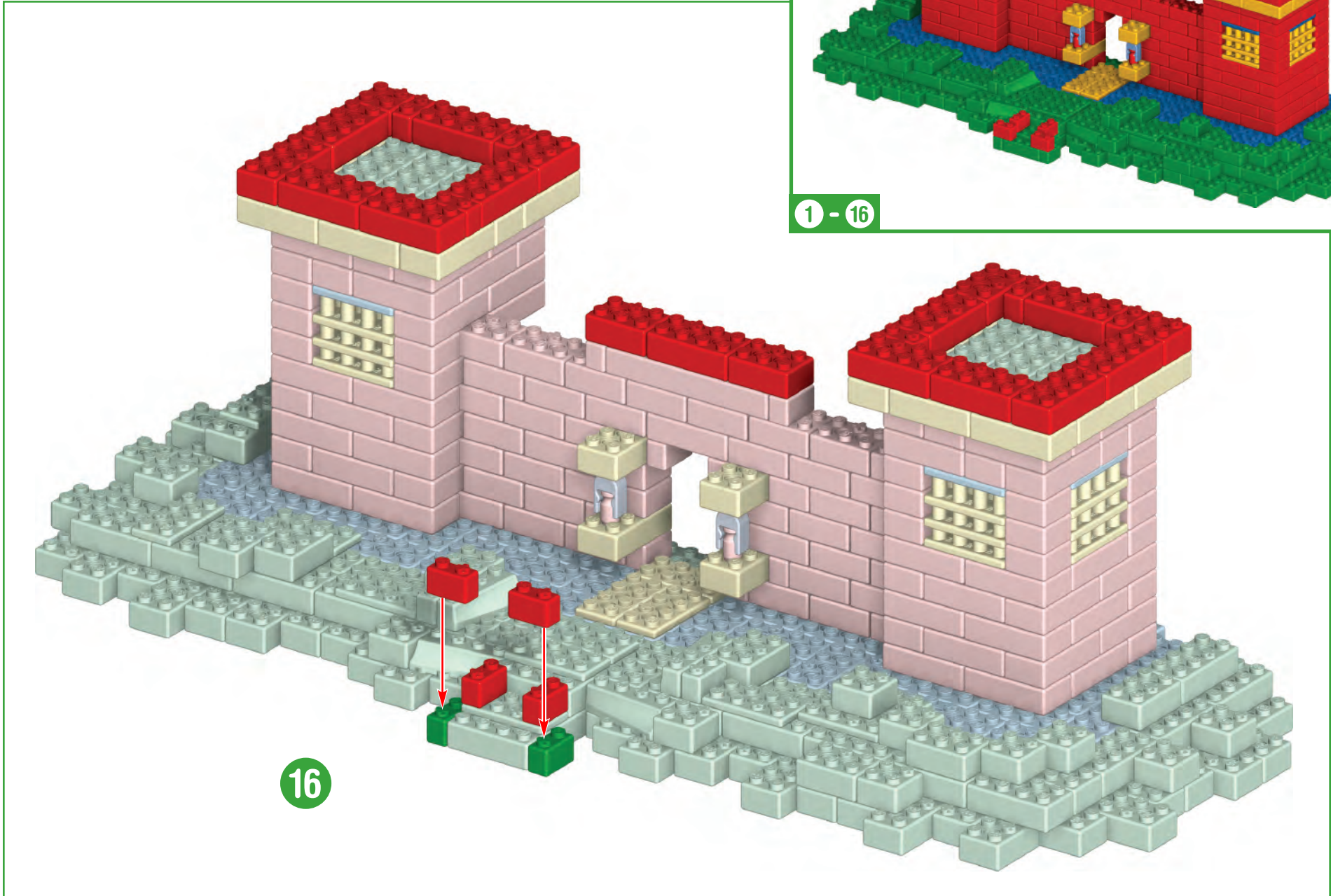

1 - 17

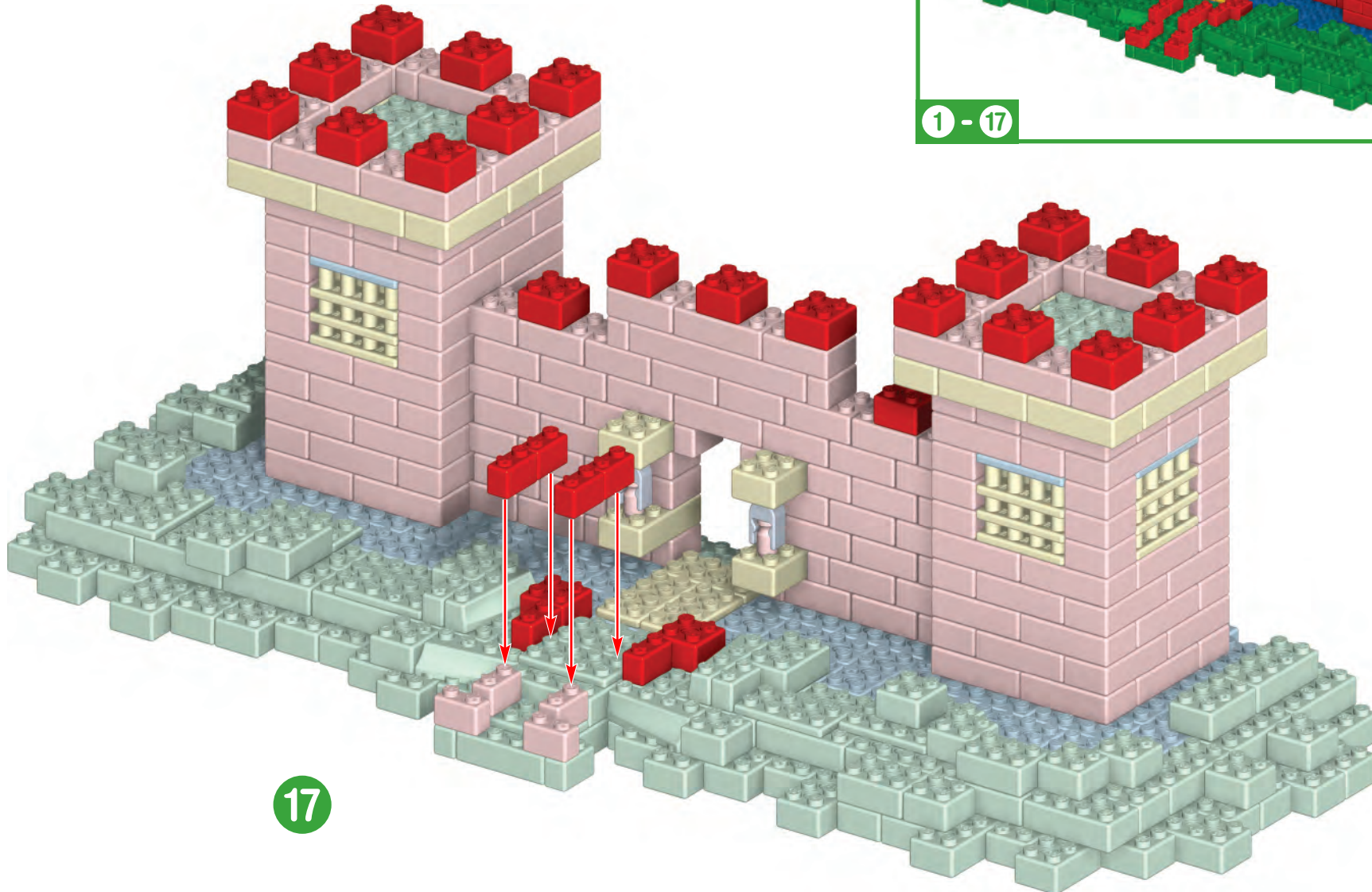

17

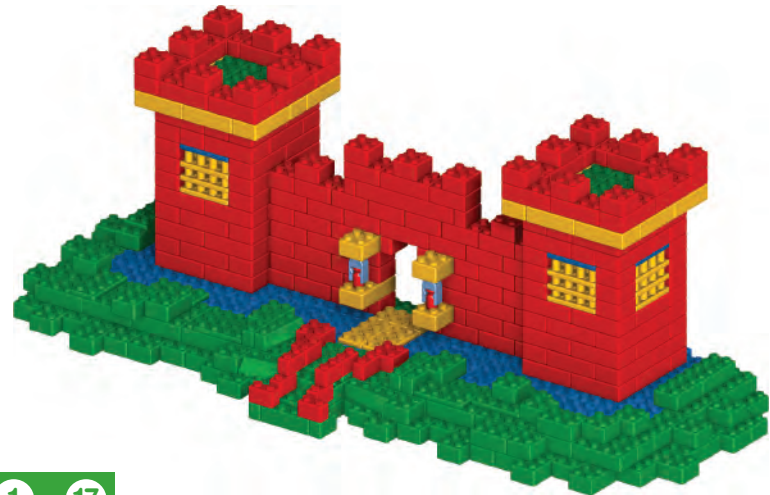



18



1 - 18

Dog House

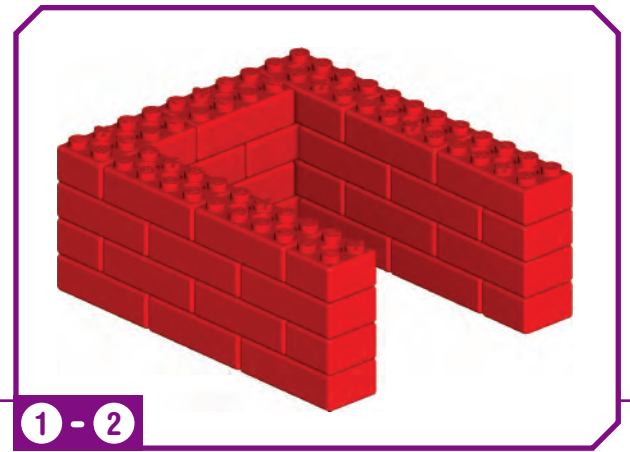
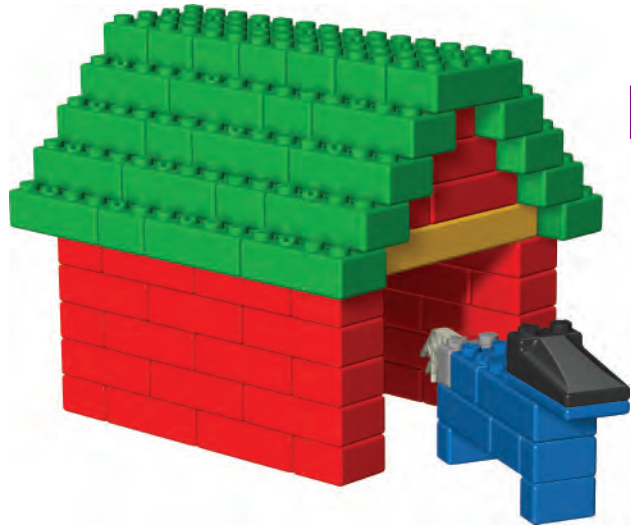

1 - 2

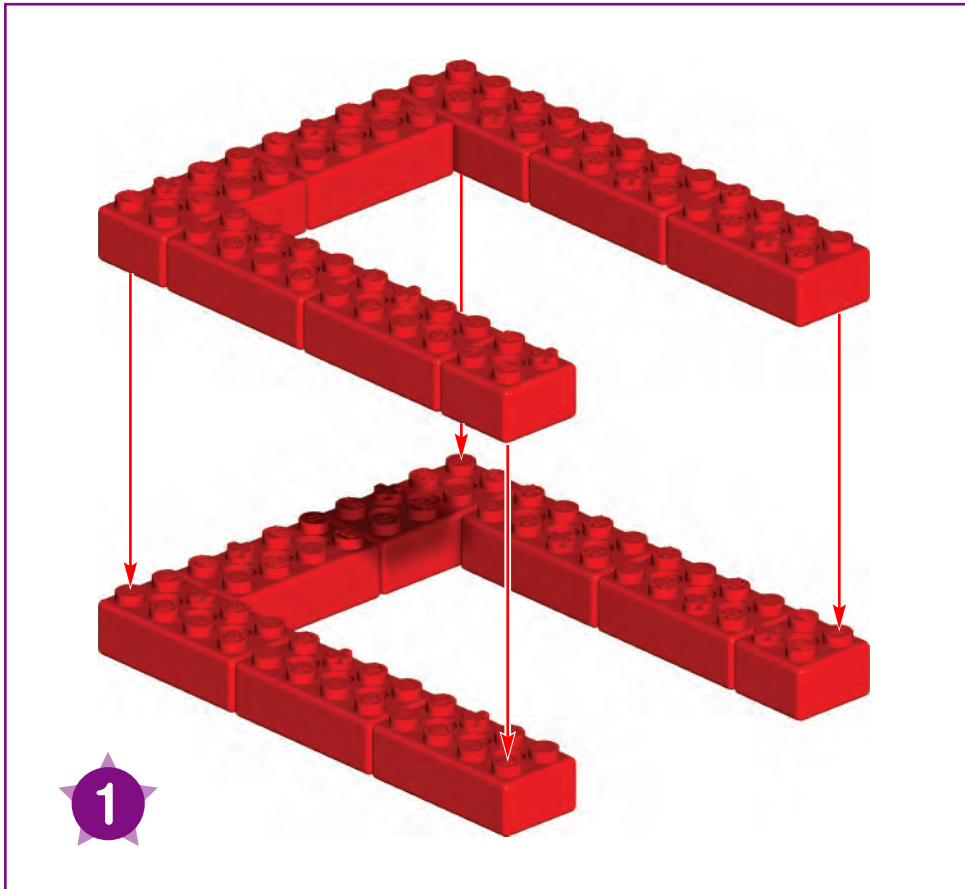

1

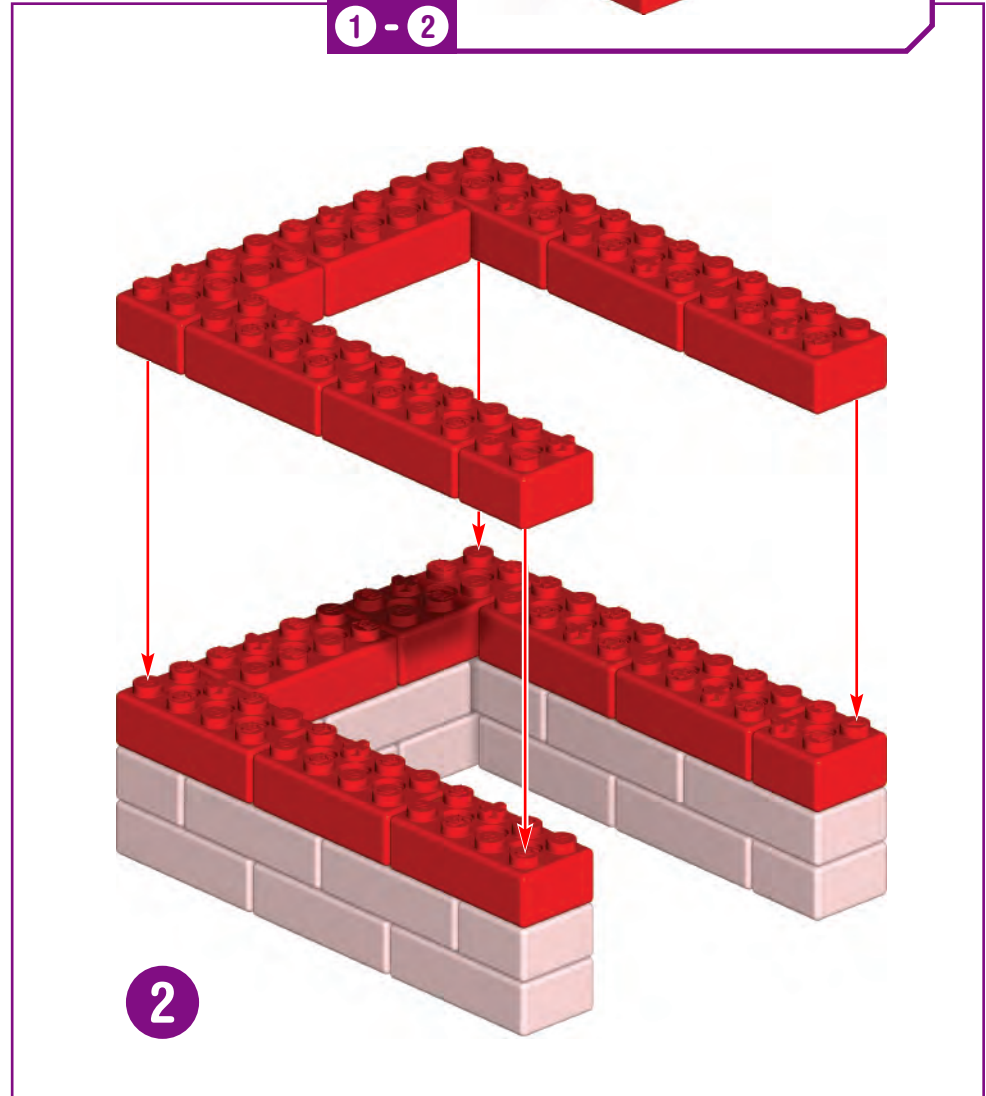

2

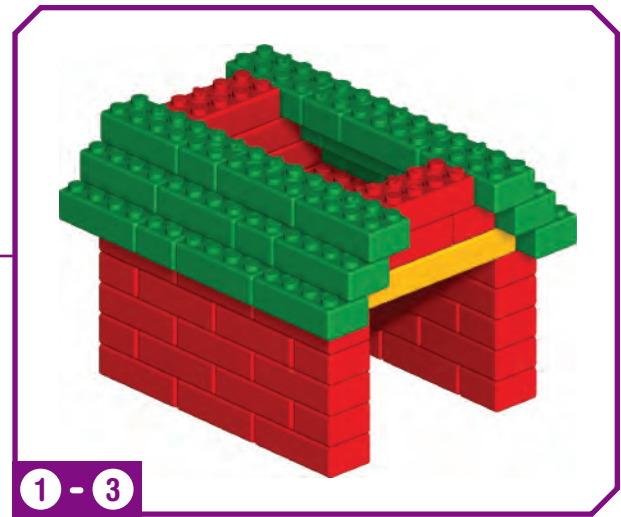
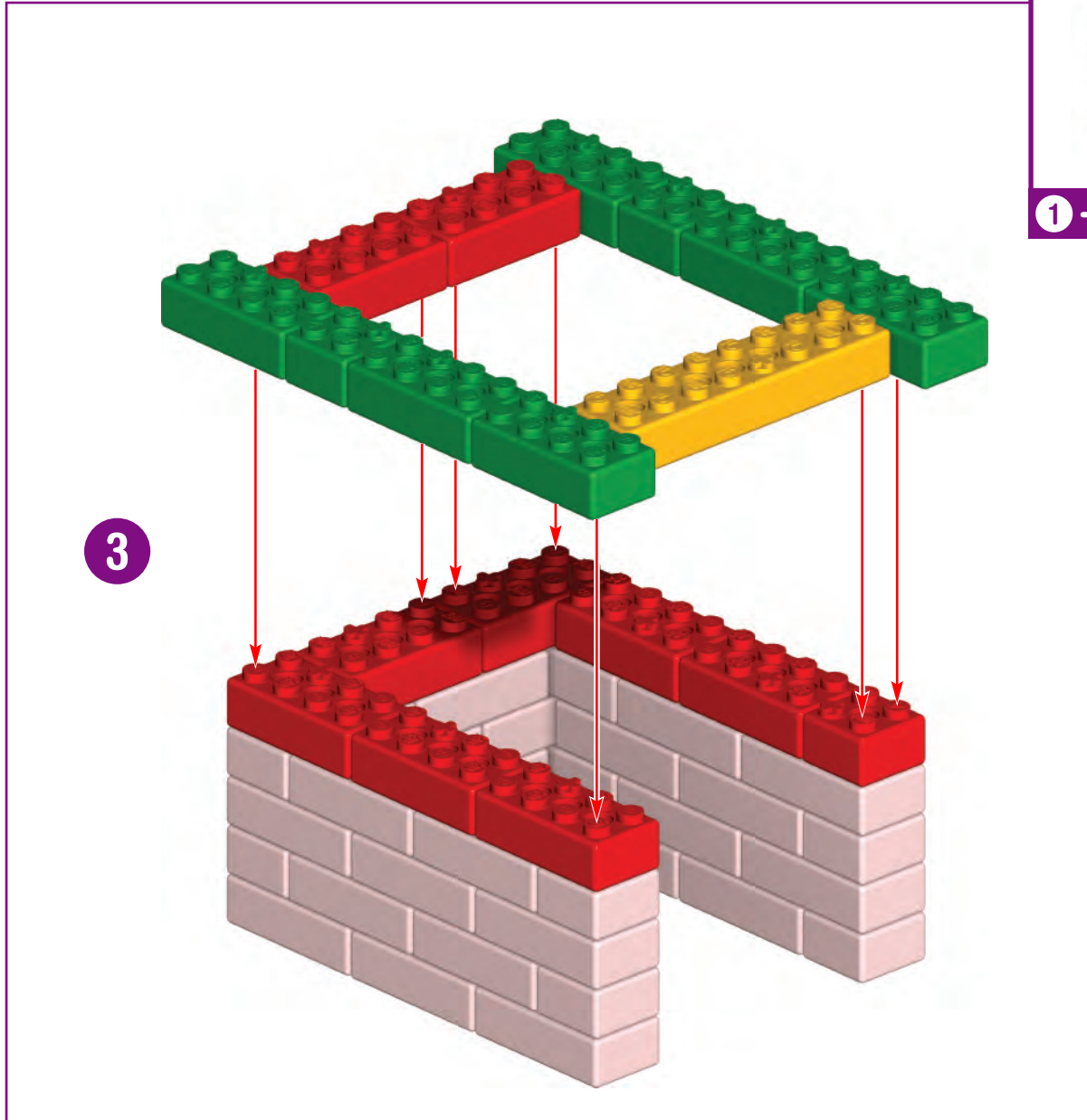

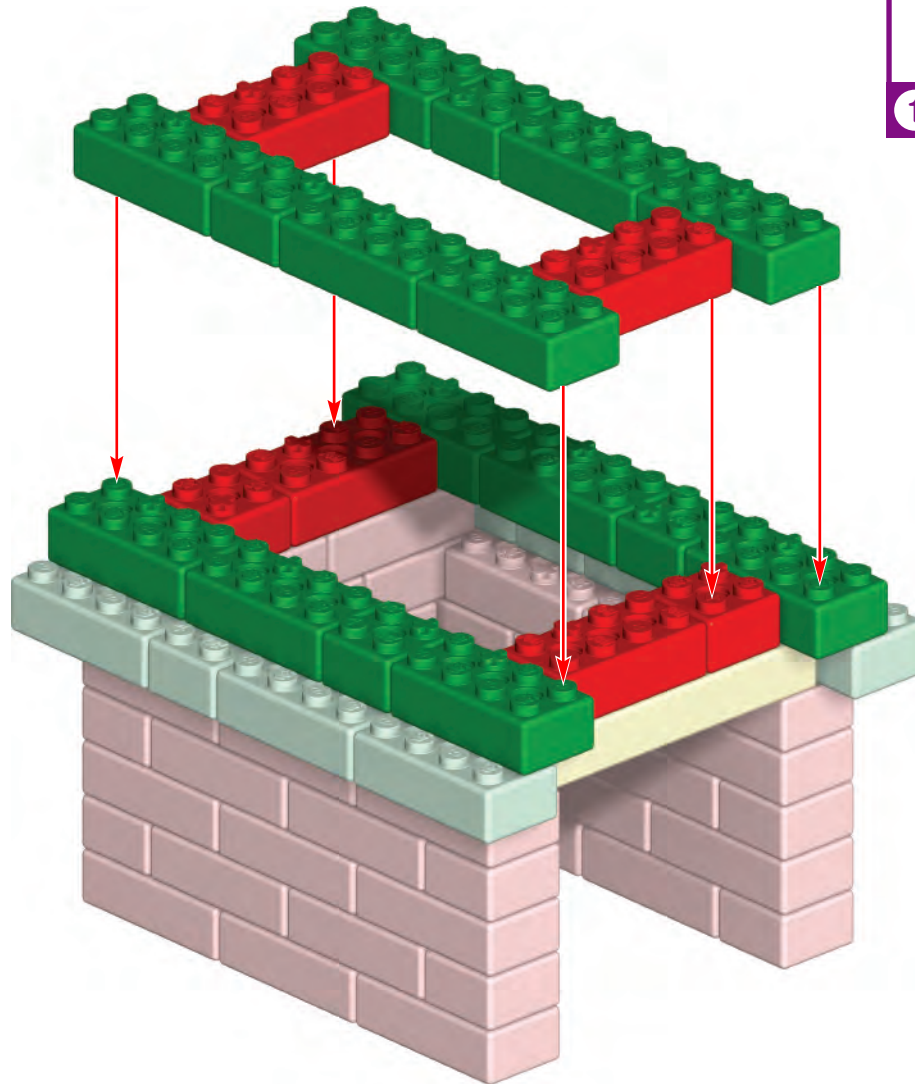

1 - 4

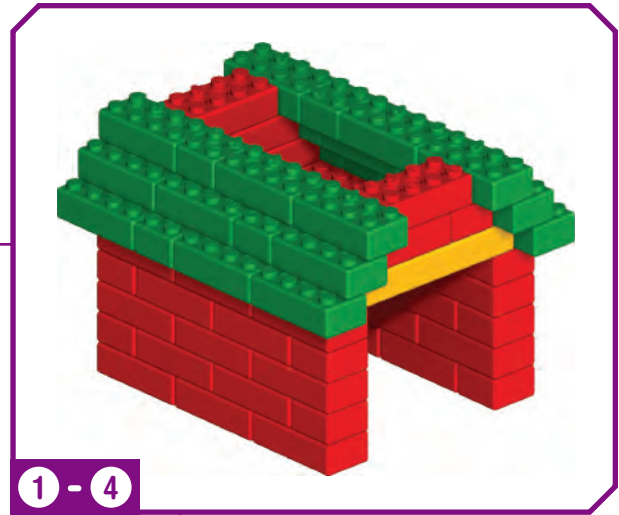

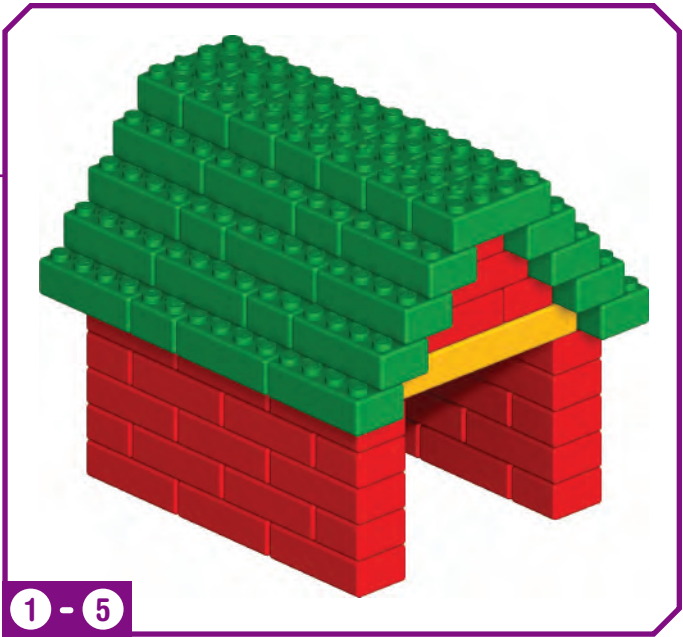
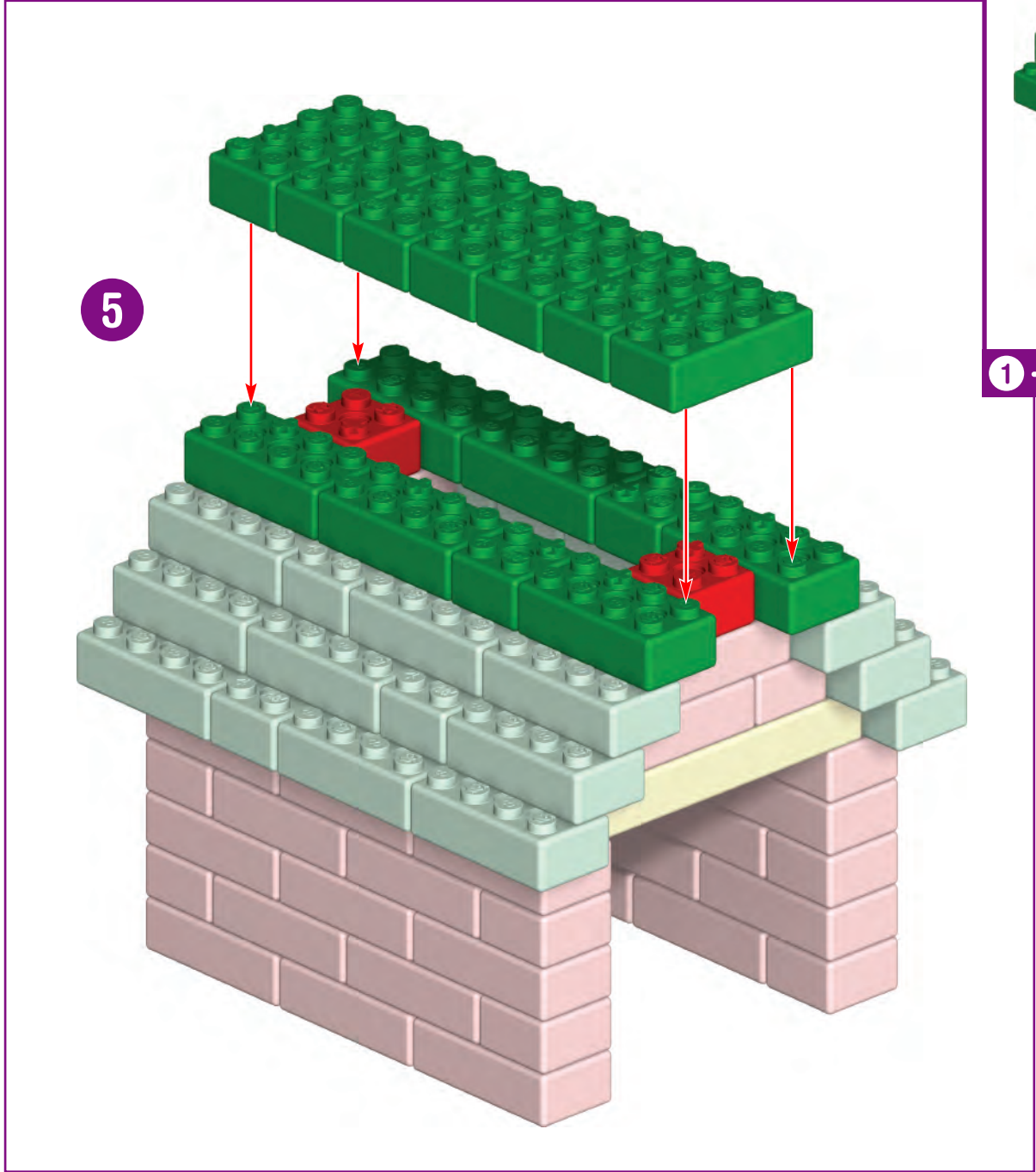

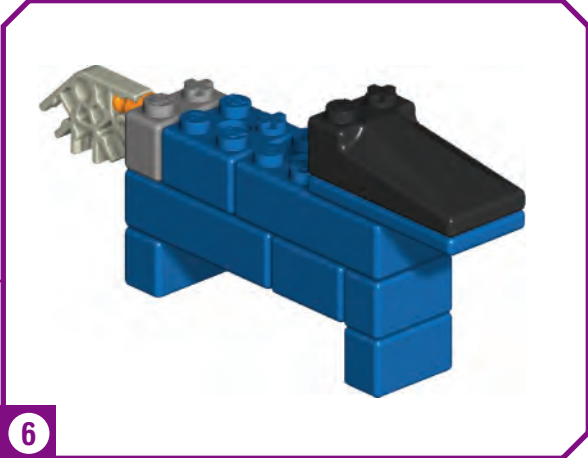
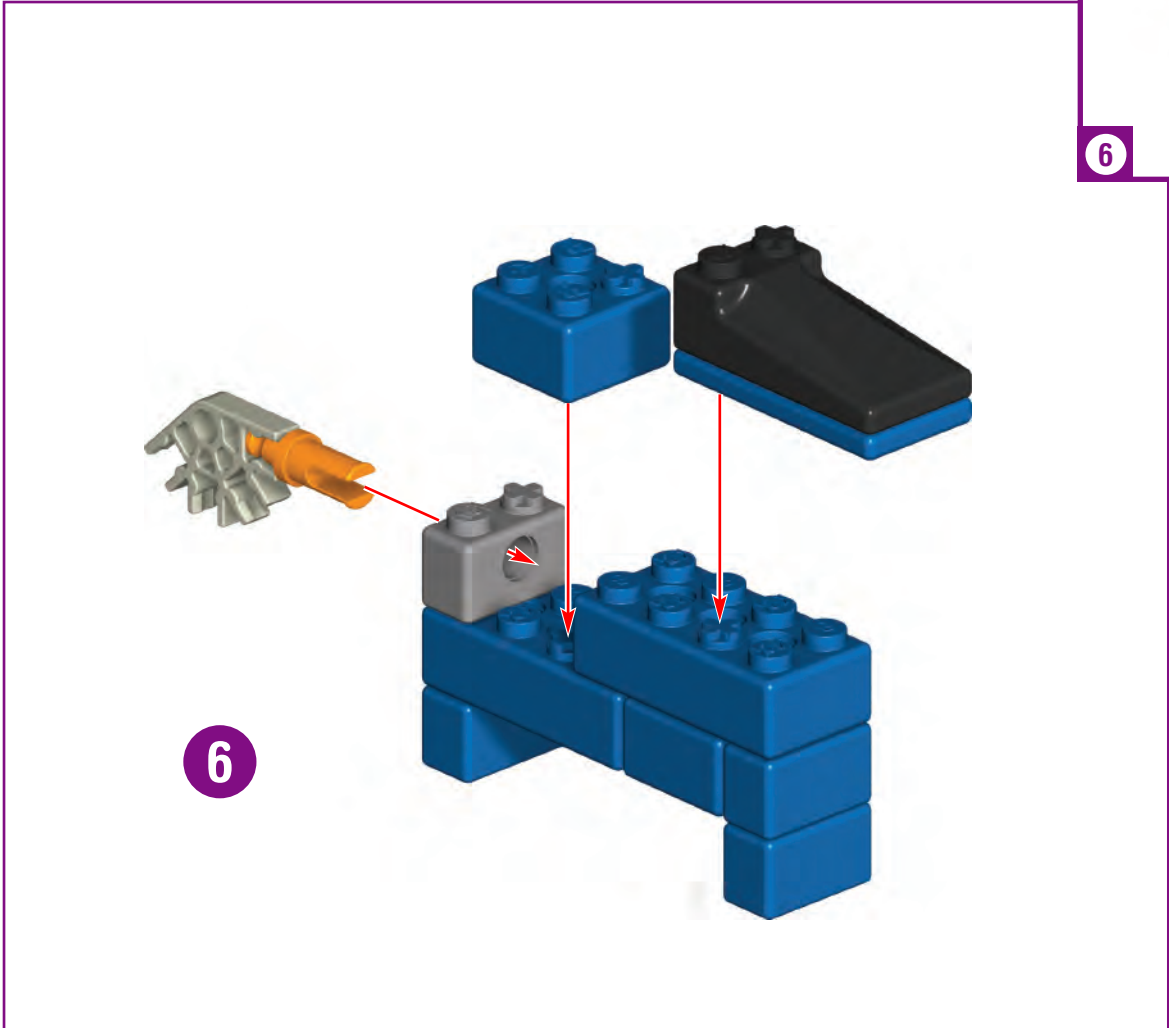

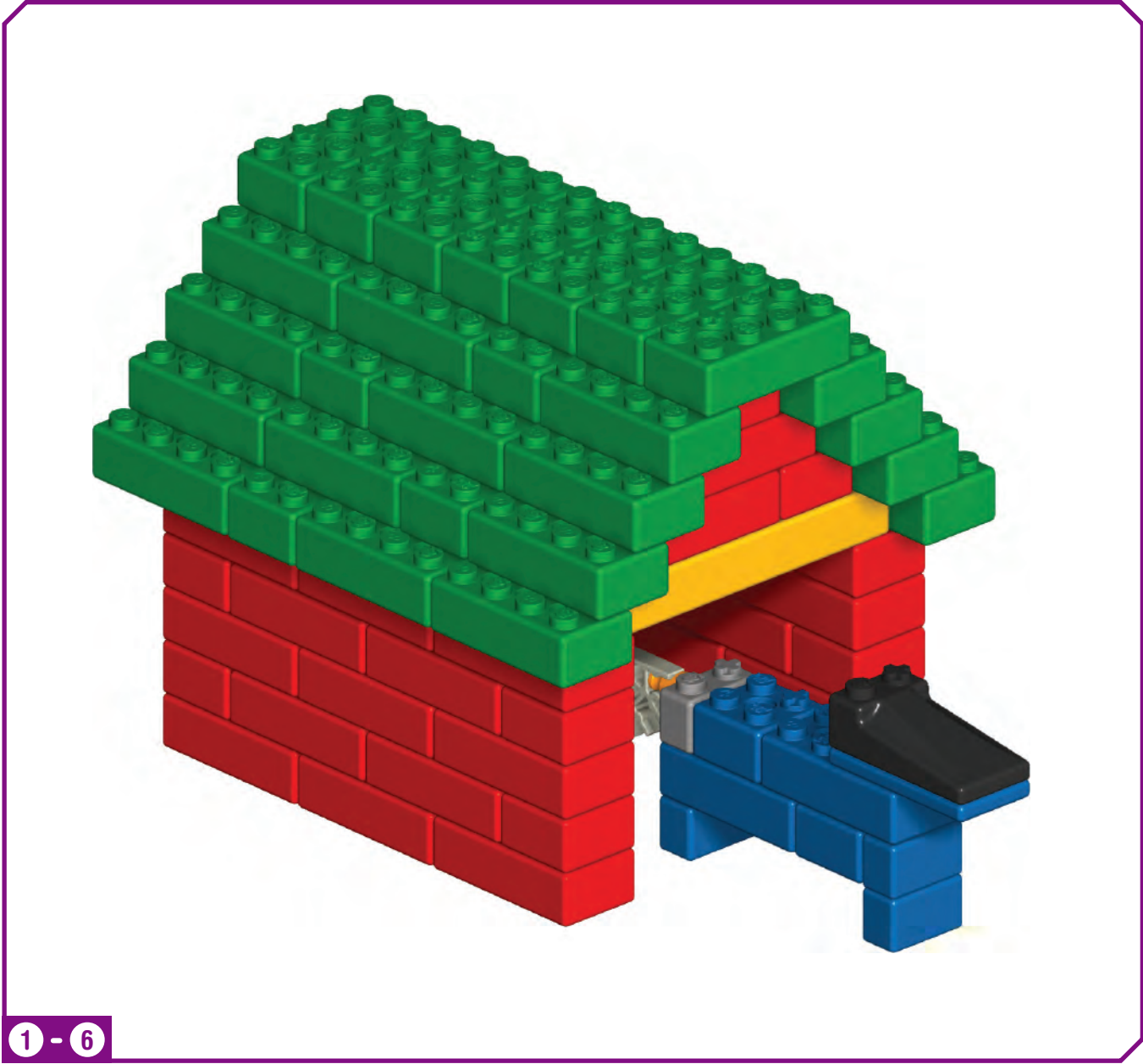

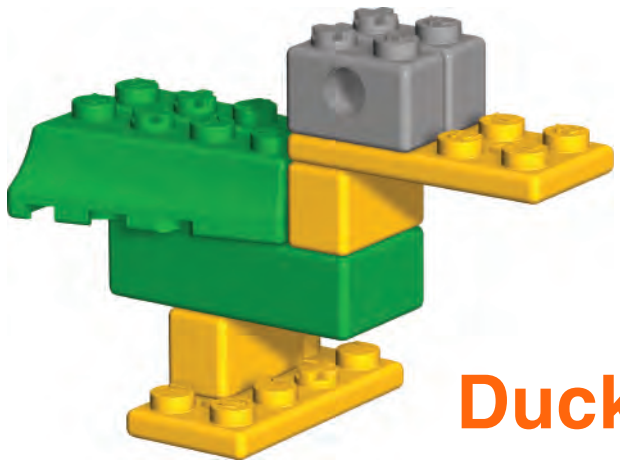

Duck

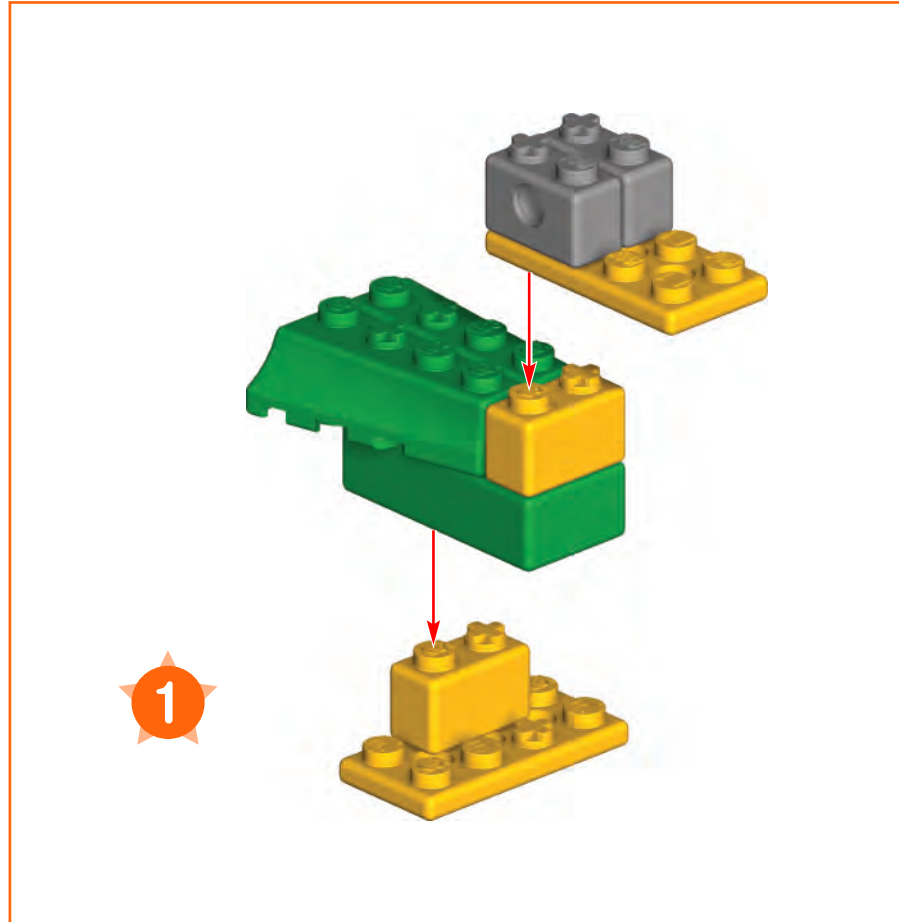

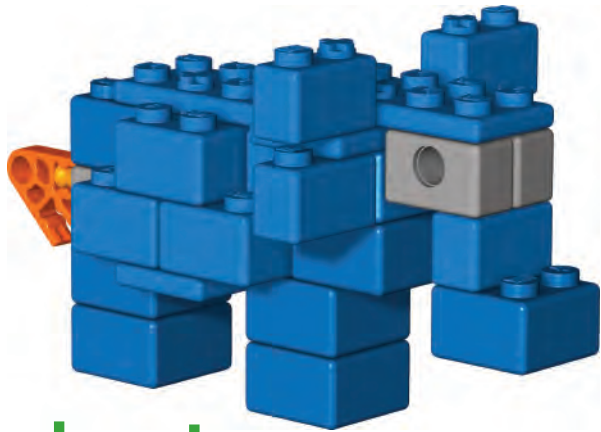

Elephant

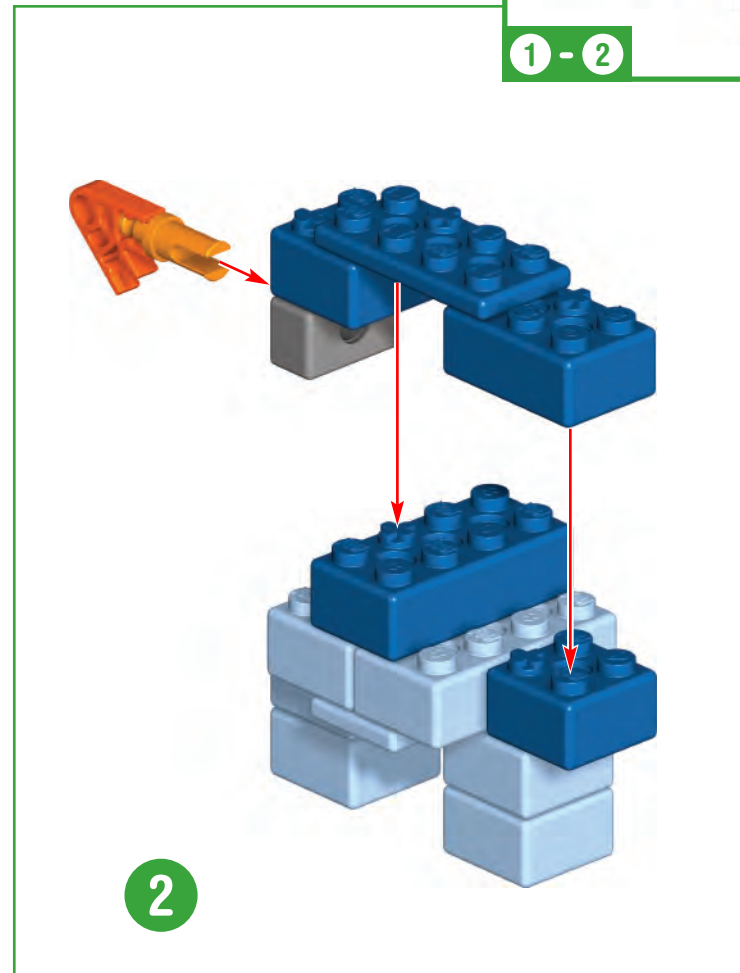
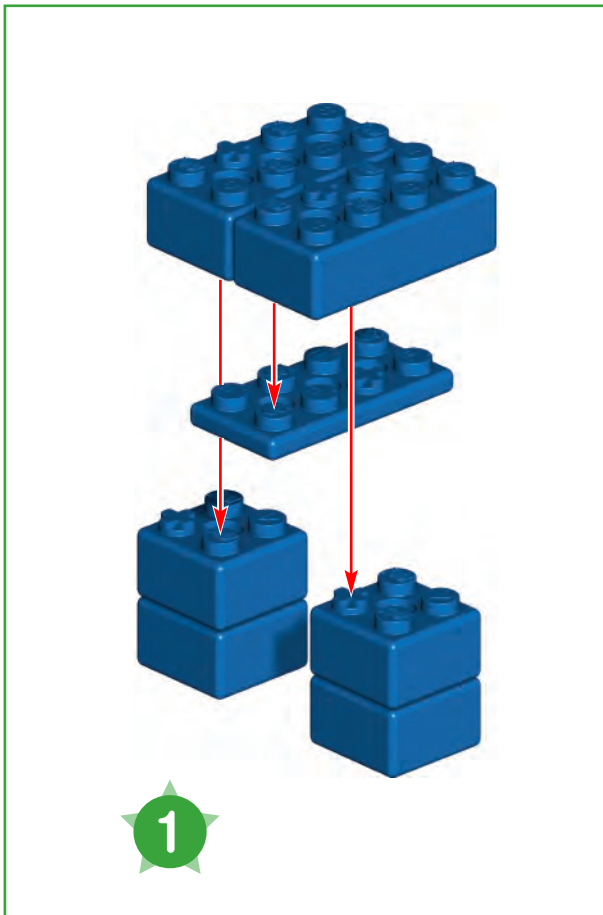
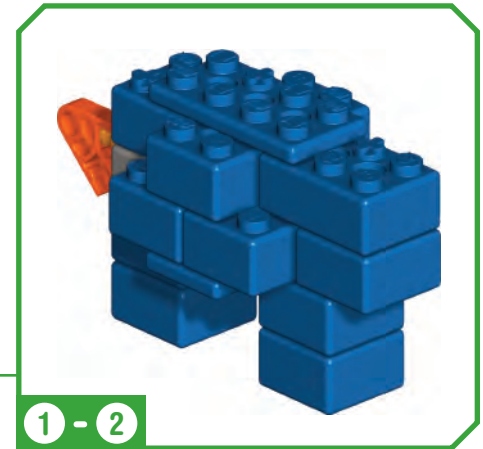

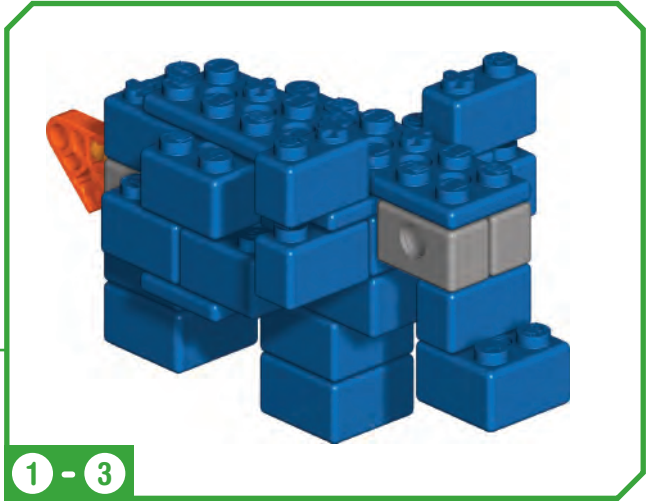
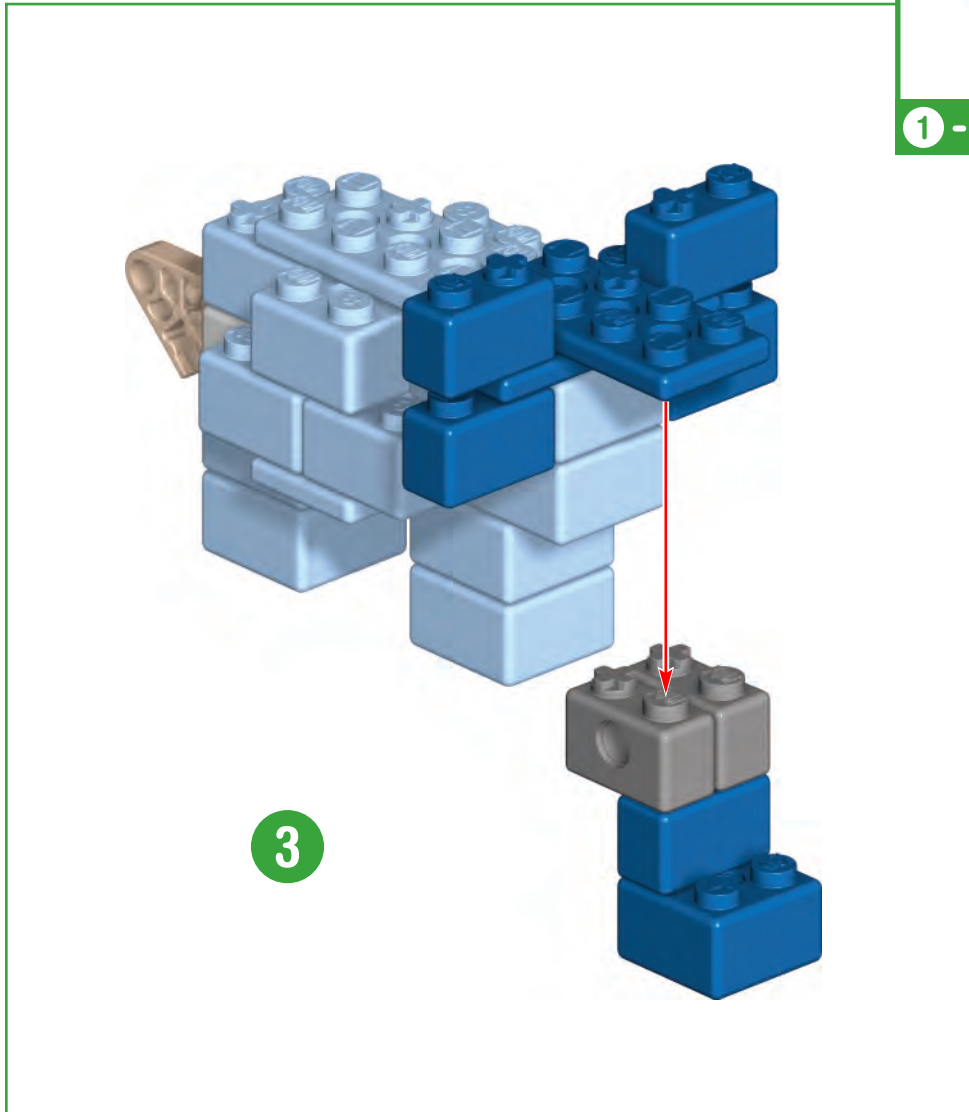



Front End Loader

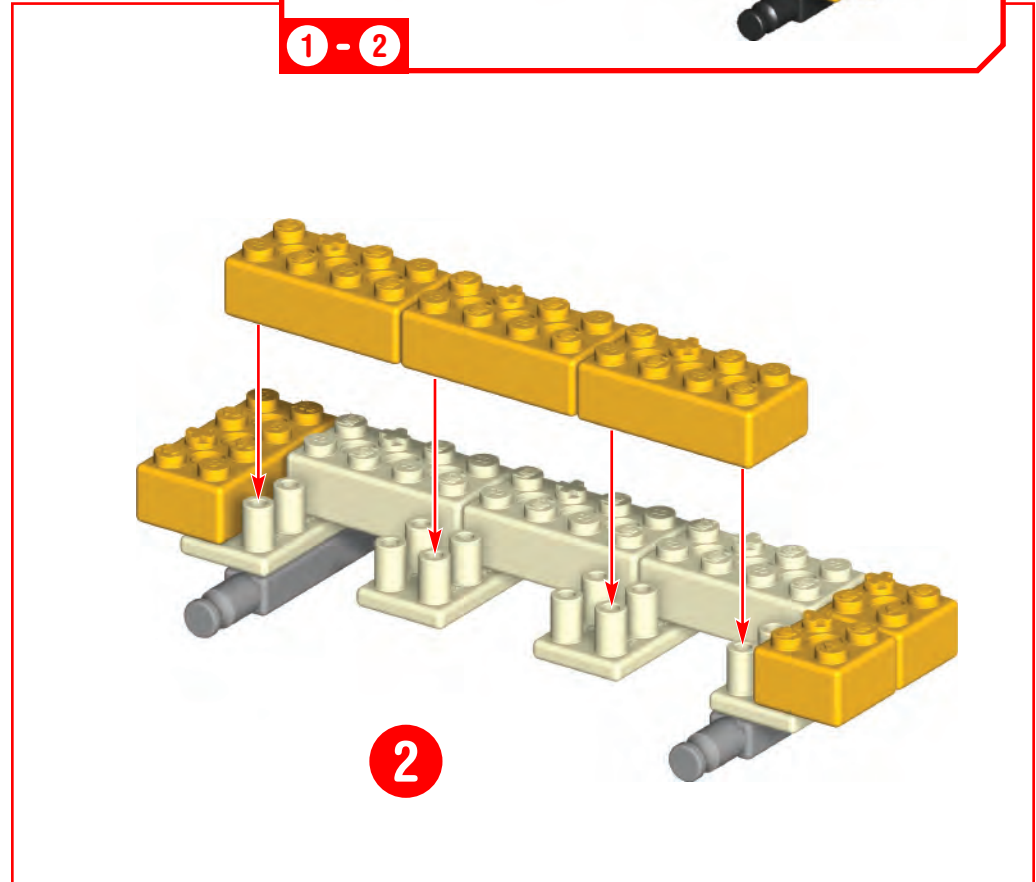
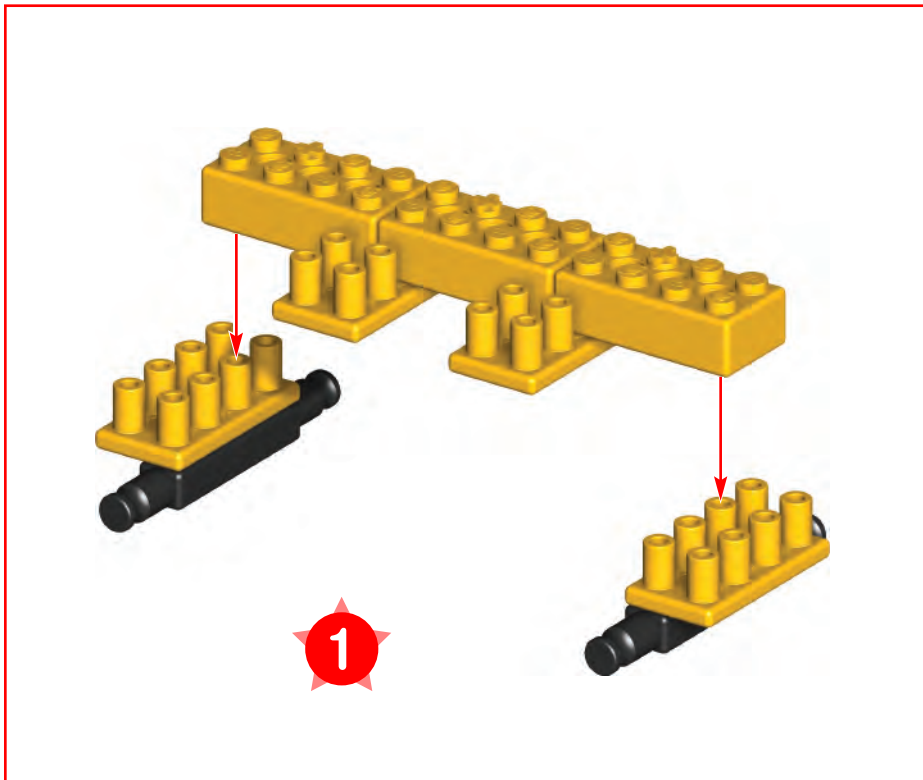
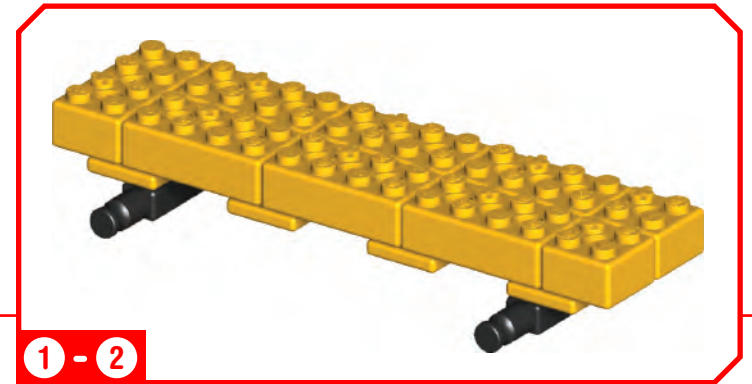

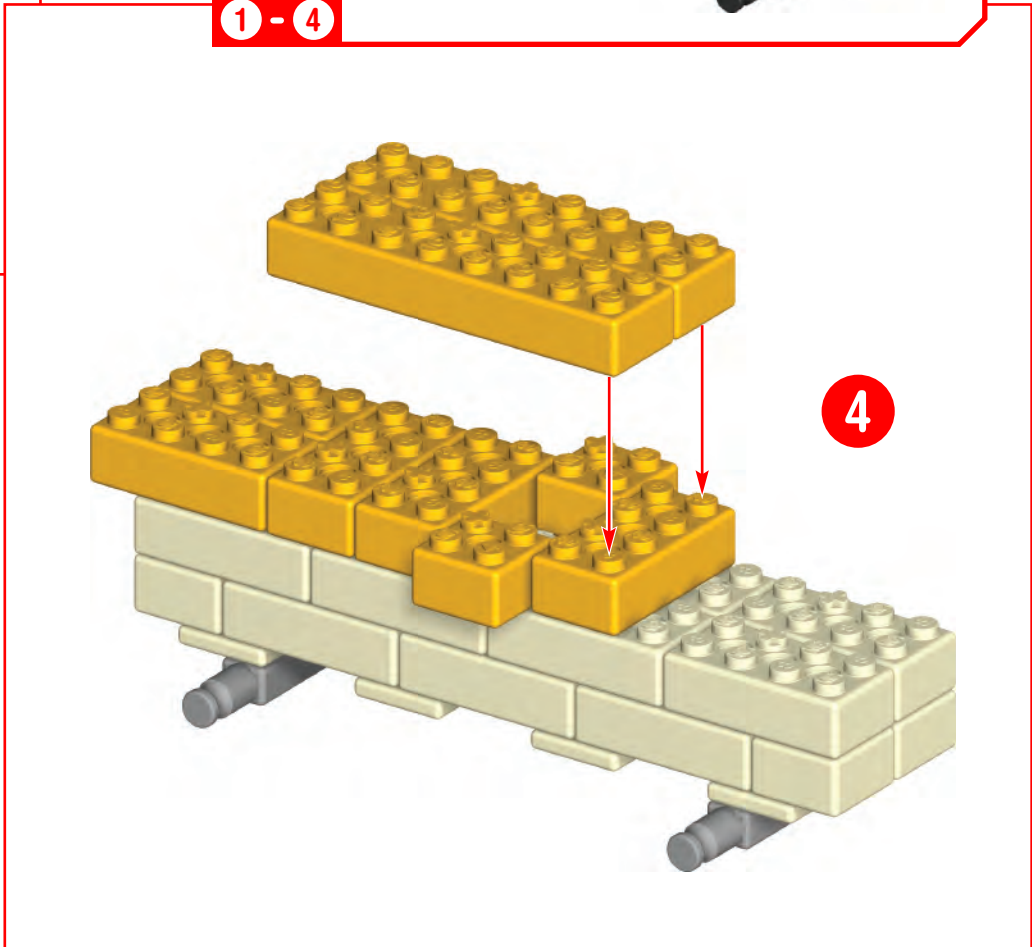
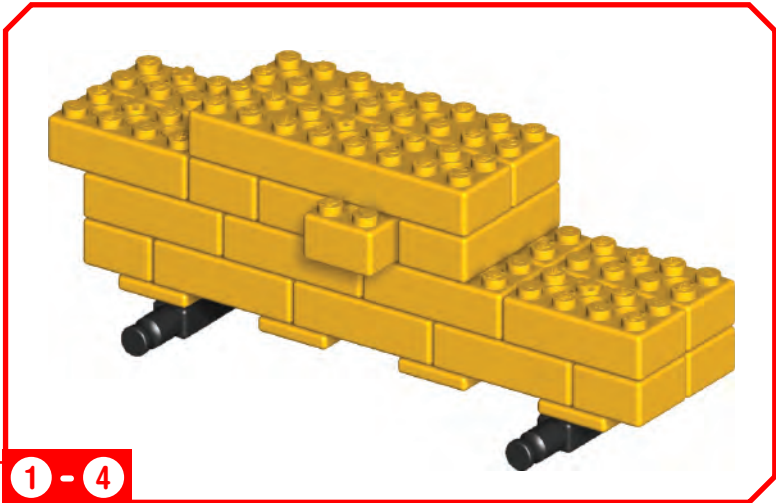
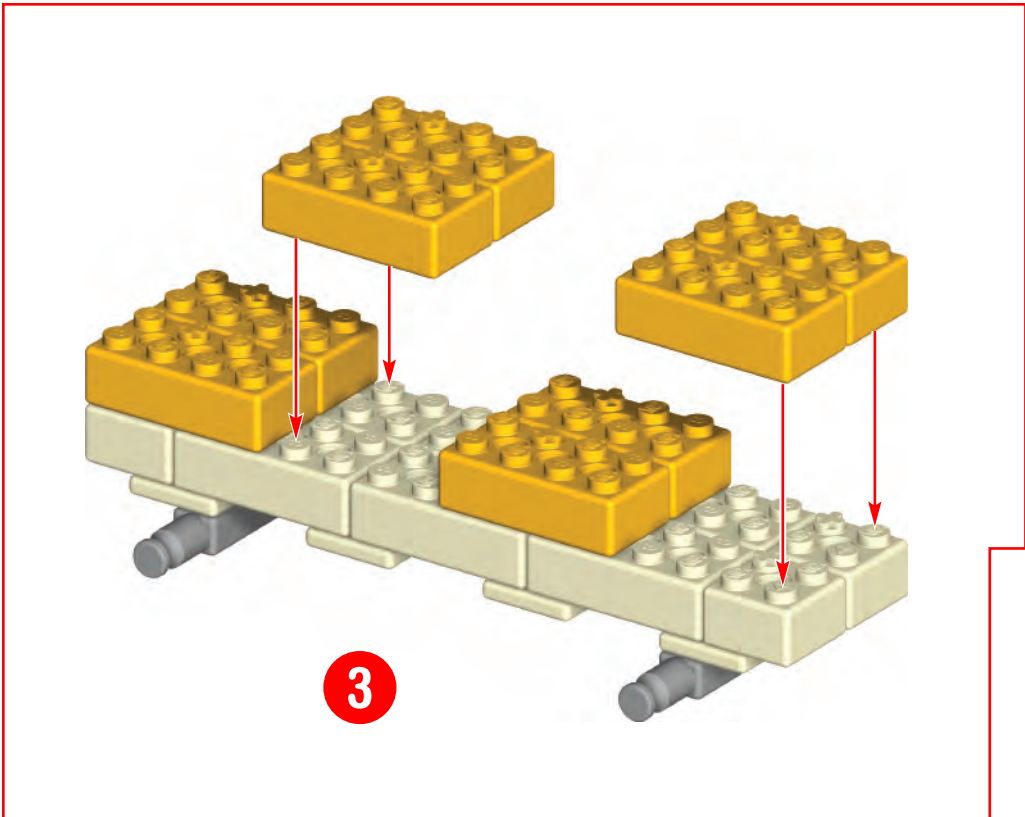

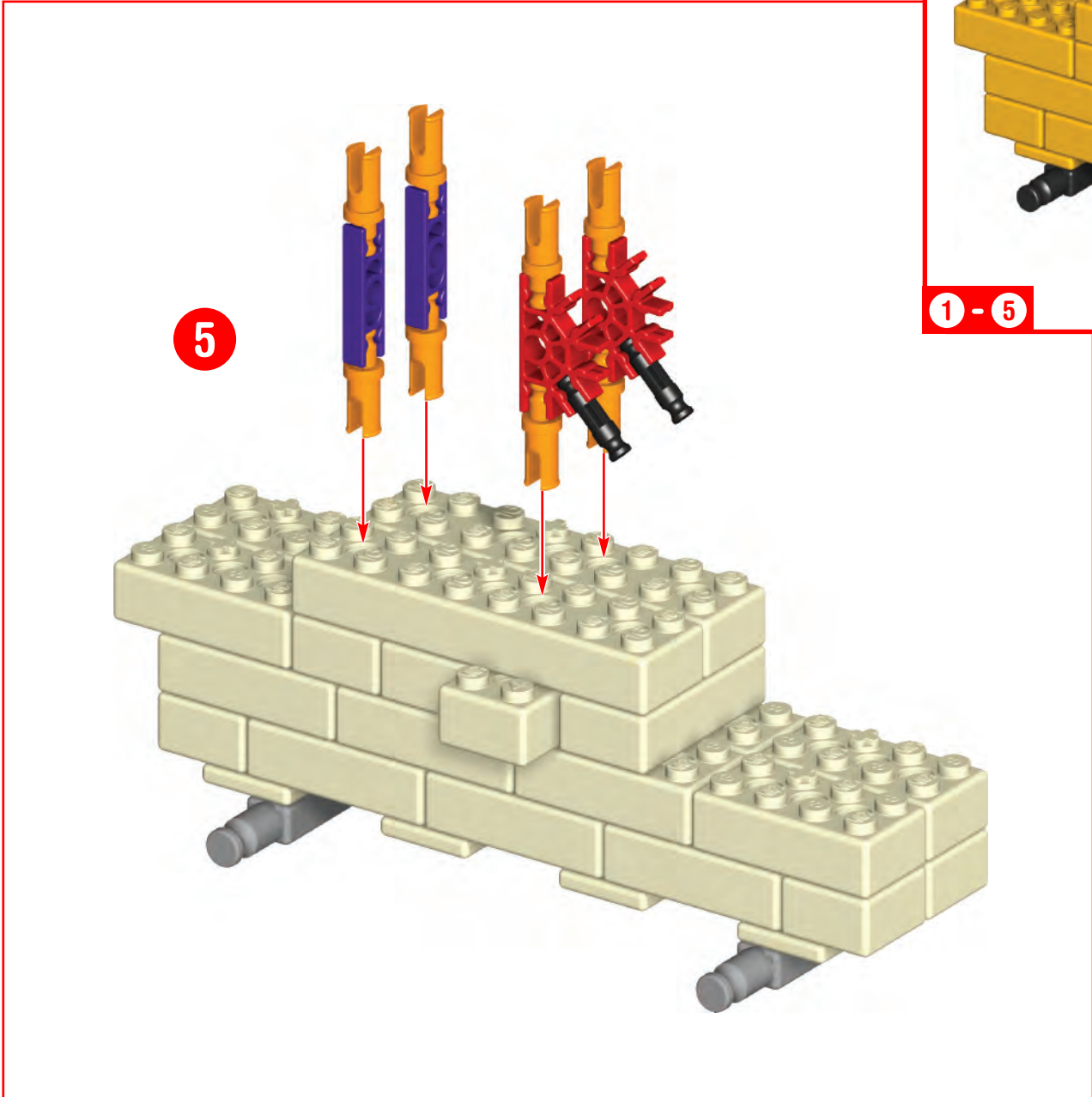

6

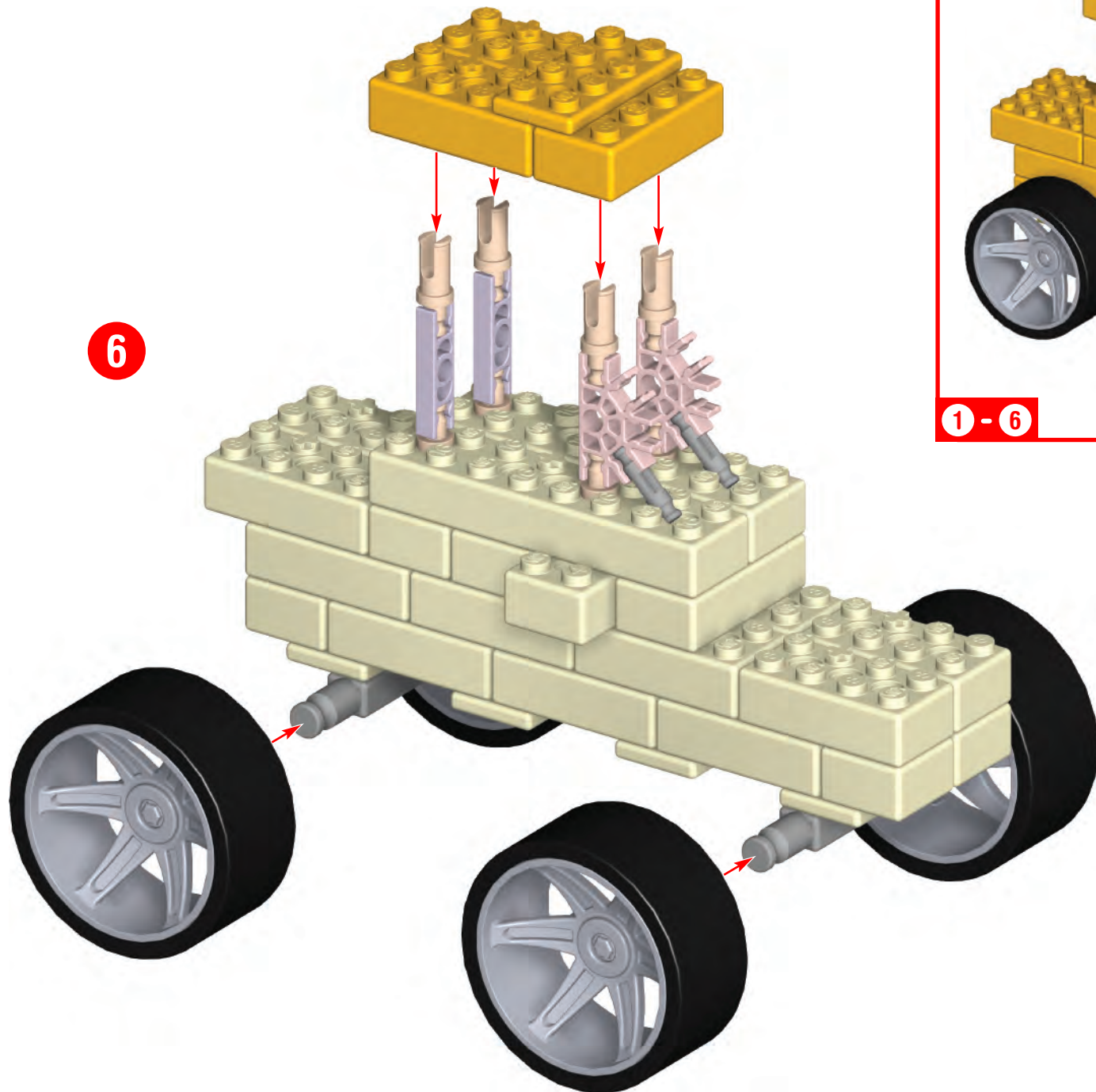

1 - 6



7

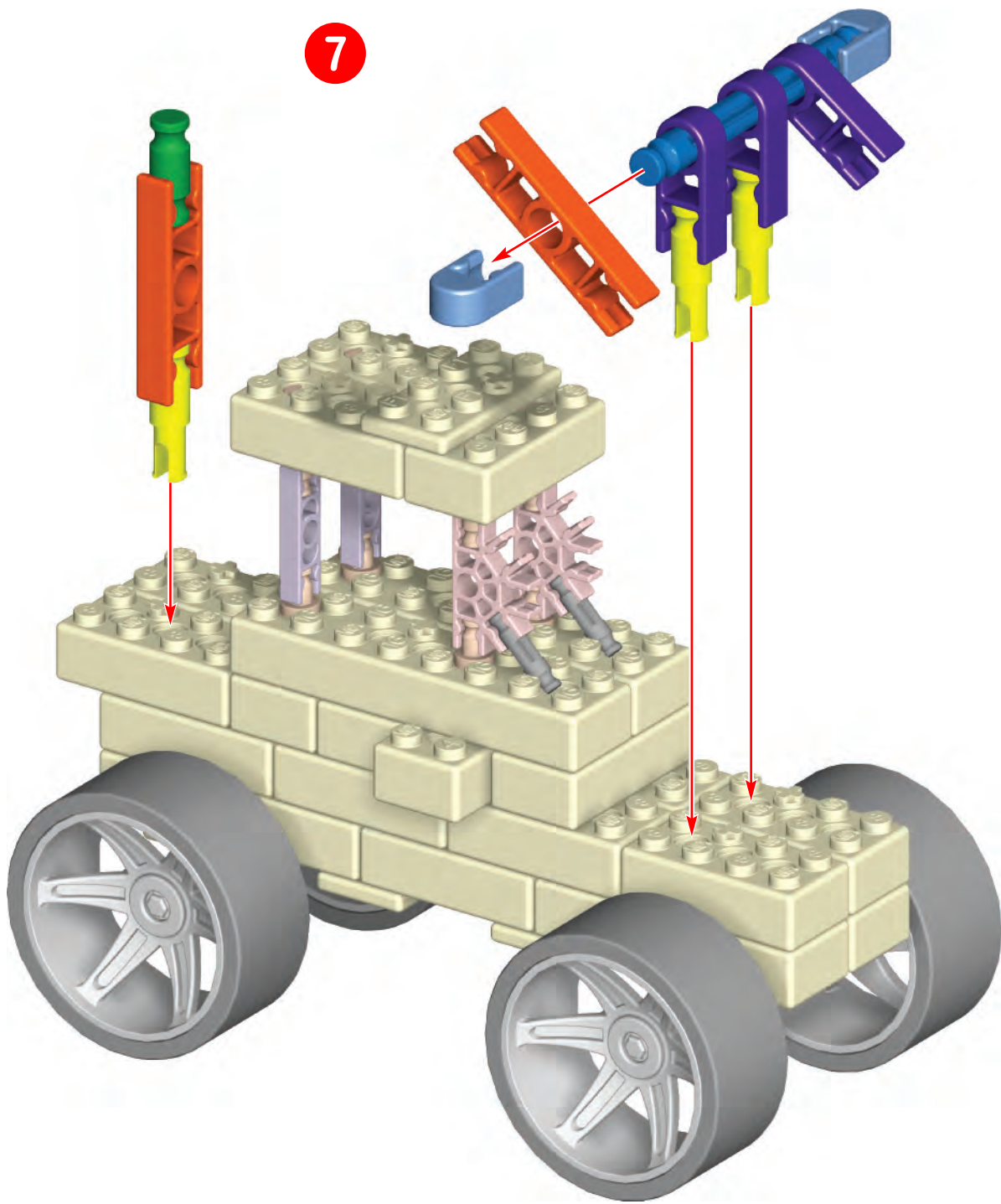

1 - 7

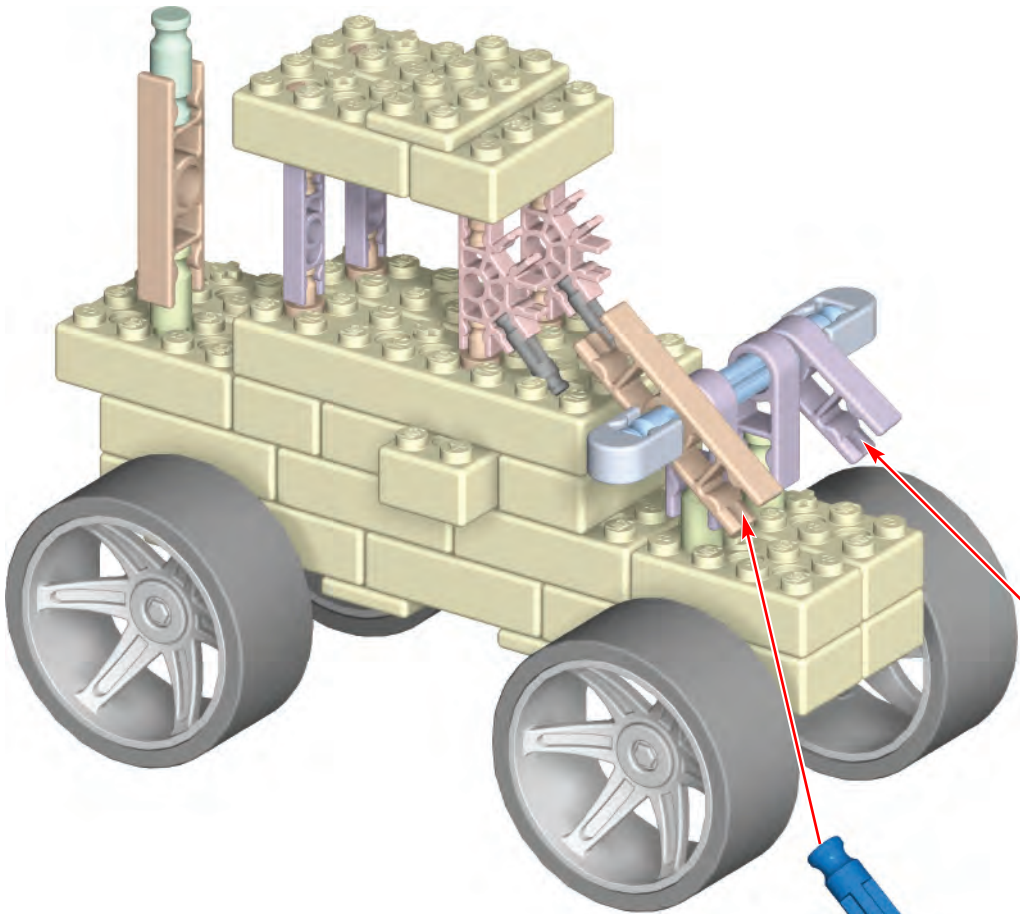

8

1 - 8



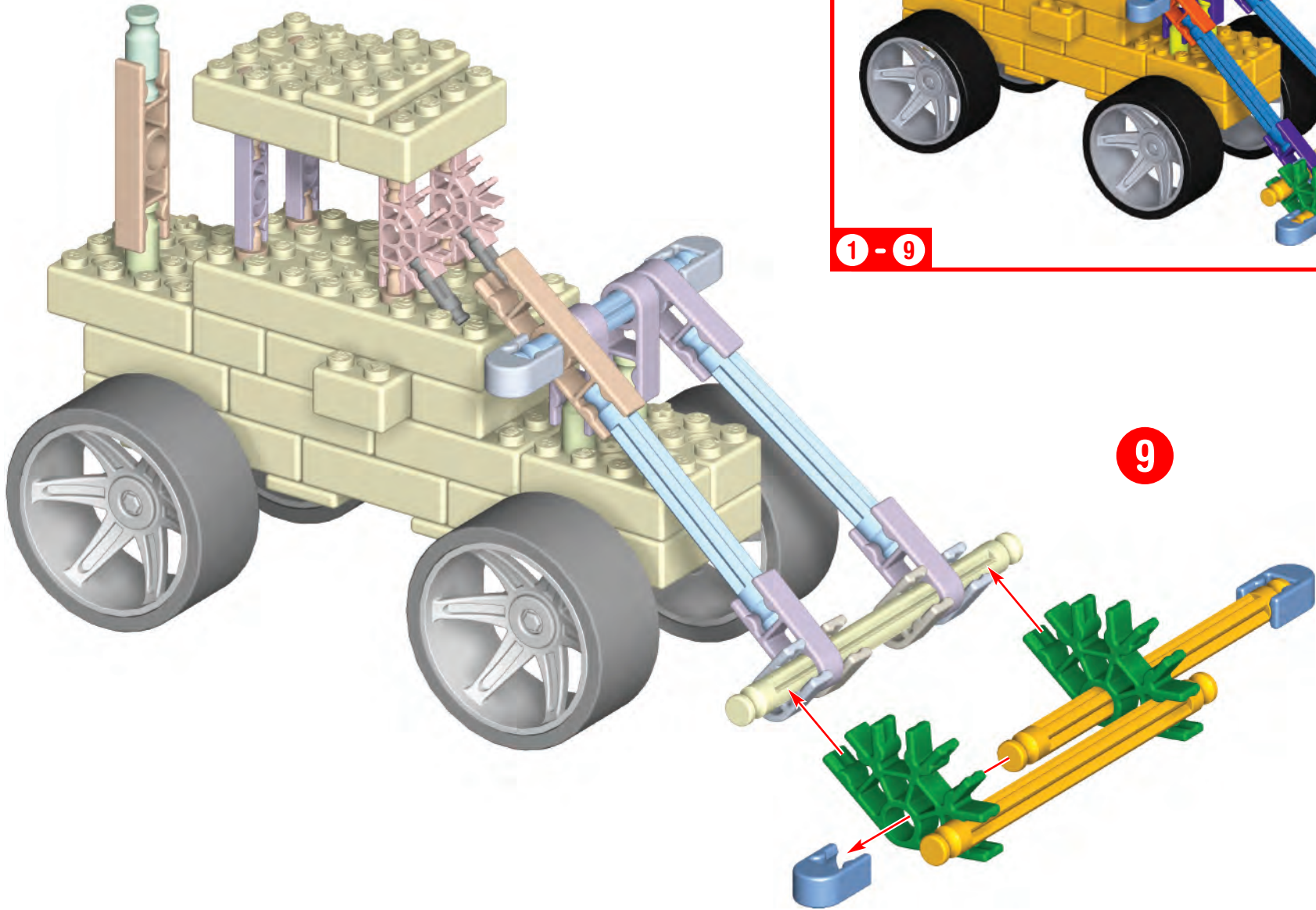



Jet Plane

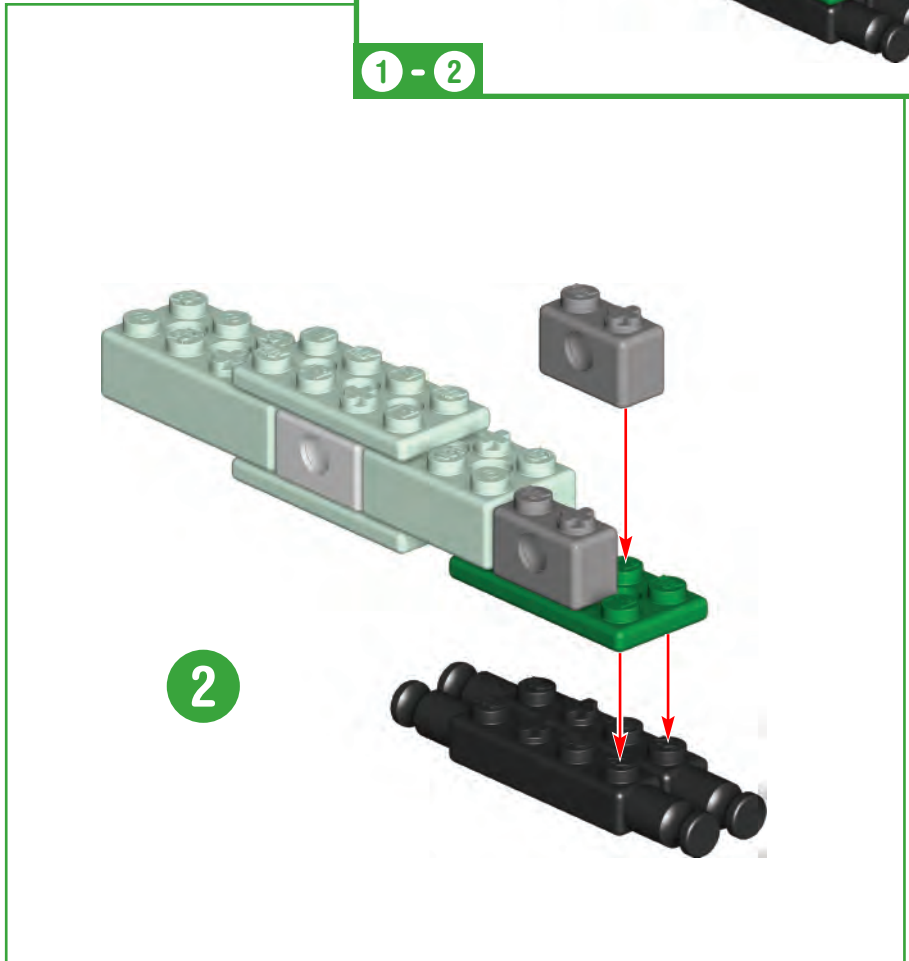
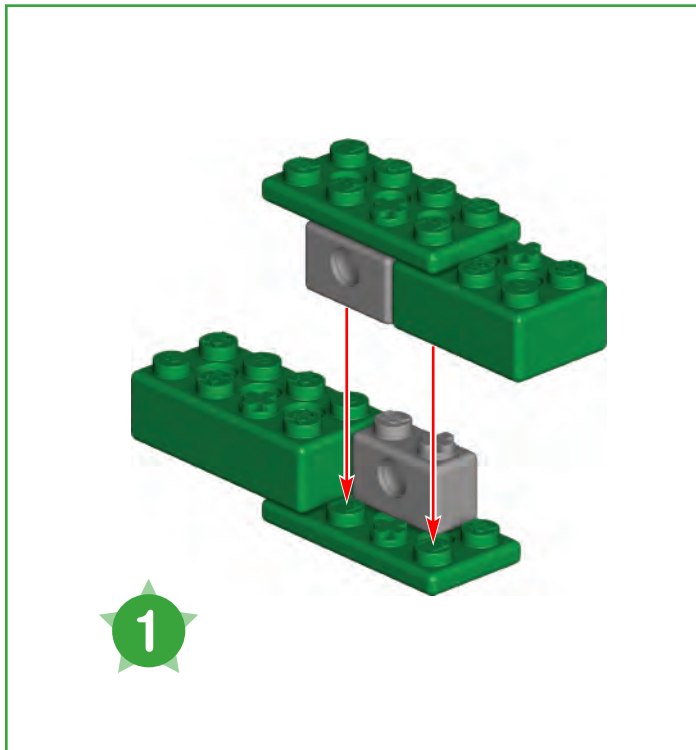
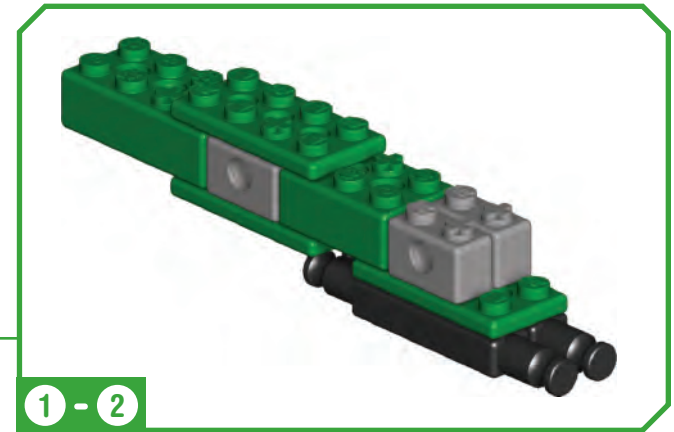

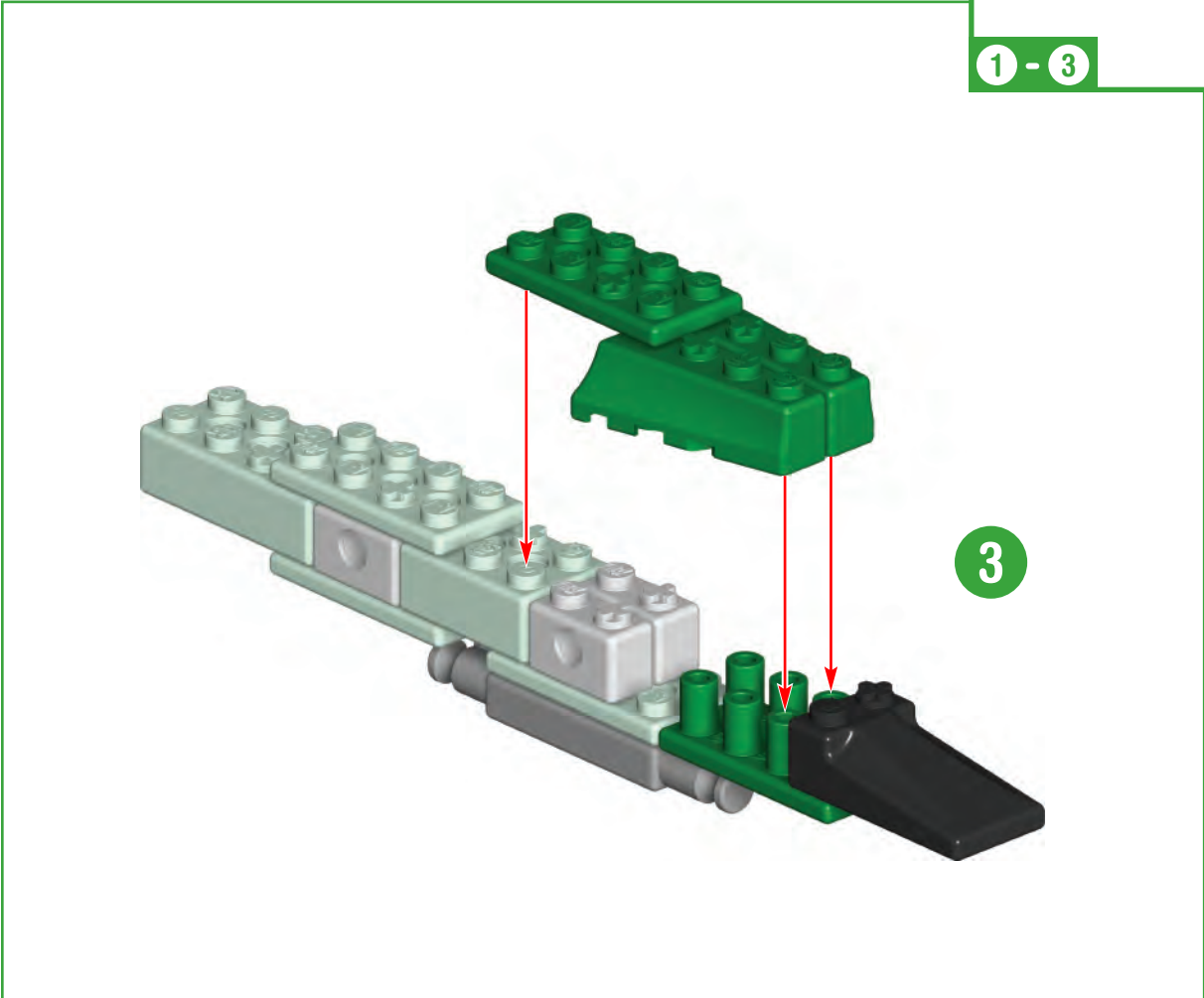
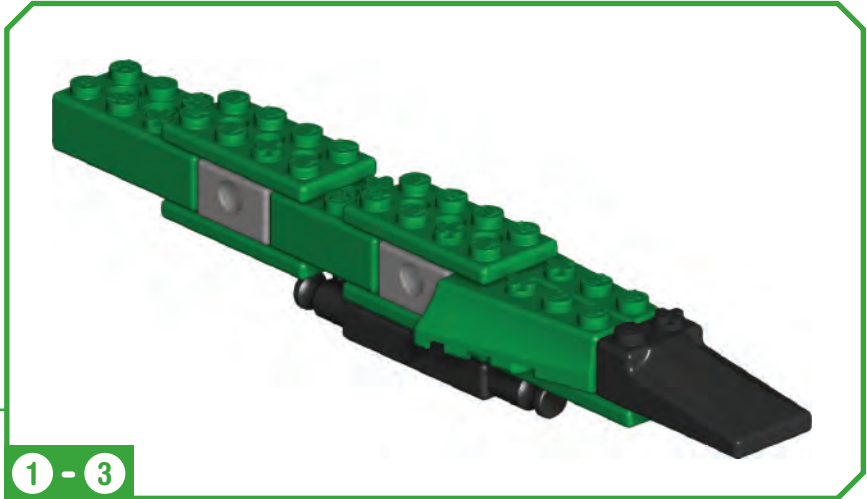

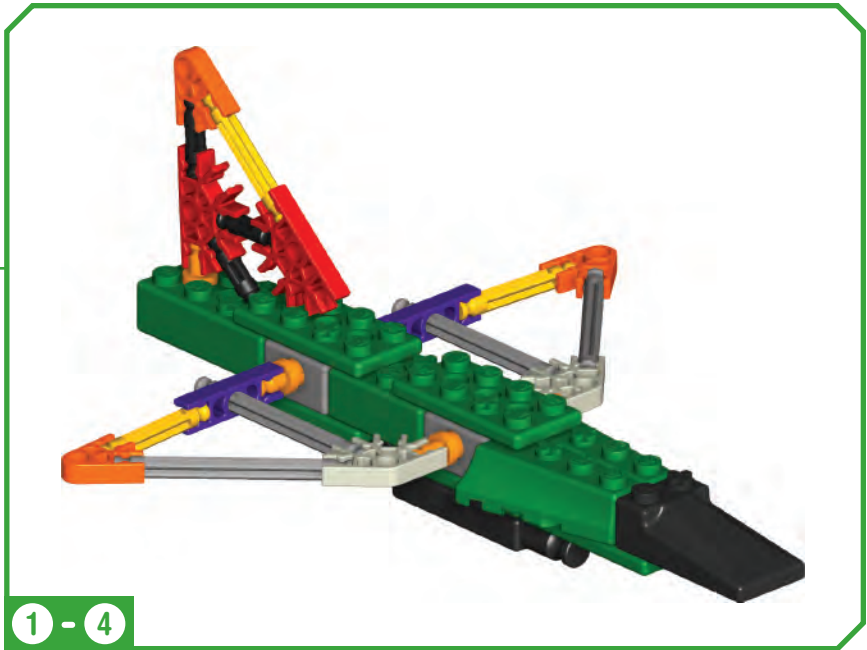
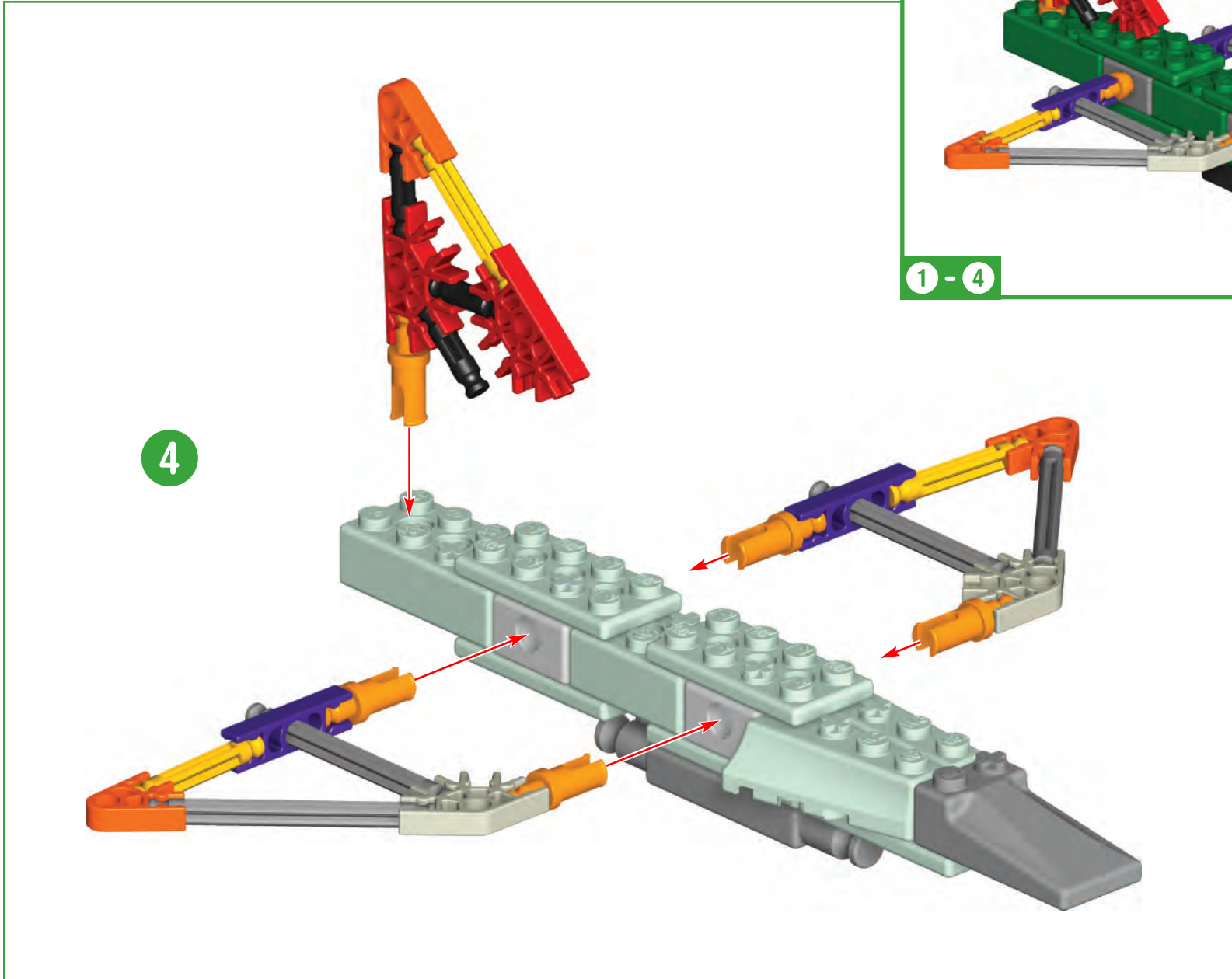

Mayan Temple

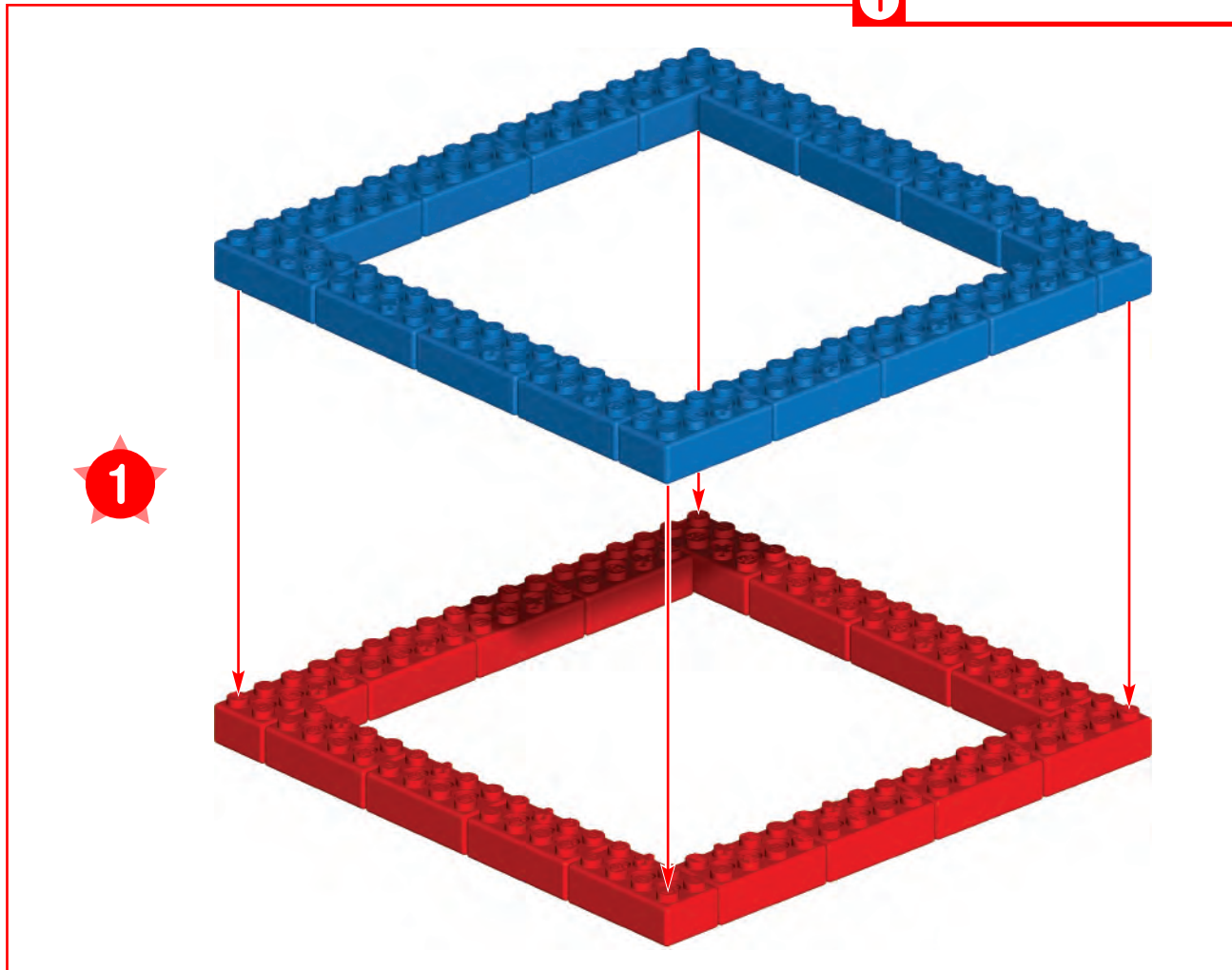
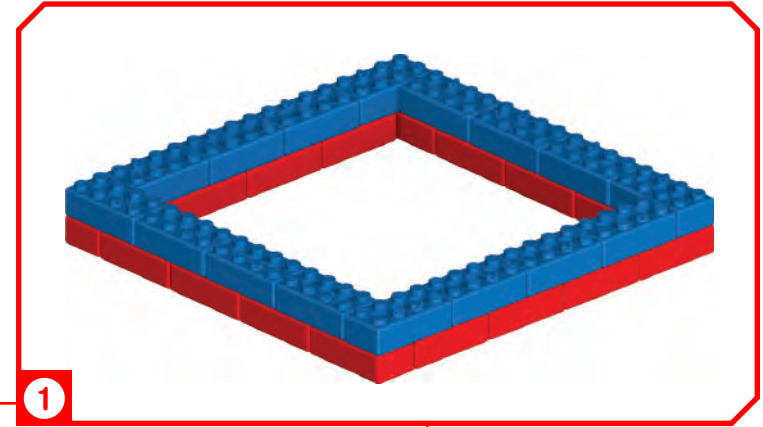

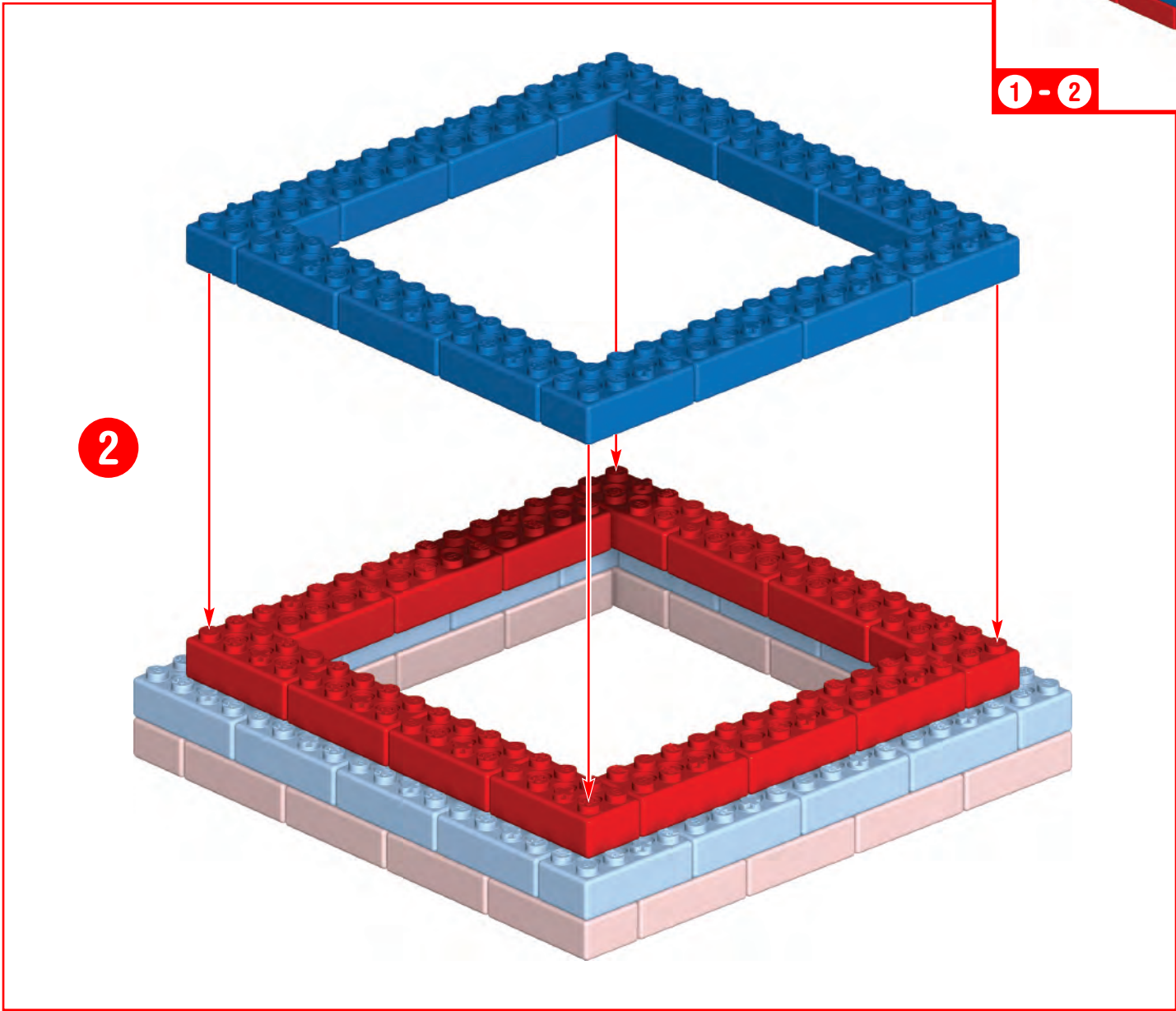
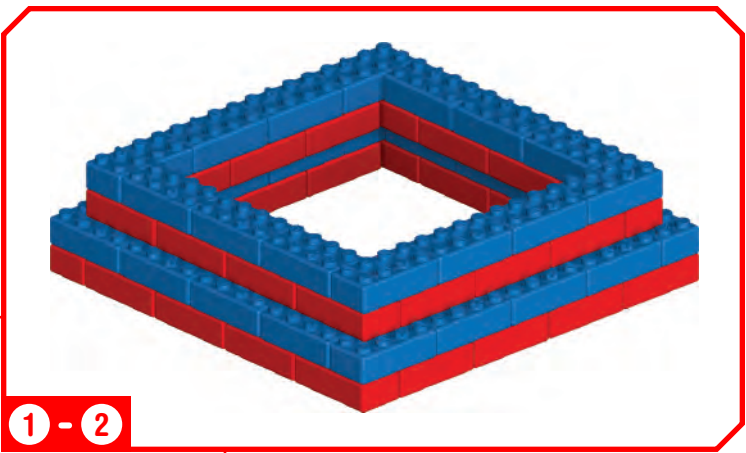

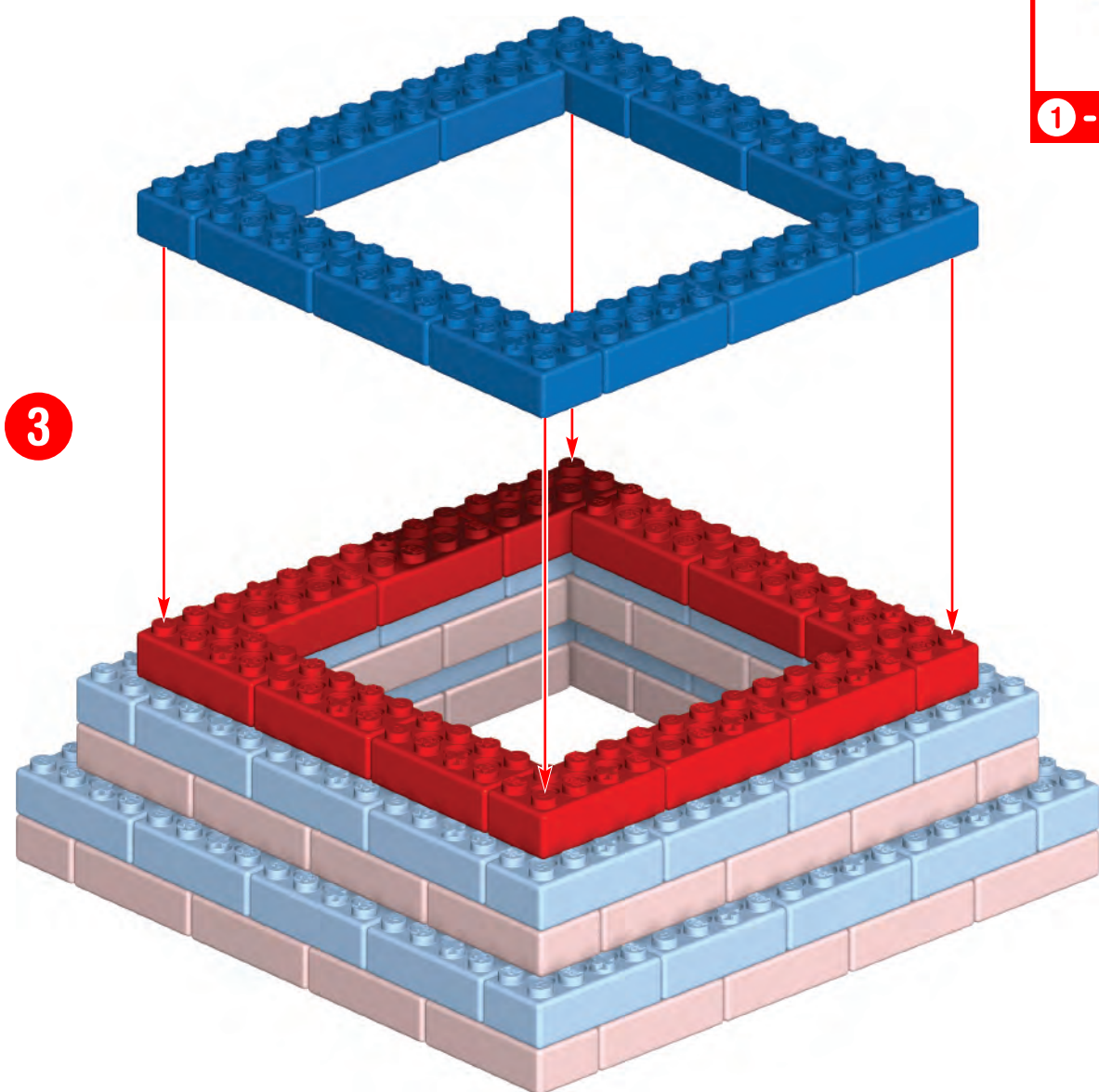

1 - 3

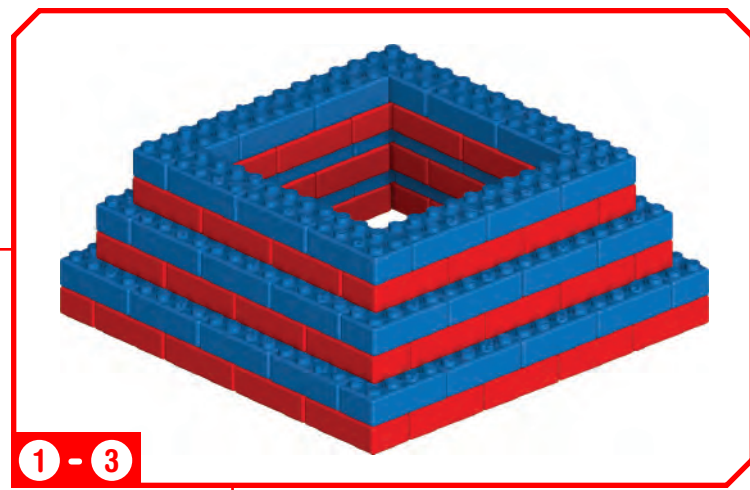

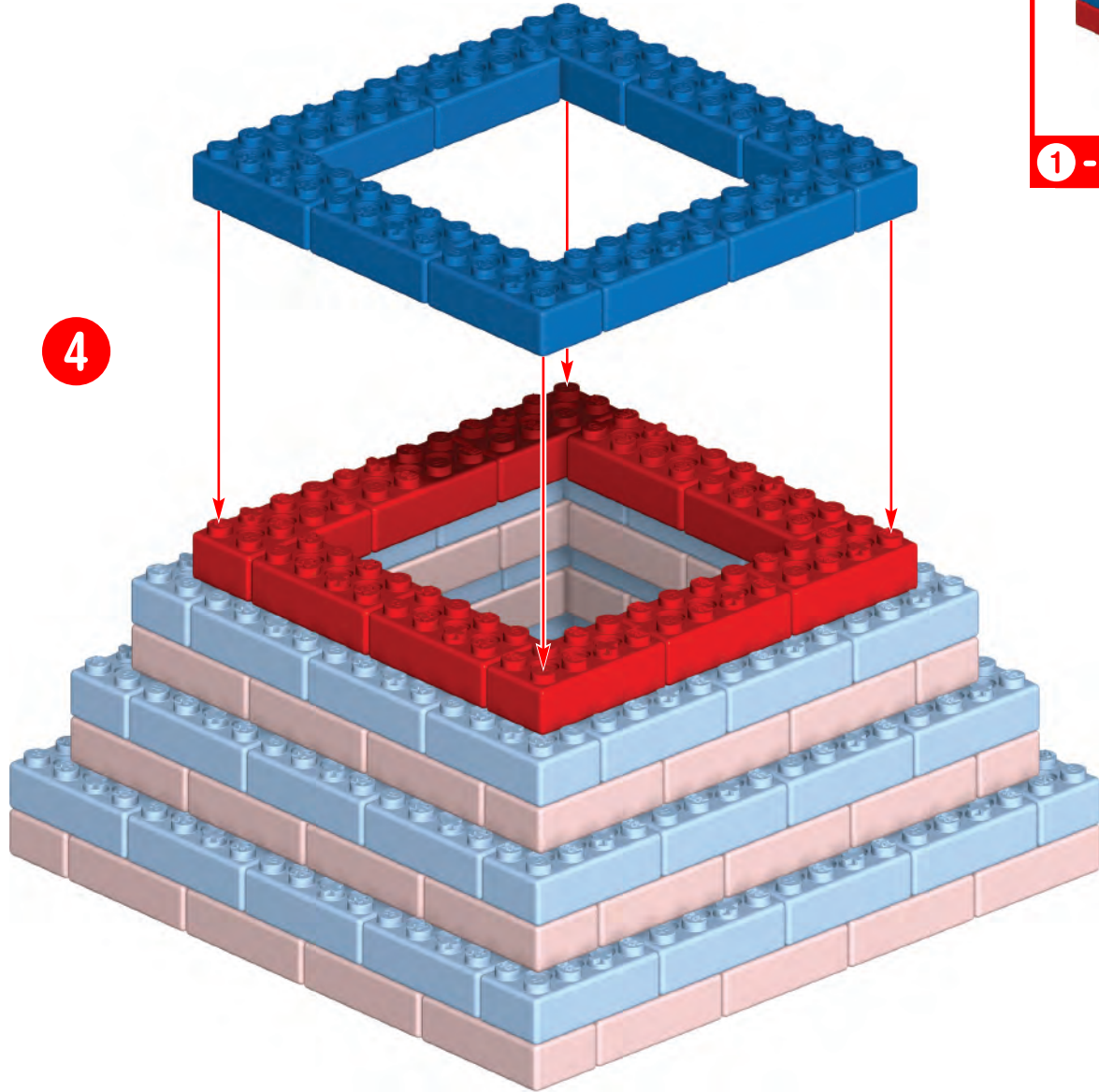

1 - 4

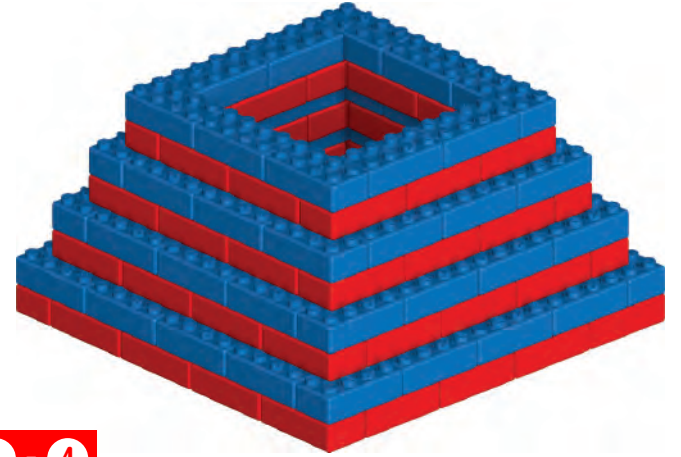

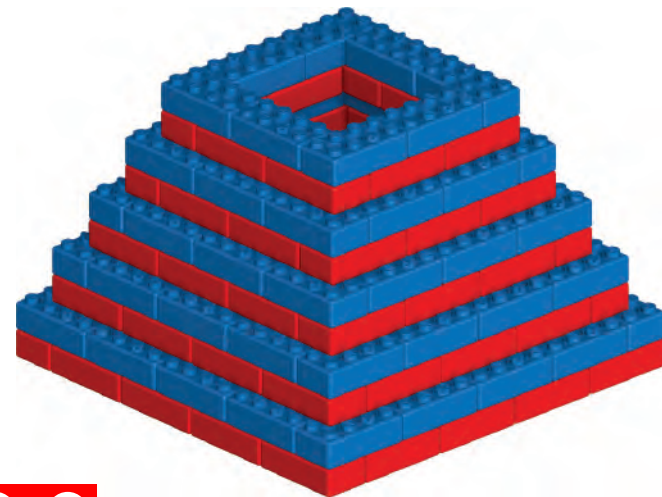
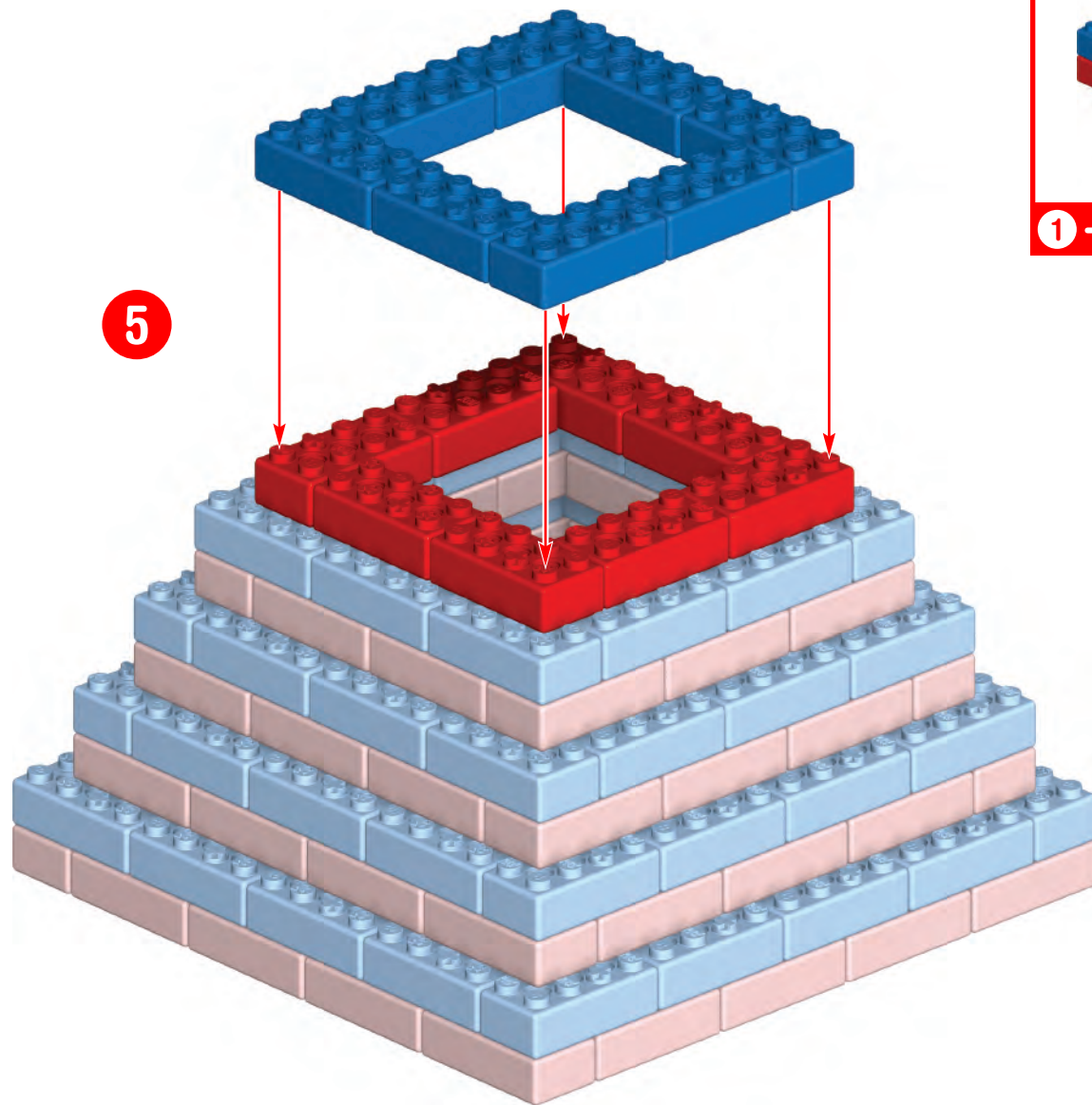

1 - 5

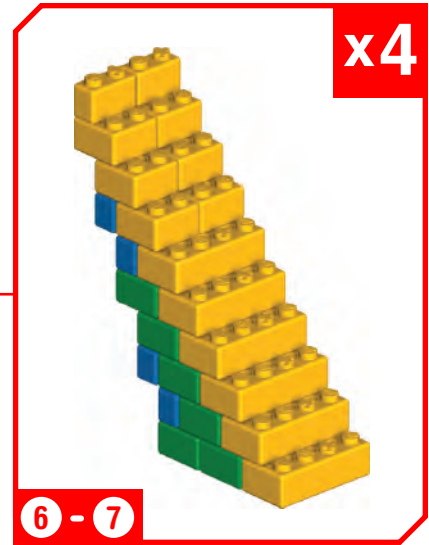
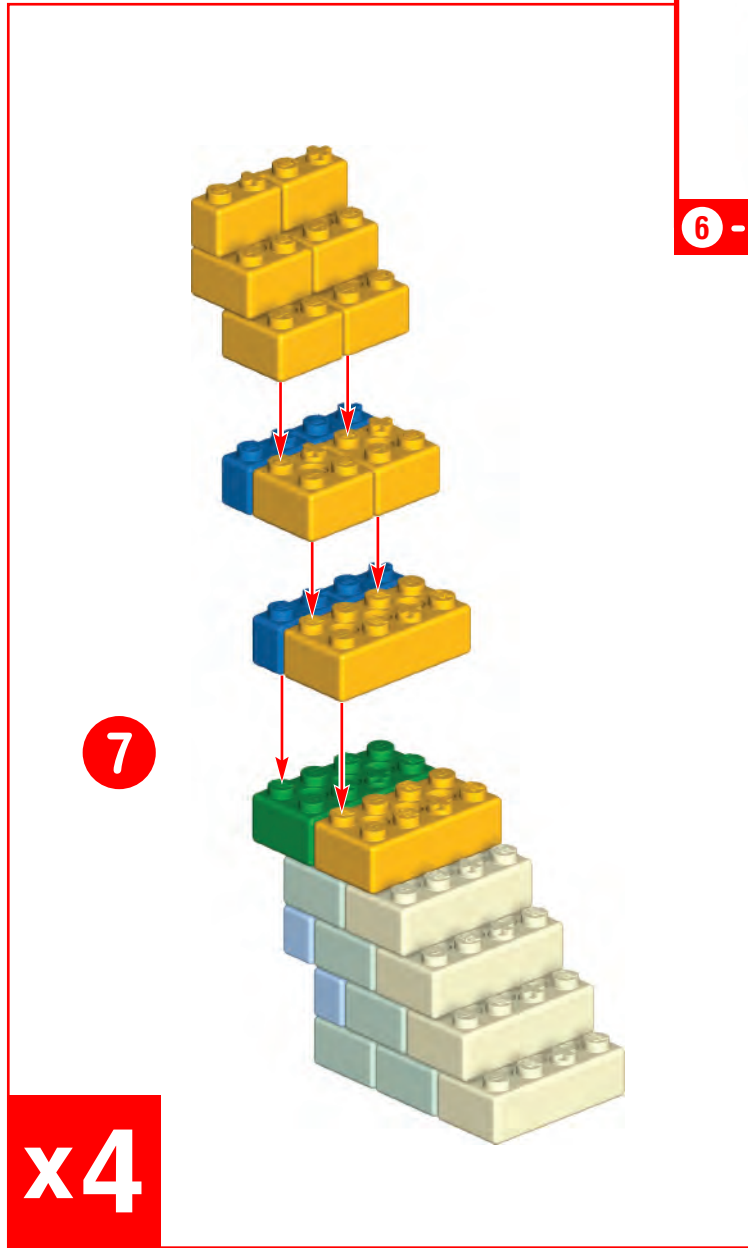
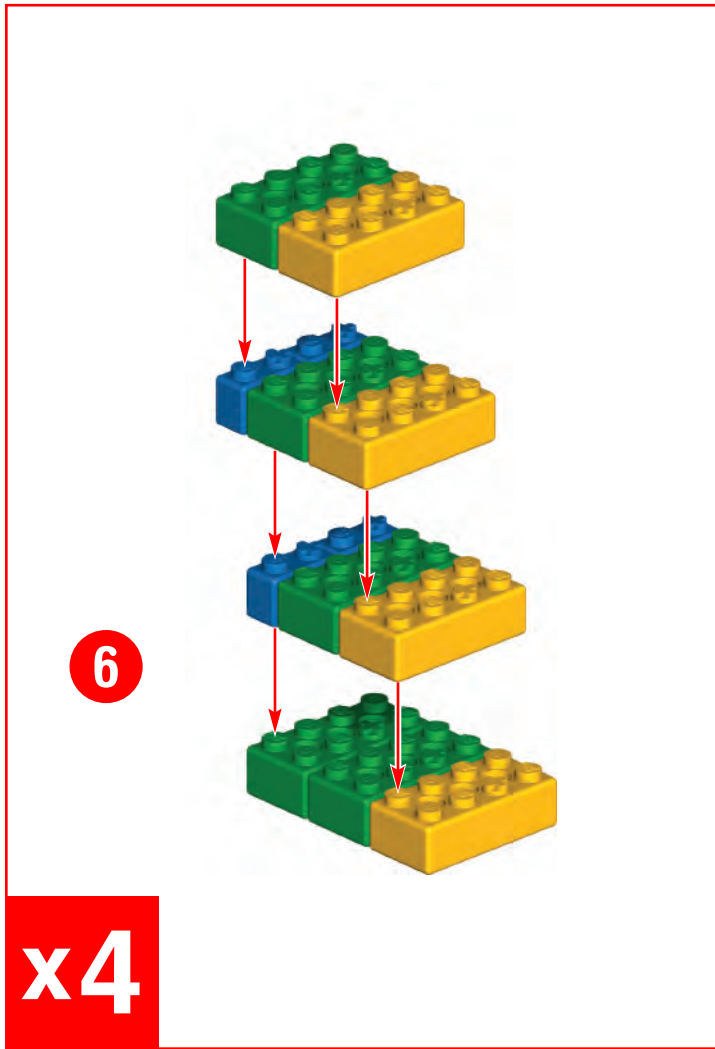

8

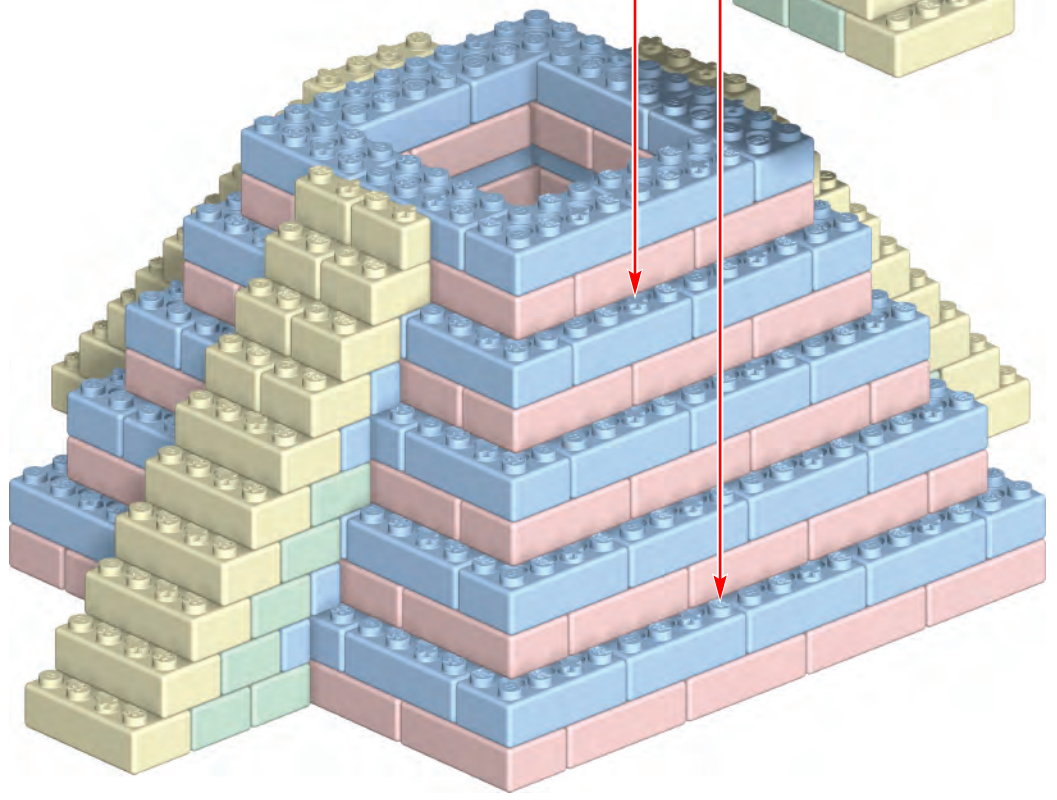
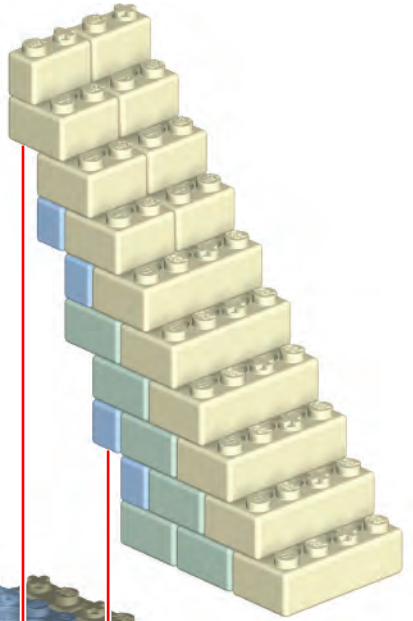

1 - 8

9

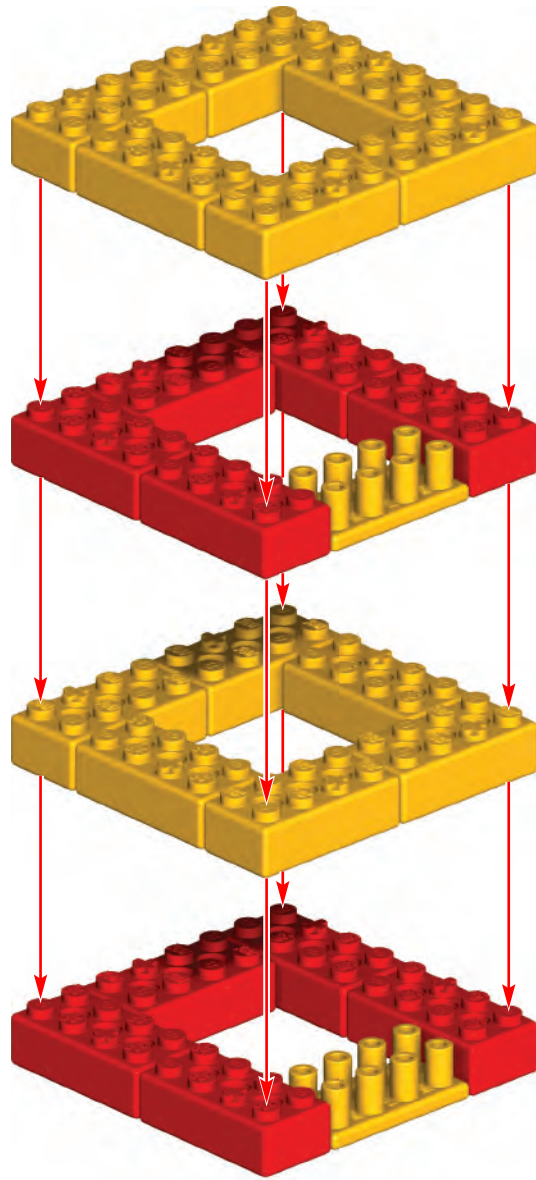

9

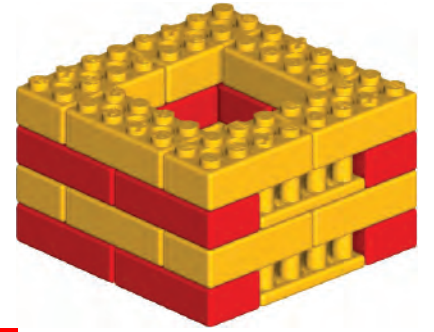

10

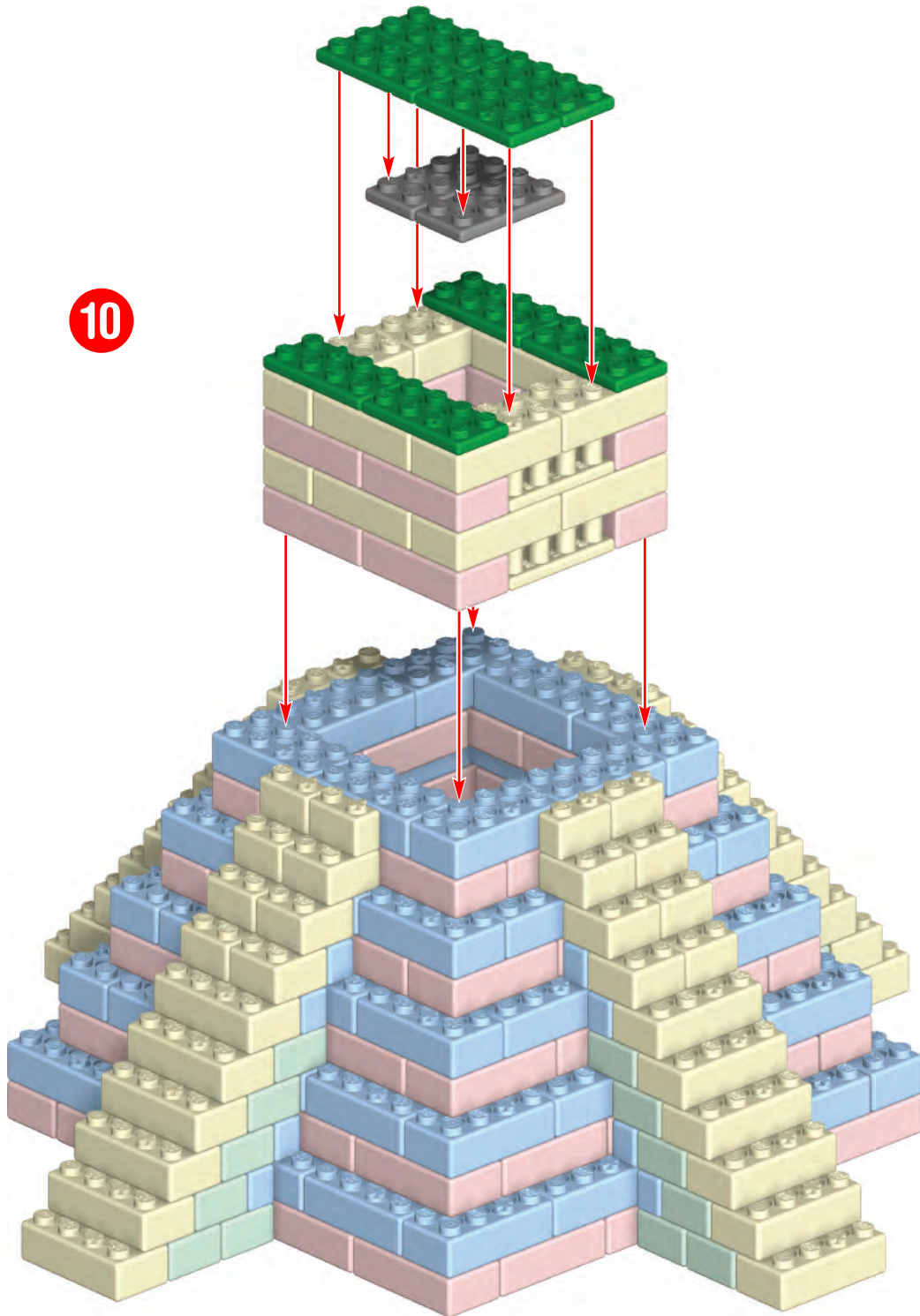

1 - 10

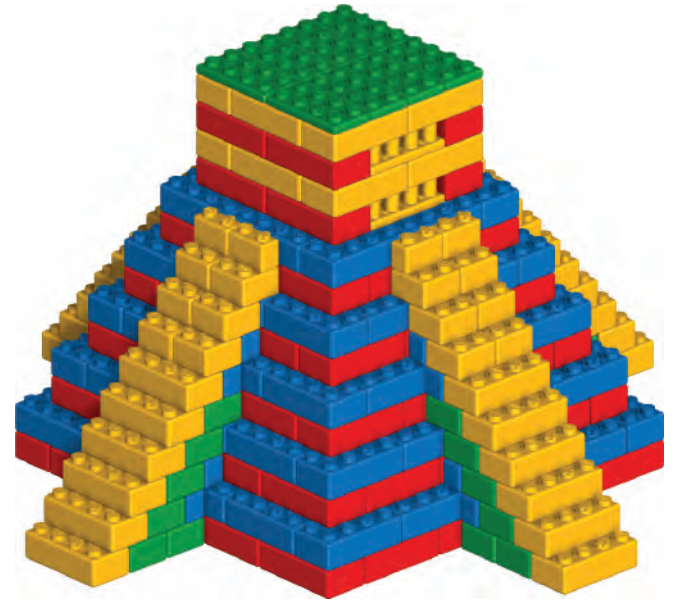

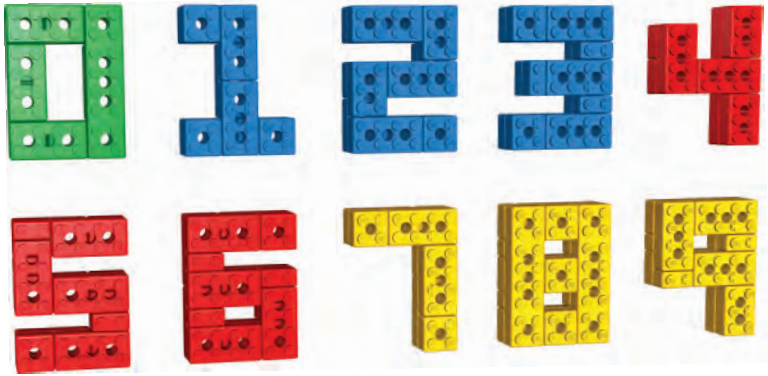

Numbers

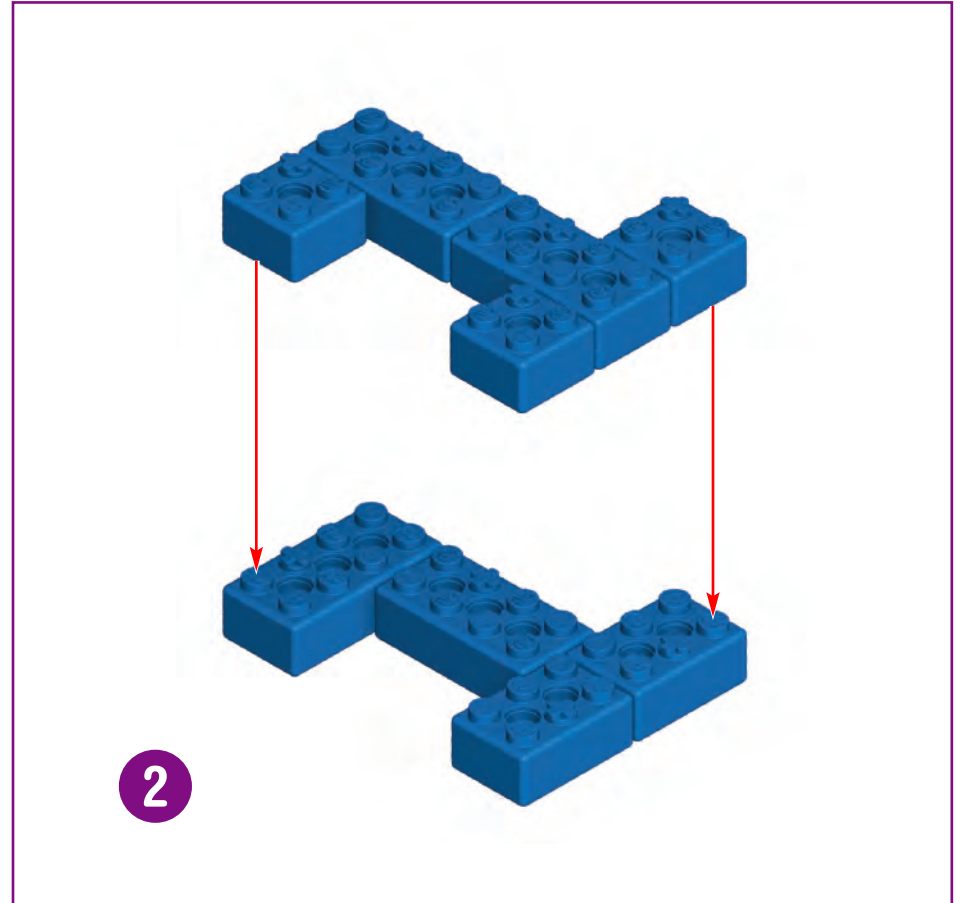
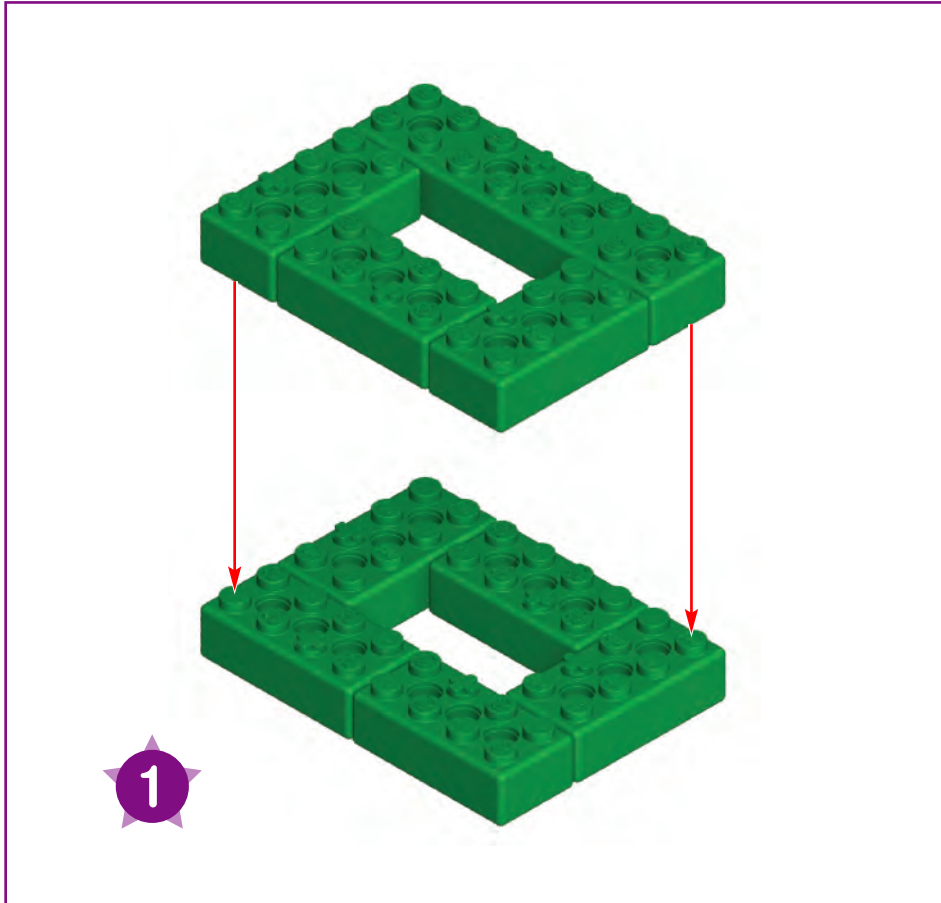
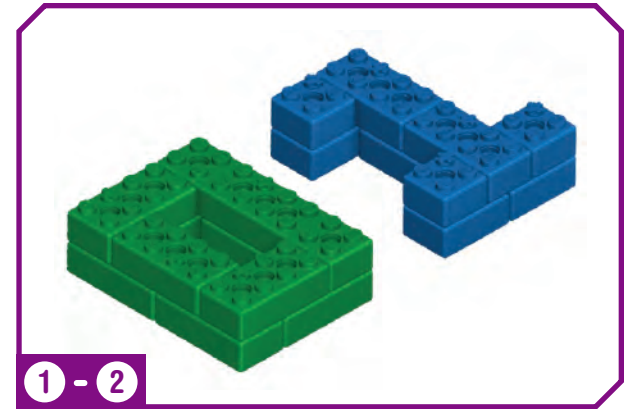

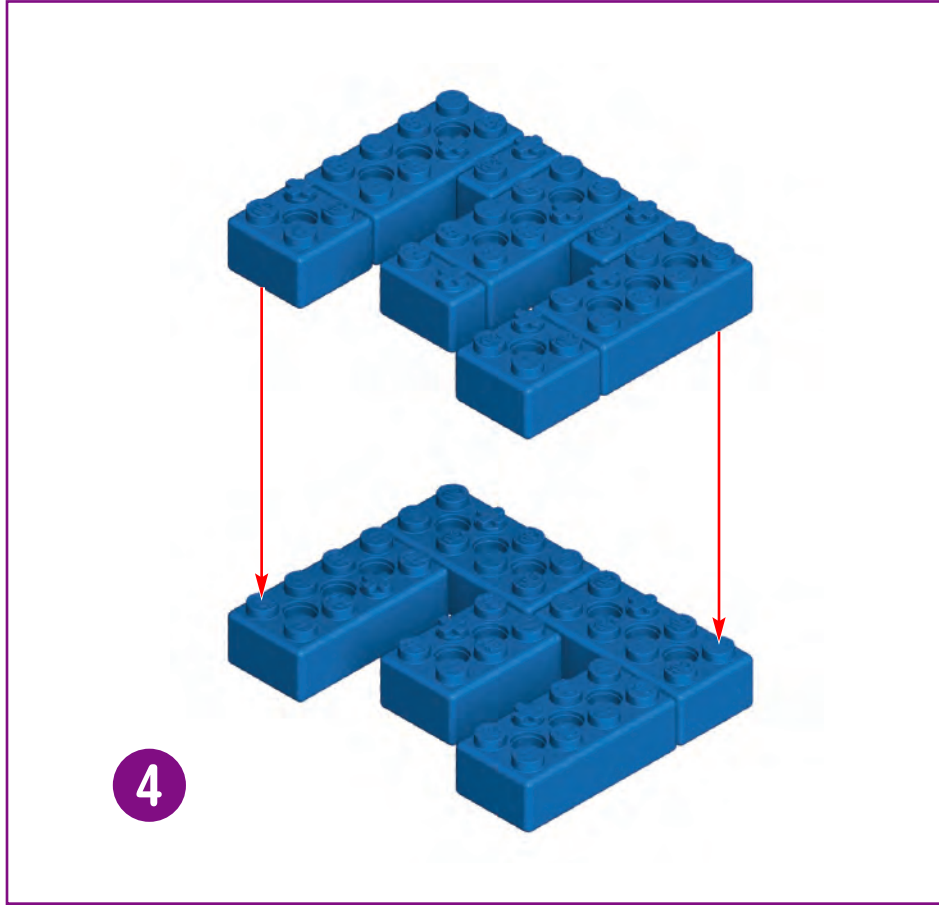
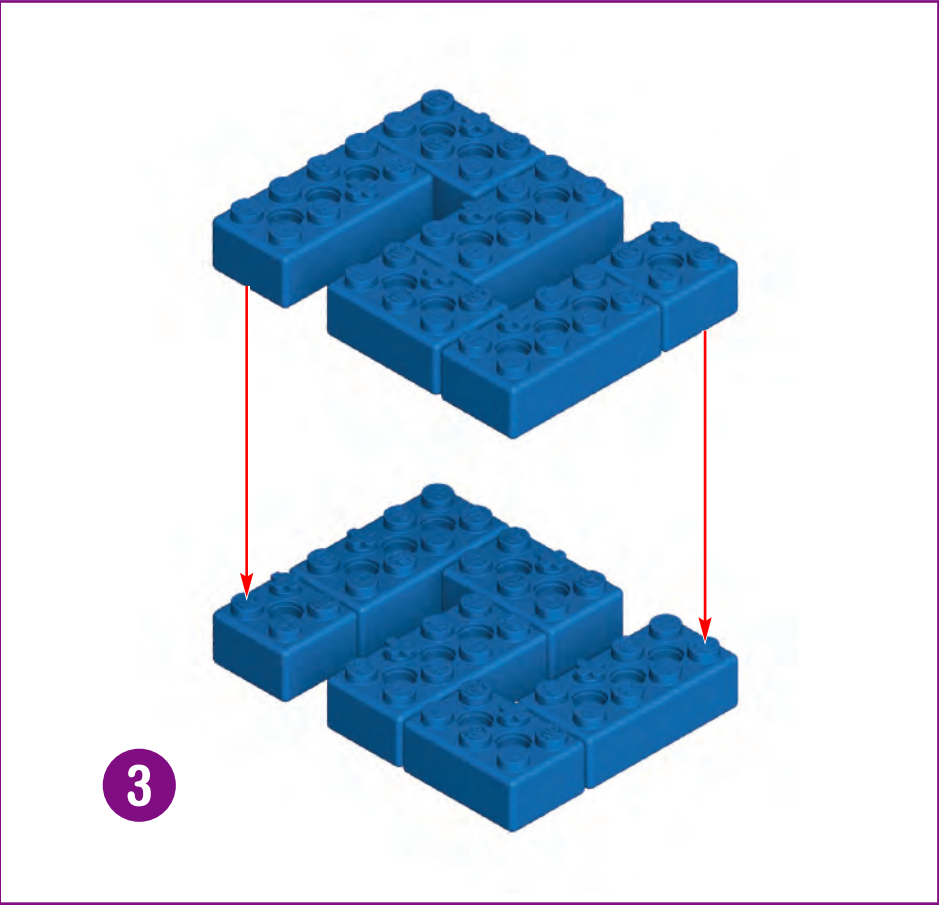
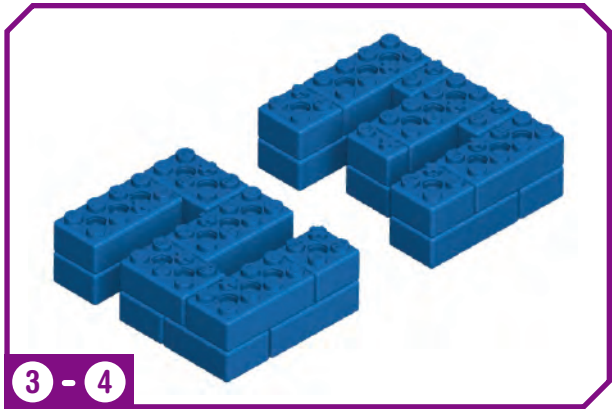

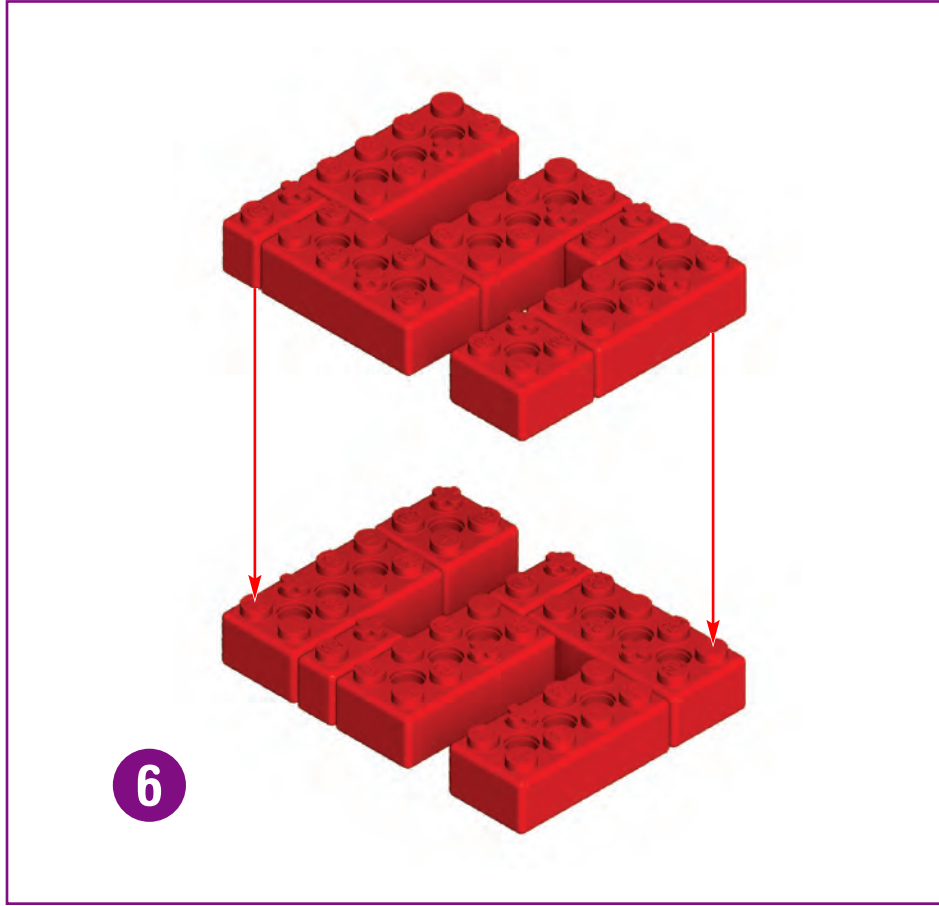
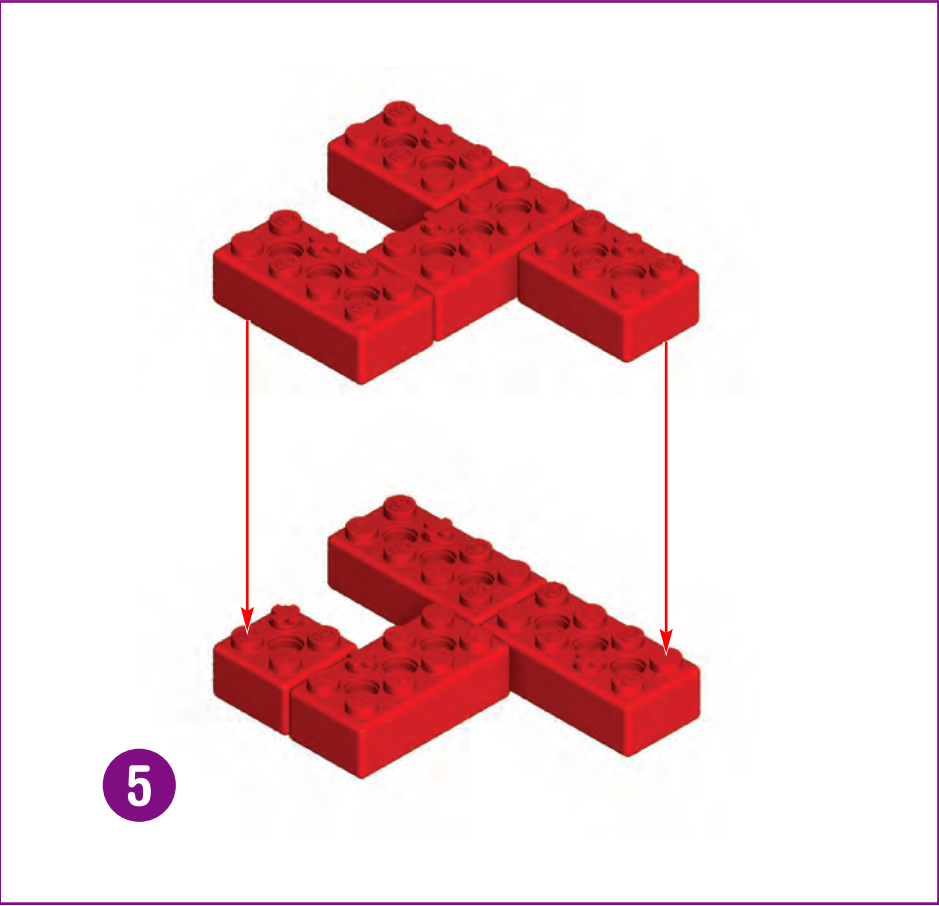
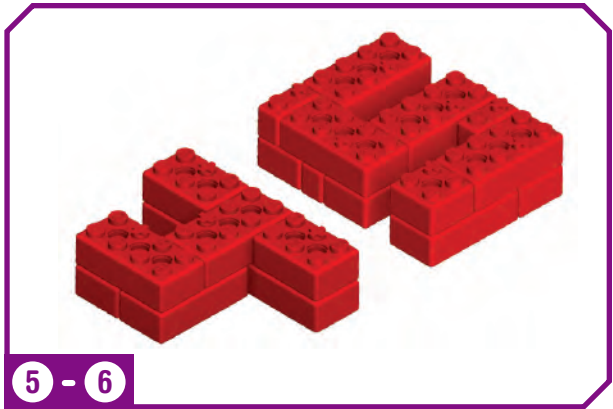

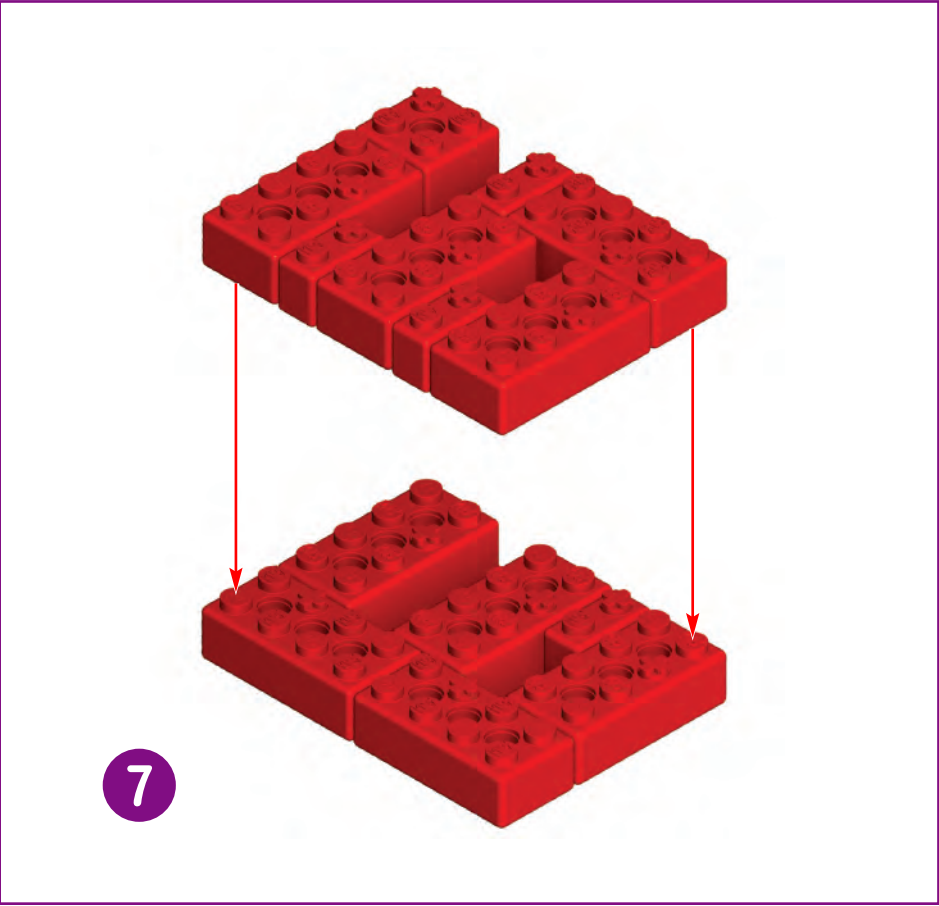
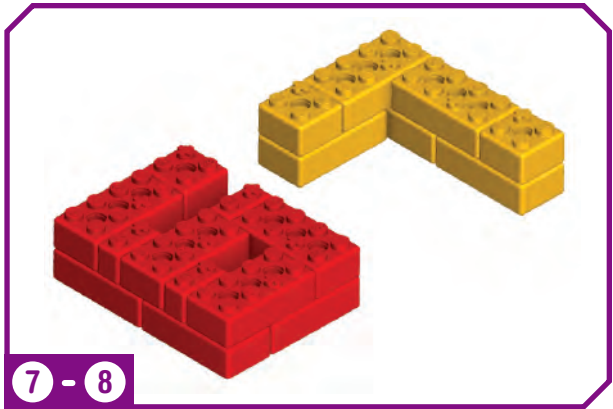

7

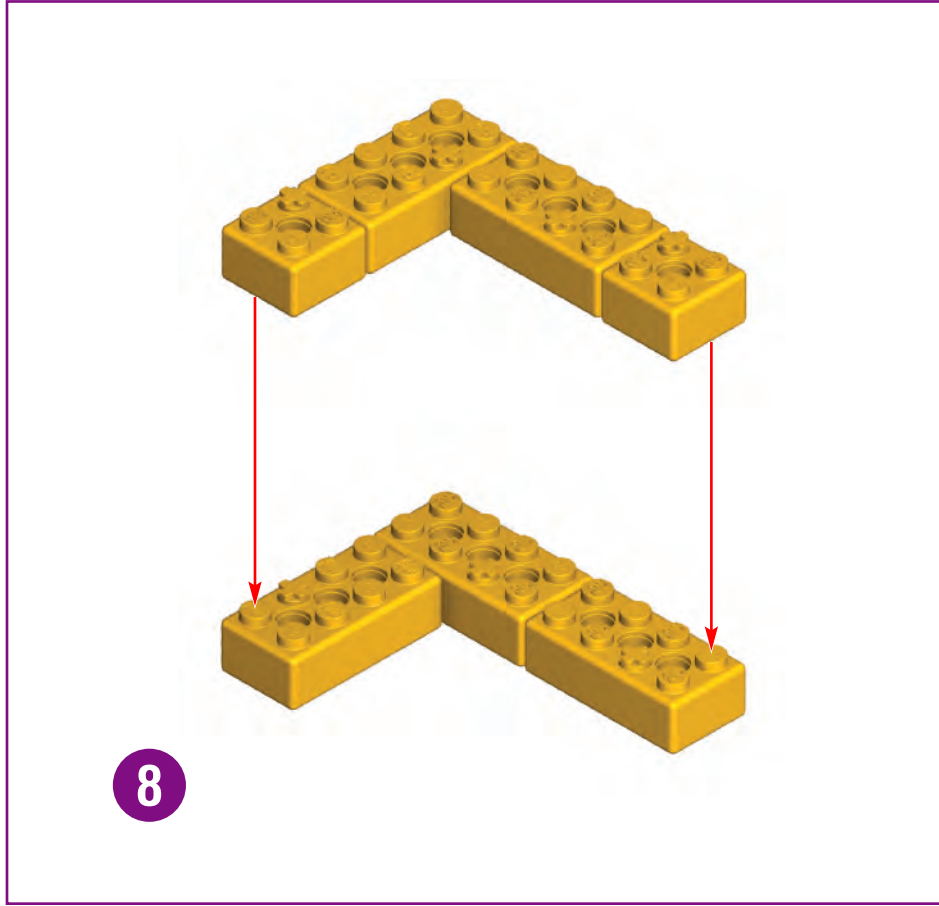

8

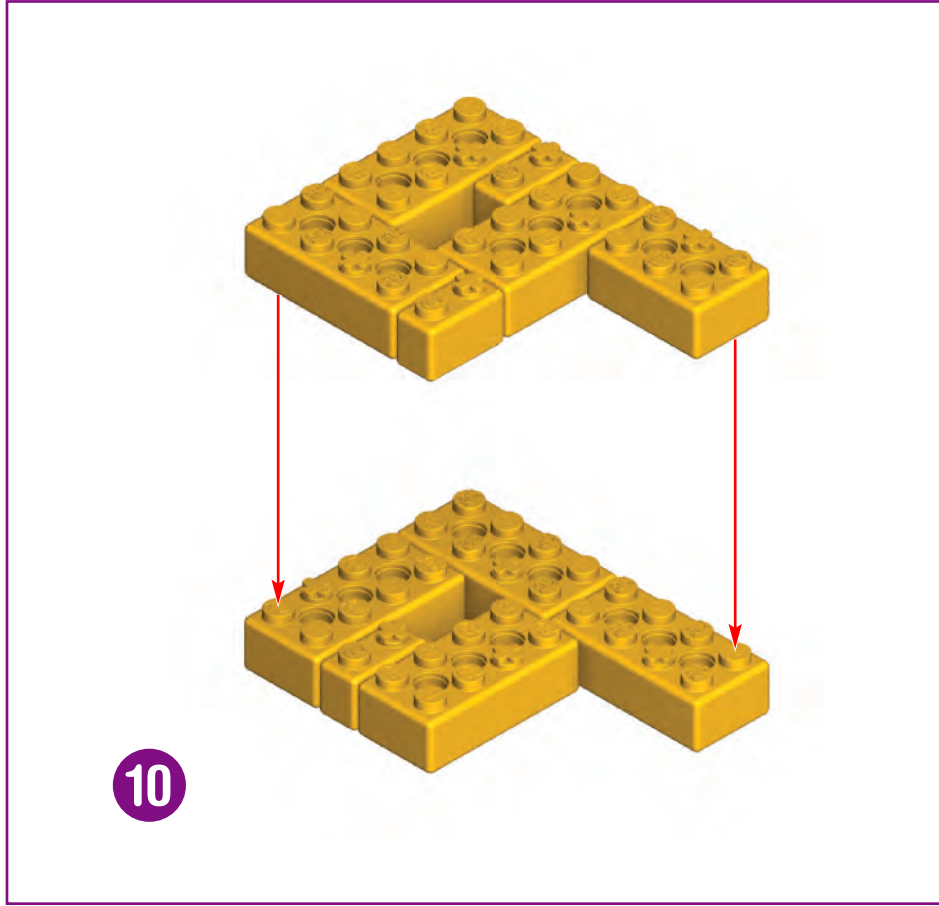
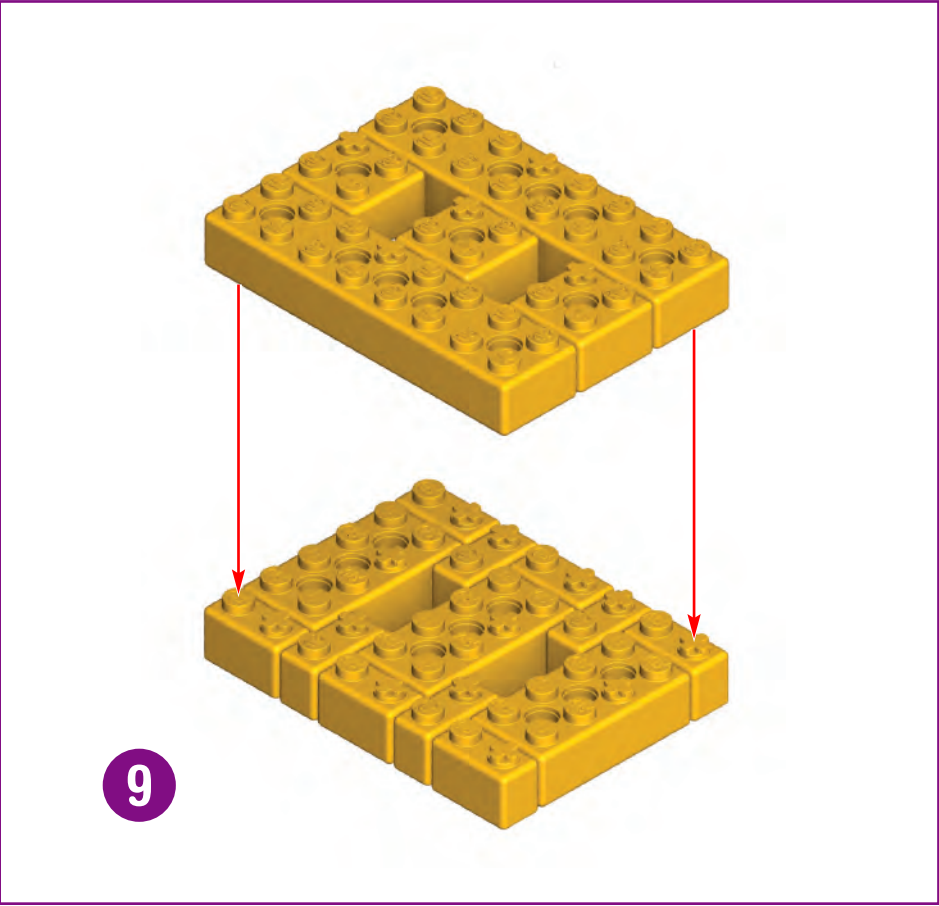
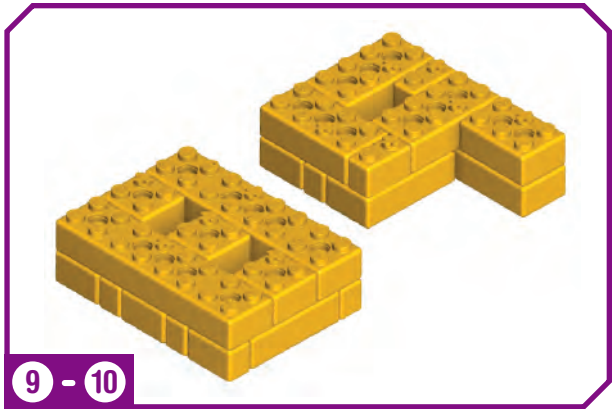



Tyrannosaurus Rex

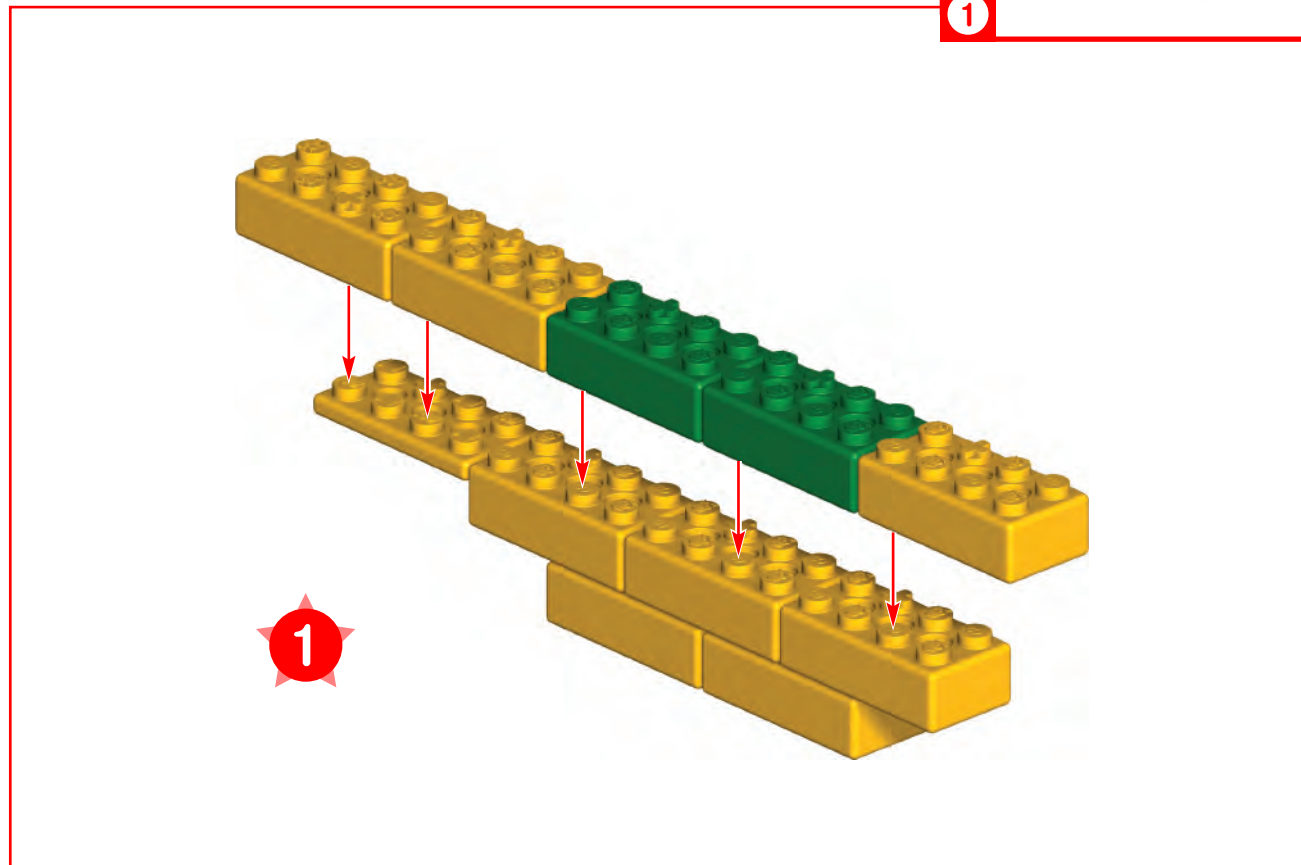
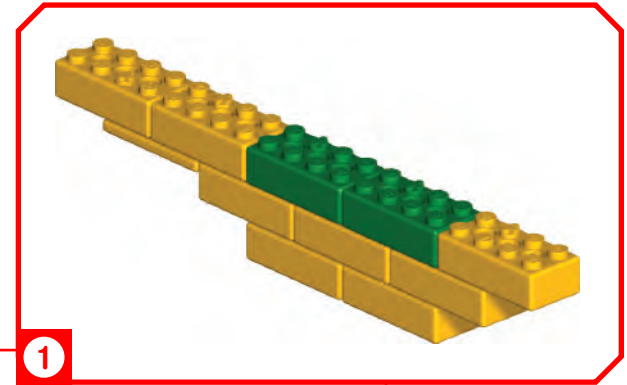

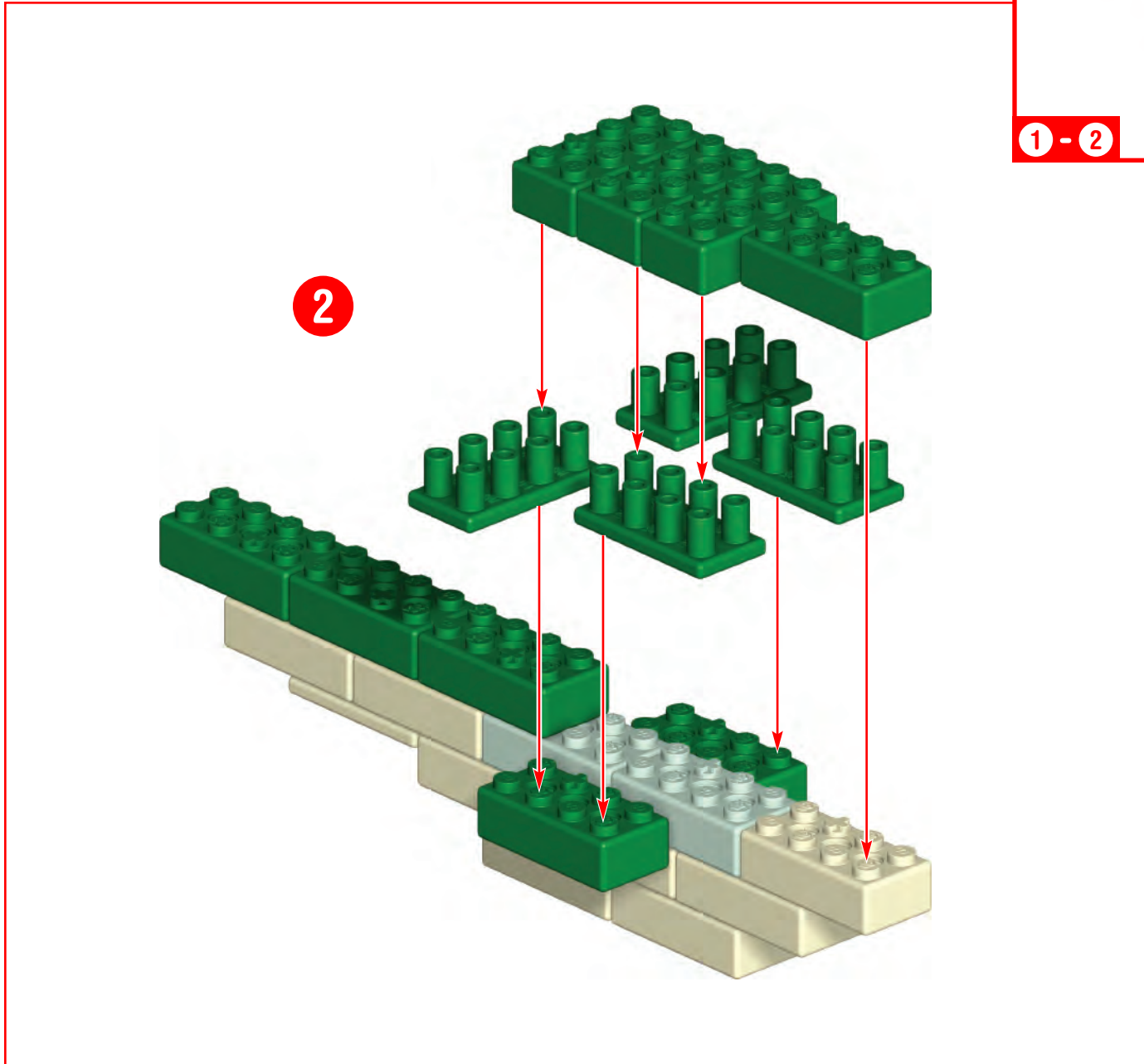
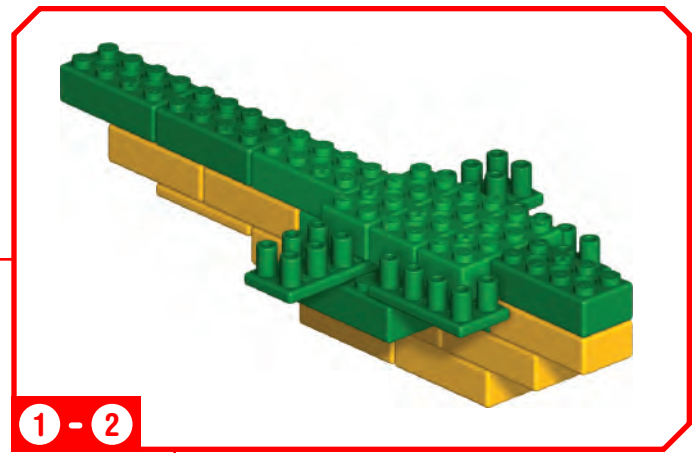

x2

3

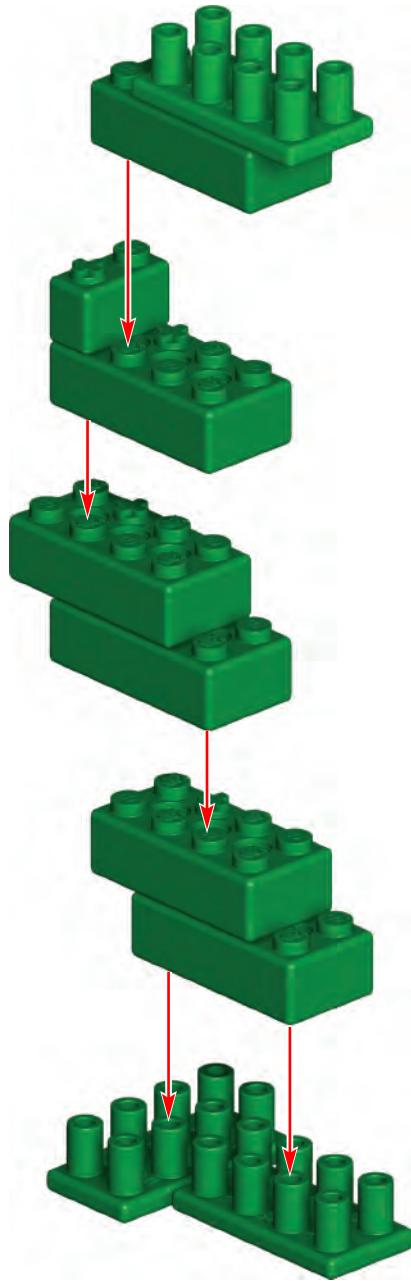

3

x2

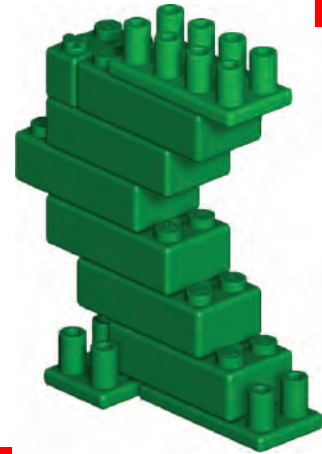

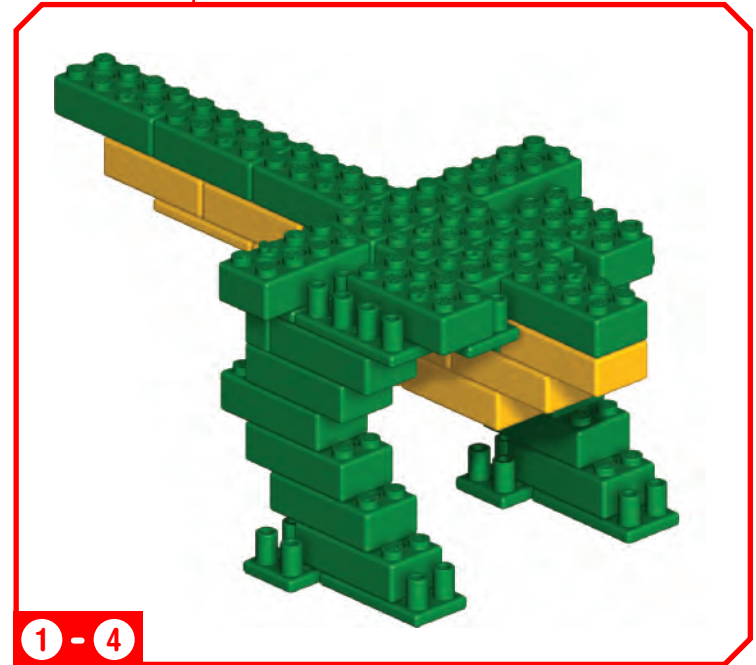
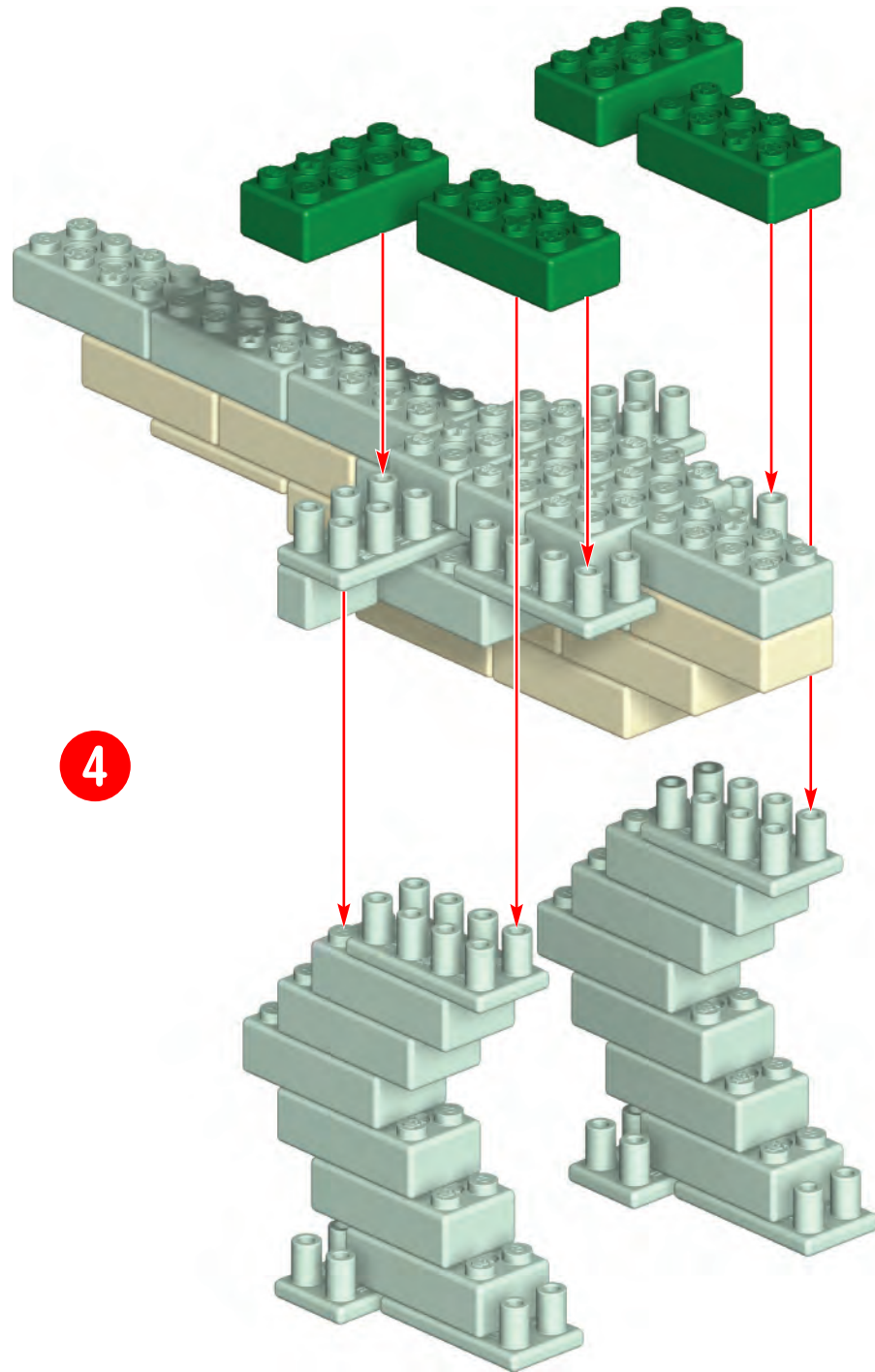

5

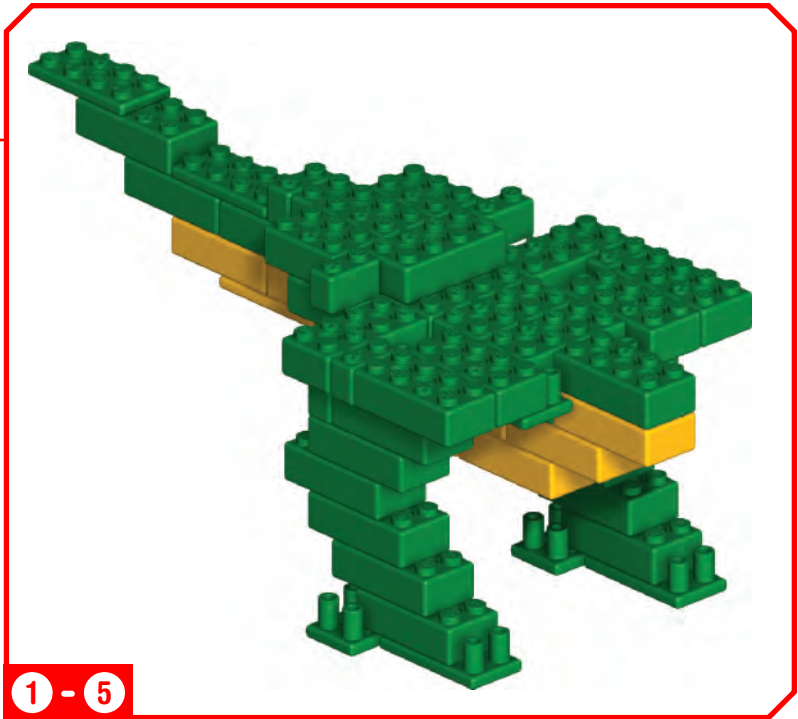
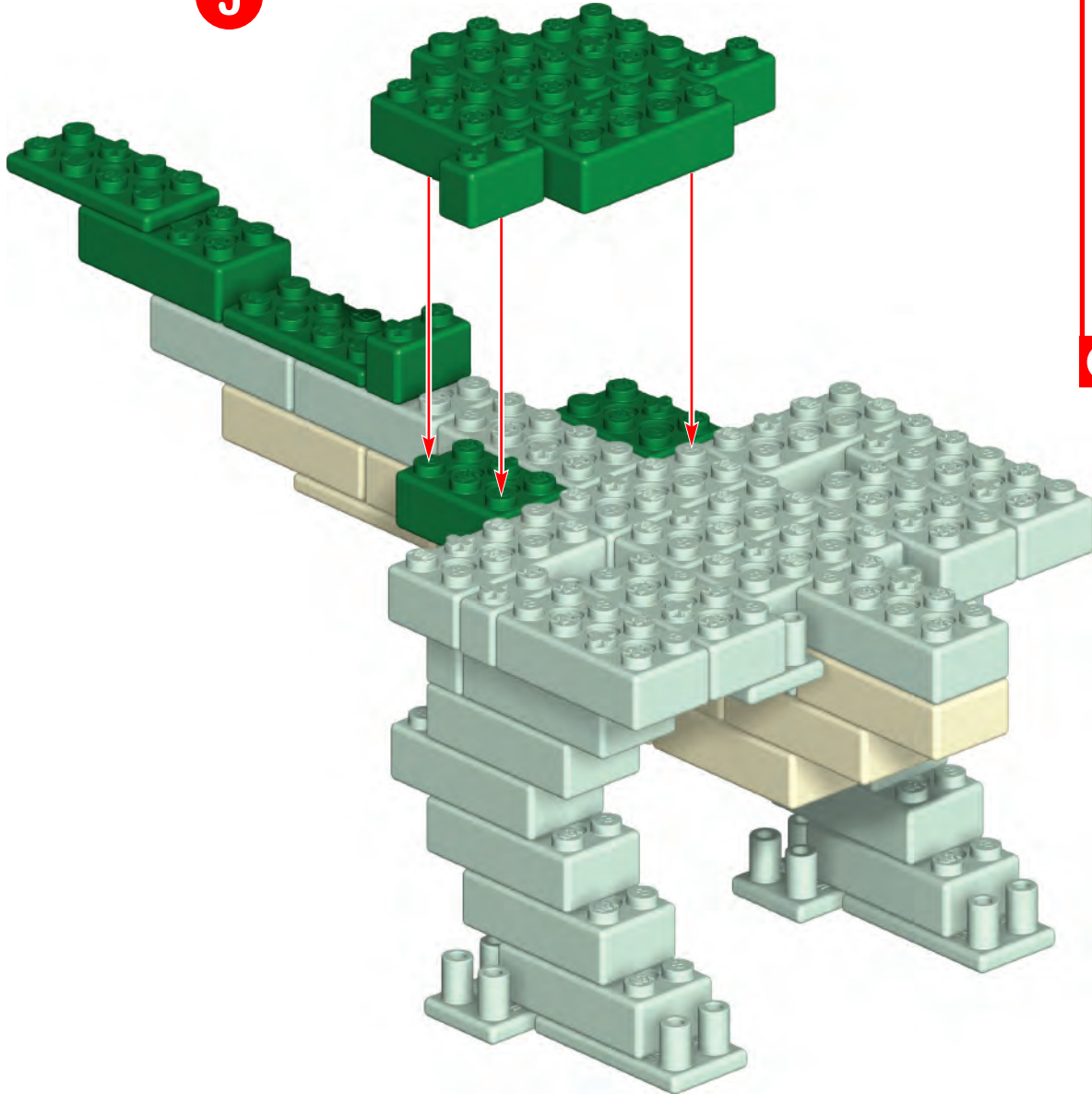

6

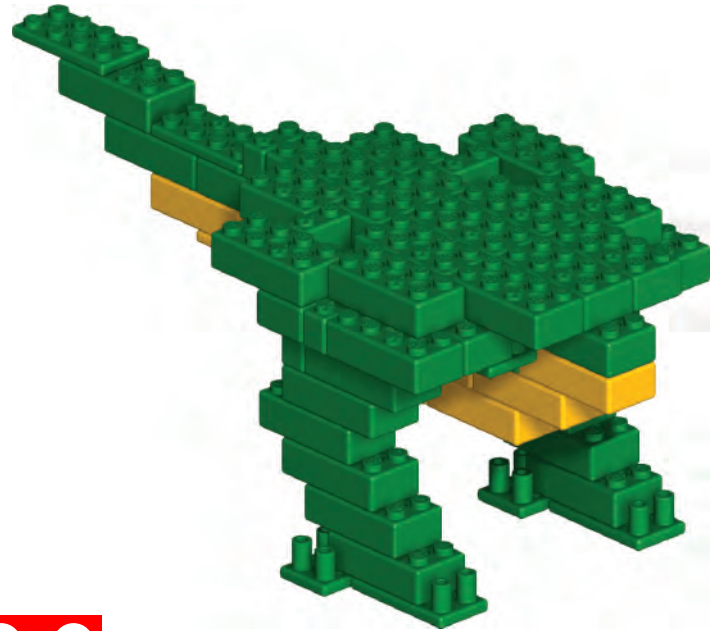
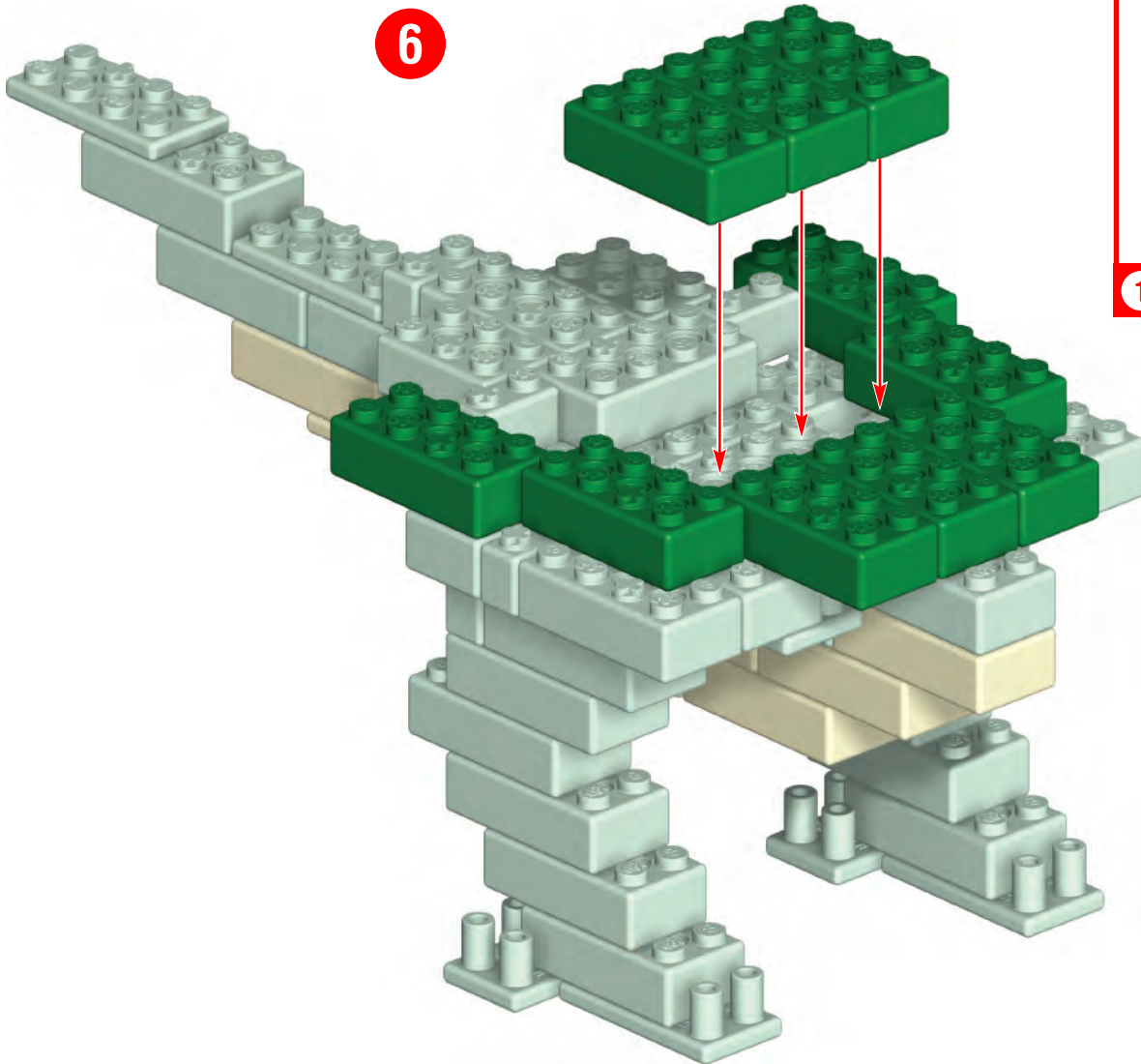

1 - 6

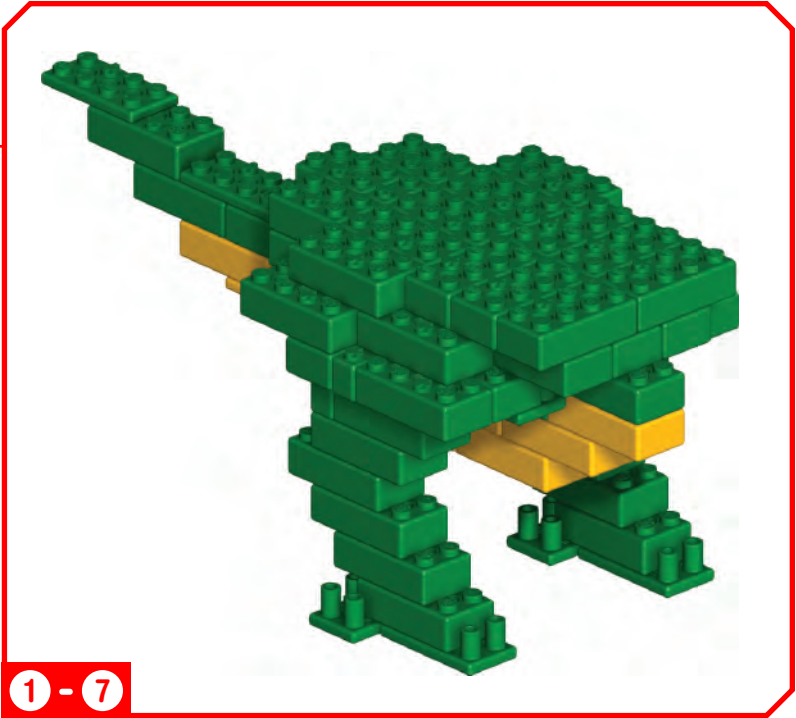
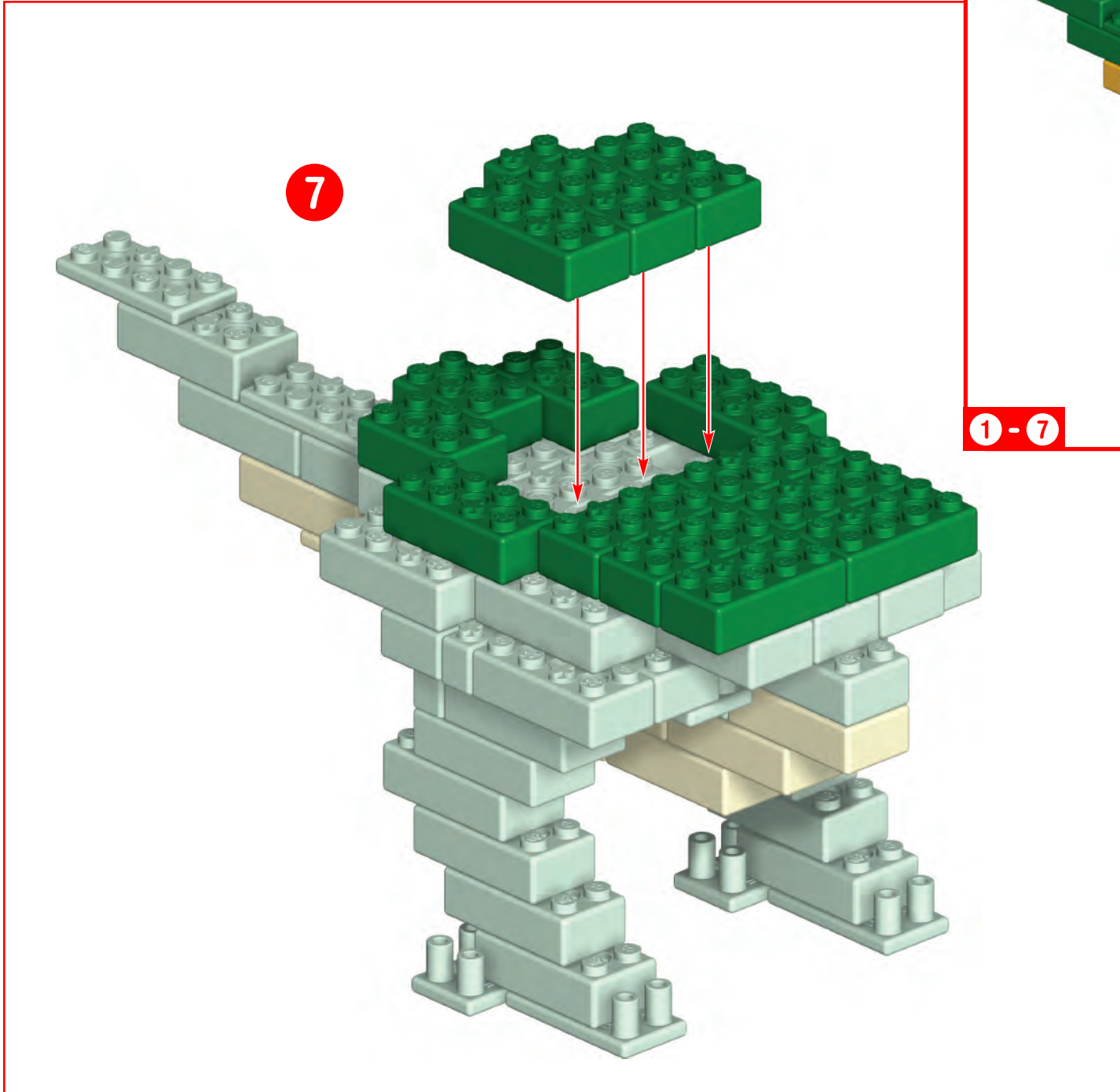

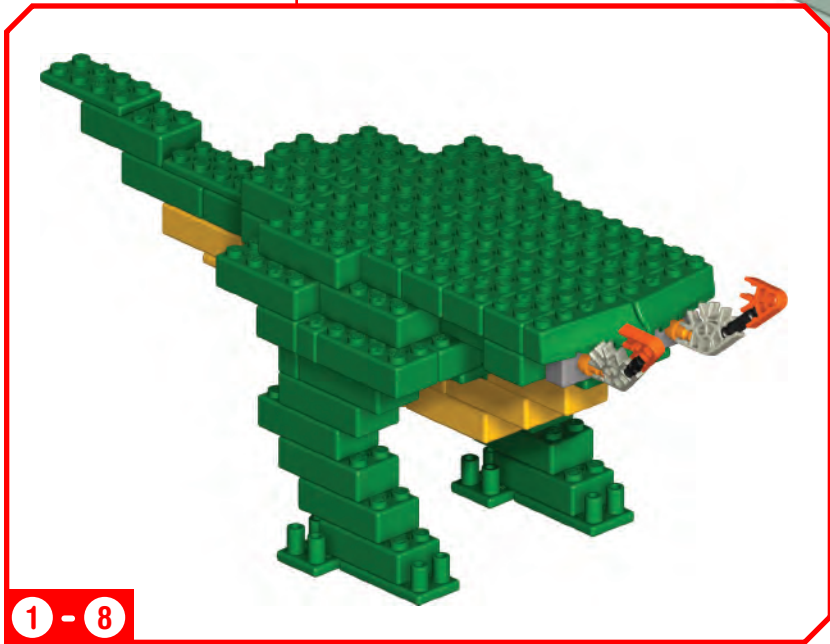
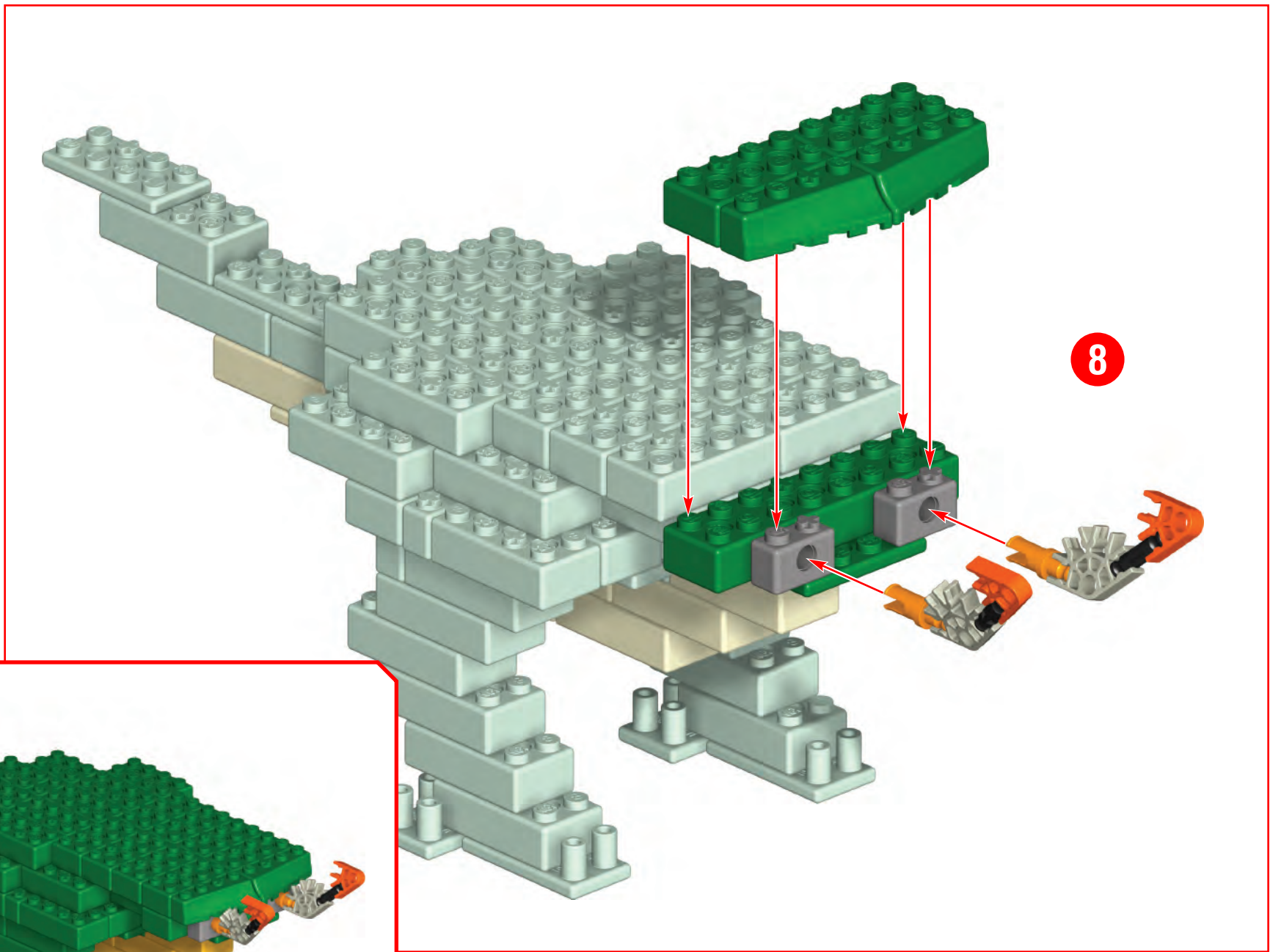

1 - 8

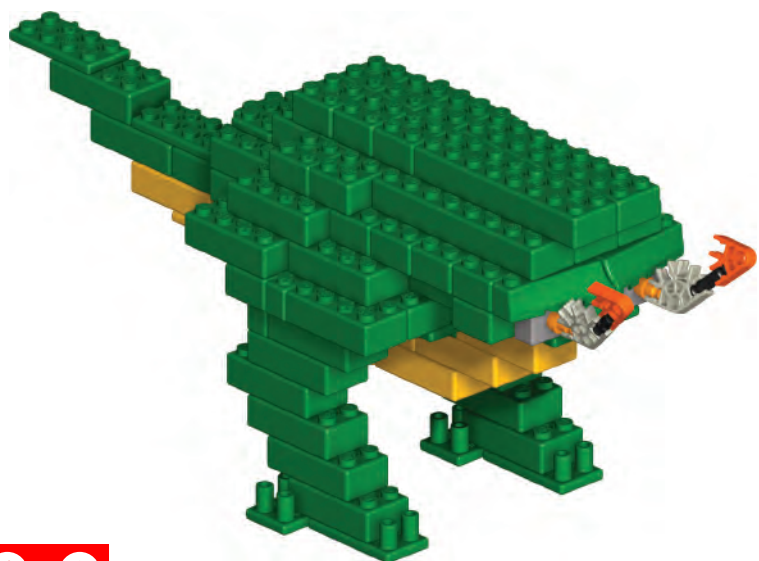
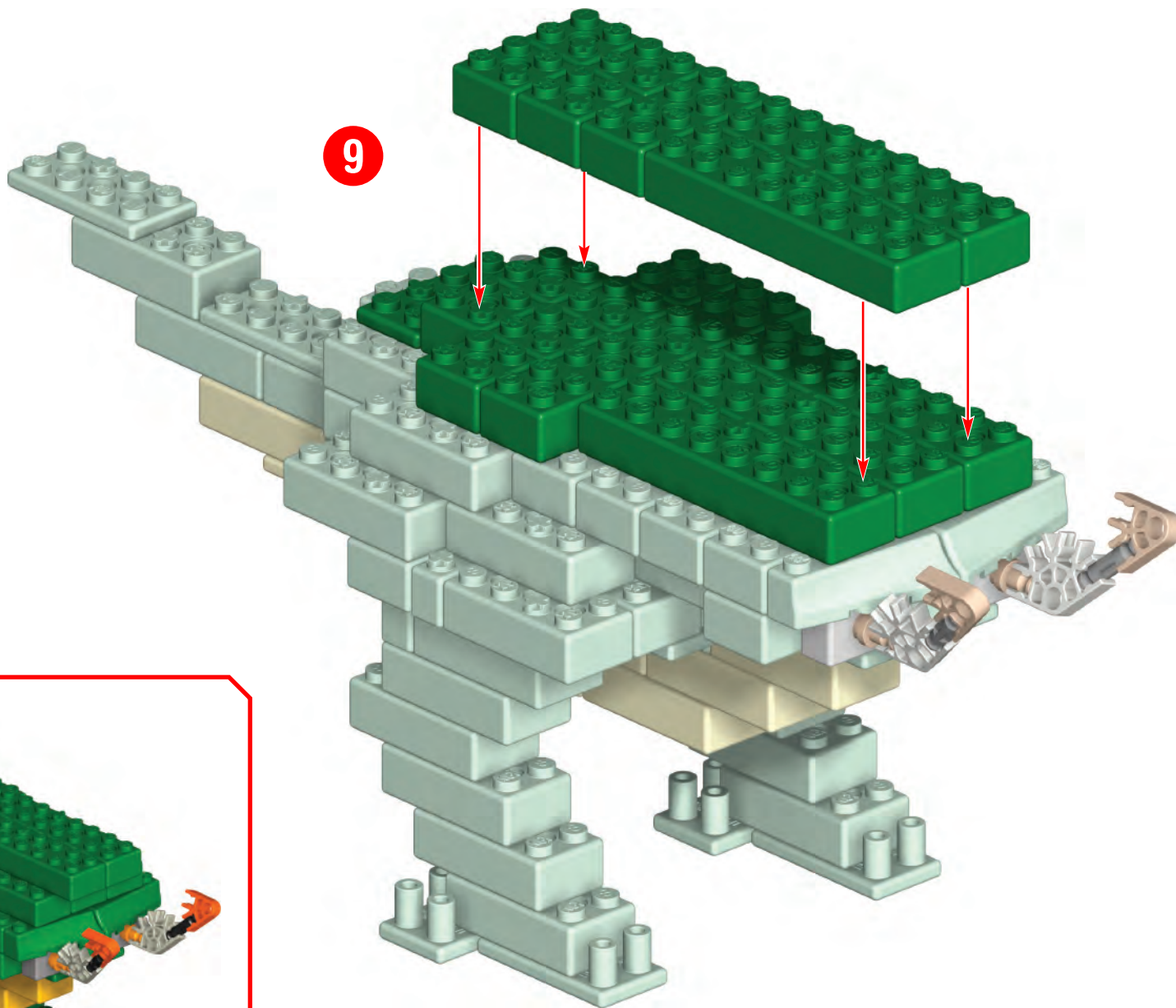

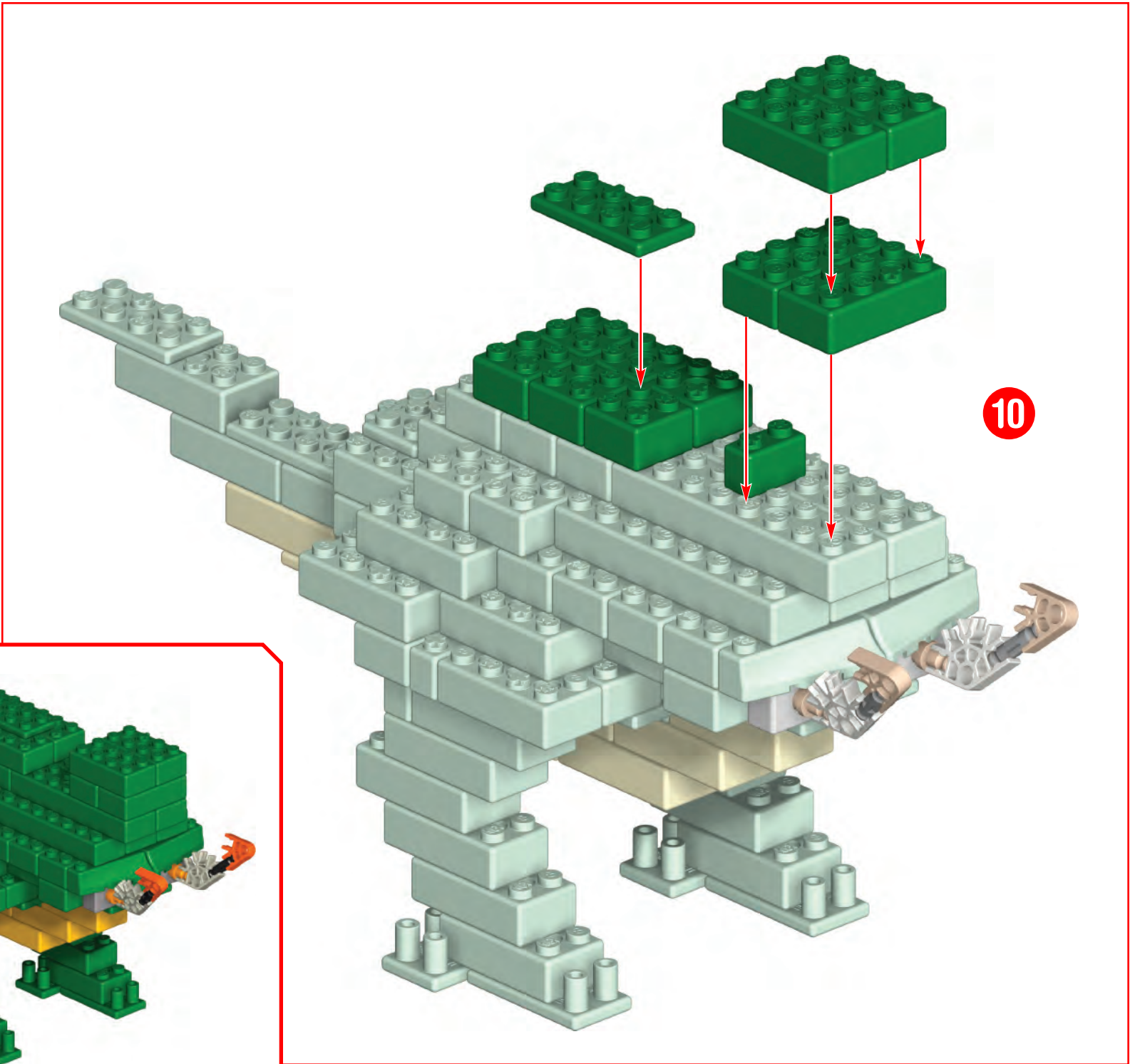
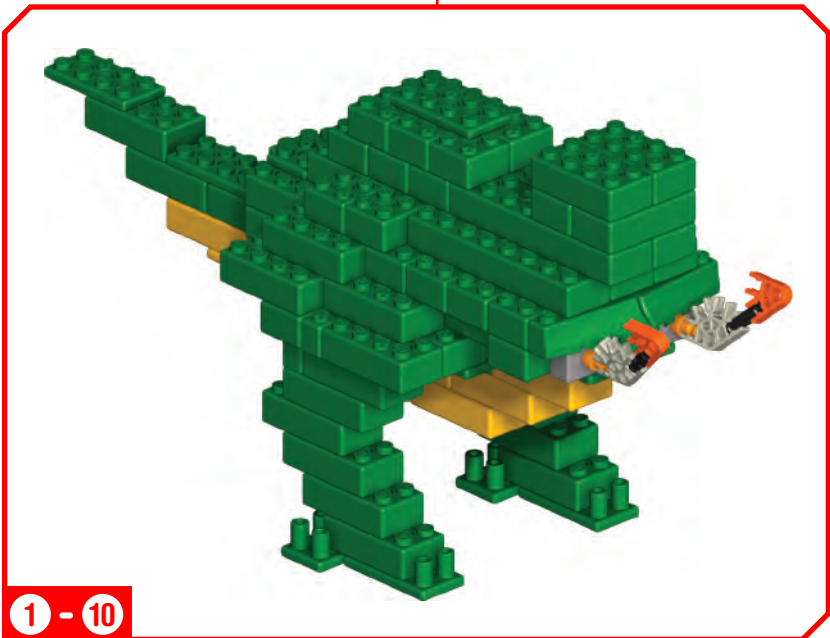

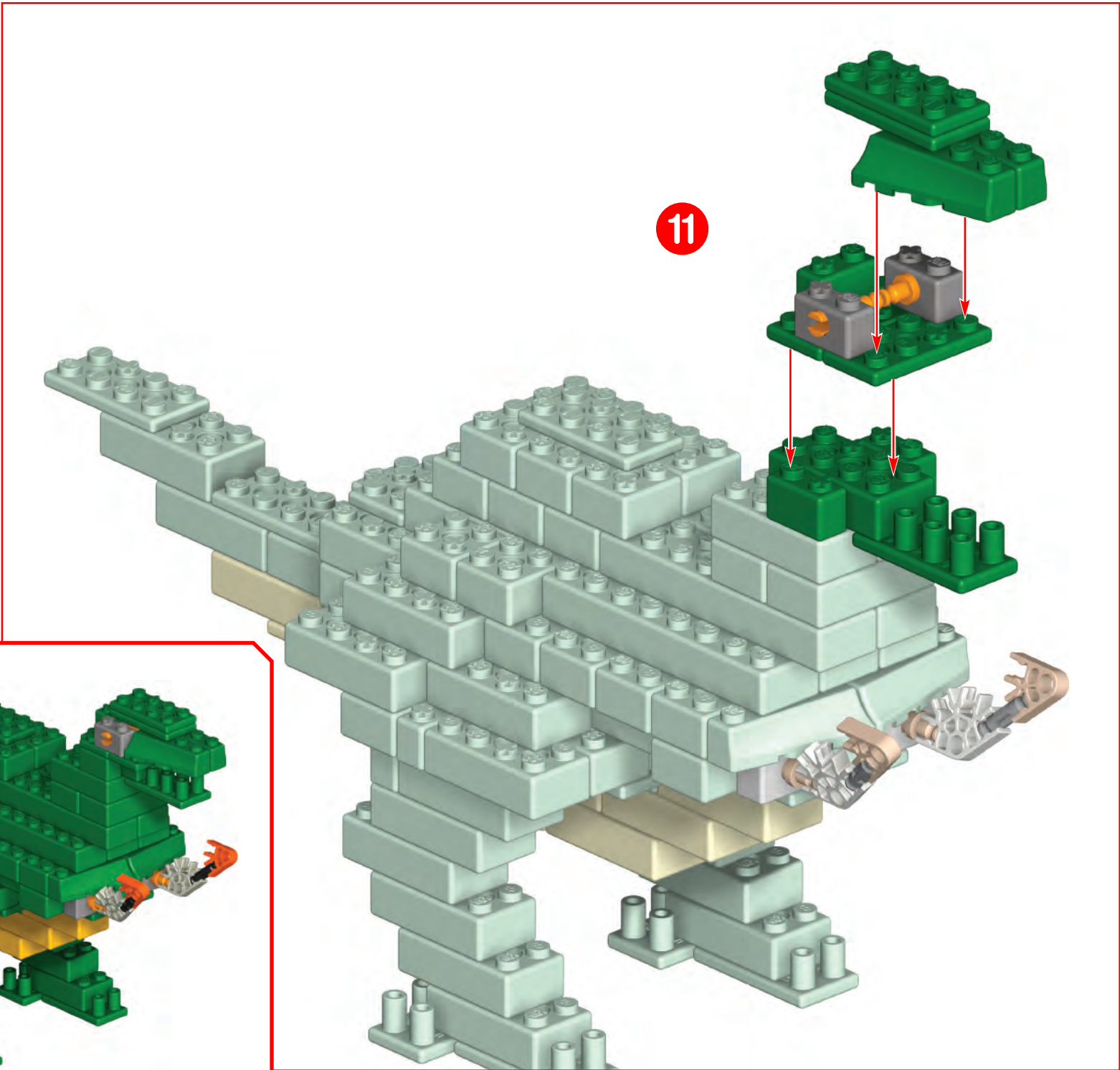
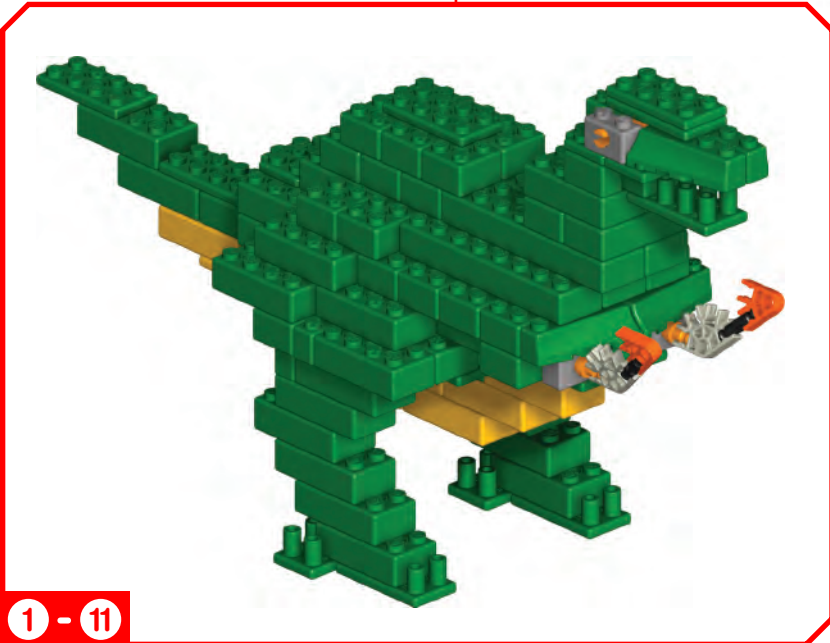

Tow Truck

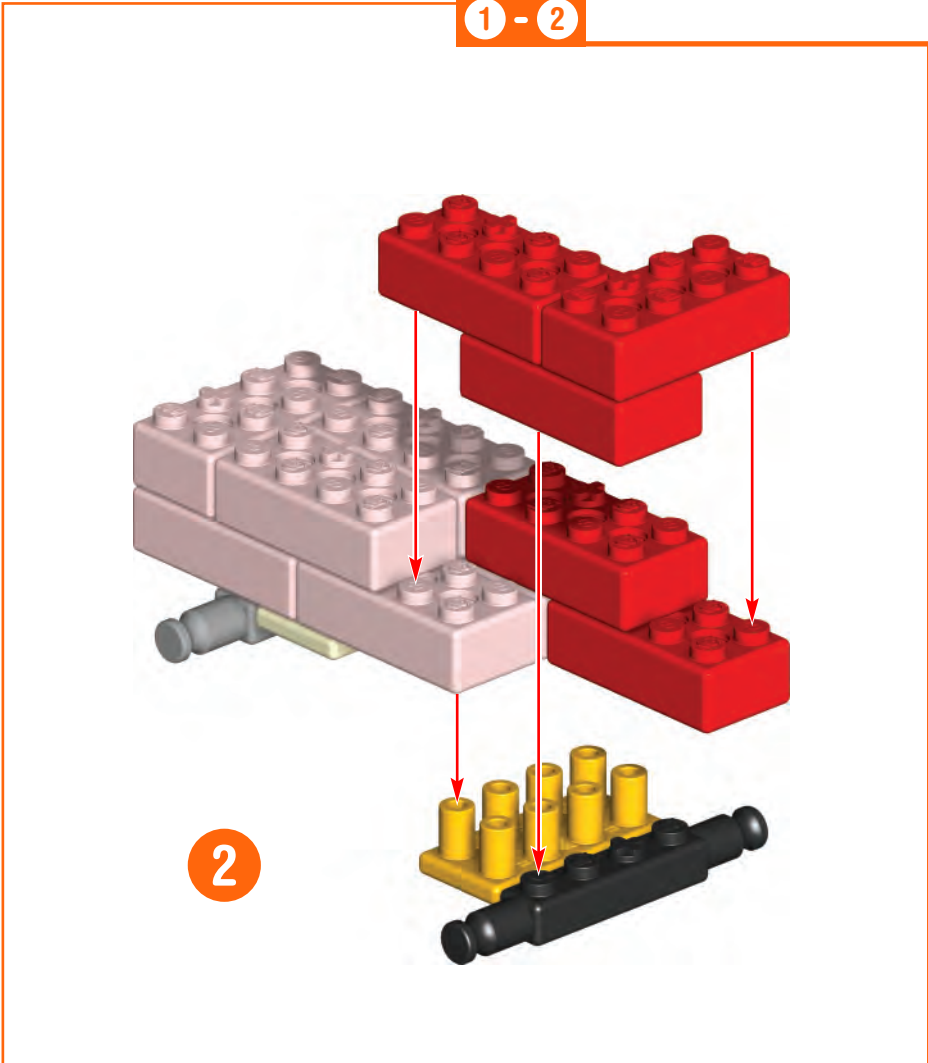
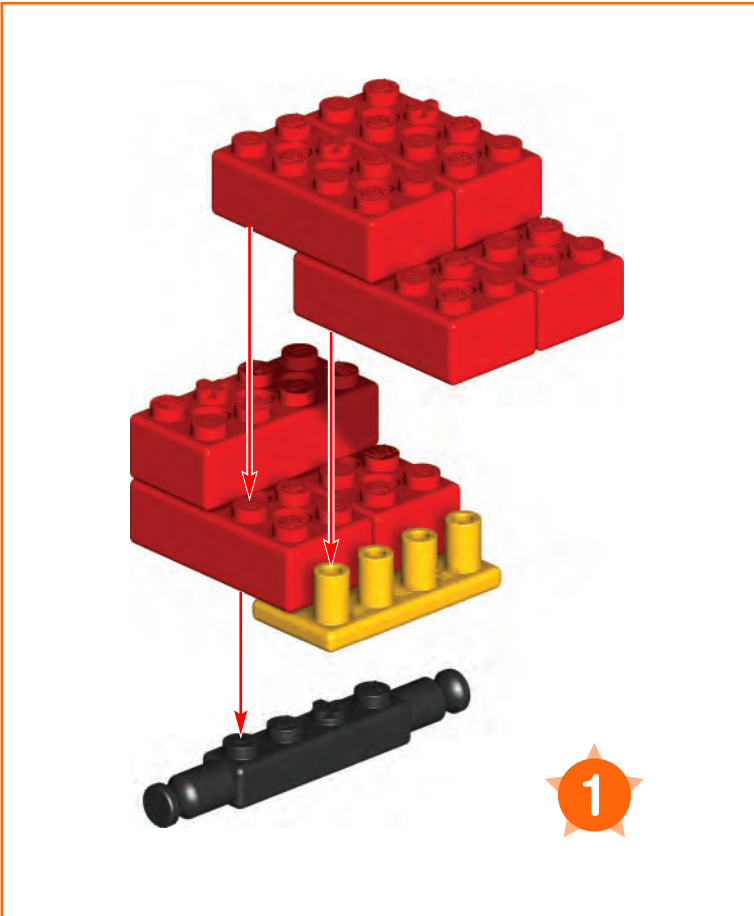
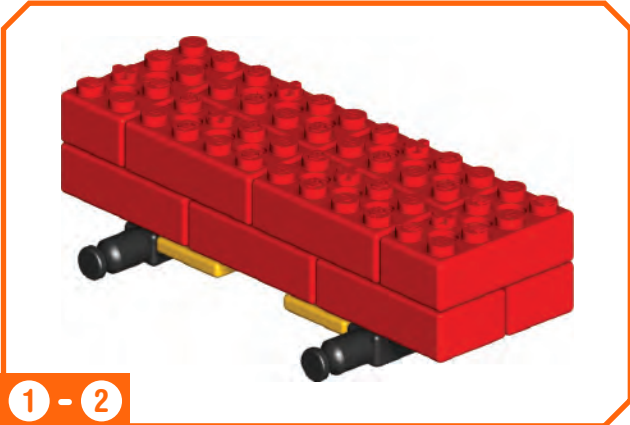



3

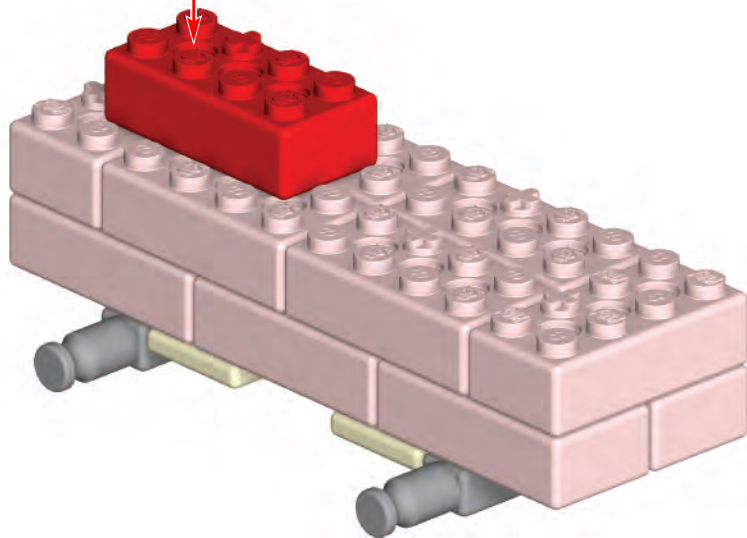

1 - 3

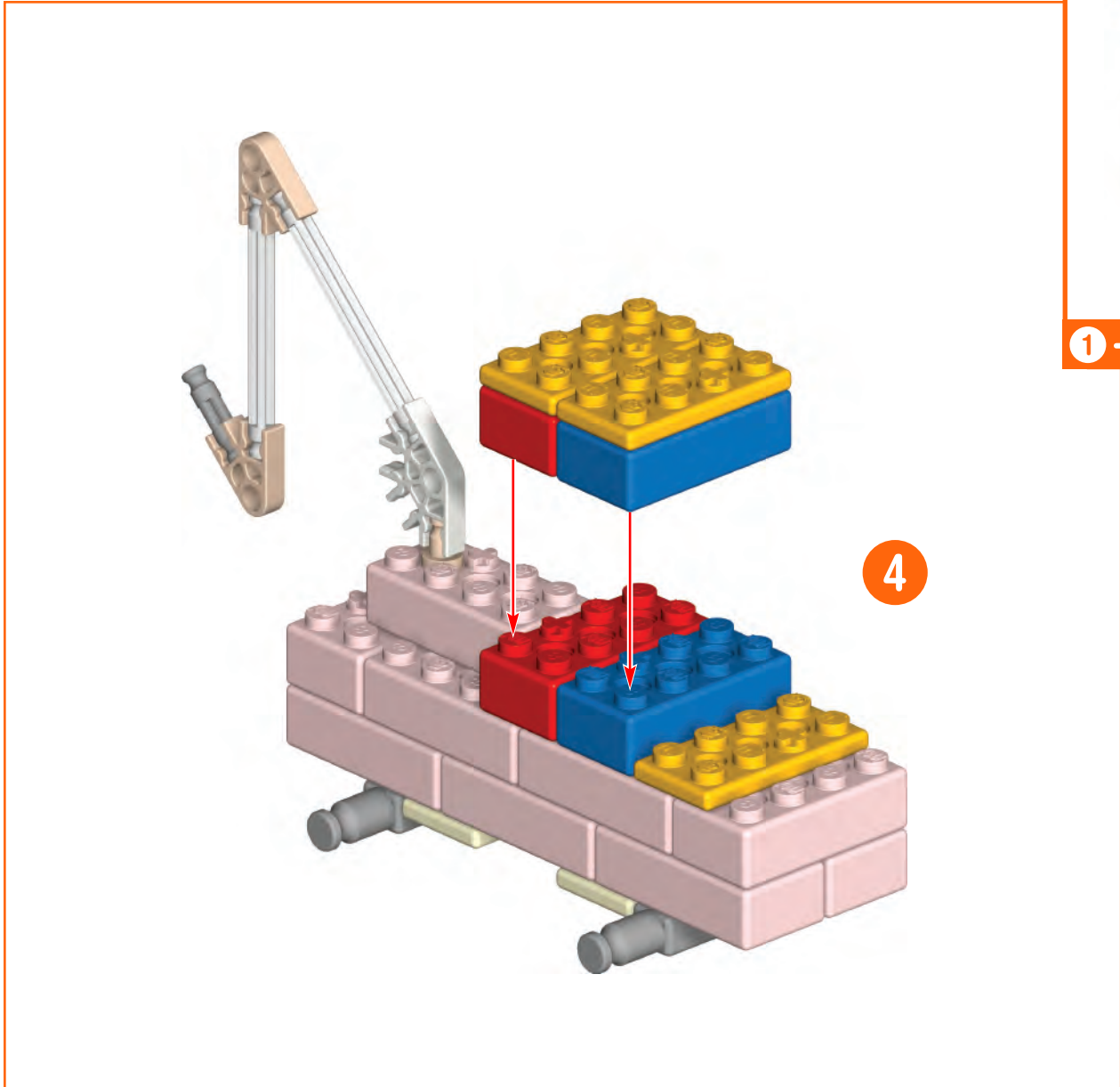

1 - 4



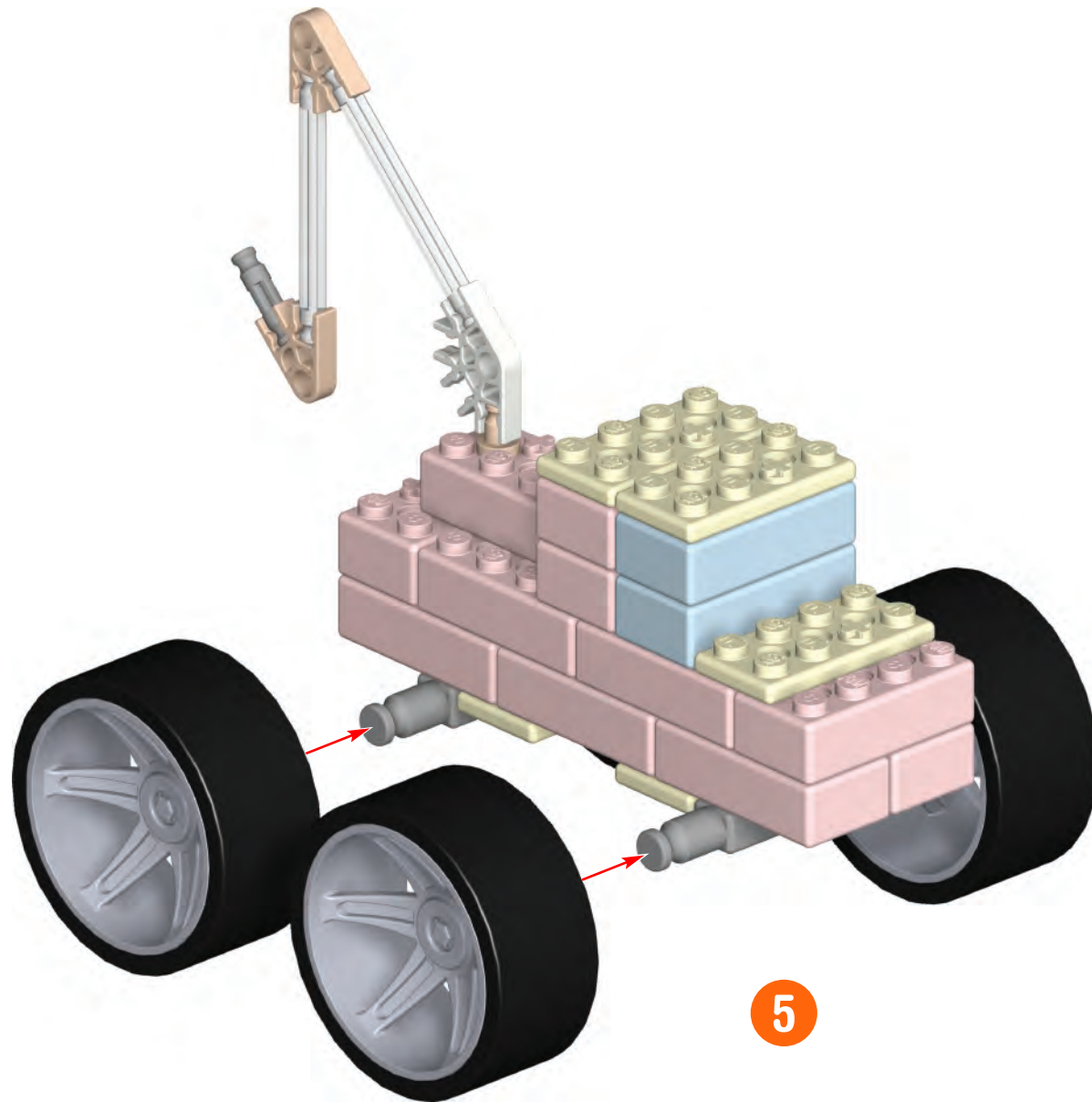

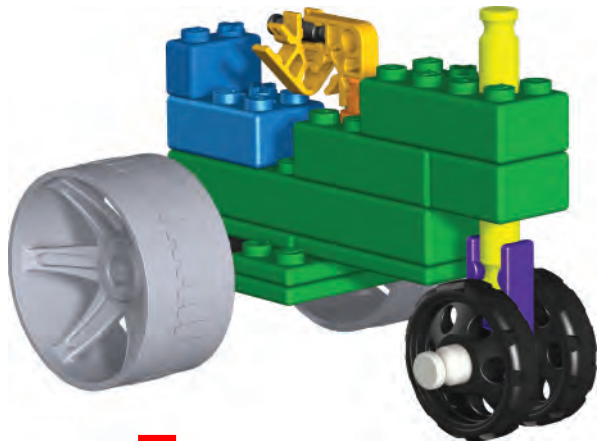

Farm Tractor

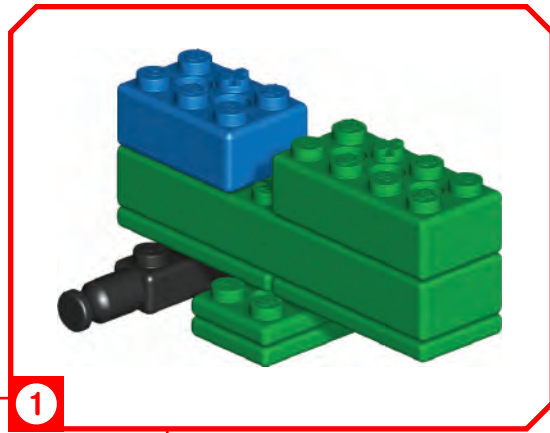

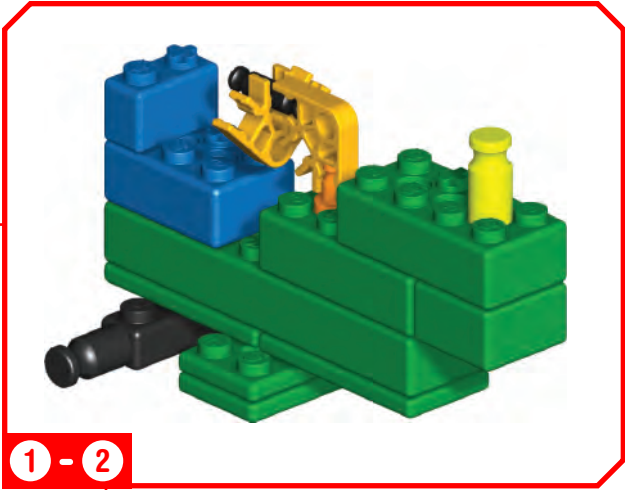
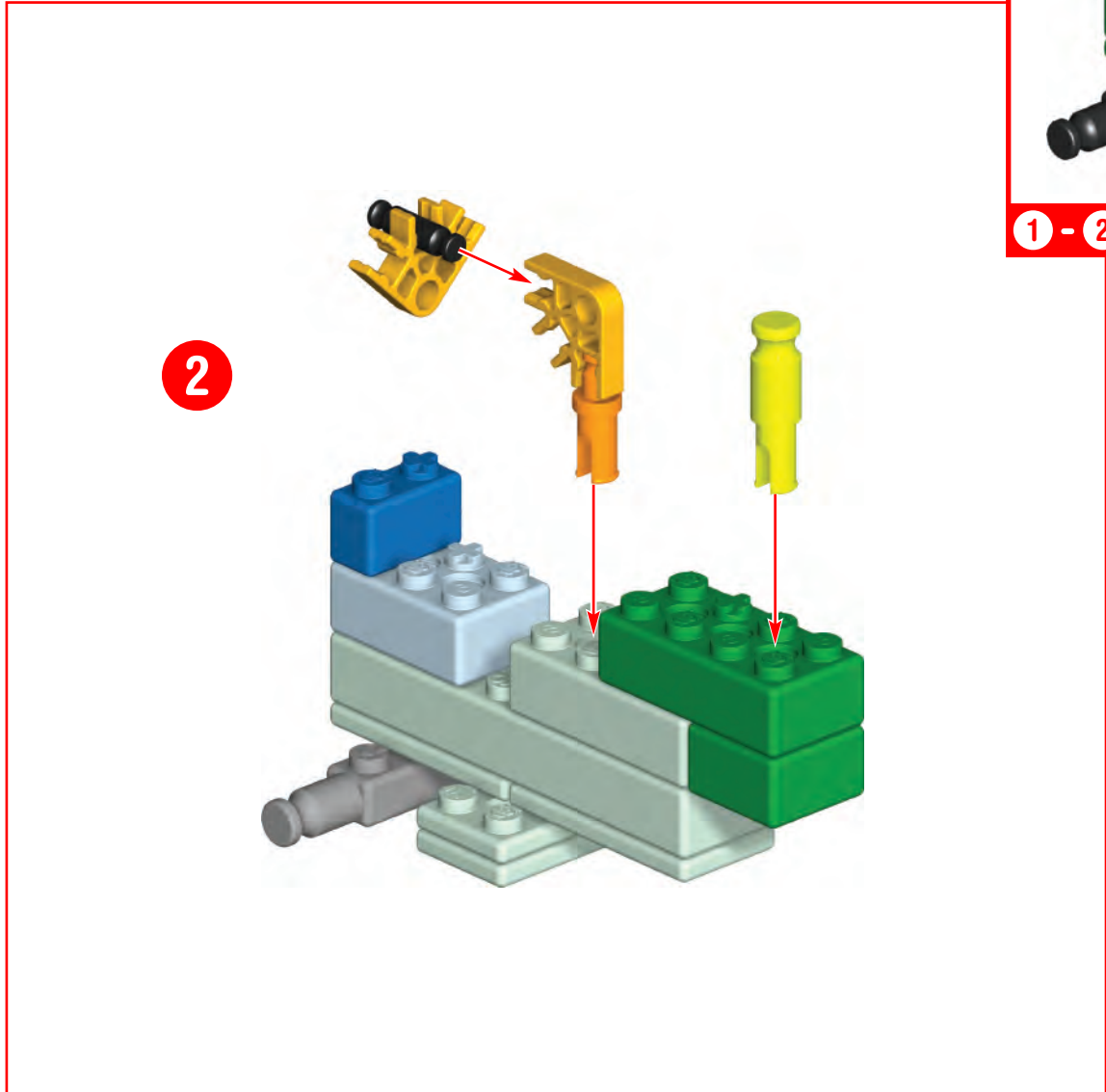

1 - 3

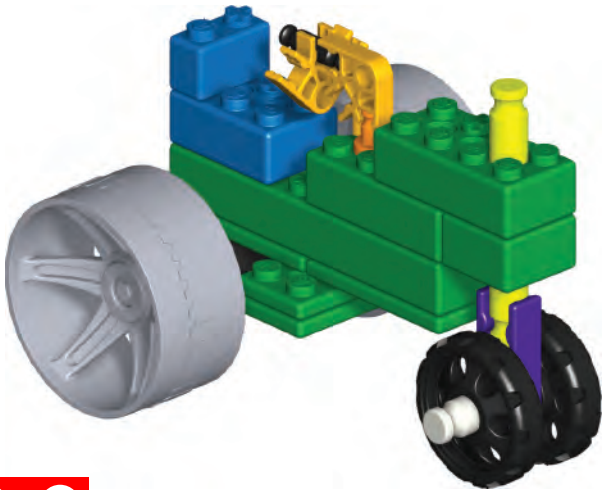

3

