

# KNEX®

Imagine • Build • Play®

5+

## BUILDING WITH BRICKS®

WORKS WITH ALL  
LEADING BUILDING BRICKS™

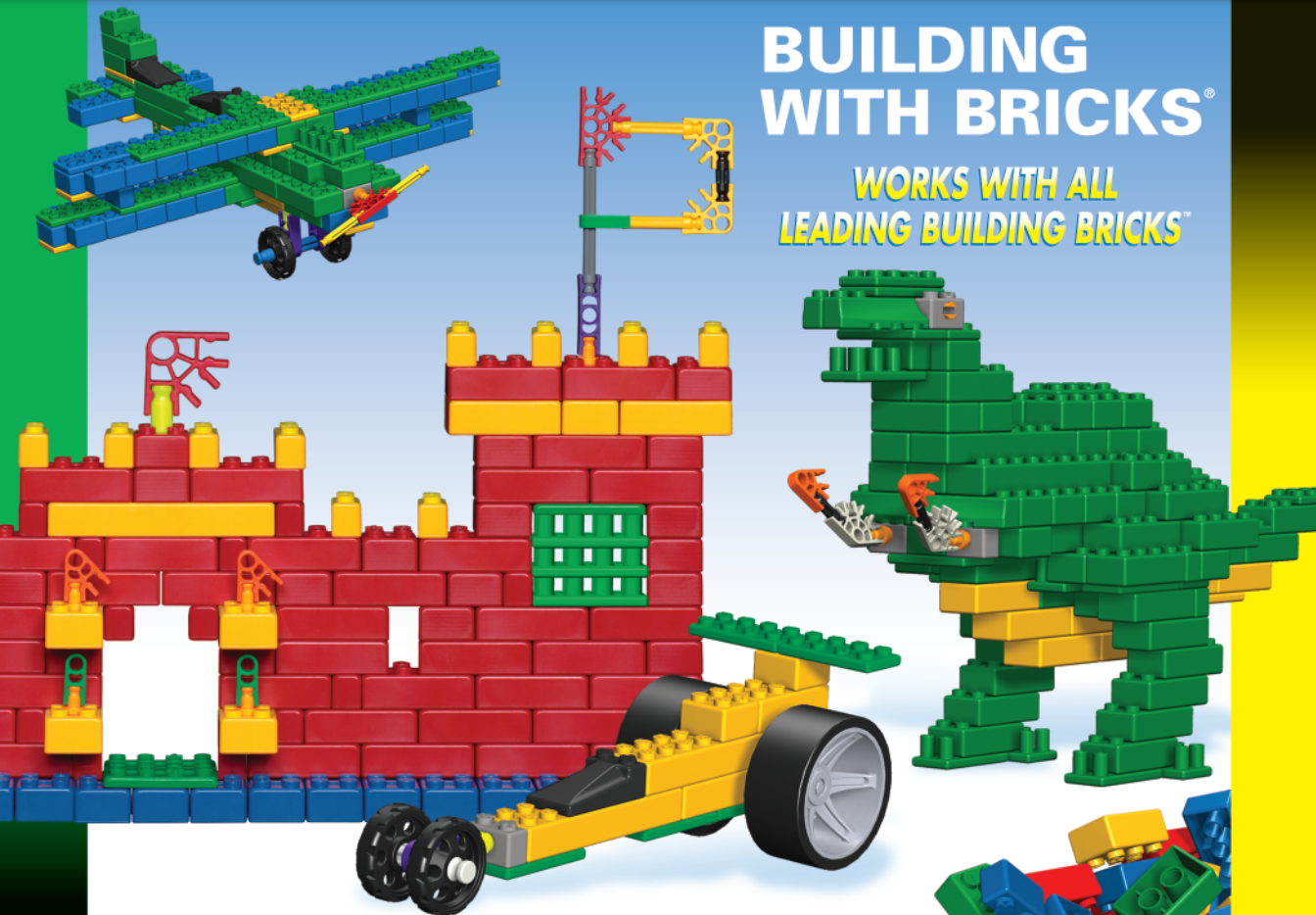

**WARNING:**

CHOKING HAZARD - Small parts.  
Not for children under 3 years.



**AVERTISSEMENT:**

DANGER D'ÉTOUFFEMENT - Pièces de petite taille.  
Ne pas donner aux enfants de moins de 3ans.

61009/61009A

# Contents

Parts Check List..... 2  
 Building Tips..... 3

## Building Instructions:

BIRD ..... 3  
 HELICOPTER ..... 4  
 DRAGSTER ..... 5  
 DINOSAUR ..... 6  
 PLANE ..... 8  
 CASTLE ..... 10  
 Building Ideas..... 12

## Translations:

Français..... 13  
 Español ..... 13  
 Deutsch ..... 13  
 Italiano..... 13  
 Português ..... 13  
 Nederlands..... 13  
 Svenska ..... 13  
 Dansk ..... 13  
 Norsk..... 13  
 Suomi ..... 13

## Parts Check List:

Before you start building, be sure to compare the parts in your set with the parts listed below. If anything is missing, check out the back cover of this instructions booklet for ways to contact us. We're here to help!



## Start Building:

Follow the steps in order. Each part has its own color and shape. Look at the picture, find the parts in your set that match and put them together. Try to hold your model in the same direction as the picture so you'll attach your piece to the right place.

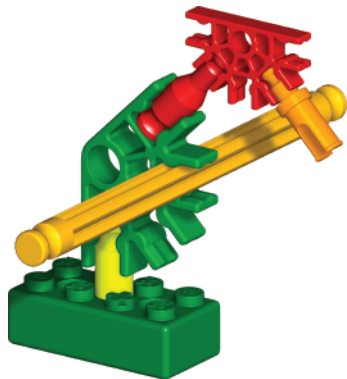
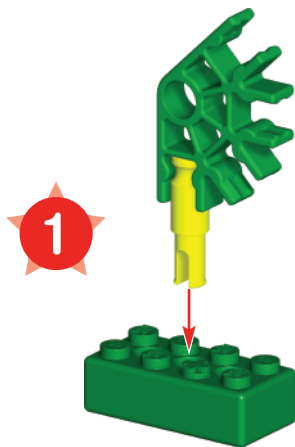

1 - 2

Bird

## Next Step:

The faded colors are the sections you have already built. You'll want to connect the next parts to the place where the arrows are pointing. There isn't an arrow for every connection spot.

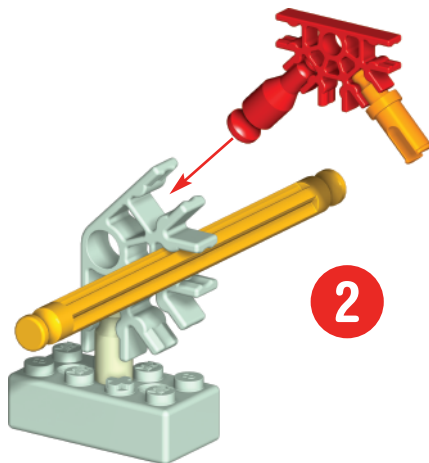

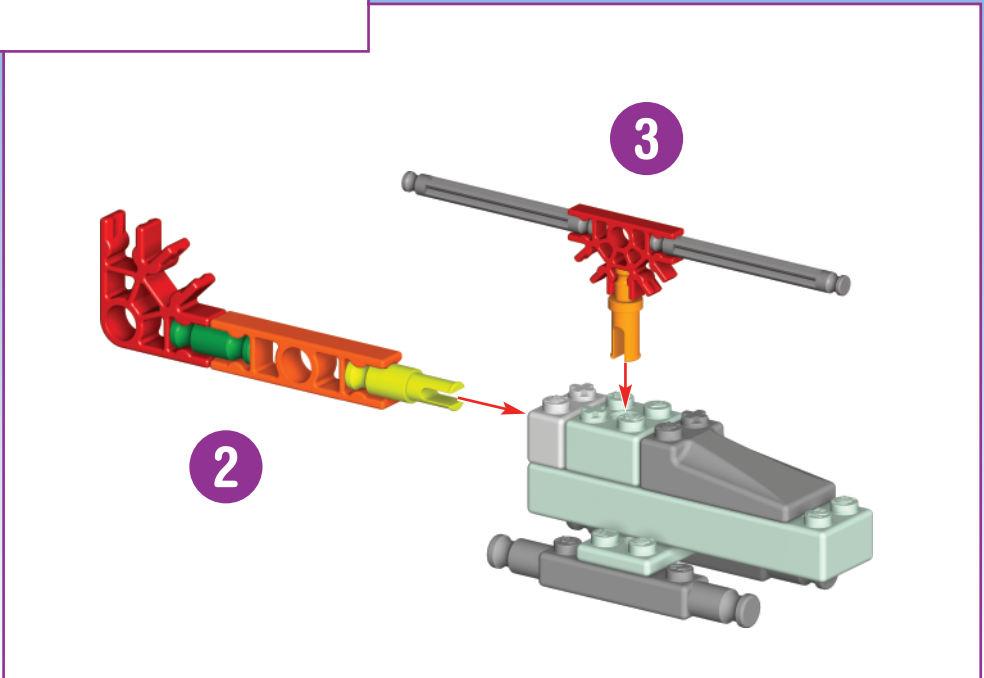
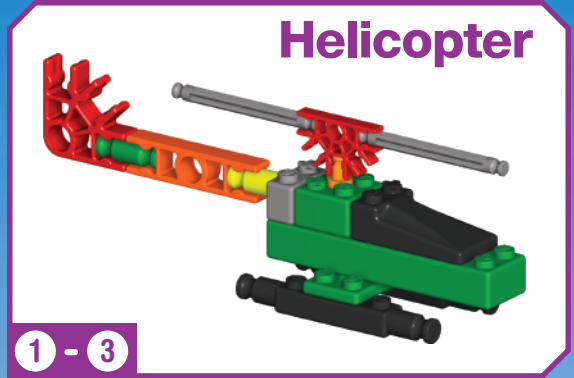
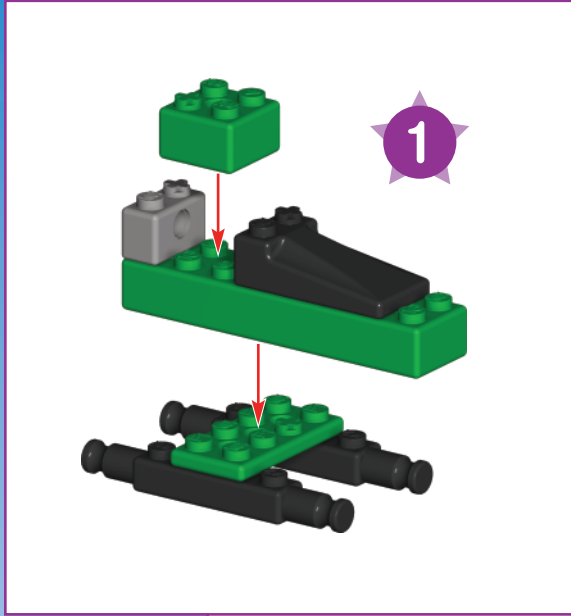

# Dragster

1

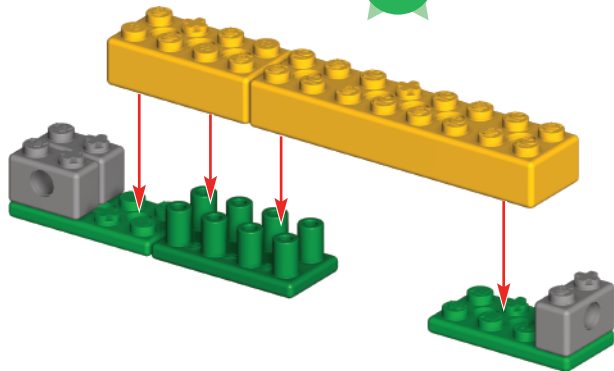

1 - 3

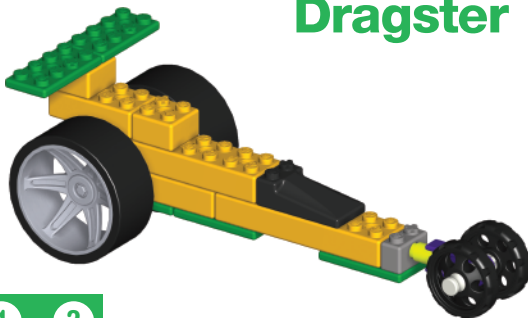

2

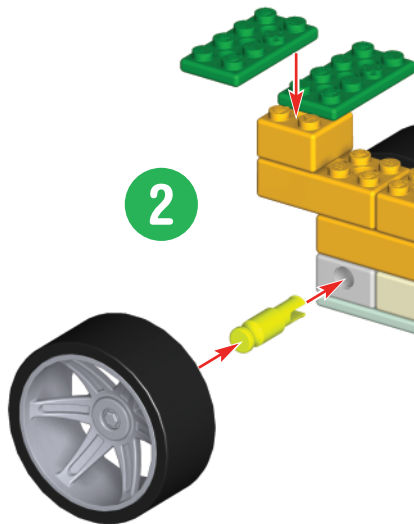

3

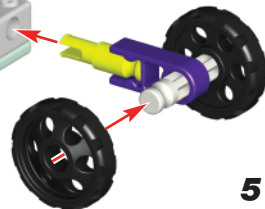

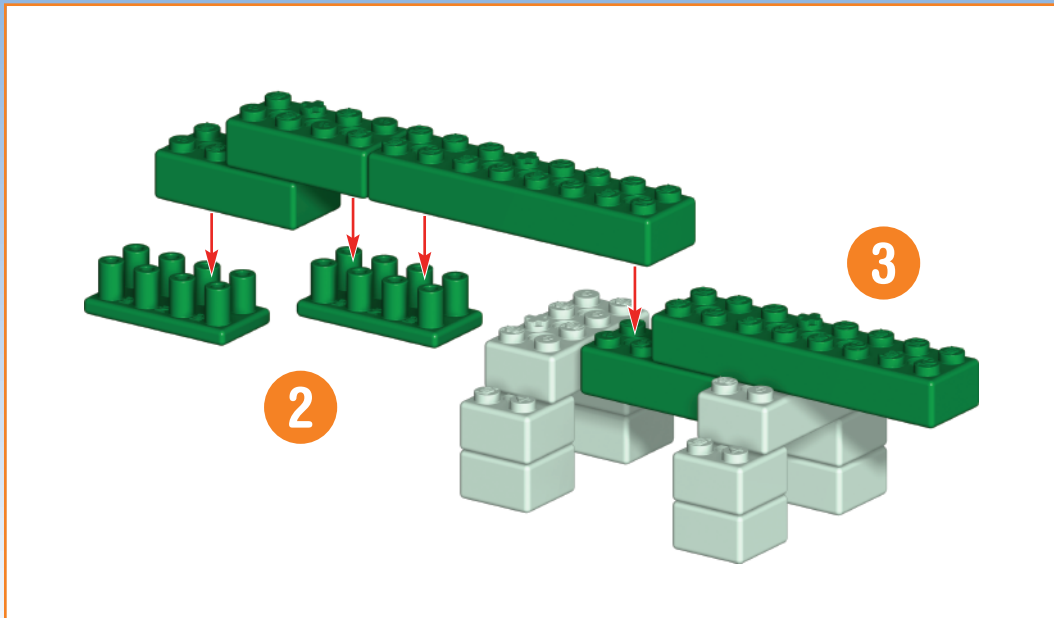
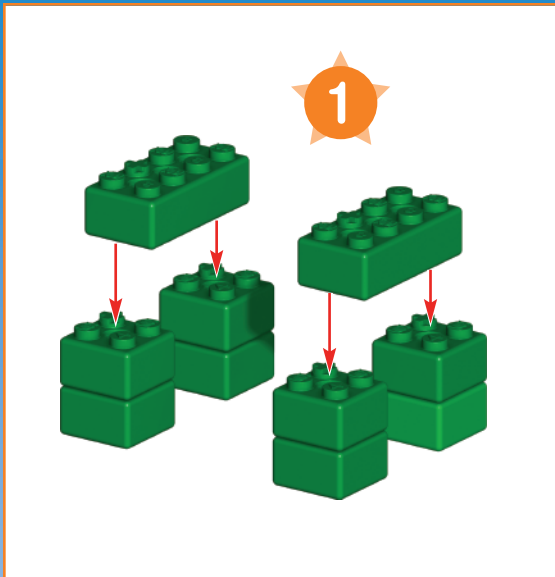

# Dinosaur

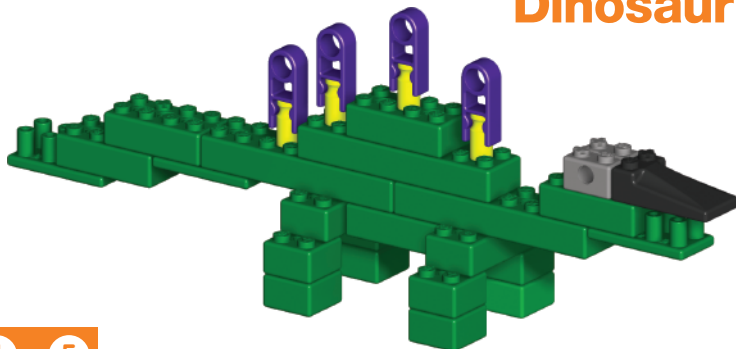

1 - 5

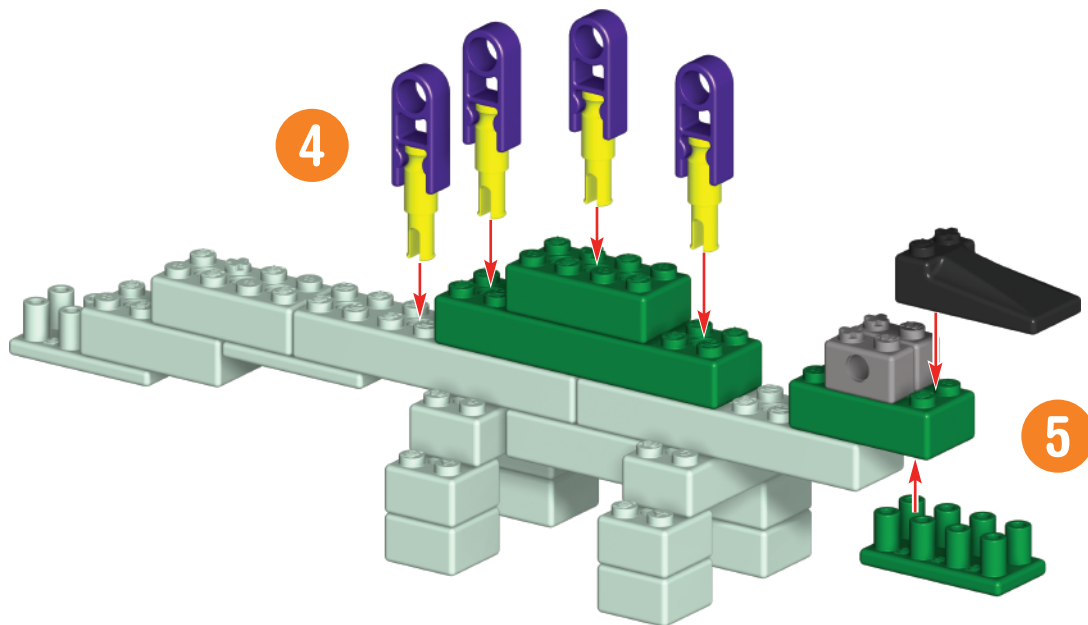

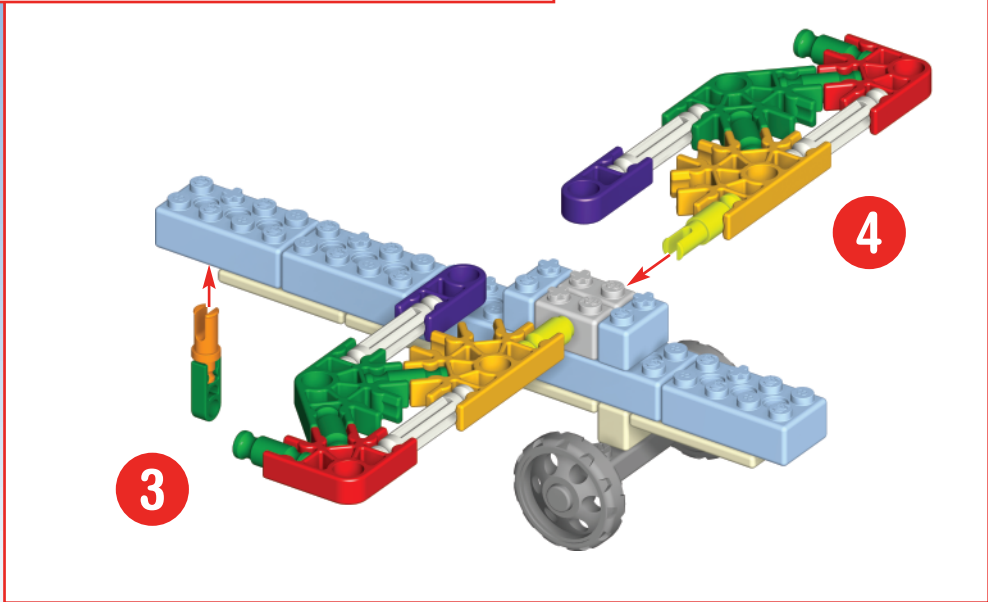
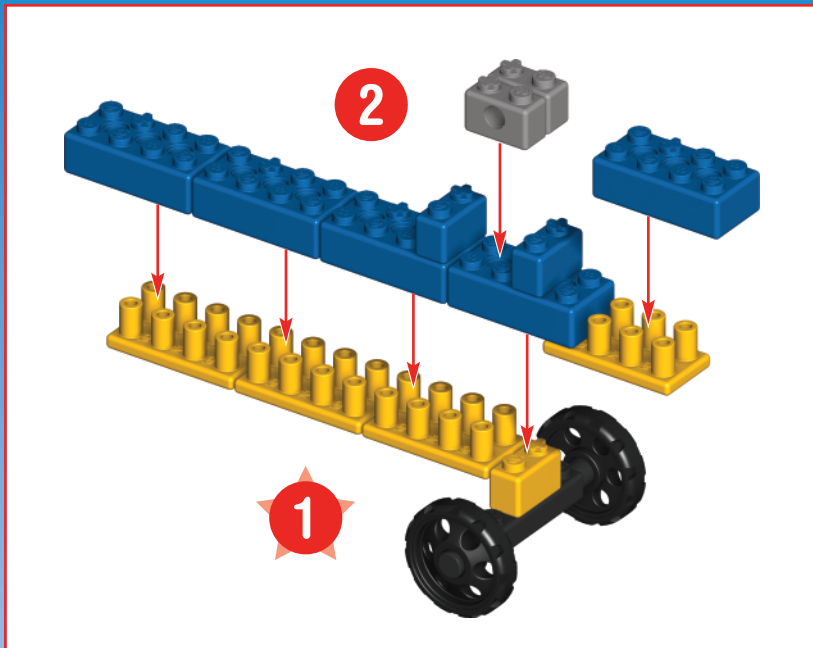

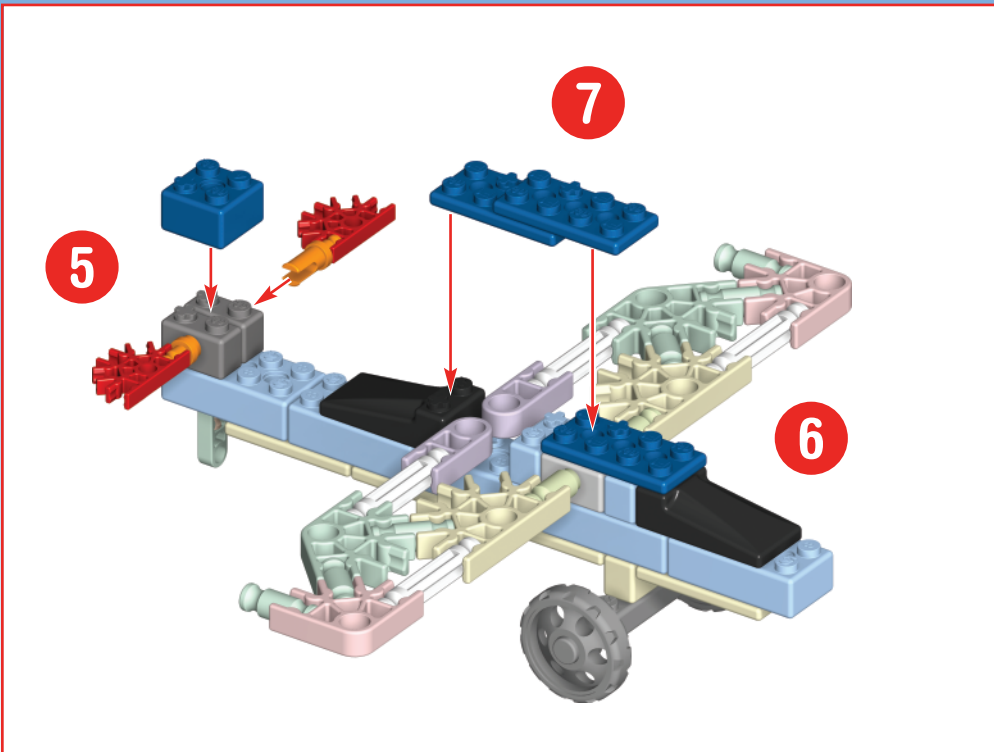
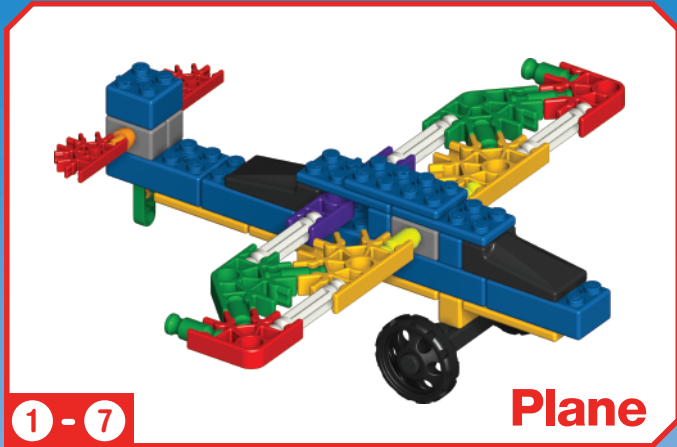

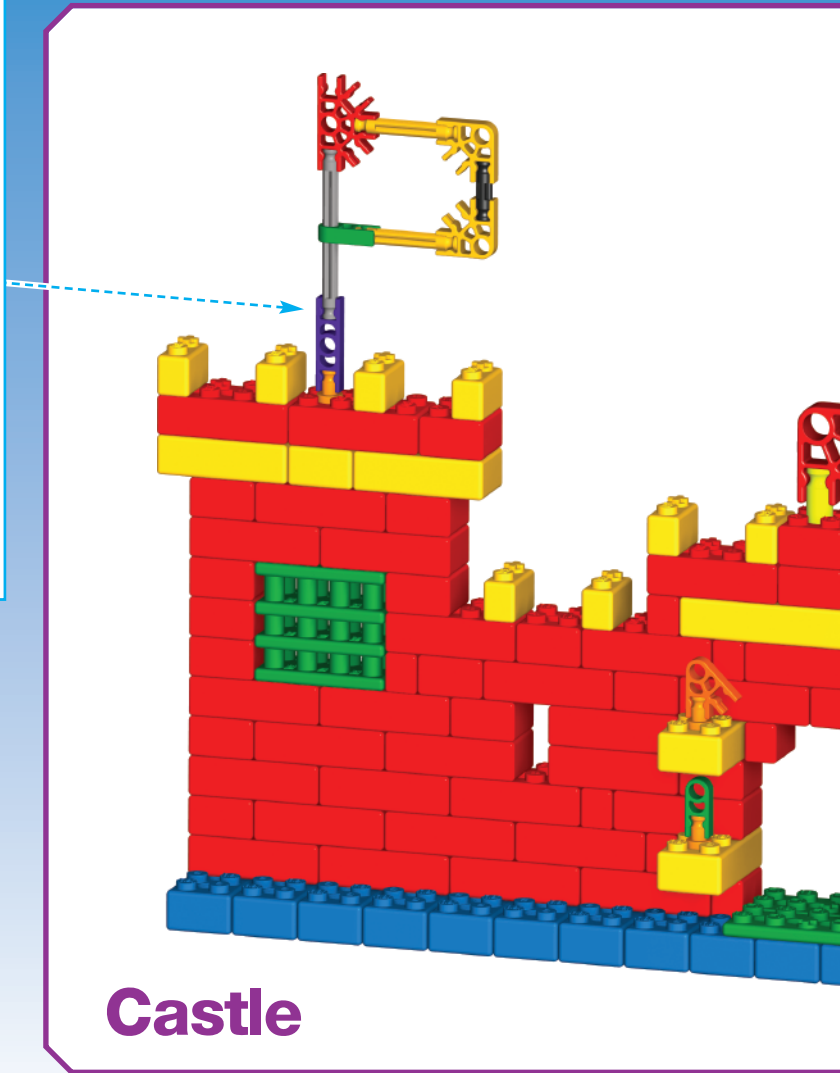
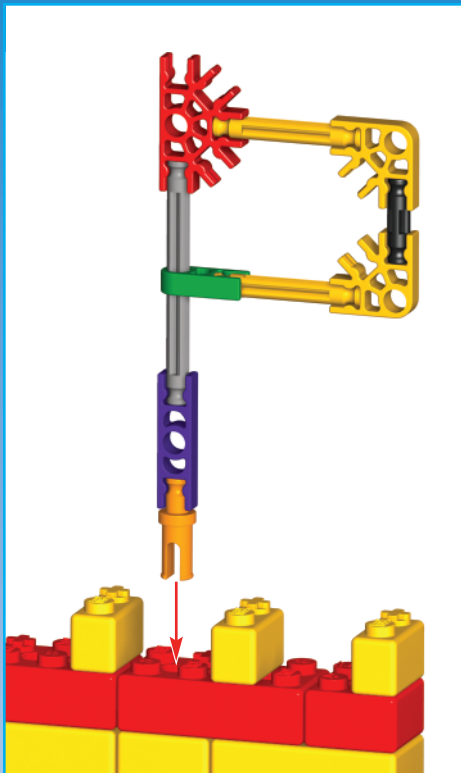

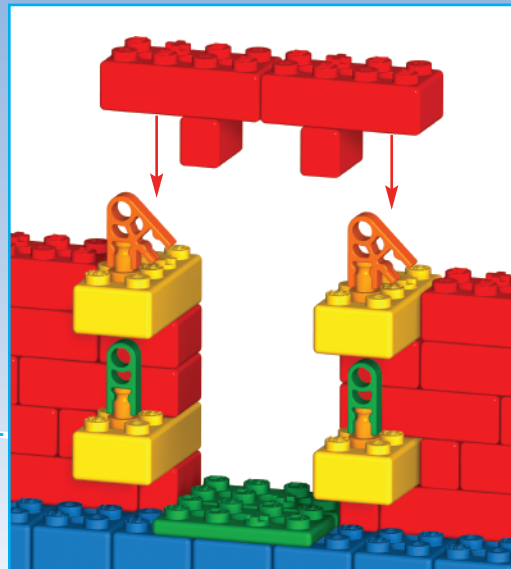
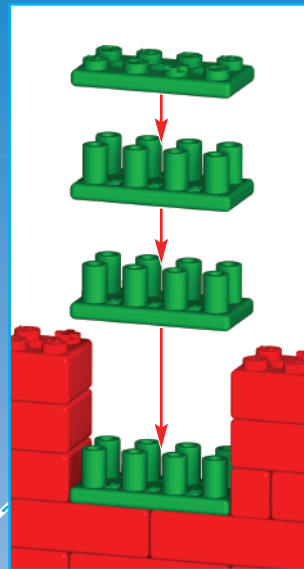
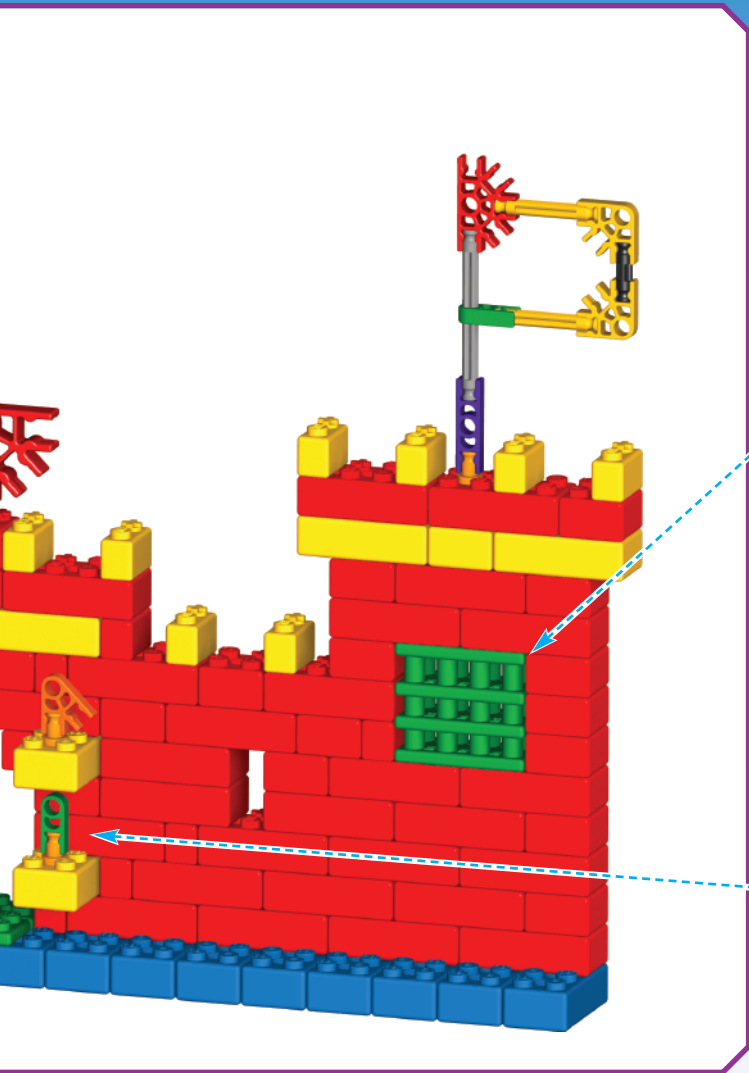

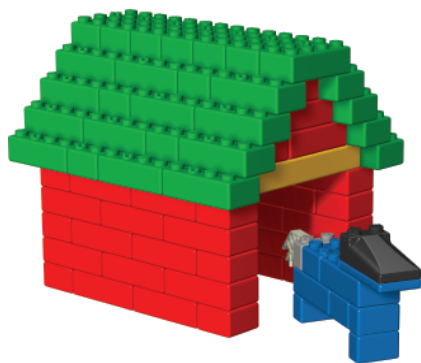
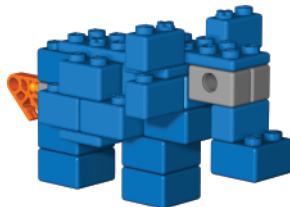
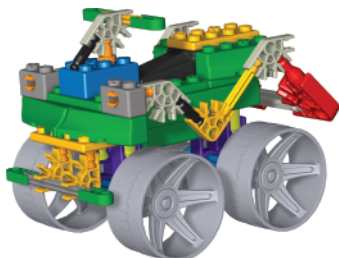
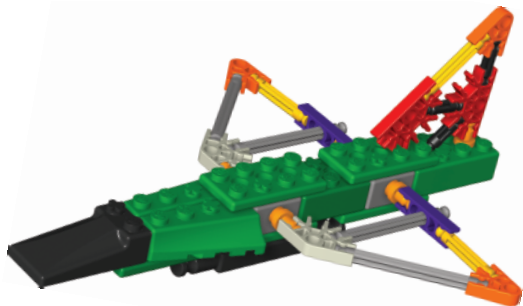

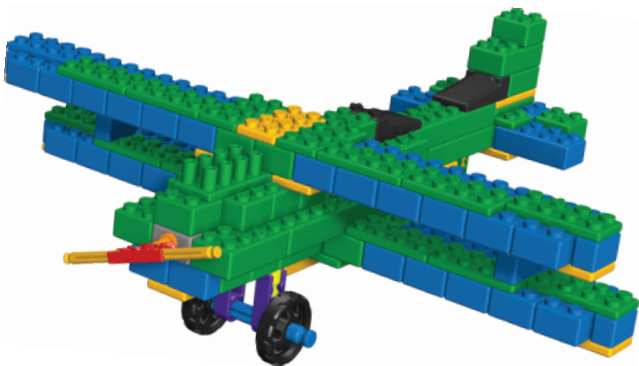

### ***Building Ideas***

Want full instructions for these models?  
No problem! Go to [www.knex.com/instructions](http://www.knex.com/instructions)  
and enter code number **61009A**

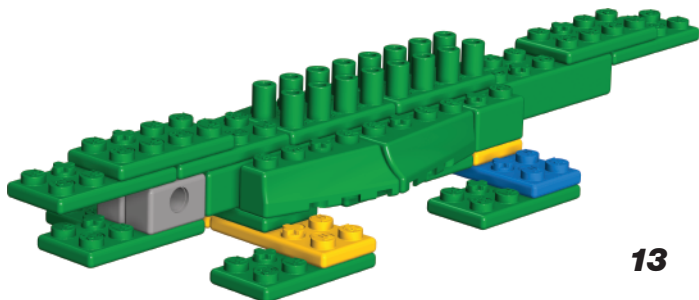
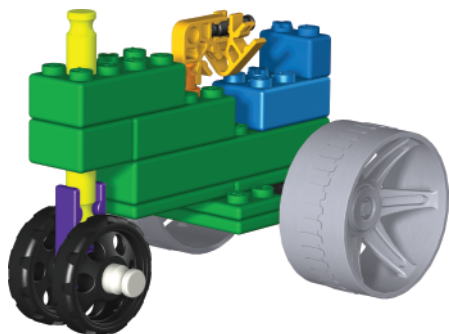
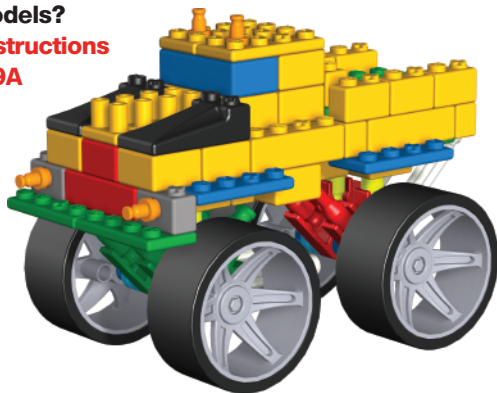

**FR** **Commence la construction** : Chaque élément a ses propres couleur et forme. Regarde l'illustration, trouve les éléments qui vont ensemble et assemble-les. Essaie de tenir ton modèle dans le même sens que sur l'illustration de façon à fixer la pièce à l'endroit qu'il faut.

**Étape suivante** : Les couleurs délavées représentent les sections que tu as déjà assemblées. Tu devras connecter les éléments suivants l'endroit où pointent les flèches. Il n'y a pas de flèche pour chaque point de connection.

**E** **Empieza a construir**: Cada pieza tiene su propio color y forma. Observa el dibujo, encuentra las piezas que combinan y ponlas juntas. Trata de mantener tu modelo en la misma dirección en que se muestra en el dibujo. Así podrás conectar la pieza en el correcto lugar.

**Paso siguiente**: Las partes descoloridas son las secciones que ya has construido. Querrás conectar las piezas que siguen en el lugar hacia el cual las flechas están apuntando. No hay una flecha para cada punto de conexión.

**D** **Los geht's mit dem Bauen**: Jedes Teil hat eine bestimmte Farbe und Form. Schau dir das Bild an und suche nach Teilen, die zueinander passen. Füge diese Teile dann zusammen. Versuche, dein Modell in der gleichen Richtung zu halten, wie in dem Bild, damit du die Teile an der richtigen Stelle zusammenfügst.

**Nächster Schritt**: Die Abschnitte mit blassen Farben hast du schon fertig gebaut. Die nächsten Teile gehören dort hin, wo die Pfeile hinzeigen. Für manche Befestigungspunkte gibt es keinen separaten Pfeil.

**I** **Comincia a costruire**: Ogni parte ha il suo colore e la sua forma. Guarda la figura, trova le parti che corrispondono e mettile insieme. Cerca di tenere il tuo modello nella stessa direzione della figura così attaccherai il pezzo al posto giusto.

**Il prossimo passo**: I colori sbiaditi sono le sezioni che hai già costruito. Quello che vorrai fare è connettere le prossime parti nel posto verso il quale sono rivolte le frecce. Non c'è una freccia per ogni punto di connessione.

**P** **Inicia a construção**: Cada peça tem a sua própria cor e configuração. Observa a ilustração, procura as peças que correspondem e coloca-as todas juntas. Tenta manter o teu modelo na mesma direcção mostrada na ilustração para encaixares a peça no local correcto.

**Passo seguinte**: As cores desbotadas pertencem às secções que já construístes. Necessitarás de unir as peças seguintes no local apontado pelas setas. Não existe uma seta para cada ponto de conexão.

**NL** **Begin te bouwen**: Elk onderdeel heeft zijn eigen kleur en vorm. Kijk naar de afbeelding, vind de overeenstemmende onderdelen en voeg ze aan mekaar. Tracht het model in dezelfde richting te houden als de afbeelding; zo zul je het stuk op de correcte plaats vastmaken.

**Volgende stap**: De vage kleuren zijn delen die reeds werden opgebouwd. De volgende onderdelen zullen moeten gekoppeld worden op de plaats aangeduid door de pijlen. Er is geen pijl voor elk koppelpunt.

**SV** **Börja bygga**: Varje del har sin egen färg och form. Titta på bilden, hitta delarna som passar och sätt ihop dem. Försök att hålla din modell i samma riktning som på bilden så att du fäster delen på rätt ställe.

**Nästa steg**: De bleka färgerna anger sektioner som du redan byggt. Du ska koppla nästa delar till ställena som anges med pilarna. Det finns inte pilar för varje kopplingspunkt.

**DA** **Begynd at bygge**: Hver del har sin egen farve og form. Se på billedet, find de dele, der matcher, og sæt dem sammen. Prøv at holde din model i samme retning som billedet, så du kommer til at sætte delen fast på den rette plads.

**Næste trin**: De faldede farver er de afsnit, du allerede har bygget. Du skal samle de næste dele på det sted, som pilene peger på. Der findes ikke nogen pil for hvert eneste samlingssted.

**NO** **Sett i gang byggingen**: Hver del har sin egen farge og fasong. Se på bildet, finn de delene som tilsvarer hverandre og sett de sammen. Forsøk å holde modellen din i samme retning som bildet slik at stykket festes til det rette stedet

**Neste skritt**: Det bleke fargene er de seksjonene som du allerede har bygget. Du skal feste de neste delene der hvor pilene peker. Det finnes ikke en pil for hvert skjøtepunktsted.

**FI** **Aloita rakentaminen**: Jokaisella osalla on oma värinsä ja muotonsa. Katso kuvaa, etsi käisiisi toisiinsa sopivat palat ja pane ne yhteen. Yritä pitää mallisi samassa suunnassa kuin kuvassa jotta varmasti kiinnität osan oikeaan kohtaan.

**Seuraava askel**: Haaleat värit osoittavat rakenteita, jotka olet jo tehnyt. Liitä seuraavat osat nuolien osoittamiin kohtiin. Nuolia ei ole jokaisessa liitäntäkohdassa.

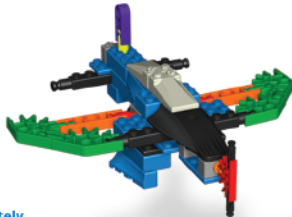

**Sold separately.**  
 Vendus séparément.  
 Se venden por separado.  
 Separat erhältlich.  
 Venduti separatamente.  
 Afzonderlijk verkocht.  
 Vendidos separadamente.  
 Säljes separat.  
 Sølges separat.  
 Selges separat.  
 Myydään erikseen.

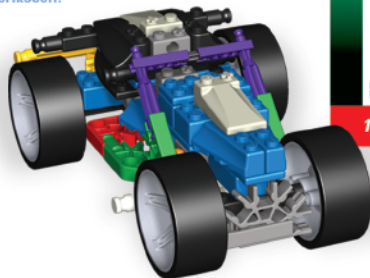
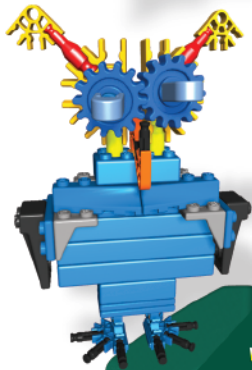

# KNEX.COM

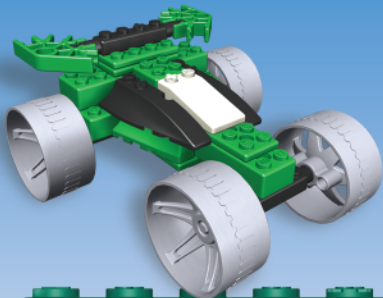

**Sold separately.**  
Vendus séparément.  
Se venden por separado.  
Separat erhältlich.  
Venduti separatamente.  
Vendidos separadamente.  
Afzonderlijk verkocht.  
Säljes separat.  
Selges separat.  
Selges separat.  
Myydään erikseen.



Questions? Call 1-800-KID-KNEX (U.S.A./Canada only) or 00800-22427276 (UK/Ireland only)  
Write to email@knex.com or visit www.knex.com

For Customer Service outside the USA, CAN, GBR please contact local distributor. Distributor information can be found at: <http://www.knex.com/distributors>  
Le Service clients hors d'USA et CAN, s'il vous plaît contacter le distributeur local. L'information de distributeur peut être trouvée à <http://www.knex.com/distributors>

©2008 K'NEX Limited Partnership Group  
P.O. Box 700  
Hatfield, PA 19440-0700

161009A-V1-06/08

Product & colours may vary. K'NEX and Imagine, Build, Play are registered trademarks of K'NEX Limited Partnership Group. Produits et couleurs peuvent varier. K'NEX et Imagine, Build, Play sont des marques déposées de K'NEX Limited Partnership Group. El producto y los colores pueden variar. K'NEX y Imagine, Build, Play son marcas registradas de K'NEX Limited Partnership Group. Manufactured under U.S. Patents/Fabriqué sous brevets américains/Fabricado bajo patentes de EE.UU. 5,061,219; 5,199,919; 5,350,331; D553,203; D553,204; D550,784; D550,785; D556,271. Other U.S. and foreign patents pending. Autres brevets américains et étrangers en instance. Otras patentes de EE.UU. y países extranjeros pendientes. Community Design No. 000 645338-001-0002. Conforms to ASTM F963-07. Conforme aux ASTM F963-07. Cumple con F963-07 de la ASTM.

